

ELECTRONIC OVEN CONTROL

Control Pad Functions

Read the instructions carefully before using the oven. For satisfactory use of your oven, become familiar with the various functions of the oven as described below. **Note:** The graphics on your timer may not look exactly like those shown. This doesn't change the way it operates. Also Push buttons or pads may be shaped differently.

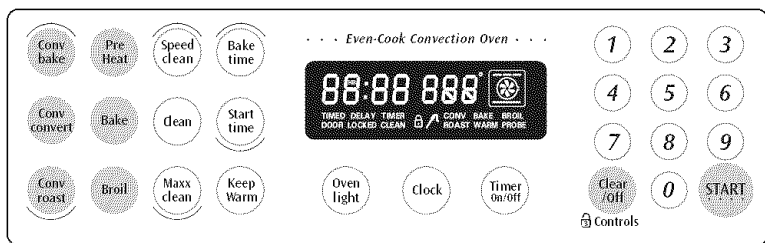
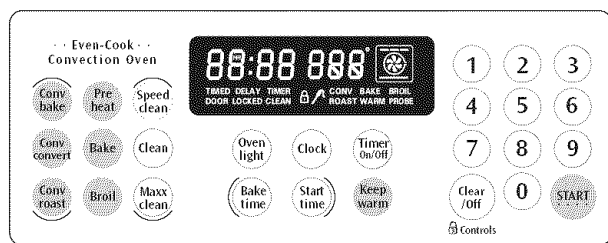

Conv Bake — Used to select the convection bake feature.
Preheat — Use to pre-condition the oven temperature.
Speed Clean — Use to select a 2 hour Self-Cleaning cycle.
Clean — Use to select a 3 hour Self-Cleaning cycle.
Oven Light — Use to turn the oven light ON and OFF.
Clock — Use to set the time of day.
Timer ON/OFF — Use to set or cancel the minute timer.
0 Thru 9 number pads — Use to enter temperature and times.



Conv Convert — Use to select the Convection Convert feature.
Bake — Use to select the normal baking feature.
Broil — Use to select variable Broil feature.
Conv Roast — Use to select the Convection Roast feature.
Maxx Clean — Use to select a 4 hour Self-Cleaning cycle.
Bake Time — Use to enter the length of the baking time.
Start Time — Use with Bake, Bake Time and Clean Pads to program a Delayed Timed Bake or Delay Self-Cleaning cycle.
Keep Warm — Use to select the Keep Warm feature.
Clear/Off or Lock Controls - Use to cancel any oven mode previously entered except the Time of Day & Minute Timer. Push **Clear/Off** to stop cooking. Also used to control the Oven Lockout feature.

Minimum & Maximum Control Pad Settings

All the features listed have minimum and maximum time or temperature settings that may be entered into the control. An ENTRY acceptance beep will sound each time a control pad is touched (the Oven Lockout pad is delayed by 3 seconds).

An ENTRY ERROR tone (3 short beeps) will sound if the entry of the temperature or time is below the minimum or above the maximum settings for the feature.

FEATURE	MIN. TEMP./TIME	MAX. TEMP./TIME
PREHEAT TEMP.	170°F/ 77°C	550°F/ 288°C
BAKE TEMP.	170°F/ 77°C	550°F/ 288°C
BROIL TEMP.	400°F/ 205°C	550°F/ 288°C
MINUTE TIMER 12 Hr.	0:01 Min.	11:59 Hr./ Min.
24 Hr.	0:01 Min.	11:59 Hr./ Min.
CLOCK TIME 12 Hr.	1:00 Hr./ Min.	12:59 Hr./ Min.
24 Hr.	0:00 Hr./ Min.	23:59 Hr./ Min.
COOK TIME 12 Hr.	0:01 Min.	11:59 Hr./ Min.
24 Hr.	0:01 Min.	11:59 Hr./ Min.
START TIME 12 Hr.	1:00 Hr./ Min.	12:59 Hr./ Min.
24 Hr.	0:00 Hr./ Min.	23:59 Hr./ Min.
CONVECTION BAKE	170°F/ 77°C	550°F/ 288°C
CONVECTION ROAST	170°F/ 77°C	550°F/ 288°C

Versión en español
 Si desea obtener una copia en español de este Manual del Usuario, sírvase escribir a la dirección que se incluye a continuación. Solicite la P/ N 318204125E.
 Spanish Owner's Guides
 Frigidaire Company
 P. O. Box 9061
 Dublin, Ohio 43017-0961

Setting the Clock

The **(Clock)** pad is used to set the clock. The clock may be set for 12 or 24 hour time of day operation. The clock has been preset at the factory for the 12 hour operation. When the range is first plugged in, or when the power supply to the range has been interrupted, the time in the display will flash (See Figure 1).



Figure 1

INSTRUCTIONS

To set the clock (example below for 1:30)

1. Press **(Clock)**. "CLO" will appear in the display (Figure 2).
2. Press **(1)** **(3)** **(0)** pads to set the time of day to 1:30 (Figure 3).
"CLO" will stay in the display. Press **(START)**. "CLO" will disappear and the clock will start (Figure 4).

PRESS

DISPLAY

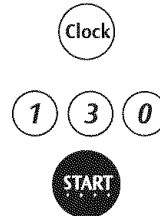

Figure 2



Figure 3

Changing between 12 or 24 hour time of day display

1. Press and hold **(Clock)** for 7 seconds (Figure 3). After 7 seconds, "12h" (Figure 5) or "24h" (Figure 6) will appear in the display and the control will beep once.
2. Press **(Clean)** to switch between the 12 and 24 hour time of day display. The display will show either "12h" (Figure 5) or "24h" (Figure 6).
3. Press **(START)** to accept the change or press **(Clear /off)** to reject the change.
4. Reset the correct time as described in **To set the Clock** above. Please note that if the 24 hour time of day mode was chosen, the clock will now display time from 0:00 through 23:59 hours.

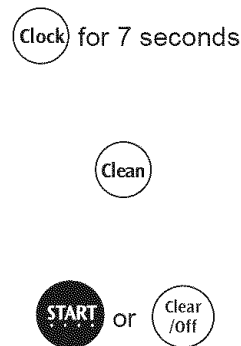

Figure 4

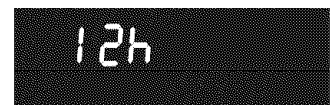

Figure 5



Figure 6

Setting the Clock (continued)

Setting Continuous Bake or 12 Hour Energy Saving

The **TIMER ON/OFF** (Timer On/Off) and **CLEAN** (Clean) pads control the Continuous Bake or 12 Hour Energy Saving features. The oven control has a factory preset built-in 12 Hour Energy Saving feature that will shut off the oven if the oven control is left on for more than 11 hours and 59 minutes. The oven can be programmed to override this feature for Continuous Baking.

INSTRUCTIONS

To set the control for Continuous Bake or 12 Hour Energy Saving features

1. Press and hold (Timer On/Off) for 7 seconds (Figure 1). After 7 seconds "12h" or "- h" will appear in the display and the control will beep once.
2. Press (Clean) to switch between the 12 Hour Energy Saving and continuous bake features. Note: "12h" (Figure 2) in the display indicates the control is set for the 12 Hour Energy Saving mode and "- h" indicates the control is set for the Continuous Bake feature (Figure 3).
3. Press (START) to accept the change (Figure 4; display will return to time of day) or press (Clear /off) to reject the change.

PRESS

(Timer On/Off) for 7 seconds

(Clean)

(START)

(Clear /off)

DISPLAY



Figure 1



Figure 2



Figure 3



Figure 4

Setting Timer

The **TIMER ON/OFF** (Timer On/Off) pad controls the Timer feature. The Timer serves as an extra timer in the kitchen that will beep when the set time has run out. It does not start or stop cooking. The Timer feature can be used during any of the other oven control functions. Refer to "Minimum and Maximum Control Pad Settings" for time amount settings.

INSTRUCTIONS

To set the Timer (example for 5 minutes)

1. Press (Timer On/Off). "- - - -" will appear and "TIMER" will flash in the display (Figure 5).
2. Press the number pads to set the desired time in the display (example (5)). Press (START). The time will begin to count down with "5:00" and "TIMER" will stay in the display (Figure 6).
- 6). Note: If (START) is not pressed the timer will return to the time of day after 25 seconds.
3. When the set time has run out, "End" and "TIMER" will show in the display (Figure 7). The clock will sound with 3 beeps every 5 seconds until (Timer On/Off) is pressed.

PRESS

(Timer On/Off)

(5)

(START)

(Timer On/Off)

(Timer On/Off)

DISPLAY



Figure 5



Figure 6



Figure 7

To cancel the Kitchen Timer before the set time has run out

Press (Timer On/Off). The display will return to the time of day.

Consumer Defined Controls

Note: The Consumer Defined Control features are adjustments to the control that will not affect cooking results. These include the Oven Lockout, Silent Control Operation and Temperature Display features.

Setting Oven Lockout Feature

The  pad controls the Oven Lockout feature. The Oven Lockout feature automatically locks the oven door and prevents the oven from being turned on. It does not disable the clock, Kitchen Timer or the interior oven lights.

INSTRUCTIONS

To activate the Oven Lockout feature

1. Press and hold  for 3 seconds.
2. After 3 seconds a beep will sound, "LOC" will appear and "DOOR LOCKED" will flash in the display (If you have a range see figure 1-A; if it's a wall oven see figure 1-B). Once the oven door is locked the "DOOR LOCKED" indicator will stop flashing.

 for 3 seconds

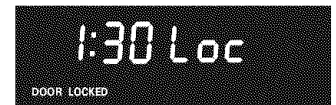



Figure 1-A



Figure 1-B

To reactivate normal oven operation:

1. Press and hold  for 3 seconds. A beep will sound. "LOC" will disappear. The "DOOR LOCKED" will flash in the display until the oven door has completely unlocked (Figure 2).
2. The oven is again fully operational.



 for 3 seconds





Figure 2

Setting Silent Control Operation

The **START TIME**  and **CLEAN**  pads control the Silent Control operation feature. The Silent Control operation feature allows the oven control to be operated without sounds or beeps whenever necessary. If desired the control can be programmed for silent operation and later returned to operating with all the normal sounds and beeps.

INSTRUCTIONS

To change control from normal sound operation to silent control operation

1. To tell if your range is set for normal or silent operation press and hold  for 7 seconds. "- - - -" will appear and "DELAY" will flash in the display (Figure 3). After 7 seconds "SP" will appear in the display (Figure 4).
2. Press  to switch between normal sound operation and silent operation mode. The display will show either "SP" (Figure 4) or "--" (Figure 5).

 for 7 seconds



Figure 3



Figure 4

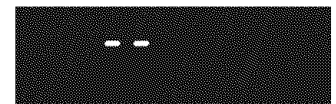



Figure 5

If "SP" appears (Figure 4), the control will operate with normal sounds and beeps. If "- -" appears (Figure 5), the control is in the silent operation mode.



3. Press  to accept the change or press  to reject the change.

 or 

Note: The control will always beep at the end of a kitchen timer and will beep when a set temperature has been reached, even if the control is set to silent operation.





Consumer Defined Controls (continued)

Setting Temperature Display — Fahrenheit or Celsius:

The **BROIL**  and **CLEAN**  pads control the Fahrenheit or Celsius temperature display modes. The oven control can be programmed to display temperatures in Fahrenheit or Celsius. The oven has been preset at the factory to display in Fahrenheit.

INSTRUCTIONS



To change display from Fahrenheit to Celsius or Celsius to Fahrenheit

1. To tell if the display is set for Fahrenheit or Celsius press  (Figure 1) and hold for 7 seconds; "550°" will appear and "BROIL" will flash in the display and a beep will sound. If "F" appears, the display is set to show temperatures in Fahrenheit (Figure 2). If "C" appears, the display is set to show temperatures in Celsius (Figure 3).
2. Press  to switch between Fahrenheit or Celsius display modes. The display will show either "F" (Figure 2) or "C" (Figure 3).
3. Press  to accept the change or press  to reject the change.

PRESS

for 7 seconds



 or 

DISPLAY



Figure 1



Figure 2



Figure 3

Setting Oven Controls





Setting Preheat

The **PREHEAT**  pad controls the Preheat feature. The Preheat feature will bring the oven up to temperature and then indicate when to place the food in the oven. Use this feature when recipes call for preheating. Preheating is not necessary when roasting or cooking casseroles. The oven can be programmed to preheat at any temperature between 170°F to 550°F.

INSTRUCTIONS

To set the Preheat temperature for 375°F

1. Arrange the interior oven racks.
2. Press . "350°" and "BAKE" will appear in the display







(Figure 1). Note that if a preheat of 350°F is needed, press .
3. Press   . "375°" and "BAKE" will appear in the display (Figure 2).
4. Press . "PRE" and "BAKE" will appear in the display as the oven heats and reaches 375°F (Figure 3).

Note: After the oven has reached the desired temperature (this example, 375°F) the control will beep and the "PRE" light will turn off and oven temperature will be displayed (Figure 4). If you missed hearing the beep, you can tell that the oven has reached preheat temperature if you see the oven temperature showing in the oven display. Once the oven has preheated, **PLACE FOOD IN THE OVEN**. The "BAKE" light will stay on.

Press  when baking is complete or to cancel the preheat feature.

To change Preheat temperature while oven is preheating (example: changing from 375°F to 425°F)

If it is necessary to change the preheat temperature while the oven is preheating to the original temperature:

1. While preheating, press . "375°" and "BAKE" will appear in the display (Figure 5)
2. Enter the new preheat temperature. Press   . "425°" and "BAKE" will appear in the display (Figure 6).
3. Press . "PRE" and "BAKE" will appear in the display as the oven heats to 425°F (Figure 7). A beep will sound once the oven temperature reaches 425°F and the display will show "425°" and "BAKE" (Figure 8).
4. When baking is complete press .

Note: Electric models only, while in preheat mode, the convection fan and convection element will be activated during the first rise of temperature to allow the oven to reach its target temperature faster. The bake and broil elements will also cycle for better heat distribution.

PRESS

DISPLAY



Figure 1



Figure 2



Figure 3



Figure 4



Figure 5



Figure 6



Figure 7



Figure 8







Setting Oven Controls (continued)

Setting Bake





The **BAKE**  pad controls normal baking. The oven can be programmed to bake at any temperature from 170° F to 550° F (The sample shown below is for 375°F).

INSTRUCTIONS

To set the Bake Temperature to 375°F

1. Arrange interior oven racks and place food in oven.
 2. Press , "350°" will appear and "BAKE" will flash in the display (Figure 1). If a bake of 350°F is needed, press .
 3. Press    (Figure 2). "BAKE" will continue to flash and "375°" will appear in the display.
 4. Press . The display will show "375°" and "BAKE" (Figure 3). A beep will sound once the oven temperature reaches 375° F.
- Pressing  will cancel the Bake feature at any time.

To change the Bake Temperature (example: changing from 375°F to 425°F)

1. After the oven has already been set to bake at 375°F and the oven temperature needs to be changed to 425°F, press  (Figure 4). "375°" will appear and "BAKE" will flash in the display.
2. Press    (Figure 5). "BAKE" will continue to flash and "425°" will appear in the display.
3. Press . "BAKE" and "425°" will stay in the display (Figure 6).

Note: If the oven was recently heated from prior cooking and has remained heated, the bake element symbol may not show in the display immediately.

Note: Electric models only, during the first rise of temperature, the convection fan and convection element will be activated to allow the oven to reach its target temperature faster. The Bake and Broil elements will also cycle for a better heat distribution.

PRESS

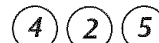

DISPLAY



Figure 1



Figure 2



Figure 3



Figure 4



Figure 5



Figure 6

Setting Oven Controls (continued)

Setting Convection Bake

The **CONV BAKE**  pad controls the Convection Bake feature. The oven can be programmed for Convection baking at any temperature between 170° F (77°C) to 550° F (288° C).

Convection baking uses a fan to circulate the oven's heat evenly and continuously within the oven (Figure 1). This improved heat distribution allows for even cooking and excellent results using multiple racks at the same time. Foods cooked on a single oven rack will generally cook faster and more evenly with Convection Bake. Multiple oven rack cooking may slightly increase cook times for some foods, but the overall result is time saved. Breads and pastries brown more evenly.

General Convection Bake Instructions

1. When using Convection Bake, adjust the cook time for desired doneness as needed. Time reductions will vary depending on the amount and type of food to be cooked. Cookies and biscuits should be baked on pans with no sides or very low sides to allow heated air to circulate around the food. Food baked on pans with a dark finish will cook faster.
2. Preheating is not necessary when cooking casseroles with Convection Bake.
3. When using Convection Bake with a single rack, place oven rack in position 2 or 3. If cooking on multiple racks, place the oven racks in positions 2 and 4.

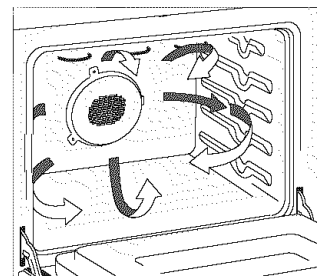

Air circulation during Convection Bake

Figure 1

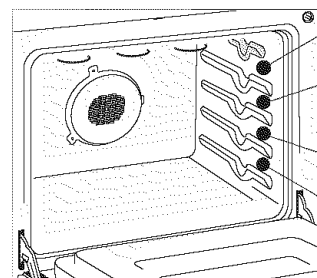

4th Rack position
3rd Rack position
2nd Rack position
1st Rack position







Figure 2

Benefits of Convection Bake:

- Multiple rack baking.
- Some foods cook up to 30% faster, saving time and energy.
- No special pans or bakeware needed.

INSTRUCTIONS

To set the oven for Convection Bake and temperature to 375°F

1. Arrange interior oven racks and place food in oven.
2. Press . "CONV BAKE" will flash and "350°" will appear in the display (Figure 3). If a Convection bake of 350°F is needed, press .
3. Press   . "CONV BAKE" will keep flashing and "350°" will appear in the display (Figure 4).
4. Press . "CONV BAKE" will stop flashing and the fan icon will appear in the display (Figure 5).

Note: The display will show an icon of rotating fan within a square. This rotating fan icon indicates when the Convection Fan is operating. **Electric Models:** The convection fan and convection element will start AS SOON AS the oven is set for Convection Bake. **Gas Models:** Please allow up to 6 minutes for the convection fan and convection element to activate.

Press  to stop Convection Bake or cancel Convection Bake at any time.

PRESS

DISPLAY



Figure 3



Figure 4



Figure 5







Setting Oven Controls (continued)

Setting Convection Roast

The **CONV ROAST**  pad is designed to give optimum cooking performance for this feature. The Convection Roast pad combines a cook cycle with the convection fan and element to roast meats and poultry. Preheating is not necessary for meats and poultry. Heated air circulates around the food from all sides, sealing in juices and flavors. Foods are crispy brown on the outside while staying moist on the inside.

INSTRUCTIONS

To set the Convection Roast feature (example: Meats to cook at 375°F)

1. Arrange interior oven racks and place food in oven.
2. Press . "CONV ROAST" will flash and "350°" will be displayed (Figure 1).
3. Press   . "CONV ROAST" will flash and "375°" will appear in the display (Figure 2).
4. Press . "CONV ROAST" and "375°" will appear in the display (Figure 3). The convection fan icon will come on.

Press  to stop Convection Roast at any time.

Note: The display will show an icon of rotating fan within a square. This rotating fan icon indicates when the Convection Fan is operating. **Electric Models:** The convection fan and convection element will start AS SOON AS the oven is set for Convection Bake. **Gas Models:** Please allow up to 6 minutes for the convection fan and convection element to activate.

Roasting Rack Instructions (some models)

When preparing meats for convection roasting, use the broiler pan and insert along with the roasting rack (if equipped). The broiler pan will catch grease spills and the insert will help prevent grease splatters. The roasting rack will allow the heat to circulate around the meat.

⚠ WARNING To prevent food from contacting the broil element and to prevent grease splattering, **DO NOT** use the roasting rack when broiling.

1. Place oven rack on bottom or next to the bottom rack position. See Arranging Oven Racks in the **Before Setting Oven Controls** section.
2. Place the insert in the broiler pan. The roasting rack fits on the insert allowing the heated air to circulate under the food for even cooking and helps to increase browning on the underside. Make sure the roasting rack is securely seated on the insert in the broiler pan. **DO NOT** use the broiler pan without the insert. **DO NOT** cover the insert with aluminum foil.
3. Position food (fat side up) on the roasting rack (See Figure 4).
4. Place the broiler pan on the oven rack.

PRESS

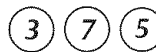

DISPLAY



Figure 1



Figure 2



Figure 3

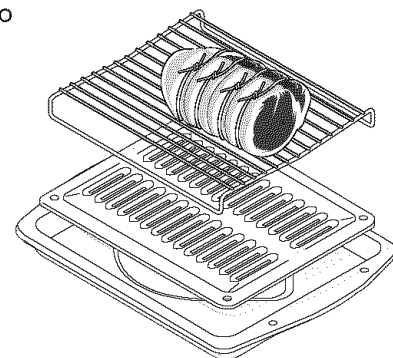



Figure 4

Setting Oven Controls (continued)

Setting Convection Convert feature

The  **CONV CONVERT** pad is used to automatically convert a standard **baking** recipe for convection baking. When set properly, this feature is designed to display the actual converted (reduced) temperature in display.

Convection Convert may **ONLY** be used with a **Bake**, **Timed Bake** or a **Delay Start** (Delayed Timed Bake) setting. When used with a Timed Bake or a Delayed Timed Bake setting, the Convection Convert feature will display a "CF" for check food when the bake time is 75% complete (See Figure 3). At this time the oven control will sound 3 long beeps at regular intervals until baking has finished. When the bake time has completely finished the control will display "End" and will sound 3 long beeps every 30 seconds until the  pad is pressed.

INSTRUCTIONS

To change from a normal bake recipe to a convection bake recipe (example: changing a 400°F (204°C) normal bake recipe to a convection bake recipe:

When the **CONV BAKE** mode is on at 400°F (204°C) (Figure 1), press

 "CONV BAKE" and the oven temperature **adjustment** will appear in the display (for this example it is 375°F). A beep will sound once the **adjusted** oven temperature is reached. The display will show "375°", "CONV BAKE" and the fan icon (Figure 2).

Note: When using a Cook Time, the convection convert will not operate if you have a timed bake under is 20 minutes.

PRESS

DISPLAY



Figure 1







Figure 2



Figure 3







Setting Oven Controls (continued)

Setting Timed Bake, Timed Convection Bake or Timed Convection Roast

The **BAKE**  or **CONVECTION BAKE**  or **CONVECTION ROAST**  and **BAKE TIME**  pads control the Timed Bake feature. The automatic timer of the Timed Bake feature will turn the oven OFF after cooking for the desired amount of time you selected.

INSTRUCTIONS

To program the oven to begin baking immediately and to shut off automatically (example: **BAKE** at 350°F for 30 minutes)

1. Be sure the clock is set for the correct time of day.
2. Arrange interior oven rack(s) and place the food in the oven.
3. Press , "350°" will appear and "BAKE" will flash in the display (Figure 1).
4. Press , "BAKE" and "350°" will appear in the display (Figure 2).
5. Press , "TIMED" will flash; "BAKE", "- - - -" and "350°" will appear in the display (Figure 3).
6. Enter the desired baking time by pressing   (Figure 4).
Note: Baking time can be set for any amount of time between 1 minute to 11 hours and 59 minutes.
7. Press . Both the "TIMED" and "BAKE" icons will remain on in the display (Figure 5). Once the Timed Bake feature has started, the current time of day will appear in the display.

Note: After the Timed Bake feature has activated, press  to display the bake time remaining in the Timed Bake mode. Once Timed Bake has started baking, a beep will sound when the oven temperature reaches the set temperature.

Press  when baking has finished or at any time to cancel the Timed Bake feature.

When the timed bake finishes:

1. "End" and the time of day will show in display. The oven will shut off automatically (Figure 6).
2. The control will beep 3 times. The control will continue to beep 3 times every 30 seconds until  is pressed.

PRESS

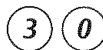

DISPLAY



Figure 1



Figure 2



Figure 3



Figure 4



Figure 5



Figure 6

CAUTION Use caution with the **DELAYED TIME BAKE** features. Use the automatic timer when cooking cured or frozen meats and most fruits and vegetables. Foods that can easily spoil such as milk, eggs, fish, meat or poultry, should be chilled in the refrigerator first. Even when chilled, they should not stand in the oven for more than 1 hour before cooking begins, and should be removed promptly when cooking is completed. Eating spoiled food can result in sickness from food poisoning.

Setting Oven Controls (continued)

Setting Delayed Timed Bake, Delayed Timed Convection Bake or Convection Roast

The **BAKE**  or **CONVECTION BAKE** , or **CONVECTION ROAST** , **BAKE TIME**  and **START TIME**











 pads control the Delayed Time Bake feature. The automatic timer of the Delayed Time Bake will turn the oven **on and off** at the time you select in advance. **Note:** If your clock is set for normal 12 hour display mode the Delayed Timed Bake or Delayed Timed Convection Bake cycle can never be set to start more than 12 hours in advance. To set for Delayed Timed Bake or Delayed Timed Convection Bake 12-24 hours in advance set the control for the 24 hour time of day display mode.

INSTRUCTIONS

PRESS

DISPLAY

To program the oven for a delayed **BAKE** start time and to shut off automatically (example: baking at 350°F, starting at 5:30 and baking for 30 minutes)

1. Be sure that the clock is set with the correct time of day.
2. Arrange interior oven rack(s) and place the food in the oven.
3. Press . "350°" will appear and "BAKE" will flash in the display (Figure 1).
4. Press . "BAKE" and "350°" will stay in the display (Figure 2).
5. Press . "TIMED" will flash, "- - - -" will appear and "BAKE" and "350°" will remain in the display (Figure 3).
6. Enter the desired baking time using the number pads by pressing  . "TIMED" will flash; "BAKE", "- - 30" and "350°" will appear in the display (Figure 4). Note: Baking time can be set for any amount of time from 1 minute to 11 hours and 59 minutes.
7. Press . "TIMED", "BAKE" and "350°" will remain in the display (Figure 5).
8. Press . "DELAY" will flash in the display. Enter the desired start time using the number pads    (Figure 6).
9. Press . When Delayed Time Bake starts, "DELAY", "BAKE" and the current time of day will appear in the display (Figure 7).
10. When the desired start time is reached, the fan icon appears in display and "DELAY" disappears. Oven starts to bake at the previously selected temperature (Figure 8).

Note: Once Delayed Time Bake has started, press  to display the bake time remaining. Once the Delayed Timed Bake has started baking, a beep will sound when the oven temperature reaches the set temperature.

Press  when baking has completed or at any time to cancel the Delayed Time Bake feature.

When the set bake time runs out:

1. "End" will appear in the display and the oven will shut off automatically (Figure 9).
2. The control will beep 3 times. The control will continue to beep 3 times every 30 seconds until  is pressed.



Figure 1



Figure 2

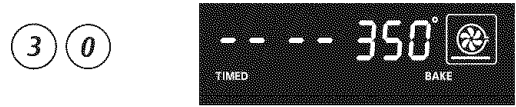

Figure 3



Figure 4

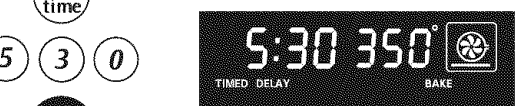

Figure 5



Figure 6



Figure 7

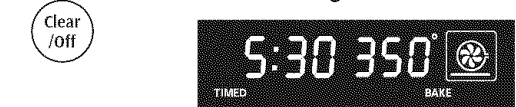

Figure 8



Figure 9

Setting Oven Controls (continued)

Setting Broil

The **Broil** pad controls the Broil feature. When broiling, heat radiates downward from the oven broiler for even coverage. The Broil feature is preset to start broiling at 550°F; however, the Broil feature temperature may be set between 400°F and 550°F. The broil pan and broil pan insert used together allow dripping grease to drain and be kept away from the high heat of the oven broiler. **DO NOT** use the broil pan without the insert (See Figure 5). **DO NOT cover the broil pan insert with foil.** The exposed grease could catch fire.

⚠ WARNING Should an oven fire occur, leave the oven door closed and turn off the oven. If the fire continues, throw baking soda on the fire or use a fire extinguisher. **DO NOT** put water or flour on the fire. Flour may be explosive and water can cause a grease fire to spread and cause personal injury.

INSTRUCTIONS

To set the oven to broil at the default setting (550°F):

- Place the broiler pan insert on the broiler pan. Then place the food on the broiler pan insert. **DO NOT** use the broiler pan without the insert. **DO NOT** cover the broiler insert with foil. The exposed grease could ignite.
- Arrange the interior oven rack and place the broiler pan on the rack. Be sure to center the broiler pan directly under the broiler element. **Electric Oven Only:** Make sure the oven door is in the broil stop position (see Figure 4). **Gas Oven Only:** Close the oven door. For optimum browning, preheat broil burner for 3-4 minutes before adding food.
- Press **Broil**. "BROIL" will flash and "550°" will appear (Figure 1).
- If a lower broil temperature is desired (minimum broil temperature setting is 400°F), press the desired temperature before continuing to step 5.
- Press **START**. The oven will begin to broil. "BROIL" and "550°" will appear in the display (Figure 2).
- Broil on one side until food is browned; turn and cook on the second side. Season and serve. **Note:** Always pull the rack out to the stop position before turning or removing food.
- To cancel broiling or if finished broiling press **Clear /off** (Figure 3).

Broiling Times

Use the following table for approximate broiling times. Increase or decrease broiling times, or move the broiling pan to a different rack position to suit for doneness. If the food you are broiling is not listed in the table, follow the instructions provided in your cookbook and watch the item closely.

Electric and Gas Oven Broiling Table Recommendations

Food Item	Rack Position from bottom	Temp Setting	Cook Time for ELECTRIC Oven Models		Cook Time For GAS Oven Models		Doneness
			1st side	2nd side	1st side	2nd side	
Steak 1" thick	3rd or 4th	550° F	6:00	4:00	8:00	6:00	Rare
	3rd or 4th	550° F	7:00	5:00	10:00	8:00	Medium
Pork Chops 3/4" thick	3rd	550° F	8:00	6:00	12:00	8:00	Well
Chicken - Bone In	2nd	450° F	20:00	10:00	25:00	15:00	Well
Chicken - Boneless	3rd	450° F	8:00	6:00	10:00	8:00	Well
Fish	3rd	500° F	13:00	n/a	as directed	as directed	Well
Shrimp	2nd	550° F	5:00	n/a	as directed	as directed	Well
Hamburger 1" thick	4th	550° F	9:00	7:00	12:00	10:00	Medium
	3rd	550° F	10:00	8:00	14:00	12:00	Well

PRESS

DISPLAY



Figure 1



Figure 2



Figure 3

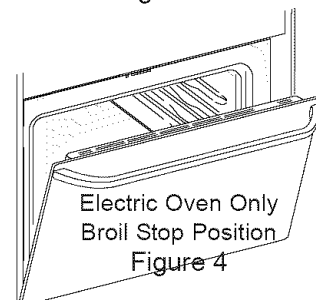

Electric Oven Only
Broil Stop Position
Figure 4

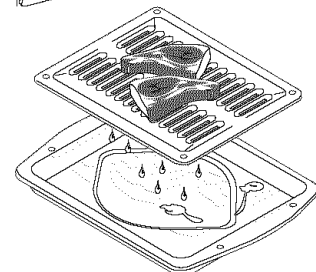





Figure 5
Doneness





Setting Oven Controls (continued)



To Set the Sabbath Feature (for use on the Jewish Sabbath & Holidays)

The **BAKE TIME**  and **START TIME**  pads are used to set the Sabbath feature. The Sabbath feature may

only be used with the **Bake**  pad. The oven temperature may be set higher or lower after setting the Sabbath feature (the oven temperature adjustment feature should be used only during Jewish Holidays), however the display will not visibly show or provide any audible tones indicating whether the change occurred correctly. Once the oven is properly set using Bake with the Sabbath feature active, the oven will remain continuously ON until cancelled. This will override the factory preset 12-Hour Energy Saving feature.





If the oven light will be needed during the Sabbath, press **Oven light**  before activating the Sabbath feature. Once the oven light is turned ON and the Sabbath feature is active, the oven light will remain ON until the Sabbath feature is turned OFF. If the oven light needs to be OFF, be sure to turn the oven light OFF before activating the Sabbath feature.

IMPORTANT NOTES: It is not advised to attempt to activate any other program feature other than **BAKE** while the Sabbath feature is active. ONLY the following key pads will function after setting the Sabbath feature;  to .

  & . **ALL OTHER KEYPADS** will not function once the Sabbath feature is properly activated.

INSTRUCTIONS

To Program the Oven to Begin Baking Immediately & activate the Sabbath feature (example: baking at 350°F)

1. Be sure that the clock is set with the correct time of day.
2. Arrange the oven racks and place the food in the oven.
3. Press , "350°" appears in the display.
4. Press  (Figure 1).
5. If a **Timed Bake** or **Delayed Timed Bake** is needed then enter the time in this step. If not, skip this step and continue to step 7. Refer to the **Timed Bake / Delayed Timed Bake** section for complete instructions. Remember the oven will shut down after completing a **Timed Bake** or **Delayed Timed Bake** and therefore may only be used once during the Sabbath/Jewish Holidays. The maximum delay time is 11 hours & 59 minutes.
6. The oven will turn ON and begin heating.
7. At the same time press and hold both the  and  pads for at least 3 seconds. **SAb** will appear in the display (Figure 2). Once **SAb** appears in the display the oven control will no longer beep or display any further changes and the oven is properly set for the Sabbath feature.

PRESS

DISPLAY







 and 



Figure 1



Figure 2





Setting Oven Controls (continued)

To Set the Sabbath Feature (for use on the Jewish Sabbath & Holidays)



INSTRUCTIONS

PRESS

DISPLAY

Note: You may change the oven temperature once baking has started by pressing , the numeric key pads for the temperature you want (example for 425°F press , , ) and then pressing  TWICE (for Jewish Holidays only).

Remember that **the oven control will no longer beep when a keypad is pressed or display any further changes** once the oven is set for the Sabbath feature.

8. The oven may be turned OFF at any time by first pressing  pad (this will turn the oven OFF only). To turn OFF the Sabbath feature press and hold both the  and  pads for at least 3 seconds. This also turns off the oven. **SAb** will disappear from the display (figure 1).

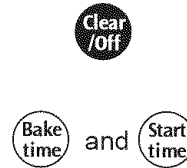



Figure 1

It is recommended that at any oven temperature change with the Sabbath feature activated be followed with 2 presses of the START pad. This will insure the oven remains ON even if the attempt to set the oven temperature was lower or higher than the oven control can accept. If the oven temperature is set incorrectly, the oven temperature will default to 170°F or 550°F. Try to set the desired oven temperature again.

Should you experience a power failure or interruption, the oven will shut off. When power is returned the oven will not turn back on automatically. The oven will remember that it is set for the Sabbath and the food may be safely removed from the oven while still in the Sabbath feature, however the oven cannot be turned back on until after the Sabbath. After the

Sabbath observance turn OFF the Sabbath feature. Press and hold both the  and  pads for at least 3 seconds. **SAb** will disappear from the display and the oven may be used with all normal functions. For further assistance, guidelines for proper usage, and a complete list of models with the Sabbath feature, please visit the web at <http://www.star-k.org>.

Setting Oven Controls (continued)

Setting the Keep Warm Feature



The **Keep Warm**  pad turns ON the Keep Warm feature and will maintain an oven temperature of 170°F (77°C).

The Keep Warm feature will keep oven baked foods warm for serving up to 3 hours after cooking has finished. After 3 hours the Keep Warm feature will shut the oven OFF. The Keep Warm feature may be used without any other cooking operations or can be used after cooking has finished using BAKE, CONVECTION BAKE or CONVECTION ROAST.

The Keep Warm feature may be used with TIMED BAKE if you wish to have the Keep Warm feature turn ON automatically when cooking has finished. The Timed Bake features require you to set start time and the amount of cooking time. With this information the control can calculate the time when cooking will complete and can then start the Keep Warm feature automatically.

INSTRUCTIONS

To set Keep Warm

1. Arrange interior oven racks and place food in oven.
2. Press . "HLd" and "WARM" will appear in the display (Figure 1). Note: If no pad is touched within 25 seconds the request to turn ON Keep Warm feature will be cancelled.
3. Press . The oven icon will appear in the display (Figure 2).
4. To turn the Keep Warm OFF at any time press .
Note: The Keep Warm feature will automatically turn OFF after 3 hours.

PRESS



DISPLAY



Figure 1



Figure 2

To set Keep Warm to turn ON automatically





1. Arrange interior oven racks and place food in oven. Set the oven properly for **Timed Bake or Delayed Timed Bake**.
2. Press . (Figure 3)
Note: If no pad is touched within 25 seconds the request to turn ON the Keep Warm feature and all functions previously programmed will be cleared.
3. Press . "HLd" will disappear and the temperature will be displayed (Figure 4). The Keep Warm mode is set to turn ON automatically after Timed Bake has finished (See Figure 2).
4. To turn the Keep Warm feature OFF at any time press .
Note: The Keep Warm feature will automatically turn OFF after 3 hours.



Figure 3



Figure 4

Pressing  at any time will stop all oven baking operations.



To turn ON/OFF the Oven Light

The oven light automatically turns ON when the oven door is opened. The oven light may also be manually turned ON or OFF by pressing the  pad.

Oven Cleaning

Self-Clean Cycle Time Length

The **SPEED CLEAN** (Speed clean), **CLEAN** (Clean) and **MAXX CLEAN** (Maxx clean) pads control the Self-Cleaning feature. If you are planning to use the oven directly after a self-clean cycle remember to allow time for the oven to cool down and the oven door to unlock. This normally takes about one hour. So a 3 hour self-clean cycle will actually take about 4 hours to complete. *It is recommend to use a (Speed clean) cycle (2 hour) for **light soils**, a (Clean) cycle (3 hour) for **average soils**, and a (Maxx clean) cycle (4 hour) for **heavy soils** (to assure satisfactory results).

⚠ WARNING During the Self-Cleaning cycle, the outside of the range can become very hot to touch. **DO NOT** leave small children unattended near the appliance.

⚠ CAUTION To avoid possible burns use care when opening the oven door after the Self-Cleaning cycle. Stand to the side of the oven when opening the door to allow hot air or steam to escape.

⚠ CAUTION **DO NOT** force the oven door open. This can damage the automatic door locking system. Use caution and avoid possible burns when opening the door after the Self-Cleaning cycle has completed. The oven may still be VERY HOT.

INSTRUCTIONS

PRESS

DISPLAY

To start an immediate Self-Cleaning cycle or to set a delay start time of 4:30 o'clock and shut of automatically (example provided is a default 3 hour Self-Clean cycle):

1. Be sure the clock is set with the correct time of day, the oven is empty and the oven door is closed.
2. Press (Clean). "CLEAN" will flash and "3:00" HR will show in the display (Figure 1). The control will automatically clean for a 3 hour period (default self-cleaning cycle time). Note: If a 2 or 4 hour clean time is desired, press (Speed clean) for 2 hour or press (Maxx clean) for a 4 hour clean time. Set the cleaning time based on the amount of soil: light, medium or heavy (* See above).
3. Press (START). The "DOOR LOCKED" icon will flash; "CLEAN" icon and the letters "CLn" will remain on in the display (Figure 2).
4. As soon as the control is set, the motor driven oven door lock will begin to close automatically. Once the door has been locked the "DOOR LOCKED" indicator light will stop flashing and remain on. Also, the oven icon will appear in the display (Figure 3).

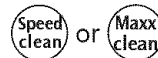

Figure 1



Figure 2



Figure 3

Note: Allow about 15 seconds for the oven door lock to close.

NOTE: If the optional delay Self-Clean feature is needed, finish steps 5-7. If Self-Clean is started immediately skip the remaining steps and continue with "When the Self-Clean cycle is done" on the following page.

5. Press (Start time). Enter the desired start time using the number pads (4) (3) (0) (Figure 4).
6. Press (START). "CLn", "DELAY", "DOOR LOCKED" and "CLEAN" icons will remain on (Figure 5).
7. The control will start the self-cleaning at the set start time, for the period of time previously selected. At that time, the icon "DELAY" will go out; "CLn" and oven icon will appear in the display (Figure 6).



Figure 4



Figure 5



Figure 6

Oven Cleaning (continued)

INSTRUCTIONS

When the Self-Clean Cycle is Completed

1. "Hot" will appear in the display with the time of day to indicate the oven must cooled down before it can be used normally (Figure 1; or Figure 2 if the clean cycle is used with the delay feature).
2. Once the oven has cooled down enough "Hot" message will disappear, the oven door will unlock and "DOOR LOCKED" will disappear from the display. The oven door can then be opened (Figure 3).

Stopping or Interrupting a Self-Cleaning Cycle

If it becomes necessary to stop or interrupt a self-cleaning cycle due to excessive smoke or fire in the oven:

1. Press .
2. The oven door can only be opened after the oven has cooled down for approximately 1 HOUR and "Hot" and "DOOR LOCKED" is no longer displayed (Figure 3).

PRESS

DISPLAY



Figure 1



Figure 2



Figure 3



IMPORTANT NOTES when using the Self-Clean feature:

1. On some models, the Self-Clean feature will not operate whenever a radiant surface remains ON.
2. On some models, starting a self-clean cycle will turn ON the Cooktop Lockout feature. If it is the case the symbol  will appear in the display (Figure 4) which will indicate that the Cooktop Lockout feature is ON. The cooktop will remain locked until the Self-Clean cycle has completed and the oven door has unlocked.
3. A Self-Clean cycle cannot be started if Oven Lockout feature is active.
4. If a Self-Cleaning Cycle has started but not finished and a power failure occurs, the appliance may not have thoroughly cleaned. Once power is restored, the oven door and the cooktop are unlocked. Then set for another Self-Clean cycle to finish.
5. If your clock is set for normal 12 hour display mode the Delay Self-Clean cycle can never be set to start more than 12 hours in advance. To set for a delayed Self-Cleaning cycle 12-24 hours in advance set the control for the 24 hour time of day display mode.



Figure 4

Adjusting Oven Temperature

The temperature in the oven has been pre-set at the factory. When first using the oven, be sure to follow recipe times and temperatures. If you think the oven is cooking too hot or too cool for the temperature you select, you can adjust the actual oven temperature to be more or less than what is displayed. Before adjusting, test a recipe by using a temperature setting that is higher or lower than the recommended temperature. The baking results should help you to decide how much of an adjustment is needed.

Note: The oven temperature adjustments made with this feature will not change the Self-Clean cycle temperature or the Broil temperature.

INSTRUCTIONS

To adjust the oven temperature higher

1. Press **Bake** for 6 seconds. 0° will appear in the display (Figure 1).
2. To increase the temperature use the number pads to enter the desired change. (Example 30°F) **3** **0** (Figure 2). The temperature may be increased by as much as 35°F (19°C).
3. Press **START** to accept the temperature change and the display will return to the time of day (Figure 3). Press **Clear/Off** to reject the change if necessary.

To adjust the oven temperature lower

1. Press **Bake** for 6 seconds. 0° will appear in the display (Figure 4).
2. To decrease the temperature use the number pads to enter the desired change. (Example -30°F) **3** **0** and then press **Clean** (Figure 5). The temperature may be decreased by as much as 35°F (19°C).
3. Press **START** to accept the temperature change and the display will return to the time of day (Figure 6). Press **Clear/Off** to reject the change if necessary.

PRESS

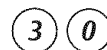

DISPLAY



Figure 1



Figure 2



Figure 3



Figure 4



Figure 5



Figure 6

To Set the Oven Control Back To The Factory Default Settings

This function allows you to reset the user defined settings back to the original settings. These include 12 or 24 Hour Time of Day Display, Continuous Control Operation or 12 Hour Energy Saving mode, Silent Control Operation or Normal Sounds, Fahrenheit or Celsius Temperature Display, Oven Temperature Adjustment (set back to 0).

1. Press and hold **7** until the first single beep sounds (about 6 seconds)
2. After the first beep, press **START** pad once. All the settings are now set to the original factory default.