

# Owner's Manual and Installation Instructions

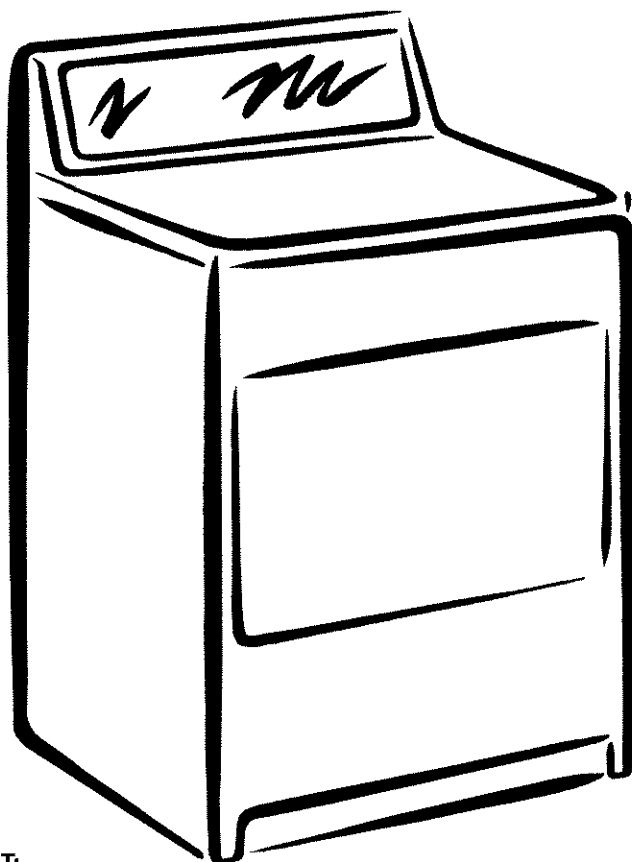

## 29-Inch Wide GAS DRYERS



### **IMPORTANT:**

Read and follow all safety  
and operating instructions  
before first use of this product.

Sears, Roebuck and Co., Hoffman Estates, IL 60179 U.S.A.  
[www.sears.com](http://www.sears.com)

ENGLISH ESPAÑOL

**WARNING:** For your safety the information in this manual must be followed to minimize the risk of fire or explosion or to prevent property damage, personal injury, or death.

**-Do not store or use gasoline or other flammable vapors and liquids in the vicinity of this or any other appliance.**

**-WHAT TO DO IF YOU SMELL GAS:**

- Do not try to light any appliance.
- Do not touch any electrical switch; do not use any phone in your building.
- Clear the room, building, or area of all occupants.
- Immediately call your gas supplier from a neighbor's phone. Follow the gas supplier's instructions.
- If you cannot reach your gas supplier, call the fire department.

**-Installation and service must be performed by a qualified installer, service agency, or the gas supplier.**

## TABLE OF CONTENTS

BEFORE USING YOUR NEW DRYER .....	3
KENMORE DRYER WARRANTY .....	4
DRYER SAFETY .....	5
INSTALLATION INSTRUCTIONS .....	7
DRYER USE .....	17
LAUNDRY TIPS .....	23
DRYER CARE .....	25
TROUBLESHOOTING .....	28
WE SERVICE WHAT WE SELL .....	30

ENGLISH

## BEFORE USING YOUR NEW DRYER

Please read this manual. It will help you install and operate your new Kenmore dryer in the most economical way.

If you need more information about the care and operation of Kenmore appliances call your nearest Sears store. You will need the complete model and serial numbers when requesting information. Your dryer's model and serial numbers are located on the Model and Serial Number Plate.

### Product Record

Use the space below to record the model number and serial number of your new Kenmore dryer.

Model No. \_\_\_\_\_

Serial No. \_\_\_\_\_

Date of Purchase \_\_\_\_\_

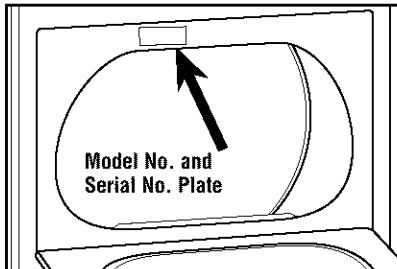

**Keep this book and your Sears Salescheck (receipt) in a safe place for future reference.**

## KENMORE DRYER WARRANTY

### **Full One Year Warranty on Mechanical and Electrical Parts**

For one year from the date of purchase, if this dryer is installed and operated according to the instructions in this manual, Sears will repair or replace any of its mechanical or electrical parts if they are defective in material or workmanship.

**NOTE:** Exhausting your dryer with a plastic vent may void this warranty. See "Installation Instructions" for the complete exhaust requirements for this dryer.

### **Warranty Restriction**

If the dryer is subjected to other than private family use, all warranty coverage is effective for only 90 days.

### **Warranty Service**

Warranty service is available by contacting your nearest Sears Service Center in the United States.

This warranty applies only while this dryer is in use in the United States.

This warranty gives you specific legal rights, and you may also have other rights which vary from state to state.

**Sears, Roebuck and Co., Dept. 817WA,  
Hoffman Estates, IL 60179.**

For Sears Warranty information or to contact a Sears Service Center, please reference the service numbers on the back page of this manual.

## DRYER SAFETY

### **Your safety and the safety of others are very important.**

We have provided many important safety messages in this manual and on your appliance. Always read and obey all safety messages.



This is the safety alert symbol. This symbol alerts you to potential hazards that can kill or hurt you and others. All safety messages will follow the safety alert symbol and either the word "DANGER" or "WARNING." These words mean:

**⚠ DANGER**

**You can be killed or seriously injured if you don't immediately follow instructions.**

**⚠ WARNING**

**You can be killed or seriously injured if you don't follow instructions.**

All safety messages will tell you what the potential hazard is, tell you how to reduce the chance of injury, and tell you what can happen if the instructions are not followed.

ENGLISH

## IMPORTANT SAFETY INSTRUCTIONS

**WARNING:** To reduce the risk of fire, electric shock, or injury to persons when using the dryer, follow basic precautions, including the following:

- Read all instructions before using the dryer.
- Do not place items exposed to cooking oils in your dryer. Items contaminated with cooking oils may contribute to a chemical reaction that could cause a load to catch fire.
- Do not dry articles that have been previously cleaned in, washed in, soaked in, or spotted with gasoline, dry-cleaning solvents, other flammable, or explosive substances as they give off vapors that could ignite or explode.
- Do not allow children to play on or in the dryer. Close supervision of children is necessary when the dryer is used near children.
- Before the dryer is removed from service or discarded, remove the door to the drying compartment.
- Do not reach into the dryer if the drum is moving.
- Do not install or store the dryer where it will be exposed to the weather.
- Do not tamper with controls.
- Do not repair or replace any part of the dryer or attempt any servicing unless specifically recommended in this Owner's Manual or in published user-repair instructions that you understand and have the skills to carry out.
- Do not use fabric softeners or products to eliminate static unless recommended by the manufacturer of the fabric softener or product.
- Do not use heat to dry articles containing foam rubber or similarly textured rubber-like materials.
- Clean lint screen before or after each load.
- Keep area around the exhaust opening and adjacent surrounding areas free from the accumulation of lint, dust, and dirt.
- The interior of the dryer and exhaust vent should be cleaned periodically by qualified service personnel.
- See the "INSTALLATION INSTRUCTIONS" section for grounding requirements.

## SAVE THESE INSTRUCTIONS

**IMPORTANT:** The gas installation must conform with local codes, or in the absence of local codes, with the National Fuel Gas Code, ANSI Z223.1/NFPA 54. The dryer must be electrically grounded in accordance with local codes, or in the absence of local codes, with the National Electrical Code, ANSI/NFPA 70 or Canadian Electrical Code, CSA C22.1.

## INSTALLATION INSTRUCTIONS

### Tools and Parts

Check that you have everything necessary for correct installation. Proper installation is your responsibility.

- 8 or 10 in. pipe wrench
- 8 or 10 in. adjustable wrench (for gas connections)
- flat-blade screwdriver
- adjustable wrench that opens to 1 in. or hex-head socket wrench (for adjusting dryer feet)
- level
- 1/4 in. nut driver or socket wrench
- knife
- safety glasses
- duct tape
- pipe-joint compound resistant to L.P. gas
- caulking gun and compound (for installing new exhaust vent)
- gloves
- pliers

### Parts supplied:

Remove parts package from dryer drum. Check that all parts were included

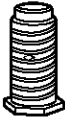

4 leveling legs

### Parts needed:

Check local codes and with gas supplier, check existing gas supply, electrical supply and venting, and read "Electrical Requirements," "Gas Supply Requirements" and "Venting Requirements" before purchasing parts.

### Mobile home installations require:

- Mobile home installation kit. To order, call your local Sears store or Sears Service Center reference the service numbers on the back page of this book. Ask for Part Number 346764.
- Metal exhaust system hardware available for purchase from your local Sears store or Sears Service Center.

ENGLISH

## Location Requirements

### **⚠ WARNING**



#### Explosion Hazard

Keep flammable materials and vapors, such as gasoline, away from dryer.

Place dryer at least 18 inches (46 cm) above the floor for a garage installation.

Failure to do so can result in death, explosion, or fire.

#### You will need

- A location that allows for proper exhaust installation. A gas dryer must be exhausted to the outdoors. See "Venting Requirements."
- A grounded electrical outlet located within 2 ft (61 cm) of either side of the dryer. See "Electrical Requirements."
- A sturdy floor to support the dryer with a total weight (dryer and load) of 200 lbs (90.7 kgs).
- A level floor with a maximum slope of 1 in. (2.5 cm) under entire dryer. (If slope is greater than 1 in. [2.5 cm], install Extended Dryer Feet kit, Part No. 279810.) Clothes may not tumble properly and dryers with automatic sensor cycles may not operate correctly if dryer is not level.

Do not operate or store your dryer in a location with year-round temperatures below 45°F (7°C). At lower temperatures, the dryer might not shut off at the end of an automatic cycle. Drying times can be extended.

Install the dryer where it is protected from water and/or weather.

Check code requirements. Some codes limit, or do not permit, installation of the dryer in garages, closets, mobile homes, or sleeping quarters. Contact your local building inspector.

**NOTE:** No other fuel-burning appliance can be installed in the same closet as a dryer.

## Installation Clearances

The location must be large enough to fully open the dryer door.

## Dryer Dimensions

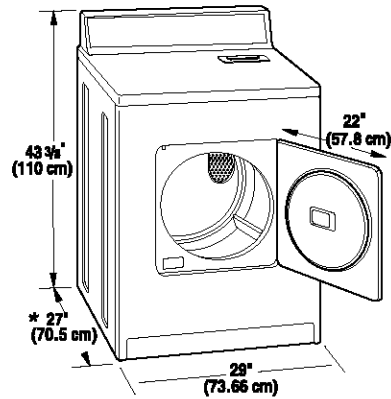

1. Small Opening Side-Swing Door

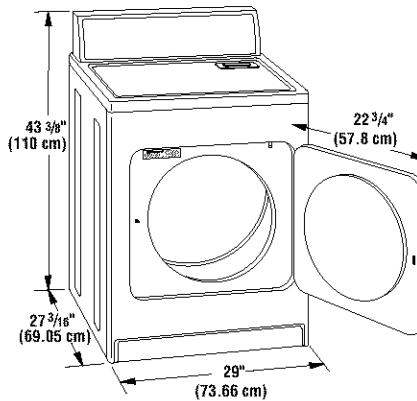

2. Large Opening Side-Swing Door



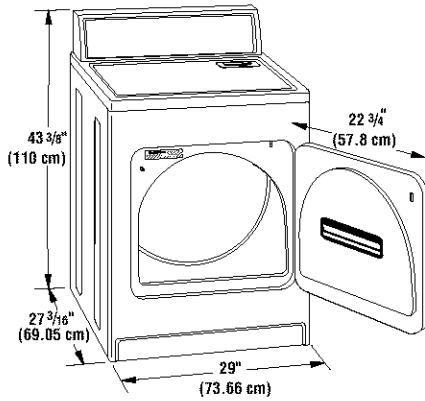

3. Wide Opening Side-Swing Door

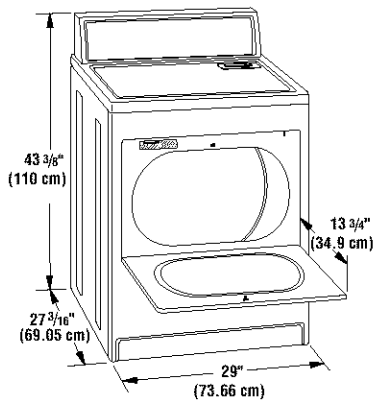

4. Wide Opening Hamper Door

\*Most installations require a minimum 5 in. (14 cm) clearance behind the dryer for the exhaust vent with elbow. See "Venting Requirements."

**Minimum installation spacing for recessed area or closet installation**

The dimensions shown following are for the minimum spacing allowed.

- Additional spacing should be considered for ease of installation and servicing.
- Additional clearances might be required for wall, door and floor moldings.
- Additional spacing of 1 in. (2.5 cm) on all sides of the dryer is recommended to reduce noise transfer.
- For closet installation with a door, minimum ventilation openings in the top and bottom of the door are required. Louvered doors with equivalent ventilation openings are acceptable.

- Companion appliance spacing should also be considered.

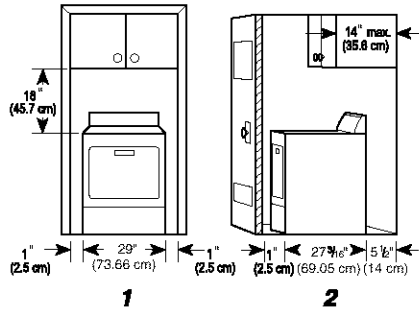

1

2

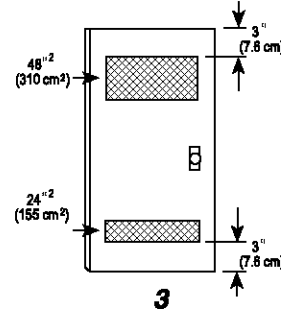

3

1. Recessed Area
2. Side view - closet or confined area
3. Closet door with vents

**Mobile Home-Additional Installation Requirements**

This dryer is suitable for mobile home installations. The installation must conform to the Manufactured Home Construction and Safety Standard, Title 24 CFR, Part 3280 (formerly the Federal Standard for Mobile Home Construction and Safety, Title 24, HUD Part 280).

**Mobile home installations require:**

- Metal exhaust system hardware which is available for purchase from your local Sears store or Sears Service Center.
- Mobile home Installation Kit Part Number 346764, see "Tools and Parts" section for ordering information.
- Special provisions must be made in mobile homes to introduce outside air into the dryer. The opening (such as a nearby window) should be at least twice as large as the dryer exhaust opening.

ENGLISH

## Electrical Requirements

### **WARNING**



#### Electrical Shock Hazard

Plug into a grounded 3 prong outlet.  
Do not remove ground prong.  
Do not use an adapter.  
Do not use an extension cord.  
Failure to follow these instructions  
can result in death, fire, or  
electrical shock.

- 120-Volt, 60-Hz., AC-only, 15- or 20-amp fused electrical supply is required. (Time-delay fuse or circuit breaker is recommended.) It is recommended that a separate circuit serving only this dryer be provided.

### **GROUNDING INSTRUCTIONS**

For a grounded, cord-connected dryer:  
This appliance must be grounded. In the event of malfunction or breakdown, grounding will reduce the risk of electric shock by providing a path of least resistance for electric current. This dryer is equipped with a cord having an equipment-grounding conductor and a grounding plug. The plug must be plugged into an appropriate outlet that is properly installed and grounded in accordance with all local codes and ordinances.

**WARNING:** Improper connection of the equipment grounding conductor can result in a risk of electric shock. Check with a qualified electrician or service representative or personnel if you are in doubt as to whether the dryer is properly grounded. Do not modify the plug provided with the dryer: if it will not fit the outlet, have a proper outlet installed by a qualified electrician.

**SAVE THESE INSTRUCTIONS**

## Gas Supply Requirements

### **WARNING**



#### Explosion Hazard

Use a new AGA or CSA approved gas supply line.

Install a shut-off valve.

Securely tighten all gas connections.

If connected to LP, have a qualified person make sure gas pressure does not exceed 13" (33 cm) water column.

Examples of a qualified person include:

licensed heating personnel,  
authorized gas company personnel,  
and authorized service personnel.

Failure to do so can result in death,  
explosion, or fire.

### **Gas Type**

#### **Natural Gas:**

This dryer is equipped for use with NATURAL GAS. It is design-certified by CSA International for L.P. (propane or butane) gases with appropriate conversion.

- Your dryer must have the correct burner for the type of gas in your home. Burner information is located on the rating plate in the door well of your dryer. If this information does not agree with the type of gas available, contact your local Sears store or Sears Service Center.

#### **L.P. gas conversion:**

**Conversion must be made by a qualified technician.**

No attempt shall be made to convert the appliance from the gas specified on the model/serial rating plate for use with a different gas without consulting the serving gas supplier.

### Gas Supply Line:

- 1/2 in. IPS pipe is recommended.
- 3/8 in. approved tubing is acceptable for lengths under 20 ft (6.1 m) if local codes and gas supplier permit.
- Must include 1/8 in. NPT plugged tapping, immediately upstream of the gas connection (see illustration).
- Must include a shutoff valve.  
An individual shutoff valve must be installed within six (6) feet (1.8 m) of the dryer in accordance with the National Fuel Gas Code, ANSI Z223.1. The location should be easy to reach for opening and closing.

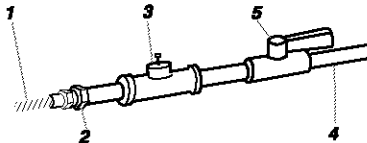

1. 3/8 in. flexible gas connector
2. 3/8 in. pipe to flare adapter fitting
3. 1/8 in. NPT plugged tapping
4. 1/2 in. NPT gas supply line
5. Gas shut-off valve

### Gas Supply Connection Requirements:

There are many methods by which your gas dryer can be connected to the gas supply. Listed here are some guidelines for two different methods of connection.

#### Option 1 (Recommended Method):

Flexible stainless steel tubing:

- If local codes permit, use flexible stainless steel tubing (Design Certified by the American Gas Association or CSA International) to connect your dryer to the rigid gas supply line. Use an elbow and a 3/8 in. flare x 3/8 in. NPT adapter fitting between the stainless steel tubing and the dryer gas pipe, as needed to prevent kinking.

#### Option 2 (Alternate Method):

Approved aluminum or copper tubing:

- Lengths under 20 ft (6.1 m) can use 3/8 in. approved tubing (if codes and gas supplier permit).
- If you are using natural gas, do not use copper tubing.
- 3/8 in. flare x 3/8 in. NPT adapter fitting between dryer pipe and 3/8 in. approved tubing.
- Lengths over 20 ft (6.1 m) should use larger tubing and a different size adapter fitting.

- If your dryer has been converted to use L.P. gas, 3/8 in. L.P. compatible copper tubing can be used. If the total length of the supply line is more than 20 ft (6.1 m), use larger pipe.

**NOTE:** Pipe joint compounds that resist the action of L.P. gas must be used. Do not use TEFLON® tape.

### Dryer Gas Pipe

- The gas pipe that comes out through the rear of your dryer has a 3/8 in. male pipe thread.

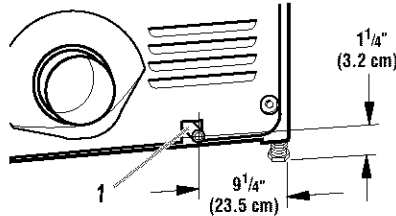

1. 3/8 in. NPT dryer pipe

### Burner Input Requirements:

#### Elevations up to 10,000 feet:

- The design of this dryer is certified by CSA International for use at altitudes up to 10,000 ft (3,000 m) above sea level at the B.T.U. rating indicated on the model/serial number plate. Burner input adjustments are not required when the dryer is operated up to this elevation.

#### Elevations above 10,000 feet:

- When installed above 10,000 ft (3,000 m) a 4% reduction of the burner B.T.U. rating shown on the model/serial number plate is required for each 1,000 ft (305 m) increase in elevation.

### Gas Supply Pressure Testing

- The dryer must be disconnected from the gas supply piping system during any pressure testing of that system at test pressures in excess of 1/2 psi.
- The dryer must be isolated from the gas supply piping system by closing the supply line shutoff valve during any pressure testing of the gas supply piping system at test pressures equal to or less than 1/2 psi.

ENGLISH

## Venting Requirements

### **⚠ WARNING**



#### Fire Hazard

**Use a heavy metal vent.  
Do not use a plastic vent.  
Do not use a metal foil vent.  
Failure to follow these instructions  
can result in death or fire.**

**WARNING:** To reduce the risk of fire, this dryer **MUST BE EXHAUSTED OUTDOORS**.

4 in. (10.2 cm) heavy metal exhaust vent and clamps must be used. DURASAFE™ venting products are recommended and are available from your local Sears store or Sears Service Center.

DURASAFE vent products can be purchased from your dealer. Please reference the service numbers located on the back page of this manual or visit our Internet site at: [www.sears.com](http://www.sears.com).

- Do not exhaust the dryer into any gas vent, chimney, wall, ceiling, or a concealed space of a building.
- Do not use an exhaust hood with a magnetic latch.
- Do not install flexible metal vent in enclosed walls, ceilings or floors.
- Do not use screws or other fastening devices that extend into the interior of the vent to secure vent.

**IMPORTANT:** Observe all governing codes and ordinances.

#### **Improper venting can cause moisture and lint to collect indoors, which may result in:**

- Moisture damage to woodwork, furniture, paint, wallpaper, carpets, etc.
- Housecleaning problems and health problems.

Use a heavy metal vent. Do not use plastic or metal foil vent.

Rigid metal vent is recommended to prevent crushing and kinking.

Flexible metal vent must be fully extended and supported when the dryer is in its final position. Remove excess flexible metal vent to avoid sagging and kinking that may result in reduced airflow.

An exhaust hood should cap the vent to prevent rodents and insects from entering the home.

Exhaust hood must be at least 12 in. (30.5 cm) from the ground or any object that may be in the path of the exhaust (such as flowers, rocks or bushes, etc.).

If using an existing vent system, clean lint from the entire length of the system and make sure exhaust hood is not plugged with lint. Replace any plastic or metal foil vent with rigid metal or flexible metal vent.

Use duct tape to seal all joints.

## Plan Vent System

### Typical Exhaust Installations

Typical installations vent the dryer from the rear of the dryer.

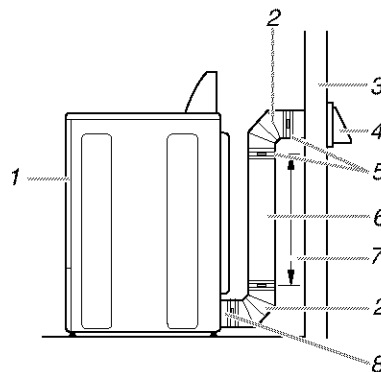

1. Dryer
2. Elbow
3. Wall
4. Exhaust hood
5. Duct tape and clamps
6. Rigid metal or flexible metal vent
7. Vent length necessary to connect elbows
8. Exhaust outlet

**Standard exhaust installation with rigid metal or flexible metal vent**

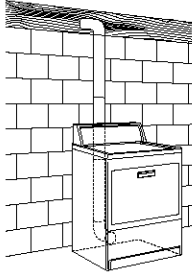

**Alternate installations for close clearances**

Venting systems come in many varieties. Select the type best for your installation. Two close-clearance installations are shown. Refer to the manufacturer's instructions.

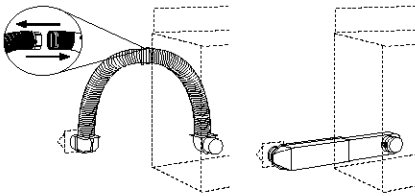

1. Over-The-Top installation (also available with one offset elbow)
2. Periscope installation

**NOTE:** The following kits for close clearance alternate-installations are available for purchase. Please see the service number located on the back page of this manual to order.

• **Over-The-Top Installation:**

Part Number 26-49900

• **Periscope Installation (For use with dryer vent to wall vent mismatch):**

Part Number 26-49901 - Less than 5 in. (12.7 cm) mismatch

Part Number 26-49908 - 5 in. (12.7 cm) to 18 in. (45.72 cm) mismatch

Part Number 26-49904 - 18 in. (45.72 cm) to 29 in. (73.66 cm) mismatch

Part Number 26-49905 - 29 in. (73.66 cm) to 50 in. (127 cm) mismatch

**Special provisions for mobile home installations**

The exhaust vent must be securely fastened to a noncombustible portion of the mobile home structure. Do not use screws or other fastening devices that extend into the interior of the vent to secure vent.

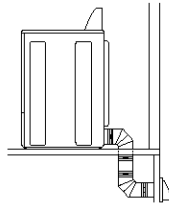

Terminate the exhaust vent outside. The exhaust vent must not terminate beneath the mobile home and must not be connected to any other duct, vent or chimney.

**Determine Vent Length**

1. Select the route that will provide the straightest and most direct path outdoors. Plan the installation to use the fewest number of elbows and turns.

When using elbows or making turns, allow as much room as possible. Bend vent gradually to avoid kinking. Avoid 90° turns.

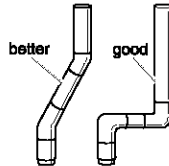

2. Determine vent length  
The maximum length of the exhaust system depends upon:
  - The type of vent (rigid metal or flexible metal).
  - The number of elbows used.
  - Type of hood

Recommended hood styles are shown here.

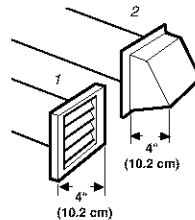

1. Louvered hood style
2. Box hood style

ENGLISH

The angled hood style (shown following) is acceptable.

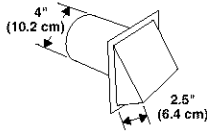

See the exhaust vent length chart that matches your hood type for the maximum vent lengths you can use.

Exhaust systems longer than specified will:

- Shorten the life of the dryer.
- Reduce performance, resulting in longer drying times and increased energy usage.

3. Determine the number of elbows you will need.

**NOTE:** Do not use vent runs longer than specified in Vent Length Chart.

The chart below helps you determine your maximum vent length based on the number of 90° turns or elbows you will need and the type of vent (rigid or flexible metal) and hood that you will use.

#### Vent Length Chart

Number of 90° turns or elbows	Type of vent	Box or Louvered hoods	Angled hoods
0	Rigid metal	64 ft (20 m)	58 ft (17.7 m)
	Flexible metal	36 ft (11 m)	28 ft (8.5 m)
1	Rigid metal	54 ft (16.5 m)	48 ft (14.6 m)
	Flexible metal	31 ft (9.4 m)	23 ft (7 m)
2	Rigid metal	44 ft (13.4 m)	38 ft (11.6 m)
	Flexible metal	27 ft (8.2 m)	19 ft (5.8 m)
3	Rigid metal	35 ft (10.7 m)	29 ft (8.8 m)
	Flexible metal	25 ft (7.6 m)	17 ft (5.2 m)
4	Rigid metal	27 ft (8.2 m)	21 ft (6.4 m)
	Flexible metal	23 ft (7 m)	15 ft (4.6 m)

### Install Vent System

1. (Optional) Put on safety glasses and gloves.
2. Install exhaust hood. Use caulking compound to seal exterior wall opening around exhaust hood.
3. Connect vent to exhaust hood. Vent must fit inside exhaust hood. Secure vent to exhaust hood with 4 in. (10.2 cm) clamp.
4. Run vent to dryer location. Use the straightest path possible. See "Determine Vent Length." Avoid 90° turns. Use duct tape to seal all joints.

### Install Leveling Legs

## ⚠ WARNING

**Excessive Weight Hazard**  
Use two or more people to move and install dryer.  
Failure to do so can result in back or other injury.

1. Place two of the carton corner posts on the floor behind the back of the dryer. See illustration.
2. Firmly grasp the body of the dryer (not the top or console panel).

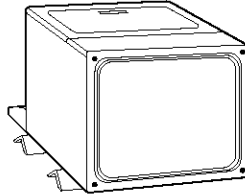

Gently lay the dryer on the cardboard corners.

3. Examine the leveling legs. Find the diamond marking.



4. Screw the legs into the leg holes by hand. Use a wrench to finish turning the legs until the diamond marking is no longer visible.
5. Stand the dryer up. Move it close to its final location. Leave enough room to connect the exhaust vent.

#### For mobile home use

Gas dryers must be securely fastened to the floor.

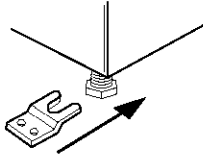

Mobile home installations require a Mobile Home Installation Kit. See "Tools and Parts" section for ordering information.

### Level Dryer

Check the levelness of the dryer. Check levelness first side-to-side, then front-to-back.

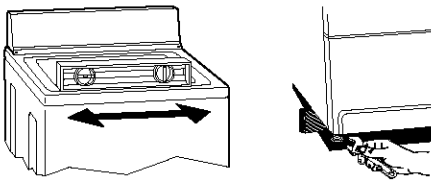

If the dryer is not level, prop up the dryer using a wood block. Use a wrench to adjust the legs up or down and check again for levelness.

**NOTE:** It might be necessary to level the dryer again after it is moved into its final position.

### Make Gas Connection

1. Remove the red cap from the gas pipe. Move the dryer to its final position.
2. Using a wrench to tighten, connect the gas supply to the dryer. Use pipe joint compound on all non-flared male threads. If flexible metal tubing is used, be sure there are no kinks.

**NOTE:** For L.P. gas connections, you must use pipe joint compound resistant to the action of L.P. gas. Do not use TEFLON® tape.

A combination of pipe fittings must be used to connect the dryer to the existing gas line. Shown following is a recommended connection. Your connection may be different, according to the supply line type, size, and location.

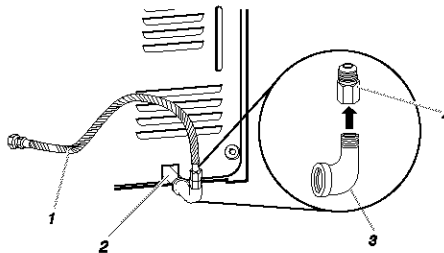

1.  $\frac{3}{8}$  in. flexible gas connector
2.  $\frac{3}{8}$  in. dryer pipe
3.  $\frac{3}{8}$  in. to  $\frac{3}{8}$  in. pipe elbow
4.  $\frac{3}{8}$  in. pipe-to-flare adapter fitting

3. Open the shutoff valve in the supply line. The valve is open when the handle is parallel to the gas pipe.

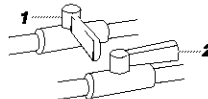

1. Closed valve
2. Open valve

4. Test all connections by brushing on an approved non-corrosive leak-detection solution. Bubbles will show a leak. Correct any leak found.

ENGLISH

---

## Connect Vent

1. Using a 4 in. (10.2 cm) clamp, connect vent to exhaust outlet in dryer. If connecting to existing vent, make sure the vent is clean. The dryer vent must fit over the dryer exhaust outlet and inside the exhaust hood. Make sure the vent is secured to exhaust hood with a 4 in. (10.2 cm) clamp.
2. Move dryer into final position. Do not crush or kink vent. Make sure dryer is level.

---

## Complete Installation

1. Check to be sure all parts are now installed. If there is an extra part, go back through the steps to see which step was skipped.
2. Check to be sure you have all of your tools.
3. Dispose of all packaging materials.
4. Check the dryer's final location. Be sure the vent is not crushed or kinked.
5. Check to be sure the dryer is level. (See "Level Dryer.")
6. Plug into a grounded 3 prong outlet. Turn power on.
7. Remove the blue protective film on the console and any tape remaining on the dryer.
8. Read "Dryer Use."
9. Wipe the dryer drum interior thoroughly with a damp cloth to remove any dust.
10. Set the dryer on a full heat cycle (not an air cycle) for 20 minutes and start the dryer.  
**If the dryer will not start, check the following:**
  - Dryer is plugged into a grounded 3 prong outlet.
  - Electrical supply is connected.
  - House fuse is intact and tight; or circuit breaker has not tripped.
  - Dryer door is closed.
11. When the dryer has been running for 5 minutes, open the dryer door and feel for heat. If you do not feel heat, turn the dryer off and check to see if the gas supply line shutoff valve is open.
  - If the gas supply line shutoff valve is closed, open it, then repeat the 5-minute test as outlined above.
  - If the gas supply line shutoff valve is open, contact a qualified technician.



## DRYER USE

### ⚠ WARNING



#### Explosion Hazard

Keep flammable materials and vapors, such as gasoline, away from dryer.

Do not dry anything that has ever had anything flammable on it (even after washing).

Failure to follow these instructions can result in death, explosion, or fire.

### ⚠ WARNING



#### Fire Hazard

No washer can completely remove oil.

Do not dry anything that has ever had any type of oil on it (including cooking oils).

Items containing foam, rubber, or plastic must be dried on a clothesline or by using an Air Cycle.

Failure to follow these instructions can result in death or fire.

### STARTING YOUR DRYER

To get the best drying results, you must operate your dryer properly. This section gives you this important information.

**NOTE:** The drawings in this section show the basic features of all models covered by this manual. Refer to the supplied "Feature Sheet" for your dryer's particular features.

1. Clean lint screen.
2. Put laundry into dryer and shut door.
3. Set Cycle Selector Control (Timer) **A**, (see "Cycle Descriptions").

4. Set FABRIC/TEMPERATURE Control **B**, (see "Fabric/Temperature Control"). Check clothes label for manufacturer's recommendations.
5. Press PUSH TO START Button **C**. Be sure door is closed.

### STOPPING/RESTARTING YOUR DRYER

- To stop the dryer at any time, open dryer door.
- To restart, press PUSH TO START Button. Be sure door is closed.
- If you wish to end your drying cycle, turn Cycle Selector Control (Timer) to OFF.

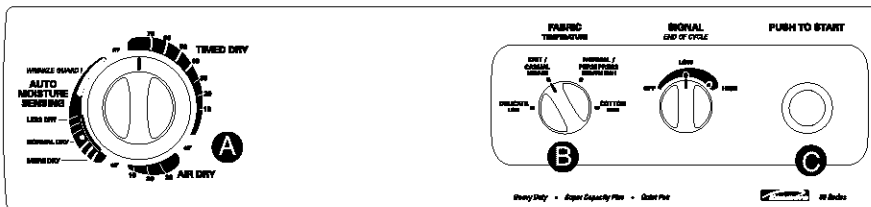

ENGLISH

## CYCLE DESCRIPTION

### for your Benefit

The automatic cycles save you time by providing the best drying results in the shortest time. This can help you save money on utility bills and reduce the risk of fabric damage.

#### Using Automatic Drying Cycles

- Set the Cycle Selector Control (Timer) to **NORMAL DRY(\*)** which is good for most fabrics.
- At the end of the cycle, feel the dried clothes. If they are damp, select **MORE DRY** the next time you do a similar load. If they are overdried, select **LESS DRY** the next time you do a similar load.
- If your dryer has an End of Cycle Signal, it will sound (if selected) once the cycle is completed. Select models feature a non-adjustable End of Cycle Signal.

#### AUTO DRY CYCLE

Use **AUTO DRY** for most loads. Drying time varies according to type of fabric, size of load, and dryness setting.

#### On Dryers with AUTO DRY I

- Dryness is determined by thermostats that react to the amount of moisture in the air exhausted from the dryer. Moist air indicates clothes are still damp. Dry air indicates that moisture has been removed.

**NOTE:** Dryers that do not have a **FABRIC/TEMPERATURE Control** give you a choice of settings for High Heat or Low Heat on the Cycle Selector Control (Timer).

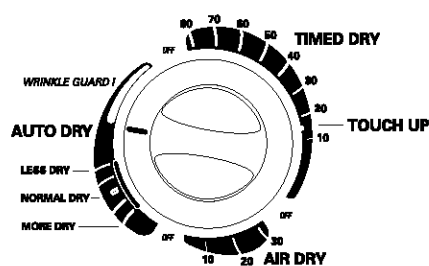

## On Dryers with AUTO MOISTURE SENSING

- Dryness is determined by an electronic sensor that “feels” the amount of moisture in clothes as they pass over it. When the dryness selected is reached, the dryer goes into a 10-minute (approximately) **Cool Down** period.
- If you do not unload the dryer, it goes into **WRINKLE GUARD® I** automatically, if available.

#### TIMED DRY CYCLE

Use this cycle to get up to 60, 70, 80 or 90 minutes (depending on model) of heated drying time.

- The heating cycle is followed by a 10-minute (approximately) **Cool Down** period.
- If your dryer has an End of Cycle Signal, it will sound (if selected) once the cycle is completed. Select models feature a non-adjustable End of Cycle Signal.

#### TOUCH UP CYCLE

Use this cycle to smooth synthetic and permanent press clothes that are clean but wrinkled from being crowded in a closet or suitcase.

- This setting provides about 15 minutes of heated drying time followed by a 10-minute (approximately) **Cool Down** period.
- If your dryer has an End of Cycle Signal, it will sound (if selected) once the cycle is completed. Select models feature a non-adjustable End of Cycle Signal.
- Remove clothes immediately when tumbling stops.

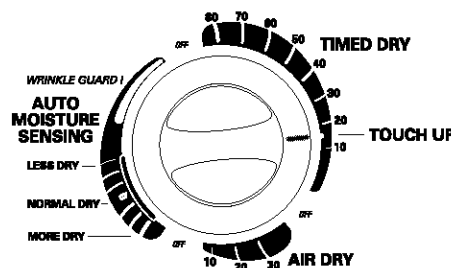

## FABRIC/TEMPERATURE CONTROL

### for your Benefit

Proper use of this control helps ensure that fabrics are dried at the right temperature for maximum life.

Use this control to select the drying temperature that matches the fabrics in your load.

- Select LOW for delicate fabrics. Select HIGH for durable fabrics such as sturdy work clothes or bath towels.
- The FABRIC/TEMPERATURE Control will not work when the Cycle Selector Control (Timer) is in the AIR DRY Cycle.

### FABRIC TEMPERATURE

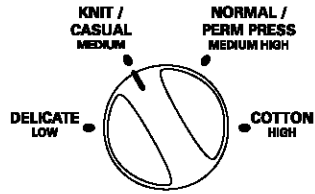

The following table lists suggested dryer settings and drying times for various loads. This is only a guide. Settings may require adjustment depending on the requirements of your load.

Type of Load	Automatic Setting	Drying Temp	TIMED DRY Setting**
<b>COTTONS AND LINENS</b>			
Extra Heavy – Bedspreads, mattress pads, quilts	MORE DRY	HIGH	70-80 min.
Heavyweight – Towels, jeans, corduroys, work clothes	MORE DRY	HIGH	50-60 min.
Medium Weight – Sheets, cotton underwear, diapers	NORMAL DRY	MEDIUM/HIGH or MEDIUM*	40-50 min.
Lightweight – Batistes, organdies, lingerie	NORMAL DRY	LOW	30-40 min.
<b>PERMANENT PRESS, SYNTHETICS AND BLENDS</b>			
Heavyweight – Work clothes, jackets, raincoats	NORMAL DRY	HIGH	40-50 min.
Medium Weight – Shirts, play clothes, sheets, slacks	NORMAL DRY	MEDIUM/HIGH or MEDIUM*	30-40 min.
Lightweight – Lingerie, blouses, dresses	LESS DRY	MEDIUM or LOW*	20-30 min.
<b>KNITS</b>			
Heavyweight – Cottons, rayons, blends, T-shirts, slacks, shirts	NORMAL DRY	HIGH	40-50 min.
Medium Weight – Synthetics (polyester, acrylic, etc.), dress slacks, skirts, sweaters	NORMAL DRY	MEDIUM/HIGH or MEDIUM*	30-40 min.
Lightweight – Synthetics (polyester, acrylic, etc.) and blends, lingerie, blouses, dresses	LESS DRY	LOW	20-30 min.

ENGLISH

\*Use the lowest temperature setting available on your dryer.

\*\*Reset time, as needed, to allow items to dry completely.

**USING AIR DRY/AIR FLUFF**

**for your Benefit**

Using these cycles gives you all the benefits of hang drying with a shorter drying time.

Use the AIR DRY Cycle to get up to 30 minutes of drying time in room temperature air. Use this setting for items that will not tolerate heat such as plastics, rubber, and heat sensitive fabrics. Also use for airing and fluffing items such as pillows.

The AIR FLUFF Setting operates exactly like the AIR DRY Cycle. This setting is available on models that do not have an AIR DRY Cycle in the Cycle Selector Control (Timer).

**To use AIR FLUFF:**

- Set Cycle Selector Control for the number of minutes you want in the TIMED DRY Cycle.
- Set FABRIC/Temperature Control to AIR FLUFF.
- Set other options, press PUSH TO START Button.

Refer to the following chart for examples of items that require drying without heat. Use the AIR DRY Cycle or AIR FLUFF Setting (depending on model), or place the items on a line or rack to air dry.

**OR**

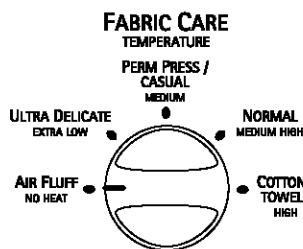
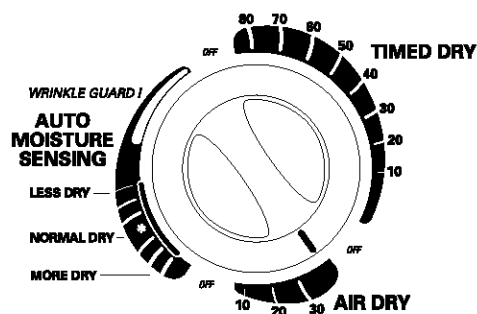

Type of Load	AIR DRY Cycle/ AIR FLUFF Setting
<b>DELICATE FABRICS</b> Sheer curtains (2 or 3 panels), gauze, lace, etc. (Use AIR DRY/AIR FLUFF if low heat is not available.)	20-30 min.
<b>RUBBER, PLASTIC, HEAT-SENSITIVE FABRICS</b> Foam rubber – Pillows, padded bras, stuffed toys <ul style="list-style-type: none"> <li>• Make sure coverings are securely stitched.</li> <li>• Shake and fluff pillows by hand several times during the cycle.</li> <li>• Make sure pillows are completely dry. Foam rubber pillows take a long time to dry.*</li> </ul> Plastic – Shower curtains, tablecloths Rubber-backed rugs Olefin, Polypropylene, Sheer nylon	20-30 min.  20-30 min. 40-50 min. 10-20 min.

\*Reset time, as needed, to allow these items to dry completely.

## END OF CYCLE SIGNAL CONTROL

### **for your Benefit**

Your dryer sounds a signal when a drying cycle is finished.

The signal is helpful when you are drying permanent press, synthetics, and other items. These items should be removed from the dryer as soon as it stops in order to prevent wrinkles.

- On some models, the volume of the signal can be adjusted.

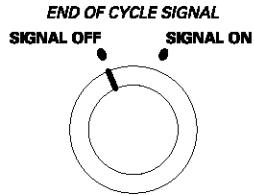

## PUSH TO START BUTTON

Use this control to start the dryer.

Be sure the dryer door is closed.

Opening the door stops the dryer. It will not start again until you close the door and press the PUSH TO START Button. Be sure the Cycle Selector Control (Timer) is still on a dry setting.

## EVENHEAT™ with AUTO MOISTURE PLUS

### **for your Benefit**

EVENHEAT™ with Auto Moisture Sensing Plus is the only system that uses 2 different sensors to “understand” how fast a load is drying, and adjusts time for optimal fabric care.

This cycle uses 2 moisture-sensing strips in the back of the dryer. When the strips no longer “feel” any moisture in the clothes, the dryer automatically turns off to prevent overdrying and shrinking.

## COOL DOWN

Approximately 10 minutes before the end of the AUTO DRY, AUTO MOISTURE SENSING and TIMED DRY Cycles, clothes are tumbled without heat to help reduce wrinkles and make clothes more comfortable to handle.

## USING WRINKLE GUARD®

### **for your Benefit**

WRINKLE GUARD® helps keep your permanent press items wrinkle free when you don't unload the dryer promptly at the end of the automatic cycle.

If you do not open the door at the end of the automatic cycle, WRINKLE GUARD® will tumble the clothes without heat.

- On dryers with WRINKLE GUARD® I, the dryer will tumble the clothes continuously for about 30 minutes unless you open the dryer door.
- On dryers with WRINKLE GUARD® III, periodic tumbling every 15 seconds will continue for about 2½ hours unless you open the dryer door.
- WRINKLE GUARD® III has a selectable ON/OFF Option. When WRINKLE GUARD® III is set at OFF, the dryer stops after Cool Down and may be unloaded.

The End of Cycle Signal will sound after each period of tumbling, unless it is off.

## WRINKLE GUARD III

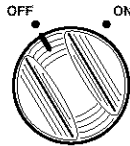

ENGLISH

**DRYER RACK**

On some models, the dryer rack was shipped on top of your dryer. Remove and discard shipping blocks before using.

**for your Benefit**

Use the Dryer Rack for items that you do not want to tumble dry, such as sweaters. When you use the dryer rack, the heated air inside the dryer flows in a concentrated pattern to allow efficient and uniform drying. Use TIMED DRY to select the desired time.

**To use the dryer rack:**

1. Slide rear pegs into the dimples on the back wall of the dryer. Lower the front legs to rest on the dryer opening.

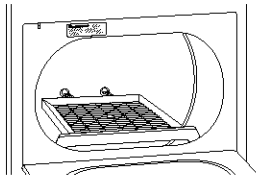

2. Put the wet items on top of the rack. Leave space between the items so air can reach all the surfaces. Close the door.

**NOTE:** Do not allow items to hang over the edge of the rack.

3. Select a timed drying cycle and temperature, or an air cycle. Items containing foam, rubber, or plastic must be dried on a clothesline or by using an air cycle.

4. Push the START button.

**NOTE:** The rack must be removed for normal tumbling. Do not use the automatic cycle with the dryer rack.

This chart shows examples of items that can be rack-dried and the suggested cycle, temperature setting, and drying time. Actual drying time will depend on the amount of moisture items hold

Rack Dry	Cycle	Temp	Time*
<b>Wool Sweaters</b> Block to shape and lay flat on the rack	Timed	Low	60
<b>Stuffed toys or pillows</b> Cotton or polyester fiber filled	Timed	Low	60
<b>Stuffed toys or pillows</b> Foam rubber filled	Air (no heat)	None	90
<b>Sneakers or canvas shoes</b>	Air (no heat)	None	90

\*(Minutes). Reset cycle to complete drying, if needed.

## LAUNDRY TIPS

### PREPARING CLOTHES FOR DRYING

#### *for your* **Benefit**

Follow these recommendations to help save on your utility bills and prolong the life of your garments.

- Refer to your Washer Owner's Manual for proper washing techniques and additional laundry tips.

### DRYING TIPS

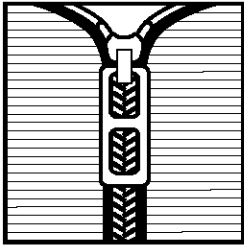

- Close zippers, snaps, and hooks to avoid snagging other items. Remove heat-sensitive trim that can be damaged by drying. Tie strings and sashes so they will not tangle.
- Check garments for spots and stains left after washing. Do not tumble these items. Heat may permanently set stains.
- Check pockets before drying. Sharp or metal objects can damage your dryer. Do not lay these objects on your dryer, they can damage the finish. Turn pockets of heavy items inside out for even drying.
- Place small items such as baby socks or hankies in laundry bag for easy removal.
- Articles to be ironed should be removed while still damp.

### SORTING CLOTHES

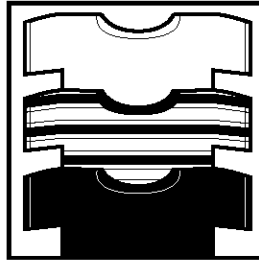

- Separate dark colors from light colors, colorfast from non-colorfast. Items properly sorted by color for washing are usually properly sorted for drying.
- Separate heavy fabrics (denim, towels) from light fabrics (synthetics, permanent press).
- Separate lint givers (towels, chenille) from lint takers (corduroy, synthetics, permanent press). When possible, turn lint takers inside out.

ENGLISH

**CHOOSING LOAD SIZES**

- Mix large items with small items. Load the dryer by the amount of space items take up, not by their weight. Do not overload the dryer. Overcrowding causes uneven drying and wrinkling, and can cause items to wear out faster (because of pilling).
- You may need to rearrange large items (sheets, blankets, tablecloths) during a cycle to reduce balling or rolling up.
- For better tumbling action, when drying only a few small items, add one or two lint-free towels. This also prevents small lightweight items from blocking airflow.

SUPER CAPACITY DRYERS		
Heavy Work Clothes	Towels	Mixed Load
4 jeans	10 bath towels	3 sheets
4 workpants	10 hand towels	(1 king, 2 twin)
4 workshirts	14 wash cloths	4 pillowcases
2 sweatshirts		3 shirts
2 sweatpants		3 blouses
		9 T-shirts
		9 shorts
		10 handkerchiefs

**USING DRYER FABRIC SOFTENERS**

Dryer fabric softeners are recommended for reducing static cling. Always follow package instructions carefully.

- Put one fabric softener sheet on top of the load before starting the dryer. Do not add a fabric softener sheet after the drying cycle has started. Instant heat can cause the fabric softener to spot fabrics.
- Remove fabric softener stains by wetting the stains and rubbing them with liquid detergent or bar soap and rewash.
- Some fabric softeners can clog the lint screen and slow drying. Use fabric softeners labeled as dryer safe.

**SAVING ENERGY**

- Sort load by fabric weight and type.
- Use the preset cycle settings to dry most loads.
- Dry full loads when possible. Do not overdry.
- Avoid overloading dryer, adding wet items to a partly dried load, or opening the door unnecessarily.
- Shorten drying times by exhausting dryer properly and cleaning exhaust vent and outside exhaust hood as needed.
- Keep the lint screen clean.
- Use dryer where room air temperature is above 45°F (7°C).



## DRYER CARE

### CLEANING YOUR DRYER

#### *for your* **Benefit**

Proper care of your dryer can extend its life and help you avoid costly service calls.

### **⚠ WARNING**



**Explosion Hazard**  
**Use nonflammable cleaner.**  
**Failure to do so can result in death, explosion, or fire.**

#### To clean dryer drum:

1. Make a paste with detergent and very warm water and apply to a soft cloth.
2. Scrub area until all excess dye is removed.
3. Wipe thoroughly with a damp cloth.
4. Tumble a load of clean towels for 20 minutes to dry.

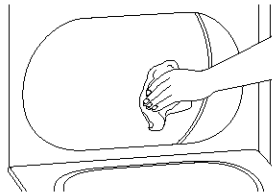

**NOTE:** Garments that contain unstable dyes, such as denim blue jeans or brightly colored cotton items, may discolor the drum interior. These stains are not harmful to your dryer and will not stain future loads of clothes. It is helpful to dry unstable dye items inside out to prevent dye transfer.

**ENGLISH**

## CLEANING THE LINT SCREEN

### Remove Lint Before Every Load

The lint screen is located on top of your dryer. Remove lint before starting every load. A screen blocked by lint can increase drying time.

#### To clean:

1. Pull out lint screen.

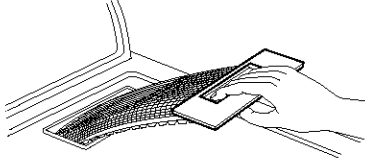

2. Roll lint off the screen with your fingers. Do not rinse or wash screen to remove lint. Wet lint is hard to remove.

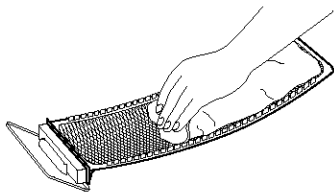

3. Push the lint screen firmly back into place.

#### IMPORTANT:

- Do not run the dryer with the lint screen loose, damaged, blocked, or missing. Doing so can cause overheating and damage to both the dryer and fabrics.
- Some towels made of synthetic fibers and natural fibers (polyester and cotton blends) may shed more lint than other towels, causing your dryer's lint screen to fill up faster. Be sure to remove lint from the lint screen before and after drying new towels.

### Wash Lint Screen As Needed

Laundry detergents and fabric softeners can cause a residue buildup on the lint screen. Wash the lint screen with a nylon brush if it becomes clogged due to a residue buildup.

#### To wash:

1. Wet both sides of lint screen with hot water.
2. Wet a nylon brush with hot water and liquid detergent; scrub lint screen with the brush to remove residue buildup.

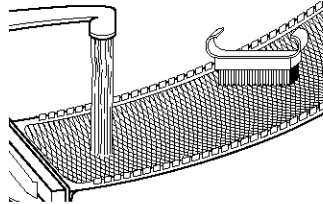

3. Rinse lint screen with hot water.
4. Thoroughly dry lint screen with a clean towel; replace in dryer.

## REMOVING ACCUMULATED LINT

### From Inside the Dryer Cabinet

Lint should be removed every 2 years or more often, depending on dryer usage. Cleaning should be done by a qualified person.

### From the Exhaust Vent

Lint should be removed every 2 years or more often, depending on dryer usage.

## MOVING CARE

- Disconnect power.
- Close shut-off valve in gas supply line.
- Disconnect gas supply line pipe and remove fittings attached to dryer pipe.
- Cap the open fuel supply line.
- Make sure leveling legs are secure in dryer base.
- Use masking tape to secure dryer door.

## VACATION CARE

- Disconnect power.
- Close shut-off valve in gas supply line.
- Wash lint screen.

## TO CHANGE DRUM LIGHT

The dryer light automatically turns on inside the dryer drum when you open the door.

1. Unplug dryer or disconnect power.

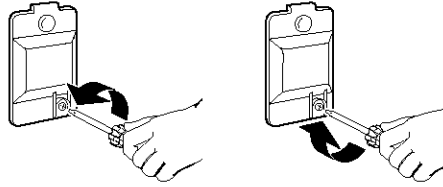

2. Open the dryer door. Locate the light bulb cover on the back wall of the dryer. Remove the screw located in the lower right corner of the cover. Remove the cover.
3. Turn bulb counterclockwise. Replace the bulb with a 10-watt appliance bulb only. Replace the cover and secure with the screw.
4. Plug in dryer or reconnect power.

ENGLISH

## TROUBLESHOOTING

### ***for your Benefit***

Most laundering problems are easily solved if you understand the cause. Using the charts below will save you time and money by helping you avoid unnecessary service calls.

<b>Problem</b>	<b>Possible Cause</b>	<b>Solution</b>
<b>Not Drying Satisfactorily</b>	Lint screen is clogged with lint.	Clean lint screen.
	Restricted air movement. Exhaust vent or outside exhaust hood is clogged with lint.	Run dryer for 5-10 minutes. Hold hand under outside exhaust hood to check air movement. If you do not feel air moving, clean exhaust system of lint or replace exhaust vent with rigid metal or flexible metal vent (see "Installation Instructions").
	Exhaust vent is crushed or kinked.	Replace with rigid metal or flexible metal vent (see "Installation Instructions").
	Gas valve on supply line is closed.	Open all valves.
	Timer or the temperature control is set on AIR DRY or AIR FLUFF.	Select the right cycle for the types of garments being dried (see "Dryer Use").
	Load not contacting the sensor strips and automatic cycle ending early.	Level dryer (see "Installation Instructions").
	Fabric softener sheets blocking outlet grill.	Use only one softener sheet per load and only use it once.
	Dryer located in room with temperature below 45°F (7°C).	Proper operation of dryer cycles requires temperatures above 45°F (7°C).
	Large amount of moisture in the load.	Expect longer dry times with items that hold more moisture (cottons).
	Cold rinse water used.	Expect longer dry times, but you are saving energy and reducing wrinkles.
Load too large and bulky to dry quickly.	Separate load to tumble freely.	
<b>Dryer Will Not Run</b>	Power cord not firmly plugged in.	Plug into a grounded 3 prong outlet.
	Fuse blown or circuit breaker tripped.	Replace fuse or reset breakers.

<b>Problem</b>	<b>Possible Cause</b>	<b>Solution</b>
<b>Dryer Will Not Run (cont'd)</b>	Using a regular fuse.	Replace with a time-delay fuse.
	Dryer door not firmly closed.	Close dryer door tightly.
	PUSH TO START Button not firmly pressed.	Press PUSH TO START Button again.
	Controls not set in an ON position.	Reset controls in an ON position.
<b>Lint in Load</b>	Lint screen is clogged.	Clean lint screen. Check for air movement.
	Improper sorting.	Sort lint givers from lint takers and by color.
	Load is too big or heavy.	Dry smaller loads so lint can be carried to the lint screen.
	Load is overdried.	Use correct dryer settings for fabric. Overdrying can cause lint-attracting static (see "Dryer Use").
	Paper or tissue in pockets.	Clean out pockets before drying.
	Pilling being mistaken for lint.	Pilling (surface fuzz) is caused by normal wear and laundering.
<b>Stains on Load</b>	Improper use of fabric softener in washer.	Use fabric softener sheets in dryer. Add at beginning of cycle when load is cold.
	Drying soiled items.	Items need to be clean before being dried.
<b>Items Shrinking</b>	Overdrying.	Match dryer settings to fabric type (see "Dryer Use").
	Poor garment quality.	Check quality of garment before purchasing.
	Manufacturer's care label instructions not followed.	Follow fabric care label instructions carefully.
<b>Loads are Wrinkled</b>	Overloading.	Dry smaller loads that can tumble freely.
	Overdrying.	Match dryer settings to fabric type (see "Dryer Use").
	Load left in dryer at the end of cycle.	Remove load as soon as tumbling stops.
<b>Odors</b>	Painting, staining or varnishing has recently taken place in the area where your dryer is located.	Ventilate the area. When the odors or fumes are gone from the area, rewash the clothing and then dry it.
	Gas Leak	Turn off gas supply line. Leave your house, then call your local gas company.
<b>Unusual Sounds</b>	Clicking (Gas Dryers) – gas valve clicking.	Normal operation.
	Thumping of rollers when dryer has had a period of non-use.	Thump will go away after 5 minutes of drying.

## WE SERVICE WHAT WE SELL

Your purchase has added value because you can depend on Sears HomeCentral® for service. With over 12,000 trained repair specialists and access to over 4.2 million parts and accessories, we have the tools, parts, knowledge and skills to ensure our pledge: We Service What We Sell.

### **Sears Maintenance Agreements**

Your Kenmore appliance is designed, manufactured and tested to provide years of dependable operation. Yet any major appliance may require service from time to time. The Sears Maintenance Agreement offers you an outstanding service program, affordably priced.

### **Sears Maintenance Agreements**

- Is your way to buy tomorrow's service at today's prices.
- Eliminates repair bills resulting from normal wear and tear.
- Provides for non-technical and instructional assistance.
- Even if you don't need repairs, provides an annual Preventive Maintenance Check, at your request, to ensure that your appliance is in proper running condition.

**Some limitations apply. For more information, call 1-800-827-6655.**

# Get it fixed, at your home or ours!

For repair of major brand appliances in **your own home...**  
no matter who made it, no matter who sold it!

**1-800-4-MY-HOME®** Anytime, day or night  
(1-800-469-4663) (U.S.A. and Canada)  
[www.sears.com](http://www.sears.com) [www.sears.ca](http://www.sears.ca)

For repair of carry-in products like vacuums, lawn equipment,  
and electronics, call for the location of your nearest  
**Sears Parts and Repair Center.**

**1-800-488-1222** Anytime, day or night (U.S.A. only)  
[www.sears.com](http://www.sears.com)

For the replacement parts, accessories and owner's manuals  
that you need to do-it-yourself, call **Sears PartsDirect<sup>SM</sup>**!

**1-800-366-PART** 6 a.m. – 11 p.m. CST, 7 days a week  
(1-800-366-7278) (U.S.A. only)  
[www.sears.com/partsdirect](http://www.sears.com/partsdirect)

To purchase or inquire about a Sears Service Agreement  
or Sears Maintenance Agreement:

**1-800-827-6655** (U.S.A.)  
7 a.m. – 5 p.m. CST, Mon. – Sat.

**1-800-361-6665** (Canada)  
9 a.m. – 8 p.m. EST, M – F, 4 p.m. Sat.

Para pedir servicio de reparación a  
domicilio, y para ordenar piezas:

**1-888-SU-HOGAR<sup>SM</sup>**  
(1-888-784-6427)

Au Canada pour service en français:

**1-800-LE-FOYER<sup>MC</sup>**  
(1-800-533-6937)  
[www.sears.ca](http://www.sears.ca)

