

Use & Care Guide
Guía de uso y cuidada
English / Español

Model/Modelos: 790.9507*

Kenmore Elite®

Induction Range

Estufa de induccion

* = color number, número de color

P/N 316902025 Rev C

Sears Brands Management Corporation
Hoffman Estates, IL 60179 U.S.A.

www.kenmore.com
www.sears.com



Table of Contents

Kenmore Elite Warranty	2	Oven Controls	16
Before Setting Surface Controls	9	Warmer Drawer (some models)	28
Induction Cooking Zones.....	11	Self Clean	31
Setting Surface Controls.....	13	Care & Cleaning	34
Before Setting Oven Controls	15	Before You Call	38
Oven Vent Location	15	Oven Baking	38
		Solutions to Common Problems	39

Kenmore Elite Warranty

When this appliance is installed, operated and maintained according to all supplied instructions, the following warranty coverage applies. To arrange for warranty service, call 1-800-4-MY-HOME® (1-800-469-4663).

U.S.A. Warranty Coverage

- One Year Limited Warranty on Appliance
For one year from the date of purchase, free repair will be provided if this appliance fails due to a defect in material or workmanship.
- Two Year Limited Warranty on Ceramic Cooktop (if equipped)
For two years from the date of purchase, if a ceramic cooktop fails due to thermal shock, or a ceramic cooktop element is defective, a free replacement part will be supplied. After the first year from purchase date, you are responsible for the labor cost of part installation.

All warranty coverage applies for only 90 days from the date of purchase if this appliance is ever used for other than private family purposes.

Canada Warranty Coverage

- Two Year Limited Warranty on Appliance
For two years from the date of purchase, free repair will be provided if any non-consumable part of this appliance fails due to defects in material or workmanship. If the appliance is ever used for other than private family purposes, this coverage applies for only 90 days from the purchase date. For information concerning possible additional coverage, call 1-800-4-MY-HOME®.

This warranty covers **ONLY** defects in material and workmanship, and will **NOT** pay for:

1. Cracks in a ceramic glass cooktop that are not a result of thermal shock.
2. Stains and scratches on a ceramic glass cooktop resulting from failure to maintain it properly according to all instructions supplied with the product.
3. Consumable items that can wear out from normal use, including but not limited to filters, belts, incandescent light bulbs, and bags.
4. A service technician to instruct the user in correct product installation, operation or maintenance.
5. A service technician to clean or maintain this product.
6. Damage to or failure of this product if it is not installed, operated or maintained according to all instructions supplied with the product.
7. Damage to or failure of this product resulting from accident, abuse, misuse or use for other than its intended purpose.
8. Damage to or failure of this product caused by the use of detergents, cleaners, chemicals or utensils other than those recommended in all instructions supplied with the product.
9. Damage to or failure of parts or systems resulting from unauthorized modifications made to this product.

Disclaimer of implied warranties; limitation of remedies

Customer's sole and exclusive remedy under this limited warranty shall be product repair as provided herein. Implied warranties, including warranties of merchantability or fitness for a particular purpose, are limited to one year in the U.S., or two years in Canada, or the shortest period allowed by law. Sears shall not be liable for incidental or consequential damages. Some states and provinces do not allow the exclusion or limitation of incidental or consequential damages, or limitation on the duration of implied warranties of merchantability or fitness, so these exclusions or limitations may not apply to you.

This warranty applies only while this appliance is used in the United States and Canada.*

This warranty gives you specific legal rights, and you may also have other rights which vary from state to state and province to province.

* In-home repair service is not available in all Canadian geographical areas, nor will this warranty cover user or servicer travel and transportation expenses if this product is located in a remote area (as defined by Sears Canada Inc.) where an authorized servicer is not available.

Sears Brands Management Corporation, Hoffman Estates, IL 60179

Sears Canada Inc., Toronto, Ontario, Canada M5B 2C3

IMPORTANT SAFETY INSTRUCTIONS

Read all instructions before using this appliance.

Read all instructions before using this appliance.

This manual contains important safety symbols and instructions. Pay attention to these symbols and follow all instructions given.

Do not attempt to install or operate your appliance until you have read the safety precautions in this manual. Safety items throughout this manual are labeled with a WARNING or CAUTION statement based on the hazard type.

DEFINITIONS

⚠ This is the safety alert symbol. It is used to alert you to potential personal injury hazards. Obey all safety messages that follow this symbol to avoid possible injury or death.

⚠ WARNING - Indicates a potentially hazardous situation which, if not avoided, may result in death or serious injury.

⚠ CAUTION - Indicates a potentially hazardous situation which, if not avoided, may result in minor or moderate injury.

Important: Indicates installation, operation, maintenance, or valuable information that is not hazard related.

⚠ WARNING Stepping, leaning, or sitting on the door or drawers of a range can result in serious injuries and also cause damage to the appliance. Do not allow children to climb or play around the range. The weight of a child on an open over door may cause the range to tip, resulting in serious burns or other injury.

⚠ CAUTION Do not heat unopened food containers. Build-up of pressure may cause container to burst and result in injury.

⚠ WARNING

Tip Over Hazard

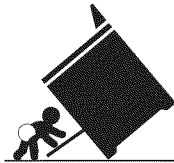

- A child or adult can tip the range and be killed.
- Verify the anti-tip device has been installed to floor or wall.
- Ensure the anti-tip device is re-engaged to floor or wall when the range is moved.
- Do not operate the range without the anti-tip device in place and engaged.
- Failure to follow these instructions can result in death or serious burns to children and adults.



Range

leveling leg

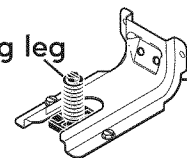

Anti-tip
bracket

To check if the anti-tip bracket is installed properly, use both arms and grasp the rear edge of the range back. Carefully attempt to tilt range forward. When properly installed, the range should not tilt forward.

Refer to the anti-tip bracket installation instructions supplied with your range for proper installation.

⚠ WARNING Do Not Leave Children Alone - Children should not be left alone or unattended in the area where appliance is in use. They should never be allowed to sit or stand on any part of the appliance, including the storage drawer, lower broiler drawer, warmer drawer, or lower double oven.

⚠ CAUTION Do not store items of interest to children in the cabinets above a range or on the backguard of the range. Children climbing on the range to reach items could be seriously injured.

IMPORTANT SAFETY INSTRUCTIONS

Read all instructions before using this appliance.

⚠ CAUTION Persons with a pacemaker or similar medical device should exercise caution using or standing near an induction unit while it is in operation, as the electromagnetic field may affect the working of the pacemaker or similar medical device. It would be advisable to consult your Doctor or the pacemaker or similar medical device manufacturer about your particular situation.

This appliance has been tested and found to comply with the limits for a class B digital device, pursuant to Part 18 of the FCC rules. These limits are designed to provide reasonable protection against harmful interference in a residential installation. This unit generates, uses and can radiate radio frequency energy and, if not installed and used in accordance with the instructions, may cause harmful interference to radio communications. However there is no guarantee that interference will not occur in a particular installation. If this unit does cause harmful interference to radio or television reception, which can be determined by turning the unit off and on, the user is encouraged to try to correct the interference by one or more of the following measures:

- Reorient or relocate the receiving antennae.
- Increase the distance between the unit and receiver.
- Connect the unit into an outlet or a circuit different from that to which the receiver is connected.

Important: Important Safety Notice - The California Safe Drinking Water and Toxic Enforcement Act requires the governor of California to publish a list of substances known to cause cancer, birth defects, or other reproductive harms, and it requires businesses to warn customers of potential exposures to such substances.

⚠ WARNING Never cover any slots, holes, or passages in the oven bottom or cover an entire oven rack with materials, such as aluminum foil. Aluminum foil linings may trap heat, causing a fire hazard.

⚠ CAUTION Wear proper apparel. Loose-fitting or hanging garments should never be worn while using this appliance. Do not let clothing or other flammable materials come into contact with hot surfaces.

⚠ CAUTION When heating fat or grease, watch it closely. Grease may catch fire if it becomes too hot.

⚠ CAUTION Do not use water or flour on grease fires. Smother fire or flame or use dry chemical or foam-type extinguisher. Cover the fire with a pan lid or use baking soda.

⚠ CAUTION Use dry potholders. Moist or damp potholders on hot surfaces may result in burns from steam. Do not let potholders touch hot cooking areas. Do not use towels or other bulky cloths.

⚠ WARNING Storage In or On Appliance—Flammable materials should not be stored in an oven, near surface units or in the storage drawer, warmer drawer or lower oven. This includes paper, plastic, and cloth items, such as cookbooks, plastic ware, and towels, as well as flammable liquids. Do not store explosives, such as aerosol cans, on or near the oven.

IMPORTANT SAFETY INSTRUCTIONS

Read all instructions before using this appliance.

⚠ CAUTION Read and follow the below instructions and precautions for unpacking, installing, and servicing your appliance:

- Remove all tape and packaging before using the range. Destroy the carton and plastic bags after unpacking the range. Never allow children to play with packaging material.
- Proper Installation—Be sure your appliance is properly installed and grounded by a qualified technician in accordance with the National Electrical Code ANSI/NFPA No. 70 latest edition and local electrical code requirements. Install only per installation instructions provided in the literature package for this range.
- Never modify or alter the construction of a range by removing the leveling legs, panels, wire covers, anti-tip brackets/screws, or any other part of the range.
- User Servicing—Do not repair or replace any part of the appliance unless specifically recommended in the manuals. All other servicing should be done only by a qualified technician. This reduces the risk of personal injury and damage to the range.
- Ask your dealer to recommend a qualified technician and an authorized repair service. Know how to disconnect the power to the oven at the circuit breaker or fuse box in case of an emergency.
- Remove the oven door from any unused range if it is to be stored or discarded.
- Do not attempt to operate the range during a power failure. If the power fails, always turn off the range. If the range is not turned off and the power resumes, the range will begin to operate again. Once the power resumes, reset the clock and oven function.

- Cold temperatures can damage the electronic control. When using this appliance for the first time, or when the appliance has not been used for an extended period of time, be sure the appliance has been in temperatures above 32°F (0°C) for at least 3 hours before turning on the power to the appliance.
- Be sure to have an appropriate foam-type fire extinguisher available, visible, and easily located near the appliance.

IMPORTANT INSTRUCTIONS FOR USING YOUR OVEN

- Never use your appliance for warming or heating the room.
- Use care when opening oven door, lower oven door, or warmer drawer (some models). Stand to the side of the range when opening the door of a hot oven. Let hot air or steam escape before you remove or replace food in the oven.
- Keep oven vent ducts unobstructed. The oven vent is located below the backguard. Touching surfaces in this area when the oven is on may cause severe burns. Do not place plastic or heat-sensitive items on or near the oven vent. These items can melt or ignite.
- Placement of Oven Racks - Always place oven racks in desired location while oven is cool. If rack must be moved while oven is hot, use extreme caution and do not let potholder contact hot heating element in oven. Use potholders and grasp the rack with both hands to reposition. Remove all bakeware and utensils before moving the rack.
- Do not use a broiler pan without its insert. Broiler pans and inserts allow dripping fat to drain away from the high heat of the broiler. Do not cover the broiler insert with aluminum foil; exposed fat and grease could ignite.

Save these instructions for future reference.

IMPORTANT SAFETY INSTRUCTIONS

Read all instructions before using this appliance.

- Protective Liners - Do not use aluminum foil to line surface unit drip bowls or oven bottoms, except as suggested in the manual. Improper installation of these liners may result in a risk of electric shock, or fire.
- Do not cook food on the oven bottom. Always cook in proper bakeware and always use the oven racks.
- Glazed cooking utensils — Only certain types of glass, glass/ceramic, ceramic, earthenware, or other glazed utensils are suitable for cook top service without breaking due to the sudden change in temperature. Check the manufacturer's recommendations for cook top use.
- When flaming foods under a ventilating hood, turn the fan on.

IMPORTANT INSTRUCTIONS FOR USING YOUR COOKTOP

- Know which knob controls each surface heating unit. Place a pan of food on the surface element unit before turning it on, and turn the element off before removing the pan.
- Improper cookware may break due to sudden changes in temperature. Check the cookware manufacturer's recommendations for cooktop use.
- Use proper pan size — This appliance is equipped with induction cooking zones of different sizes. Select utensils specifically manufactured and approved for induction cooking that have flat bottoms that match the induction cooking zone size. Proper relationship of utensil to cooking zone will also improve efficiency.
- Utensil handles should be turned inward and not extend over adjacent surface elements — To reduce the risk of burns, ignition of flammable materials, and spillage due to unintentional contact with the utensil, the handle of the utensil should be positioned so that it is turned inward, and does not extend over adjacent surface units.
- Never leave surface elements unattended at high heat settings — Boilovers cause smoking and greasy spillovers that may ignite, or a pan that has boiled dry may melt.

- Do not use decorative surface burner covers. If an element is accidentally turned on, the decorative cover will become hot and possibly melt. Burns will occur if the hot covers are touched. Damage may also be done to the cooktop.

IMPORTANT INSTRUCTIONS FOR CLEANING YOUR RANGE

⚠ CAUTION Before manually cleaning any part of the range, be sure all controls are turned off and the range is cool. The range may be hot and can cause burns.

- Clean the range regularly to keep all parts free of grease that could catch fire. Pay particular attention to the area around each surface element. Do not allow grease to accumulate.
- Always follow the manufacturer's recommended directions for use of kitchen cleaners and aerosols. Be aware that excess residue from cleaners and aerosols may ignite causing damage and injury.
- Clean ventilating hoods frequently. Grease should not be allowed to accumulate on the hood or filter. Follow the manufacturer's instructions for cleaning hoods.

IMPORTANT SAFETY INSTRUCTIONS

Read all instructions before using this appliance.

IMPORTANT INSTRUCTIONS FOR CLEANING YOUR SELF-CLEANING OVENS

- Clean only the parts listed in this manual. Before using self-clean, remove the broiler pan, any food, utensils, and bakeware from the oven. Remove oven racks unless otherwise instructed.
- Do Not Use Oven Cleaners. No commercial oven cleaner or oven liner protective coating of any kind should be used in or around any part of the oven.
- Do Not Clean Door Gasket. The door gasket is essential for a good seal. Care should be taken not to rub, damage, or move the gasket.
- Some birds are extremely sensitive to the fumes given off during the self-clean cycle of any oven. Move birds to another well-ventilated room.

IMPORTANT INSTRUCTIONS FOR CERAMIC-GLASS COOKTOP MODELS

- Do not cook on broken cook top — If cook top should break, cleaning solutions and spillovers may penetrate the broken cook top and create a risk of electric shock. Contact a qualified technician immediately.
- Clean cook top with caution — If a wet sponge or cloth is used to wipe spills on a hot cooking area, be careful to avoid a steam burn. Some cleaners can produce noxious fumes if applied to a hot surface.

⚠ CAUTION DO NOT TOUCH SURFACE HEATING UNITS, OR SURFACE COOKING ELEMENTS, AREAS NEAR THESE SURFACE HEATING UNITS, OR INTERIOR SURFACE OF THE OVEN. Both surface heating and oven heating elements may be hot even though they are dark in color. Areas near surface cooking units may become hot enough to cause burns. During and after use, do not touch, or let clothing or other flammable materials touch these areas until they have had sufficient time to cool. Among these areas are the cook top, surfaces facing the cook top, the oven vent openings and surfaces near these openings, oven door and oven door window.

GROUNDING INSTRUCTIONS

⚠ WARNING Avoid fire hazard or electrical shock. Failure to follow this warning may cause serious injury, fire, or death.

For personal safety, this appliance must be properly grounded. For maximum safety, the power cord must be plugged into an electrical outlet that is the correct voltage, is correctly polarized and properly grounded in accordance with local codes. It is the personal responsibility of the consumer to have the appropriate outlet with the correct, properly grounded wall receptacle installed by a qualified electrician. It is the responsibility and obligation of the consumer to contact a qualified installer to assure that the electrical installation is adequate and is in conformance with all local codes and ordinances.

See the installation instructions packaged with this appliance for complete installation and grounding instructions.

IMPORTANT SAFETY INSTRUCTIONS

Read all instructions before using this appliance.

PRODUCT RECORD

In this space below, record the date of purchase, model and serial number of your product. You will find the model and serial number printed on an identification plate. See Figure 1 for serial plate location.

Model No. _____

Serial No. _____

Date of Purchase _____

Save sales receipt for future reference.

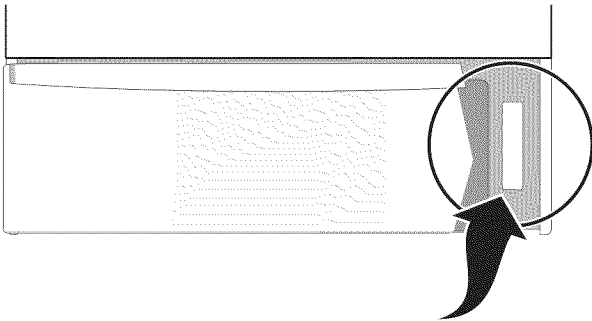

Figure 1: Serial plate location

To locate the serial plate, open storage drawer (some models) or warmer drawer (some models). The serial plate is attached to the lower right oven frame.

Before Setting Surface Controls

Benefits of Induction Surface Cooking

Fast and efficient - The induction cooking zones heat faster while using less energy. Induction power levels are quick to boil and efficient when simmering.

A cooler cooktop - A unique feature of the induction cooking zones is whether turned on or off, the cooking zones remain cooler than radiant type elements. Virtually no wasted heat is produced because the heat begins with the presence of cookware.

Easy cleanups - The cooler cooking zones make cleanup easier. Spills resist sticking or burning, so they wipe up easily.

Magnetic detector - The cooking zone has a sensor that automatically detects whether or not cookware is magnetic. This will reduce accidental turn-ons.

Pan size detection - The pan size recognition sensor automatically detects and adapts the induction cooking zones to the pan sizes in use for consistent, more even cooking.

More responsive - The induction cooking zones are more responsive than their electric or gas counterparts because the pan is what heats. This type of cooking heats easier and will be just as responsive when reducing to a simmer.

About the Induction Cooktop

The cooktop is equipped with four differently-sized induction cooking zones and a radiant heat warm zone.

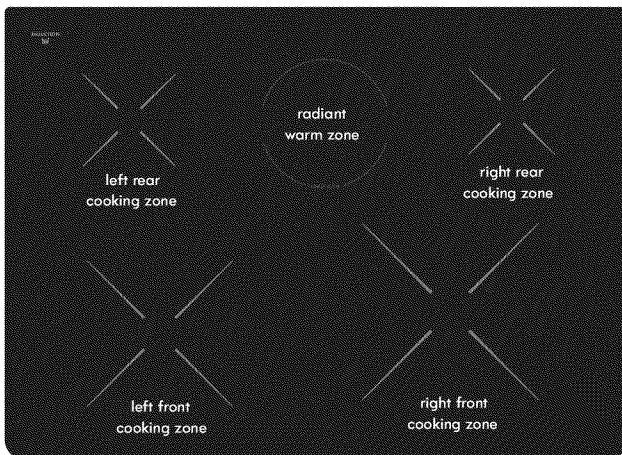

Figure 2: Induction cooking zones

Induction cooking heats the pan directly, and heating will only begin when cookware is properly placed on the cooking zones.

Induction Cookware

Important note:

Before using the induction cooking zones, be sure to carefully read and follow these cookware recommendations and the instructions in the pan sensing section.

Induction cooktops allow the flexibility to use a wide range of cookware. Induction cooking only requires the cookware to be magnetic. Induction-specific cookware may be purchased.

The cooking zones will not activate if the cookware is not constructed with a base magnetic material. To check if the cookware base material is suitable, use a magnet to test (See Figure 3). If a magnet sticks to the bottom of the cookware, the material type is correct.

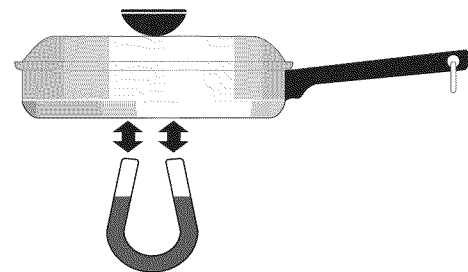

Figure 3: Cookware verification

For best results, only use high quality heavy gauge cookware on the induction cooking zones. Follow all the manufacturer's recommendations when using cookware made for induction cooking.

Induction Cookware Types

The most common induction cookware types available are:

Stainless steel - Generally, excellent for induction cooking. Is durable, easy to clean, and resists staining. Not all stainless steel cookware is magnetic. Check before purchase or use.

Cast iron - Good for induction cooking. Cooks evenly. Do not slide cast iron cookware on cooktop. Cast iron cookware with a rough bottom will scratch a ceramic cooktop

Porcelain-enameled metal - Heating characteristics vary depending on quality of base material. Porcelain-enamel coating must be smooth to avoid scratching ceramic cooktop. Test with a magnet before purchase or use.

Before Setting Surface Controls

When Using the Cooking Zones

- Be sure to use cooktop cookware made with a magnetic base material.
- Use quality cooktop cookware with heavier bottoms for better heat distribution.
- Cookware should have flat bottoms that make good contact with the entire cooking zone area. Check for flatness by rotating a ruler across the bottom of the cookware (See Figure 4).

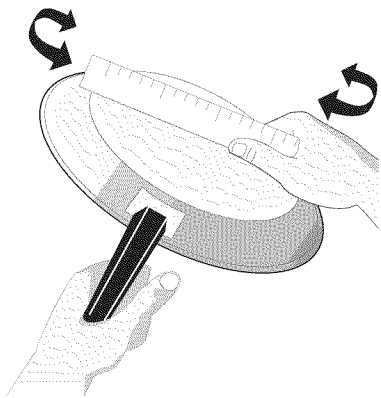

Figure 4: Check for level-bottomed cookware

- Be sure cookware is properly balanced and does not tilt from a heavy handle.
- Be sure that the pan size matches the amount of food to be prepared. The size and type of cookware used will influence the setting needed for best cooking results.
- Never let cookware boil dry. This may cause permanent damage to the cooktop, such as breakage, fusion, or marring.
- Use cookware that meets the minimum and maximum cookware size requirements for each cooking zone.

Hot Cookware and Residual Heat

CAUTION Unlike radiant surface elements, the cooking zones will not glow red when they are hot. The glass surface may be hot from residual heat transferred from the cookware and burns may occur. Do not touch hot cookware or pans directly with hands. Always use oven mitts or pot holders to protect hands from burns.

The type and size of cookware, cooking duration, the number of cooking zones in use, and their power level settings are all factors that will affect the amount of heat that will spread beyond the cooking zones.

The induction cooking zones and areas surrounding the cooking zones may become hot enough to cause burns. Be sure to read all cautions.

Important note:

Some accessories are made to straddle cooking zones. Never place or straddle a cooking utensil over two different surface cooking zones heating at the same time. This will cause uneven heating results and could cause the ceramic cooktop to fracture.

Home Canning

CAUTION Canning can generate large amounts of steam. Use extreme caution to prevent burns. Always raise the lid to vent steam away from you. Safe canning requires that harmful micro-organisms are destroyed and the jars are sealed completely. When canning in a water bath canner, a gentle but steady boil must be maintained continuously for the required time.

Be sure to read and observe all the following points when home canning with your appliance. Check with the United States Department of Agriculture (USDA) website (www.usda.gov) and be sure to read all the information they have available as well as follow their recommendations for home canning procedures.

- Use only quality flat bottom canners when home canning. Use a straight-edge to check canner bottom.
- Use only a completely flat bottom canner with no ridges that radiate from the bottom center when home canning using a range with a ceramic glass cooktop.
- Make sure the diameter of the canner does not exceed 1 inch beyond the cooking zone markings. Use smaller diameter canners on ranges with ceramic glass or open coil electric cooktops.
- Start with hot tap water to boil water quickly.
- Use the highest heat setting when first bringing the water to a boil. Once boiling, reduce heat to lowest possible setting to maintain that boil.
- Use tested recipes and follow instructions carefully. Check with your local Cooperative Agricultural Extension Service or a manufacturer of glass jars for the latest canning information.
- It is best to can small amounts and light loads.
- Do not leave water bath or pressure canners on high heat for an extended amount of time.
- Alternate surface units between each batch to allow the units and surrounding surfaces to cool down. Try to avoid canning on the same burner unit all day.

Induction Cooking Zones

Pan Sensing

The cooking zone sensors located below the cooktop surface require that certain cookware conditions are met before the induction cooking zones can operate.

If a cooking zone is activated and no cookware is detected, the zone display will flash with the last power level setting (See Figure 5). If improper cookware is used, the cooking zones may not heat.

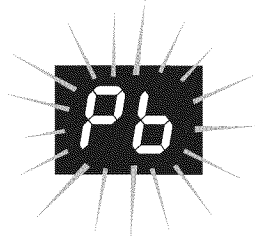

Figure 5: Flashing error message

The conditions that generate a flashing message are illustrated in Figure 6. Use Figure 6 as a guide to help to correct the problem before attempting to reactivate any of the cooking zones.

If the problem or problems are not corrected, the cooking zone will automatically turn off after three minutes.

Important note:

It is recommended that you lower the requested power level setting before correcting the pan sensing message.

Pan Sensing-Induction Cooking Zones

Minimum Pan Size

Induction cooking zones require a minimum pan size in order to activate. The cookware bottom must meet the minimum area for the heating process to begin.

If a pan that is induction-capable is centered properly but is too small, the cooking zone display will flash the last power level setting and the pan will not heat. Select a larger pan that meets the minimum size requirement to activate the cooking zone.

Maximum Recommended Pan Size

The graphics on each cooking zone location are your guides to the correct maximum pan size for that zone (See Figure 7).

It is recommended to not use pans with bottoms that extend more than 1/2" (13 mm) beyond any of the longer line marks provided on the cooktop.

The cookware must make full contact with the ceramic glass surface. Cookware should not rest on or touch the metal edges of the cooktop.

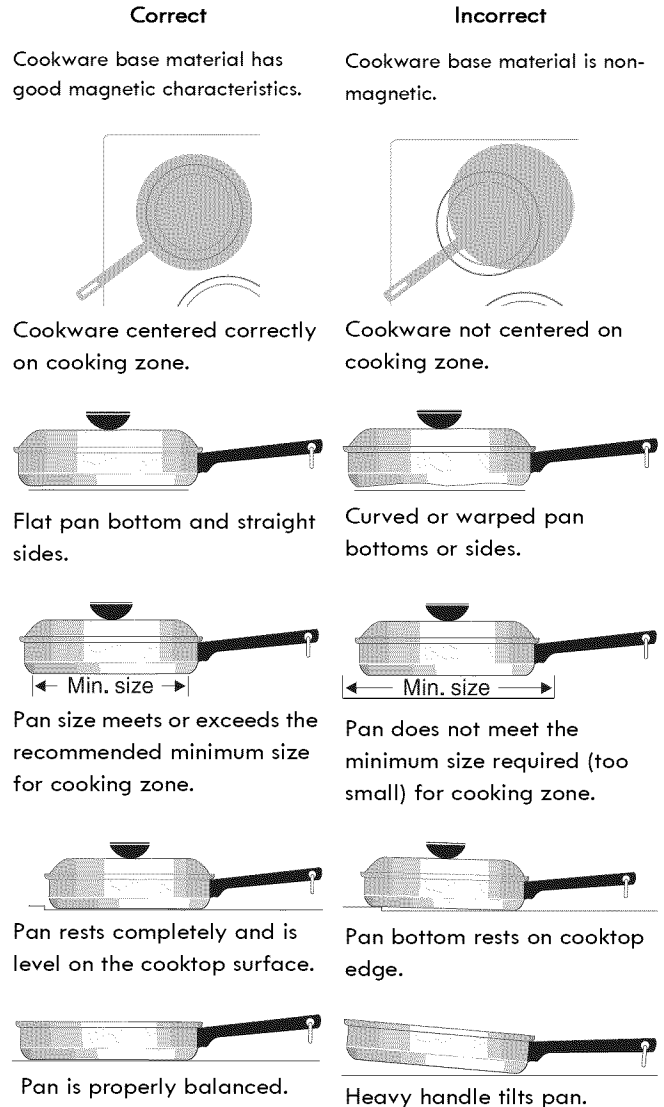

Figure 6: Troubleshooting guide

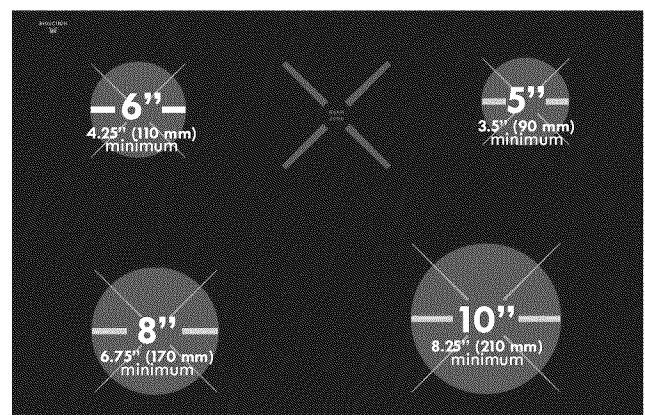

Figure 7: Induction zones minimum pan size requirements

Induction Cooking Zones

Cooktop Display Windows

The range backguard provides a digital window for each of the cooking zones located on the cooktop. Power levels and messages are easily monitored and controlled using the window displays in combination with the corresponding control knobs.

Available Power Level Settings

The cooktop control (Figure 8) will display power levels ranging from Pb (Figure 9), Hi (Figure 13) to Lo (Figure 10).

The settings between 9.5 (Figure 14) and 1.5 (Figure 15) decrease and increase in 0.5 increments.

Use Table 1 to determine the correct power level setting for the type of food you are preparing.

Power Boost Power Level (Pb)

When setting an induction cooking zone for the highest setting (to the POWER BOOST position), the display will initially show Pb (Power Boost) power level for up to 10 minutes. After 10 minutes, the cooking zone will automatically return to the Hi setting (See Figure 13). The Pb setting is only available immediately after activating a cooking zone by turning the knob to the highest setting (to the POWER BOOST position).

Hot Surface Window Message (HE)

After using an induction cooking zone, the cooktop may become very hot. After turning any cooking zone off, the cooktop may remain hot for some time. The corresponding Hot Element (HE) message will remain on until the cooktop has cooled (See Figure 12).

ESEC Error Indicator Message (Er)

An error message will be displayed (flashing Er) (Figure 11) at power up (or after a power failure) if any of the surface control knobs were left in the ON positions. If a power failure should occur, be sure to set all of the four surface control knobs to the OFF position. This will reset the surface controls.

Be sure to reset the clock by referring to the "Setting Clock" heading on page 17. Once the surface controls have been set to the OFF positions and the clock has been set with the correct time of day, the surface controls should return to normal operation. If the surface controls do not function and the Er message remains in any display after following these procedures, contact an authorized servicer for assistance.

Lockout Window Message (- -)

The (- -) message will appear whenever the Lockout, Self-clean or Sabbath feature is active (See Figure 16). Refer to the "Setting Oven Lockout" heading on page 19 for more details.

Important:

The induction cooking zones will not operate when the oven is set for Sabbath mode. For more details on the Sabbath feature, see the "Setting the Sabbath Feature (for use on the Jewish Sabbath and Holidays)" heading on page 26.

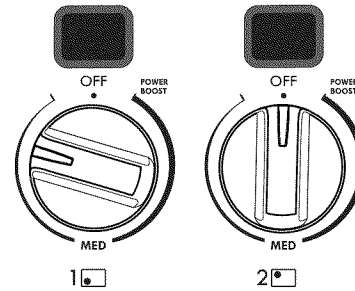

Figure 8: Cooktop control knobs



Figure 9:

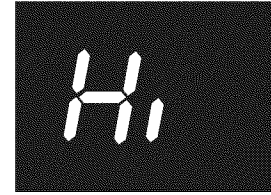

Figure 13:

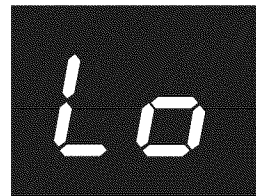

Figure 10:



Figure 14:

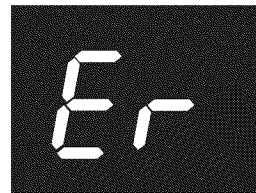

Figure 11:



Figure 15:

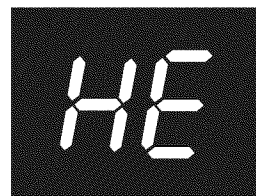

Figure 12:

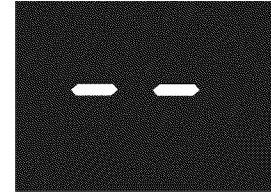

Figure 16:

Setting Surface Controls

Operating Induction Cooking Zones

Start most surface cooking on a higher setting and then adjust to a lower setting to finish cooking.

The suggested settings may vary slightly depending on the cookware design, quality, and amount of food being prepared (See Table 1).

Be sure to use quality cookware that is constructed with magnetic base material and meets the minimum and maximum pan size requirements.

To operate induction cooking zones:

CAUTION Unlike radiant surface elements, induction cooking zones do not glow red. The glass surface may be hot from residual heat transferred from the cookware and burns may occur. Do not touch hot cookware or pans directly with hands. Always use oven mitts or pot holders to handle cookware.

1. Place induction cookware on the desired cooking zone.
2. To activate the cooking zone, push in and turn the control knob in either direction to the desired setting.
3. Adjust the power level by turning the knob. This will decrease or increase the power level. Power levels 9.5 through 1.5 decrease and increase by 0.5 increments. Lo is the lowest power level available.
4. Once cooking is complete, turn the control knob to OFF and remove cookware.

Table 1: Suggested cooking zone power level settings

Settings	Type of cooking
Power boost (Pb)	Use to start heating pans that contain large amounts of food or to bring large pans of water to boil
High (8.0-Hi)	Start most foods, bring water to a boil, pan broiling
Medium high (5.0-8.0)	Continue a rapid boil, fry, deep fat fry
Medium (4.0-5.0)	Maintain a slow boil, thicken sauces and gravies or steam vegetables
Medium Low (2.0-4.0)	Keep foods cooking, poach, stew
Low (Lo - 2.0)	Keep warm, melt, simmer

The suggested power level settings shown in Table 1 are based on cooking with medium sized pans with lids. Be sure to make any further setting adjustments needed for best surface cooking results.

The size and type of utensil used, as well as the amount and type of food being cooked, will influence the setting needed for best cooking results.

CAUTION Do not place flammable items (plastic salt and pepper shakers, spoon holders, plastic wrappings, etc.) on the cooktop when in use. These items could melt or ignite if placed too close to hot cookware.

CAUTION The cooking zones may appear to have cooled after they have been turned off. The glass surface may still be hot from residual heat and burns may occur if the cooktop is touched before it has cooled sufficiently.

Pan Preheat Recommendations

Induction cooking may decrease the amount of time required to preheat a cooking utensil compared to cooking on a radiant element cooktop or gas surface burner.

Whenever using the cooktop or oven, always pay close attention to all food items cooking and remain attentive until all the cooking is complete.

Important note:

Remember that induction surface cooking will initially heat the cooking utensil very quickly.

Important:

- The HE (hot element) message will appear in the display windows once a heating element or cooking zone is turned off and will remain on until the heating surface area or areas have cooled sufficiently.
- Do not allow aluminum foil, or any material that can melt, to make contact with the ceramic glass cooktop. If these items melt, they may damage the ceramic cooktop.
- The pan sensor will detect if the cookware is moved from the center of any active induction cooking zone, and the cookware will no longer heat. The affected cooking zone display window will flash until the cookware is moved back to the center of the cooking zone. If the cookware is properly centered on the cooking zone, the zone will resume heating. The cooking zone will remember the power level setting for up to three minutes before the cooking zone will automatically shut off.

Setting Surface Controls

Cooktop Operational Noises

The electronic processes involved in induction cooking may create some background noises. You may hear a slight buzzing sound when cooking on the cooktop. These noises are part of the induction cooking process and are considered normal.

Some cookware will buzz depending on the construction or base material. The buzz may be more noticeable if the contents of the pan are cold. As the pan heats, the noise will decrease. The noise will also decrease if the power level setting is reduced.

Important note:

When using the induction cooktop, operational noises are more noticeable while cooking at the Pb level. Very loud noises are not part of normal induction cooking.

Warm Zone

The purpose of the warm zone is to keep foods at serving temperatures and to warm oven-safe dishware. Cover all food on the warm zone with a lid to maintain quality. Always start with hot food. Do not heat cold food with the warm zone. For best results when warming pastries or breads, the cover should have an opening to allow moisture to escape. Do not use plastic wrap to cover food. Plastic may melt onto the surface and be difficult to remove. Use only dishware, utensils, and cookware recommended for oven and cooktop use.

To set the warm zone control:

⚠ WARNING Food Poisoning Hazard. Do not heat cold food on the warm zone. Doing so can result in food poisoning or sickness.

⚠ CAUTION The warm zone is radiant heat, but it will not glow red when it is hot. To avoid possible burns, always use potholders or oven mitts when moving food to and from the warm zone because cookware and plates will be hot.

⚠ CAUTION Radiant surface elements may appear to have cooled after they have been turned off. The glass surface may still be hot and burns may occur if the glass surface is touched before it has cooled.

⚠ CAUTION Do not place flammable items (plastic salt and pepper shakers, spoon holders, plastic wrappings, etc.) on top of the range when it is in use. These items could melt or ignite. Pot holders, towels, or wooden spoons could catch fire if placed too close to the surface elements.

1. Place cookware on the warm zone.
2. Push in and turn the warm zone's control knob to the desired setting, indicated by the semi-circle line around the knob. You may turn the knob either way (left or right) to activate the burner. (The warm zone indicator light will turn on).
3. When finished, turn the control knob to the OFF position.

Warm Zone Temperature Selection

If a particular food is not listed, start with the medium heat level and adjust as needed (See Table 2). Most foods can be kept at serving temperatures by using the medium heat level.

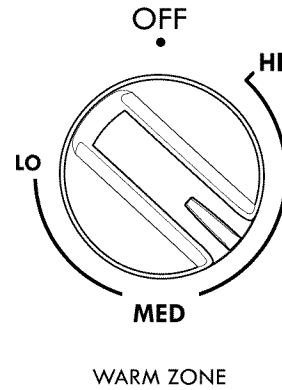

Figure 17: Warm zone control

Table 2: Warm zone recommended food settings

Food Item	Heating Level
Breads/Pastries	LO (Low)
Casseroles	LO (Low)
Dinner Plates with Food	LO (Low)
Eggs	LO (Low)
Gravies	LO (Low)
Meats	MED (Medium)
Sauces	MED (Medium)
Soups (cream)	MED (Medium)
Stews	MED (Medium)
Vegetables	MED (Medium)
Fried Foods	HI (High)
Hot Beverages	HI (High)
Soups (liquid)	HI (High)

Before Setting Oven Controls

Oven Vent Location

The oven vent is located under the left side of the control panel. When the oven is on, warm air passes through this vent. This venting is necessary for proper air circulation in the oven and good baking results. Do not block oven vent.

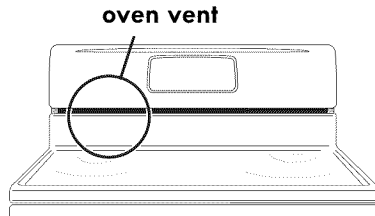

Figure 18: Do not block oven vent location

⚠ WARNING Protective Liners — Do not use aluminum foil to line the oven bottom. Only use aluminum foil as recommended in this manual. Improper installation of these liners may result in risk of electric shock or fire.

⚠ CAUTION Always use pot holders or oven mitts when using the oven. When cooking, the oven interior and exterior, as well as the oven racks, will become very hot which can cause burns.

Removing, Replacing, and Arranging Flat or Offset Oven Racks

To Arrange - Always arrange the oven racks when the oven is cool (prior to operating the oven).

To Remove - Pull the oven rack straight forward until it reaches the stop position. Lift up front of oven rack slightly and slide out.

To Replace - Place the oven rack on the rack guides on both sides of oven walls. Tilt the front of oven rack upward slightly and slide the oven rack back into place. Be sure oven racks are level before using.

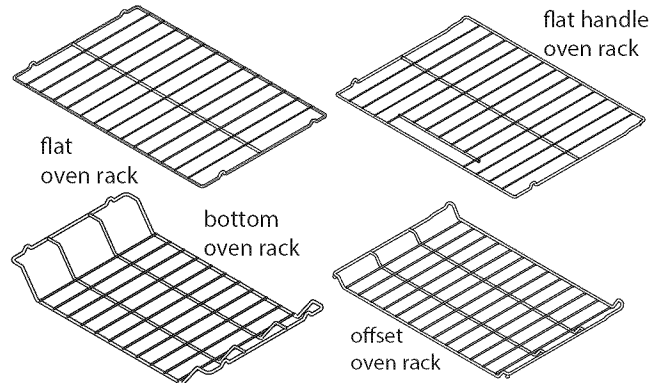

Figure 19: Oven rack types

Oven Rack Descriptions

- Flat oven racks (or the flat handle oven rack) may be used for most cooking needs and may be placed in most oven rack positions.
- The offset oven rack (some models) provides additional stepdown positions from the standard flat rack design. The offset design positions the base of the rack about 1/2 of a rack position lower than the flat rack and may be used in most oven rack positions.
- To maximize oven cooking space, place the bottom oven rack (some models) in the lowest rack position for baking or roasting large cuts of meat.

Air Circulation in the Oven

For best baking results allow 2-4" (5-10 cm) around the cookware for proper air circulation and be sure pans and cookware do not touch each other, the oven door, sides or back of the oven cavity. Hot air must be able to circulate around the cookware in the oven for even heat to reach around the food.

Oven Controls

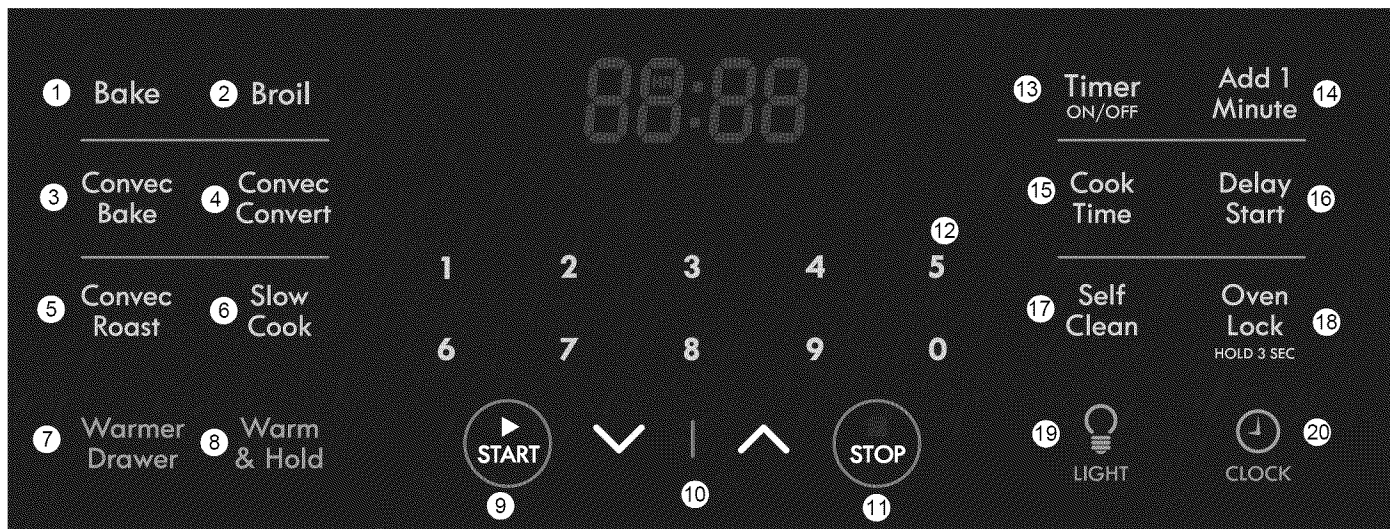

1. **Bake** - Use to start a normal Bake function.
2. **Broil** - Use to select Broil function.
3. **Convec Bake** - Use to select the Convection Bake function.
4. **Convec Convert** - Use to select the Convection Convert function.
5. **Convec Roast** - Use to select Convection Roast function.
6. **Slow Cook** - Use to select Slow Cook function.
7. **Warmer Drawer (some models)** - Use to select Warmer Drawer function.
8. **Warm & Hold** - Use to keep cooked food warm and at serving temperature for up to 3 hours.
9. **START** - Use to start oven functions.
10. **Up / Down arrows** - Use with the function keys to adjust settings and adjust temperature and times.
11. **STOP** - Use to cancel any oven function previously entered except clock and timer.
12. **0-9 keypad** - Use to enter oven temperatures and times.
13. **Timer ON/Off** - Use to set and cancel the timer.
14. **Add 1 Minute** - Use to add one minute to the timer. This works with the kitchen timer and does not affect any cook time or start time functions.
15. **Cook Time** - Use to set a specific amount of time needed for cooking. Automatically cancels cooking process at end of set time.
16. **Delay Start** - Use with Bake, Convection Bake, Convection Convert, and Self Clean functions to program a delayed start time.
17. **Self Clean** - Use to select 2, 3, or 4 hr Self-Clean cycle.
18. **Oven Lock** - Use to lock oven door and oven functions.

19. **LIGHT** - Use to turn internal oven light on and off.
20. **CLOCK** - Use to set time of day.

Important note:

The oven control works with both the numeric keypad and the Up / Down arrow keys. For cooking functions (Bake, Broil, Convec Bake, Convec Convert, Convec Roast, and Slow Cook) as well as for the Timer ON/OFF and the CLOCK functions, you may press the **Up / Down arrows** to adjust the temperature in addition to (or instead of) using the digital keys. Regardless of the method you choose, always press the **START** key to initiate the function.

Please be aware that the Up / Down arrows will not operate with the following functions: Warmer Drawer, Add 1 Minute, and Warm & Hold. If an arrow key is pressed in an attempt to program any given function that is invalid, the control will sound a triple beep.

Minimum and Maximum Control Settings

All of the features listed have minimum and maximum time and temperature settings that may be entered into the control. An entry acceptance beep will sound each time a key is touched. An entry error tone (three short beeps) will sound if the entry of the temperature or time is below the minimum allowable setting or above the maximum setting for the cooking feature. The error tone will also sound any time a key is pressed if the entry is determined to be an invalid selection.

Table 3: Minimum and maximum control settings

Feature	Min. Temp or Time	Max. Temp or Time
Bake	170°F (77°C)	500°F (260°C)
Broil	400°F (205°C)	550°F (288°C)
Timer	1 minute	11 hrs. 59 mins.
Self Clean	2 Hours	4 Hours
Warm & Hold	170°F (77°C)	3 Hours
Cook Time	1 Minute	11:59
Delay Time 12 Hr.	1:00	12:59
Delay Time 24 Hr.	0:00	23:59
Convec Bake	170°F (77°C)	500°F (260°C)
Convec Roast	170°F (77°C)	500°F (260°C)
Clock 12 Hr.	1:00	12:59
Clock 24 Hr.	0:00	23:59
Slow Cook	LO 225°F (108°C)	HI 275°F (134°C)



Setting Clock

When the appliance is first powered up, 12:00 will flash in the display (See Figure 20). The time of day must first be set before operating the oven.



Figure 20: 12:00 in display before setting the clock

To set clock to 1:30:

1. Press .
2. Enter 1 3 0 using numeric keypad or press the Up / Down arrow keys until 130 appears in the display.
3. Press .

Important note:

The clock cannot be changed when a Cook Time, Self Clean, Delay Start, or cooking feature is active.

Setting Timer

The minute timer allows you to track your cooking times without interfering with the cooking process. The timer may be set from a minimum time of 1 minute to a maximum of 11 hours and 59 minutes.

To set timer for 5 minutes:

1. Press **Timer ON/OFF**.
2. Enter 5 using numeric keypad or press the **Up arrow** key until 5 appears in the display.
3. Press  to start the timer. When set time ends, **END** will show in the display and the control will sound a beep three times every 30 seconds until **Timer ON/OFF** key is pressed.

To cancel the timer when active, press **Timer ON/OFF** again.

Important note:

- The timer does not start or stop the cooking process. It serves as an extra minute timer that will beep when the set time has run out. The timer may be used alone or while using any of the other oven functions.
- When timer is set for more than 1 hour it will display hours and minutes until 1 hour remains. When less than 1 hour remains, the display counts down in minutes and seconds. With less than 1 minute remaining, only seconds will display.
- If the timer is active during a cooking process, the timer will show in the display. To view the status of any other active oven function, press the key of the cooking function once and it will appear in the display for a few seconds.

Add 1 Minute

Use the Add 1 Minute feature to set additional minutes to the timer. Each press of the key will add 1 additional minute. If **Add 1 Minute** is pressed when the timer is not active, the timer will activate and begin counting down from 1 minute.

To add 2 minutes to the timer:

Press **Add 1 Minute** twice.

Oven Controls

Setting 12 Hour or 24 Hour Display Mode

The clock display mode allows you to select 12 hr or 24 hr modes. The factory pre-set clock display mode is 12 hours.

To set 12 hr or 24 hr display mode:



1. Press and hold  for 6 seconds.
2. Press the Up / Down arrow keys to toggle between 12 Hr day or 24 Hr day display modes (See Figure 21).
3. Press  to accept the choice.



Figure 21: 12 Hr dAy and 24 Hr dAy settings

Changing Between Continuous Bake Setting or 12 Hour Energy Saving

The oven control has a factory preset built-in 12 Hour Energy Saving feature that will turn off the oven if the oven is left on for more than 12 hours. The control may be programmed to override this feature to bake continuously.

To change between continuous bake or 12 hour energy saving feature:

1. Press and hold Timer ON/OFF for 6 seconds
2. Press the Up / Down arrow keys to toggle between 12 Hour OFF or Stay On feature (See Figure 22).
3. Press  to accept choice.



Figure 22: 12 hr energy saving (L) and continuous setting (R)

Changing Temperature Display to Fahrenheit (°F) or Celsius (°C)

The electronic oven control is set to display °F when shipped from the factory. The display may be changed to show either °F or °C oven temperatures.

To change temperature display mode from °F to °C or from °C to °F:

1. Press and hold Broil for 6 seconds.
2. Once F (or C) appears in the display, press the Up / Down arrow keys to toggle between Fahrenheit and Celsius temperature display modes (See Figure 23).
3. Press  to accept the choice.

Important note:

The oven temperature display cannot be changed during the cooking process or if a Delay Start has been set or Self Clean is active.

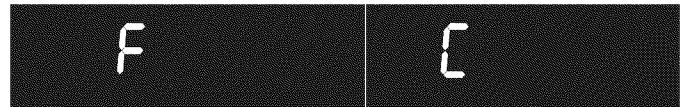

Figure 23: Display showing Fahrenheit and Celsius

Setting Silent or Audible Control mode

Silent mode allows the oven control to operate without audible tones. The control may be programmed for silent operation and later reset to operate with all the normal audible tones.

To set for silent or audible mode:

1. Press and hold Delay Start for 6 seconds.
2. Press the Up / Down arrow keys to toggle between bEEP On or bEEP OFF (See Figure 24).
3. Press  to accept the choice.



Figure 24: Display showing audible and silent operation

Setting Oven Lockout

The control may be programmed to lock the oven door and lock the oven control keys.

To activate the oven lockout features:

1. Be sure oven door is completely closed.
2. Press and hold the **Oven Lock** key for 3 seconds. The motor driven door latch mechanism will begin locking the oven door automatically. Do not open the oven door. Allow about 15 seconds for the oven door to completely lock. Once door is locked, the word **DOOR** with a lock icon will appear in the display. The Oven Lockout function locks the cooktop on this model.

To cancel the oven lockout feature:

1. Press and hold the **Oven Lock** key for 3 seconds. The motor door latch will begin unlocking the oven door automatically. Do not open the oven door. Allow about 15 seconds for the oven door to completely unlock.
2. When the word **DOOR** with a lock icon no longer displays, the oven door may be opened, and the oven control keypad will be available for use.

Important note:

- To avoid damage to the oven door latching mechanism, do not attempt to open or close the oven door whenever the word **DOOR** with a lock icon is displayed.
- If a control key is pressed when oven lockout is active, the control will triple beep indicating the key action is not available when the oven lockout feature is active. The Oven Lockout function locks the cooktop on this model.

Operating Oven Lights

The interior oven lights will automatically turn on when the oven door is opened. Oven lights will not operate during a self clean cycle.

Press  to turn the interior oven lights on and off whenever the oven door is closed.

The interior oven lights are located on the rear wall of the oven interior and are covered with a glass shield. The glass shield protects the bulb from high temperatures and should always be in place whenever the oven is in use.

To replace the interior oven light, see “Replacing Oven Light (some models)” on page 36.

Oven Controls

Setting Bake

Use the bake feature whenever the recipe calls for baking using normal temperatures. A reminder tone will sound indicating when the set bake temperature is reached and to place the food in the oven.

Bake may be set for any oven temperature between 170°F (77°C) to 500°F (260°C).

To set Bake for oven temperature of 425°F:

⚠ CAUTION Always use pot holders or oven mitts when using the oven. When cooking the oven interior, oven racks, and cooktop will become very hot which can cause burns.

1. Press **Bake**.
2. Enter **4 2 5** using numeric keypad or press the **Up arrow** key until **4 2 5** appears in the display.
3. Press **START**. The word **BAKE** will appear on the display.

To cancel Bake at any time, press **STOP**.

Baking tips

- When baking using two oven racks, position bakeware as shown in Figure 25. Allow at least 2 inches (5 cm) of space between bakeware for proper air circulation.
- Dark or dull pans absorb more heat than shiny bakeware, resulting in dark or overbrowning of foods. It may be necessary to reduce the oven temperature or cook time to prevent overbrowning of some foods. Dark pans are recommended for pies. Shiny pans are recommended for cakes, cookies, and muffins.
- Glass cookware is a slow heat conductor. May require reducing oven temperature.
- Minimize opening of the oven door. Opening the door will reduce the temperature in the oven.
- For cakes, pastries, and breads, use the convection bake function for best results when using multiple racks.
- Fully preheat the oven before cooking items like cookies, biscuits, and breads.
- When using any single rack, position the rack so that the food is in the center of the oven.
- For best results when baking cakes or cookies using two oven racks, place racks in positions 2 and 5 (See Figure 26) and place pans as shown in Figure 25.

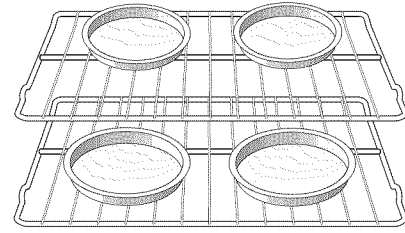

Figure 25: Baking on multiple levels

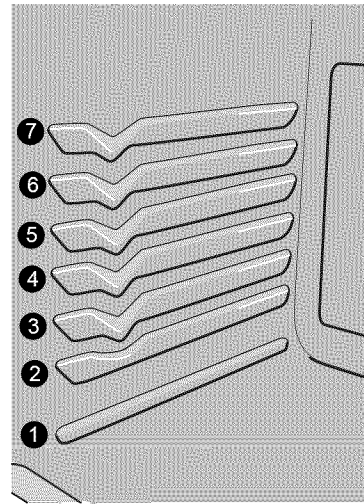

Figure 26: Oven rack positions

Important note:



The oven will bake no longer than 12 hours. If you wish to bake for a longer period, see "Setting Cook Time" on page 21 for detailed information.

Setting Cook Time

Use Cook Time to set the amount of time needed for baking. The oven will turn on immediately and stop automatically after the set cook time ends.

To program oven to bake with oven default temperature of 350°F and to shut-off after 30 minutes:

⚠ WARNING Food Poisoning Hazard. Do not let food sit for more than one hour before or after cooking. Doing so can result in food poisoning or sickness. Foods that can easily spoil such as milk, eggs, fish, meat, or poultry should be chilled in the refrigerator first. Even when chilled, they should not stand in the oven for more than 1 hour before cooking begins and should be removed promptly when finished cooking.

1. Press **Cook Time**.
2. Enter **3 0** using numeric keypad or press the **Up arrow** key until **3 0** appears in the display.
3. Press  to accept.
4. Press **Bake**.
5. Press . The word **BAKE** will appear on the display.

When the programmed cook time ends:

End will appear in the display window, and the oven will shut-off automatically (See Figure 27). The oven control will beep three times every 30 seconds as a reminder until  is pressed.





Figure 27: Display showing cooking has ended

Important note:

- The Cook Time feature may be set with Bake, Convection Bake, Convection Roast, and Slow Cook. Cook Time or Delay Start will not operate with the Broil function.
- The maximum Cook Time setting is 11 hours and 59 minutes unless oven is set for continuous cooking.

To change the oven temperature or cook time after baking has started:

1. Press **Bake** (for oven temperature) or **Cook Time**.
2. Press  or  and release when the desired temperature or cook time setting appears in the display. When the cook time runs out, **End** will appear in the display. The oven control will beep three times every minute until  is pressed.



Setting Delay Start

Delay Start sets a delayed starting time to oven cooking or cleaning functions. Prior to setting a delay start, be sure the time of day is set correctly.

To program oven for a Delay Start beginning at 5:30, to shut-off automatically after 50 minutes and for baking at 375°F:

⚠ WARNING Food Poisoning Hazard. Do not let food sit for more than one hour before or after cooking. Doing so can result in food poisoning or sickness. Foods that can easily spoil such as milk, eggs, fish, meat, or poultry should be chilled in the refrigerator first. Even when chilled, they should not stand in the oven for more than 1 hour before cooking begins and should be removed promptly when finished cooking.

⚠ CAUTION Always use pot holders or oven mitts when using the oven. When cooking the oven interior, oven racks, and cook-top will become very hot which can cause burn

1. Press **Cook Time**.
2. Enter **5 0** using numeric keypad or press the **Up arrow** key until **5 0** appears in the display.
3. Press  to accept.
4. Press **Delay Start**.
5. Enter **5 3 0** using numeric keypad or press the **Up arrow** key until **5 3 0** appears in the display.
6. Press  to accept.
7. Press **Bake**.
8. Enter **3 7 5** using numeric keypad or press the **Up arrow** key until **3 7 5** appears in the display.
9. Press .

When the programmed cook time ends:

End will appear in the display window, and the oven will shut off automatically (See Figure 27). The oven control will beep three times every 30 seconds as a reminder until  key is pressed.

Important note:

Delay Start may be set using a 24 hr clock. To set clock for 24 Hr operation, See “Setting 12 Hour or 24 Hour Display Mode” on page 18 for more information. The Delay Start feature may be used with Convection Bake, Convection Roast, Convection Convert, Bake, Slow Cook, and Self Clean functions. Delay Start or Cook Time will not operate with the Broil function.

Oven Controls

Convection Bake

Benefits of convection cooking include:

- Foods can cook up to 25 to 30% faster.
- Multiple rack baking.
- When using convection, use cookware or pans with low sides. This allows the air to circulate around the food evenly.

Convection functions use a fan to circulate the oven's heat uniformly and continuously around the oven. This improved heat distribution allows for fast, even cooking and browning results. It also gives better baking results when using two oven racks at the same time. Heated air flows around the food from all sides, sealing in juices and flavors. Breads and pastry brown more evenly. Most foods baked in a standard pan will cook faster and more evenly with the convection feature. Convec Bake may be set for any oven temperature between 170°F (77°C) and 500°F (260°C).

To set Convection Bake with a default oven set temperature of 350°F:

1. Press **Convec Bake**.
2. Press .

To cancel Convection Bake at any time, press .

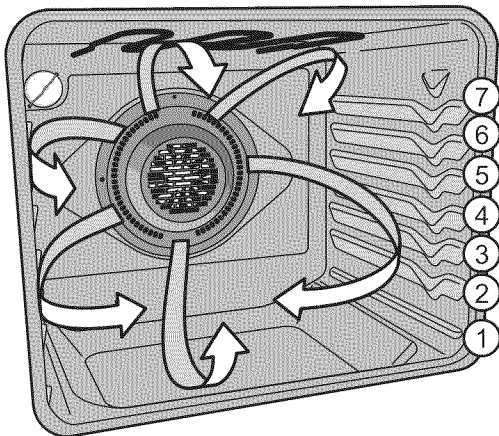

Figure 28: Air movement using convection

Important notes:

- If the oven door is opened when Convec Bake is active, the convection fan will stop rotating until the oven door is closed.
- When using Convec Bake, cook time reductions may vary depending on the amount and type of food being cooked.

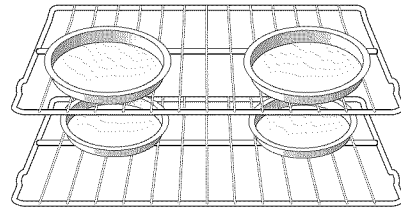

Figure 29: Baking on multiple levels

Baking tips

- Fully preheat the oven before cooking items like cookies, biscuits, and breads.
- When using any single rack, position the rack so that the food is in the center of the oven.
- Dark or dull bakeware absorbs more heat than shiny bakeware. It may be necessary to reduce oven temperature and cook time to prevent overbrowning of some foods. Dark bakeware is recommended for pies. Shiny bakeware is recommended for cakes, cookies, and muffins.
- Glass cookware may require reduced temperatures.
- Use pans or cookware with low sides. This allows the air to circulate around food evenly.
- Reduce oven temperature 25°F from recipe's recommended oven temperature. Follow the remainder of the recipe's instructions using the minimum recommended cook time.
- When using two oven racks, place in positions 2 and 5 (See Figure 28).
- For cakes, pastries, and breads, use the convection bake function for best results when using multiple racks.

Setting Convection Roast

The Convection Roast function combines a cook cycle with the convection fan to roast meats and poultry. Meats cooked using the Convection Roast function will be juicier, and poultry will be crisp on the outside while staying tender and moist on the inside.

Convection Roast may be set for any oven temperature between 170°F (77°C) and 500°F (260°C).

Suggestions for Convection Roast:

- Preheating is not necessary when roasting foods using Convection Roast. Since Convection Roast cooks food faster, reduce the cook time by 25% from the recommended cook time of your recipe. If necessary, increase cooking time until the desired doneness is obtained.
- The broiler pan will catch grease drippings, and the grid will help prevent splatters. The roasting rack will hold the meat. Use the offset rack on rack position 1.
- Do not cover foods when dry roasting because this will prevent the meat from browning properly.

To set Convection Roast with a default oven set temperature of 350°F:

1. Press **Convec Roast**.
2. Press .

To cancel Convection Roast at any time, press .

Important note:

- If the oven door is opened when any convection function is active, the convection fan will stop rotating until the oven door is closed.
- It is not recommended to roast chicken on a roasting rack. Use a deep pan instead.

Setting Convection Convert

Pressing the Convection Convert key automatically converts the cooking temperature entered for any standard baking recipe to the lower temperature required for convection baking.

When Convection Convert is used with a timed Convection Bake setting of 20 minutes or more, the Convection Convert function will display a **CF** message as a reminder to check food when the bake time is 75% complete (See Figure 30). At this time the oven control will sound one long beep at regular intervals until the set cook time has finished.





Figure 30: Check Food reminder shown in display.

To add Convection Convert to Convection Bake function using default oven set temperature of 350°F:

1. Press **Convec Bake**.
2. Press **Convec Convert**.



To cancel Convection Convert at any time, press .

To program oven for Convection Convert with oven default temperature of 350°F and to shut-off after 30 minutes:

1. Press **Convec Bake**.
2. Press .
3. Press **Cook Time**.
4. Enter **3 0** using numeric keypad or press the **Up arrow** key until **3 0** appears in the display.
5. Press .
6. Press **Convec Convert**.

To cancel Convection Convert at any time, press .

To program oven for Convection Convert with recipe temperature of 425°F and to shut-off after 30 minutes:

1. Press **Convec Bake**.
2. Enter **4 2 5** using numeric keypad or press the **Up arrow** key until **4 2 5** appears in the display.
3. Press .
4. Press **Cook Time**.
5. Enter **3 0** using numeric keypad or press the **Up arrow** key until **3 0** appears in the display.
6. Press .
7. Press **Convec Convert**. Set bake temperature will convert to a lower temperature and begin baking process.

To cancel Convection Convert at any time, press .

Important note:

- Convection Convert may only be used with the Convection Bake function and with a minimum of 20 minutes cook time.
- When using Convection Convert feature, Cook Time reductions may vary depending on the oven set temperature.
- The convection fan will begin rotating once Convection Bake, Convection Roast, or Convection Convert has been activated.
- If the oven door is opened when any convection function is active, the convection fan will stop rotating until the oven door is closed.



Oven Controls

Setting Broil

Use the Broil function to cook meats that require direct exposure to radiant heat for optimum browning results. The Broil feature is factory preset to broil at 550°F. The Broil function temperature may be set at any temperature between 400°F (205°C) and 550°F (288°C).

The suggested broil settings are recommendations only (See Table 4). Depending on cooking preferences, you can increase or decrease cooking times or move food to a different rack position. If the food you are broiling is not listed in the table, follow the instructions provided in your cookbook and watch the item closely.

To set Broil with the default broil oven temperature of 550°F:

1. Arrange the oven racks when cool. For optimum browning results, preheat oven for 2 minutes before adding food.
2. Position bakeware in oven. Leave door open at the broil stop position.
3. Press **Broil**.
4. Press . To set to a lower broil temperature, press and hold the **Down arrow** key until the desired temperature is reached. The lowest setting the oven control will accept for Broil is 400°F. To adjust the Broil temperature, press **Broil** again and then the **Up** or **Down** arrow key to set the desired temperature.
5. Broil on one side until food is browned; turn an broil other side until done to your satisfaction.
6. When finished broiling, press .
7. To cancel Broil at any time, press **STOP**.

CAUTION Always use pot holders or oven mitts when using the oven. When cooking, the oven interior, oven racks, and cook-top will become very hot which can cause burns.

WARNING Should an oven fire occur, close the oven door and turn the oven off. If the fire continues, use a fire extinguisher. Do not put water or flour on fire. Flour may be explosive.

Important notes:

- Always arrange oven racks when the oven is cool.
- For best results when broiling, use a broil pan with broil pan insert designed to drain the fat from the food and help avoid spatter and reduce smoking. To purchase them, call Sears at 1-800-4-MY-HOME (1-800-4663) and order broil pan kit 5304442087.
- When broiling, always pull the oven rack out to the stop position before turning or removing food.

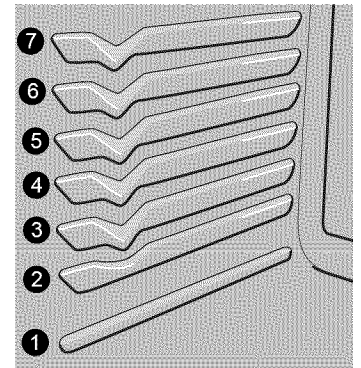
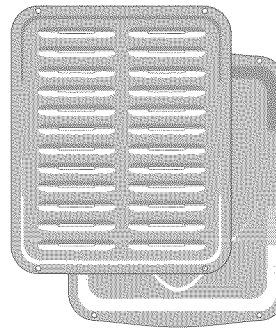

Figure 31: Broiler pan/insert

Figure 32: Rack positions

Table 4: Suggested Broil Settings¹

Food	Rack Position	Setting	Cook time in minutes		Doneness
			1st side	2nd side	
Steak, 1 inch thick	6th or 7th	550°F	8	6	Medium
Steak, 1 inch thick	5th or 6th	550°F	10	8	Medium-well
Steak, 1 inch thick	5th or 6th	550°F	11	10	Well
Pork Chops, 3/4 inch thick	5th	550°F	12	8	Well
Chicken, bone-in	5th	450°F	25	15	Well
Chicken, boneless	5th	450°F	10	8	Well
Fish	5th	550°F	as directed		Well
Shrimp	4th	550°F	as directed		Well
Hamburger, 1 inch	5th or 6th	550°F	12	10	Medium

1. For steaks, cook times are suggestions and should only be used as a guide.

Setting Slow Cook

The Slow Cook feature cooks foods more slowly and at lower oven temperatures for longer periods of time. Slow Cook is ideal for roasting beef, pork and poultry. Slow cooking meats may result in the exterior of meats becoming dark but will not burn the outside as it seals in the meat's juices.

Two Slow Cook settings are available: high (Hi) and low (Lo). The high setting is best for cooking foods between 4 and 5 hours. The low setting is best for cooking foods up to 9 hours or longer.

Tips for best results when using Slow Cook:

- Completely thaw all frozen foods before cooking.
- When using a single oven rack, place in oven rack position 2 or 3. Position racks to accommodate the size of various bakeware when cooking multiple food items.
- Do not open the oven door often or leave the door open when checking foods. If the oven heat escapes often, the Slow Cook time may need to be extended.
- Cover to keep foods moist or use a loose or vented type cover to allow foods to turn crisp or brown.
- Roasts may be left uncovered so browning can occur. Cook times will vary depending on the weight, fat content, bone, and the shape of the roast. Preheating the oven will not be necessary when using the Slow Cook feature.
- Add any cream or cheese sauces during the last hour of cooking.

Important note:

- Slow Cook may be used with additional settings of Cook Time and Delay Start.
- The maximum cook time for Slow Cook function is 11 hours and 59 minutes unless the control has been changed to the continuous bake mode.

To set Slow Cook:

⚠ WARNING Food poisoning hazard. Do not let food sit for more than one hour before or after cooking. Doing so can result in food poisoning or sickness. Foods that can easily spoil such as milk, eggs, fish, meat or poultry, should be chilled in the refrigerator first. Even when chilled, they should not stand in the oven for more than 1 hour before cooking begins, and should be removed promptly when finished cooking.

1. Position bakeware in oven and close oven door.
2. Press **Slow Cook**. HI will appear in the display, indicating the default temperature setting is for high.
3. If a low setting is needed, press the **Down arrow** key to select the low setting.
4. Press  to activate Slow Cook.

To cancel Slow Cook at any time, press .

Warm & Hold™

Warm & Hold should only be used with foods that are already at serving temperatures. Warm & Hold will keep cooked foods warm and ready for serving for up to 3 hours after cooking has finished. After 3 hours the Warm & Hold will shut-off automatically. Warm & Hold will keep the oven temperature at 170° F (77°C).



To set Warm & Hold:

1. If needed, arrange oven racks and place cooked food in oven.
2. Press **Warm & Hold**. Hold WARM will appear in the display. (If no other keys are touched within 25 seconds the request for Warm & Hold will clear.)
3. Press . Warm & Hold will automatically turn on and then turn off after 3 hours unless cancelled.

To turn Warm & Hold off at any time, press .

To add Warm & Hold to turn ON after baking 45 minutes with a set temperature of 425°F:

⚠ WARNING Food poisoning hazard. Do not let food sit for more than one hour before or after cooking. Doing so can result in food poisoning or sickness. Foods that can easily spoil such as milk, eggs, fish, meat or poultry, should be chilled in the refrigerator first. Even when chilled, they should not stand in the oven for more than 1 hour before cooking begins, and should be removed promptly when finished cooking.

1. Press **Cook Time**.
2. Enter 4 5 using numeric keypad.
3. Press .
4. Press **Bake** and enter 425 on numeric keypad.
5. Press  to accept.
6. Press **Warm & Hold**. Hold WARM will appear in the display.
7. Press . When the cook time is over, the Warm & Hold will automatically turn ON. The Warm & Hold function will automatically turn OFF after 3 hours.

Important note:

- Warm & Hold will maintain the oven temperature at 170° F (77°C) for 3 hours.
- Warm & Hold may be set when finished cooking or may be added to automatically turn on after cooking using Cook Time. Delay Start may also be added.

Oven Controls

Setting the Sabbath Feature (for use on the Jewish Sabbath and Holidays)



For further assistance, guidelines for proper usage, and a complete list of models with the Sabbath feature, please visit the web at www.star-k.org.

This appliance provides special settings for use when observing the Jewish Sabbath/Holidays. Sabbath mode disables all audible tones or visual display changes on the oven control. Bake heating is the only cooking feature available while in the Sabbath mode. Oven controls are locked during Sabbath mode.

You must first set the Bake feature and temperature(s) needed for the oven, the Cook Time, and Delay Start options (if needed). Any settings made prior to setting the Sabbath mode will be visible in the displays. The Cook Time option, if set prior to the Sabbath mode, will give one audible alert at the end of Cook Time.

The Sabbath mode will override the factory preset 12 hour energy saving mode, and the appliance will stay on until the cooking features are cancelled. If any of the cooking features are cancelled when the appliance is in the Sabbath mode, no audible or visual indicators will be available to verify the cancellation.

If the oven interior lights are needed, be sure to activate them prior to setting the Sabbath mode. Once the oven light is turned on and the Sabbath mode is active, the oven light will remain on until the Sabbath mode is turned off and the oven lights are turned off. The oven door will not activate the interior oven lights when the oven door is opened or closed.

It is recommended that any oven temperature modification made within an active Sabbath mode be followed with two presses of the **START** key. This will insure the oven remains on even if an attempt is made to set the oven temperature outside of its temperature range. If the oven temperature is set outside of the temperature range, the oven will default to the nearest available temperature. Try to set the desired oven temperature again.

⚠ WARNING Food poisoning hazard. Do not let food sit for more than one hour before or after cooking. Doing so can result in food poisoning or sickness. Foods that can easily spoil such as milk, eggs, fish, meat or poultry, should be chilled in the refrigerator first. Even when chilled, they should not stand in the oven for more than 1 hour before cooking begins, and should be removed promptly when finished cooking.

To program oven to Bake with default oven temperature of 350°F and activate the Sabbath feature:

1. Be sure the clock is set with the correct time of day.
2. Arrange oven racks, place bakeware in oven, and close oven door.
3. Press **Bake**.
4. Press .
5. If Cook Time or Delay Start are not needed, skip this step and continue to step 6. If a Cook Time or Delay Start are desired enter the times at this point. See "Setting Cook Time" and "Setting Delay Start" on page 21 for detailed instructions.
6. Press and hold **Cook Time** and **Delay Start** simultaneously for about 3 seconds to set the Sabbath feature. Once the feature is set, **SAb** will appear in the display indicating the oven is properly set for the Sabbath feature (See Figure 33).



Figure 33: Oven set for Sabbath baking.

Important note:

- Do not attempt to activate any other oven function except Bake while the Sabbath feature is active. The following keys will function correctly when the Sabbath feature is active: 0-9 number keypad, Bake, , and . All other keys should not be used once the Sabbath feature is active.
- You may change the oven temperature once baking has started. Press **Bake**, use the numeric keypad to enter the oven temperature change (170°F to 500°F), and press (for Jewish Holidays only).
- Remember that the oven control will no longer provide audible tones or display any further changes when the Sabbath feature is active.
- Remember the oven will shut-off automatically after completing a Cook Time, Delay Start, or Warm & Hold and therefore may only be used once during the Sabbath/Jewish Holidays.
- If a Delay Start time longer than 11 hours and 59 minutes is desired, set the oven control for the 24 hour day display mode setting. For detailed instructions, see "Setting 12 Hour or 24 Hour Display Mode" on page 18 for more information.

To turn the oven off and keep the Sabbath feature active:

Press .

To turn off the Sabbath feature:

Press and hold both **Cook Time** and **Delay Start** simultaneously for at least 3 seconds to turn the Sabbath feature off. The control will provide an acceptance tone, and **SAb** will disappear from the display. The oven is no longer programmed for the Sabbath feature.

What to do during a power failure or power interruption after the Sabbath feature was activated:

Should you experience a power failure or interruption, the oven will shut-off. When power is restored the oven will not turn back on automatically. The oven will remember that it is set for the Sabbath, and the oven display will show the message **SF** for Sabbath failure (See Figure 34).



Figure 34: Display showing Sabbath failure

The food may be safely removed from the oven while still in the Sabbath feature, however the oven cannot be turned back on until after the Sabbath/Holidays. After the Sabbath observance turn off the Sabbath feature. Press and hold both **Cook Time** and **Delay Start** keys for at least 3 seconds simultaneously to turn the Sabbath feature off. **SF** will disappear from the display, and the oven may be used with all normal functions.

Important:

The induction cooktop will not operate when the oven is set for Sabbath Day feature. The cooktop displays will show the cooktop lockout -- messages whenever the Sabbath Day feature is active.

Adjusting Oven Temperatures

Your appliance has been factory calibrated and tested to ensure accurate baking temperatures. For the first few uses, follow your recipe times and temperature recommendations carefully. If you think the oven is cooking too hot or too cool for your recipe times, you may adjust the control so the oven cooks hotter or cooler than the oven temperature displayed.

The oven temperature may be increased as much as +35°F (+19°C) or decreased -35°F (-19°C) from the factory calibrated settings.

To increase (+) or decrease (-) the oven temperature by 20°F:

1. Press and hold **Bake** until the control produces an audible tone (about 6 seconds). The factory offset temperature of 0 (zero) should appear in the display.
2. Enter **2 0** using numeric keypad.
3. To offset the oven by -20°F, press the **Down arrow** key until the display reads -20.
4. Press  to accept change.

Important note:

- Oven temperature adjustments will not change the Broil or Self Clean function temperatures.
- Do not use oven thermometers such as those found in grocery stores to check the temperature settings inside your oven. These oven thermometers may vary as much as 20 to 40°F degrees from actual temperatures.
- The oven temperature adjustment may be made if your oven control is set to display temperatures in °C (Celsius). Minimum and maximum settings for Celsius range from plus (+)19°C to minus (-) 19°C.

Restoring Factory Default Settings

Your appliance was set with predetermined (default) oven control settings. Over time, users may have made changes to these settings. The following options may have been modified since the appliance was new:

- 12 or 24 hr display mode
- Continuous bake or 12 hour energy savings mode
- Silent or audible control
- Oven temperature display (Fahrenheit or Celsius)
- Oven temperature adjustments (UPO)
- Any saved recipes

To restore oven control to factory default settings:

CAUTION If you choose to restore any of the options to a factory default setting using this method, all of the above user settings will be restored to the factory default settings. This includes the oven temperature offset that will reset to (0) zero.



1. Press and hold **7** on numeric keypad until acceptance tone sounds (about 6 seconds).
2. Press . The control has been reset with the default settings.

Oven Controls

Recipe Recall

Use the Recipe Recall feature to record and recall your favorite baking recipe settings. This feature stores and recalls different recipe settings using Bake, Conv Bake, and Conv Roast Recipe Recall may be programmed for any baking temperature between 170°F (77°C) to 550°F (288°C).

To store a Bake recipe. The recipe in this example is for a Bake at 325°F with a cook time of 45 minutes:

1. Press **Bake**.
2. Press **3 2 5** using the numeric keys to enter oven temperature.
3. Press .
4. Press **Cook Time**.
5. Press **4 5** using numeric keys to enter cook time.
6. Press and hold  until a tone sounds (about 3 seconds). The tone indicates that the recipe setting has been recorded for future recall.
7. Press .

Important note: The oven will automatically start heating with the recorded recipe unless  is pressed at this time.

To recall recipe stored in the example shown above. Recipe is for bake at 325°F for 45 minutes:

1. Position cookware in oven and close door.
2. Press **Bake**. (If recipe was stored using another cooking feature press that instead.)
3. Press . The oven will begin to cook with the programmed recipe. If Cook Time was recorded this feature will also recall the cooking time.

To cancel Recipe Recall at anytime press .

To erase a stored recipe:

1. Press the function where the recipe is stored.
2. Press .
3. Press **Cook Time**, enter **0 (zero)** and hold **start key** for 3 seconds until you hear the acceptance tone.

Important note:

- The Recipe Recall stores **Bake, Conv Bake, Conv Roast, Slow Cook, Cakes Breads and Preheat settings**. This feature will not work with **Delay Start** settings.
- If a recalled recipe includes Cook Time the oven will automatically shut-off when the Cook Time is finished.

Warmer Drawer (some models)

Warm & Ready™ Drawer

The purpose of the warmer drawer is to keep hot cooked foods at serving temperatures. Examples are vegetables, gravies, meats, casseroles, biscuits, rolls, and pastries. It is not recommended to heat cold food in the warmer drawer; always start with hot food.

The warmer drawer may also be used to warm dinner plates. All food placed in the warmer drawer should be covered with a lid or aluminum foil to maintain quality.

Important note:

Do not use plastic wrap to cover food. Plastic may melt onto the drawer and be very difficult to clean up. Use only utensils and cookware recommended by the manufacturer for use in the keep warm drawer.

Arranging Warmer Drawer Rack Positions

⚠ WARNING Storage In or On Appliance—Flammable materials should not be stored in an oven, near surface units or in the storage drawer, warmer drawer or lower oven. This includes paper, plastic, and cloth items, such as cookbooks, plastic ware, and towels, as well as flammable liquids. Do not store explosives, such as aerosol cans, on or near the range.

⚠ WARNING Do Not Leave Children Alone - Children should not be left alone or unattended in the area where appliance is in use. They should never be allowed to sit or stand on any part of the appliance, including the storage drawer, lower broiler drawer, warmer drawer, or lower double oven.

⚠ CAUTION Always use potholders or oven mitts when removing food from the warmer drawer as cookware and plates will be hot and you can be burned.

The keep warmer drawer rack may be used in two ways:

- In the upright position (See Figure 35) to allow low profile food items to be placed both under and on top of the rack (for example, rolls or biscuits on top of the rack and a casserole dish underneath).

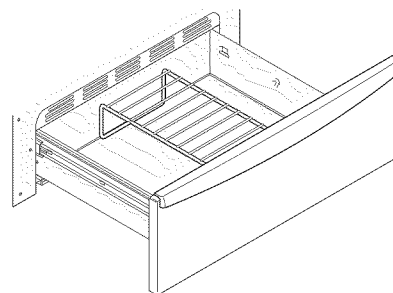

Figure 35: Upright position

- In the downward position (See Figure 36) to allow for light weight food items and empty cookware (for example, rolls, pastries, and dinner plates) on the rack.

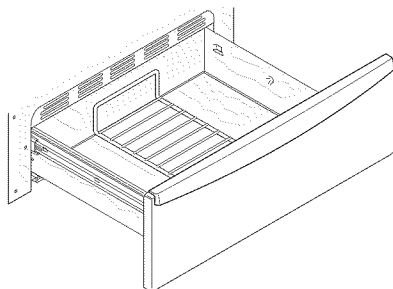

Figure 36: Downward position

Setting Warmer Drawer

To set warmer drawer:

⚠ WARNING Food Poisoning Hazard. Do not let food sit for more than one hour before or after cooking. Doing so can result in food poisoning or sickness. Foods that can easily spoil such as milk, eggs, fish, meat, or poultry should be chilled in the refrigerator first. Even when chilled, they should not stand in the oven for more than 1 hour before cooking begins and should be removed promptly when finished cooking.

⚠ CAUTION Always use potholders or oven mitts when removing food from the warmer drawer as cookware and plates will be hot and you can be burned.

1. Open warmer drawer when cool and arrange warmer drawer rack as needed.
2. For best results, close the warmer drawer and preheat the drawer before adding food or plates. An empty warmer drawer will fully preheat in approximately 15 minutes.
3. Place food in warmer drawer that is already at serving temperature on warmer drawer rack. Dinner plates may be warmed also.
4. Press **Warmer Drawer**, and then press **START**. The drawer will heat to 170°F.
5. Always turn warmer drawer control off after use by pressing **Warmer Drawer**.

Important notes:

- Always start with hot food when using the warmer drawer. Do not heat cold food in the warmer drawer.
- Self Clean can not be set when the warmer drawer is active.
- The warmer drawer is equipped with a catch that may require extra force to open and close the drawer.

Warmer Drawer Humidity Controller

This feature may be used to control humidity levels in the warmer drawer. The humidity control knob is located on the inside front panel of the warmer drawer.

To help keep foods moist, move the handle to the right. This closes the vents and helps keep the moisture inside the warmer drawer. For crisp foods, move the handle to the left. This opens the vents and allows more of the moisture to escape.

For dry heat: Slide the humidity control knob in the direction of the “less” arrow (See Figure 37). This allows more of the moist heat to escape and provides a drier environment for the food in the warmer drawer.

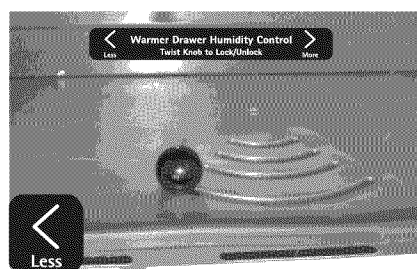

Figure 37: The dry heat position

For moist heat: Slide the humidity control knob in the direction of the “more” arrow (See Figure 38). More moisture will remain in the warmer drawer cavity. This will help keep the food in the warmer drawer from drying out.

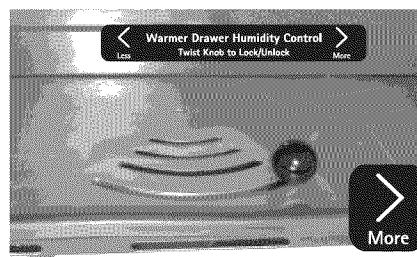

Figure 38: The moist heat position

Important note:

For some types of servings, you may want to store previously prepared food in a dry heat environment. For frequent controller adjustments, slightly loosen humidity controller knob and slide to the desired position. To maintain a setting, adjust controller knob into position and tighten knob.

Oven Controls

Removing and Replacing the Warmer Drawer

To remove the warmer drawer:

⚠ WARNING Electrical shock hazard can occur and result in serious injury or death. Disconnect appliance from electric power before cleaning and servicing the warmer drawer.

1. Turn power OFF to the appliance before removing the warmer drawer.
2. Open the warmer drawer completely.
3. On left warmer drawer rail, locate black release lever and press up with finger while pulling out slightly on the oven drawer handle. On right warmer drawer rail, locate black release lever and press down with finger while pulling out slightly on the warmer drawer handle (See Figure 39).

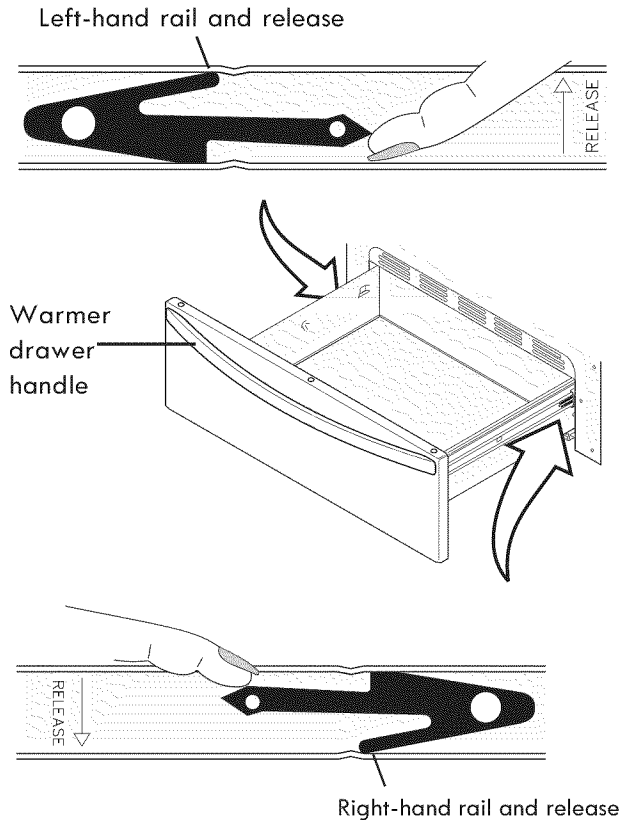

Figure 39: Removing the warmer drawer

4. The warmer drawer should now be released from the rails. Remove warmer oven drawer (using level and square motion) completely out and away from the appliance.

To replace the warmer drawer:

1. Pull the bearing glides to the front of the outer compartment glide channels until they snap into place (See Figure 40).

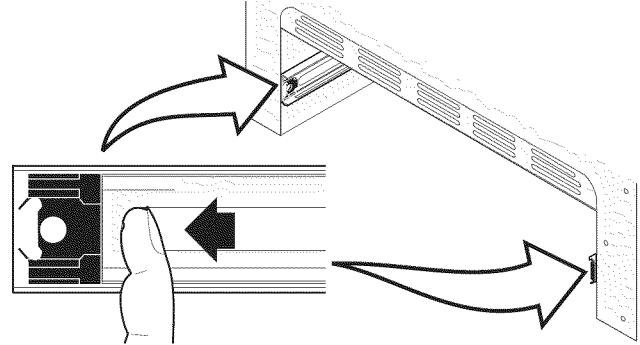

Figure 40: Bearing glide placement

2. Carefully line up both sides of the warmer drawer glide rails to the outer compartment glide channels located inside the empty warmer drawer compartment (See Figure 41).

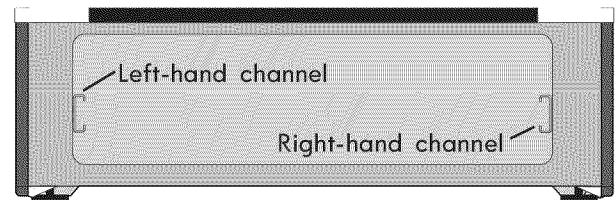

Figure 41: Channel alignment

3. While holding the warmer drawer level and square using the warmer drawer handle, push (do not force) the warmer drawer all the way into the outer compartment glide channels all the way into the range. Open the warmer drawer again to verify the glides have seated.
4. If you do not hear the levers click or the bearing glides do not feel seated remove the warmer drawer and repeat Steps 1 through 3 again. This will minimize possible damage to the bearing glides.

Self Clean

A self cleaning oven cleans itself with high temperatures (well above normal cooking temperatures), which eliminate soils completely or reduces them to a fine powdered ash you can wipe away afterwards with a damp cloth. This function can be programmed for any duration between 2 and 4 hours. Use the numeric keypad or the Up / Down arrow keys. Each arrow key pressed changes the time by 1 minute up or down. Press **START**.

Read before starting Self Clean. Be sure to read all following caution and important statements before starting a self clean cycle.

⚠ CAUTION Do not leave small children unattended near appliance. During self clean cycle, the outside of the oven can become very hot and cause burns if touched.

⚠ CAUTION Do not line the oven walls, racks, oven bottom, or any part of the range with aluminum foil. This will cause permanent damage to the oven interior and destroy heat distribution, and will melt to the oven interior.

⚠ CAUTION Do not force the oven door open. This will damage the automatic door locking system. Use caution when opening the oven door after the self clean cycle ends. The oven may still be very hot and cause burns. To avoid possible burns, stand to side of oven when opening door to allow steam or hot air to escape.

⚠ CAUTION The health of some birds is extremely sensitive to fumes given off during the self clean cycle of any range. Move birds to a well ventilated room.

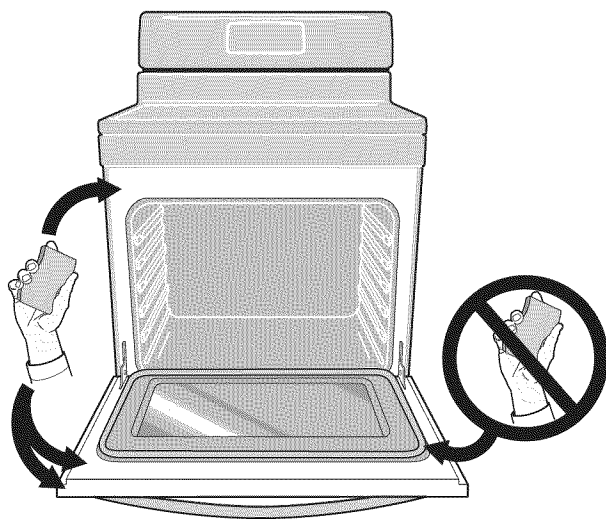

Figure 42: Areas to clean and to avoid

Important notes:

- Completely remove all oven racks and any accessories from oven cavity to avoid damage to oven racks. If the oven racks are not removed they may discolor. Remove all items from the oven and cooktop including cookware, utensils, and any aluminum foil. Aluminum foil will not withstand high temperatures from a self clean cycle and will melt.
- Do not use oven cleaners or oven protective coatings in or around any part of the oven interior. Clean any soil from the oven frame, the door liner outside the oven door gasket, and the small area at the front center of the oven bottom (See Figure 42). These areas heat sufficiently to burn soil on. Clean using soap and water prior to starting Self Clean.
- Remove any excessive spills. Any spills on the oven bottom should be wiped up and removed before starting a Self Clean cycle. To clean use hot, soapy water and a cloth. Large spills can cause heavy smoke or fire when subjected to high temperatures. Do not allow food spills with high sugar or acid content (such as milk, tomatoes, sauerkraut, fruit juices, or pie fillings) to remain on the surface as they may leave a dull spot even after cleaning.
- Do not clean the oven door gasket. The woven material in the gasket is essential for a good seal. Care should be taken not to rub, damage, or remove the oven door gasket. Doing so could cause damage to the door gasket and compromise the performance of the oven.
- The kitchen area should be well ventilated using an open window, ventilation fan, or exhaust hood during the first Self Clean cycle. This will help eliminate the normal odors.
- Do not attempt to open the oven door when the OVEN LOCK indicator light is flashing. Allow about 15 seconds for the motorized door latch mechanism to completely lock or unlock the oven door.
- When the clean time finishes, the oven door will remain locked until the range has cooled sufficiently. In addition to the clean time that was programmed, you must allow about 1 additional hour for the oven to cool before you will be able to open the oven door.
- This model comes with lubricated porcelain oven racks, which can remain in the oven during the self-clean cycle. Do not clean this vegetable oil lubrication off the racks. It is important that the sides of the oven racks always have a light coating of vegetable oil. To maintain optimal rack performance, re-apply a thin layer of vegetable oil to the sides of the rack after every self-clean cycle or when the rack becomes difficult to slide.

Oven Controls

Setting Self Clean

To set self clean:

1. Be sure the oven is empty and all oven racks are removed. Remove all items from the oven. Be sure oven door is completely closed.
2. Press **Self Clean** and the default 3 hour clean time will appear in the display. You may accept the default 3 hour clean time by going to step 3, or choose a different clean time. Press **Self Clean** and use the numeric keypad or **Up / Down arrow** keys to select any time between 2 hours and 4 hours. Once you have the desired clean time selected proceed to Step 3.
3. Press  to activate Self Clean.

As soon as Self Clean becomes active, a motor driven lock mechanism will begin locking the oven door automatically. Do not attempt to open the oven door (allow 15 seconds for the lock mechanism to lock the oven).

Once the oven door has locked, **CLEAN** will appear in the display indicating Self Clean has started.



When Self Clean is finished:

CAUTION Use caution when opening the oven door after self cleaning. The oven may still be very hot and can cause burns. To avoid possible burns stand to the side of the oven when opening the oven door to allow hot air or steam to escape.

1. **CLEAN** message will turn off, and **Hot** will appear in display window.
2. Once the oven has cooled down (about 1 hour) and **Hot** is no longer displayed, the oven door may be opened.
3. When the oven interior has completely cooled, wipe away any residue or powdered ash with a damp cloth or paper towel.

Setting Delay Start Self Clean

To start a delay Self Clean with default clean time of 3 hours and a start time of 9:00 o'clock:

1. Be sure the clock is set with the correct time of day, the oven is empty, and all oven racks are removed. Be sure oven door is completely closed.
2. Press **Delay Start**.
3. Using numeric keypad, enter **9 0 0** or press the **Up arrow** key until **9 0 0** appears in the display.
4. Press  to accept
5. Press **Self Clean**.
6. Press .

If it becomes necessary to stop Self Clean when active:

1. Press .
2. If Self Clean has heated the oven to a high temperature, allow enough time for the oven to cool.
3. Before restarting Self Clean, be sure to read important notes below.

Important note:

- If your clock is set with the (default) 12 hr display mode, the Delay Start for a Self Clean can only be programmed to start up to 11 hours and 59 minutes after the time showing in the display (be sure to set the clock to current time before programming a delay start). To set a Delay Start Self Clean to begin 12 or more hours (maximum is 23 hours and 59 minutes) after the time of setting, be sure to first set the control in the 24 Hr display mode.
- If Self Clean was active and then interrupted by a power failure or cancelled before the oven was thoroughly cleaned, it may be necessary to run another Self Clean cycle.
- If the oven temperature was high enough when Self Clean was interrupted the oven control may not allow another Self Clean cycle to be set for up to 4 hours.

Steam Clean

Steam cleaning works best for spot cleaning and light soils on the oven bottom. Steam clean may also be used before manually cleaning the oven or before Self Clean to help loosen soils on the oven bottom.

To set the controls for steam clean:

⚠ WARNING Do not set the cleaning temperature higher than the temperature listed in these instructions. Higher temperatures will dry the steam too soon and may lead to burns or serious injury when cleaning.

⚠ WARNING Do not attempt to wipe out the oven before the cooling off period or attempt to shorten the cooling off period. Doing so may lead to burns or other serious injury when cleaning.

⚠ CAUTION Do not add ammonia, oven cleaners, or any other household cleaners or chemicals to the water used for steam cleaning.

1. Oven should be at room temperature. Remove all racks and oven accessories.
2. Scrape or wipe loose debris from the oven bottom.
3. Pour 8 oz (235 ml) of distilled or filtered water onto the oven bottom (See Figure 43). Close the oven door.

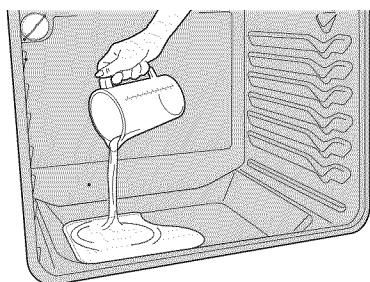



Figure 43: Pour water onto the oven bottom

4. Press **Bake**.
5. Enter **170°F (77°C)** using the arrow keys and press **START**.
6. Set the minute timer for **10** minutes.
7. Allow the oven to heat. Do not open the oven door while the oven is heating.
8. An alert will sound when the timer is finished. Press **Timer ON/Off** to stop the timer and press  to return to the clock.
9. Set the minute timer for **10** minutes to allow for a cool-down period. Do not attempt to wipe out the oven before a 10 minute cool-down period.
10. An alert will sound when the timer is finished. Press **Timer ON/Off** to stop the timer.

11. Stand to the side of the range out of the way of escaping vapor when opening the oven door.
12. Wipe oven cavity and bottom. Do not clean oven door gasket (See Figure 44).

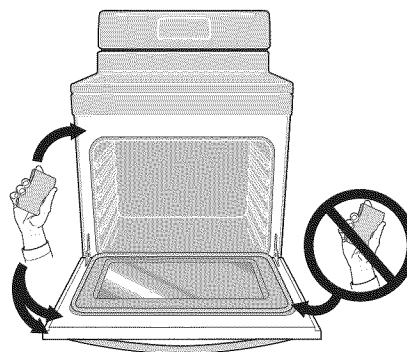



Figure 44: Do not clean the oven door gasket

To stop the steam cleaning cycle at any time, press .

Important notes:

- Always stay close to the oven when steam cleaning, so you can hear the timer alert.
- For best results, wipe out oven immediately after the cool-down period is complete.
- Removal of especially stubborn or baked-on soils may require a manual cleaning or a self clean cycle. See “Setting Self Clean” on page 32.
- Some condensation or water vapor may appear close to the oven vent, and some water may remain on the oven bottom. This is normal. Wipe with a soft cloth or sponge when the cool-down period is complete.
- The oven gasket may become damp; do not wipe dry. Open door to broil position and allow to air dry.
- Local water sources often contain minerals (hard water) and will leave deposits on the oven cavity surfaces. If this occurs, wipe cavity surfaces with diluted vinegar or lemon juice. Use distilled or filtered water.
- If the door is opened during steam cleaning or cool-down period, steam will escape and the oven may be more difficult to clean. Keep oven door closed during steam cleaning.

Care & Cleaning

Table 5: Cleaning recommendations

Surface Type	Recommendation
Control knobs Painted body parts Painted decorative trim Aluminum, plastic or vinyl trim	For general cleaning, use hot, soapy water and a cloth. For more difficult soils and built-up grease, apply a liquid detergent directly onto the soil. Leave on soil for 30-60 minutes. Rinse with a damp cloth and dry. Do not use abrasive cleaners on any of these materials; they can scratch. To remove control knobs, turn to OFF position. Grasp firmly and pull straight off the shaft. To replace knobs after cleaning, line up the flat sides of both knob and shaft, then push knob into place.
Control panel Control keypad membrane Decorative trim (some models)	Before cleaning the control panel, turn all controls off, activate oven lockout (on some models), and if needed remove any knobs from panel. Do not use abrasive cleaners on any of these materials; they can scratch. Clean using hot, soapy water and a cloth or sponge. Be sure to squeeze excess water from cloth or sponge before wiping control panel, especially when wiping around the controls area. Excess water in or around the controls may cause damage to the appliance. When rinsing, use clean water and a cloth or sponge and be sure to squeeze excess water from cloth or sponge before wiping the control panel.
Porcelain enamel parts and door liner	Gentle scrubbing with a soapy non-abrasive scouring pad will remove most spots. Rinse with a 1:1 solution of clear water and ammonia. If necessary, cover difficult spots with an ammonia-soaked paper towel for 30 to 40 minutes. Rinse with clean water and a damp cloth, and then scrub with a soap-filled non-abrasive scouring pad. Rinse and wipe dry with a clean cloth. Do not allow food spills with high sugar or acid content (milk, tomatoes, sauerkraut, fruit juices, or pie filling) to remain on the surface; they may cause a dull spot even after cleaning.
Oven interior	For oven interior remove excessive spillovers from oven cavity bottom before starting Self Clean. Clean any soils from oven frame and door liner outside the oven door gasket. For important cleaning precautions, read all the instructions in "Self Clean" on page 31.
Porcelain coated oven racks	This model comes with lubricated porcelain oven racks, which can remain in the oven during the self-clean cycle. Do not clean this vegetable oil lubrication off the racks. It is important that the sides of the oven racks always have a light coating of vegetable oil. To maintain optimal rack performance, re-apply a thin layer of vegetable oil to the sides of the rack after every self-clean cycle or when the rack becomes difficult to slide.
Oven door	Use soap and water to thoroughly clean the top, sides, and front of the oven door. Rinse well. You may use a glass cleaner on the outside glass of the oven door. Do not immerse the door in water. Do not spray or allow water or the glass cleaner to enter the door vents. Do not use oven cleaners, cleaning powders, or any harsh abrasive cleaning materials on the outside of the oven door.
Ceramic cooktop	Do not use spray cleaners on the cooktop. See "Cooktop Maintenance" on page 35.
Stainless Steel (some models)	Only use cleaners and polishes that are specifically manufactured for cleaning stainless steel. Always rub in direction of metal grain to avoid damaging. Do not use cleaners with high concentrations of chlorides or chlorine. Do not use harsh scrubbing cleaners. Polish with a lint-free cloth. Always be sure to wipe excess cleaner/polish off from the metal surface as bluish stains may occur during future oven heating that cannot be removed. Clean heavier soils with hot, soapy water and a cloth or sponge. Rinse and dry using clean water and a cloth.

Cooktop Maintenance

Consistent and proper cleaning is essential to maintaining your ceramic glass cooktop.

Prior to using your cooktop for the first time, apply the recommended CookTop® Cleaning Creme to the ceramic surface (on the web visit www.sears.com for replacement cooktop cleaner, item number 40079). Buff with a non-abrasive cloth or sponge. This will make cleaning easier when soiled from cooking. The special cooktop cleaning cream leaves a protective finish on the glass to help prevent scratches and abrasions.

Sliding aluminum or copper clad bottom pans on the cooktop can cause metal markings on the cooktop surface. These marks should be removed immediately after the cooktop has cooled using the cooktop cleaning cream. Metal marks can become permanent if not removed prior to future use.

Cookware (cast iron, metal, ceramic or glass) with rough bottoms can mark or scratch the cooktop surface.

Do not:

- Slide anything metal or glass across the cooktop.
- Use cookware with dirt or dirt build up on bottom; replace with clean cookware before using.
- Use your cooktop as a cutting board or work surface in the kitchen.
- Drop heavy or hard objects on the ceramic glass cooktop, they may cause it to crack.

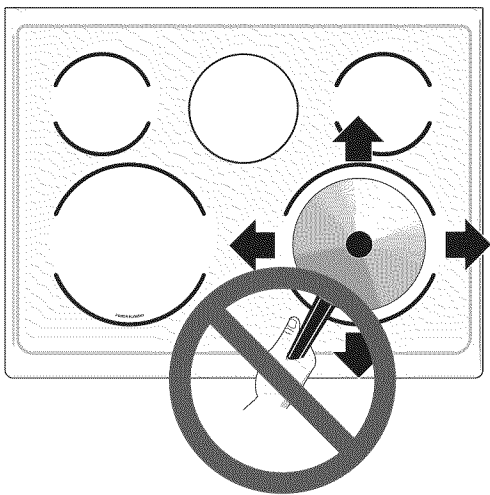

Figure 45: Cooktop care

Cooktop Cleaning

⚠ WARNING Do not use a cooktop cleaner on a hot cooktop. The fumes can be hazardous to your health, and can chemically damage the ceramic-glass surface.

⚠ CAUTION Before cleaning the cooktop, be sure the controls are turned to OFF and the cooktop is cool. The glass surface could be hot and burns may occur if the glass surface is touched before it has cooled sufficiently.

For light to moderate soil:

Apply a few drops of CookTop® Cleaning Creme directly to the cooktop. Use a paper towel or use a non-abrasive cloth or sponge to clean the entire cooktop surface. Make sure the cooktop is cleaned thoroughly, leaving no residue.

For heavy, burned on soil:

Apply a few drops of CookTop® Cleaning Creme directly to the soiled area. Rub the soiled area using a non-abrasive cleaning tool, applying pressure as needed. Do not use the pad you use to clean the cooktop for any other purpose.

If soils remain, carefully scrape soils with a metal razor blade scraper, holding scraper at a 30 degree angle to the surface. Remove loosened soils with cooktop cleaning cream and buff surface clean.

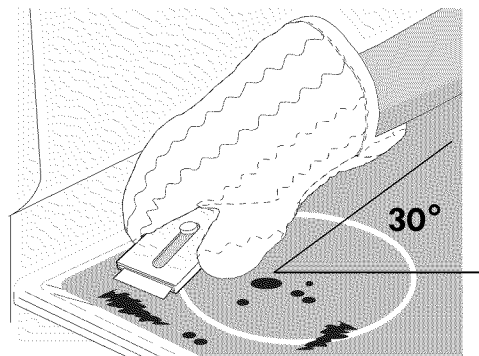

Figure 46: Cooktop cleaning

Plastic or foods with a high sugar content need be removed immediately if spilled or melted onto the ceramic cooktop surface. Permanent damage (such as pitting of the cooktop surface) may occur if not removed immediately. After turning the surface elements off, use a razor blade scraper or a metal spatula with a mitt and scrape the soil from the hot surface (as illustrated). Allow the cooktop to cool, and use the same method for heavy or burned on soils.

Care & Cleaning

Do not use the following on the cooktop:

- Do not use abrasive cleaners and scouring pads, such as metal and some nylon pads. They may scratch the cooktop, making it more difficult to clean.
- Do not use harsh cleaners, such as chlorine bleach, ammonia or oven cleaners, as they may etch or discolor the cooktop.
- Do not use dirty sponges, cloths or paper towels, as they can leave soil or lint on the cooktop which can burn and cause discoloration.

Important note:

Damage to the ceramic glass cooktop may occur if you use an abrasive type cleaning pad. Only use cleaning products that have been specifically designed for ceramic glass cooktops.



Figure 47: Cleaning products to avoid

General Cleaning

Refer to Table 5 for more detailed information about cleaning specific parts of the range.

CAUTION Before manually cleaning any part of the range, be sure all controls are turned off and the range is cool. The range may be hot and can cause burns.

CAUTION Ammonia must be rinsed before operating the oven. Provide adequate ventilation.

Aluminum foil and utensils

WARNING Never cover any slots, holes, or passages in the oven bottom or cover an entire oven rack with materials such as aluminum foil. Aluminum foil linings may trap heat, causing a fire hazard.

WARNING Protective Liners — Do not use aluminum foil to line the oven bottom. Only use aluminum foil as recommended in this manual. Improper installation of these liners may result in risk of electric shock, or fire.

- Aluminum foil - Use of aluminum foil on a hot cooktop can damage the cooktop. Do not use thin aluminum cooking utensils or allow aluminum foil to touch the surface elements under any circumstances.
- Aluminum utensils - The melting point of aluminum is much lower than that of other metals. Care must be taken when aluminum pots or pans are used on the cooktop. If aluminum pans are allowed to boil dry when using the cooktop, not only will the utensil be damaged or destroyed, but it may fuse to, break, or mark the ceramic glass surface, permanently damaging the cooktop surface.

Replacing Oven Light (some models)

To replace the interior oven light bulb:

The interior oven light bulb is located at the rear oven cavity and is covered with a glass shield. The glass shield must be in place whenever the oven is in use (See Figure 48).

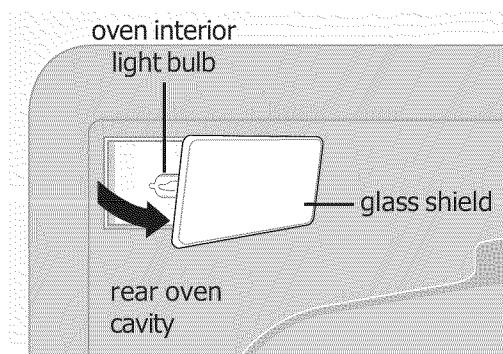

Figure 48: Replacing the oven light

CAUTION Be sure the range is unplugged and all parts are cool before replacing oven light. Wear a leather-faced glove for protection against possible broken glass.

1. Turn electrical power off at the main source or unplug the appliance.
2. Remove interior oven light shield.
3. Replace bulb with a new T-4 type 40 Watt Halogen appliance bulb. Please note: do not allow your fingers to touch the new bulb when replacing. This will shorten the life of the new bulb. Use a paper towel to cover the new bulb when installing.
4. Replace glass interior oven light shield.
5. Turn power back on again at the main source (or plug the appliance back in).
6. Be sure to reset the time of day on the clock.

Removing and Replacing the Lift-Off Oven Door

⚠ CAUTION To avoid possible injury when removing or replacing the oven door, follow the instructions below carefully and always hold the oven door with both hands positioned away from the door hinge area.

⚠ CAUTION The door is heavy. For safe, temporary storage, lay the door flat with the inside of the door facing down.

To remove the oven door:

1. Open oven door completely (horizontal with floor - Figure 49).
2. Pull the door hinge locks on both left and right door hinges down from the oven frame completely towards the oven door (Figure 50). A tool such as a small flat-blade screwdriver may be required.
3. Firmly grasp both sides of oven door along the door sides (Do not use the oven door handle - Figure 51).
4. Close the door to the broil stop position (the oven door will stop into this position just before fully closing).
5. With the oven door in the broil stop position, lift the oven door hinge arms over the roller pins located on each side of the oven frame (Figure 52).

To replace oven door:

1. Firmly grasp both sides of oven door along the door sides (Do not use the oven door handle - Figure 51).
2. Holding the oven door at the same angle as the removal position, seat the hook of the hinge arm over the roller pins located on each side of the oven door frame (Figure 52). The hook of the hinge arms must be fully seated onto the roller pins.
3. Fully open the oven door (horizontal with floor - Figure 49).
4. Push the door hinge locks up towards and into the oven frame on both left and right oven door hinges (Figure 50) to the locked position; then, close the oven door.

Special Care Instructions

Most oven doors contain glass that can break. Follow these recommendations:

- Do not close the oven door until all the oven racks are fully in place inside the oven cavity.
- Do not hit the glass with pots, pans, or any other object.
- Scratching, hitting, jarring, or stressing the glass may weaken its structure causing an increased risk of breakage at a later time.

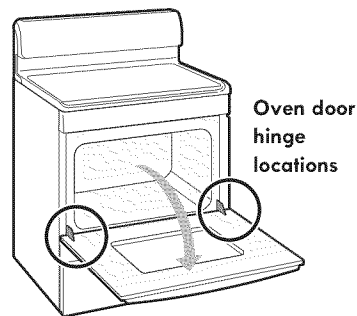

Figure 49: Oven hinge locations

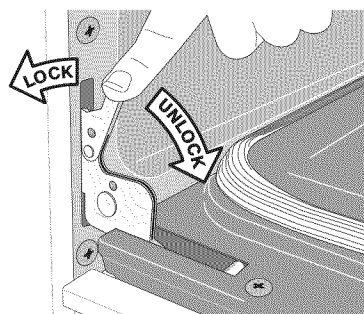

Figure 50: Hinge lock/unlock positions

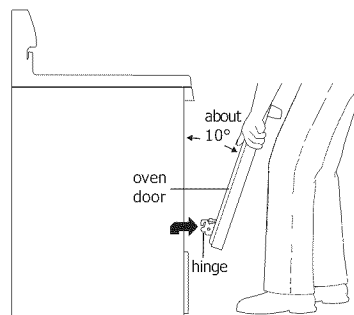

Figure 51: How to remove door

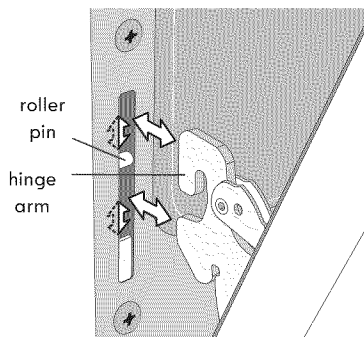

Figure 52: Hinge pin locations



Before You Call

Oven Baking

For best cooking results, heat the oven before baking cookies, breads, cakes, pies, pastries, et cetera. There is no need to preheat the oven for roasting meat or baking casseroles.

The cooking times and temperatures needed to bake a product may vary slightly from your previously owned appliance.

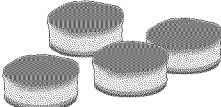
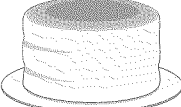
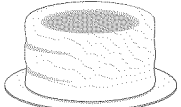
Baking Problems and Solutions

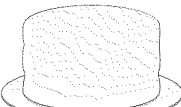
Baking Problems	Causes	Corrections
<p>Cookies and biscuits burn on the bottom.</p> 	<ul style="list-style-type: none"> • Cookies and biscuits put into oven before the preheating time is completed. • Oven rack is overcrowded. • Dark pans absorb heat too fast. 	<ul style="list-style-type: none"> • Allow oven to preheat to desired temperature before placing food in oven. • Choose pan sizes that will permit 2" to 4" of air space (5.1 cm or 10.2 cm) on all sides when placed in the oven. • Use a medium weight baking sheet.
<p>Cakes too dark on top or bottom</p> 	<ul style="list-style-type: none"> • Cakes put in oven before preheating time is completed. • Rack position too high or too low. • Oven too hot. 	<ul style="list-style-type: none"> • Allow oven to preheat to the selected temperature before placing food in the oven. • Use proper rack position for baking needs. • Set oven temperature 25°F (13°C) lower than recommended.
<p>Cakes not done in center</p> 	<ul style="list-style-type: none"> • Oven too hot. • Incorrect pan size. • Pan not centered in oven. • Glass cookware slow heat conductor. 	<ul style="list-style-type: none"> • Set oven temperature 25°F (13°C) lower than recommended. • Use pan size suggested in recipe. • Use proper rack position and place pan so there is 5.1 cm to 10.2 cm (2" to 4") of space on all sides of pan. • Reduce temperature and increase cook time or use shiny bakeware.
<p>Cakes not level.</p> 	<ul style="list-style-type: none"> • Oven not level. • Pan too close to oven wall or rack overcrowded. • Pan warped. 	<ul style="list-style-type: none"> • Place a marked glass measuring cup filled with water on the center of the oven rack. If the water level is uneven, refer to the installation instructions for leveling the oven. • Be sure to allow 5.1 cm to 10.2 cm (2" to 4") of clearance on all sides of each pan in the oven. • Do not use pans that are dented or warped.
<p>Foods not done when cooking time is over.</p> 	<ul style="list-style-type: none"> • Oven too cool. • Oven overcrowded. • Oven door opened too frequently. 	<ul style="list-style-type: none"> • Set oven temperature 25°F (13°C) higher than suggested and bake for the recommended time. • Be sure to remove all pans from the oven except the ones to be used for baking. • Open oven door only after shortest recommended baking time. • Make sure to allow 2" to 4" of clearance between all pans and racks, allowing for even air flow.

Solutions to Common Problems

Before you call for service, review the following list. It may save you time and expense. Possible solutions are provided with the problem listed:

Problem	Solution
Poor baking results	<ul style="list-style-type: none"> • Many factors affect baking results. Make sure the proper oven rack position is used. Center food in the oven and space pans to allow air to circulate. Allow the oven to preheat to the set temperature before placing food in the oven. Try adjusting the recipe's recommended temperature or baking time. If you feel the oven is too hot or cool, see "Adjusting Oven Temperatures" on page 27.
Appliance is not level.	<ul style="list-style-type: none"> • Be sure floor is level, strong, and stable enough to adequately support range. • If floor is sagging or sloping, contact a carpenter to correct the situation. • Poor installation. Place oven rack in center of oven. Place a level on the oven rack. Adjust leveling legs at base of appliance until the rack is level. • Kitchen cabinet alignment may make range appear not level. Be sure cabinets are square and have sufficient room for appliance clearance.
Cannot move appliance easily. Appliance must be accessible for service.	<ul style="list-style-type: none"> • Cabinets not square or are built in too tightly. Contact builder or installer to make appliance accessible. • Carpet interferes with appliance. Provide sufficient space so appliance can be lifted over carpet.
Entire appliance does not operate.	<ul style="list-style-type: none"> • Make sure power cord is plugged properly into outlet. • Electrical power outage. Check house lights to be sure. Call your local electric company for service outage information. • Service wiring is not complete. Call 1-800-4-MY-HOME® for assistance (See back cover).
Oven portion of appliance does not operate.	<ul style="list-style-type: none"> • The time of day is not set. The time of day must first be set in order to operate the oven. See "Setting Clock" on page 17. • Be sure the oven controls are set properly for the desired function. See the "Oven Controls" starting on page 16 and review instructions for the desired cooking function in this manual or see "Entire appliance does not operate" in this checklist.
Surface element is too hot or not hot enough.	<ul style="list-style-type: none"> • Incorrect induction cooktop power level setting. Adjust power level setting higher or lower as needed.
Surface element does not heat or does not heat evenly.	<ul style="list-style-type: none"> • Be sure the correct surface control knob is turned on for element needed. • Lightweight or warped pans used. Use only flat, evenly balanced, medium or heavy-weight cookware. Flat pans heat better than warped pans. Cookware materials and weight of the material affect heating. Heavy and medium-weight pans heat evenly. Because lightweight pans heat unevenly, foods may burn easily.
Oven light does not work.	<ul style="list-style-type: none"> • Be sure the oven light is secure in the socket. Also see "Replacing Oven Light (some models)" on page 36.

Before You Call

Oven smokes excessively when broiling.	<ul style="list-style-type: none">• Incorrect setting. Follow the "Setting Broil" instructions on page 24.• Be sure oven door is opened to broil stop position when broiling.• Meat too close to the broil element. Reposition the broil rack to provide proper clearance between the meat and the element. Preheat the broil element for searing.• Meat not properly prepared. Remove excess fat from meat. Cut remaining fatty edges to prevent curling, but do not cut into lean.• Grease has built up on oven surfaces. Regular cleaning is necessary when broiling frequently. Old grease or food spatters cause excessive smoking.
Flames inside oven or smoking from oven vent.	<ul style="list-style-type: none">• Excessive spillovers in oven. For example, this will happen for pie spillovers or large amounts of grease left on the oven bottom. Wipe up excessive spillovers before starting oven. If flames or excessive smoke are present, follow "Setting Broil" on page 24.
Oven control panel beeps and displays any F code error.	<ul style="list-style-type: none">• Oven control has detected a fault or error condition. Press STOP to clear the error code. Try Bake or Broil function. If the F code error repeats, remove power from appliance, wait 5 minutes, and then repower appliance and set clock with the correct time of day. Try Bake or Broil function again. If the fault recurs, press STOP to clear and call 1-800-4-MY-HOME® for assistance (See back cover).
Self Clean does not work.	<ul style="list-style-type: none">• Oven control not set properly. Review the "Self Clean" instructions on page 31.
Soil not completely removed after Self Clean.	<ul style="list-style-type: none">• Self Clean was interrupted. Review the "Self Clean" instructions on page 31.• Excessive spillovers on oven bottom. Remove before starting Self Clean.• Failure to clean soil from the oven frame, the door liner outside the oven door gasket and the small area at the front center of the oven bottom. These areas are not in the self-cleaning area, but get hot enough to burn on residue. Clean these areas before the self-cleaning cycle is started. Burned-on residue can be cleaned with a stiff nylon brush and water or a nylon scrubber. Be careful not to damage the oven gasket.
Oven racks discolored.	<ul style="list-style-type: none">• Oven racks left in oven cavity during Self Clean. Always remove oven racks from oven cavity before starting a self-clean cycle. Clean by using a mild, abrasive cleaner following manufacturer's instructions. Rinse with clean water, dry and replace in oven.
Convection fan does not rotate.	<ul style="list-style-type: none">• Oven door is open. Convection fan will turn off if oven door is opened when Convection is active. Close oven door.
Scratches or abrasions on cooktop surface.	<ul style="list-style-type: none">• Coarse particles such as salt or hardened soils between cooktop and utensils can cause scratches. Be sure cooktop surface and bottoms of utensils are clean before usage. Small scratches do not affect cooking and will become less visible with time.• Cleaning materials not recommended for ceramic-glass cooktop have been used. Apply the recommended CookTop® Cleaning Creme to the ceramic surface (on the web visit www.sears.com for replacement cooktop cleaner, item number 40079). Buff with a non-abrasive cloth or sponge. For more information, see "Cooktop Maintenance" on page 35.• Cookware with rough bottom was used. Use smooth, flat-bottomed cookware.
Metal marks on the cooktop.	<ul style="list-style-type: none">• Sliding or scraping of metal utensils on cooktop surface. Do not slide metal utensils on cooktop surface. Apply the recommended CookTop® Cleaning Creme to the ceramic surface (on the web visit www.sears.com for replacement cooktop cleaner, item number 40079). Buff with a non-abrasive cloth or sponge. For more information, see "Cooktop Maintenance" on page 35.
Brown streaks or specks on cooktop surface.	<ul style="list-style-type: none">• Boilovers are cooked onto surface. Use razor blade scraper to remove soil. For more information, see "Cooktop Maintenance" on page 35.

-
- | | |
|--|---|
| Areas of discoloration with metallic sheen on cooktop surface. | <ul style="list-style-type: none">• Mineral deposits from water and food. Remove using the recommended CookTop® Cleaning Creme to the ceramic surface (on the web visit www.sears.com for replacement cooktop cleaner, item number 40079). Buff with a non-abrasive cloth or sponge. |
| Induction cooking zone does not heat cookware or does not heat evenly. | <ul style="list-style-type: none">• Be sure the correct surface control is activated for the cooking zone.• Be sure to use the correct cookware material type for induction cooking. Use cookware specifically identified by the manufacturer to use for induction cooking. If you're not sure, use a magnet to test whether the cookware type will work. If a magnet sticks to the bottom of the cookware, the material type is correct for induction cooking.• Be sure to read about pan-sensing in the Induction Cooking section and correct any pan-sensing issues in the checklist provided.• Use quality heavier gauge cookware. |
| Cooking zones do not glow when heating. | <ul style="list-style-type: none">• The induction cooking zones do not glow even when they are hot. Induction cooking uses electromagnetic energy to induce heat directly to the cookware. |
-

Before You Call

Master Protection Agreements

Congratulations on making a smart purchase. Your new Kenmore® product is designed and manufactured for years of dependable operation. But like all products, it may require preventive maintenance or repair from time to time. That's when having a Master Protection Agreement can save you money and aggravation.

The Master Protection Agreement also helps extend the life of your new product. Here's what the Agreement* includes:

- ☑ **Parts and labor** needed to help keep products operating properly **under normal use**, not just defects. Our coverage goes **well beyond the product warranty**. No deductibles, no functional failure excluded from coverage – **real protection**.
- ☑ **Expert service** by a force of more than **10,000 authorized Sears service technicians**, which means someone you can trust will be working on your product.
- ☑ **Unlimited service calls and nationwide service**, as often as you want us, whenever you want us.
- ☑ **“No-lemon” guarantee** – replacement of your covered product if four or more product failures occur within twelve months.
- ☑ **Product replacement** if your covered product can't be fixed.
- ☑ **Annual Preventive Maintenance Check** at your request – no extra charge.
- ☑ **Fast help by phone** – we call it **Rapid Resolution** – phone support from a Sears representative on all products. Think of us as a “talking owner’s manual”.
- ☑ **Power surge protection** against electrical damage due to power fluctuations.
- ☑ **\$250 Food Loss Protection** annually for any food spoilage that is the result of mechanical failure of any covered refrigerator or freezer.
- ☑ **Rental reimbursement** if repair of your covered product takes longer than promised.
- ☑ **25% discount** off the regular price of any non-covered repair service and related installed parts.

Once you purchase the Agreement, a simple phone call is all that it takes for you to schedule service. You can call anytime day or night, or schedule a service appointment online.

The Master Protection Agreement is a risk free purchase. If you cancel for any reason during the product warranty period, we will provide a full refund. Or, a prorated refund anytime after the product warranty period expires. Purchase your Master Protection Agreement today!

Some limitations and exclusions apply. For prices and additional information in the U.S.A. call 1-800-827-6655.

*** Coverage in Canada varies on some items. For full details call Sears Canada at 1-800-361-6665.**

Sears Installation Service

For Sears professional installation of home appliances, garage door openers, water heaters, and other major home items, in the U.S.A. or Canada call **1-800-4-MY-HOME®**.

Acuerdos maestros de protección

Enhorabuena por haber hecho una compra inteligente. Su nuevo producto Kenmore® está diseñado y fabricado para brindarle años de funcionamiento fiable. Pero, como cualquier producto, puede necesitar mantenimiento preventivo o reparaciones periódicas. Es por eso que tener un Acuerdo maestro de protección podría ahorrarle dinero y molestias.

El Acuerdo maestro de protección también sirve para prolongar la durabilidad de su nuevo producto. El acuerdo* incluye lo siguiente:

- ☑ **Piezas y mano de obra** necesarias para contribuir a mantener el funcionamiento adecuado de los productos **utilizados en condiciones normales de uso**, no sólo en caso de defectos de los productos. Nuestra cobertura va **mucho más allá que la garantía del producto**. No se aplican deducibles ni exclusiones por fallas del funcionamiento: es decir, **verdadera protección**.
- ☑ **Servicio técnico por expertos** (más de **10000 técnicos autorizados de Sears**), lo cual significa que quien repare o realice el mantenimiento de su producto será un profesional de confianza.
- ☑ **Servicio técnico a escala nacional y número ilimitado de llamadas de solicitud de servicio técnico**: se puede poner en contacto con nosotros cuantas veces lo desee y cuando lo desee.
- ☑ **Garantía “sin sorpresas”**: se reemplaza el producto cubierto por el acuerdo si ocurren cuatro o más fallas del producto en un periodo de 12 meses.
- ☑ **Reemplazo del producto**: en caso de que no se pueda reparar el producto cubierto por el acuerdo.
- ☑ **Revisión anual preventiva de mantenimiento del producto**: puede solicitarla en cualquier momento, sin costo alguno.
- ☑ **Rápida asistencia telefónica**, la cual denominamos **Solución rápida**: es decir, asistencia telefónica a través de cualquiera de nuestros representantes de Sears, sobre cualquiera de nuestros productos. Piense en nosotros como en un “manual parlante del usuario”.
- ☑ **Protección contra fallas eléctricas**, contra daños debidos a fluctuaciones de la corriente eléctrica.
- ☑ **\$250 al año para cubrir cualquier posible deterioro de alimentos** que haya tenido que desechar debido a una falla mecánica de cualquiera de nuestros refrigeradores o congeladores cubiertos por este acuerdo.
- ☑ **Devolución de gastos de alquiler de electrodomésticos** si la reparación de su producto asegurado toma más que el tiempo prometido.
- ☑ **25% de descuento** aplicable tanto a los costos del servicio de reparación, como de las piezas instaladas relacionadas que no hayan quedado cubiertos por este acuerdo.

Una vez que haya realizado el pago de este acuerdo, bastará una simple llamada telefónica para concertar una visita de servicio. Puede llamar a cualquier hora del día o de la noche, o bien concertar una visita de servicio por Internet.

La adquisición del Acuerdo maestro de protección es una inversión exenta de riesgos. Si por cualquier motivo decide cancelar dicho acuerdo durante el periodo de garantía del producto, le haremos un reintegro total del valor. O bien un importe proporcional si cancela el acuerdo en cualquier otro momento posterior al vencimiento del periodo de garantía del producto. ¡Adquiera hoy mismo su Acuerdo maestro de protección!

Algunas limitaciones y exclusiones podrían aplicarse. Para solicitar precios e información adicional, llame al 1-800-827-6655 (en los EE.UU.).

*** La cobertura en Canadá varía en el caso de algunos artículos. Para obtener detalles completos al respecto, llame al 1-800-361-6665 de Sears de Canadá.**

Servicio de instalación de Sears

Para solicitar la instalación por profesionales de Sears de electrodomésticos, abridores de puertas de garaje, calentadores de agua y otros artículos de uso prioritario en el hogar, **llame al 1-800-4-MY-HOME** en los EE.UU. o Canadá.

Get it fixed, at your home or ours!

Your Home

For troubleshooting, product manuals and expert advice:



www.managemylife.com

For repair – **in your home** – of **all** major brand appliances, lawn and garden equipment, or heating and cooling systems, **no matter who made it, no matter who sold it!**

For the replacement parts, accessories and owner's manuals that you need to do-it-yourself.

For Sears professional installation of home appliances and items like garage door openers and water heaters.

1-800-4-MY-HOME[®] (1-800-469-4663)

Call anytime, day or night (U.S.A. and Canada)

www.sears.com www.sears.ca

Our Home

For repair of carry-in items like vacuums, lawn equipment, and electronics, call anytime for the location of your nearest

Sears Parts & Repair Service Center

1-800-488-1222 (U.S.A.) **1-800-469-4663** (Canada)

www.sears.com www.sears.ca

To purchase a protection agreement on a product serviced by Sears:

1-800-827-6655 (U.S.A.) **1-800-361-6665** (Canada)

Para pedir servicio de reparación a domicilio, y para ordenar piezas:

1-888-SU-HOGAR[®]

(1-888-784-6427)

www.sears.com

Au Canada pour service en français:

1-800-LE-FOYER^{MC}

(1-800-533-6937)

www.sears.ca

The Sears logo, consisting of the word "sears" in a lowercase, serif font.

® Registered Trademark / TM Trademark of KCD IP, LLC in the United States, or Sears Brands, LLC in other countries

© Marca Registrada / TM Marca de Fábrica de KCD IP, LLC en Estados Unidos, o Sears Brands, LLC in otros países

^{MC} Marque de commerce / ^{MD} Marque déposée de Sears Brands, LLC