

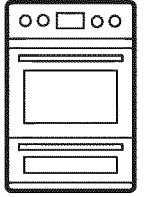

Electrolux



.....
Induction Range

.....
Use and Care Guide

CONTENTS

- | | | | |
|-----------|---------------------------------|-----------|------------------------------|
| 7 | Before Setting Surface Controls | 39 | Care and Cleaning |
| 10 | Setting Surface Controls | 43 | Solutions to Common Problems |
| 14 | Before Setting Oven Controls | 43 | Before You Call |
| 16 | Setting Oven Controls | 46 | Warranty |

WELCOME TO ELECTROLUX

PLEASE READ & SAVE THIS GUIDE

Thank you for purchasing an Electrolux appliance. You've chosen a product that brings with it decades of professional experience and innovation. Ingenious and stylish, it has been designed with you in mind. So whenever you use it, you can be safe in the knowledge that you'll get great results every time.

This Use & Care Guide is part of our commitment to customer satisfaction and product quality throughout the service life of your new appliance.

We view your purchase as the beginning of a relationship. To ensure our ability to continue serving you, please use this page to record important product information.

CUSTOMER CARE AND SERVICE

When contacting Service, ensure that you have the following data available.

The information can be found on the rating plate.

Serial plate location: open lower oven drawer (some models) or warmer drawer. (which one of these do we want to keep, this information can be changed at any time but if we can try and get it as close as possible that would be great)

We recommend the use of original spare parts.

Registering your product with Electrolux enhances our ability to serve you. You can register online at www.electroluxappliances.com or by dropping your Product Registration Card in the mail.

Keep a Record for Quick Reference

Purchase Date _____

Electrolux model number _____

Electrolux serial number _____

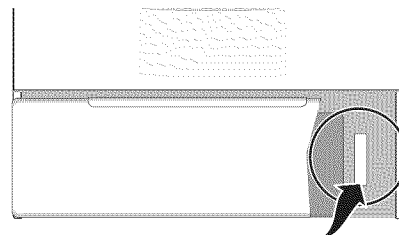

QUESTIONS?

For toll-free telephone support in the U.S. and Canada:

1-877-4ELECTROLUX (1-877-435-3287)

For online support and Internet production information visit <http://www.electroluxappliances.com>.

Important Safety Instructions

Read all instructions before using this appliance.

This manual contains important safety symbols and instructions. Please pay attention to these symbols and follow all instructions given.

⚠ CAUTION

Persons with a pacemaker or similar medical device should exercise caution using or standing near an induction unit while it is in operation, as the electromagnetic field may affect the working of the pacemaker or similar medical device. It would be advisable to consult your Doctor or the pacemaker or similar medical device manufacturer about your particular situation.

This appliance has been tested and found to comply with the limits for a class B digital device, pursuant to Part 18 of the FCC rules. These limits are designed to provide reasonable protection against harmful interference in a residential installation. This unit generates, uses and can radiate radio frequency energy and, if not installed and used in accordance with the instructions, may cause harmful interference to radio communications. However there is no guarantee that interference will not occur in a particular installation. If this unit does cause harmful interference to radio or television reception, which can be determined by turning the unit off and on, the user is encouraged to try to correct the interference by one or more of the following measures:

- Reorient or relocate the receiving antennae. Increase distance between unit and receiver.
- Connect the unit into an outlet or a circuit different from that to which the receiver is connected.

DEFINITIONS

⚠ WARNING

Obey all safety messages that follow this symbol to avoid possible injury or death.

Do not attempt to install or operate your appliance until you have read the safety precautions in this manual. Safety items throughout this manual are labeled with a WARNING or CAUTION statement based on the risk type.

⚠ WARNING

Indicates a potentially hazardous situation which, if not avoided, may result in death or serious injury.

⚠ CAUTION

Indicates a potentially hazardous situation which, if not avoided, may result in minor or moderate injury.

Indicates installation, operation, maintenance or valuable information that is not hazard related.

IMPORTANT! Indicates installation, operation, maintenance or valuable information that is not hazard related.

⚠ WARNING

Tip Over Hazard

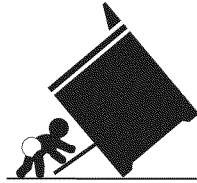

- A child or adult can tip the range and be killed.
- Verify the anti-tip device has been installed to floor or wall.

- Ensure the anti-tip device is re-engaged to floor or wall when the range is moved.
- Do not operate the range without the anti-tip device in place and engaged.
- Failure to follow these instructions can result in death or serious burns to children and adults.



Range leveling leg

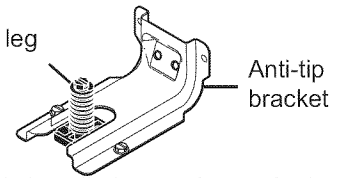

To check if the anti-tip bracket is installed properly, use both arms to grasp the rear edge of the range back. Carefully attempt to tilt range forward. When properly installed, the range should not tilt forward.

Refer to the anti-tip bracket installation instructions supplied with your range for proper installation.

⚠ WARNING

Stepping, leaning or sitting on the door or drawers of a range can result in serious injuries and also cause damage to the appliance. **DO NOT** allow children to climb or play around the range. The weight of a child on an open oven door may cause the range to tip, resulting in serious burns or other injury. **NEVER** cover any slots, holes or passages in the oven bottom or cover an entire oven rack with materials such as aluminum foil. Aluminum foil linings may trap heat, causing a fire hazard.

⚠ WARNING

Storage in or on appliance — flammable materials should not be stored in an oven, near surface units or in the storage drawer, warmer drawer or lower oven. This includes paper, plastic and cloth items, such as cookbooks, plasticware and towels, as well as flammable liquids. Do not store explosives, such as aerosol cans, on or near the range.

Important Safety Instructions

⚠ WARNING

Do not leave children alone — children should not be left alone or unattended in the area where appliance is in use. They should never be allowed to sit or stand on any part of the appliance, including the storage drawer, lower broiler drawer, warmer drawer or lower double oven.

⚠ CAUTION

Do not store items of interest to children in the cabinets above a range or on the backguard of the range. Children climbing on the range to reach items could be seriously injured.

⚠ CAUTION

Do not touch surface heating units, or surface cooking elements, areas near these surface heating units, or interior surface of the oven. Both surface heating and oven heating elements may be hot even though they are dark in color. Areas near surface cooking units may become hot enough to cause burns. During and after use, do not touch, or let clothing or other flammable materials touch these areas until they have had sufficient time to cool. Among these areas are the cook top, surfaces facing the cook top, the oven vent openings and surfaces near these openings, oven door and oven door window.

⚠ CAUTION

Wear proper apparel — loose-fitting or hanging garments should never be worn while using the appliance. Do not let clothing or other flammable materials contact hot surfaces.

⚠ CAUTION

DO NOT USE WATER OR FLOUR on grease fires — smother the fire with a pan lid, or use baking soda, a dry chemical or foam-type extinguisher.

⚠ CAUTION

When heating fat or grease, watch it closely. Fat or grease may catch fire if allowed to become too hot.

⚠ CAUTION

Use dry potholders — moist or damp potholders on hot surfaces may result in burns from steam. Do not let potholders touch hot heating elements. Do not use a towel or other bulky cloth instead of a potholder.

⚠ CAUTION

Do not heat unopened food containers — buildup of pressure may cause container to burst and result in injury.

IMPORTANT! Important Safety Notice

The California Safe Drinking Water and Toxic Enforcement Act requires the Governor of California to publish a list of substances known to the state to cause cancer, birth defects or other reproductive harm, and requires businesses to warn customers of potential exposure to such substances.

- Remove all tape and packaging before using the range. Destroy the carton and plastic bags after unpacking the range. Never allow children to play with packaging material.
- Proper installation—Be sure your appliance is properly installed and grounded by a qualified technician in accordance with the National Electrical Code ANSI/NFPA No. 70 latest edition and local electrical code requirements. Install only per installation instructions provided in the literature package for this range.
- **Do not attempt to operate the range during a power failure.** If the power fails, always turn off the range. If the range is not turned off and the power resumes, the range will begin to operate again. Once the power resumes, reset the clock and oven function.
- User servicing—Do not repair or replace any part of the appliance unless specifically recommended in the manuals. All other servicing should be done only by a qualified technician. This may reduce the risk of personal injury and damage to the range.
- Ask your dealer to recommend a qualified technician and an authorized repair service. Know how to disconnect the power to the range at the circuit breaker or fuse box in case of an emergency.
- Never modify or alter the construction of a range by removing the leveling legs, panels, wire covers, anti-tip brackets/screws, or any other part of the range.
- Remove the oven door from any unused range if it is to be stored or discarded.

Save these instructions for future reference.

Important Safety Instructions

IMPORTANT INSTRUCTIONS FOR USING YOUR OVEN

⚠ WARNING

Protective Liners — **DO NOT USE ALUMINUM FOIL** to line the oven bottom. Only use aluminum foil as recommended in this manual. Improper installation of these liners may result in risk of electric shock, or fire.

- Use care when opening oven door, warmer drawer or lower oven door — Stand to the side of the range when opening the door of a hot oven. Let hot air or steam escape before you remove or replace food in the oven.
- Keep oven vent ducts unobstructed. The oven vent is located below the backguard. Touching the surfaces in this area when the oven is operating may cause severe burns. Also, do not place plastic or heat-sensitive items on or near the oven vent. These items could melt or ignite.
- Placement of interior oven racks. Always place oven racks in desired location while oven is cool. If rack must be moved while oven is hot use extreme caution. Use potholders and grasp the rack with both hands to reposition. Do not let potholders contact the hot heating elements in the oven. Remove all utensils from the rack before moving.
- Do not use the broiler pan without its insert. The broiler pan and its insert allow dripping fat to drain and be kept away from the high heat of the broiler.
- Do not cover the broiler insert with aluminum foil. Exposed fat and grease could ignite.

IMPORTANT INSTRUCTIONS FOR USING YOUR COOKTOP

- Know which knob controls each surface heating unit. Place a pan of food on the surface element unit before turning it on, and turn the element off before removing the pan.
- Use proper pan size — This appliance is equipped with one or more surface units of different sizes. Select utensils specifically designed for induction ranges having flat bottoms large enough to cover the surface of the induction zone. Proper relationship of cookware to zone will also improve efficiency. If improperly placed, the display will flash until the cookware is placed properly on the induction zone.

- Cookware handles should be turned inward and not extend over adjacent surface elements. — To reduce the risk of burns and spillage due to unintentional contact with the utensil, the handle of the cookware should be positioned so that it is turned inward, and does not extend over adjacent surface units.
- Never leave surface elements unattended at high heat settings — Boil overs cause smoking and greasy spills.
- Glazed cooking utensils — Only certain types of cookware are suitable for cook top service and must be magnetic to work properly on the induction zones. Check the manufacturer's recommendations for cook top use to ensure that the cookware is compatible with induction cooking.
- When flaming foods under a ventilating hood, turn the fan on.

IMPORTANT INSTRUCTIONS FOR CERAMIC-GLASS COOK TOP MODELS

- **Do not cook on broken cook top**—If cook top should break, cleaning solutions and spillovers may penetrate the broken cook top and create a risk of electric shock. Contact a qualified technician immediately.
- **Clean cook top with caution**—If a wet sponge or cloth is used to wipe spills on a hot cooking area, be careful to avoid a steam burn. Some cleaners can produce noxious fumes if applied to a hot surface.

Save these instructions for future reference.

Important Safety Instructions

IMPORTANT INSTRUCTIONS FOR CLEANING YOUR RANGE

⚠ CAUTION

Before manually cleaning any part of the range, be sure all controls are turned OFF and the range is COOL. The range may be hot and can cause burns.

- Clean the range regularly to keep all parts free of grease that could catch fire. Pay particular attention to the area around each surface element. Do not allow grease to accumulate.
- Kitchen cleaners and aerosols — Always follow the manufacturer's recommended directions for use. Be aware that excess residue from cleaners and aerosols may ignite causing damage and injury.
- Clean ventilating hoods frequently — Grease should not be allowed to accumulate on the hood or filter. Follow the manufacturer's instructions for cleaning hoods.

IMPORTANT INSTRUCTIONS FOR SELF-CLEANING OVENS

- **Clean in the self-cleaning cycle only the parts listed in this Use & Care Manual.** Before self-cleaning the oven, remove the oven racks, broil pan, broil pan insert and any cookware, cooking utensils or foods from the oven.
- Do Not Use Oven Cleaners — No commercial oven cleaner or oven liner protective coating of any kind should be used in or around any part of the oven.
- Do Not Clean Door Gasket — The door gasket is essential for a good seal. Care should be taken not to rub, damage or move the gasket.
- The health of some birds is extremely sensitive to the fumes given off during the self-cleaning cycle of any range. Move birds to another well-ventilated room.

GROUNDING INSTRUCTIONS

FOR MODELS FACTORY EQUIPPED WITH A POWER CORD

⚠ WARNING

Avoid fire hazard or electrical shock. DO NOT use an adapter plug, an extension cord, or remove grounding prong from electrical power cord. Failure to follow this warning can cause serious injury, fire or death.

This appliance is equipped with a 3-prong grounding plug for your protection against shock hazard and should be plugged directly into a properly grounded receptacle. **DO NOT** cut or remove the grounding prong from this plug.

For personal safety, the range must be properly grounded. For maximum safety, the power cord must be plugged into an electrical outlet that is correctly polarized and properly grounded.

If a 2-prong wall receptacle is the only available outlet, it is the personal responsibility of the consumer to have it replaced with a properly grounded 3-prong wall receptacle installed by a qualified electrician.

See **INSTALLATION INSTRUCTIONS** packaged with this range for complete installation and grounding instructions.

Grounding type wall receptacle

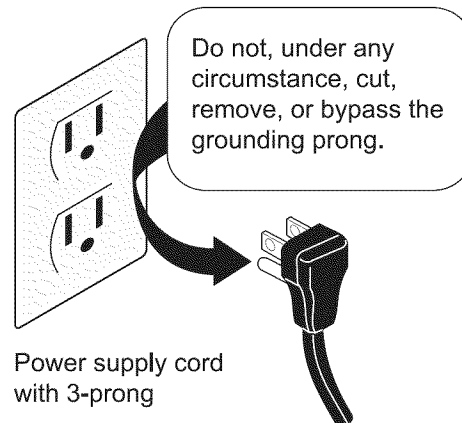

IMPORTANT! Make sure to purchase the power cord that is designed to fit your receptacle. Your receptacle may differ from the one shown in the image above. For maximum safety, the power cord must be plugged into an electrical outlet that is correctly sized, polarized and properly grounded.

Save these instructions for future reference.

BEFORE SETTING SURFACE CONTROLS

Using proper cookware

The size and type of cookware used will influence the induction zone power level setting needed for best cooking results. Be sure to follow the recommendations for using proper cookware.

Cookware should have flat bottoms that make good contact with the induction cooking zone. Check for flatness by rotating a ruler across the bottom of the cookware.

Cookware should always:

- Have flat bottoms.
- Have tight fitting lids.
- Be well-balanced.
- Be made of material that conducts heat well.
- Be easy to clean.
- Match to the size of the element.

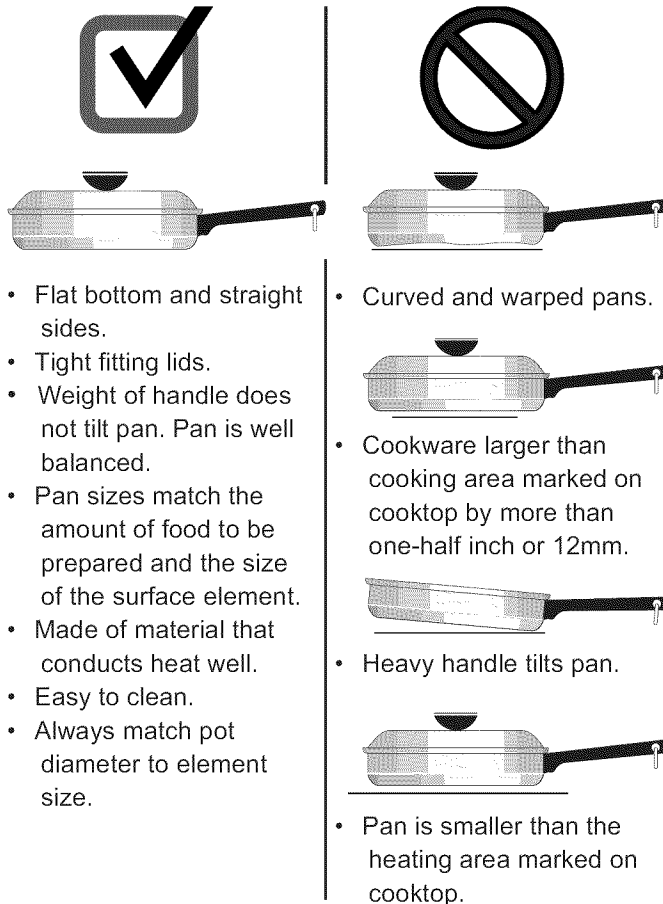
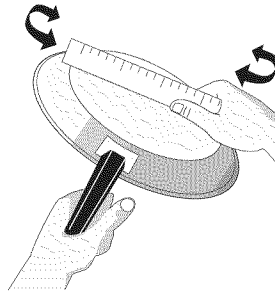

Figure 1: Choosing proper cookware

Induction cookware

Before using the induction cooking zones, be sure to carefully read and follow these cookware recommendations and the instructions in the **pan sensing** section.

Induction cooking requires proper cookware that is made specifically to work with the induction heating zones. Not all stainless steel will work. Only cookware that attracts a magnet is acceptable. Most manufacturers will prominently display information that their cookware is induction compatible or made specifically for induction ranges.

The cooking zones will not activate if the cookware is not constructed with a base magnetic material. To check if the cookware is suitable, use a magnet to test (Figure 2). If a magnet sticks to the bottom of the cookware, the material type is correct.

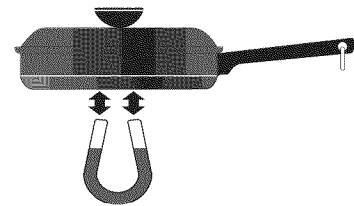

Figure 2: Check bottom of cookware with a magnet

For the best possible surface cooking results, it is recommended to only use high quality heavy gauge cookware on the induction cooking zones.

Be sure to follow all the manufacturer's recommendations when using cookware made for induction cooking.

Induction cookware types

The most common induction cookware types available are:

- **Stainless steel** - Generally, excellent for induction cooking. Is durable, easy to clean and resists staining.
- **Cast iron** - Good for induction cooking. Cooks evenly. Do not slide cast iron cookware on cooktop. Cast iron cookware with a rough surface will scratch ceramic cooktop.
- **Porcelain-enamel on metal** - Heating characteristics will vary depending on quality of base material. Porcelain-enamel coating must be smooth to avoid scratching ceramic cooktop.

CAUTION Not all stainless steel cookware is magnetic; stainless steel is not always suitable for induction cooking. Always check to make sure the bottom of the cookware will attract a magnet.

Benefits of induction surface cooking

Fast and efficient - The induction cooking zones heat faster while using less energy. Induction power levels are quick to boil and efficient when simmering.

A cooler cooktop - A unique feature of the induction cooking zones is whether turned on or off, the cooking zones remain cooler than radiant type elements. Virtually no wasted heat is produced since the heat begins with the presence of cookware.

Easy cleanups - The cooler cooking zones make cleanup easier. Spills resist sticking or burning so they wipe up easily.

Magnetic detector - The cooking zone has a sensor that automatically detects whether cookware is magnetic. This will reduce accidental turn-on.

Pan size detection - The pan size recognition sensor automatically detects and adapts the induction cooking zones to the pan sizes in use for consistent, more even cooking.

More responsive - The induction cooking zones are more responsive than their electric or gas counterparts because only the pan heats. This type of cooking heats easier and will be just as responsive when reducing to a simmer.

About the induction cooktop

Your cooktop is equipped with four induction cooking zones and a radiant heat warmer zone. The two left side zones can be combined using the bridge function that will accommodate oversized pots and an induction griddle.

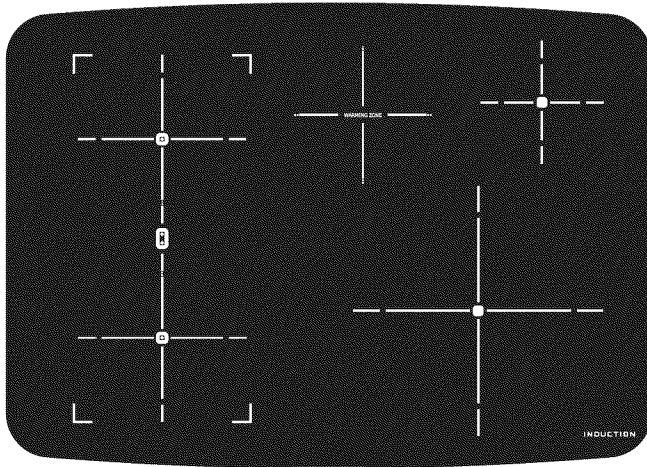

Figure 3: Induction cooktop heating zones

Induction cooking directly heats the pan; heating will only begin when cookware is properly placed on the cooking zones.

Pan sensing

The cooking zone sensors located below the cooktop surface require that certain cookware conditions are met before the induction cooking zones can operate.

The cooking zone display windows may display a pan sensing error message. If a cooking zone is activated and no cookware is detected, the affected induction cooking zone display window will flash with the last power level request setting. If the cookware does not meet the correct conditions, the cooking zones may not heat.

Minimum pan size

Induction cooking zones require a minimum pan size in order to activate. The graphics on each cooking zone location are your guide to the correct minimum pan size for that zone. The shorter lines guide the minimum pan size (Figure 3). The cookware bottom must meet the minimum area for the heating process to begin.

If a pan that is induction-capable is centered properly but is too small, the affected cooking zone display will flash the last power level setting and the pan will not heat.

When no pan is on the cooking zone or if the pan is not making proper contact, the last power level setting (**Power Boost shown here as an example in Figure 4**) will flash in the display. If the pan is not centered or if no pan is placed on the element, the affected cooking zone will automatically turn off after 3 minutes. It is recommended that you lower the requested power level setting before correcting the pan sensing message.

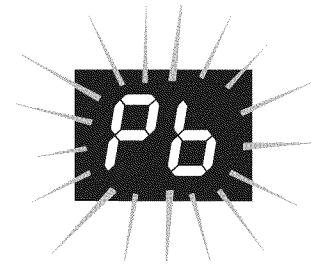

Figure 4: Pb flashes when pan is not making contact

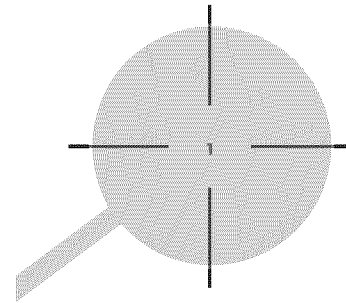

Figure 5: Proper pan placement. Cookware base material has good magnetic properties

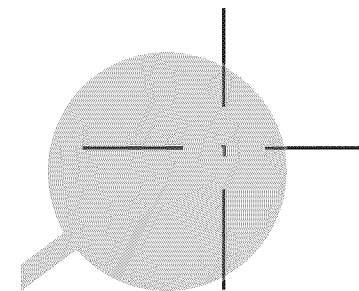

Figure 6: Improper pan placement causing Pb to flash. Cookware base material may not be magnetic.

When using the cooking zones

- Be sure to use cooktop cookware made with a magnetic base material.
- Use quality cooktop cookware with heavier bottoms for better heat distribution, allowing for more even cooking results.
- Check that cookware bottom rests level on cooktop surface. Cookware should have flat bottoms that make good contact with the entire induction cooking zone area.
- Check for flatness by rotating a ruler across the bottom of the cookware.
- Be sure cookware is properly balanced and does not tilt from a heavy handle.
- Be sure that the pan size matches the amount of food to be prepared. The size and type of cookware used will influence the setting needed for best cooking results.
- Never let cookware boil dry. This may cause permanent damage such as breakage, fusion, or marring that can affect the cooktop.
- Use cookware that meets the minimum and maximum cookware size requirements for each cooking zone.

Moving cookware on smoothtop

CAUTION Always lift cookware before moving on the ceramic glass smoothtop. Any cookware that has rough or dirty bottoms can mark and scratch the ceramic glass surface. Always start with clean cookware.

Sliding any type of cookware over the surface will scratch the cooktop over time (Figure 7). Scratches will make cleaning the ceramic cooktop difficult and degrade its appearance.

For more detailed information about the cooktop see “Cooktop maintenance” and “Cooktop cleaning” in the “Care and Cleaning” section.

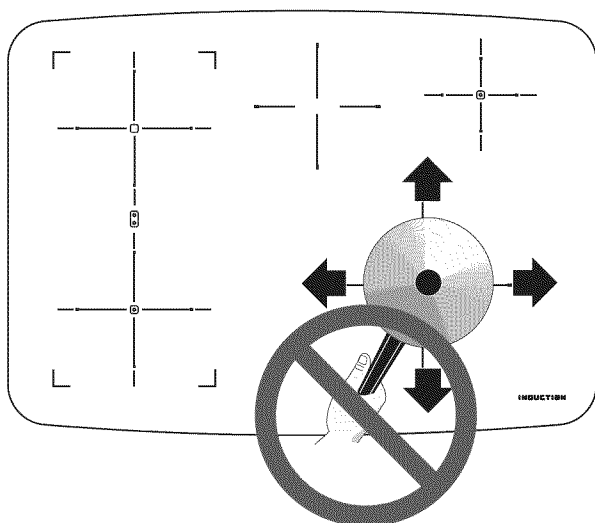

Figure 7: Do not slide cookware on cooktop

Hot cookware and residual heat

WARNING

Unlike radiant surface elements, the cooking zones will not glow red when they are hot. The glass surface may be hot from residual heat transferred from the cookware and burns may occur.

CAUTION

Do not touch hot cookware or pans directly with hands. Always use oven mitts or pot holders to protect hands from burns.

The type and size of cookware, cooking duration, the number of cooking zones in use and their power level settings are all factors that will affect the amount of heat that will spread beyond the cooking zones.

The induction cooking zones and areas surrounding the cooking zones may become hot enough to cause burns.

Home Canning

Be sure to read and observe all the following points when home canning with your appliance. Check with the USDA (United States Department of Agriculture) website and be sure to read all the information they have available as well as follow their recommendations for home canning procedures.

- Use only quality flat bottom canners when home canning. Use a straight-edge to check canner bottom (see Cookware Recommendations section).
- Use only a completely flat bottom canner with no ridges that radiate from the bottom center when home canning using a range with a ceramic glass cooktop.
- Make sure the diameter of the canner does not exceed 1 inch beyond the cooking zone markings.
- It is recommended to use smaller diameter canners on ranges with ceramic glass or open coil electric cooktops.
- Start with hot tap water to bring water to boil more quickly.
- Use the highest heat setting when first bringing the water to a boil. Once boiling is achieved, reduce heat to lowest possible setting to maintain that boil.

IMPORTANT! NEVER place or straddle a cooking utensil over 2 different surface cooking zones heating at the same time. This will cause uneven heating results and could cause the ceramic cooktop to fracture. The only exception is when using large cookware or the griddle with the bridge elements activated.

Oven vent location

The oven vent is located under the left side of the control panel. When the oven is operational, warm air will pass through this vent for proper air circulation and provides good baking results in the upper oven. Do not block this vent.

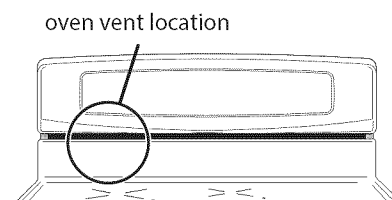
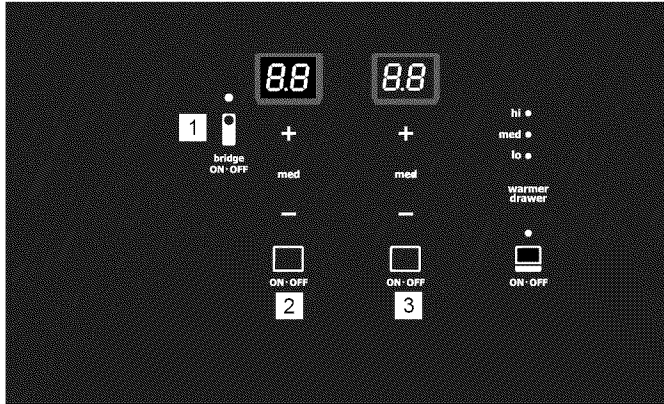
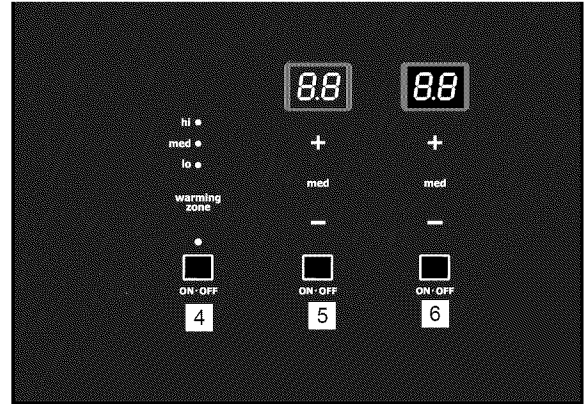

Figure 8: Do not block oven vent

SETTING SURFACE CONTROLS



- 1** Bridge feature using two 7 inch zones
- 2** Left front 7 inch induction zone
- 3** Left rear 7 inch induction zone



- 4** Warming zone element
- 5** Right rear 5 inch induction zone
- 6** Right front 10 inch induction zone

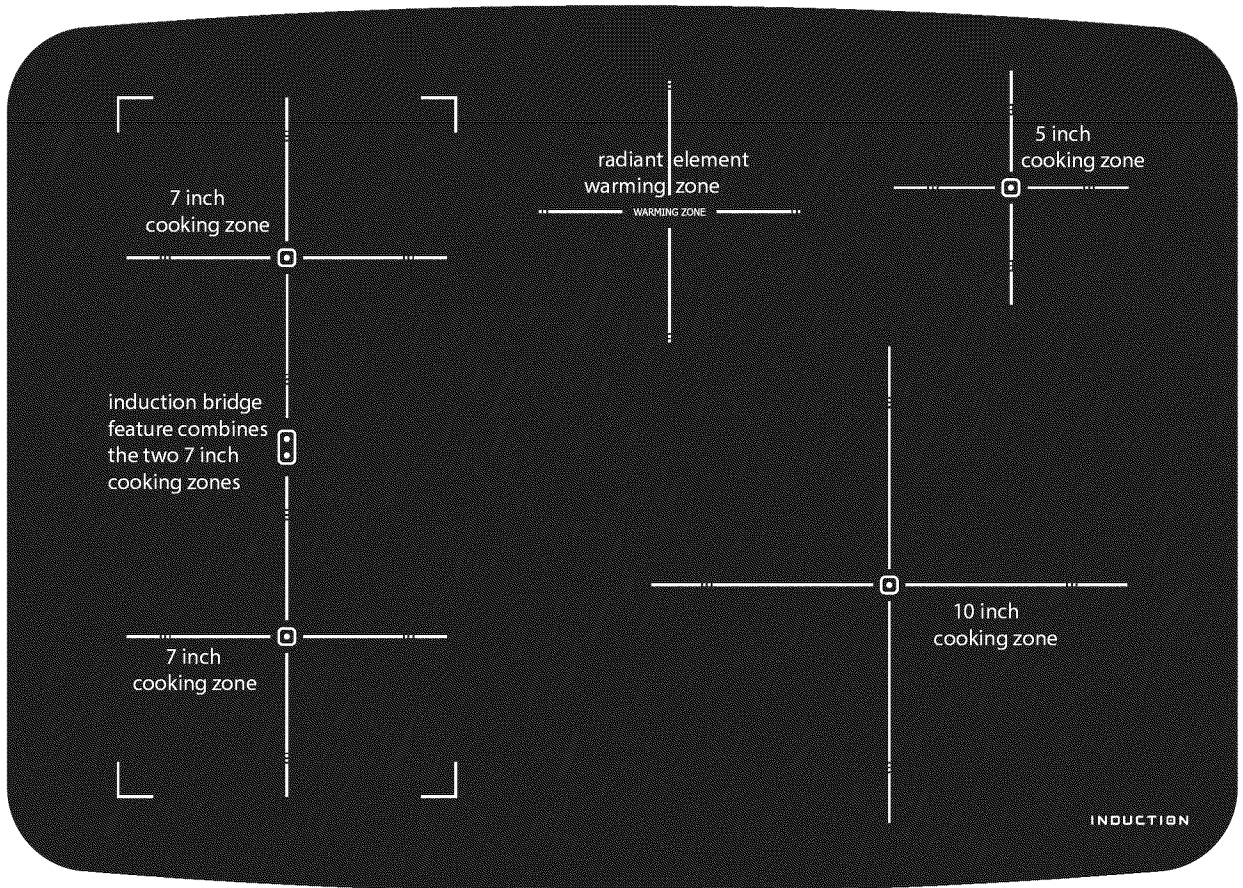

Cooktop power level settings

The surface control provides varied settings for each induction cooking zone. These power levels include **Lo**, **5.0** (medium), **Hi**, and **Power Boost (Pb)**.

The **+** and **-** keys provide incremental adjustments for precise control when changing surface settings.

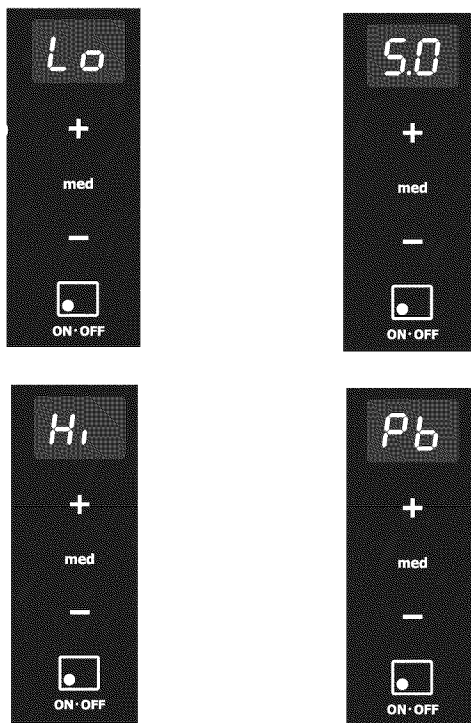

Figure 9: Power settings from Lo to Pb

Cooktop element display windows

The control panel has four digital display windows to show power levels for the cooking zones. Power levels are monitored using the window displays and controlled with the corresponding keys.

Available power settings

The control panel displays power level settings ranging from **Pb** (Power boost) (Figure 9) to **Lo**. The settings between **9.5** (Figure 11) and **3.0** (Figure 12) decrease or increase in increments of 0.5 (1/2). Settings between **2.8** (Figure 12) and **Lo** are simmer settings and decrease or increase in increments of 0.2.

IMPORTANT! The power boost (**Pb**) setting can only be accessed by pressing **ON-OFF** and then **+**. The **Pb** setting will remain active for ten minutes before automatically powering down to **Hi** unless the power is reduced using the **-** key.

Hot surface element message (HE)

After turning any of these elements **OFF**, the cooktop will remain HOT for some time. The corresponding **HE** message (Figure 14) will remain ON until that element position on the cooktop has cooled. The display will turn off when cool.



Figure 10: Power boost level



Figure 11: Hi power and 9.5 setting



Figure 12: 3.0 setting and 2.8



Figure 13: 1.2 setting and Lo (lowest setting)



Figure 14: Display showing OFF and Hot Element

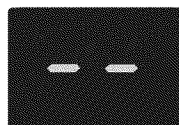

Figure 15: Cooktop lock and Sabbath mode messages

Cooktop lockout message (- -)

The (- -) message will appear in the display when the cooktop lockout feature is active (Figure 15) and during the **self clean** mode. Refer to the cooktop lockout instructions for more detailed information.

Sabbath Day feature (Sb) message

The display windows will show the (- -) message when the Sabbath Day feature is active (Figure 15). See "Setting the Sabbath mode" section for detailed instructions.

IMPORTANT!

Do not allow aluminum foil, plastic, or ANY material that can melt to make contact with the ceramic glass cooktop. If these items melt on the cooktop they can damage the ceramic cooktop.

Using the Power Boost level (Pb)

The power boost level is available on all four induction zones. The power boost setting is the highest level of induction cooking and can only be set by starting in the power boost setting. The power boost level is best for heating cookware that contain large amounts of food or to bring a large amount of water to boil.

To operate the power boost:

1. Press **ON-OFF** and then press **+**. **Pb** will appear in the display.
2. The power boost level will remain active for **ten** minutes and then automatically turn to the **Hi** level unless changed to a lower level.
3. To cancel **Pb** at any time press **ON-OFF**.

IMPORTANT! The power boost feature cannot be used as part of the bridge feature. If the power boost feature is desired on any induction zone that is already in use at a lower level, the control must be turned **OFF** before the **Pb** feature can be set as described above.

Using the bridge feature

The bridge feature combines the two 7 inch induction cooking zones to offer a large cooking surface for very large cookware and for using a griddle. The cookware must be large enough to cover both 7 inch induction zones located on the left side of the cooktop.

IMPORTANT! The bridge ON-OFF key must be pressed first before the bridge zones can be activated. Once set, the two zones will operate as a single unit when raising or lowering the power setting. If either bridge control is turned off, both induction zones will stop the cooking process.

To operate the bridge feature:

1. Make sure the cookware or griddle is covering both 7 inch induction zones.
2. Press **bridge ON-OFF**.
3. Press the **+** or **-** key to reach the desired power level. Remember that **Pb** is not available when using the bridge.
4. To turn off the bridge zone press **bridge ON-OFF**. The bridge can also be turned off by pressing the **ON-OFF** key on either of the induction zones connected by the bridge feature.

Using the griddle:

⚠ CAUTION

The griddle used on an induction cooktop will heat much faster than conventional cookware. Always use potholders to remove the griddle. Allow the griddle to cool before removing. Do not set hot griddle on surfaces that cannot withstand high heat (such as counter tops).

⚠ CAUTION

Never drop the griddle on the cooktop. Always place the griddle on the cooktop before turning on the power.

IMPORTANT! Always center the griddle over the bridge induction cooking zones. (figure)

Do not place the griddle's rubber feet directly on a cooking zone. Do not use the griddle in the oven or in a microwave.

Using the griddle:

The griddle is designed to be used only with the bridge feature and the two 7 inch induction cooking zones.

To cook using the griddle:

1. Place the griddle carefully over the two left induction cooking zones as illustrated in Figure 16.
2. Press **bridge ON-OFF**.
3. Press **+**, **med**, or **-** on either control to start the cooking process. The two zones will work as one single unit.
4. When bridge mode is active, adjusting either cooking zone will adjust both simultaneously.
5. To cancel cooking at any time press **bridge ON-OFF** or the **ON-OFF** key of either cooking zone.

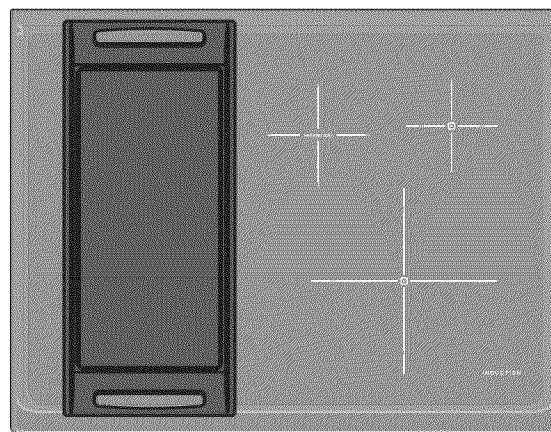
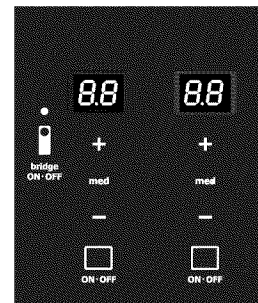

Figure 16: Griddle placed correctly using bridge feature

Recommended settings for using the griddle

| | |
|--|---|
| Eggs | Preheat for 3 minutes on setting 7 . Cook on setting 5 (med) . |
| Sausages, bacon or beef patties | Preheat for 2 minutes on setting 8 Cook on setting 5 (med) . |
| Pancakes | Preheat for 3 minutes on setting 5 (med) . Cook using setting 5 (med) . |

IMPORTANT! If the griddle setting is left on **Hi** for 10 minutes or longer, the cooking zone could automatically shut down to protect against overheating. If this occurs, **HE** will appear in the display. When using the cooktop, if **EO63/EO64** (error codes) appear in the display, let the griddle and the cooking zone cool down (about 15 minutes) until the cooktop can be used again.



To clean the griddle: Hand wash with a nylon brush and very hot water. If needed, use dish soap sparingly. Rinse well. Dry with lint free cloth. Do not use metal scouring pads. Do not clean in dishwasher. Store in a dry place.

Warming zone

The purpose of the warming zone is to maintain cooked foods at serving temperatures.

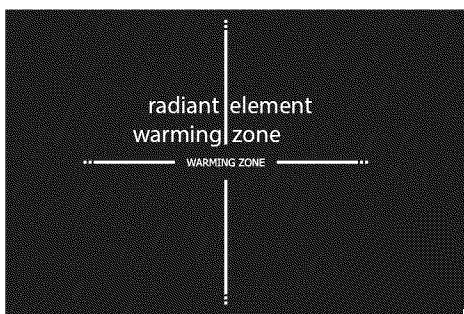

Figure 17: Warming zone in center rear of cooktop

Always start with hot, cooked foods. It is not recommended to heat cold food to serving temperatures. Foods like vegetables, gravies, casseroles, soups, stews, breads, and pastries work well on the warming zone. The warming zone works well for warming oven-safe dinner plates.

Warming zone temperature selection

Refer to the suggested settings when choosing a setting for food. If a particular food is not listed, start with the **med** setting and adjust as needed. Most foods may be kept at serving temperatures when using the **med** setting.

Suggested warmer zones settings

| Food item | Heat level |
|-------------------------|------------|
| Hot beverages | hi |
| Fired foods | hi |
| Vegetables | med |
| Soups (cream) and stews | med |
| Sauces and gravies | med |
| Meats | med |
| Eggs | lo |
| Dinner plates with food | lo |
| Casseroles | lo |
| Breads and pastries | lo |

IMPORTANT!

Use only plates, cookware, and utensils recommended for oven and ceramic cooktop use. Do not use plastic wrap or aluminum foil to cover foods. Plastic or aluminum foil may melt onto the ceramic cooktop

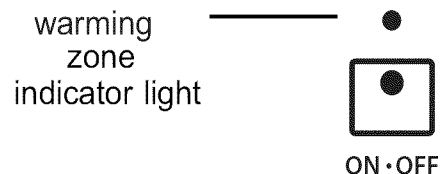

Figure 18: Warming zone indicator light glows when active

To operate the warming zone:

1. Place cookware on the warming zone.
2. Press **warming zone ON-OFF**. The warming zone indicator light will turn on. (Figure 18)
3. Press **warming zone** key until desired temperature setting is displayed. (Figure 19)



ON • OFF

warming zone

When finished press **ON-OFF**.



ON • OFF

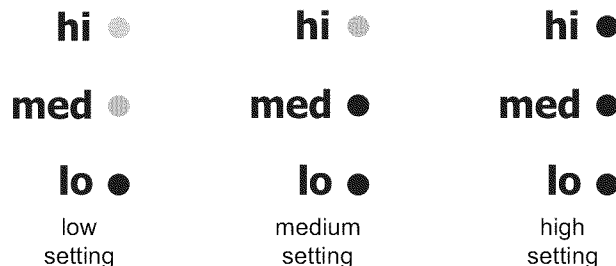

Figure 19: Warming zone settings

⚠ CAUTION

- Unlike other radiant elements on conventional ranges, the warming zone will not glow red when it is hot. To avoid possible burns always use potholders or oven mitts when moving food to and from the warming zone. Cookware or plates will be hot.
- Radiant surface elements may appear to have cooled after they have been turned off. The glass surface may still be hot and burns may occur if the glass surface is touched before it has cooled sufficiently.
- Do not place flammable items such as plastic salt & pepper shakers, spoon holders, plastic wrappings or aluminum foil on top of the range when it is in use. These items could melt or ignite. Potholders, towels or wooden spoons could catch fire if placed too close to the warmer zone.

BEFORE SETTING OVEN CONTROLS

Oven racks

CAUTION

Always use potholders or oven mitts when removing food or adjusting the oven racks. Wait until the oven has completely cooled if possible. Oven racks may be very hot and may cause burns.

Air circulation in the oven

For best air circulation when baking, allow a space of 2-4 inches (5-10 cm) around the cookware for proper air circulation. Be sure pans and cookware do not touch each other, the oven door, sides or back of the oven cavity.

Hot air must be able to circulate around cookware for even heat to reach the food.

The oven vent is located under the left side of the control panel. When the oven is operational, warm air will pass through this vent for proper air circulation and provide good baking results in the upper oven. Do not block this vent.

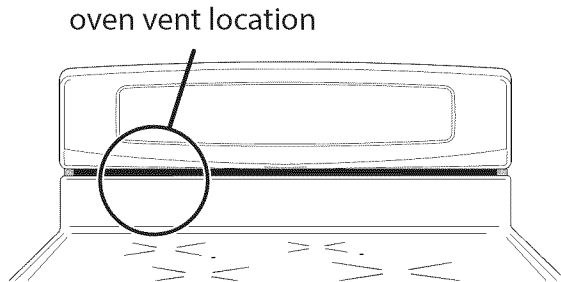

Figure 20: Oven vent

Removing and replacing flat or offset oven racks

- To remove - pull the oven rack straight forward until it reaches the stop position. Lift up front of oven rack slightly and slide out.
- To replace - place the oven rack on the rack guides on the oven walls. Tilt the front of the rack upward slightly and slide the oven rack back into place.

Flat oven racks may be used for most cooking needs and may be placed in most oven rack positions. (Figure 21)

The **offset oven rack** (Figure 22) provides additional step down positions from the standard flat rack design. The offset design positions the base of the rack about 1/2 of a rack position lower than the flat rack and may be used in most oven rack positions.

The fully extendable **Luxury-Glide™** oven rack (Figure 23) allows you to effortlessly extend your food away from the oven. See **Removing and Replacing the Luxury-Glide™ Oven Racks** for instructions.

The **bottom oven rack** (Figure 24) is used on the lowest rack position to maximize space for baking or roasting large cuts of meat.

Types of oven racks

Your appliance may be equipped with any one or more of the following rack types.

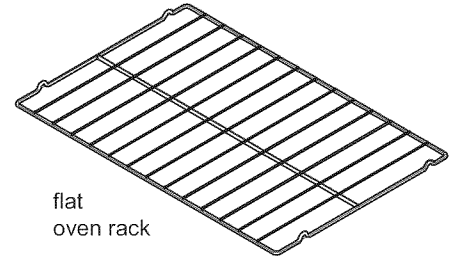

Figure 21: Flat rack for most baking

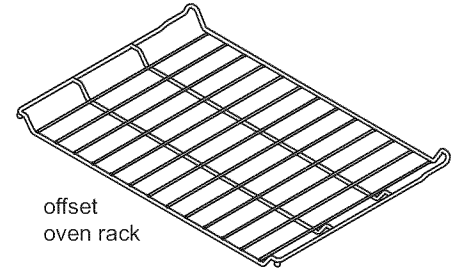

Figure 22: Offset to provide extra space for some foods

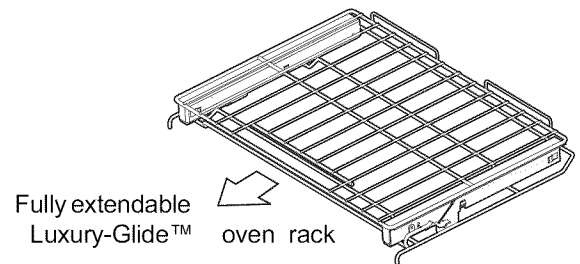

Figure 23: Luxury Glide rack

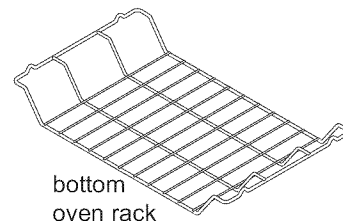

Figure 24: Bottom oven rack for extra large food items

Luxury Glide™ oven racks

IMPORTANT!

Remove ALL oven racks before starting a self clean cycle. If oven racks are left inside the oven during a cleaning cycle, the slide ability of the Luxury-Glide™ oven racks may be damaged and all of the oven racks will lose their shiny finish.

Clean oven racks according to the instructions provided in the Care & Cleaning section.

The fully extendable **Luxury-Glide™** rack makes food preparation easier. This oven rack has glide tracks that allow the rack to be pulled away from the oven without rubbing the sides of the oven wall.

Removing and replacing the Luxury-Glide™ oven racks

To remove - Using one hand, reach through handle opening and lift up on the release lever located across the lower front of the rack as shown in Figure 25.

While holding up the release lever, pull the glide rack out of the oven until the stop position is reached (Figure 26). Using both hands, grasp the upper and lower portions of the glide rack. Lift up the front of the rack slightly and continue to pull the rack away from the oven (Figure 27). Be sure to grasp both upper and lower rack portions together when removing or handling the glide rack.

The rack portions move independently and are difficult to handle unless held together.

To replace - grasp both upper and lower portions of glide rack, lift and hold the rack level between the oven cavity walls. Tilt the front of the rack upward slightly and slide the rack completely into position. Some force may be necessary to make sure the oven rack has snapped completely into place.

IMPORTANT!

To prevent possible damage to the oven, **DO NOT** attempt to close the oven door until all the oven racks are fully positioned back inside the oven cavity.

Luxury-Glide™ extendable oven rack

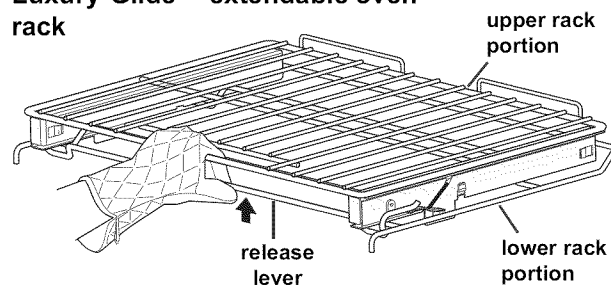

Figure 25: Luxury-Glide™ rack and release lever

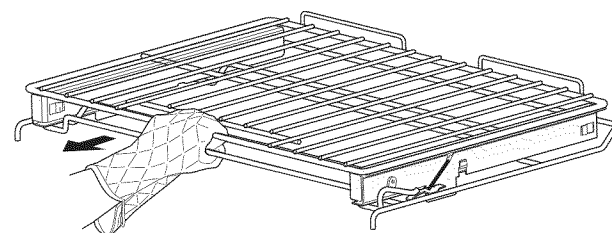

Figure 26: Gripping release lever and sliding rack

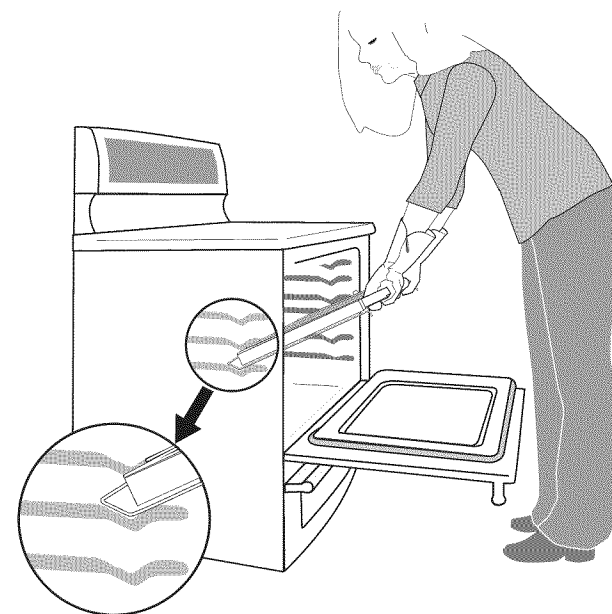
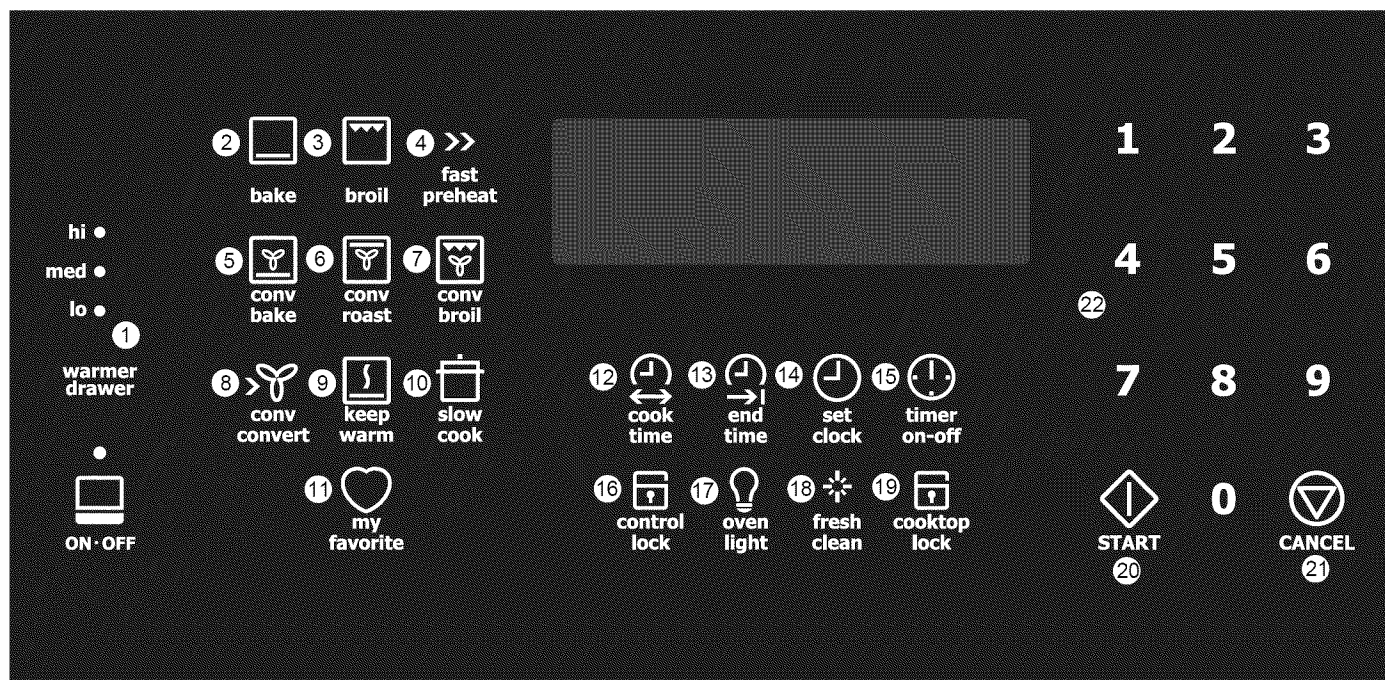

Figure 27: Removing the Luxury-Glide™ rack

SETTING OVEN CONTROLS



1. Warmer Drawer
2. Bake
3. Broil
4. Fast Preheat
5. Convection Bake
6. Convection Roast
7. Convection Broil
8. Convection Convert
9. Keep Warm
10. Slow Cook
11. My Favorite
12. Cook Time
13. End Time
14. Set Clock
15. Oven Timer
16. Control Lock
17. Oven Light
18. Fresh Clean (self-clean)
19. Cooktop Lock
20. Start
21. Cancel
22. Numeric Key Pad

Minimum and maximum control settings

| Feature | Minimum Temp | Maximum Temp |
|---------------|------------------|------------------|
| Fast Preheat | 170°F/76°C | 500°F/260°C |
| Bake | 170°F/76°C | 500°F/260°C |
| Broil | 400°/204°C | 550°F/288°C |
| Conv Bake | 300°F/148°C | 500°F/260°C |
| Conv Roast | 300°F/148°C | 500°F/260°C |
| Conv Broil | 400°F/205°C | 550°F/288°C |
| Keep Warm | 150°F/66°C | 190°F/88°C |
| Slow Cook | Lo (225°F/108°C) | Hi (275°F/135°C) |
| Warmer Drawer | Lo (150F°) | Hi (190F°) |

Minimum and maximum time settings

| Feature | Minimum Time | Maximum Time |
|-------------------|--------------|--------------|
| Timer | 1 min | 11 hr 59 min |
| Clock 12 hour | 1:00 hr | 11 hr 59 min |
| Clock 24 hour | 0:00 hr | 23 hr 59 min |
| Cook time 12 hour | 1 min | 11 hr 59 min |
| End time 12 hour | 1:00 hr | 12 hr 59 min |
| End Time 24 hour | 0:00 hr | 23 hr 59 min |
| Clean Duration | (2 hr) | (4hr) |

Setting the clock

When the appliance is powered up for the first time or when the electric supply to the appliance has been interrupted, the display will flash “12:00” (Figure 28).



Fig. 28 12:00 displayed when oven is powered up or power is restored after an interruption

To set the clock for 1:30:

1. Press **set clock**



2. Enter **130** using numeric keypad

130

3. Press **START** to accept



- Be sure to set the clock to the **correct time** of day before using the oven, especially when cooking with added time instructions.
- The clock cannot be adjusted while the oven is cooking, the timer is active, or during a self clean.
- If an invalid time of day is entered, the control will sound with a triple beep (error tone). Re-enter a valid time of day and press **START**. If **CANCEL** is pressed the clock will automatically set for **12:00**.

Changing clock display mode

The oven control is factory preset to display the time of day in the 12-hour clock setting. The display can be changed to a 24 hour clock setting or to the OFF mode.

When the clock display is turned off it continues to run and will function based on the previously set 12 or 24-hour setting.

To change clock display modes:

1. Press and **hold set clock** for 6 seconds



2. Press **set clock** to toggle between “12 hr Day- 24hr day” or “CLO OFF” display choices. Release key when desired mode displays (



3. Press **START** to accept



Fig. 29 Clock set for 12 hour mode



Fig. 30 Clock set for 24 hour mode



Fig. 31 Clock off mode



The clock display mode cannot be changed while the oven is active with any cooking function or during self-clean.

Changing Oven temperature display (°F or °C)

The oven control is factory preset to display oven temperatures with Fahrenheit (°F) values. The control may be changed to display temperatures in Celsius (°C) if desired.

To change the temperature display mode:

1. Press and hold **BROIL** key for 6 seconds. Release when F or C appears in display.
2. Press **BROIL** to toggle between F and C temperature display choices. When the desired mode appears in the display release the key.
3. Press **START** to accept.



broil



broil



START



The clock display cannot be modified while oven is active with any cooking function or during self-clean operation.

Changing between 12- Hour Energy Saving or continuous bake mode settings

The oven control is factory preset for a 12 HR Energy Saving mode. This setting automatically turns off any oven function after 11 hours and 59 minutes of non-stop cooking. The control may be set to override this feature if there is a need for cooking beyond 12 hours.

To change between 12 Hour Energy Saving and continuous bake settings:

1. Press and hold **timer on-off** for 6 seconds. Either **12 Hr Off** (Figure 32) or **Stay On** (Figure 33) will appear.
2. Press **timer** again to choose desired setting.
3. Press **START** to accept.



timer on-off



timer on-off



START



Fig. 32 Oven set for 12 Hr energy saving mode



Fig. 33 Oven set for continuous operation

Adjusting tone volume

A tone will sound when a key is pressed and also at the end of a cycle (timer, cook time, or end time). The factory audio setting is preset to the highest level (Figure 34). The volume may be adjusted for lower levels from 1 through 5, or can be turned off.

Level **Aud 5** is the highest setting, level 1 is the lowest setting (Figure 35) and **Aud OFF** (Figure 36) will provide a silent control setting.



Fig. 34 Tone volume highest level



Fig. 35 Tone volume lowest level



Fig. 36 Tone volume off

To adjust the audio tone level:

1. Press and hold **End Time** for 6 seconds. When **Aud** appears release the key.
2. To choose the different audio level continue to press **End Time** to toggle to the desired audio level and then release the key.
3. Press **START** to accept.



end time



end time



START



When the control is set for **Aud OFF**, error tones will remain audible.

Cooktop Lock

The cooktop lock will lockout the cooktop control keys. This **does not lock** the oven controls or lock the oven door. To lock the oven controls use the control lock feature.

To activate cooktop lock:

Press and hold **cooktop lock** for about 3 seconds. Once locked, **cooktop** and lock icon will appear (Figure 37). The cooktop power level display windows will show --(Figure 38).

To cancel the cooktop lock feature:

Press and hold **cooktop lock** key for 3 seconds. Once unlocked, **cooktop** and lock icon will no longer appear.



Fig. 37 Cooktop lock indicator

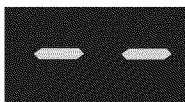

Fig. 38 Cooktop locked indicator in power level display windows

Oven control lock

The control lock will lock the oven controls and the oven door. This feature **does not lock** the cooktop controls. To lock the cooktop controls use the cooktop lock feature.

To activate the control lock:

Press and hold **control lock** key for about 3 seconds and release when the control beeps. **door Loc** will appear and remain in the display while the oven door locks (about 15 seconds) and remain until unlocked.

To cancel control lock:

Press and hold **control lock** key for 3 seconds until control beeps and release. Once the oven door unlocks, the **door Loc** message will no longer appear in the display (Figure 39).



Fig. 39 Oven door locked

- If an oven control key is pressed when oven lock is active, the oven will sound an error tone (triple beep) indicating the function is not available until the control lock feature is turned off.
- Do not attempt to force the oven door open when the **door Loc** message is displayed.

Timer

The timer can help timed cooking or food preparation times without interfering with any active cooking process. When the timer countdown reaches less than 1 minute, the display will show the time remaining in seconds. When the time runs out the timer will beep, **End** will display.

Timer settings:

- Minimum setting time: 1 minute
- Maximum set time: 11 hours 59 minutes

How to set the timer for 5 minutes:

1. Press **timer on-off**



2. Enter **5** minutes using numeric keypad

5

3. Press **START**



- To cancel an active timer press the **timer on-off** key. The timer **does not** start or stop the cooking process. The timer may be started alone or with any other active cooking feature.
- The timer will display hours and minutes until 1 hour remains. When less than one hour remains, the display will count down in minutes and seconds. Once the timer has less than 1 minute, only seconds will display.
- If both the oven and the timer are active, the timer information will display by default. To momentarily display information for any other active feature, press the corresponding key once to display the desired feature.

Fast Preheat

Use the Fast Preheat option for single rack baking to bring the oven to baking temperature. The fast preheat option can only be set using the Bake or Conv Bake features. Fast Preheat may be set with cook time or cook time with an end time. The following oven temperature settings apply for the Fast Preheat function:

- Factory default temperature: 350°F/176°C
- Minimum Fast Preheat setting: 170°F/77°C
- Maximum Fast preheat setting: 500°F/260°C

For best results

- Recommended for single rack cooking ONLY. Use oven rack position 2 or 3.
- For batter and dough-based baked goods such as cakes, pastries, and breads, use the standard bake function for best results.

To set Fast Preheat using the default oven temperature:

1. Press **BAKE** or **Conv Bake**



bake

conv
bake

2. Press **Fast Preheat**

fast
preheat

3. Press **START**



START

- When activated, the oven will begin preheating and **PRE** will appear in the display.
- A tone will sound indicating the oven has finished preheating. Place prepared food inside oven using a **single** oven rack.
- To stop preheating at anytime press **CANCEL**. How to set fast preheat with the oven temperature set for 425°F/218°C:

To set Fast Preheat with an oven temperature of 425°F/218°C:

1. Press **BAKE** or **Conv Bake**



bake

conv
bake

2. Enter **4 2 5** using numeric key-pads

425

3. Press **Fast Preheat**

fast
preheat

4. Press **START**



START

To stop **Fast Preheat** at any time press **CANCEL**.



The convection fan will rotate when the fast preheat is started. This is normal. If fast preheat is set with the bake feature the convection fan will turn off once the oven set temperature is reached.



To change temperature settings after fast preheat has started, press BAKE key, enter desired new temperature using the numeric keypad, then press START to accept.

IMPORTANT! Once the oven has fully preheated, the **fast pre-heat** feature will perform like bake and continue to bake until cancelled.

Bake

Use **BAKE** to cook most food items that require normal cooking temperatures. Bake may be set with the following options:

- Fast preheat
- Cook Time and Cook Time with End Time setting

The following oven temperature settings apply will to the **BAKE** feature:

- Factory default bake setting: 350°F/176°C
- Minimum bake setting: 170°F/77°C
- Maximum bake setting: 500°F/260°C

To set the oven for bake at the default oven temperature of 350°F(176°C):

1. Press **BAKE**. The default oven temperature of 350°F will appear in the display



2. Press **START**



Once **BAKE** is active the oven will begin preheating. When the oven reaches set temperature the control will sound a tone indicating the oven is ready.

To stop **BAKE** at any time press **CANCEL**

CAUTION Always use pot holders or oven mitts when working with a hot oven. When cooking, the oven interior, oven racks and cooktop will become hot enough to cause burns.

CAUTION

DO not cook foods directly on the oven bottom. To avoid damaging the oven interior and surfaces, always cook foods in the oven using cookware positioned on an oven rack

To set **BAKE** with oven temperature of 425°F/218°C:

1. Press **BAKE**



2. Enter 4 2 5 using numeric keypad

425

3. Press **START**



To stop **BAKE** at any time press **CANCEL**

- The convection fan will rotate when **BAKE** is first started. This is normal. The fan will turn off once the oven reaches the set temperature.
- A **cook time** setting may be added to a baking function any time after starting a bake. Refer to the **cook time section** for complete instructions.



If **BAKE** is active without a cook time setting, the oven will remain on for 12 hours before turning off automatically unless it is cancelled. To bake longer than 12 hours, see “Changing between 12- Hour Energy Saving or continuous bake mode settings” on page 18 for instructions.

For best results

- Place food items using oven rack positions 2 or 4. (Figure 40)
- When using an offset oven rack (some models), place in oven rack position 2 or 3.
- For best results when baking cakes using 2 racks, place cookware on oven rack positions 2 and 4. (Figure 41)
- When using 2 oven racks for baking, position cookware allowing 2-4 inches (5-10cm) of space between the food items to ensure proper circulation.
- Dark or dull pans and glass absorb more heat than shiny bakeware resulting in dark or over browning of foods. To prevent this it may be necessary to reduce the oven temperature or cook time to prevent over browning of some foods. Dark pans are recommended for pies. Shiny pans are recommended for cakes, cookies and muffins.
- Do not open the oven door too often. Opening the door will reduce the temperature in the oven.
- For batter and dough-based baked goods such as cakes, pastries, and breads, use the standard bake function for best results.

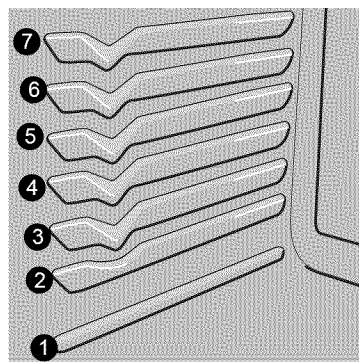

Fig. 40 Rack positions

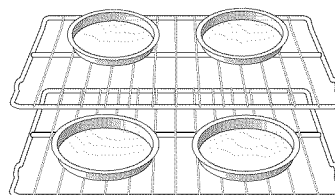

Fig. 41 Multiple rack pan spacing

Convection bake

Convection (conv) bake uses a fan to circulate the oven heat evenly and continuously (Figure 42). The improved heat distribution allows for even cooking with excellent results. Multiple rack cooking may slightly increase cook times for some food types, but the overall result will be time saved.

The conv bake feature should only be used when your recipe instructions have been written especially for convection baking.

If your recipe instructions are for baking and you wish to use conv bake, follow the conv convert option instructions. The conv convert option will automatically adjust the oven temperature so that convection baking will provide the best possible results.

Benefits of convection bake:

- Superior multiple oven rack performance.
- Foods cook more evenly.
- No special pans or bake ware required.

Conv bake may be set with the following options:

- Conv convert
- Fast preheat
- Cook time or cook time with end time settings

The following temperature settings apply to the conv bake feature:

- Factory default setting: 350°F/176°C
- Min. bake setting: 170°F / 77°C
- Max. bake setting: 500°F / 260°C

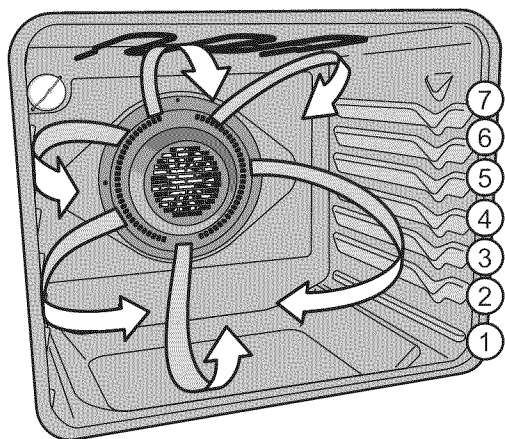

Fig. 42 Air circulation in convection mode

To set convection bake with the factory default temperature of 350° (176°):

1. Preheat oven if needed
2. Press **conv bake**
3. Press **START**



When activated, the control display will show **CONV BAKE** (Figure 43) and the oven will begin heating. Once the oven reaches the set temperature a tone will sound indicating the oven is ready.



Fig. 43 Display showing active convection bake

To stop conv bake at anytime press **CANCEL**.



When baking with a single rack use rack positions 2 or 3. When using 2 racks use rack positions 2 and 4. When using 3 racks use rack positions 2, 3 and 5.

- Layer cakes will have better results using the normal bake feature. For best results it is recommended to preheat the oven before baking items like cookies, biscuits and breads.
- Cookies and biscuits should be baked on pans with no sides or very low side to allow heated air to circulate around the food. Food items baked on pans with a dark finish will cook faster.
- When placing multiple food items in the oven allow 2-4 inches (5-10cm) of space between the food items for proper air circulation.
- For multiple-rack convection baking, place items on racks as shown in Figure 44.

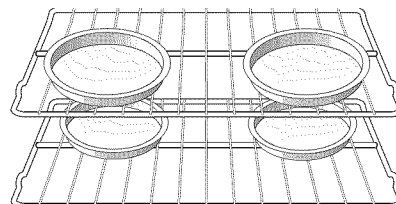

Fig. 44 Pans spaced for convection baking

Convection convert

The convection (conv) convert feature allows you to convert any normal baking recipe into a convection bake recipe. The control uses the normal recipe settings and adjusts to a lower temperature for convection baking. Conv convert must be used with conv bake. Conv convert may be set with cook or end time instructions.

Benefits of convection convert:

- Superior multiple oven rack performance.
- Some foods cook faster, saving time and energy.
- No special pans or bake ware required.

To set conv convert with the factory default oven temperature of 350°F (176°C):

1. Press **conv bake**



2. Press **conv convert**



When activated, the control display will show **CONV BAKE** and the oven will begin heating. Once the oven reaches the set temperature a tone will sound indicating the oven is ready.

To stop **conv convert** at anytime press **CANCEL**.



When using **conv convert**, cook time reductions may vary depending on the oven temperature setting.

- **Conv convert** reduces original temperatures by 25°F (14°C).
- The conv convert feature will work best if cook time is 20 minutes or longer. If setting a cook time that is under 20 minutes, the feature will not provide a **CF** (check food) message.

To set conv convert for 30 minutes with a temperature setting of 375°F (191°C):

1. Press **COOK TIME**



2. Enter **30** using numeric keypad

30

3. Press **START**



4. Press **CONV BAKE**



5. Enter **375** using numeric keypad

375

6. Press **conv convert**



When conv convert is used with cook time or end time settings, the conv convert feature will display a **CF** for check food when the cook time is 75% complete (Figure 45). At this time the oven control will provide one long tone at regular intervals until the set cook time has finished or conv convert is canceled.

To stop **conv convert** at anytime press **CANCEL**.



Fig. 45 Check food reminder when using conv convert

For best results:

- When baking with a single rack use rack positions 2 or 3. When using 2 racks use rack positions 2 and 4. When using 3 racks use rack positions 2, 3 and 5.
- For best results it is recommended to preheat the oven before baking items like cookies, biscuits and breads.
- Cookies and biscuits should be baked on pans with no sides or very low side to allow heated air to circulate around the food.
- Food items baked on pans with a dark finish will cook faster.
- When placing multiple food items in the oven allow 2-4 inches (5-10cm) of space between the food items for proper air circulation.

Cook Time

The cook time feature is used when a recipe calls for a specific temperature and cook time. Following the recipe's suggested cook time can help ensure the best possible results.

The maximum cook time setting is 11 hours, 59 minutes. Cook time instructions may be set with Bake, Conv Bake, Conv Roast, Slow Cook, Keep warm, Fast Preheat, and My Favorite.

To bake for 30 minutes with the oven at default temperature setting of 350°F (176°C):

1. Press **Cook Time**



2. Enter **30** using numeric keypads

30

3. Press **START**



4. Press **BAKE**



5. Press **START**



Once active, the oven display will show TIMED and BAKE. The oven will bake at the set temperature for the full 30 minutes and then automatically shut off. The timed bake can be ended at any time by pressing CANCEL.

When the cook time runs out:

End will appear in the display window and the oven will shut off automatically. The control will beep three times and repeat the end tones every 30 seconds until the **CANCEL** is pressed.

To stop cooking at any time press **CANCEL**.

FOOD POISONING HAZARD. Do not let food sit for more than one hour before or after cooking. Doing so can result in food poisoning or sickness.

IMPORTANT! When using a timed cooking function it is possible to check how much cooking time remains. Press the **cook time** key once to momentarily display any remaining cook time. During cooking where cook time settings are being used, the **cook time** can be removed at anytime by pressing **cook time** and setting a new time of **0:00** using the numeric keys.

IMPORTANT! **Cook Time** settings are not allowed in the **BROIL** or **Self-Clean** features.

⚠ CAUTION

Use caution when preparing foods with cook time and end time instructions. Foods that can easily spoil such as milk, meat, fish or poultry, should be chilled in the refrigerator first. Even when chilled, they should not stand in the oven for more than one hour before cooking begins, and should be removed promptly when cooking ends.

Setting cook time with end time

Adding a cook time with a specific end time allows the user to control exactly when the cooking process will begin and end.

Cook time and end time instructions may be set with Bake, Conv bake, Conv Roast, Slow Cook, and Keep Warm.

Before setting end time instructions be sure the time of day is set correctly on the oven clock.

To set the oven to BAKE at 375°F (191°C) for 50 minutes and to automatically shut off at 5:30:

1. Press **COOK TIME**



2. Enter **50** using the numeric keypad

50

3. Press **START**



4. Press **END TIME**



5. Enter **5 3 0** using numeric keypad

530

6. Press **START**



7. Press **BAKE** (Figure 1)



8. Enter **375** using numeric keypad

375

9. Press **START** to activate



Fig. 46 Timed bake setting

Once **START** is pressed, the oven will calculate the delayed start time. When the delayed starting time passes, the oven will automatically turn on and heat to the set temperature. The oven will maintain the set temperature throughout the set cook time until the set end time cancels the cooking function.

When cook time runs out:

End will appear in the display window and the oven will shut off automatically. The control will beep 3 times every 30 seconds until **CANCEL** is pressed.

To stop cooking at any time press **CANCEL**.

Broil

Use the BROIL feature to cook meats that require direct exposure to radiant heat for optimum browning results.

⚠ WARNING

Should an oven fire occur, **close the door**. If the fire continues, throw baking soda on the fire or use a fire extinguisher. **DO NOT put water or flour on the fire**. Flour may be explosive and water can cause a grease fire to spread possibly causing personal injury.

⚠ CAUTION

Always use pot holders or oven mitts when working with a hot oven. When broiling, the oven interior, oven racks and cooktop will become **hot** enough to cause burns. **DO NOT** use the broiler pan without the insert. **DO NOT** cover the broil pan / insert with aluminum foil; the exposed grease could ignite.

⚠ CAUTION

To prevent food from contacting the broil element and to prevent grease splattering, use the broil pan and insert when broiling.

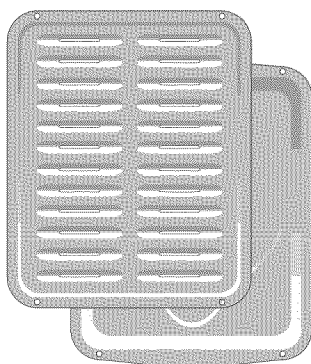



Fig. 47 Broil pan and insert

- For optimum browning results, allow the oven to preheat for 5-6 minutes before placing meat in the oven. To avoid burning food, watch the food carefully when broiling and turn meat when needed.
- Use the recommended pans and oven rack positions for the type and amount of meat being prepared. See *Broiling Table on the next page*.

Recommended broiling times

Use the broiling table (Table 1) for approximate recommended broiling times for the types of meat listed. Depending on the type, the thickness, and the desired doneness of meat, it might be necessary to increase or decrease broiling times or adjust the broiling pan to different rack positions. If the food you are broiling is not listed in the table, follow the instructions provided in your recipe and watch the broiling process closely.

To set broil with the factory default temperature setting of 550°F / 288°C:

1. Place the broiler insert on the broiler pan, then place the meat on the insert. Remember to follow all warnings and cautions.
2. Arrange the interior oven rack to rack position recommendations. See Table 1 and Figure 49. Be sure to place the pan with the meat directly under the broil element. **Leave the oven door open** in the broil position. (Figure 48)
3. Press **BROIL** 
 broil
4. Press **START** 
 START
5. Turn meat when the first side is browned to the desired amount.

Once activated, the oven display will show **BROIL** and will broil at the set temperature until cancelled.

To stop **BROIL** at anytime press **CANCEL**.

The broil pan insert has slots that allow grease and fat from the meat to drain into the broiler pan. (Figure 47)

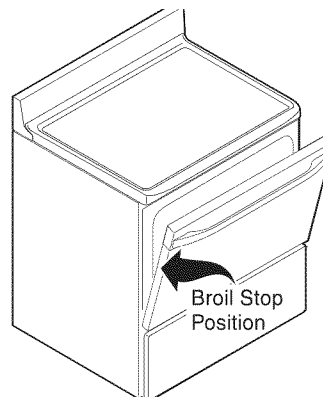

Fig. 48 Door stop for normal broiling

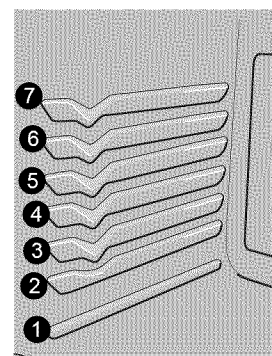

Fig. 49 Rack positions

Convection broil

Use the convection broil feature to cook thicker cuts of meats that require direct exposure to radiant heat and the convection fan for optimum browning results.

To set convection broil with a default oven set temperature of 550°F (288°C):

1. Press **conv broil**



2. Press **START** to accept



The convection fan will begin rotating once conv broil has been activated and oven door is closed.

To stop convection broil at any time press **CANCEL**.

For best results:

- Be sure to carefully follow all the recommended broil pan and insert instructions and the directions for placing the oven racks as provided in the broil section.
- Since convection broil cooks food faster, reduce the cook time by 25% from the recommended cook time of your recipe (check the food at this time). If necessary, increase cook time until the desired doneness is obtained.
- Close the oven door when using convection broil.

Table 1: Broiling Recommendations

| Food | Rack Position | Temperature | Cook time in minutes, 1st side | Cook time in minutes, 2nd side | Doneness |
|-----------------------|---------------|-------------|--------------------------------|--------------------------------|-------------|
| Steak 1" thick | 5th or 6th* | 550°F | 6 | 4 | Medium |
| Steak 1" thick | 6th or 7th* | 550°F | 7 | 5 | Medium-well |
| Steak 1" thick | 6th or 7th* | 550°F | 8 | 7 | Well |
| Pork Chops 3/4" thick | 6th | 550°F | 8 | 6 | Well |
| Chicken bone-in | 5th | 450°F | 20 | 10 | Well |
| Chicken boneless | 6th | 450°F | 8 | 6 | Well |
| Fish | 6th | 500°F | 13 | n/a | Well |
| Shrimp | 5th | 550°F | 5 | n/a | Well |
| Hamburger 1" thick | 7th | 550°F | 9 | 7 | Medium |
| Hamburger 1" thick | 6th | 550°F | 10 | 8 | Well |

Use the off-set rack if you choose to use an oven rack in position 7

Convection roast

Convection (conv) roast combines a cook cycle with the convection fan and element to rapidly roast meats and poultry. Heated air circulates around the meat from all sides, sealing in juices and flavors. Meats cooked with this feature are crispy and brown on the outside while staying moist inside. There is no need to reduce the oven temperature when using conv roast.

Conv roast may be set with the following options:

- Cook time
- Cook time with end time

The following oven temperature settings apply for conv roast:

- Factory default temperature: 350°F/176°C
- Min. conv roast setting: 170°F/76°C
- Max. conv roast setting: 500°F/260°C

Benefits of conv roast:

- Superior multiple oven rack performance
- Some foods will cook faster, saving time and energy

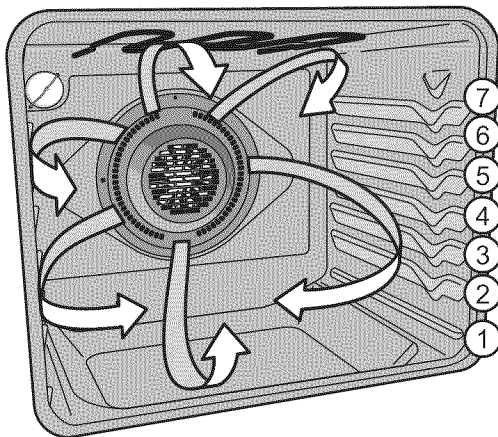

Fig. 50 Air circulation for convection cooking

To set conv roast with the factory default oven temperature setting of 350°F (176°C):

1. Press **CONV ROAST**



2. Press **START**



When activated, the control display will show **CONV ROAST** and the oven will begin heating. Once the oven reaches the set temperature a tone will sound indicating the oven is ready.

To stop conv roast at anytime press **CANCEL**.



Preheating for conv roast will not be necessary for most meats and poultry.

- Arrange oven racks so the food is in the center of the oven.
- Since **conv roast** cooks faster, reduce cook times by 25% from the recommended time of your recipe (check the food at this time). Then if needed, increase cook time until the desired doneness is obtained.
- Place food items using the recommended rack positions for the type of food being prepared.
- Be sure to carefully follow your recipe's temperature and time recommendations or refer to the conv roast recommendations for additional information. See Table 2, "Convection roasting temperature and time recommendations," on the next page.
- Do not cover foods when dry roasting - covering will prevent the meat from browning properly.

Convection roast (cont'd)

When cooking meats using convection roast, it is recommended to use the broiler pan and insert. The broiler pan will catch grease spills and the insert helps prevent grease splatters.

To properly arrange food for roasting:

1. Place oven rack on bottom or next to the bottom oven rack position.
2. Place the insert on the broiler pan.
3. Make sure the insert is securely seated on top of the broiler pan. Do not use the broiler pan without the insert. DO NOT cover the insert with aluminum foil.
4. Place meat (fat side up) on insert (Figure 51). Place prepared food on oven rack and slide into oven.

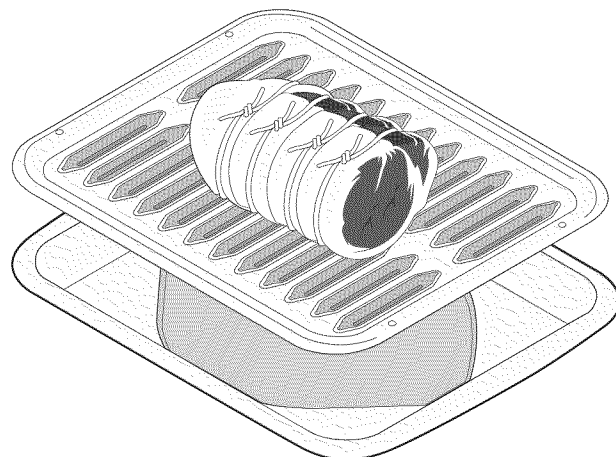

Fig. 51 Broil pan and insert for convection roast

Table 2: Convection roasting temperature and time recommendations

| Meat | | Weight | Oven Temp | Internal Temp | Minutes per lb. |
|---------|----------------------|---------------|-------------|---------------|-----------------|
| Beef | Standing rib roast* | 4 to 6 lbs. | 350°F | * | 25-30 |
| | Ribeye Roast* | 4 to 6 lbs. | 350°F | * | 25-30 |
| | Tenderloin roast | 2 to 3 lbs. | 400°F | * | 15-25 |
| Poultry | Turkey whole** | 12 to 16 lbs. | 325°F | 180°F | 8-10 |
| | Turkey whole** | 16 to 20 lbs | 325°F | 180°F | 10-15 |
| | Turkey whole** | 20 to 24 lbs. | 325°F | 180°F | 12-16 |
| | Chicken | 3 to 4 lbs. | 350°F-375°F | 180°F | 12-16 |
| Pork | Ham roast, fresh | 4 to 6 lbs. | 325°F | 160°F | 30-40 |
| | Shoulder blade roast | 4 to 6 lbs. | 325°F | 160°F | 20-30 |
| | Loin | 3 to 4 lbs. | 325°F | 160°F | 20-25 |
| | Pre-cooked ham | 5 to 7 lbs. | 325°F | 160°F | 30-40 |

* For beef medium 160°F. well done 170°F

** Stuffed turkey requires additional roasting time. Shield legs and breast with foil to prevent over browning and drying of the skin.

Keep warm

Use the keep warm feature to keep hot foods warm. Keep warm may be set with the following options:

- Cook Time
- Cook Time with End Time

⚠ WARNING

FOOD POISONING HAZARD. DO NOT let sit for more than one hour before or after cooking. Doing so may cause bacteria to grow which can result in food poisoning or other illness.

To prevent food from contacting the broil element and to prevent grease splatter, **DO NOT** use the roasting rack when broiling.

The following temperature settings apply to the keep warm feature:

- Auto-suggest default setting 170°F / 76°C
- Minimum Keep Warm setting 150°F / 66°C
- Maximum Keep Warm setting 190°F / 88°C

To set keep warm with the default setting:

1. Press **keep warm**



2. Press **START**



To set keep warm with a setting of 150°F:

1. Press **keep warm**



2. Enter **150** using numeric keypad

150

3. Press **START**



If changing cooking times, select the **cook time** or **end time** keys needed to make changes.

To end Keep Warm at any time press **CANCEL**.

Temperature selection

See the recommended settings chart below for keep warm. If a particular food is not listed, use the default temperature of 170°F. If more crispness is desired, remove the lid or aluminum foil from the food. Most foods can be kept at serving temperatures at 170°F. When a combination of foods are to be kept warm (for example a meat with 2 vegetables and rolls) use 170°F.

Table 3: Keep Warm Recommended Food Settings

| Food Item | Heating Level |
|-------------------------|---------------|
| Hot Beverages | 190°F |
| Fried Foods | 190°F |
| Vegetables | 170°F |
| Soups (Cream) & Stews | 170°F |
| Sauces and Gravies | 170°F |
| Meats | 170°F |
| Eggs | 150°F |
| Dinner Plates with Food | 150°F |
| Casseroles | 150°F |
| Breads/Pastries | 150°F |

Slow cook

The slow cook feature is used to cook foods slowly using lower temperatures. The cooking results will be much like that of a slow cooker. This feature is ideal when roasting beef, pork or poultry.

Slow cook may be set with the following options:

- Cook time
- Cook time with End time

The following temperature settings apply to the slow cook feature:

- High: 275°F / 134°C use for cooking 4 to 5 hours
- Low: 225°F / 108°C use for cooking 8 to 9 hours

To set Slow Cook with low setting:

1. Position oven racks and cookware in oven. Close the oven door.
2. Press **Slow Cook** key. HI will appear in the oven display indicating the default setting is for high heat. If a low setting is needed, press Slow Cook again to select the **LO** setting and release.
3. Press **START**



Fig. 52 Slow cook high shown active

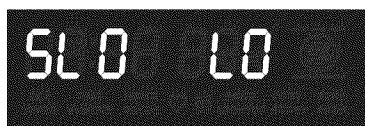

Fig. 53 Slow cook low shown active

To stop slow cook at any time press **CANCEL**.

To add or change any cook settings after slow cook has started:

1. Press **slow cook**.
2. To change the setting, press the **slow cook** again to toggle between the **Hi** or **Lo** setting and release.
3. Press **START** to accept change.



If changing cooking times, select the cook time or end time keys to make the needed changes.

- Slow cooking meats may result in the outside of the meat turning dark; this is normal.
- Completely thaw all frozen foods before cooking
- Arrange food in center of oven.
- Position multiple racks to accommodate size of cooking utensils when cooking multiple food items.
- Add any cream or cheese sauces during the last hour of cooking.
- Do not frequently open the oven door or leave the oven door open when checking food items. The more heat that is lost, the longer the food will need to cook.
- Cover foods to keep them moist or use a loose or vented cover to allow foods to turn crisp or brown.
- Roasts may be left uncovered so browning can occur. Cook times will vary depending on the weight, fat content, bone & the shape of the roast.
- Preheating the oven is not necessary.

Using the warmer drawer

The lower warmer drawer is ideal for warming foods such as pizza, casseroles, baked potatoes and frozen convenience foods. Use the warmer drawer to keep hot cooked foods at serving temperature. The warmer drawer may also be used to warm dinner plates.

⚠ WARNING

Keep children away from the warmer drawer when hot. Failure to do so can result in burns.

⚠ CAUTION

Always use oven mitts when removing food from the warmer drawer. The warmer drawer rack, compartment, cookware, and plates may be hot.

Should a fire occur, close the drawer and turn the lower drawer OFF. If the fire continues, use a fire extinguisher. Do not put water or flour on the fire. Flour may be explosive.

Recommendations for the warmer drawer

- When placing food in the warmer drawer always use a baking sheet or pan with 4 raised sides to prevent food from sliding off.
- DO NOT LINE THE WARMER DRAWER WITH FOIL OR COVER THE RACK WITH FOIL. This may result in damage to your oven.
- The maximum height of foods and utensils that may be used in the warmer drawer is 4". The maximum width is 15".
- Pay close attention to foods that have potential to rise beyond the recommended 4" maximum height.
- Use pans in the warmer drawer large enough to contain food and any juices created from the cooking process.
- Do not use plastic wrap to cover food. Plastic may melt onto the drawer or surrounding areas and be very difficult to clean.
- Use a lid or aluminum foil instead. Use only utensils and cookware in the warmer drawer that are recommended for oven use in the upper oven.

FOR BEST RESULTS

- For best results with the warmer drawer, pastries, casseroles with crumb toppings and bakery type items should be cooked in the upper oven.
- When using the warmer drawer, limit the number of times the drawer is opened; this will minimize heat loss. Repeated opening of the drawer during the warming process may produce uneven results.

Arranging warmer drawer rack positions

The warmer drawer rack may be used two ways:

- In the upright position (See Fig. 1) to allow low profile food items to be placed both under and on top of the rack (for example, rolls or biscuits on top of the rack and a casserole dish underneath).
- In the downward position (See Fig. 2) to allow for light weight food items and empty cookware (for example, rolls or pastries and dinner plates) on the rack.

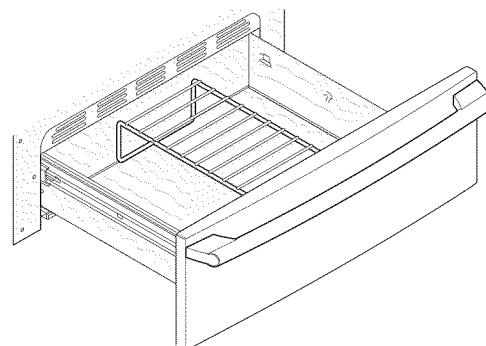

Figure 54: Rack in up position

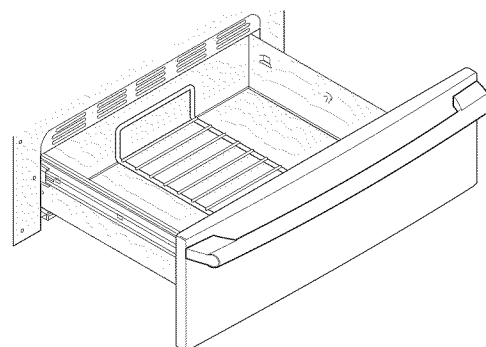

Figure 55: Rack in down position

⚠ WARNING

FOOD POISONING HAZARD. Do not let food sit for more than one hour before or after cooking. Doing so can result in food poisoning or sickness.

NOTES

- The warmer drawer will not operate when the upper oven is set for self-cleaning or the control lock feature is active.
- If the warmer drawer is ON and a self-clean or control lock request is attempted, the oven control will deny the request with a triple beep.

Temperature selection

See the recommended settings chart below. If a particular food is not listed, use the default temperature of 170°F. If more crispness is desired, remove the lid or aluminum foil from the food. Most foods can be kept at serving temperatures at 170°F. When a combination of foods are to be kept warm (for example a meat with 2 vegetables and rolls) use 170°F.

Warmer Drawer Recommended Food Settings

| Food Item | Heating Level |
|-------------------------|---------------|
| Hot beverages | hi |
| Fried foods | hi |
| Vegetables | med |
| Soups (Cream) | med |
| Stews | med |
| Sauces | med |
| Meats | med |
| Gravies | lo |
| Eggs | lo |
| Dinner plates with food | lo |
| Casseroles | lo |
| Breads and pastries | lo |

Warmer drawer indicator light

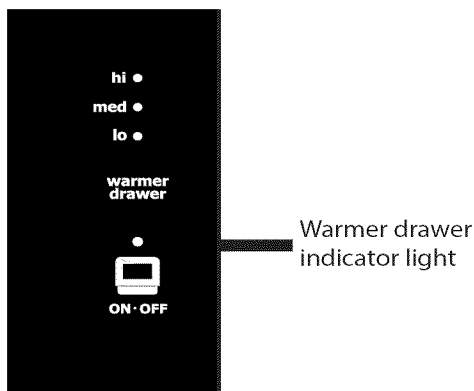

Figure 56: Control showing warmer drawer indicator light

Setting the warmer drawer

To set warmer drawer to hi:

1. Arrange the warmer drawer rack in the UP or DOWN position to accommodate the items being warmed.
2. Press **ON-OFF** and the warmer drawer indicator light will turn on and flash. (Figure 56).



ON-OFF

3. Press **warmer drawer**. The **lo** indicator light will turn on. To change the setting, continue to press **warmer drawer** to toggle between **lo**, **med**, and **hi**. (Figure 57)
4. Once warming is finished, press **ON-OFF** to turn off the warmer drawer.



ON-OFF

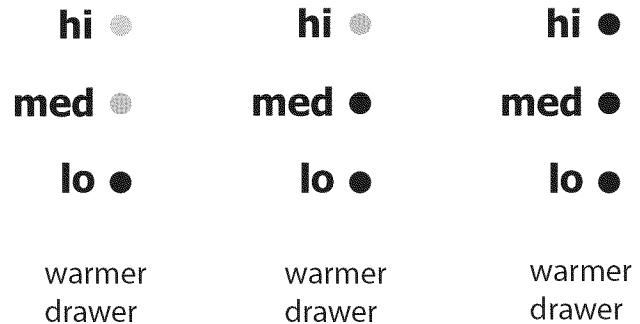

Figure 57: Warmer drawer settings

Warmer drawer cleaning tips





For easier clean-up, the warmer drawer should be cleaned as soon as the drawer cools down. Clean after each use to minimize build-up of spatter and food leftovers. When cooking foods that spatter, cover the food with heatproof lid or foil. Use a mild detergent and water to clean the warmer drawer and sides. For stubborn soils use a nonabrasive cleaning pad to remove soils. DO NOT use oven cleaners on the warmer drawer cavity.

My Favorite

The my favorite feature stores and recalls a favorite recipe setting. This feature will only store or recall one favorite recipe at a time.



My favorite feature may be used with bake, cook time, conv bake, conv roast and keep warm cooking features. This feature will not work with any other feature including end time, broil or self clean.

To set a favorite recipe (example: bake for 30 minutes with oven temperature of 325°F):

1. Press **cook time** 
2. Enter **30** minutes using numeric keypads **30**
3. Press **START** 
4. Press **BAKE** 
5. Enter **3 2 5** oven temperature using numeric keypad **325**
6. Press **START** 
7. To store, press and hold my favorite key for 3 seconds and release when you hear acceptance tone 

The recipe is now set. If you do not wish to continue cooking at this time using the newly stored recipe, be sure to press **CANCEL**

To use a saved favorite recipe setting:

1. Press **my favorite** key. The favorite icon will appear in the display. 
2. Press **START** 

To erase a favorite recipe setting:

- Press **my favorite** and hold until the favorite icon disappears from the display. 

- If you do not wish the oven to automatically start the recipe when saving my favorite, be sure to press **CANCEL** for the last step.
- If a different favorite recipe is needed, you may record a new recipe over the old.

Adjusting the oven temperature

Your appliance has been factory calibrated and tested to ensure accurate baking temperatures. For the first few uses, follow your recipe times and temperature recommendations carefully. If you think the oven is cooking too hot or too cool for your recipe times, the control may be adjusted so the oven cooks hotter or cooler than the temperature displayed.

The oven temperature may be increased +35°F (+19°C) or decreased -35°F (-19°C) by adjusting the **user programmable offset (UPO)**.

IMPORTANT! Do not use oven thermometers such as those found in grocery stores to check the temperature settings inside your oven. These oven thermometers could vary as much as 20° to 40° from actual oven temperatures.

How to offset the oven temperature by +30°F:



1. Press and hold **BAKE** for 6 seconds and release when acceptance tone sounds. **UPO** will appear in the display. 
2. Enter **3 0** using numeric keypad (Figure 58). **30**
3. To accept change, press **START** 



Fig. 58 Oven temperature set 30° higher than default

How to offset the oven temperature by -30°F:





1. Press and hold **bake** for 6 seconds and release when acceptance tone sounds. **UPO** will appear in display. 
2. Enter **3 0** using the numeric keypad (Figure 58). **30**
3. Press **bake** again to toggle to minus setting (Figure 59). 
4. To accept change, press **START**. 



Fig. 59 Oven temperature set 30° lower than default

 Oven temperature adjustments made by changing the UPO setting will not affect the broil or self-clean feature temperatures.

Setting the Sabbath mode

(For use on Jewish Sabbath and Holidays)



For further assistance, guidelines for proper usage and a complete list of models with the Sabbath feature, please visit the web at <http://www.star-k.org>.

This appliance provides special settings for use when observing the Jewish Sabbath/Holidays. Sabbath mode disables all audible

tones or visual display changes on the oven control. **BAKE** and **cooktop** heating are the only cooking features available while in the Sabbath mode.

You must first set the **BAKE** feature and temperature(s) needed for the oven, the **COOK TIME** option if needed, and any cooktop power levels before setting the Sabbath mode. Any settings made prior to setting the Sabbath mode will be visible in the displays. The **COOK TIME** option, if set prior to the Sabbath mode, will give one audible alert at the end of **COOK TIME**.

The Sabbath mode will override the factory preset 12-hour Energy Saving mode and the appliance will stay on until the cooking features are cancelled. If any of the cooking features are cancelled when the appliance is in the Sabbath mode, no audible or visual indicators will be available to verify the cancellation.

If the oven interior lights are needed, be sure to activate them prior to setting the Sabbath mode. Once the oven light is turned ON and the Sabbath mode is active, the oven light will remain on until the Sabbath mode is turned off and the oven lights are turned off. The oven door will not activate the interior oven lights when the oven door is opened or closed.

It is recommended that any oven temperature modification made within an active Sabbath mode be followed with 2 presses of the **START** key. This will insure the oven remains ON even if an attempt is made to set the oven temperature outside of its temperature range. If the oven temperature is set outside of the temperature range, the oven will default to the nearest available temperature. Try to set the desired oven temperature again.

To set the oven for Sabbath mode to bake at 325°F:

1. Be sure the clock is set to the correct time of day.
2. Press **bake**.



3. Enter **3 2 5** using numeric keypad.

3 2 5

4. Press **START**.



5. If needed, enter the **cook time** or **end time** settings.

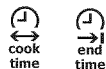

6. To enter Sabbath mode, press and hold both the **cook time** and the **end time** keys together for 3 seconds. A beep will sound. release the keys.

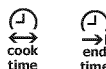

Once properly set in Sabbath mode, **SAb** will show in the oven display and **- -** will appear in all the individual cooktop displays until the Sabbath mode is cancelled (see Figure 60).

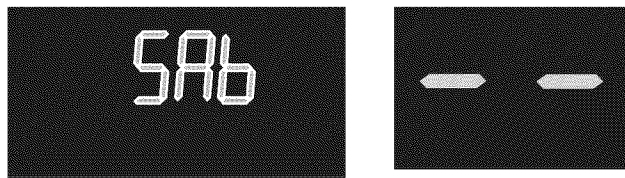

Fig. 60 Sabbath Mode oven (L) and cooktop displays (R)

The only keys available once the range is set to Sabbath mode are: Bake, Fresh Clean, Cook Time, End Time, Start, Cancel, and Numeric keypad. You may change the oven temperature once baking has started and is in Sabbath Mode. For example, to change baking temperature:

1. Press **BAKE**.
2. Enter the desired temperature.
3. Press **START**.

Remember that the oven control will no longer beep or display further changes once the oven is set in Sabbath mode. All previously set features in the oven and the cooktop will automatically cancel once Sabbath mode has ended.

IMPORTANT! Remember the oven will shut off after completing a cook time or end time and therefore may only be used once during the Sabbath/Jewish holidays. The maximum cook time setting is 11 hours and 59 minutes.

Canceling Sabbath Mode

To cancel the Sabbath mode:

1. Press and hold both the **COOK TIME** and **END TIME** key together for 3 seconds. A beep will sound. Release the keys.
2. **Sab** will disappear from the display.

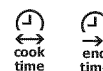

WARNING

FOOD POISONING HAZARD: Do not let food sit for more than one hour before or after cooking. Doing so may result in food poisoning or sickness.

What to do after a power failure or power interruption when Sabbath mode is active

Should a power failure or interruption occur during the Sabbath/Holidays, the appliance will shut OFF. **SF** will appear in all the control display, indicating a Sabbath mode failure (Figure 61) Sabbath Failure mode will remain and the oven will not work until Sabbath mode is cancelled..



Fig. 61 Sabbath Failure

After Sabbath mode is cancelled, Sabbath mode settings may be entered again.

Restoring control to factory default settings

Your appliance is set with a number of predetermined oven control settings. Over time you may make changes to the original factory settings.

The following functions or features have user programmable options or adjustments that may have been changed from the default settings.

- Clock 12-hour or 24-hour display mode
- 12-Hour Energy Savings or continuous bake mode
- Tone volume
- Oven temperature display mode (F° or C°)
- Any oven temperature adjustment made
- Any saved “my favorite”

IMPORTANT! Before restoring, be aware that any previous changes made to the oven control settings will be erased once the keypad is pressed. This includes any temperature offset made for the oven when baking.

To restore factory default settings:

1. Press and hold the number 7 key for 6 seconds. A beep will sound and **rST P S** will appear in the display (Figure 62).
2. Press **START** to accept

7



Fig. 62 Oven ready to reset to default settings

Interior oven light

The interior oven light will automatically turn ON when the door is open.

Press  to turn the interior oven light ON and OFF whenever the oven door is closed.

The oven light will not operate during a self clean cycle.

The interior oven light is located at the upper left rear wall of the oven interior and is covered with a glass shield held in place with a wire holder. The glass shield must be in place whenever the oven is in use.

To change the interior light, see **Changing the oven light** in the “Care and Cleaning” section.

Before starting fresh clean

Adhere to the following precautions before a self-clean cycle:

- Remove **all items** from the oven and cooktop including food, cookware, utensils, plastic, and any aluminum foil. Aluminum foil will not withstand high temperatures generated during the self-clean cycle.
- Remove all oven racks and accessories from the oven interior to avoid possible damage. If the oven racks are not removed they may discolor. The Luxury Glide™ oven rack must be removed before starting self-clean to avoid damaging the glide ability of the rack. **REMOVE RACKS** will flash in the display for several seconds as a reminder to remove the racks before starting a self-clean cycle. (Figure 63)



Fig. 63 Remove racks indicator

- Be sure the **oven vent is clear**.
- Remove **all items** from the storage drawer.
- Be sure oven light shield is in place.
- **Remove any excess spills or loose debris.** Spills on the oven bottom should be wiped up and removed **before starting self-clean**. To clean, use hot, soapy water and a cloth. Large food spill overs can cause heavy smoke or a fire during self-clean. Spills that have a high sugar or acid content (such as milk, tomatoes, sauerkraut, fruit juices or pie filling) may leave a dull spot even after self-cleaning.
- **Do not clean the oven door gasket** (Figure 64). Do not use any cleaning materials on the oven door gasket. Doing so may damage the gasket. The woven material of the oven door is essential for a good seal. Care should be taken not to rub, damage or remove the door gasket.
- **Do not** use commercial oven cleaners or protective coatings of any kind inside oven. Residue from oven cleaners may damage the porcelain during the next self-clean cycle.



Clean any soil from the oven exterior. Clean using soap and water before starting a self-clean cycle. If soils are not removed, they may burn on due to the high temperature during self-clean.

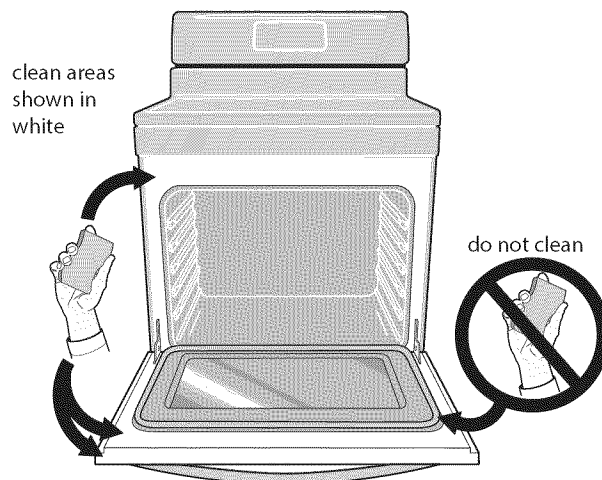

Fig. 64 Areas of oven door and frame: Clean with caution

⚠ WARNING

Do not touch the oven during the self-clean cycle.

⚠ WARNING

Keep children away from the oven during the self-clean cycle.

⚠ WARNING

Failure to follow these instructions can result in burns.

⚠ CAUTION

The health of some birds is extremely sensitive to the fumes given off during the self-clean cycle of any range. Move birds to another well-ventilated room.

⚠ CAUTION

Do Not line the oven walls, oven racks, oven bottom or any other part of the range with aluminum foil. Doing so will stop heat distribution, produce poor baking results and may cause permanent damage to the oven interior. Aluminum foil will melt to a hot oven surface during self-clean.

Setting fresh clean

A self-cleaning oven automatically cleans itself using much higher temperatures than those used for cooking. The self-clean feature eliminates soils completely or reduces them to a fine powdered ash that, when the oven has cooled, can be wiped away easily with a damp cloth.

The self-clean function provides 3 different clean time settings for self-cleaning. Set clean for 2 hours for light, 3 hours for normal or 4 hours for heavier soils.

To start a self-clean:

1. The oven door should be empty and all **oven racks** removed. Remove all items from the cooktop. Be sure the oven door is completely closed
2. Press **fresh clean** once for a 3-hour clean (Figure 65), twice for a 4-hour clean (Figure 66) or 3 times for a 2-hour clean (Figure 67).
3. Press **START**



Fig. 65 3 Hour normal clean



Fig. 66 4 Hour heavy clean



Fig. 67 2 Hour light clean

Once active, the door lock motor will begin locking the oven door. **door loc** (Figure 68) will appear in the display. **DO NOT** try to open the door when the **door loc** message is on (allow about 15 seconds for the oven door to completely lock). **DO NOT** force the oven door open. This could damage the door locking system. Once the oven door is locked the **door loc** message will turn off and **CLn** will appear in the display for the entire self clean cycle (Figure 69).



Fig. 68 Door lock indicator



Fig. 69 Oven in self clean operation

When the self clean cycle is finished:

1. The time of day and **Hot** will show in the display (Figure 70).
2. Once the oven has cooled (about 1 hour) and **Hot** is no longer displayed, the **door OPn** message will appear (Figure 71). When this message turns OFF the door has finished unlocking.



Fig. 70 Hot oven (door still locked)



Fig. 71 Door opens when oven is cooled

3. When the oven is cool, wipe away any residue or powdered ash from the oven interior using a damp cloth or paper towel.



A self-clean cycle will not start if the control lock feature is active.



When the self clean feature is active, you may check the amount of time remaining by pressing



If a self-clean cycle was started but did not finish due to a power outage, your oven may not have completely cleaned.

Setting fresh clean (cont'd)

To cancel self-clean:

1. Press  .
2. If the self-clean cycle has heated the oven to a high enough temperature, **Hot** (Figure 72) will appear in the display. Allow enough time for the oven to cool and for the **door OPn** message to display (Figure 73). When this message turns OFF the oven door may be opened.

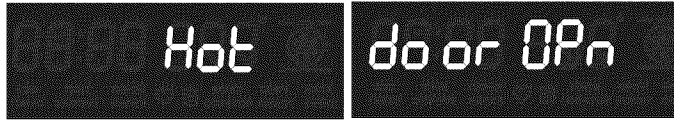

Fig. 72 Oven too hot for door to unlock

Fig. 73 Door opens when oven cools enough

Starting fresh clean after cancelling:

If a self clean cycle was cancelled using the **cancel key** before the oven was finished cleaning, you may wish to set another self-clean cycle.

If self clean was cancelled shortly after being started, and the oven interior did not reach high self-clean temperatures, the next clean cycle may be set as soon as the oven door unlocks from the cancelled clean cycle.

If the oven reached high temperatures before the self-clean cycle was cancelled, you may be required to wait up to 4 hours before the control will allow another self-clean cycle to be started.

Restarting a fresh clean cycle after a power outage:

If the self-clean cycle was interrupted by a power failure, the oven may not be thoroughly cleaned. Another self-clean cycle may be needed. Once power is restored, the oven has cooled and the door unlocks, set to clean for another cycle.

Setting repeated self-clean cycles

If attempting to set repeating self-clean cycles, the control may display the message **CLEAn** then **dELAy** followed by the length of time before the next self-clean may be set.





For example, if the message display reads "4:00" and the time is 12:00 o'clock, the control will not allow a self-clean to be set until after 4:00 o'clock.

Setting delayed fresh clean

You may wish to set the oven to perform a self-clean at a later time (up to 12 hours later). The end time key will determine when the cleaning will stop.

The end time must be set far enough from the real time to allow for the type of clean cycle you select, whether 2, 3, or 4 hours. Remember to add 30 to 40 additional minutes of cooling time before using the oven for cooking.

Setting for a heavy (4 hour) self clean cycle to end at 8:00 o'clock:

1. Be sure the clock is set with the correct time of day. **In this example the time of day should be earlier than 4:00 o'clock. Remove all oven racks.** Remove all items from the cooktop. Be sure the oven door is completely closed.
2. Press **end time** 
3. Enter 8 0 0 using the numeric keypad **800**
4. Press **START** 
5. Press **fresh clean** 
6. Press **fresh clean** again 
7. Press **START** 

Press CANCEL at any time to stop fresh clean

CAUTION

To avoid possible burns use caution opening the oven door after the self-clean cycle is finished. The oven may still be **VERY HOT. Stand to the side of the oven** when opening the door to allow hot air to escape.

CARE AND CLEANING

Cleaning Recommendations

| Surface | Type Cleaning Recommendation |
|---|--|
| Control knobs (some models) Painted body parts Painted decorative trim Aluminum, plastic or vinyl trim | <ul style="list-style-type: none"> For general cleaning, use hot, soapy water and a cloth. For more difficult soils and built-up grease, apply a liquid detergent directly onto soil. Leave on soil for 30-60 minutes. Rinse with a damp cloth and dry. Do not use abrasive cleaners these surfaces; they can scratch. To remove control knobs, turn to OFF position; grasp firmly and pull straight off the shaft. To replace knobs after cleaning, line up the flat sides of both knob and shaft; then push knob into place. |
| Control panel Control key pad membrane Decorative trim (some models) | <ul style="list-style-type: none"> Before cleaning the control panel, turn all controls off, activate control lock (some models) and if needed remove knobs from panel (some models). Do not use abrasive cleaners on controls or trim; they can scratch. Clean using hot, soapy water and a dishcloth. Be sure to squeeze excess water from dishcloth before wiping control panel; especially when wiping around the controls area. Excess water in or around the controls may cause damage to the appliance. When rinsing, use clean water and a dishcloth and be sure to squeeze excess water from dishcloth before wiping the control panel. |
| Stainless Steel (some models) | <ul style="list-style-type: none"> Clean stainless with warm soapy water using a clean sponge or cloth. Rinse with clean water and dry with soft clean cloth. Do not use harsh scrubbing cleaners. Only use kitchen cleaners especially made for cleaning stainless steel. Always be sure to rinse cleaners from the surface as bluish stains may occur during heating that cannot be removed. |
| Porcelain enamel parts Broiler pan and broiler pan insert | <ul style="list-style-type: none"> Gentle scrubbing with a soapy no-scratch cleaning pad will remove most spots. Rinse with a 1:1 solution of clear water and ammonia. If necessary, cover difficult spots with an ammonia-soaked paper towel for 30 to 40 mins. Rinse with clean water and a damp cloth, and then scrub with a soap-filled no-scratch cleaning pad. Rinse and wipe dry with a clean cloth. Do not allow food spills with high sugar or acid content (milk, tomatoes, sauerkraut, fruit juices or pie filling) to remain on surfaces; they may cause a dull spot even after cleaning. |
| Oven interior | <ul style="list-style-type: none"> Remove excessive spills from oven cavity bottom before starting self-clean. Clean any soils from oven frame and door liner outside the oven door gasket. For important preparation information be sure to read all the instructions in the self-cleaning section. |
| Oven racks | <ul style="list-style-type: none"> Do not clean oven racks in oven during the self-clean cycle. Remove and clean using a mild, abrasive cleaner following manufacturer's instructions. Thoroughly rinse and dry. |
| Oven door | <ul style="list-style-type: none"> Use soap & water to thoroughly clean the top, sides and front of the oven door. Rinse well. You may use a glass cleaner on the outside glass of the oven door. Do not immerse the door in water. Do not spray or allow water or glass cleaner to enter the door vents. To avoid scratches, do not use oven cleaners, cleaning powders or any harsh abrasive cleaning materials on the outside of the oven door. Do not clean the oven door gasket. On self-cleaning models the oven door gasket is made of a woven material which is essential for a good seal. Care should be taken not to rub, damage or remove this gasket. |
| Ceramic cooktop | <ul style="list-style-type: none"> Refer to Cooktop cleaning and Cooktop maintenance in the Care and Cleaning section. |

Cooktop maintenance

Consistent and proper cleaning is essential to maintaining your ceramic glass cooktop.

Prior to using your cooktop for the first time, apply some of the cooktop cleaner supplied with your new appliance. Buff with a non-abrasive cloth or non scratch cleaning pad. This will make cleaning easier when soiled from cooking. The special cooktop cleaning cream leaves a protective finish on the glass to help prevent scratches and abrasions.

Sliding aluminum or copper clad bottom pans on the cooktop can cause metal markings on the cooktop surface. These marks should be removed immediately after the cooktop has cooled using the cooktop cleaning cream. Metal marks can become permanent if not removed prior to future use.

Cookware (cast iron, metal, ceramic or glass) with rough or dirty bottoms can mark or scratch the cooktop surface.

Do not:

- Slide anything metal or glass across the cooktop.
- Use cookware with dirt or dirt build up on bottom; replace with clean cookware before using.
- Use your cooktop as a cutting board or work surface in the kitchen.
- Cook foods directly on the cooktop surface without a pan.
- Drop heavy or hard objects on the ceramic glass cooktop, they may cause it to crack.

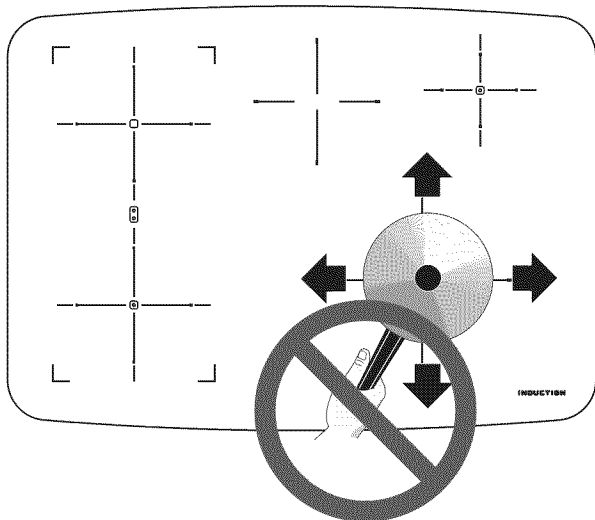

Figure 74: Take care to not slide cookware

Cooktop cleaning

⚠ CAUTION Before cleaning the cooktop, be sure the controls are turned to OFF and the cooktop is COOL.

For light to moderate soil:

Apply a few drops of the ceramic glass cooktop cleaner directly to the cooktop. Use a paper towel or use a non-abrasive, no-scratch cleaning pad to clean the entire cooktop surface. Make sure the cooktop is cleaned thoroughly, leaving no residue.

For heavy, burned on soil:

Apply a few drops of the ceramic glass cooktop cleaner directly to the soiled area. Rub the soiled area using a non-abrasive, no-scratch cleaning pad, applying pressure as needed. Do not use the pad you use to clean the cooktop for any other purpose.

If soils remain, carefully scrape soils with a razor blade scraper, holding scraper at a 30 degree angle to the surface. Remove loosened soils with cooktop cleaning cream and buff surface clean.

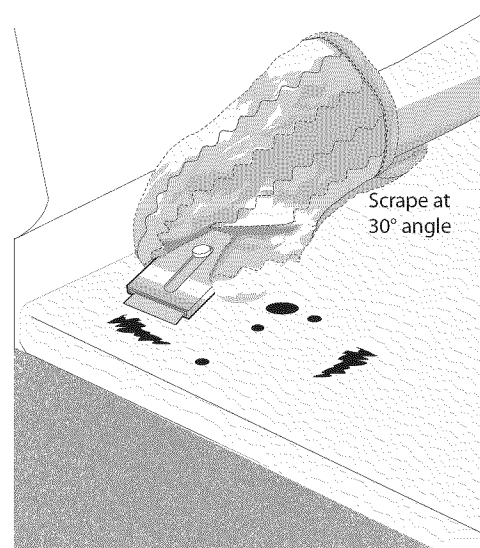

Figure 75: Using razor blade to scrape cooktop

Cooktop cleaning (cont'd)

Plastic or foods with a high sugar content:

These types of soils need be removed immediately. Permanent damage (such as pitting of the cooktop surface) may occur if not removed immediately.

After turning the surface elements OFF, use a razor blade scraper or a metal spatula with a mitt and scrape the soil from the hot surface. Allow the cooktop to cool. Use the same method for heavy or burned on soils.

i Damage to the ceramic glass cooktop may occur if you use an abrasive type cleaning pad. Only use cleaning products that have been specifically designed for ceramic glass cooktops.

Do not use the following on the cooktop:

- Do not use abrasive cleaners and scouring pads, such as metal and some nylon pads. They may scratch the cooktop, making it more difficult to clean.
- Do not use harsh cleaners, such as chlorine bleach, ammonia or oven cleaners, as they may etch or discolor the cooktop.
- Do not use dirty sponges, cloths or paper towels, as they can leave soil or lint on the cooktop which can burn and cause discoloration.



Figure 76: Never use harsh or abrasive cleaners

Aluminum foil and oven liners

Do not use oven bottom liners or use aluminum foil to cover the oven racks.

⚠ CAUTION Protective liners—Do not use aluminum foil to line the oven bottom, except as suggested in the manual. Improper installation of these liners may result in a risk of electrical shock, or fire.

Using a liner in the oven restricts the heat and air flow needed to obtain the best possible cooking results for any oven.

During self-clean the oven temperature can become hot enough to melt aluminum cooking utensils or aluminum foil if left in the oven. This could result in permanent damage to the oven interior and porcelain finish.

Replacing the oven light

⚠ CAUTION Be sure the range is unplugged and all parts are COOL before replacing oven light. Wear a leather-faced glove for protection against possible broken glass.

The interior oven light bulb is located at the rear oven cavity and is covered with a glass shield. The glass shield must be in place whenever the oven is in use (Figure 77).

Replacing the oven interior light bulb:

1. Turn electrical power off at the main source or unplug the appliance.
2. Remove interior oven light shield (Figure 77).
3. Replace bulb with a new T-4 type 40 Watt Halogen appliance bulb. Please note: do not allow your fingers to touch the new bulb when replacing. This will shorten the life of the new bulb. Use a paper towel to cover the new bulb when installing.
4. Replace glass interior oven light shield.
5. Turn power back on again at the main source (or plug the appliance back in).
6. Be sure to reset the time of day on the clock.

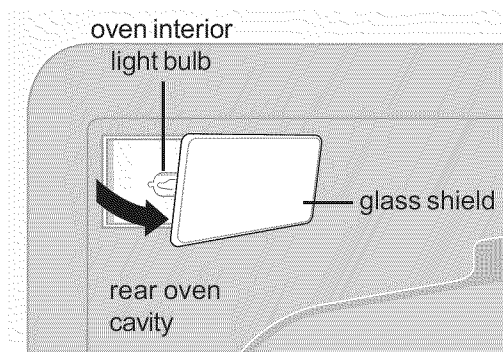

Figure 77: Oven light and glass shield

Removing and replacing the oven door

⚠ CAUTION To prevent possible burns, do not attempt to remove the oven door until the oven has completely cooled.

⚠ WARNING The oven door is heavy. Be careful when removing and lifting the door. Do not lift the oven door by the handle.

To remove the oven door:

1. Open oven door completely (Figure 78).
2. Pull the hinge locks on both left and right hinges down from the oven frame completely towards the oven door (Figure 79). A tool such as a small flat-blade screwdriver may be required.
3. Firmly grasp both sides of oven door along the door sides (Do not use the oven door handle).
4. Close the door to the broil stop position (Figure 80). The oven door will stop into this position just before fully closing.
5. With the oven door in the broil stop position (Figure 80), lift and carefully pull the oven door away from the oven frame. To avoid finish damage, be careful not to allow the oven door hinges to contact the oven front frame.

To replace oven door:

1. Firmly grasp both sides of oven door along the door sides (Do not use the oven door handle).
2. Holding the oven door at the same angle as the removal position, carefully line up and insert both door hinge arms between the pins located on each side of the oven door frame (Figure 81).
3. With both door hinge arms in place, open the oven door (Figure 78).
4. Push the door hinge locks up towards and into the oven frame for both left and right oven door hinges to the locked position (Figure 79).
5. Close the oven door.

Special door care instructions - Most oven doors contain glass that can break.

Read the following recommendations:

- Do not close the oven door until all the oven racks are fully in place.
- Do not hit the glass with pots, pans, or any other object.
- Scratching, hitting, jarring or stressing the glass may weaken its structure causing an increased risk of breakage at a later time.

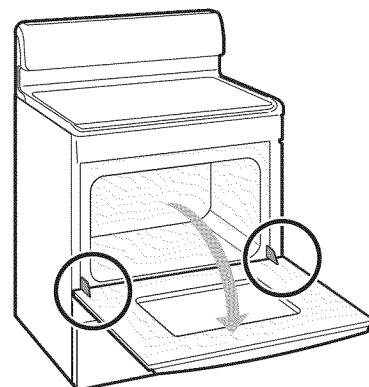

Figure 78: Oven hinge locations

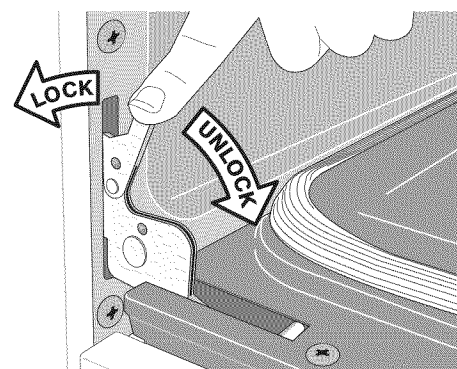

Figure 79: Unlocking and locking the hinges

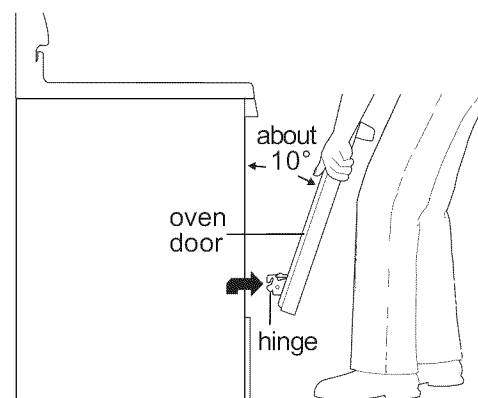

Figure 80: Broil stop position for removing door

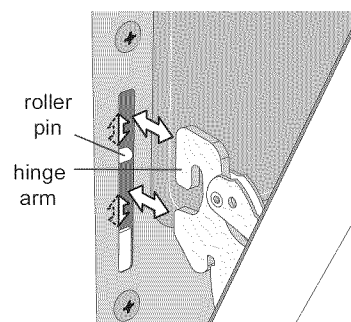

Figure 81: Oven hinge and roller pin

SOLUTIONS TO COMMON PROBLEMS

Before You Call

Baking Problems and Solutions

For best cooking results, heat the oven before baking cookies, breads, cakes, pies or pastries, etc. There is no need to preheat the oven for roasting meat or baking casseroles.

The cooking times and temperatures needed to bake a product may vary slightly from your previously owned appliance.

Cookies and biscuits burn on the bottom.

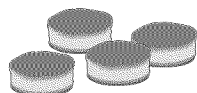

- Cookies and biscuits put into oven before the preheating time is completed.
- Oven rack is overcrowded.
- Dark pans absorb heat too fast.
- Allow oven to preheat to desired temperature before placing food in oven.
- Choose pan sizes that will permit 2" to 4" of air space (5.1 cm to 10.2 cm) on all sides when placed in the oven.
- Use a medium weight baking sheet.

Cakes too dark on top or bottom

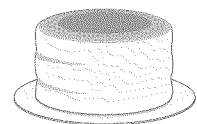

- Cakes put in oven before preheating time is completed.
- Rack position too high or too low.
- Oven too hot.
- Allow oven to preheat to the selected temperature before placing food in the oven.
- Use proper rack position for baking needs.
- Set oven temperature 25°F/13°C lower than recommended.

Cakes not done in center

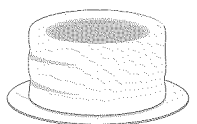

- Oven too hot.
- Incorrect pan size.
- Pan not centered in oven.
- Set oven temperature 25°F/13°C lower than recommended.
- Use pan size suggested in recipe.
- Use proper rack position and place pan so there is 5.1 cm to 10.2 cm (2" to 4") of space on all sides of pan.

Cakes not level.

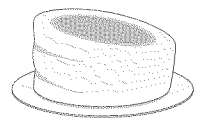

- Oven not level.
- Pan too close to oven wall or rack overcrowded.
- Pan warped.
- Place a marked glass measuring cup filled with water on the center of the oven rack. If the water level is uneven, refer to the installation instructions for leveling the oven.
- Be sure to allow 5.1 cm to 10.2 cm (2" to 4") of clearance on all sides of each pan in the oven.
- Do not use pans that are dented or warped.

Foods not done when cooking time is over.

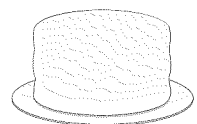

- Oven too cool.
- Oven overcrowded.
- Oven door opened too frequently.
- Set oven temperature 25°F/13°C higher than suggested and bake for the recommended time.
- Be sure to remove all pans from the oven except the ones to be used for baking.
- Open oven door only after shortest recommended baking time.

Before you call for service, review the following list. It may save you time & expense. The list includes common occurrences that are not the result of defective workmanship or materials in this appliance.

| Problem | Solution |
|---|--|
| Appliance is not level | <ul style="list-style-type: none"> • Be sure floor is level, strong & stable enough to adequately support range. If floor is sagging or sloping, contact a carpenter to correct the situation. • Poor installation. Place oven rack in center of oven. Place a level on the oven rack. Adjust leveling legs at base of appliance until the oven rack is level. • Kitchen cabinet alignment may make range appear not level. Be sure cabinets are square & have sufficient room for appliance clearance. |
| Cannot move appliance easily. Appliance must be accessible for service | <ul style="list-style-type: none"> • Cabinets not square or are built in too tightly. Contact builder or installer to make appliance accessible. • Carpet interferes with appliance. Provide sufficient space so appliance can be lifted over carpet. |
| Surface element too hot or not hot enough | <ul style="list-style-type: none"> • Incorrect control setting. Be sure the correct control is ON for the element that you are attempting to use. |
| Surface element does not heat | <ul style="list-style-type: none"> • Lightweight or warped pans used. Use only flat, evenly balanced, medium or heavyweight cookware. Flat pans heat better than warped pans. Cookware materials and weight of the material affect heating. Heavy & medium weight pans heat evenly. Because lightweight pans heat unevenly, foods may burn easily. |
| Entire appliance does not operate | <ul style="list-style-type: none"> • The time of day is not set. The time of day must first be set in order to operate the oven. See "Setting the clock" in the Setting Oven Controls section. • Make sure cord/plug is plugged correctly into outlet. • Service wiring is not complete. Contact your dealer, installing agent or authorized service agent. • Electrical power outage. Check house lights to be sure. Call your local electric company for service. |
| Oven does not operate | <ul style="list-style-type: none"> • Be sure the oven controls are set properly for the desired cooking feature. See "Setting Oven Controls" in this Use & Care Guide or read the instructions "Entire appliance does not operate" in this checklist. |
| Oven light does not work | <ul style="list-style-type: none"> • Replace or tighten bulb. See "Replacing the oven light" in this Use & Care Guide. |
| Flames inside oven or smoking from oven vent | <ul style="list-style-type: none"> • Excessive spills in oven. For example this will happen for pie spills or large amounts of grease left on the oven bottom. Wipe up excessive spills before starting oven. If flames or excessive smoke are present see "About broiling" in the Setting Oven Controls section. |
| Oven control panel beeps & displays any F code error (for example F10) | <ul style="list-style-type: none"> • Oven control has detected a fault or error condition. Press CANCEL to clear the display & stop beeping. Try the bake or broil feature again. If the F code error repeats, remove power supply to appliance, wait 5 minutes and then repower the appliance and set clock for the time of day. Try the bake or broil feature again. If the fault recurs, record fault and call for service. |

Questions or for service call: 1-877-4ELECTROLUX (1-877-435-3287)

| Problem | Solution |
|---|--|
| Oven smokes excessively during broiling | <ul style="list-style-type: none"> • Control not set properly. Follow broiling instructions under Setting Oven Controls. • Make sure oven door is opened to broil stop position. • Meat too close to the broil element. Reposition the broil rack to provide proper clearance between the meat & the element. Preheat the broil element for searing. • Meat not properly prepared. Remove excess fat from meat. Cut remaining fatty edges to prevent curling, but do not cut into lean. • Insert on broiler pan wrong side up & grease not draining. Always place grid on the broiler pan with ribs up & slots down to allow grease to drip into pan (some models). • Grease has built up on oven surfaces. Regular cleaning is necessary when broiling frequently. Old grease or food spatters cause excessive smoking. |
| Oven control panel beeps & cooktop control displays any F code error (for example F10) | <ul style="list-style-type: none"> • Cooktop control has detected a fault or error condition. If the F code error persists, remove power supply to appliance, wait 5 minutes and then repower the appliance and set clock for time of day. Try the cooktop setting again. If the fault recurs, record F code fault and call for service. |
| Scratches or abrasions on cooktop surface | <ul style="list-style-type: none"> • Coarse particles such as salt or sand between cooktop and utensils can cause scratches. Be sure cooktop surface and bottoms of utensils are clean before usage. Small scratches do not affect cooking and will • become less visible with time. • Cleaning materials not recommended for ceramic glass cooktop have been used. See "Cooktop cleaning" in the Care and Cleaning section of this Use & Care Guide. • Cookware with rough bottom has been used. Use smooth, flat-bottomed cookware. |
| Metal marks on the cooktop | <ul style="list-style-type: none"> • Sliding or scraping of metal utensils on cooktop surface. Do not slide metal utensils on cooktop surface. • Use a ceramic-glass cooktop cleaning creme to remove the marks. See "Cooktop cleaning" in the Care and Cleaning section. |
| Brown streaks or specks on cooktop surface | <ul style="list-style-type: none"> • Boil overs are cooked onto surface. Use razor blade scraper to remove soil. See "Cooktop cleaning" in the Care and Cleaning section. |
| Areas of discoloration with metallic sheen | <ul style="list-style-type: none"> • Mineral deposits from water and food. Remove using a ceramic-glass cooktop cleaning creme. Use cookware with clean, dry bottoms. |
| Poor baking results | <ul style="list-style-type: none"> • Many factors affect baking results. Make sure the proper oven rack position is used. Center food in the oven and space pans to allow air to circulate. Allow oven to preheat to the set temperature before placing food in the oven. Try adjusting the recipe's recommended temperature or baking time. If you feel the oven is too hot or cool, see "Adjusting the oven temperature" in the Setting Oven Controls section of this Use & Care Guide. |

Questions or for service call: 1-877-4ELECTROLUX (1-877-435-3287)

WARRANTY

Your appliance is covered by a one year limited warranty. For one year from your original date of purchase, Electrolux will repair or replace any parts of this appliance that prove to be defective in materials or workmanship when such appliance is installed, used, and maintained in accordance with the provided instructions. In addition, the glass cooktop or radiant surface element of your appliance (excluding built-in and free-standing range appliances) is covered by a two through five year limited warranty. During the 2nd through 5th years from your original date of purchase, Electrolux will provide a replacement glass cooktop or radiant surface element for your appliance which has proven to be defective in materials or workmanship when such appliance is installed, used, and maintained in accordance with the provided instructions.

Exclusions

This warranty does not cover the following:

1. Products with original serial numbers that have been removed, altered or cannot be readily determined.
2. Product that has been transferred from its original owner to another party or removed outside the USA or Canada.
3. Rust on the interior or exterior of the unit.
4. Products purchased "as-is" are not covered by this warranty.
5. Products used in a commercial setting.
6. Service calls which do not involve malfunction or defects in materials or workmanship, or for appliances not in ordinary household use or used other than in accordance with the provided instructions.
7. Service calls to correct the installation of your appliance or to instruct you how to use your appliance.
8. Expenses for making the appliance accessible for servicing, such as removal of trim, cupboards, shelves, etc., which are not a part of the appliance when it is shipped from the factory.
9. Service calls to repair or replace appliance light bulbs, air filters, water filters, other consumables, or knobs, handles, or other cosmetic parts.
10. Labor or in-home service costs during the additional limited warranty periods beyond the first year from your original date of purchase.
11. Pickup and delivery costs; your appliance is designed to be repaired in the home.
12. Surcharges including, but not limited to, any after hour, weekend, or holiday service calls, tolls, ferry trip charges, or mileage expense for service calls to remote areas, including the state of Alaska.
13. Damages to the finish of appliance or home incurred during transportation or installation, including but not limited to floors, cabinets, walls, etc.
14. Damages caused by: services performed by unauthorized service companies; use of parts other than genuine Electrolux parts or parts obtained from persons other than authorized service companies; or external causes such as abuse, misuse, inadequate power supply, accidents, fires, or acts of God.

DISCLAIMER OF IMPLIED WARRANTIES; LIMITATION OF REMEDIES

CUSTOMER'S SOLE AND EXCLUSIVE REMEDY UNDER THIS LIMITED WARRANTY SHALL BE REPAIR OR REPLACEMENT AS PROVIDED HEREIN. **CLAIMS BASED ON IMPLIED WARRANTIES, INCLUDING WARRANTIES OF MERCHANTABILITY OR FITNESS FOR A PARTICULAR PURPOSE, ARE LIMITED TO ONE YEAR OR THE SHORTEST PERIOD ALLOWED BY LAW, BUT NOT LESS THAN ONE YEAR.** ELECTROLUX SHALL NOT BE LIABLE FOR CONSEQUENTIAL OR INCIDENTAL DAMAGES SUCH AS PROPERTY DAMAGE AND INCIDENTAL EXPENSES RESULTING FROM ANY BREACH OF THIS WRITTEN LIMITED WARRANTY OR ANY IMPLIED WARRANTY. SOME STATES AND PROVINCES DO NOT ALLOW THE EXCLUSION OR LIMITATION OF INCIDENTAL OR CONSEQUENTIAL DAMAGES, OR LIMITATIONS ON THE DURATION OF IMPLIED WARRANTIES, SO THESE LIMITATIONS OR EXCLUSIONS MAY NOT APPLY TO YOU. THIS WRITTEN WARRANTY GIVES YOU SPECIFIC LEGAL RIGHTS. YOU MAY ALSO HAVE OTHER RIGHTS THAT VARY FROM STATE TO STATE.

If You Need Service

Keep your receipt, delivery slip, or some other appropriate payment record to establish the warranty period should service be required. If service is performed, it is in your best interest to obtain and keep all receipts. Service under this warranty must be obtained by contacting Electrolux at the addresses or phone numbers below.

This warranty only applies in the USA, Puerto Rico and Canada. In the USA and Puerto Rico, your appliance is warranted by Electrolux Major Appliances North America, a division of Electrolux Home Products, Inc. In Canada, your appliance is warranted by Electrolux Canada Corp. Electrolux authorizes no person to change or add to any obligations under this warranty. Obligations for service and parts under this warranty must be performed by Electrolux or an authorized service company. Product features or specifications as described or illustrated are subject to change without notice.

USA

1-877-435-3287

Electrolux Major Appliances North America
10200 David Taylor Drive
Charlotte, NC 28262

Canada

1-800-265-8352

Electrolux Canada Corp.
5855 Terry Fox Way
Mississauga, Ontario, Canada L5V 3E4

www.electrolux-store.com

