



DISHWASHER USER INSTRUCTIONS

Thank you for Choosing KitchenAid® Appliances.

We hold our company to the highest quality standards and it is important to us that you have a positive experience owning a KitchenAid® product.

For your convenience, we have provided an easy to follow User Instruction Book. These instructions include a “Troubleshooting” section to help you through any problems you may encounter.

For additional information, you can visit the Frequently Asked Questions (FAQs) section of our website at www.kitchenaid.com. If you need further assistance using your KitchenAid dishwasher, please contact us at 1-800-422-1230. In Canada: visit www.kitchenaid.ca or call 1-800-807-6777.

Have your complete model and serial number ready. You can find your model and serial number on the label located near the door on the right-hand or left-hand side of the dishwasher interior.

Para obtener acceso a “Instrucciones para el usuario de la lavavajillas” en español, o para obtener información adicional acerca de su producto, visite: www.kitchenaid.com

Tenga listo su número completo de modelo y de serie. Puede encontrar su número de modelo y de serie en la etiqueta ubicada cerca de la puerta, al lado derecho o izquierdo del interior de la lavavajillas.

Table of Contents

DISHWASHER SAFETY	2
PARTS AND FEATURES.....	4
START-UP / QUICK REFERENCE (VARIES BY MODEL)	5
QUICK STEPS.....	6
DISHWASHER USE.....	6
CYCLE AND OPTION DESCRIPTIONS	8
DISHWASHER FEEDBACK SECTION.....	10
DISHWASHER FEATURES.....	11
DISHWASHER CARE	12
TROUBLESHOOTING	13
WARRANTY	16

Dishwasher Safety

Your safety and the safety of others are very important.

We have provided many important safety messages in this manual and on your appliance. Always read and obey all safety messages.



This is the safety alert symbol.

This symbol alerts you to potential hazards that can kill or hurt you and others.

All safety messages will follow the safety alert symbol and either the word "DANGER" or "WARNING."

These words mean:

⚠ DANGER

You can be killed or seriously injured if you don't immediately follow instructions.

⚠ WARNING

You can be killed or seriously injured if you don't follow instructions.

All safety messages will tell you what the potential hazard is, tell you how to reduce the chance of injury, and tell you what can happen if the instructions are not followed.

IMPORTANT SAFETY INSTRUCTIONS

WARNING: When using the dishwasher, follow basic precautions, including the following:

- Read all instructions before using the dishwasher.
- Use the dishwasher only for its intended function.
- Use only detergents or rinse agents recommended for use in a dishwasher, and keep them out of the reach of children.
- When loading items to be washed:
 - 1) Locate sharp items so that they are not likely to damage the door seal; and
 - 2) Load sharp knives with the handles up to reduce the risk of cut-type injuries.
- Do not wash plastic items unless they are marked "dishwasher safe" or the equivalent. For plastic items not so marked, check the manufacturer's recommendations.
- Do not touch the heating element during or immediately after use.
- Do not operate the dishwasher unless all enclosure panels are properly in place.
- Do not tamper with controls.
- Do not abuse, sit on, or stand on the door, lid, or dish racks of the dishwasher.
- To reduce the risk of injury, do not allow children to play in or on the dishwasher.
- Under certain conditions, hydrogen gas may be produced in a hot water system that has not been used for two weeks or more. **HYDROGEN GAS IS EXPLOSIVE.** If the hot water system has not been used for such a period, before using the dishwasher turn on all hot water faucets and let the water flow from each for several minutes. This will release any accumulated hydrogen gas. As the gas is flammable, do not smoke or use an open flame during this time.
- Remove the door or lid to the washing compartment when removing an old dishwasher from service or discarding it.

SAVE THESE INSTRUCTIONS

GROUNDING INSTRUCTIONS

■ For a grounded, cord-connected dishwasher:

The dishwasher must be grounded. In the event of a malfunction or breakdown, grounding will reduce the risk of electric shock by providing a path of least resistance for electric current. The dishwasher is equipped with a cord having an equipment-grounding conductor and a grounding plug. The plug must be plugged into an appropriate outlet that is installed and grounded in accordance with all local codes and ordinances.

WARNING: Improper connection of the equipment-grounding conductor can result in a risk of electric shock.

Check with a qualified electrician or service representative if you are in doubt whether the dishwasher is properly grounded. Do not modify the plug provided with the dishwasher; if it will not fit the outlet, have a proper outlet installed by a qualified electrician.

■ For a permanently connected dishwasher:

The dishwasher must be connected to a grounded metal, permanent wiring system, or an equipment-grounding conductor must be run with the circuit conductors and connected to the equipment-grounding terminal or lead on the dishwasher.

SAVE THESE INSTRUCTIONS



⚠ WARNING

Tip Over Hazard

Do not use dishwasher until completely installed.

Do not push down on open door.

Doing so can result in serious injury or cuts.

State of California Proposition 65 Warnings:

WARNING: This product contains one or more chemicals known to the State of California to cause cancer.

WARNING: This product contains one or more chemicals known to the State of California to cause birth defects or other reproductive harm.

Parts and Features

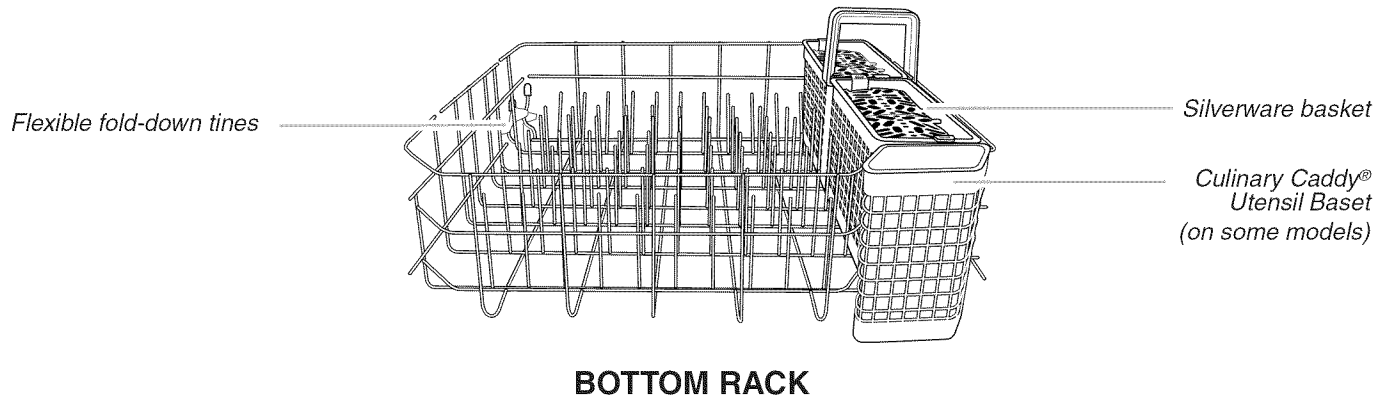
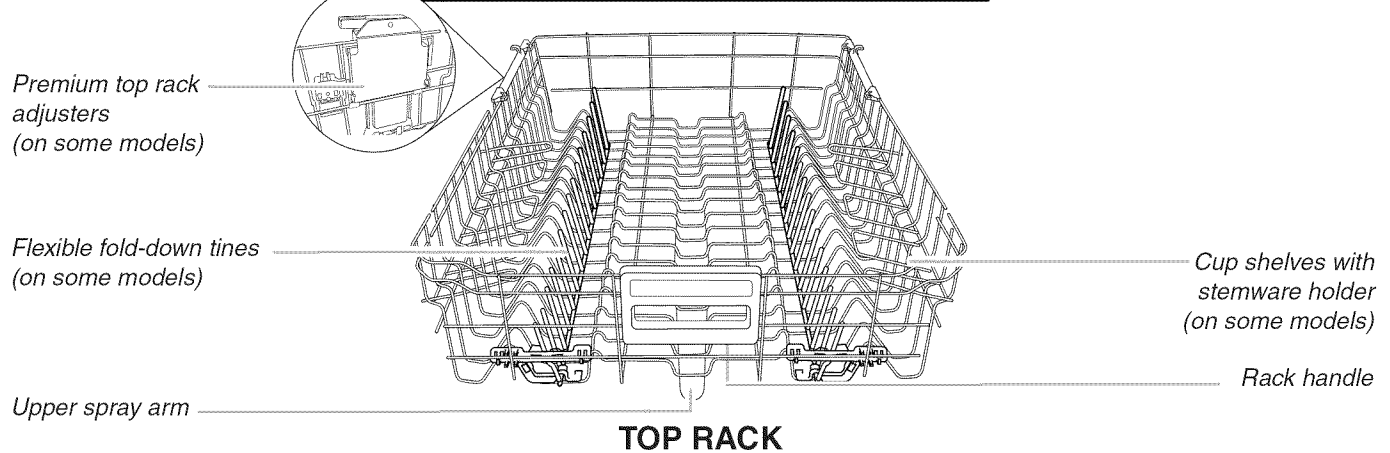
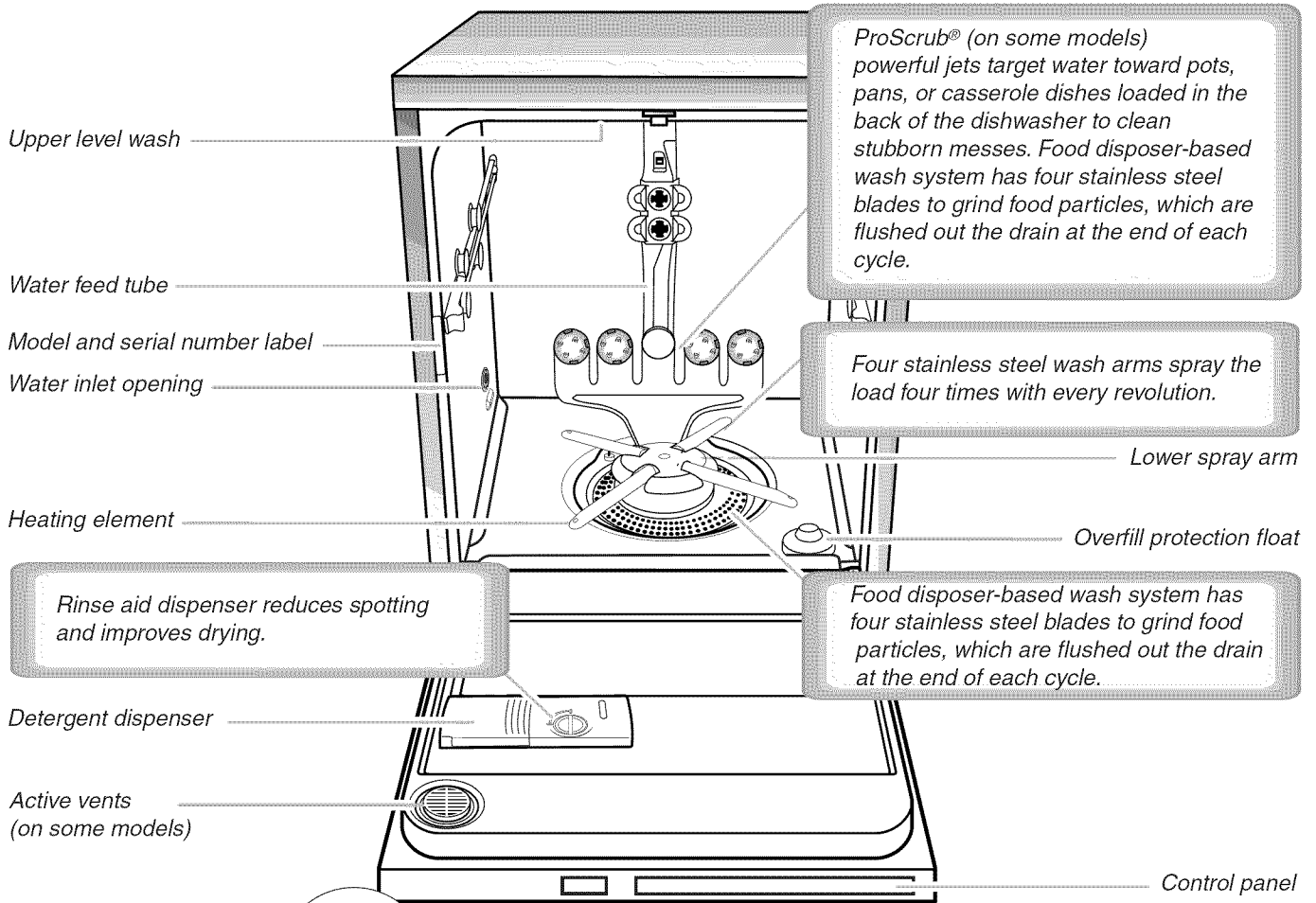

Start-Up / Quick Reference (varies by model)

IMPORTANT: Do not block detergent dispenser.

Tall items placed in the lower rack may block the dispenser door. Cookie sheets and cutting boards loaded on the left-hand side of the dishwasher can easily block the dispenser. If detergent is inside of the dispenser or on the bottom of the tub after the cycle is complete, the dispenser was blocked.

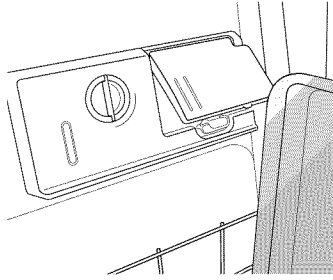

Drying - Rinse Aid is essential.

You must use a drying agent such as a rinse aid for good drying performance (sample included). Rinse aid along with the Heat Dry option will provide best drying and avoid excessive moisture in the dishwasher interior.

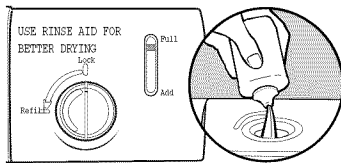

+ ■ Heat Dry

1 Hour Wash - When you need fast results.

Efficient dishwashers run longer to save water and energy, just as driving a car slower saves on gas. When you need fast results, the 1 Hour Wash will clean dishes using slightly more water and energy. Select the Heat Dry option to speed drying times (adds approximately 35 minutes to the 1 Hour Wash cycle).

■ 1 Hour Wash

Heavy Duty cycle for tough soil cleaning

The Heavy Duty cycle is recommended for tough soil loads. Use for hard-to-clean, heavily soiled pots, pans, casseroles, and regular tableware. No need to prerinse dishes; just scrape and load.

■ Heavy Duty

ProScrub® Option loading to clean baked-on food (on some models)

When the ProScrub® option is selected, it provides a concentrated wash on the back of the lower dish rack for hard-to-clean dishes. Place these dishes with the soiled surface of the dish toward the ProScrub® spray jets in the lower rack of the dishwasher.

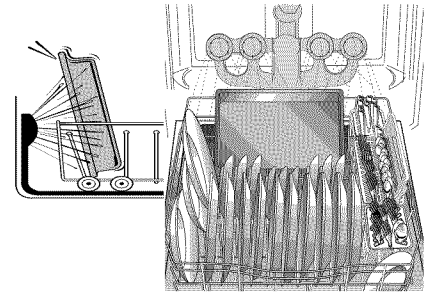

Press START/RESUME every time you add a dish.

IMPORTANT: If anyone opens the door (such as, for adding a dish, even during the Delay Hours option), the START/RESUME button must be pressed each time.

■ START/RESUME
Repeat Last Cycle

If the START/RESUME button is located on top of door: Push door firmly closed within 3 seconds of pressing START/RESUME. If the door is not closed within 3 seconds, the start button LED will flash, an audible tone will be heard, and the cycle will not start.

Proper Detergent Dosing

It is possible to use too much detergent in your dishwasher. This can lead to etching of your dishes. See "Add Detergent" in the "Dishwasher Use" section to determine the amount of detergent needed based on your water hardness.

Quick Steps

1 Prepare and load dishwasher.

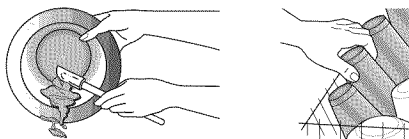

3 Select a cycle and option (cycles and options vary by model).

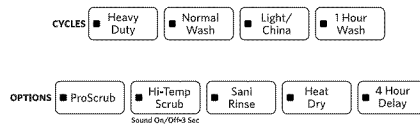

2 Add detergent for cleaning and rinse aid for drying.

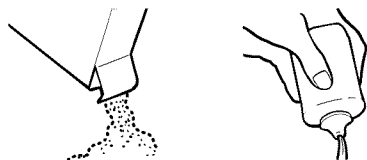

4 Start dishwasher.

NOTE: If the Start/Resume button is located on the top of door, push door firmly closed within 3 seconds of pressing START/RESUME.



Dishwasher Use

STEP 1

Prepare and Load the Dishwasher

IMPORTANT: Remove leftover food, bones, toothpicks and other hard items from the dishes. Remove labels from containers before washing.

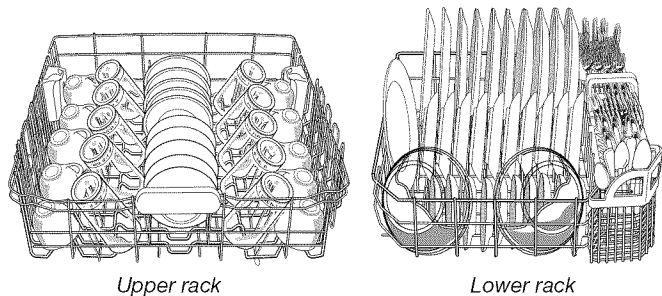

Upper rack

Lower rack

- Make sure nothing keeps spray arm(s) from spinning freely. It is important for the water spray to reach all soiled surfaces.
- Make sure that when the dishwasher door is closed no items are blocking the detergent dispenser.
- Items should be loaded with soiled surfaces facing down and inward to the spray as shown. This will improve cleaning and drying results.
- Avoid overlapping items like bowls or plates that may trap food.
- Place plastics, small plates and glasses in the upper rack. Wash only plastic items marked "dishwasher safe."
- To avoid thumping/clattering noises during operation: Load dishes so they do not touch one another. Make sure lightweight load items are secured in the racks.
- Improper loading can cause dishes to be chipped or damaged. When loading glasses or mugs, it is best to load these items in between rows of tines instead of loading them over tines, as shown in the image above.

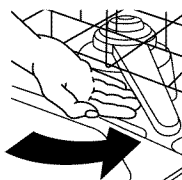

- When loading silverware, always place sharp items pointing down. Mix items in each section of the basket with some pointing up and some down to avoid nesting. Spray cannot reach nested items.



STEP 2

Add Detergent

NOTE: If you do not plan to run a wash cycle soon, run a Rinse Only cycle (on some models). Do not use detergent.

- Use automatic dishwasher detergent only. Add powder, liquid or tablet detergent just before starting a cycle.
- Fresh automatic dishwasher detergent results in better cleaning. Store tightly closed detergent container in a cool, dry place.

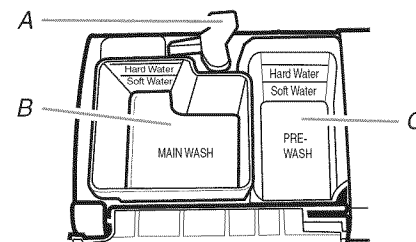

A. Cover latch
B. Main Wash section
C. Pre-Wash section

- The amount of detergent to use depends on:
 - How much soil remains on the items - Heavily soiled loads require more detergent.
 - The hardness of the water - If you use too little in hard water, dishes won't be clean. If you use too much in soft water, glassware will etch.
 - Soft to Medium Water (0-6 grains per U.S. gallon) [typical water softener water and some city water]
 - Medium to Hard Water (7-12 grains per U.S. gallon) [well water and some city water]
- Depending on your water hardness, fill the Main Wash section of the dispenser as shown. Fill the Pre-wash section to the level shown, if needed.

NOTE: Fill amounts shown are for standard powdered detergent. Follow instructions on the package when using other dishwasher detergent types.

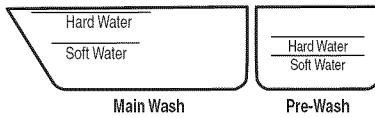

Premeasured forms are suitable for all hardness and soil levels. Always place premeasured detergents in the main compartment and close the lid.

Add Rinse Aid

- Your dishwasher is designed to use rinse aid for good drying performance. Without rinse aid your dishes and dishwasher interior will have excessive moisture. The Heat Dry option will not perform as well without rinse aid.
- Rinse aid keeps water from forming droplets that can dry as spots or streaks. They also improve drying by allowing water to drain off of the dishes after the final rinse.
- Rinse aid helps to reduce excess moisture on the dish racks and interior of your dishwasher.
- Check the rinse aid indicator. Add rinse aid when indicator drops to "Add" level.
- To add rinse aid, turn the dispenser cap to "Refill" and lift off. Pour rinse aid into the opening until the indicator level is at "Full." Replace the dispenser cap and turn to "Lock." Make sure cap is fully locked.

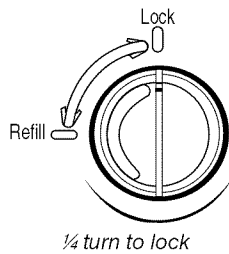
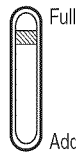

NOTE: For most water conditions, the factory setting of 2 will give good results. If you have hard water or notice rings or spots, try a higher setting. Turn the arrow adjuster inside the dispenser by either using your fingers or inserting a flat-blade screwdriver into the center of the arrow and turning.

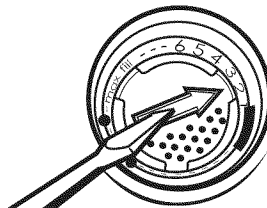

STEP 3

Select a Cycle (cycles vary by model)

See "Cycle and Option Descriptions" charts in the following section.

Efficient dishwashers run longer to save water and energy, just as driving a car slower saves on gas. Typical cycle time is approximately 2½ hours, but can take less or more time to complete depending on selections.

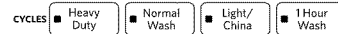

Select Options (options vary by model)

See "Cycle and Option Descriptions" charts in the following section.

You can customize your cycles by pressing the options desired. If you change your mind, press the option again to turn off the option, or select a different option. Not all options are available for every cycle. If an invalid option is selected for a given cycle, the lights will flash.

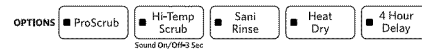

STEP 4

Start or Resume a Cycle

- Run hot water at the sink nearest your dishwasher until the water is hot. Turn off water.
- Press START/RESUME once to show which selections you used. Select the wash cycle and options desired OR press START/RESUME to repeat the same cycle and options as in the previous wash cycle.



IMPORTANT: If anyone opens the door (such as, for adding a dish, even during the Delay Hours option), the Start/Resume button must be pressed each time.

- If the Start/Resume button is located on top of door, push door firmly closed within 3 seconds of pressing START/RESUME. If the door is not closed within 3 seconds, the Start/Resume button LED will flash, an audible tone will be heard, and the cycle will not start.

Cycle and Option Descriptions

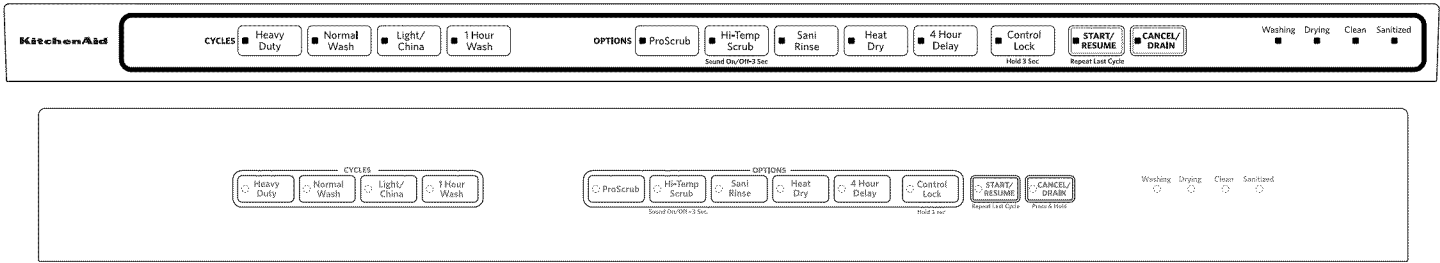

This information covers several different models. Your dishwasher may not have all the cycles and options described.

CYCLE SELECTIONS

CYCLES	SOIL LEVEL	WASH TIME* (MINS.) W/O OPTIONS		WATER USAGE GALLONS (Liters)
		Typical**	Max	
<input type="checkbox"/> Heavy Duty Use for hard-to-clean, heavily soiled pots, pans, casseroles, and regular tableware.	Light to Medium	115	165	6.4 (24.3)
	Heavy/Baked-On	120	170	6.4 (24.3)
<input type="checkbox"/> Normal Wash Use for loads with normal amounts of food soil. The energy-usage label is based on this cycle.	Light	85 - 100	170	3.9 (14.7)
	Medium	105	165	4.6 (17.5)
	Heavy	120	170	6.4 (24.3)
<input type="checkbox"/> Light/China Use for lightly soiled items or china and crystal.	Light	75	135	3.9 (14.7)
	Medium	80	145	5.5 (20.7)
	Heavy	100	160	5.5 (20.7)
<input type="checkbox"/> 1 Hour Wash When you need fast results, the 1 Hour Wash will clean dishes using slightly more water and energy. Select the Heat Dry or ProDry™ option to speed drying times (add approximately 27 to 35 minutes to the 1 Hour Wash cycle).	All soil levels	60	62	6.4 (24.3)
<input type="checkbox"/> Rinse Only Use for rinsing dishes, glasses, and silverware that will not be washed right away. Do not use detergent.	All soil levels	10	12	1.7 (6.3)

Wash times depend on water temperature, heavy soil condition, dish load size and options selected. Adding options will add time to the cycle.





* Adding options will add time to the cycle. See options information section.

** This is the approximate cycle time obtained with 120°F (49°C) hot water available at the dishwasher. Increase in time results from low temperature of the incoming water.



OPTION SELECTIONS

OPTIONS	CAN BE SELECTED WITH	WHAT IT DOES	ADDED TIME TO CYCLE		ADDED WATER GALLONS (LITERS)
			TYPICAL	MAX	
<input type="checkbox"/> ProScrub Cleans pans, casseroles, etc., with tough food soil to eliminate the need for soaking and scrubbing of dirty, baked-on dishes.	Heavy Duty Normal Wash	Activates the ProScrub® spray jets to provide intensified cleaning power to items at the back of the lower rack.	45	85	0 - 1.6 (0 - 6)
<input type="checkbox"/> Hi-Temp Scrub Raises the main wash temperature to improve cleaning for loads containing tough, baked-on food.	Heavy Duty Normal Wash	Raises the main wash temperature from 105°F (41°C) to 145°F (63°C) and the final rinse from 130°F (54°C) to 140°F (60°C).	45	85	0 - 1.6 (0 - 6)

OPTION SELECTIONS



OPTIONS	CAN BE SELECTED WITH	WHAT IT DOES	ADDED TIME TO CYCLE		ADDED WATER GALLONS (LITERS)
			TYPICAL	MAX	
 Sani Rinse	Heavy Duty Normal Wash	Raises the main wash temperature from 105°F (41°C) to 145°F (63°C) and the final rinse from 140°F (60°C) to 155°F (68°C).	60	105	0 - 1.6 (0 - 6)
 Heat Dry	Available with any cycle except Rinse Only	Activates the heating element at the end of the wash cycle to speed drying times. Heat Dry defaults to ON when any cycle is selected except for 1 Hour Wash.	52	52	0
 4 Hour Delay	Available with any cycle	Delays the start of a cycle up to 4 hours.	240	240	0
<p>Control Lock</p>  Control Lock Hold 3 Sec	<p>Avoids unintended use of the dishwasher between cycles, or cycle and option changes during a cycle.</p> <p>To turn on Control Lock, press and hold for 3 seconds. The Control Lock light will stay on for a short time, indicating that it is activated, and all buttons are disabled. If you press any button while your dishwasher is locked, the light flashes 3 times. The dishwasher door can still be opened/closed while the controls are locked.</p> <p>NOTE: You may need to disable Sleep Mode by pressing either START/RESUME or CANCEL, or by opening and closing the door before you are able to turn Control Lock off.</p> <p>To turn off Control Lock, press and hold for 3 seconds. The light turns off.</p>				

CONTROLS AND CYCLE STATUS

CONTROL	PURPOSE	COMMENTS
	To start or resume a wash cycle	If the door is opened during a cycle or the power is interrupted, the Start/Resume indicator flashes. The cycle will not resume until the door is closed and START/RESUME is pressed. NOTE: If the Start/Resume button is located on top of door, push door firmly closed within 3 seconds of pressing START/RESUME. If the door is not closed within 3 seconds, the Start/Resume button LED will flash, an audible tone will be heard, and the cycle will not start.
	To reset any cycle or options during selection. To cancel a wash cycle after it's started.	Press and hold CANCEL/DRAIN to reset any control selections made. See "Canceling A Cycle After Dishwasher Is Started" and "Changing A Cycle After Dishwasher Is Started" sections.
	To turn the audible tones on or off.	Press and hold the Hi-Temp Scrub button for 3 seconds to turn the audible tones on or off. Only audible tones for confirming button presses can be turned on/off. Important audible tones, such as indicating a cycle has been interrupted, cannot be deactivated.

Dishwasher Feedback Section

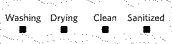
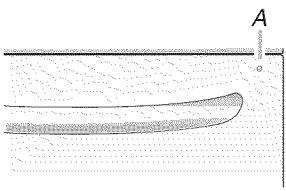
CONTROLS AND CYCLE STATUS

CONTROL	PURPOSE	COMMENTS
	The Cycle Status Indicator Lights are used to follow the progress of the dishwasher cycle. Located on the front of the dishwasher for front control models, and located on the top of the door for hidden control models.	Clean indicator glows when a cycle is finished. If you select the Sani Rinse option, when the Sani Rinse cycle is finished, the Sanitized indicator glows. If your dishwasher did not properly sanitize your dishes, the light flashes at the end of the cycle. This can happen if the cycle is interrupted, or the water could not be heated to the required temperature. The Clean and Sanitized lights go off when you open and close the door or press and hold CANCEL.
	The Front Indicator Light or Single Exterior Light (A) shows progress of your dishwasher cycle by color. (Available on some hidden control models only).	The light will be blue if the dishwasher is washing or rinsing. The light will be red when the dishwasher is drying. The light will be green to indicate that the cycle is complete. If the Front Indicator Light is blinking, see "Troubleshooting" section.
	The Cycle Status Display is used to follow the progress of the dishwasher cycle, and to show other information. (Available on some models instead of Cycle Status Indicator Lights)	The indicators will inform you if you are able to add a dish to the cycle after it has started. It will also inform you if the dishwasher is washing, rinsing, drying, complete, and/or sanitized. They will show whether the control is locked and/or the delay option is selected. A series of bars will count down the duration of the cycle remaining from left to right. Each bar equals approximately 24 minutes of cycle length. The bars will also count down the delay feature from left to right, and the delay indicator will be activated.

Canceling A Cycle

1. Press and hold the Cancel/Drain button once. The Cancel/Drain light will turn on. If the Cancel/Drain button is located on the top of the door, open the door slightly to stop the cycle. Wait for the spraying action to stop before completely opening the door. Press and hold the Cancel/Drain button once.
2. Close the door and the dishwasher starts a drain cycle (if water remains in bottom of dishwasher). Let the dishwasher drain completely. The Cancel/Drain light turns off after 2 minutes.

Changing A Cycle After Dishwasher Is Started

1. You can interrupt a cycle and restart your dishwasher from the beginning using the following procedure.
2. Press and hold the Cancel/Drain button twice to reset the control. If the Cancel/Drain button is located on the top of the door, open the door slightly to stop the cycle. Wait for the spraying action to stop before completely opening the door. Press and hold the Cancel/Drain button twice to reset the control.

3. Select new cycles and options.
4. Press START/RESUME.

Adding A Dish After Dishwasher Is Started

1. Check if Add a Dish indicator is lit. (Available on some models. Otherwise, proceed to Step 2.)
2. Open the door slightly to stop the cycle. Wait for the spraying action to stop, then open the door completely.
3. Check whether the detergent dispenser cover is still closed. If it is open, the wash cycle has already started and adding a dish is not recommended.
4. If detergent has not yet been used (detergent dispenser cover is closed), you may add a dish.
5. Press START/RESUME.

Dishwasher Features

Your KitchenAid dishwasher may have some or all of these features.

ProScrub® Option Wash Area

The ProScrub® option wash area is located at the back of the lower level rack.

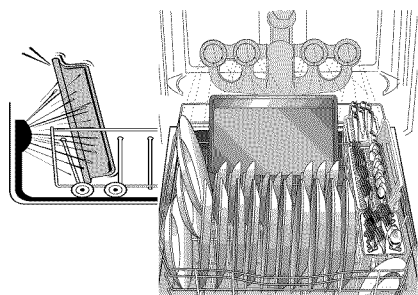

NOTE: You must select the ProScrub® wash option to use this feature. Make sure items do not interfere with the water feed tube, spray arms, or ProScrub® spray jets.

- Keep the last tine row in the back of the lower rack in the 60° angled position when using the ProScrub® option.
- Load pans, casserole dishes, etc., in the back of the lower dish rack with the soiled surfaces facing the ProScrub® spray jets, and resting on the last row of tines in the angled position.
- Only one row of items may face the ProScrub® spray jets. Stacking, overlapping or nesting items will keep the ProScrub® spray jets from contacting all of the surfaces.

Silverware Basket

Use the slots in the covers to keep your silverware separated for optimum wash. There are specially designed slots (small round holes) for chopsticks. Mix silverware types to keep them separated. Load knives down, forks up, and alternate spoons, for best cleaning results.

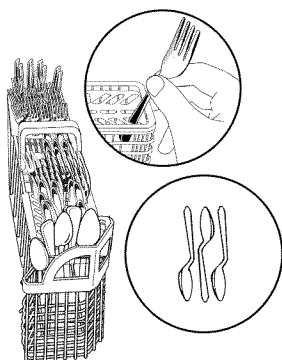

NOTE: If your silverware does not fit into the designated slots, flip the covers up and push them down into the basket.

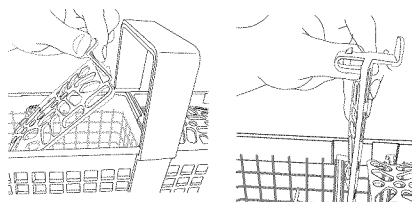

CULINARY CADDY® Utensil Basket

Use the utensil basket to hold specialty cooking utensils (serving spoons, spatulas, and similar items), or overflow silverware items.

The basket hangs on the bottom rack in the right-hand corner. Load the basket while it is on the bottom rack or remove the basket for loading on a counter or table.

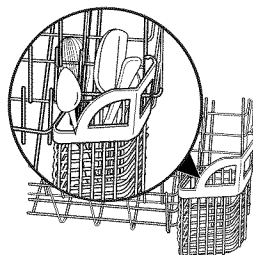

NOTE: Spin the spray arms while the bottom rack is inside the dishwasher to be sure items in the basket do not stop the rotation of the arms.

Manual Adjustable 2-Position Top Rack

You can raise or lower the top rack to fit tall items in either the top or bottom rack. Adjusters are located on each side of the top rack. Raise the top rack to accommodate items up to 9" (22 cm) in the top rack and 13" (33 cm) in the bottom rack, or lower the top rack to accommodate items up to 11" (28 cm) in both the top and bottom racks.

IMPORTANT: Remove dishes prior to removing the top rack from the dishwasher.

1. To raise, remove rack and slide lower wheels into the rails as directed in "Removable Top Rack" section.
2. To lower, remove rack and slide upper wheels into the rails as directed in "Removable Top Rack" section.

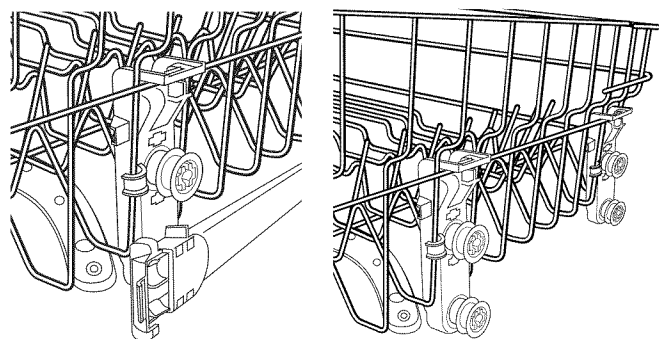

Premium Adjustable 2-Position Top Rack

You can raise or lower the top rack to fit tall items in either the top or bottom rack. Adjusters are located on each side of the top rack. Each adjuster has 2 preset positions.

To raise the rack, press both rack adjusters and lift the rack until it is in the Up position and level.

To lower the rack, press both rack adjusters and slide the rack to its Down position and level.

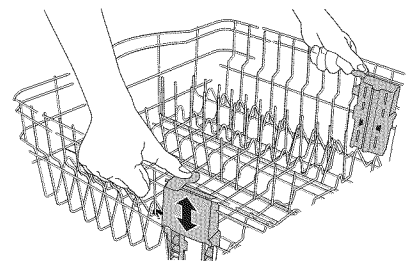

FLEXI-FOLD DOWN™ Flexible Tines

The row of tines on the left-hand and right-hand sides of the top rack can be adjusted to make room for a variety of dishes.

To adjust the fold-down tines:

1. Grasp the tip of the tine that is in the tine holder.
2. Gently push the tine out of the holder.
3. Lay the tines down, toward the center of the rack.

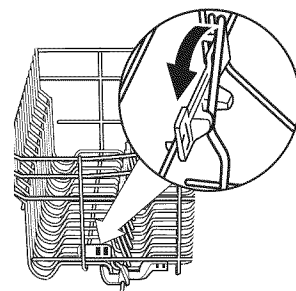

NOTE: The bottom rack may also have 1 or 2 rows of flexible tines located in the back of the rack. Follow the same instructions to adjust.

Removable Top Rack (for SatinGlide® rails)

The removable top rack allows you to wash larger items such as pots, roasters, and cookie sheets in the bottom rack.

IMPORTANT: Remove dishes prior to removing the top rack from dishwasher.

To remove the rack

To gain access to the track stops, pull the upper rack forward about halfway out of the tub.

To open, flip the track stop toward the outside of the tub.

After opening both track stops, pull top rack out of the rails.

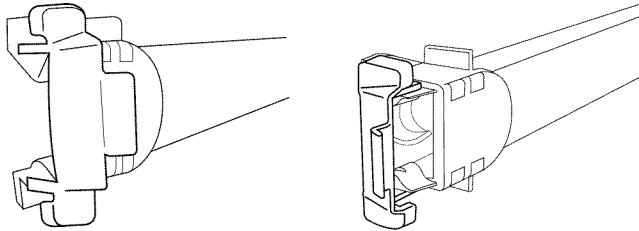

Track stop closed.

Track stop open

SURE-HOLD® Cup and Stemware Holder

Fold down the extra shelf on the left-hand or right-hand side of the top rack to hold additional cups, stemware or long items such as utensils and spatulas.

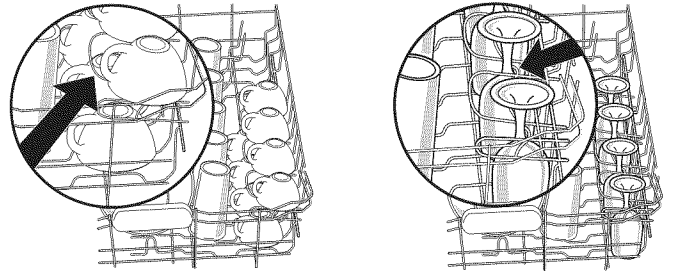

SURE-HOLD® Light Item Clips

The light item clips hold lightweight plastic items such as cups, lids, or bowls in place during washing.

To move a clip:

1. Pull the clip up and off the tine.
2. Reposition the clip on another tine.

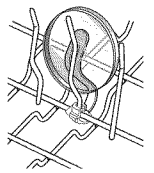

Dishwasher Care

Cleaning

Cleaning the exterior

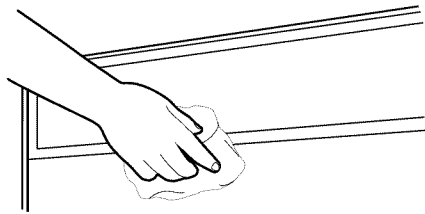

In most cases, regular use of a soft, damp cloth or sponge and a mild detergent is all that is necessary to keep the outside of your dishwasher looking nice and clean. If your dishwasher has a stainless steel exterior, a stainless steel cleaner is recommended.

Cleaning the interior

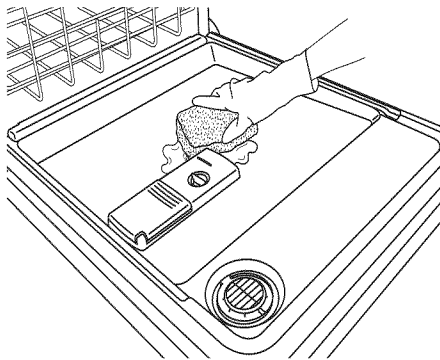

Hard water minerals can cause a white film to build up on the inside surfaces, especially just beneath the door area.

Do not clean the dishwasher interior until it has cooled. You may want to wear rubber gloves. Do not use any type of cleanser other than dishwasher detergent because it may cause foaming or sudsing.

To clean interior

Make a paste with powdered dishwasher detergent on a damp sponge and clean.

OR

Use liquid automatic dishwasher detergent and clean with a damp sponge.

OR

See the vinegar rinse procedure in “Cloudy or Spotted Dishware (and Hard Water Solution)” in “Troubleshooting” section.

NOTE: Run a normal cycle with dishwasher detergent after cleaning the interior.

Drain Air Gap

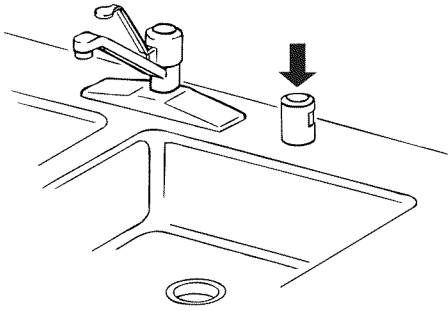

Some state or local plumbing codes require the addition of a drain air gap between a built-in dishwasher and the home drain system. Check the drain air gap when your dishwasher is not draining well.

The drain air gap is usually located on top of the sink or countertop near the dishwasher.

NOTE: The drain air gap is an external plumbing device that is not part of your dishwasher. The warranty provided with your dishwasher does not cover service costs directly associated with the cleaning or repair of the external drain air gap.

To clean the drain air gap

Clean the drain air gap periodically to ensure proper drainage of your dishwasher. With most types, you lift off the chrome cover. Unscrew the plastic cap. Then check for any soil buildup. Clean if necessary.

Storing

Storing for the summer

If your dishwasher is not in use during the summer months, turn off the water supply and power supply to the dishwasher.

Storing for the winter

Avoid possible water damage to your home and dishwasher due to freezing water lines. If your dishwasher is left in a seasonal dwelling or could be exposed to near freezing temperatures, have your dishwasher winterized by authorized service personnel.

Troubleshooting

First try the solutions suggested here or visit our website and reference FAQs (Frequently Asked Questions) to possibly avoid the cost of a service call.

In the U.S.A., www.kitchenaid.com In Canada, www.kitchenaid.ca

PROBLEM	SOLUTION
DISHWASHER DOES NOT RUN	<p>NOTE: It is normal for the dishwasher to repeatedly pause several times during a cycle. If the Start/Resume light is blinking, close the door and push START/RESUME.</p> <p>Be sure the door is closed and latched.</p> <p>Be sure you have disabled Sleep Mode by pressing either START/RESUME or CANCEL, or by opening and closing the door before selecting your cycle/option.</p> <p>Check that there is not an interference with large casserole dishes and the wash system at the back of the dishwasher. Adjust loading as necessary to ensure door is closed and latched.</p> <p>Be sure you have selected a cycle. (See "Cycles and Options Descriptions" section.)</p> <p>Be sure there is power to the dishwasher. A circuit breaker or fuse may have tripped.</p> <p>If lights other than Start/Resume blink and the unit will not run, you will need to call for service.</p>
DETERGENT REMAINS IN THE DISPENSER OR TABLET IS ON BOTTOM OF TUB	<p>Check for dishware such as cookie sheets, cutting boards, or large containers, etc., that may be blocking the detergent dispenser from opening properly.</p> <p>Be sure your detergent is fresh and lump free.</p> <p>Be sure the cycle has completed (the Clean light is on). If it has not completed, you will need to resume the cycle by closing the door and pressing START/RESUME.</p>
CYCLE RUNS TOO LONG	<p>NOTES:</p> <ul style="list-style-type: none">■ To use less water and reduce energy consumption you will encounter cycles that typically run for up to 3 hours.■ A water heater setting of 120°F (49°C) is best, the dishwasher will delay longer while heating cooler water.■ Some options will add time to the cycle. (See "Cycles and Options Descriptions" section.) The Heat Dry option adds approximately ½ hour. <p>Try the 1 Hour Wash cycle.</p> <p>Run the hot water at a faucet close to the dishwasher before starting the cycle.</p>

PROBLEM	SOLUTION
DISHWASHER NOT DRYING	<p>NOTE: Plastic and items with nonstick surfaces are difficult to dry because they have a porous surface which tends to collect water droplets. Towel drying may be necessary. Use of rinse aid along with the Heat Dry option is needed for proper drying. Proper loading of items can affect drying. (See specific loading instructions within this guide.) Glasses and cups with concave bottoms hold water. This water may spill onto other items when unloading.</p> <ul style="list-style-type: none"> ■ Unload the bottom rack first. ■ Locate these items on the more slanted side of the rack for improved results.
WILL NOT FILL	<p>Be sure the water is turned on to the dishwasher. Check that the float is free from obstructions. (See “Parts and Features.”) Check for suds in the dishwasher. If foam or suds are detected, the dishwasher may not operate properly or may not fill with water. (See “Blinking Lights” in “Troubleshooting.”)</p>
WATER REMAINS IN THE TUB/WILL NOT DRAIN	<p>Be sure the cycle has completed (the Clean light is on). If it has not, you will need to resume the cycle by closing the door and pressing START/RESUME. If dishwasher is connected to a food waste disposer, be sure the knockout plug has been removed from the disposer inlet. Check for kinks in the drain hose. Check for food obstructions in the drain or disposer. Check your house fuse or circuit breaker.</p>
HARD WATER (WHITE RESIDUE ON DISHWASHER INTERIOR OR GLASSWARE)	<p>NOTE: Extremely hard water mineral deposits can cause damage to your dishwasher and make it difficult to achieve good cleaning. A water softener is strongly recommended if your hardness is 15 grains or more. If a water softener is not installed, the following steps may help: Use a commercial cleaner designed for dishwashers once per month. Always use a rinse aid. Always use a high-quality, fresh detergent. Use a detergent booster/water softener additive designed for dishwashers.</p>
ODORS	<p>NOTE: If the dishwasher is not used daily, you can run a rinse cycle with the partial load daily until a full load is ready to run, or use the Top Rack Only option (on some models) for partial loads. Run a vinegar rinse through the dishwasher by putting 2 cups (500 mL) of white vinegar in an upright glass measuring cup in the lower rack. Run a normal cycle with the Heat Dry option turned off. Do not use detergent. The dishwasher may not be draining properly, see “Water Remains In The Tub/Will Not Drain” in “Troubleshooting.”</p>
NOISY	<p>NOTES:</p> <ul style="list-style-type: none"> ■ Surging sounds can occur periodically throughout the cycle while the dishwasher is draining. ■ Normal water valve hissing may be heard periodically. ■ A normal snap sound may be heard when the detergent dispenser opens during the cycle and when the door is opened at the end of the cycle. ■ Improper installation will affect noise levels. <p>A thumping sound may be heard if items extend beyond the racks and interfere with the wash arms. Readjust the dishware and resume the cycle.</p>
FOOD SOILS REMAIN ON DISHES	<p>Be sure the dishwasher is loaded correctly. Improper loading can greatly decrease the washing performance (see “Dishwasher Use”). Select the proper cycle and option for the type of soils. The Heavy Duty cycle with the ProScrub® (on some models) option can be used for tougher loads. Be sure the incoming water temperature is at least 120°F (49°C). Use the proper amount of fresh detergent. More detergent is needed for heavier-soiled loads and hard water conditions. Scrape food from dishes prior to loading (do not prerinse).</p>
DISHES DIRTY/SUDS IN DISHWASHER/CYCLE NOT COMPLETE	<p>If foam or suds are detected by the dishwasher sensing system, the dishwasher may not operate properly or may not fill with water. Suds can come from:</p> <ul style="list-style-type: none"> ■ Using the incorrect type of detergent, such as dish detergent for hand washing dishes, laundry detergent, or hand soap. ■ Not replacing the rinse aid dispenser cap after filling (or refilling) the rinse aid. ■ Using an excessive amount of dishwasher detergent. <p>Call for service. If no water was present in the machine at any time during a heated wash cycle, the cycle will end and the Clean LED will not come on. See “Will Not Fill” in “Troubleshooting.”</p>
DID NOT SANITIZE	<p>If the sanitized light is blinking, the load is <i>NOT</i> sanitized. The cycle was interrupted in the final rinse, or the temperature for your water heater is set too low. Set your water heater to 120°F (49°C).</p>

PROBLEM	SOLUTION
DAMAGE TO DISHWARE	Improper loading can cause dishes to become chipped or damaged. (See specific loading instructions within this guide.)
BLINKING LIGHTS	<p>Blinking LED's will occur when the cycle is paused or when the cycle has been interrupted by opening the door. In this case, the Start/Resume button LED, the Cycle Status Indicator LED(s), and the countdown bars on the Cycle Status Display all blink together to indicate that attention is needed. See Start or Resume a Cycle in the "Dishwasher Use" section.</p> <p>Blinking LED's can also occur when certain errors have been detected. In this case, the Clean/Complete LED will blink one time with a pause in between blinks.</p> <p>Call for service.</p>
CLOUDY OR SPOTTED DISHWARE (AND HARD WATER SOLUTION)	<p>NOTES:</p> <ul style="list-style-type: none"> ■ Liquid rinse aid is necessary for drying and to reduce spotting. ■ Use the correct amount of detergent. <p>Confirm that the cloudiness is removable by soaking the item in white vinegar for 5 minutes. If the cloudiness disappears, it is due to hard water. Adjust the amount of detergent and rinse aid. (See "Hard Water [White Residue On Dishwasher Interior Or Glassware] in "Troubleshooting.") If it does not come clear, it is due to etching (see below).</p> <p>Be sure the incoming water temperature is set at 120°F (49°C).</p> <p>Try using the High Temp and Sani Rinse options.</p> <p>To remove spotting, run a vinegar rinse through the dishwasher.</p> <ul style="list-style-type: none"> ■ Wash and rinse the affected dishware and load into dishwasher. Remove all silverware and metal items. Put 2 cups (500 mL) of white vinegar in a glass measuring cup in the lower rack. Run a normal cycle with the Heat Dry option turned off. No detergent is needed.
ETCHING (PERMANENT CLOUDINESS)	This is an erosion of the surface of the glassware and can be caused by a combination of: water that is too hot, from using too much detergent with soft water or by pre-washing. Detergent needs food soil to act upon. If etching has occurred, the glassware is permanently damaged. To avoid further etching, adjust the detergent amount to match the water hardness, stop pre-washing, and use water heating options only when incoming water temperature is below 120°F (49°C).
LEAKING WATER	<p>Be sure dishwasher has been installed properly and is level.</p> <p>Suds can cause the dishwasher to overflow. Measure the detergent accurately and use only detergents designed for use in a dishwasher. Less detergent is needed in soft water. Try another brand of detergent if sudsing continues.</p> <p>To avoid rinse aid leaking from the dispenser, be sure the lid is securely attached and avoid overfilling.</p>
TUB IS DISCOLORED	<p>NOTES:</p> <ul style="list-style-type: none"> ■ High iron content in the water can discolor the tub. ■ Tomato-based foods can discolor the tub or dishware. <p>A citrus-based cleaner can be used to clean.</p>

KITCHENAID® DISHWASHER WARRANTY

LIMITED WARRANTY

For one year from the date of purchase, when this major appliance is operated and maintained according to instructions attached to or furnished with the product, KitchenAid brand of Whirlpool Corporation or Whirlpool Canada LP (hereafter "KitchenAid") will pay for factory specified parts and repair labor to correct defects in materials or workmanship that existed when this major appliance was purchased. Service must be provided by a KitchenAid designated service company. YOUR SOLE AND EXCLUSIVE REMEDY UNDER THIS LIMITED WARRANTY SHALL BE PRODUCT REPAIR AS PROVIDED HEREIN. This limited warranty is valid only in the United States or Canada and applies only when the major appliance is used in the country in which it was purchased. Proof of original purchase date is required to obtain service under this limited warranty.

SECOND THROUGH FIFTH YEAR LIMITED WARRANTY ON CERTAIN COMPONENT PARTS

In the second through the fifth year from the date of purchase, when this major appliance is operated and maintained according to instructions attached to or furnished with the product, KitchenAid will pay for factory specified parts for the following components to correct defects in materials or workmanship that existed when this major appliance was purchased: nylon dish racks and electronic controls.

LIFETIME LIMITED WARRANTY ON STAINLESS STEEL TUB AND INNER DOOR LINER

For the lifetime of the product from the date of purchase, when this major appliance is installed, operated and maintained according to instructions attached to or furnished with the product, KitchenAid will pay for factory specified parts and repair labor for the following components to correct defects in materials or workmanship that existed when this major appliance was purchased: stainless steel tub and inner door liner.

ITEMS EXCLUDED FROM WARRANTY

This limited warranty does not cover:

1. Replacement parts or repair labor if this major appliance is used for other than normal, single-family household use or when it is used in a manner that is inconsistent to published user or operator instructions and/or installation instructions.
2. Service calls to correct the installation of your major appliance, to instruct you on how to use your major appliance, to replace or repair house fuses, or to correct house wiring or plumbing.
3. Service calls to repair or replace appliance light bulbs, air filters or water filters. Consumable parts are excluded from warranty coverage.
4. Damage resulting from accident, alteration, misuse, abuse, fire, flood, acts of God, improper installation, installation not in accordance with electrical or plumbing codes, or use of products not approved by KitchenAid.
5. Cosmetic damage, including scratches, dents, chips or other damage to the finish of your major appliance, unless such damage results from defects in materials or workmanship and is reported to KitchenAid within 30 days from the date of purchase.
6. Any food or medicine loss due to refrigerator or freezer product failures.
7. Pickup and delivery. This major appliance is intended to be repaired in your home.
8. Repairs to parts or systems resulting from unauthorized modifications made to the appliance.
9. Expenses for travel and transportation for product service if your major appliance is located in a remote area where service by an authorized KitchenAid servicer is not available.
10. The removal and reinstallation of your major appliance if it is installed in an inaccessible location or is not installed in accordance with KitchenAid's published installation instructions.
11. Replacement parts or repair labor on major appliances with original model/serial numbers that have been removed, altered or cannot be easily determined.

DISCLAIMER OF IMPLIED WARRANTIES

IMPLIED WARRANTIES, INCLUDING ANY IMPLIED WARRANTY OF MERCHANTABILITY OR IMPLIED WARRANTY OF FITNESS FOR A PARTICULAR PURPOSE, ARE LIMITED TO ONE YEAR OR THE SHORTEST PERIOD ALLOWED BY LAW. Some states and provinces do not allow limitations on the duration of implied warranties of merchantability or fitness, so this limitation may not apply to you. This warranty gives you specific legal rights, and you also may have other rights that vary from state to state or province to province.

LIMITATION OF REMEDIES; EXCLUSION OF INCIDENTAL AND CONSEQUENTIAL DAMAGES

YOUR SOLE AND EXCLUSIVE REMEDY UNDER THIS LIMITED WARRANTY SHALL BE PRODUCT REPAIR AS PROVIDED HEREIN. KITCHENAID SHALL NOT BE LIABLE FOR INCIDENTAL OR CONSEQUENTIAL DAMAGES. Some states and provinces do not allow the exclusion or limitation of incidental or consequential damages, so these limitations and exclusion may not apply to you. This warranty gives you specific legal rights, and you also may have other rights that vary from state to state or province to province.

If outside the 50 United States and Canada, contact your authorized KitchenAid dealer to determine if another warranty applies.

If you think you need repair service, first see the "Troubleshooting" section of the Use & Care Guide. If you are unable to resolve the problem after checking "Troubleshooting," additional help can be found by checking the "Assistance or Service" section or by calling KitchenAid. In the U.S.A., call **1-800-422-1230**. In Canada, call **1-800-807-6777**.

2/10

For additional product information or to view FAQs (Frequently Asked Questions), in U.S.A. visit: www.kitchenaid.com
In Canada visit: www.kitchenaid.ca

If you do not have access to the Internet and you need assistance using your product or you would like to schedule service, you may contact KitchenAid at the number below.

Have your complete model number ready. You can find your model and serial number on the label located near the door on the right-hand or left-hand side of the dishwasher interior.

For assistance or service in the U.S.A., call 1-800-422-1230. In Canada, call 1-800-807-6777.

If you need further assistance, you can write to KitchenAid with any questions or concerns at the address below:

In the U.S.A.:

KitchenAid Brand Home Appliances
Customer eXperience Center
553 Benson Road
Benton Harbor, MI 49022-2692

In Canada:

KitchenAid Brand Home Appliances
Customer eXperience Centre
200 – 6750 Century Avenue
Mississauga ON L5N 0B7

Please include a daytime phone number in your correspondence.

Please keep this User Instructions and model number information for future reference.