



# DISHWASHER USER INSTRUCTIONS

THANK YOU for purchasing this high-quality product. If you should experience a problem not covered in TROUBLESHOOTING, please visit our website at [www.whirlpool.com](http://www.whirlpool.com) for additional information. If you still need assistance, call us at 1-800-253-1301. In Canada, visit our website at [www.whirlpool.ca](http://www.whirlpool.ca) or call us at 1-800-807-6777.

You will need your model and serial number located near the door on the right-hand or left-hand side of the dishwasher interior.

Para obtener acceso a "Instrucciones para el usuario de la lavavajillas" en español, o para obtener información adicional acerca de su producto, visite : [www.whirlpool.com](http://www.whirlpool.com)

Tenga listo su número de modelo completo. Puede encontrar su número de modelo y de serie en la etiqueta ubicada cerca de la puerta al lado derecho o izquierdo del interior de la lavavajillas.

## Table of Contents

DISHWASHER SAFETY .....	1
WHAT'S NEW IN YOUR DISHWASHER .....	3
PARTS AND FEATURES .....	4
QUICK STEPS.....	5
DISHWASHER USE .....	6
CYCLE AND OPTION DESCRIPTIONS .....	8
DISHWASHER FEATURES.....	11
FILTRATION SYSTEM.....	13
DISHWASHER CARE .....	14
TROUBLESHOOTING .....	15

## Dishwasher Safety

### Your safety and the safety of others are very important.

We have provided many important safety messages in this manual and on your appliance. Always read and obey all safety messages.



This is the safety alert symbol.

This symbol alerts you to potential hazards that can kill or hurt you and others.

All safety messages will follow the safety alert symbol and either the word "DANGER" or "WARNING."

These words mean:

**⚠ DANGER**

You can be killed or seriously injured if you don't immediately follow instructions.

**⚠ WARNING**

You can be killed or seriously injured if you don't follow instructions.

All safety messages will tell you what the potential hazard is, tell you how to reduce the chance of injury, and tell you what can happen if the instructions are not followed.

## IMPORTANT SAFETY INSTRUCTIONS

**WARNING:** When using the dishwasher, follow basic precautions, including the following:

- Read all instructions before using the dishwasher.
- Use the dishwasher only for its intended function.
- Use only detergents or rinse agents recommended for use in a dishwasher, and keep them out of the reach of children.
- When loading items to be washed:
  - 1) Locate sharp items so that they are not likely to damage the door seal; and
  - 2) Load sharp knives with the handles up to reduce the risk of cut-type injuries.
- Do not wash plastic items unless they are marked “dishwasher safe” or the equivalent. For plastic items not so marked, check the manufacturer’s recommendations.
- Do not touch the heating element during or immediately after use.
- Do not operate the dishwasher unless all enclosure panels are properly in place.
- Do not tamper with controls.
- Do not abuse, sit on, or stand on the door, lid, or dish racks of the dishwasher.
- To reduce the risk of injury, do not allow children to play in or on the dishwasher.
- Under certain conditions, hydrogen gas may be produced in a hot water system that has not been used for two weeks or more. **HYDROGEN GAS IS EXPLOSIVE.** If the hot water system has not been used for such a period, before using the dishwasher turn on all hot water faucets and let the water flow from each for several minutes. This will release any accumulated hydrogen gas. As the gas is flammable, do not smoke or use an open flame during this time.
- Remove the door or lid to the washing compartment when removing an old dishwasher from service or discarding it.

### SAVE THESE INSTRUCTIONS

State of California Proposition 65 Warnings:

**WARNING:** This product contains one or more chemicals known to the State of California to cause cancer.

**WARNING:** This product contains one or more chemicals known to the State of California to cause birth defects or other reproductive harm.

## GROUNDING INSTRUCTIONS

### ■ For a grounded, cord-connected dishwasher:

The dishwasher must be grounded. In the event of a malfunction or breakdown, grounding will reduce the risk of electric shock by providing a path of least resistance for electric current. The dishwasher is equipped with a cord having an equipment-grounding conductor and a grounding plug. The plug must be plugged into an appropriate outlet that is installed and grounded in accordance with all local codes and ordinances.

**WARNING:** Improper connection of the equipment-grounding conductor can result in a risk of electric shock.

Check with a qualified electrician or service representative if you are in doubt whether the dishwasher is properly grounded. Do not modify the plug provided with the dishwasher; if it will not fit the outlet, have a proper outlet installed by a qualified electrician.

### ■ For a permanently connected dishwasher:

The dishwasher must be connected to a grounded metal, permanent wiring system, or an equipment-grounding conductor must be run with the circuit conductors and connected to the equipment-grounding terminal or lead on the dishwasher.

### SAVE THESE INSTRUCTIONS



## ⚠ WARNING

### Tip Over Hazard

**Do not use dishwasher until completely installed.**

**Do not push down on open door.**

**Doing so can result in serious injury or cuts.**

---

## What's New in Your Dishwasher

---

### Energy

Congratulations on purchasing your water and energy efficient dishwasher! This dishwasher cleans by spraying the dishes with water and pauses to allow the detergent to soak into and release the soils on the dishes. The cycles are longer due to the soak and pauses for exceptional cleaning. Several models contain an optical water sensor. The optical water sensor is used to determine the optimum water and energy consumption for great cleaning performance. The first cycle using the sensor will run longer to calibrate the optical sensor.



---

### Performance

#### Rinse Aid

Using rinse aid will optimize your drying and wash performance. This dishwasher is specifically designed to be used with rinse aid for improved drying performance and controlling buildup of hard water deposits. Energy efficient dishwashers use less water and energy, so they depend on the water "sheeting" action of rinse aid for total optimal performance.

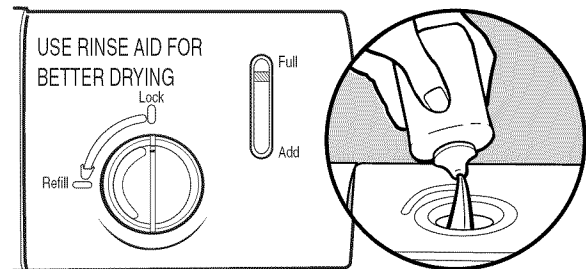

#### Detergent

The United States has passed a restriction limiting the amount of phosphorus (phosphates) in the household dishwasher detergents to no more than 0.5%, where previous detergents contained 8.7%. Major manufacturers have reformulated their dishwasher detergent for this change in detergents as another step in eco-conscious awareness. With these recent changes it is recommended to use tablets and packs for convenience and improved performance.

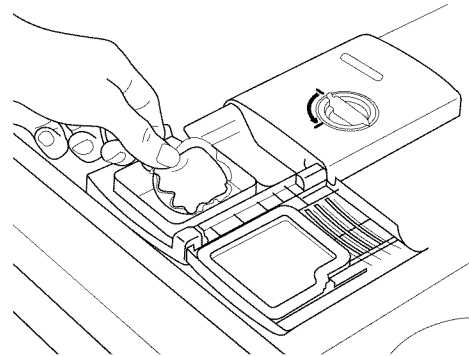

#### Filtration System

Your dishwasher has the latest technology in dishwasher filtration. This triple filtration system minimizes sound and optimizes water and energy conservation while providing optimal cleaning performance. Regular maintenance of your filters will sustain peak cleaning performance. We suggest you clean both your upper and lower filter and rinse under running water at least once a month.

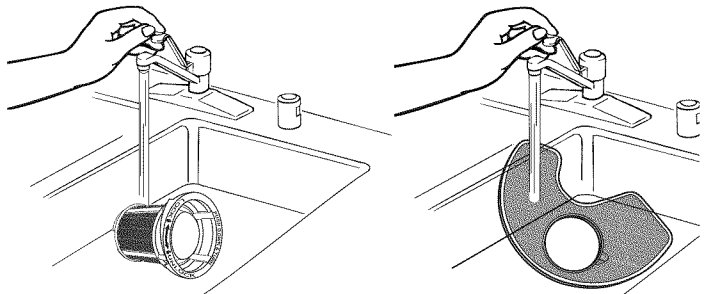

## Parts and Features

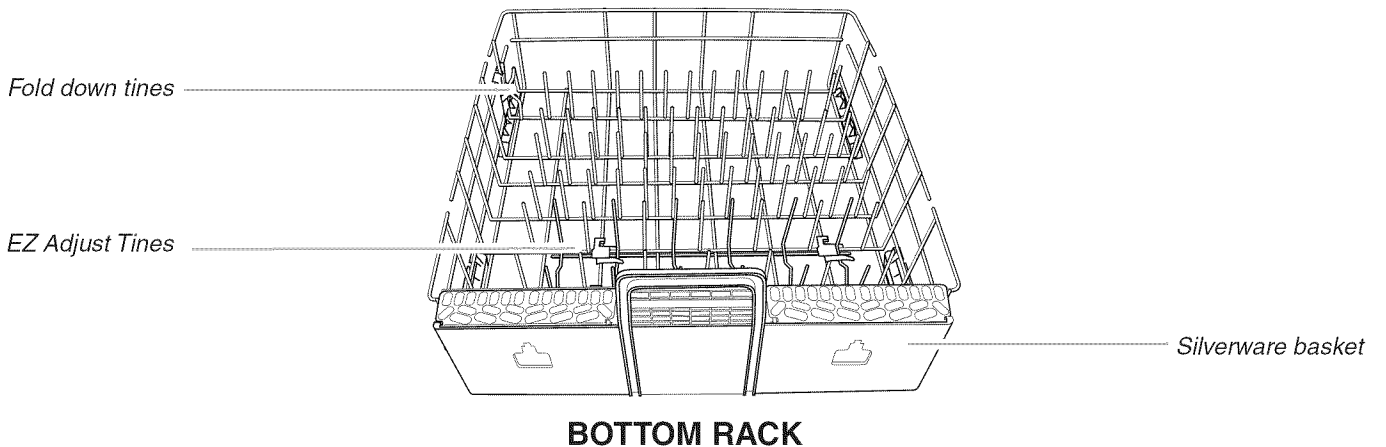
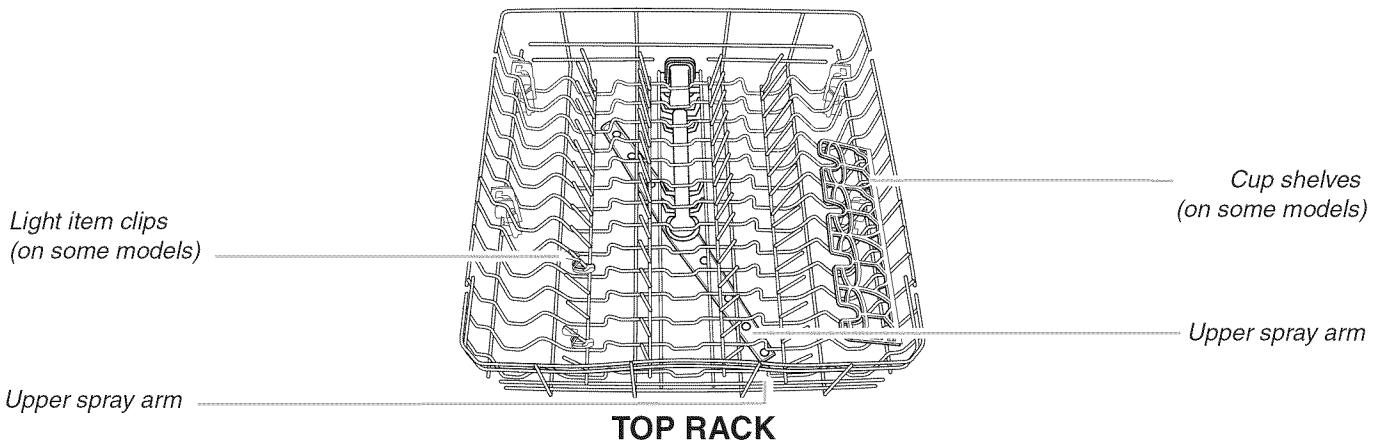
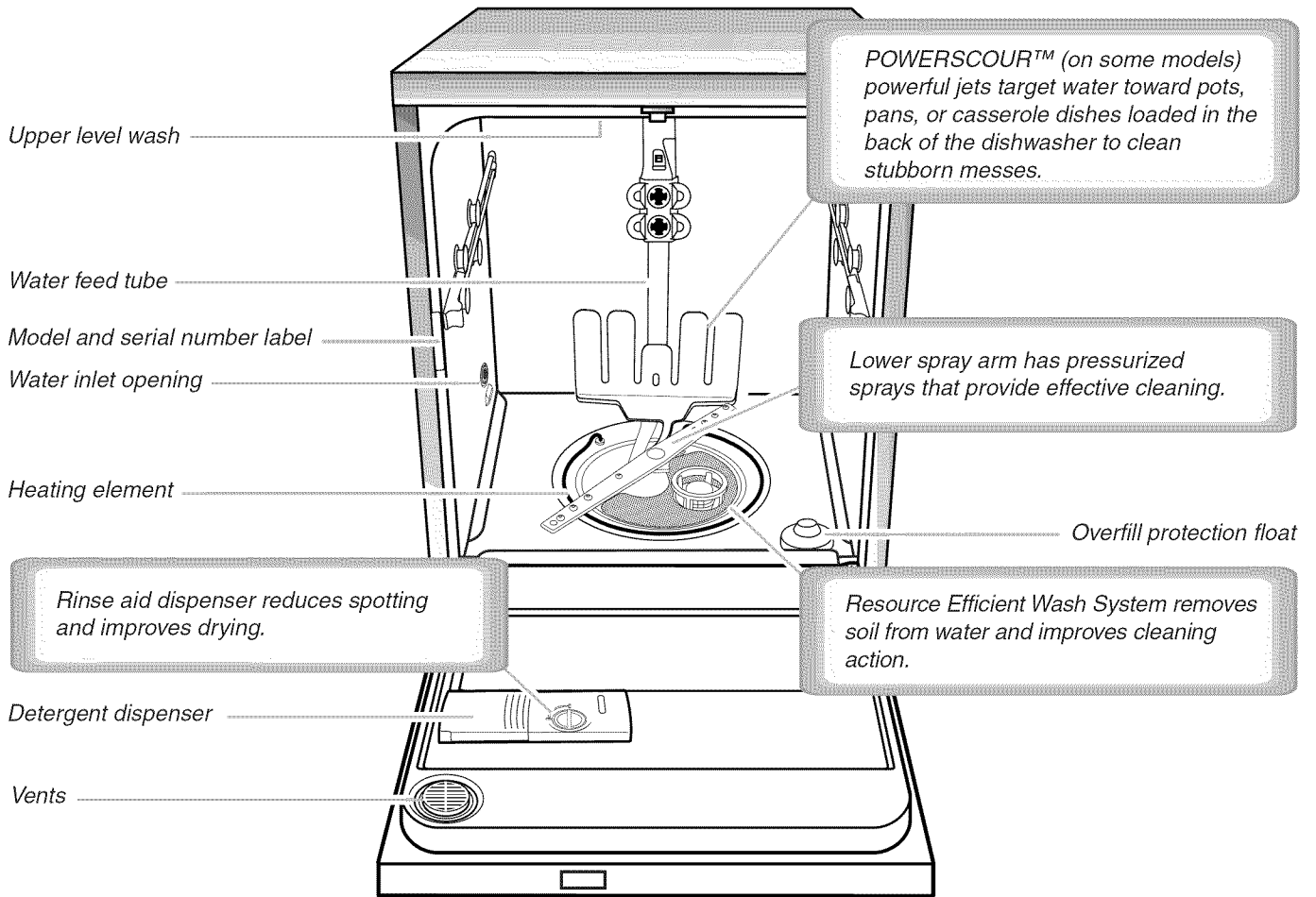

## Quick Steps

### 1 Prepare and load dishwasher.

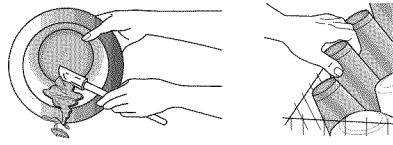

Spin the spray arms. They should turn freely.

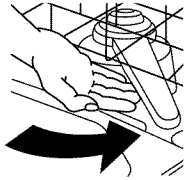

### 4 Start dishwasher.

For models with controls on top of the door, select wash cycle, option and press START/RESUME before closing the door. Push door firmly closed. The door latches automatically. Select the wash cycle, options and press START/RESUME or press START/RESUME to repeat the same cycle and options as in the previous wash cycle.



### 2 Add detergent and rinse aid.

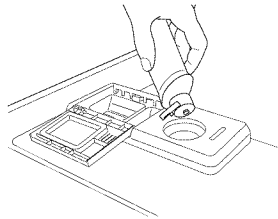
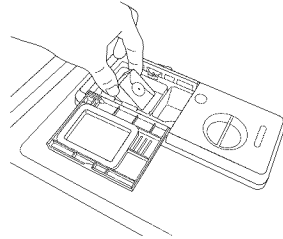

### 5 Unload and clean the filter. See “Recommended Time Interval to Clean Your Filter,” in the “Filtration System” section for the recommended cleaning schedule.

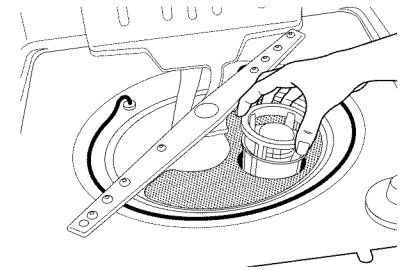
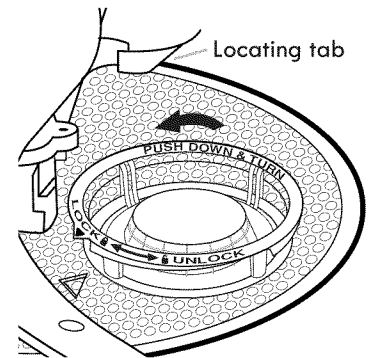

### 3 Select a cycle and option (cycles and options vary by model).

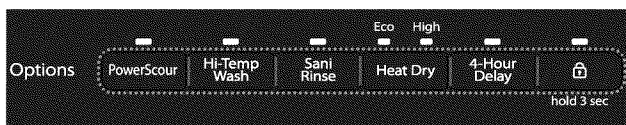
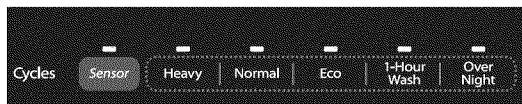

## STEP 1

### Prepare and Load the Dishwasher

**IMPORTANT:** Remove leftover food, bones, toothpicks and other hard items from the dishes. Remove labels from containers before washing.

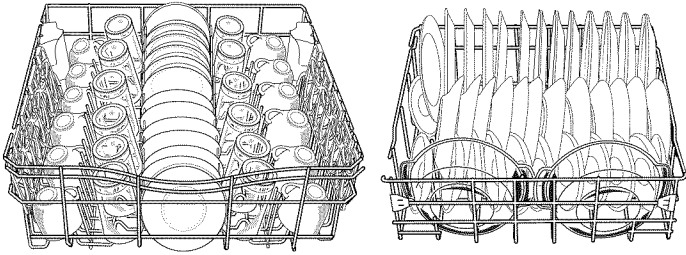

Upper rack

Lower rack

- Make sure nothing keeps spray arm(s) from spinning freely. It is important for the water spray to reach all soiled surfaces.
- Make sure that when the dishwasher door is closed no items are blocking the detergent dispenser.
- Items should be loaded with soiled surfaces facing down and inward to the spray as shown in the graphics above. This will improve cleaning and drying results.
- Avoid overlapping items like bowls or plates that may trap food.
- Place plastics, small plates and glasses in the upper rack.
- Wash only items marked “dishwasher safe.”
- To avoid thumping/clattering noises during operation: Load dishes so they do not touch one another. Make sure lightweight load items are secured in the racks.

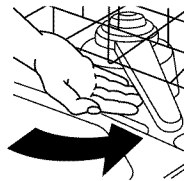

- When loading silverware, always place sharp items pointing down and avoid “nesting” as shown. If your silverware does not fit into the designated slots, flip the covers up and mix silverware types to keep them separated.

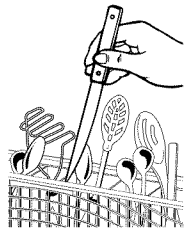

- Use suggested loading patterns, as shown, to better clean your silverware.
- Use the slots in the covers to keep your silverware separated for optimum wash. (See illustration, right.)

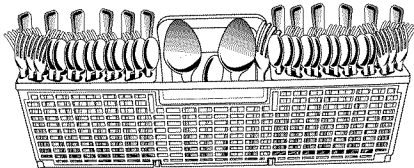

## STEP 2

### Add Detergent

**NOTE:** If you do not plan to run a wash cycle soon, run a rinse cycle. Do not use detergent.

- Use automatic dishwasher detergent only. Add powder, liquid or tablet detergent just before starting a cycle.
- Fresh automatic dishwasher detergent results in better cleaning. Store tightly closed detergent container in a cool, dry place.
- For optimum performance, tablet detergent is recommended.

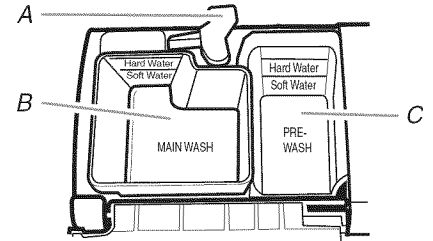

A. Cover latch  
B. Main wash section  
C. Pre-wash section

- The amount of detergent to use depends on:  
How much soil remains on the items - Heavily soiled loads require more detergent.

The hardness of the water - If you use too little detergent in hard water, dishes won't be clean. If you use too much in soft water, glassware will etch.

Soft to Medium Water (0-6 grains per U.S. gallon)  
[typical water softener water and some city water]

Medium to Hard Water (7-12 grains per U.S. gallon)  
[well water and some city water]

- Depending on your water hardness, fill the Main Wash section of the dispenser as shown. Fill the Pre-Wash section to the level shown, for heavily soiled items.

**NOTE:** Fill amounts shown are for standard powdered detergent. Follow instructions on the package when using other dishwasher detergent.



### Add Rinse Aid

- Your dishwasher is designed to use rinse aid for good drying performance. Without rinse aid your dishes and dishwasher interior will have excessive moisture. The heat dry option will not perform as well without rinse aid.
- Rinse aid keeps water from forming droplets that can dry as spots or streaks. They also improve drying by allowing water to drain off of the dishes after the final rinse.
- Check the rinse aid indicator. Add rinse aid when indicator drops to “Add” level.

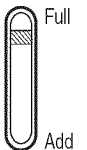

- To add rinse aid, turn the dispenser cap to “Refill” and lift off. Pour rinse aid into the opening until the indicator level is at “Full.” Replace the dispenser cap and turn to “Lock.” Make sure cap is fully locked.

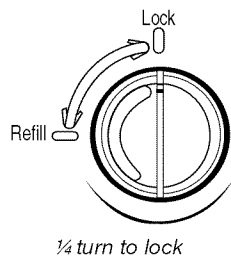

**NOTE:** For most water conditions, the factory setting will give good results.

- Check the water hardness level to ensure no rings or spots on your dishware before adding rinse aid or adjusting the factory setting.
- If you have hard water or notice rings or spots, try a higher setting.

Turn the arrow adjuster inside the dispenser by either using your fingers or inserting a flat-blade screwdriver into the center of the arrow and turning.

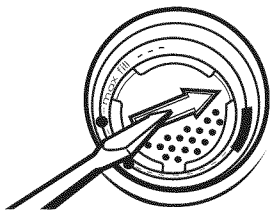

### STEP 3

#### Select a Cycle (cycles vary by model)

See “Cycle and Option Descriptions” charts in the following section.

Heavier cycles and options affect cycle length.

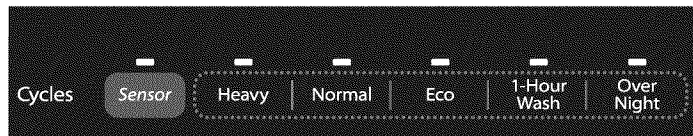

#### Select Options (options vary by model)

See “Cycle and Option Descriptions” charts in the following section.

You can customize your cycles by pressing the options desired.

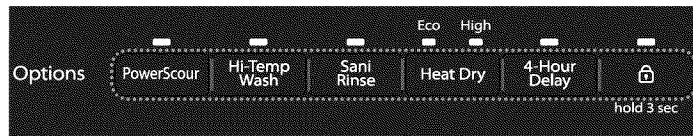

### STEP 4

#### Start or Resume a Cycle

- Run hot water at the sink nearest your dishwasher until the water is hot. Turn off water. For best dishwashing results, water should be 120°F (49°C) as it enters the dishwasher.
- For models with controls on top of the door, select wash cycle, option and press START/RESUME before closing the door. Push door firmly closed. The door latches automatically. Select the wash cycle, options and press STAR/RESUME or press START/RESUME to repeat the same cycle and options as in the previous wash cycle.
- You can add an item anytime at the beginning of the cycle. Open the door slowly and add the item. Close the door firmly. Press START/RESUME.



## Cycle and Option Descriptions

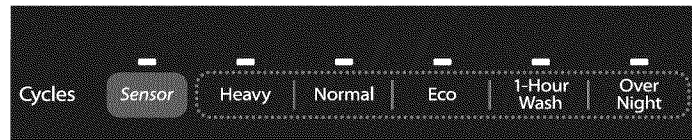









This information covers several different models. Your dishwasher may not have all the cycles and options described.

You can customize your cycle by selecting an option.

See option selections. If you change your mind, press the option again to turn off the option, or select a different option. You can change an option anytime before the selected option begins. At each stage of the wash cycle, you may hear noises that you are not used to hearing in your previous dishwasher. Each cycle will provide a series of pauses and water sprays throughout the wash cycle. This is normal and will provide optimal cleaning performance.

\*Maximum wash times depend on water temperature, heavy soil condition, dish load size and options selected.





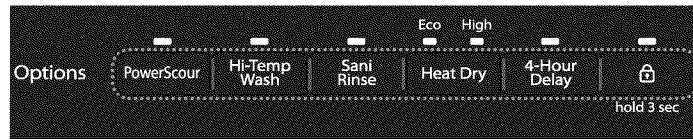

CYCLE SELECTIONS				
CYCLES	DISH LOAD TYPES	DESCRIPTIONS	ESTIMATED WASH TIME (HH:MM)	
			Cycle Minimum	*Maximum (with options selected)
	This is the most recommended cycle for all loads. Use for all day-to-day soil types when washing full to partial dish loads.	This cycle will sense the correct wash time and temperature for the soil levels and size, while sensing the right level for drying. Throughout the cycle, the wash will repeatedly pause adjusting for optimal wash action and sensing.	1:45	4:40
	Use for hard-to-clean, heavily soiled pots, pans, casseroles, and regular tableware.	This cycle combines tough wash action, longer wash time and higher wash temperatures to remove the tough soils.	2:05	4:40
	Use for loads with normal amounts of food soil.	The energy-usage label is based on this cycle. During the wash, the wash action will repeatedly pause for several seconds.	1:45	4:40
	Use for lightly soiled items, china and crystal. 	The most water and energy efficient cycle, using less water and energy, while maintaining good wash performance.	1:45	2:13
	Use for fast results. The 1 Hour Wash cycle will clean normal soils using slightly more water and energy.	For improved drying, select the Heated Dry option which adds ½ hour.	0:58	1:21
	Use for loads with normal amounts of food soil. It is a longer cycle and therefore is ideal to run overnight. 	Longer cycle developed to run overnight to save energy. This cycle has a longer soak time before the main wash begins.	6:20	7:00

**IMPORTANT:** The sensor in your dishwasher monitors the soil level. Cycle time and/or water usage can vary as the sensor adjusts the cycle for the best wash performance. If the incoming water is less than the recommended temperature or food soils are heavy, the cycle will automatically compensate by adding time, heat and water as needed.









## OPTION SELECTIONS

OPTIONS	DISH LOAD TYPES	DESCRIPTIONS	USE WITH:
	Pans, casseroles, etc., with tough food soil.	Activates the POWERSCOUR™ spray jets and provides intensified water spray to the back of the lower level rack. May add heat and time to the cycle.	Sensor, Heavy or Normal cycle
	Loads containing tough, baked-on food.	Increases the target water temperature during the wash portions of the cycle. Adds heat, wash time and water to the cycle.	Sensor, Heavy or Normal cycle
	To sanitize your dishes and glassware in accordance with NSF/ANSI Standard 184 for Residential Dishwashers.	Raises the water temperature in the final rinse to approximately 155°F (68°C). This high temperature rinse sanitizes your dishes and glassware in accordance with NSF/ANSI Standard 184 for Residential Dishwashers. Certified residential dishwashers are not intended for licensed food establishments. The Sanitize or Sani Rinse option adds heat and time to the cycle.	Sensor, Heavy or Normal cycle. Only these sanitization cycles have been designed to meet the NSF/ANSI requirements.
	For best drying results, dry dishes with heat. High Dry provides the optimum dry performance. Eco Dry provides energy savings and good dry performance.	Turn OFF (air dry) when loads contain plastic dinnerware that may be sensitive to high temperatures. High Dry with the use of rinse aid will provide the best drying performance.	All cycles
	To run your dish washer at a later time or during off-peak hours.	Delays the start of a cycle up to 8 hours (on models with 2-4-8 Hour Delay). Select a wash cycle and options. Press Delay until reaching the desired hours for the delay to start. Press START/RESUME. Close the door firmly.	All cycles
	Smaller loads slightly soiled.	Uses less energy and time to clean small loads.	Sensor, Heavy or Normal cycle

## OPTION SELECTIONS

OPTIONS	PURPOSE	DESCRIPTIONS	USE WITH:
<b>Control Lock</b> 	To avoid unintended use of your dishwasher, or cycle and option changes during a cycle.	<p>To turn on Lock, press and hold Control Lock for at least 3 seconds.</p> <p>To turn off Lock, press and hold Control Lock for at least 3 seconds.</p> <p>When Control Lock is lit, all buttons are disabled. If you press any pad while your dishwasher is locked, the light flashes 3 times. The dishwasher door can be opened while the controls are locked.</p>	Anytime

## CONTROLS AND CYCLE STATUS

CONTROL	PURPOSE	COMMENTS
	Press to start or resume a wash cycle	If the door is opened during a cycle or the power is interrupted, the Start/Resume indicator flashes. The cycle will not resume until the door is closed and Start/Resume is pressed.
	Press to cancel wash cycle	Close the door firmly. The dishwasher starts a 2-minute drain (if needed). Let the dishwasher drain completely.
	To follow the progress of your dishwasher cycle	<p>Clean indicator glows when a cycle is finished.</p> <p>If you select the Sani Rinse option, when the Sani Rinse cycle is finished, the "Sanitized" indicator glows. If your dishwasher did not properly sanitize your dishes, the light flashes at the end of the cycle. This can happen if the cycle is interrupted, or the water could not be heated to the required temperature. The light goes off when you open or close the door or press CANCEL.</p>

## Dishwasher Features

Your Whirlpool dishwasher may have some or all of these features.

### POWERSCOUR™ Wash Area

The POWERSCOUR™ wash area is located at the back of the lower level rack.

**NOTE:** You must select the POWERSCOUR™ wash option to use this feature. Make sure items do not interfere with the water feed tube, spray arms, or POWERSCOUR™ spray jets.

- Load pans, casserole dishes, etc. in the back of the lower dish rack with the soiled surfaces facing the POWERSCOUR™ spray jets.
- Only one row of items may face the POWERSCOUR™ spray jets. Stacking, overlapping or nesting items will keep the POWERSCOUR™ spray jets from contacting all of the surfaces.

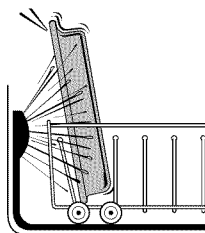

### Cup shelves

Fold down the extra shelf on the left-hand or right-hand side of the top rack to hold additional cups, stemware or long items such as utensils and spatulas.

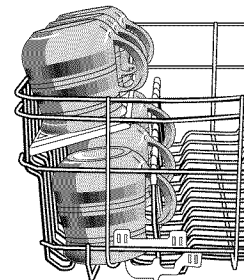

### ANYWARE™ PLUS silverware basket

The ANYWARE™ PLUS silverware basket can be hung on the door, the bottom rack, or placed inside the bottom rack.

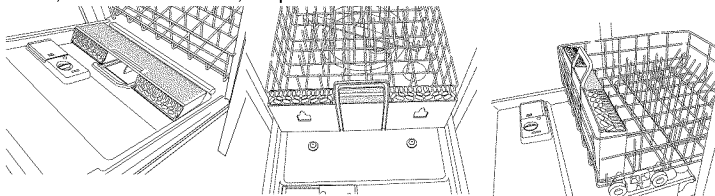

#### To open the ANYWARE™ PLUS silverware basket:

To unlock, grasp the front panel, pull up and rotate 90° as shown. Make sure the front panel is up all the way before rotating.

**NOTE:** Be sure the front panel of the silverware basket is completely locked into place before pulling out the bottom rack and before closing the dishwasher door.

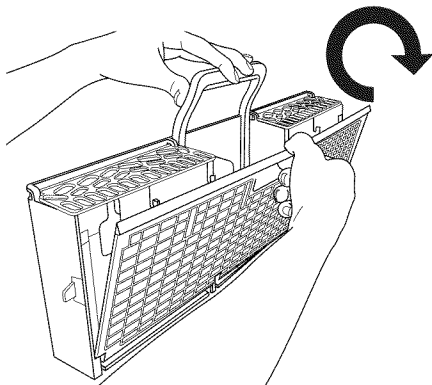

#### To remove the basket from the door:

1. Grasp the silverware basket by the handle. Slide it toward the top of the door.
2. Lift the basket off the holding buttons.

#### To replace the basket in the door:

1. Set the silverware basket on the holding buttons.
2. Slide the basket toward the bottom of the door until it locks into place.

### Fold-down Tines

The row of tines on the left-hand and right-hand sides of the upper or in the back of lower rack can be adjusted to make room for a variety of dishes.

#### To adjust the fold-down tines:

1. Grasp the tip of the tine that is in the tine holder.
2. Gently push the tine out of the holder.
3. Lay the tines down, toward the center of the rack.

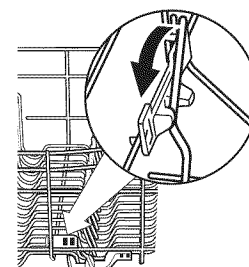

### Light Item Clips

The light item clips hold lightweight plastic items such as cups, lids, or bowls in place during washing.

#### To move a clip:

1. Pull the clip up and off the tine.
2. Reposition the clip on another tine.

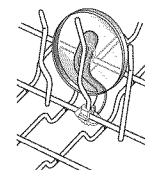

### EZ Adjust Tines

Sliding lower-rack tines that move left or right to fit your dishes. You can use this feature to fit larger items such as cereal bowls.

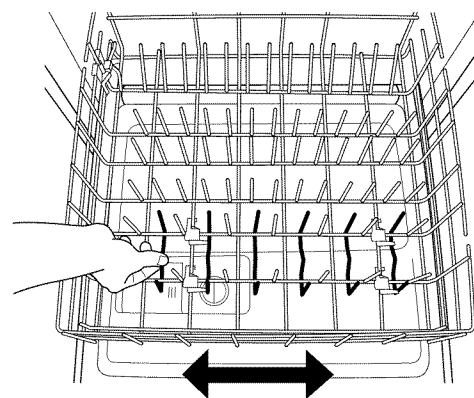

---

## EZ-2-Lift™ Top Rack

You can raise or lower the top rack to fit tall items in either the top or bottom rack. Adjusters are located on each side of the top rack. Raise the top rack to accommodate items up to 9" (22 cm) in the top rack and 13" (33 cm) in the bottom rack, or lower the top rack to accommodate items up to 11" (28 cm) in both the top and bottom racks.

To raise the rack, press both rack adjusters and lift the rack until it is in the Up position and level.

To lower the rack, press both rack adjusters and slide the rack back to its lower position.

**NOTE:** The top rack must be level.

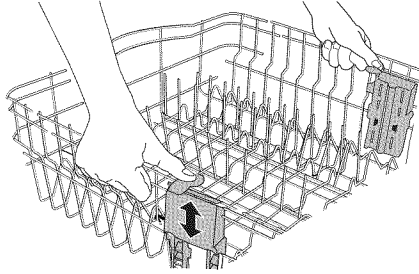

---

## Removable Top Rack

The removable top rack allows you to wash larger items such as pots, roasters, and cookie sheets in the bottom rack.

**IMPORTANT:** Remove dishes prior to removing the top rack from dishwasher.

To remove the rack

1. To gain access to the track stops, pull the upper rack forward about halfway out of the tub.
2. To open, flip the track stop toward the outside of the tub.
3. After opening both track stops, pull top rack out of the rails.
4. Close track stops and slide the tracks back into the dishwasher.

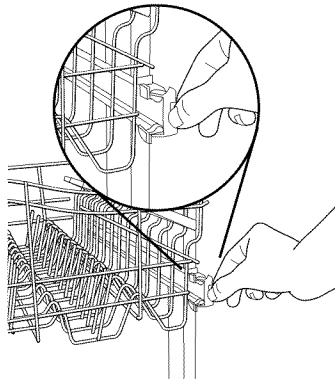

---

## To replace the rack

1. Gently pull tracks forward in dishwasher until they stop. Open track stops.
2. Place the back wheels on each side of the rack into the track slot and roll them back into the tracks, but do not push the rack all the way into the tub.
3. Insert front rack wheels on each side of the rack into the track slots.
4. Slide rack into the dishwasher. The stops will automatically close when rack enters dishwasher.

---

## Standard Rack Adjuster

You can raise or lower the top rack to fit tall items in either the top or bottom rack. Adjusters are located on each side of the top rack. Raise the top rack to accommodate items up to 9"

(22 cm) in the top rack and 13" (33 cm) in the bottom rack, or lower the top rack to accommodate items up to 11" (28 cm) in both the top and bottom racks.

1. To raise, remove rack and slide lower wheels into the rails as directed in "Removable Top Rack" section.
2. To lower, remove rack and slide upper wheels into the rails as directed in "Removable Top Rack" section.

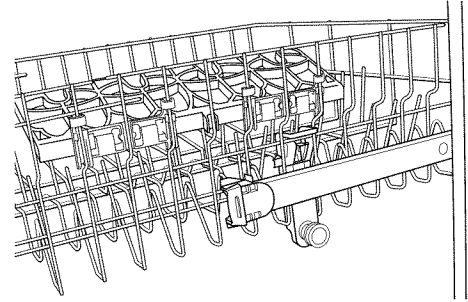

## Filtration System

Your dishwasher has the latest technology in dishwasher filtration. This triple filtration system minimizes sound and optimizes water and energy conservation while providing superior cleaning performance. Throughout the life of your dishwasher, the filter will require maintenance to sustain peak cleaning performance.

The triple filter system consists of 2 parts, an upper filter assembly and a lower filter.

- The upper filter assembly keeps oversized items and foreign objects, along with very fine food particles, out of the pump.
- The lower filter keeps food from being recirculated onto your dishware.

The filters may need to be cleaned when:

- Visible objects or soils are on the Upper Filter Assembly.
- There is degradation in cleaning performance (that is, soils still present on dishes).
- Dishes feel gritty to the touch.

It is very easy to remove and maintain the filters. The chart below shows the recommended cleaning frequency.

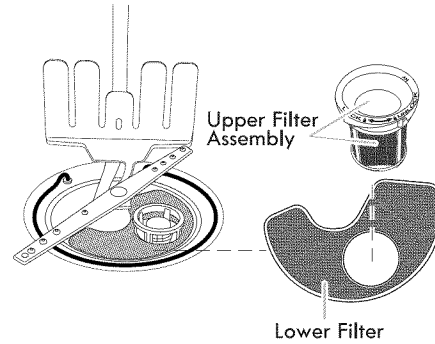

### RECOMMENDED TIME INTERVAL TO CLEAN YOUR FILTER

Number of Loads Per Week	If you only scrape before loading*	If you scrape and rinse before loading	If you wash before loading
8-12	Every two months	Every four months	Once per year
4-7	Every four months	Once per year	Once per year
1-3	Twice per year	Once per year	Once per year

\*Manufacturer's recommendation: This practice will conserve the water and energy that you would have used to prepare your dishes. This will also save you time and effort.

### Very Hard Water

If you have hard water (above 15 grains), clean your filter at least once per month. Building up of white residue on your dishwasher indicates hard water. For tips on removing spots and stains, see "Troubleshooting" section.

### Filter Removal Instructions

1. Turn the Upper Filter Assembly  $\frac{1}{4}$  turn counterclockwise and lift out.
2. Separate the upper filter assembly by gently pulling apart.
3. Clean the filters as shown.

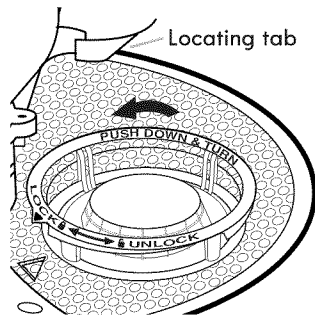

To remove Upper Filter Assembly

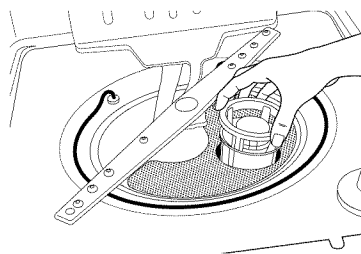

### Cleaning Instructions

**IMPORTANT:** Do not use wire brush, scouring pad, etc., as they may damage the filters.

Rinse filter under running water until most soils are removed. If you have hard-to-remove soils or calcium deposits from hard water, a soft brush may be required.

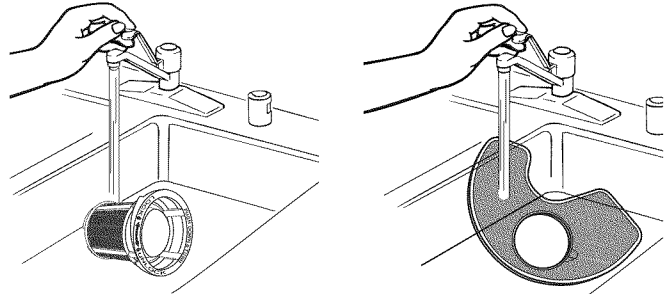

## Filter Reinstallation Instructions

1. Noting the previous illustrations, place the Lower Filter under the Locating Tabs in the bottom of the dishwasher so the round opening for the Upper Filter Assembly lines up with the round opening in the bottom of the tub.
2. Insert the Upper Filter Assembly into the circular opening in the Lower Filter.

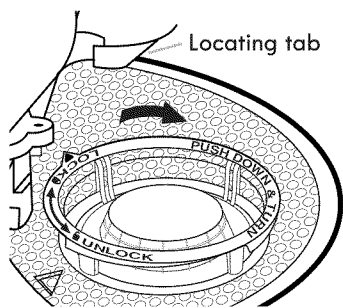
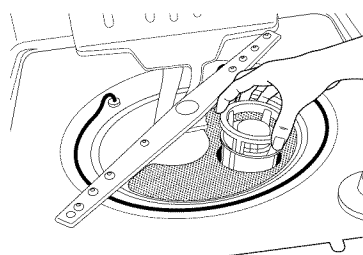

To replace Upper Filter Assembly

3. Slowly rotate the filter clockwise until it drops into place. Continue to rotate until the filter is locked into place. If the filter is not fully seated (still turns freely), continue to turn the filter clockwise until it drops and locks into place.

**NOTE:** The Upper Filter Assembly arrow does not have to align with the arrow in the Lower Filter as long as the filter is locked.

**IMPORTANT:** To avoid damage to dishwasher, do not operate your dishwasher without the filters properly installed. Be sure the Lower Filter is securely in place and the Upper Filter Assembly is locked into place. If the Upper Filter Assembly turns freely, it is not locked into place.

## Dishwasher Care

### CLEANING THE DISHWASHER

#### Cleaning the exterior

Clean the exterior of the dishwasher with a soft, damp cloth and mild detergent. If your dishwasher has a stainless steel exterior, a stainless steel cleaner is recommended - Stainless Steel Cleaner and Polish Part Number 31464.

#### Cleaning the interior

Clean the interior of the dishwasher, with a paste of powdered dishwasher detergent and water or use liquid dishwasher detergent on a damp sponge to clean the cooled-down interior.

A white vinegar rinse may remove white spots and film. Vinegar is an acid, and using it too often could damage your dishwasher.

Put 2 cups (500 mL) white vinegar in a glass or dishwasher-safe measuring cup on the bottom rack. Run the dishwasher through a complete washing cycle using an air-dry or an energy-saving dry option. Do not use detergent. Vinegar will mix with the wash water.

#### Dishwasher Maintenance Procedure

To help avoid odor or odor-causing residue in your dishwasher, use affresh® dishwasher and disposer cleaner (recommended) once a month as part of routine maintenance. Affresh® dishwasher and disposer cleaner is effective in all dishwasher brands.

#### IMPORTANT:

- Read these instructions as well as the instructions found on the affresh® product package completely before beginning the cleaning process.
- Avoid handling the tablet without foil wrapper or gloves.

1. Remove all dishware from the dishwasher. Open the dishwasher and place 1 affresh® dishwasher and disposer tablet in the main detergent tray and close the tray. Place another tablet in the prewash tray or simply place 1 tablet in the bottom of the dishwasher. Close the dishwasher. Run the dishwasher on the most aggressive cycle - heavy duty scrub, heated water, etc.
2. Place 1 affresh® dishwasher and disposal tablet into the garbage disposal. Turn on hot water to slow flow. Run the disposal and water for 15 seconds. Turn off disposal and water. Do not flush disposal completely with water. Water from the dishwasher will clean out the disposal. If you have no garbage disposal, skip this step.

#### Drain air gap

If you have a drain air gap, check and clean it if the dishwasher isn't draining well.

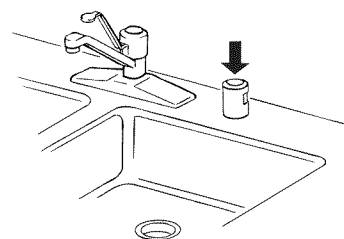

#### Storing the Dishwasher

If you will not be using the dishwasher during the summer months, turn off the water and power supply to the dishwasher. In the winter, if the dishwasher could be exposed to near freezing temperatures or is left in a seasonal dwelling such as a second home or vacation home, avoid water damage by having your dishwasher winterized by authorized service personnel.

## Troubleshooting

First try the solutions suggested here or visit our website and reference FAQs (Frequently Asked Questions) to possibly avoid the cost of a service call.

In the U.S.A., [www.whirlpool.com](http://www.whirlpool.com) In Canada, [www.whirlpool.ca](http://www.whirlpool.ca)

### Dishwasher is not operating properly

#### ■ Dishwasher does not run or stops during a cycle

It is normal for certain cycles to repeatedly pause for several seconds during the main wash. Is the door closed tightly and latched?

Is the right cycle selected?

Is there power to the dishwasher? Has a household fuse blown, or has a circuit breaker tripped? Replace the fuse or reset the circuit breaker. If the problem continues, call an electrician.

Has the motor stopped due to an overload? The motor automatically resets itself within a few minutes. If it does not restart, call for service.

Is the water shutoff valve (if installed) turned on?

#### ■ The Clean light is flashing

Check the following:

- Is the overflow protection float able to move up and down freely? Press down to release.
- Be sure the water supply is turned on to the dishwasher. (This is very important following the new installation of your dishwasher.)
- Check for suds in the dishwasher. If foam or suds are detected by the dishwasher sensing system, the dishwasher may not operate properly or may not fill with water.

Suds can come from:

1. Using the incorrect type of detergent, such as laundry detergent, hand soap, or dish detergent for hand washing dishes.
2. Forgetting to replace the rinse aid dispenser cap after filling (or refilling) the rinse aid.
3. Using an excessive amount of dishwasher detergent.

#### ■ Dishwasher will not fill

Is the overflow protection float able to move up and down freely? Press down to release.

#### ■ Dishwasher seems to run too long

Try the 1 Hour Wash cycle.

Is the water supplied to the dishwasher hot enough? The dishwasher runs longer while heating water.

Is the dishwasher cycle time within the cycle times? See cycle sections wash times. A delay automatically occurs in some wash and rinse cycles until the water reaches the proper temperature.

This dishwasher is equipped with an optical sensor wash that detects water temperature, soil and detergent amount. Wash cycles are adjusted based on the load sensing.

**IMPORTANT:** The very first wash cycle after installation in your home will be adjusted to include an additional 2 rinses. This cycle must not be interrupted for proper sensor adjustment. If this adjustment cycle is canceled or stopped before the Clean light comes on at the end of the cycle, the next wash cycle will repeat this sensor adjustment.

#### ■ Water remains in the dishwasher

Is the cycle complete?

Was the disposer knockout plug removed during installation? (See "Install the drain hose" section in the Installation Instructions.)

#### ■ Detergent remains in the covered section of the dispenser

Is the cycle complete?

Check for items such as cookie sheets, cutting boards, or large containers that may be blocking the detergent dispenser from opening properly.

Be sure the cycle has finished (green light is on). If it has not finished, you will need to resume the cycle by pressing START/RESUME and closing the door within 3 seconds.

Is the detergent lump-free? Replace detergent if necessary.

#### ■ White residue on the front of the access panel

Was too much detergent used?

Is the brand of detergent making excess foam? Try a different brand to reduce foaming and eliminate buildup.

#### ■ Odor in the dishwasher

Are dishes washed only every 2 or 3 days?

Check and clean your filters regularly. See the table in "Filtration System" section for "Recommended Time Interval to Clean Your Filter."

Does the dishwasher have a new plastic smell? Run a vinegar rinse as described in "Dishwasher Care."

To avoid odor, use affresh™ dishwasher and disposal cleaner tablet once a month or as needed for a fresher dishwasher as described in "Dishwasher Care."

#### ■ Condensation on the kitchen counter (built-in models)

Is the dishwasher aligned with the countertop? Moisture from the vent in the dishwasher console can form on the counter. Refer to the Installation Instructions for more information.

#### ■ Bottom rack does not fully slide into the dishwasher

Check to see if items loaded for POWERSCOUR™ wash option have shifted. Reload to keep items from interfering with spray jets or spray arm.

### Dishes do not dry completely

#### ■ Dishes do not dry completely

Did you use a rinse aid? Your dishwasher is designed to use rinse aid for good drying performance. Without rinse aid your dishes and dishwasher interior will have excessive moisture. The heat dry option will not perform as well without rinse aid.

#### ■ Dishes are not dry

Did you load your dishwasher to allow proper water drainage? Do not overload. Use a liquid rinse aid to speed drying.

Are the plastics wet? Plastics often need towel drying.

Is the rinse aid dispenser empty?

Did you use an air-dry or energy-saving dry option? Use a heated drying option for dryer dishes.

#### ■ Excess moisture on racks and dishwasher interior

Check the rinse aid indicator to see that there is rinse aid in the dispenser.

### Spots and stains on dishes

#### ■ Spotting and filming on dishes

Is your water hard, or is there a high mineral content in your water? Conditioning the final rinse water with a liquid rinse aid helps eliminate spotting and filming. Keep the rinse aid dispenser filled. Always use a high-temp option. If your water hardness is 13 grains or above, it is strongly recommended that you install a home water softener. If you do not wish to drink softened water, have the softener installed onto your hot water supply.



Is the water temperature too low? For best dishwashing results, water should be 120°F (49°C) as it enters the dishwasher.

Did you use the correct amount of effective detergent? Use recommended dishwasher detergents only. Do not use less than 1 tbs (15 g) per load. Detergent must be fresh to be effective. Heavy soil and/or hard water generally require extra detergent.

Using dishwasher detergent tablets and packs have been proven better than powder, liquid or gel detergents to reduce filming on your dishes. By using these tablets and packs, over time this will start to reduce or eliminate white film. Also, by using a rinse aid you can minimize repeat buildup of white film.

Is the home water pressure high enough for proper dishwasher filling? Home water pressure should be 20 to 120 psi (138 to 828 kPa) for proper dishwasher fill. If you have questions about your water pressure, call a licensed, qualified plumber.

**NOTE:** To remove spots and film from glassware, remove all silverware and metal items and run a vinegar rinse as described in “Dishwasher Care.”

- **Silica film or etching (silica film is a milky, rainbow-colored deposit; etching is a cloudy film)**

Sometimes there is a water/chemical reaction with certain types of glassware. This is usually caused by some combination of soft or softened water, alkaline washing solutions, insufficient rinsing, overloading the dishwasher, and the heat of drying. It might not be possible to avoid the problem, except by hand washing.

To slow this process use a minimum amount of detergent but not less than 1 tbs (15 g) per load. Use a liquid rinse aid and underload the dishwasher to allow thorough rinsing. Silica film and etching are permanent and cannot be removed. Do not use heated drying.

- **White spots on cookware with nonstick finish**

Has the dishwasher detergent removed cookware seasoning? Reseason cookware after washing it in the dishwasher.

- **Brown stains on dishes and dishwasher interior**

Does your water have high iron content? Rewash dishes using 1-3 tsp (5-15 mL) of citric acid crystals added to the covered section of the detergent dispenser. Do not use detergent. Follow with a Normal wash cycle with detergent. If treatment is needed more often than every other month, the installation of an iron removal unit is suggested.

- **Black or gray marks on dishes**

Are aluminum items rubbing dishes during washing? Disposable aluminum items can break down in the dishwasher and cause marking. Hand wash these items. Remove aluminum markings by using a mild abrasive cleaner.

- **Orange stains on plastic dishes or dishwasher interior**

Are large amounts of tomato-based foods on dishes placed in the dishwasher? It may be necessary to use a stain removal product to remove stains from your dishwasher. Stains will not affect dishwasher performance.

---

## Noises

- **Surging sounds**

Surging sounds can occur periodically throughout the cycle while the dishwasher is draining

- **Valve hissing**

Normal water valve hissing may be heard periodically, during the water fill.

- **Snapping sound**

A normal snap sound may be heard when the detergent dispenser opens during the cycle, and when the door is opened at the end of the cycle.

- **Grinding, grating, crunching or buzzing sounds**

A hard object has entered the wash module (on some models). When the object is ground up, the sound should stop. If the noise persists after a complete cycle, call for service.

---

## Dishwasher stops and starts

- **Numerous starts and stops**

It is normal to hear numerous starts and stops during throughout your entire cycle. These starts and stops are needed to provide optimal cleaning performance and energy savings.

- **Depending on cycle selected**

Depending on the cycle selected and the soil level sensed by the “Optical Water Sensor” (in some models), you will experience more starts and stops throughout the entire cycle.

---

## Dishes are not completely clean

- **Food soil left on the dishes**

Is the dishwasher loaded correctly?

Check and clean your filters regularly. See the table in “Filtration System” section for “Recommended Time Interval to Clean Your Filter.”

Did you choose the cycle that describes the most difficult soil in your dishwasher? If you have some items with heavier soils, use a heavier cycle.

Is the water temperature too low? For best dishwashing results, water should be 120°F (49°C) as it enters the dishwasher.

Did you use the correct amount of fresh detergent? Use recommended dishwasher detergents only. Do not use less than 1 tbs (15 g) per load. Detergent must be fresh to be effective. Heavy soil and/or hard water generally require extra detergent.

Is detergent caked in dispenser? Use fresh detergent only. Do not allow detergent to sit for several hours in a wet dispenser. Clean dispenser when caked detergent is present.

Is the pump or spray arm clogged by labels from bottles and cans?

Is the home water pressure high enough for proper dishwasher filling? Home water pressure should be 20 to 120 psi (138 to 828 kPa) for proper dishwasher fill. If you have questions about your water pressure, call a licensed, qualified plumber.

Are high suds slowing the wash arm? Do not use soap or laundry detergents. Use recommended dishwasher detergents only.

- **Dishes in the POWERSCOUR™ wash area are not clean**

Are the dishes loaded to face the POWERSCOUR™ spray jets? Load soiled dish surfaces to face the back of the dishwasher toward the POWERSCOUR™ spray jets. Tilt the dishes toward the back so water can drain from surfaces, and the lower spray arm can wash the item from below.

**NOTE:** Loaded items may shift when dish racks are pushed into the dishwasher. Make sure dishes do not interfere with the spray arms, water feed tube, or POWERSCOUR™ spray jets.

Are items loaded so they do not overlap? Load items only one row deep without any overlap so that the POWERSCOUR™ spray jets can reach all surfaces.

---

## Dishes are damaged during a cycle

- **Chipping of dishes**

Did you load the dishwasher properly? Load the dishes and glasses so they are stable and do not strike together from washing action. Minimize chipping by moving the rack in and out slowly.

**NOTE:** Antiques, feather-edged crystal, and similar types of china and glassware might be too delicate for automatic dishwashing. Wash by hand.



# WHIRLPOOL CORPORATION MAJOR APPLIANCE WARRANTY

## LIMITED WARRANTY

For one year from the date of purchase, when this major appliance is operated and maintained according to instructions attached to or furnished with the product, Whirlpool Corporation or Whirlpool Canada LP (hereafter "Whirlpool") will pay for Factory Specified Parts and repair labor to correct defects in materials or workmanship. Service must be provided by a Whirlpool designated service company. This limited warranty is valid only in the United States or Canada and applies only when the major appliance is used in the country in which it was purchased. Outside the 50 United States and Canada, this limited warranty does not apply. Proof of original purchase date is required to obtain service under this limited warranty.

## ITEMS EXCLUDED FROM WARRANTY

### This limited warranty does not cover:

1. Service calls to correct the installation of your major appliance, to instruct you on how to use your major appliance, to replace or repair house fuses, or to correct house wiring or plumbing.
2. Service calls to repair or replace appliance light bulbs, air filters or water filters. Consumable parts are excluded from warranty coverage.
3. Repairs when your major appliance is used for other than normal, single-family household use or when it is used in a manner that is contrary to published user or operator instructions and/or installation instructions.
4. Damage resulting from accident, alteration, misuse, abuse, fire, flood, acts of God, improper installation, installation not in accordance with electrical or plumbing codes, or use of consumables or cleaning products not approved by Whirlpool.
5. Cosmetic damage, including scratches, dents, chips or other damage to the finish of your major appliance, unless such damage results from defects in materials or workmanship and is reported to Whirlpool within 30 days from the date of purchase.
6. Any food loss due to refrigerator or freezer product failures.
7. Costs associated with the removal from your home of your major appliance for repairs. This major appliance is designed to be repaired in the home and only in-home service is covered by this warranty.
8. Repairs to parts or systems resulting from unauthorized modifications made to the appliance.
9. Expenses for travel and transportation for product service if your major appliance is located in a remote area where service by an authorized Whirlpool servicer is not available.
10. The removal and reinstallation of your major appliance if it is installed in an inaccessible location or is not installed in accordance with published installation instructions.
11. Major appliances with original model/serial numbers that have been removed, altered or cannot be easily determined. This warranty is void if the factory applied serial number has been altered or removed from your major appliance.

The cost of repair or replacement under these excluded circumstances shall be borne by the customer.

## DISCLAIMER OF IMPLIED WARRANTIES; LIMITATION OF REMEDIES

CUSTOMER'S SOLE AND EXCLUSIVE REMEDY UNDER THIS LIMITED WARRANTY SHALL BE PRODUCT REPAIR AS PROVIDED HEREIN. IMPLIED WARRANTIES, INCLUDING WARRANTIES OF MERCHANTABILITY OR FITNESS FOR A PARTICULAR PURPOSE, ARE LIMITED TO ONE YEAR OR THE SHORTEST PERIOD ALLOWED BY LAW. WHIRLPOOL SHALL NOT BE LIABLE FOR INCIDENTAL OR CONSEQUENTIAL DAMAGES. SOME STATES AND PROVINCES DO NOT ALLOW THE EXCLUSION OR LIMITATION OF INCIDENTAL OR CONSEQUENTIAL DAMAGES, OR LIMITATIONS ON THE DURATION OF IMPLIED WARRANTIES OF MERCHANTABILITY OR FITNESS, SO THESE EXCLUSIONS OR LIMITATIONS MAY NOT APPLY TO YOU. THIS WARRANTY GIVES YOU SPECIFIC LEGAL RIGHTS, AND YOU MAY ALSO HAVE OTHER RIGHTS WHICH VARY FROM STATE TO STATE OR PROVINCE TO PROVINCE.

If outside the 50 United States and Canada, contact your authorized Whirlpool dealer to determine if another warranty applies. 9/07

For additional product information or to view FAQs (Frequently Asked Questions), in U.S.A., visit [www.whirlpool.com](http://www.whirlpool.com)  
In Canada, visit [www.whirlpool.ca](http://www.whirlpool.ca)

If you do not have access to the Internet and you need assistance using your product or you would like to schedule service, you may contact Whirlpool at the number below.

*Have your complete model number ready. You can find your model number and serial number on the label located near the door on the right-hand or left-hand side of the dishwasher interior.*

For assistance or service in the U.S.A., call 1-800-253-1301. In Canada, call 1-800-807-6777.

If you need further assistance, you can write to Whirlpool with any questions or concerns at the address below:

In the U.S.A.:

Whirlpool Brand Home Appliances  
Customer eXperience Center  
553 Benson Road  
Benton Harbor, MI 49022-2692

In Canada:

Whirlpool Brand Home Appliances  
Customer eXperience Centre  
200 – 6750 Century Ave.  
Mississauga ON L5N 0B7

Please include a daytime phone number in your correspondence.

Please keep these User Instructions and model number information for future reference.

**W10350359B**  
**SP PN W10350360A**

© 2011 Whirlpool Corporation.  
All rights reserved.

© Registered Trademark/TM Trademark of Whirlpool, U.S.A.  
Whirlpool Canada LP licensee in Canada

6/11  
Printed in U.S.A.