

# Operator's Manual



## 28cc/1.7 cu.in. 2-Cycle GASOLINE WEEDWACKER®

Model No.  
358.792010



- Safety
- Assembly
- Operation
- Maintenance
- Parts List
- Español, p. 20

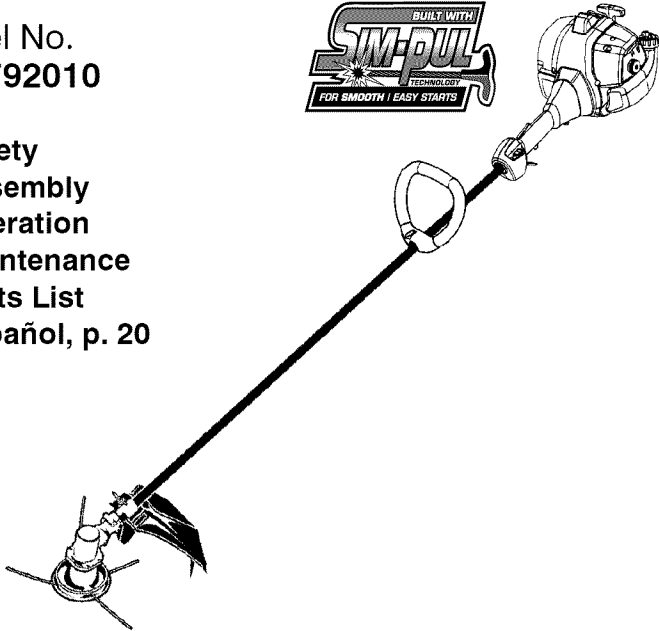

### WARNING:

Read and follow all Safety Rules and Operating Instructions before first use of this product.



For answers to your questions about this product:  
Call 7 am–7 pm, Mon.–Sat., or 10 am–7 pm, Sun.

**1-800-235-5878** (Hours listed are Central Time)

Sears, Roebuck and Co., Hoffman Estates, IL 60179 U.S.A.

545212843 Rev. 4 2/16/09 BRW

## TABLE OF CONTENTS

Warranty Statement	2	Storage	14
Identification of Safety Symbols	3	Troubleshooting Table	15
Safety Rules	4	Emissions Statement	16
Assembly	6	Parts List	18
Operation	7	Spanish	20
Maintenance	10	Parts and Ordering	Back Cover
Service & Adjustments	12		

## WARRANTY STATEMENT

### CRAFTSMAN PROFESSIONAL FULL WARRANTY

If this Craftsman product fails due to a defect in material or workmanship within three (3) years from the date of purchase, return it to any Sears store, Parts & Repair Service Center, or other Craftsman outlet in the United States for free repair (or replacement if repair proves impossible).

This warranty applies for only 1 year if this product is ever used for commercial or rental purposes.

**This warranty covers ONLY defects in material and workmanship. Sears will NOT pay for:**

- Expendable items that can wear out from normal use within the warranty period, such as cutting line, filters or spark plugs.
- Repairs necessary because of accident or failure to operate or maintain the product according to all supplied instructions.
- Preventive maintenance, or repairs necessary due to improper fuel mixture, contaminated or stale fuel.

This warranty gives you specific legal rights, and you may also have other rights which vary from state to state.

**Sears, Roebuck and Co., Hoffman Estates, IL 60179**

## REPAIR PROTECTION AGREEMENTS

*Congratulations on making a smart purchase.* Your new Craftsman product is designed and manufactured for years of dependable operation. But like all products, it may require repair from time to time. That's when having a Repair Protection Agreement can save you money and aggravation.

**Here's what the Repair Protection Agreement\* includes:**

- ✓ **Expert service** by our 10,000 professional repair specialists
- ✓ **Unlimited service and no charge** for parts and labor on all covered repairs
- ✓ **Product replacement** up to \$1500 if your covered product can't be fixed
- ✓ **Discount of 10%** from regular price of service and related installed parts not covered by the agreement; also, 10% off regular price of preventive maintenance check
- ✓ **Fast help by phone** - we call it Rapid Resolution - phone support from a Sears representative. Think of us as a "talking operator's manual".

Once you purchase the Repair Protection Agreement, a simple phone call is all that it takes for you to schedule service. You can call anytime day or night, or schedule a service appointment online. The Repair Protection Agreement is a risk-free purchase. If you cancel for any reason during the product warranty period, we will provide a full refund. Or, a prorated refund anytime after the product warranty period expires. Purchase your Repair Protection Agreement today!

**Some limitations and exclusions apply. For prices and additional information in the U.S.A. call 1-800-827-6655.**

**\*Coverage in Canada varies on some items. For full details call Sears Canada at 1-800-361-6665.**

## Sears Installation Service

For Sears professional installation of home appliances, garage door openers, water heaters, and other major home items, in the U.S.A. or Canada call **1-800-4-MY-HOME®**.

# IDENTIFICATION OF SAFETY SYMBOLS

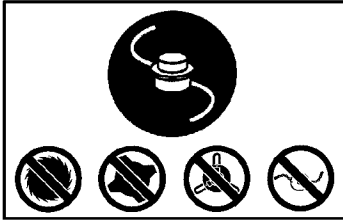

**⚠ DANGER:** Use only specified trimmer head, spool, and recommended trimmer line. Never use blades, flailing devices, wire, rope, string, etc. This unit is designed for line trimmer use only. Failure to follow these instructions may result in serious injury.



**⚠ WARNING:** This unit can be dangerous! Careless or improper use can cause serious injury.



Read the operator's manual before use. Failure to follow instructions could result in serious injury. Save operator's manual.



Trimmer line can throw objects violently. You can be blinded or injured. Always wear hearing protection and safety glasses marked Z87. Always wear heavy, long pants, long sleeves, boots and gloves.

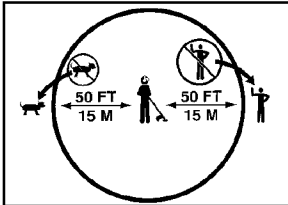

Hazard zone for thrown objects.

- Trimmer line throws objects violently.
- You and others can be blinded/injured.
- Keep children, bystanders, and animals 50 feet (15 meters) away.



Secure hair above shoulder length. Do not wear jewelry, loose clothing, or clothing with loosely hanging straps, ties, tassels, etc. They can be caught in moving parts.

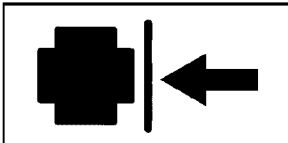

Assist handle to be positioned only below the arrow.

## IDENTIFICATION OF SAFETY SYMBOLS

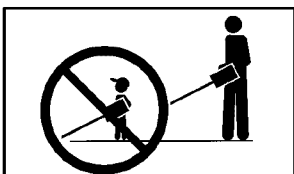

Never allow children to operate this unit.

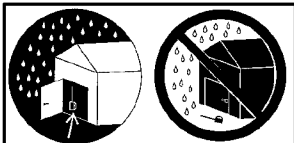

Store unit indoors in a high, dry place out of the reach of children. Store unit and fuel in area where fuel vapors cannot reach sparks or open flames from water heaters, electric motors or switches, furnaces, etc.



When servicing unit, use only identical replacement parts.

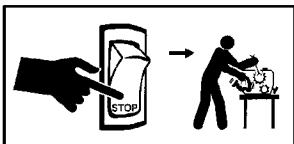

Always stop unit and disconnect spark plug before cleaning or servicing.



**⚠ WARNING:** Fire hazard. Never mix, pour, or store gasoline or use the unit near a flame or sparks (including smoking, open flames, or work that can cause sparks).

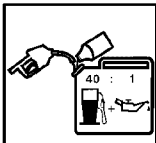

Use unleaded gasoline and two-stroke oil mixed at a ratio of 40:1 (2.5%).

## SAFETY RULES

**⚠ WARNING:** When using gardening appliances, basic safety precautions must always be followed to reduce the risk of fire and serious injury. Read and follow all instructions. *This power unit can be dangerous!* Operator is responsible for following instructions and warnings on unit and in manual. Read entire operator's manual before using unit! Be thoroughly familiar with the controls and the proper use of the unit. Restrict the use of this unit to persons who have read, understand,

and will follow the instructions and warnings on the unit and in the manual. Never allow children to operate this unit.



OPERATOR'S  
MANUAL



SAFETY INFORMATION  
ON THE UNIT

**⚠ DANGER:** Never use blades or flailing devices. This unit is designed for line trimmer use only. Use of any other accessories or attachments will increase the risk of injury.

If situations occur which are not covered in this manual, use care and good judgment. If you need assistance, contact your Sears Service Center or call 1-800-235-5878.

#### **OPERATOR SAFETY**

- Dress properly. Always wear safety glasses or similar eye protection when operating, or performing maintenance, on your unit (safety glasses are available). Eye protection should be marked Z87.
- Always wear face or dust mask if operation is dusty.
- Always wear heavy, long pants, long sleeves, boots, and gloves. Wearing safety leg guards is recommended.
- Always wear foot protection. Do not go barefoot or wear sandals. Stay clear of spinning line.
- Secure hair above shoulder length. Secure or remove loose clothing or clothing with loosely hanging ties, straps, tassels, etc. They can be caught in moving parts.
- Being fully covered also helps protect you from debris and pieces of toxic plants thrown by spinning line.
- Stay Alert. Do not operate this unit when you are tired, ill, upset or under the influence of alcohol, drugs, or medication. Watch what you are doing; use common sense.
- Wear hearing protection.
- Never start or run inside a closed room or building. Breathing exhaust fumes can kill.
- Keep handles free of oil and fuel.

#### **UNIT / MAINTENANCE SAFETY**

-  **WARNING:** Disconnect the spark plug before performing maintenance except carburetor adjustments.
- Look for and replace damaged or loose parts before each use. Look for and repair fuel leaks before use. Keep in good working condition.
  - Replace trimmer head parts that are chipped, cracked, broken, or damaged in any other way before using the unit.
  - Maintain unit according to recommended procedures. Keep cutting line at proper length.
  - Use only Craftsman replacement line. Never use wire, rope, string, etc.
  - Install required shield properly before using the unit. Use only specified trimmer head; make sure it is properly installed and securely fastened.
  - Make sure unit is assembled correctly as shown in this manual.

- Make carburetor adjustments with lower end supported to prevent line from contacting any object.
- Keep others away when making carburetor adjustments.
- Use only recommended Craftsman accessories and replacement parts.
- Have all maintenance and service not explained in this manual performed by a Sears Service Center.

#### **FUEL SAFETY**

- Mix and pour fuel outdoors.
- Keep away from sparks or flames.
- Do not smoke or allow smoking near fuel or the unit or while using the unit.
- Avoid spilling fuel or oil. Wipe up all fuel spills before starting engine.
- Move at least 10 feet (3 meters) away from fueling site before starting engine. Stop engine and allow it to cool before removing fuel cap.
- Empty the fuel tank before storing or transporting the unit. Use up fuel left in the carburetor by starting the engine and letting it run until it stops.
- Store unit and fuel in area where fuel vapors cannot reach sparks or open flames from water heaters, electric motors or switches, furnaces, etc.
- Always store gasoline in a container approved for flammable liquids.

#### **CUTTING SAFETY**

-  **WARNING:** Inspect the area before each use. Remove objects (rocks, broken glass, nails, wire, etc.) which can be thrown by or become entangled in line. Hard objects can damage the trimmer head and be thrown causing serious injury.
- Keep others including children, animals, bystanders, and helpers at least 50 feet (15 meters) away. Bystanders should be encouraged to wear safety glasses. Stop engine immediately if you are approached.
  - Use only for trimming, scalping, mowing, edging and sweeping. Do not use for pruning or hedge trimming.
  - Keep firm footing and balance. Do not overreach.
  - Keep all parts of your body away from muffler and spinning line. Keep engine below waist level. A hot muffler can cause serious burns.
  - Cut only from your right to your left. Cutting on left side of the shield will throw debris away from the operator.
  - Use only in daylight or good artificial light.
  - Use only for jobs explained in this manual.

## TRANSPORTING AND STORAGE

- Stop the unit before carrying.
- Allow engine to cool before storing or transporting in vehicle.
- Empty the fuel tank before storing or transporting the unit. Use up fuel left in the carburetor by starting the engine and letting it run until it stops.
- Store unit and fuel in area where fuel vapors cannot reach sparks or open flames from water heaters, electric motors or switches, furnaces, etc.
- Store unit so line limiter blade cannot accidentally cause injury. The unit can be hung by the shaft.
- Store unit out of reach of children.

This unit is not equipped with an anti-vibration system and is intended for occasional use only.

**SAFETY NOTICE:** Exposure to vibrations through prolonged use of gasoline powered hand tools could cause blood vessel or nerve damage in the fingers, hands, and joints of people prone to circulation disorders or abnormal swellings. Prolonged use in cold weather has been linked to blood vessel damage in otherwise healthy people. If symptoms occur such as numbness, pain, loss of strength, change in skin color or texture, or loss

of feeling in the fingers, hands, or joints, discontinue the use of this tool and seek medical attention. An anti-vibration system does not guarantee the avoidance of these problems. Users who operate power tools on a continual and regular basis must monitor closely their physical condition and the condition of this tool.

**SPECIAL NOTICE:** This unit is equipped with a temperature limiting muffler and spark arresting screen which meets the requirements of California Codes 4442 and 4443. All U.S. forest land and the states of California, Idaho, Maine, Minnesota, New Jersey, Oregon, and Washington require by law that many internal combustion engines be equipped with a spark arresting screen. If you operate in a locale where such regulations exist, you are legally responsible for maintaining the operating condition of these parts. Failure to do so is a violation of the law. For normal homeowner use, the muffler and spark arresting screen will not require any service. After 50 hours of use, we recommend that your muffler be serviced or replaced by a Sears Service Center.

## ASSEMBLY

### CARTON CONTENTS

Check carton contents against the following list.

#### Model 358.792010

- Trimmer
- Shield
- Wing Nut (screwed onto shield)
- Container of line
- Container of oil
- Bump feed trimmer head

Examine parts for damage. Do not use damaged parts.

**NOTE:** If you need assistance or find parts missing or damaged, call 1-800-235-5878.

It is normal for the fuel filter to rattle in the empty fuel tank.

Finding fuel or oil residue on muffler is normal due to carburetor adjustments and testing done by the manufacturer.

### ASSEMBLY

**WARNING:** If received assembled, repeat all steps to ensure your unit is properly assembled and all fasteners are secure.

### ADJUSTING THE HANDLE

**WARNING:** When adjusting the assist handle, be sure it remains above the safety label and below the mark or arrow on the shaft.

1. Loosen wing nut on handle.
2. Rotate the handle on the shaft to an upright position; retighten wing nut.

### ATTACHING SHIELD

**WARNING:** The shield must be properly installed. The shield provides partial protection from the risk of thrown objects to the operator and others and is equipped with a line limiter blade which cuts excess line to the proper length. The line limiter blade (on underside of shield) is sharp and can cut you.

For proper orientation of shield, see KNOW YOUR TRIMMER illustration in OPERATION section.

1. Remove wing nut from shield.
2. Insert bracket into slot as shown.
3. Pivot shield until bolt passes through hole in bracket.
4. Securely tighten wing nut onto bolt.

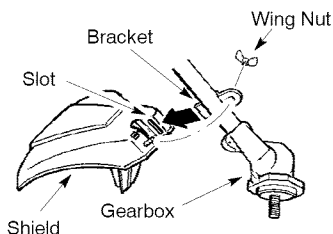

## OPERATION

### KNOW YOUR TRIMMER

READ THIS OPERATOR'S MANUAL AND SAFETY RULES BEFORE OPERATING YOUR UNIT. Compare the illustrations with your unit to familiarize yourself with the location of the various controls and adjustments. Save this manual for future reference.

Bump Feed Trimmer Head



Fixed Line Trimmer Head



Line Limiter Blade

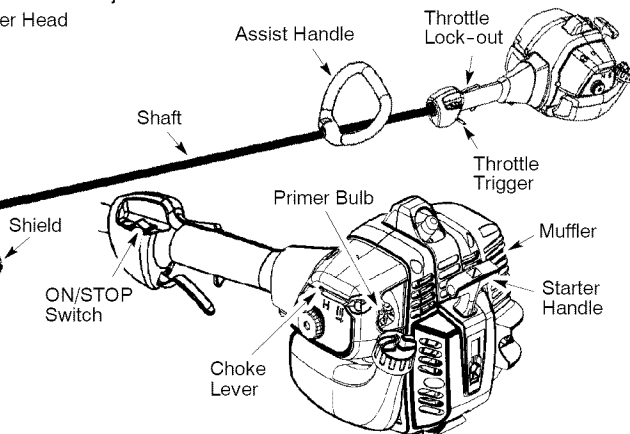

### ON/STOP SWITCH

The ON/STOP switch is used to stop engine. To stop the engine, push and release the engine ON/STOP switch.

### PRIMER BULB

The PRIMER BULB removes air from the carburetor and fuel lines and fills them with fuel. This allows you to start the engine with fewer pulls on the starter rope. Activate the primer bulb by pressing it and allowing it to return to its original form.

### THROTTLE LOCK-OUT

The THROTTLE LOCK-OUT must be pressed with the palm of your hand as you grip the throttle handle before the trigger can be used. This feature prevents you from accidentally squeezing the throttle trigger.

### CHOKE

The CHOKE helps to supply fuel to the engine to aid in cold starting. Activate the choke by moving the choke lever to the FULL CHOKE position. After the engine attempts to start, move the choke lever to the HALF CHOKE position. Once engine has started, move the choke lever to the OFF CHOKE position.

### BEFORE STARTING ENGINE

**WARNING:** Be sure to read the fuel information in the safety rules before you begin. If you do not understand the safety rules, do not attempt to fuel your unit. Call 1-800-235-5878.

### FUELING ENGINE

**WARNING:** Remove fuel cap slowly when refueling. This engine is certified to operate on unleaded gasoline. Before operation, gasoline must be mixed with a good

quality synthetic 2-cycle air-cooled engine oil. We recommend Craftsman brand synthetic oil. Mix gasoline and oil at a ratio of 40:1. A 40:1 ratio is obtained by mixing 3.2 ounces of oil with 1 gallon of unleaded gasoline. Included with this trimmer is a 3.2 ounce container of oil. Pour the entire contents of this container into 1 gallon of gasoline to achieve the proper fuel mixture. DO NOT USE automotive oil or marine oil. These oils will cause engine damage. When mixing fuel, follow instructions printed on container.

Once oil is added to gasoline, shake container momentarily to assure that the fuel is thoroughly mixed. Always read and follow the safety rules relating to fuel before fueling your unit.

### IMPORTANT

Alcohol blended fuels (called gasohol or using ethanol or methanol) can attract moisture which leads to separation and formation of acids during storage. Acidic gas can damage the fuel system of an engine while in storage. To avoid engine problems, empty the fuel system before storage for 30 days or longer. Drain the gas tank, start the engine and let it run until the fuel lines and carburetor are empty. Use fresh fuel next season. Never use engine or carburetor cleaner products in the fuel tank or permanent damage may occur. See the STORAGE section for additional information.

### HOW TO STOP YOUR UNIT

- Release the throttle trigger.
- Push and release the engine ON/STOP switch. The switch will automatically return to the ON position. Wait 5 seconds before attempting to restart unit to allow switch to reset.

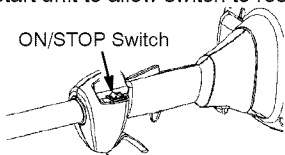

### HOW TO START YOUR UNIT

**⚠ WARNING:** Avoid any contact with the muffler. A hot muffler can cause serious burns.

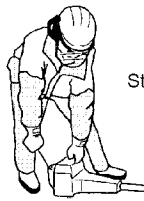

Starting Position

### STARTING A COLD ENGINE

**NOTE:** DO NOT squeeze the throttle trigger until the engine has started and runs.

1. Set unit on a flat surface.
2. Slowly press the primer bulb 10 times.

Primer Bulb

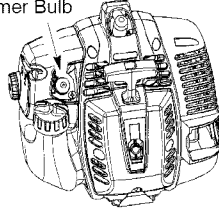

3. Move choke lever to FULL CHOKE position.

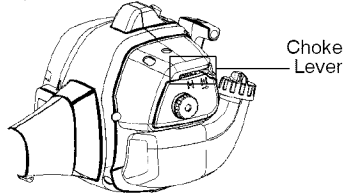

4. This unit has the Sim-pul™ starting system. You do not have to pull the starter rope handle sharply or briskly. Pull starter rope handle with a controlled and steady motion until engine sounds as if it is trying to start, but do not pull rope more than 3 times.
5. As soon as engine sounds as if it is trying to start, move choke lever to HALF CHOKE position.
6. Pull starter rope until engine runs. **NOTE:** If the engine doesn't start after 6 pulls (at the HALF CHOKE position), move the choke lever to the FULL CHOKE position. Pull the starter rope 2 more times. Move the choke lever to the HALF CHOKE position and pull the starter rope until the engine runs, but no more than 6 pulls. If the engine still doesn't start, it is probably flooded. Proceed to STARTING A FLOODED ENGINE.



- Once the engine starts, allow it to run 10 seconds, then move the choke lever to the OFF CHOKE position and begin normal operation. **NOTE:** If engine dies with the choke lever in the OFF CHOKE position, move the choke lever to the FULL CHOKE position and pull the rope until engine runs, but no more than 6 pulls.

#### STARTING A WARM ENGINE

- Move the choke lever to the HALF CHOKE position.
- Pull starter rope with a controlled and steady motion until engine runs, but no more than 6 pulls.
- Allow engine to run 15 seconds, then move the choke lever to OFF CHOKE and begin normal operation.

**NOTE:** If engine has not started, pull starter rope 5 more pulls. If engine still does not run, it is probably flooded.

#### STARTING A FLOODED ENGINE

Flooded engines can be started by placing the choke lever in the OFF CHOKE position; then, pull the rope to clear the engine of excess fuel. This could require pulling the starter handle many times depending on how badly the unit is flooded.

If the unit still doesn't start, refer to TROUBLESHOOTING TABLE or call 1-800-235-5878.

#### OPERATING INSTRUCTIONS

To maximize operating efficiency, do not run the engine for longer than 1 minute at a time at full throttle.

#### OPERATING POSITION

ALWAYS USE:

Hearing Protection → Eye Protection

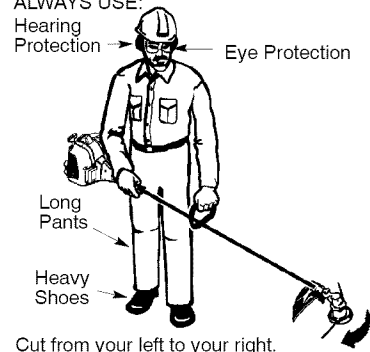

**WARNING:** Always wear eye protection and hearing protection. Never lean over the trimmer head. Rocks or debris can ricochet or be thrown into

eyes and face and cause blindness or other serious injury.

When operating unit, stand as shown and check for the following:

- Wear eye protection, hearing protection and heavy clothing.
- Hold trigger handle with right hand and assist handle with left hand.
- Hold unit so that engine is below waist level.
- Cut only from your left to your right to ensure debris is thrown away from you. Without bending over, keep line near and parallel to the ground and not crowded into material being cut.

Do not run the engine at a higher speed than necessary. The cutting line will cut efficiently when the engine is run at less than full throttle. At lower speeds, there is less engine noise and vibration.

Always release the throttle trigger and allow the engine to return to idle speed when not cutting.

#### HOW TO STOP YOUR UNIT

- Release the throttle trigger.
- Push and release the engine ON/STOP switch.

#### CUTTING METHODS

**WARNING:** Use minimum speed and do not crowd the line when cutting around hard objects (rock, gravel, fence posts, etc.), which can damage the trimmer head, become entangled in the line, or be thrown causing a serious hazard.

- The tip of the line does the cutting. You will achieve the best performance and minimum line wear by not crowding the line into the cutting area. The right and wrong ways are shown below.

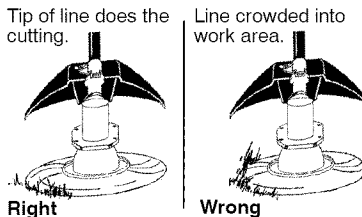

- The line will easily remove grass and weeds from around walls, fences, trees and flower beds, but it also can cut the tender bark of trees or shrubs and scar fences.
- For trimming or scalping, use less than full throttle to increase line life and decrease head wear, especially:

- During light duty cutting.
- Near objects around which the line can wrap such as small posts, trees or fence wire.

**TRIMMING** - Hold the bottom of the trimmer head about 3 inches (8 cm) above the ground and at an angle. Allow only the tip of the line to make contact with vegetation. Do not force trimmer line into work area.

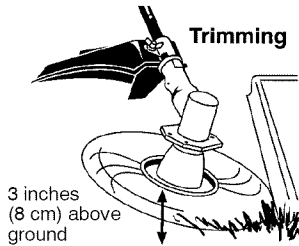

**SCALPING** - The scalping technique removes unwanted vegetation down to the ground. Hold the bottom of the trimmer head about 3 inches (8 cm) above the ground and at an angle. Allow the tip of the line to strike the ground around trees, posts, monuments, etc. This technique increases line wear.

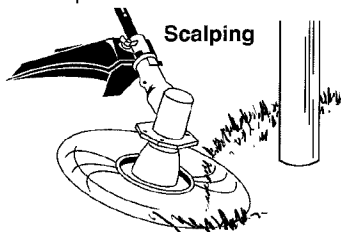

**MOWING** - Your trimmer is ideal for mowing in places conventional lawn mowers cannot reach. In the mowing position, keep the line parallel to the ground. Avoid pressing the head into the ground as this can scalp the ground and damage the tool.

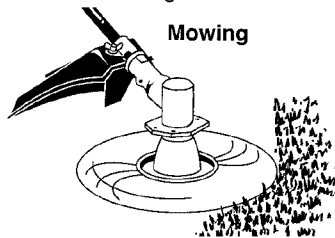

**SWEEPING** - The fanning action of the rotating line can be used to blow away loose debris from an area. Keep the line parallel to and above the area surface and swing the tool from side to side.



## MAINTENANCE

### MAINTENANCE SCHEDULE

**⚠ WARNING:** Disconnect the spark plug before performing maintenance except for carburetor adjustments.

CARE & MAINTENANCE TASK	WHEN TO PERFORM
Check for loose fasteners and parts	Before each use
Check for damaged or worn parts	Before each use
Inspect and clean unit and decals	After each use
Clean air filter	Every 5 hours of operation
Inspect muffler and spark arresting screen	Every 50 hours of operation
Replace spark plug	Yearly

## GENERAL RECOMMENDATIONS

The warranty on this unit does not cover items that have been subjected to operator abuse or negligence. To receive full value from the warranty, the operator must maintain unit as instructed in this manual. Various adjustments will need to be made periodically to properly maintain your unit.

## CHECK FOR LOOSE FASTENERS AND PARTS

- Spark Plug Boot
- Air Filter
- Housing Screws
- Assist Handle Screw
- Debris Shield

## CHECK FOR DAMAGED OR WORN PARTS

Contact Sears Service Center for replacement of damaged or worn parts.

- ON/STOP Switch - Ensure ON/STOP switch functions properly by pushing and releasing the switch. Make sure engine stops. Wait 5 seconds before attempting to restart unit to allow switch to reset. Restart engine and continue.
- Fuel Tank - Discontinue use of unit if fuel tank shows signs of damage or leaks.
- Debris Shield - Discontinue use of unit if debris shield is damaged.

## INSPECT AND CLEAN UNIT AND DECALS

- After each use, inspect complete unit for loose or damaged parts. Clean the unit and decals using a damp cloth with a mild detergent.
- Wipe off unit with a clean dry cloth.

## CLEAN AIR FILTER

A dirty air filter decreases engine performance and increases fuel consumption and harmful emissions. Always clean after every 5 hours of operation.

1. Clean the cover and the area around it to keep dirt from falling into the carburetor chamber when the cover is removed.
2. Remove parts as illustrated.

**NOTE:** To avoid creating a fire hazard or producing harmful evaporative emissions, do not clean filter in gasoline or other flammable solvent.

3. Wash the filter in soap and water.
4. Allow filter to dry.
5. Replace parts.

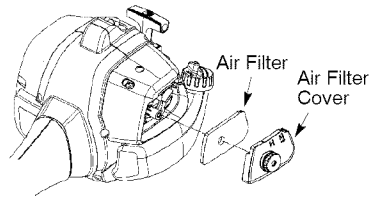

## INSPECT MUFFLER AND SPARK ARRESTING SCREEN

**WARNING:** The muffler on this product contains chemicals known to the State of California to cause cancer.

As your unit is used, carbon deposits build up on the muffler and spark arresting screen.

For normal homeowner use, however, the muffler and spark arresting screen will not require any service. After 50 hours of use, we recommend that your muffler be serviced or replaced by your Sears Service Center.

## REPLACE SPARK PLUG

Replace the spark plug each year to ensure the engine starts easier and runs better. Set spark plug gap at 0.025 inch. Ignition timing is fixed and nonadjustable.

1. Twist, then pull off spark plug boot.
2. Remove spark plug from cylinder and discard.
3. Replace with Champion RCJ-6Y spark plug and tighten securely with a 3/4 inch socket wrench.
4. Reinstall the spark plug boot.

## SERVICE AND ADJUSTMENTS

### LINE REPLACEMENT IN FIXED LINE TRIMMER HEAD

- Always use Craftsman replacement line.

Choose the line size best suited for the job at hand. Red line (#71-85908) is designed for cutting grass and small weeds. The black colored line (#71-85909) is designed for cutting larger weeds and light brush.

1. Remove any remaining line from the trimmer head.

**NOTE:** The line glide plate is held in place by the cutting line. The line must be removed to release the line glide plate from the trimmer head.

2. Remove the line glide plate.
3. Clean entire surface of trimmer head.
4. Reinstall line glide plate (see illustration).

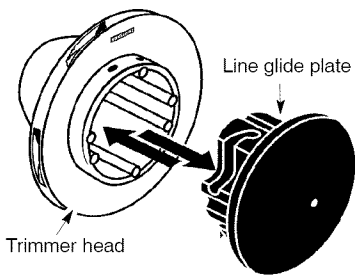

**NOTE:** The line glide plate must be re-installed in trimmer head before inserting new line. Use large holes when replacing line.

5. Insert both ends of line through the proper holes in the side of the trimmer head.

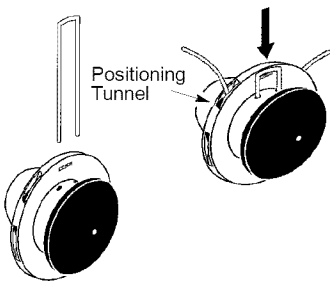

6. Repeat step 5 for second line.

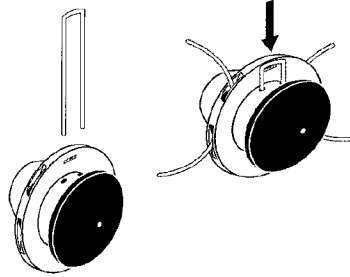

7. Pull both lines and make sure the lines are against the hub and extended full through the positioning tunnels.

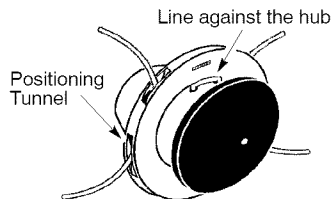

8. Correctly installed line will be the same length on both ends.

### LINE REPLACEMENT IN BUMP FEED TRIMMER HEAD

1. Remove any remaining line from trimmer head.

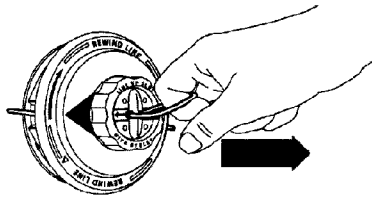

2. Clean entire surface of trimmer head.
3. Replace line using a 15 feet (4.5 meters) length of 0.095 inch (2.4 mm) diameter Craftsman brand line (#71-85904).

- ⚠ WARNING:** Never use wire, rope, string, etc., which can break off and become a dangerous missile.
4. Align arrows on tap button with line exit holes on side of trimmer head.

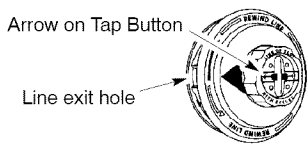

5. Bend the line at the midpoint and insert both ends of the line through the holes in the center of the tap button.

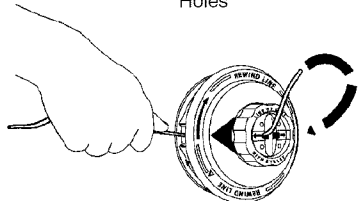
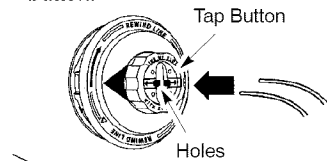

6. Pull ends of line and make sure the line is against the tap button and extended evenly through the line exit holes on both sides of the trimmer head.

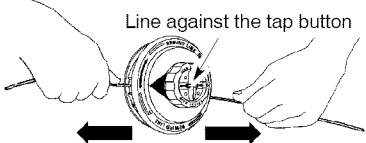
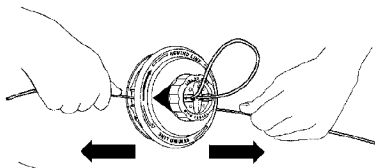

7. Rewind line to desired length by turning tap button in direction shown on spool.

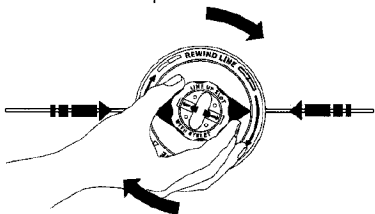

**If cutting line retreats into trimmer head during use:**

1. Remove cover from trimmer head by pressing tab and turning cover clockwise (looking from bottom of unit).

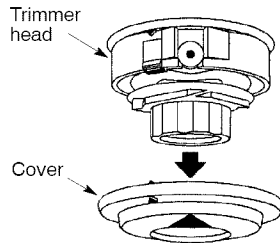
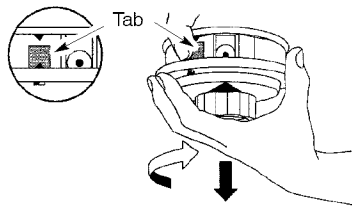

2. Remove spool and line from trimmer head.

**NOTE:** Ensure spring remains in center of trimmer head.

3. Unwind and remove all line from spool. Reinstall spool in trimmer head.
4. Align arrow on cover with arrow on trimmer head. Reinstall cover by turning counterclockwise.

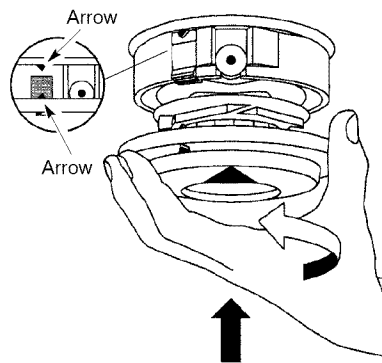

5. Reinstall line into trimmer head by repeating steps 4-7.

## REPLACING THE TRIMMER HEAD

1. Align hole in the dust cup with the hole in the side of the gearbox by rotating the arbor shaft.
2. Insert a small screwdriver into aligned holes. This will keep the shaft from turning while removing and installing trimmer head.

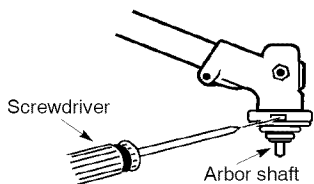

3. While holding the screwdriver in position, remove trimmer head by turning clockwise (looking from bottom of unit).
4. Thread replacement trimmer head onto the shaft by turning counterclockwise. **Only tighten hand tight!**
5. Remove the screwdriver.

## CARBURETOR IDLE SPEED ADJUSTMENT

**⚠ WARNING:** Keep others away when making idle speed adjustments. The trimmer head will be spinning during most of this procedure. Wear your protective equipment and observe all safety precautions. After making adjustments, the trimmer head must not move or spin at idle speed.

The carburetor has been carefully set at the factory. Adjustments may be necessary if you notice any of the following conditions:

- Engine will not idle when the throttle is released.

- The trimmer head moves or spins at idle.

Make adjustments with the unit supported so the cutting attachment is off the ground and will not make contact with any object. Hold the unit by hand while running and making adjustments. Keep all parts of your body away from the cutting attachment and muffler.

### To adjust idle speed:

Allow engine to idle. Adjust speed until engine runs without trimmer head moving or spinning (idle too fast) or engine stalling (idle speed too slow).

- Turn idle speed screw clockwise to increase engine speed if engine stalls or dies.
- Turn idle speed screw counterclockwise to decrease engine speed if trimmer head moves or spins at idle.

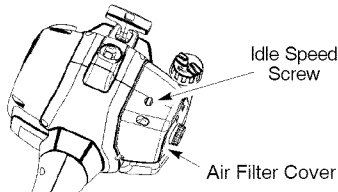

**⚠ WARNING:** Recheck the idle speed after each adjustment. The trimmer head must not move or spin at idle speed to avoid serious injury to the operator or others.

If you require further assistance or are unsure about performing this procedure, contact your Sears Service Center or call our customer assistance help line at 1-800-235-5878.

## STORAGE

**⚠ WARNING:** Perform the following steps after each use:

- Allow engine to cool before storing or transporting.
- Store unit and fuel in a well ventilated area where fuel vapors cannot reach sparks or open flames from water heaters, electric motors or switches, furnaces, etc.
- Store unit with all guards in place. Position unit so that any sharp object cannot accidentally cause injury.
- Store unit and fuel well out of the reach of children.

### SEASONAL STORAGE

Prepare unit for storage at end of season or if it will not be used for 30 days or more.

If your unit is to be stored for a period of time:

- Clean the entire unit before lengthy storage.
- Store in a clean dry area.
- Lightly oil external metal surfaces.

### FUEL SYSTEM

Empty the fuel system before storage for 30 days or longer. Drain the gas tank, start the engine and let it run until the fuel lines and carburetor are empty. Use fresh fuel next season.

Under FUELING ENGINE in the OPERATION section of this manual, see message labeled **IMPORTANT** regarding the use of gasohol in your engine.

Fuel stabilizer is an acceptable alternative in minimizing the formation of fuel gum deposits during storage. Add stabilizer to the gasoline in the fuel tank or fuel storage container. Follow the mix instructions found on stabilizer container. Run engine at least 3 minutes after adding stabilizer.

Craftsman 40:1, 2-cycle engine oil (air cooled) is already blended with fuel stabilizer. If you do not use this Sears oil, you can add a fuel stabilizer to your fuel tank.

## ENGINE

- Remove spark plug and pour 1 teaspoon of 40:1, 2-cycle engine oil (air cooled) through the spark plug opening. Slowly pull the starter rope 8 to 10 times to distribute oil.
- Replace spark plug with new one of recommended type and heat range.
- Clean air filter.
- Check entire unit for loose screws, nuts, and bolts. Replace any damaged, broken, or worn parts.
- At the beginning of the next season, use only fresh fuel having the proper gasoline to oil ratio.

## OTHER

- Do not store gasoline from one season to another.
- Replace your gasoline can if it starts to rust.

## TROUBLESHOOTING TABLE

**⚠ WARNING:** Always stop unit and disconnect spark plug before performing all of the recommended remedies below except remedies that require unit to be operating.

TROUBLE	CAUSE	REMEDY
Engine will not start.	<ol style="list-style-type: none"> <li>1. Engine flooded.</li> <li>2. Fuel tank empty.</li> <li>3. Spark plug not firing.</li> <li>4. Fuel not reaching carburetor.</li> <li>5. Carburetor requires adjustment.</li> </ol>	<ol style="list-style-type: none"> <li>1. See "Starting a Flooded Engine" in Operation Section.</li> <li>2. Fill tank with correct fuel mixture.</li> <li>3. Install new spark plug.</li> <li>4. Check for dirty fuel filter; replace. Check for kinked or split fuel line; repair or replace.</li> <li>5. Contact Sears Service (see back cover).</li> </ol>
Engine will not idle properly.	<ol style="list-style-type: none"> <li>1. Carburetor requires adjustment.</li> <li>2. Crankshaft seals worn.</li> <li>3. Compression low.</li> </ol>	<ol style="list-style-type: none"> <li>1. See "Carburetor Idle Speed Adjustment" in Service and Adjustments Section.</li> <li>2. Contact Sears Service (see back cover).</li> <li>3. Contact Sears Service (see back cover).</li> </ol>
Engine will not accelerate, lacks power, or dies under a load.	<ol style="list-style-type: none"> <li>1. Air filter dirty.</li> <li>2. Spark plug fouled.</li> <li>3. Carburetor requires adjustment.</li> <li>4. Carbon build-up on muffler outlet screen.</li> <li>5. Compression low.</li> </ol>	<ol style="list-style-type: none"> <li>1. Clean or replace air filter.</li> <li>2. Clean or replace plug and regap.</li> <li>3. Contact Sears Service (see back cover).</li> <li>4. Contact Sears Service (see back cover).</li> <li>5. Contact Sears Service (see back cover).</li> </ol>
Engine smokes excessively.	<ol style="list-style-type: none"> <li>1. Fuel mixture incorrect.</li> <li>2. Air filter dirty.</li> <li>3. Carburetor requires adjustment.</li> </ol>	<ol style="list-style-type: none"> <li>1. Empty fuel tank and refill with correct fuel mixture.</li> <li>2. Clean or replace air filter.</li> <li>3. Contact Sears Service (see back cover).</li> </ol>
Engine runs hot.	<ol style="list-style-type: none"> <li>1. Fuel mixture incorrect.</li> <li>2. Spark plug incorrect.</li> <li>3. Carburetor requires adjustment.</li> <li>4. Carbon build-up on muffler outlet screen.</li> </ol>	<ol style="list-style-type: none"> <li>1. See "Fueling Engine" in Operation section.</li> <li>2. Replace with correct spark plug.</li> <li>3. Contact Sears Service (see back cover).</li> <li>4. Contact Sears Service (see back cover).</li> </ol>

## U.S. EPA / CALIFORNIA EMISSION CONTROL WARRANTY STATEMENT

**YOUR WARRANTY RIGHTS AND OBLIGATIONS:** The U.S. Environmental Protection Agency/California Air Resources Board and Sears, Roebuck and Co., U.S.A., are pleased to explain the emissions control system warranty on your year 2009 and later small off-road engine. In California, all small off-road engines must be designed, built, and equipped to meet the State's stringent anti-smog standards. Sears must warrant the emission control system on your small off-road engine for the periods of time listed below provided there has been no abuse, neglect, or improper maintenance of your small off-road engine. Your emission control system includes parts such as the carburetor, the ignition system and the fuel tank. Where a warrantable condition exists, Sears will repair your small off-road engine at no cost to you. Expenses covered under warranty include diagnosis, parts and labor. **MANUFACTURER'S WARRANTY COVERAGE:** If any emissions related part on your engine (as listed under Emissions Control Warranty Parts List) is defective or a defect in the materials or workmanship of the engine causes the failure of such an emission related part, the part will be repaired or replaced by Sears. **OWNER'S WARRANTY RESPONSIBILITIES:** As the small off-road engine owner, you are responsible for the performance of the required maintenance listed in your operator's manual. Sears recommends that you retain all receipts covering maintenance on your small off-road engine, but Sears cannot deny warranty solely for the lack of receipts or for your failure to ensure the performance of all scheduled maintenance. As the small off-road engine owner, you should be aware that Sears may deny you warranty coverage if your small off-road engine or a part of it has failed due to abuse, neglect, improper maintenance, unapproved modifications, or the use of parts not made or approved by the original equipment manufacturer. You are responsible for presenting your small off-road engine to a Sears authorized repair center as soon as a problem exists. Warranty repairs should be completed in a reasonable amount of time, not to exceed 30 days. If you have any questions regarding your warranty rights and responsibilities, you should contact

your nearest authorized service center, call Sears at 1-800-469-4663, or send e-mail correspondence to [emission\\_warranty@HCOP-emission.com](mailto:emission_warranty@HCOP-emission.com). **WARRANTY COMMENCEMENT DATE:** The warranty period begins on the date the small off-road engine is purchased. **LENGTH OF COVERAGE:** This warranty shall be for a period of two years from the initial date of purchase. **WHAT IS COVERED: REPAIR OR REPLACEMENT OF PARTS.** Repair or replacement of any warranted part will be performed at no charge to the owner at an approved Sears Service Center. If you have any questions regarding your warranty rights and responsibilities, you should contact your nearest authorized service center, call Sears at 1-800-469-4663, or send e-mail correspondence to [emission\\_warranty@HCOP-emission.com](mailto:emission_warranty@HCOP-emission.com). **WARRANTY PERIOD:** Any warranted part which is not scheduled for replacement as required maintenance, or which is scheduled only for regular inspection to the effect of "repair or replace as necessary" shall be warranted for 2 years. Any warranted part which is scheduled for replacement as required maintenance shall be warranted for the period of time up to the first scheduled replacement point for that part. **DIAGNOSIS:** The owner shall not be charged for diagnostic labor which leads to the determination that a warranted part is defective if the diagnostic work is performed at an approved Sears Service Center. **CONSEQUENTIAL DAMAGES:** Sears may be liable for damages to other engine components caused by the failure of a warranted part still under warranty. **WHAT IS NOT COVERED:** All failures caused by abuse, neglect, or improper maintenance are not covered. **ADD-ON OR MODIFIED PARTS:** The use of add-on or modified parts can be grounds for disallowing a warranty claim. Sears is not liable to cover failures of warranted parts caused by the use of add-on or modified parts. **HOW TO FILE A CLAIM:** If you have any questions regarding your warranty rights and responsibilities, you should contact your nearest authorized service center, call Sears at 1-800-469-4663, or send e-mail correspondence to [emission\\_warranty@HCOP-emission.com](mailto:emission_warranty@HCOP-emission.com).



**WHERE TO GET WARRANTY SERVICE:** Warranty services or repairs shall be provided at all Sears Service Centers. Call 1-800-469-4663 or send e-mail correspondence to [emission\\_warranty@HCOP-emission.com](mailto:emission_warranty@HCOP-emission.com).  
**MAINTENANCE, REPLACEMENT AND REPAIR OF EMISSION RELATED PARTS:** Any Sears approved replacement part used in the performance of any warranty maintenance or repair on emission related parts will be provided without charge to the owner if the part is under warranty.

**EMISSION CONTROL WARRANTY PARTS LIST:** Carburetor, air filter (covered up to maintenance schedule), ignition system: spark plug (covered up to maintenance schedule), ignition module, muffler including catalyst (if equipped), fuel tank.  
**MAINTENANCE STATEMENT:** The owner is responsible for the performance of all required maintenance as defined in the operator's manual.

The information on the product label indicates which standard your engine is certified.  
Example: (Year) EPA and/or CALIFORNIA.

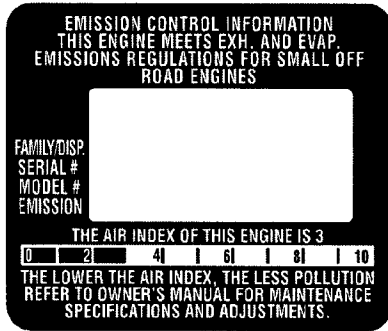

This engine is certified to be emissions compliant for the following use:

- Moderate (50 hours)
- Intermediate (125 hours)
- Extended (300 hours)