

# LCD Digital Colour TV



## Operating Instructions

-  Before operating the TV, please read the “Safety information” section of this manual.  
Retain this manual for future reference.

**DVB<sup>®</sup> HD**  
Digital Video  
Broadcasting **ready**

**KDL-46S2000 KDL-46S2010**  
**KDL-40S2000 KDL-40S2010**  
**KDL-32S2000 KDL-32S2010**  
**KDL-32S2020 KDL-26S2000**  
**KDL-26S2010 KDL-26S2020**

# BRAVIA



For useful information about Sony products

<http://www.sony-europe.com/myproduct>

# NOTICE FOR CUSTOMERS IN THE UNITED KINGDOM

A moulded plug complying with BS1363 is fitted to this equipment for your safety and convenience.

Should the fuse in the plug supplied need to be replaced, a 13 AMP fuse approved by ASTA or BSI to BS 1362 (i.e., marked with ⚡ or ⚡) must be used.

When an alternative type of plug is used it should be fitted with a 13 AMP FUSE, otherwise the circuit should be protected by a 13 AMP FUSE at the distribution board. If the plug supplied with this equipment has a detachable fuse cover, be sure to attach the fuse cover after you change the fuse. Never use the plug without the fuse cover. If you should lose the fuse cover, please contact your nearest Sony service station.

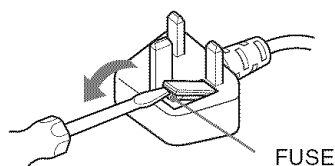

## How to replace the fuse

Open the fuse compartment with a blade screwdriver, and replace the fuse.

## WARNING

- To prevent the risk of electric shock, if the mains lead or plug is damaged, do not insert the plug into the mains socket outlet. This plug cannot be used and should be destroyed.
- To prevent the risk of fire or electric shock, do not expose the TV set to rain or moisture.
- Dangerously high voltages are present inside the TV set. Do not open the cabinet. Refer servicing to qualified personnel only.

## Notice for Digital TV function

- Any functions related to Digital TV (**DVB**) will only work in countries or areas where DVB-T (MPEG2) digital terrestrial signals are broadcasted. Please confirm with your local dealer if you can receive a DVB-T signal where you live.
- Although this TV set follows DVB-T specifications, compatibility with future DVB-T digital terrestrial broadcasts cannot be guaranteed.
- Some Digital TV functions may not be available in some countries.

## Introduction

Thank you for choosing this Sony product. Before operating the TV, please read this manual thoroughly and retain it for future reference.

## Trademark information

- **DVB** is a registered trademark of the DVB Project
- Manufactured under license from BBE Sound, Inc. Licensed by BBE Sound, Inc. under one or more of the following US patents: 5510752, 5736897. BBE and BBE symbol are registered trademarks of BBE Sound, Inc.
- TruSurround XT, SRS and (●) symbol are trademarks of SRS Labs, Inc. TruSurround XT technology is incorporated under license from SRS Labs, Inc.
- **HDMI** HDMI, the HDMI logo and High-Definition Multimedia Interface are trademarks or registered trademarks of HDMI Licensing, LLC.
- The illustrations used in this manual are of the KDL-32S2000/KDL-32S2010/KDL-32S2020 unless otherwise state.

# Table of Contents

## Start-up Guide

4

Safety information .....	7
Precautions .....	10
<b>Overview of the remote .....</b>	<b>11</b>
<b>Overview of the TV buttons and indicators .....</b>	<b>12</b>

## Watching TV

Watching TV .....	13
Checking the Digital Electronic Programme Guide (EPG) <b>DVB</b> .....	16
Using the Favourite list <b>DVB</b> .....	18
Viewing pictures from connected equipment .....	19

## Using MENU Functions

Navigating through menus .....	20
Picture menu .....	21
Sound menu .....	23
Screen menu .....	25
Set-up menu .....	26
PC Settings menu .....	28
Analogue Set-up menu (Analogue mode only) .....	29
Digital Set-up menu <b>DVB</b> .....	31

## Using Optional Equipment

Connecting optional equipment.....	33
------------------------------------	----

## Additional Information

Specifications .....	36
Troubleshooting .....	38
Index .....	40

**DVB** : for digital channels only

# 1: Checking the accessories

Remote RM-ED005 (1)

Size AA batteries (R6 type) (2)

Mains lead (Type BF) (1)

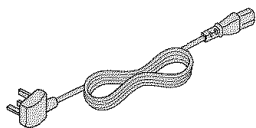

Coaxial cable (1)



Cable holder (1)

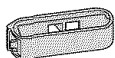

Support belt (1) and screws (2)

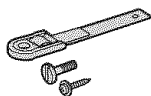

## To insert batteries into the remote

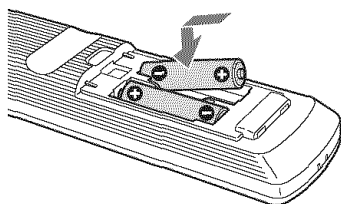

### Notes

- Observe the correct polarity when inserting batteries.
- Dispose of batteries in an environmentally friendly way. Certain regions may regulate disposal of the battery. Please consult your local authority.
- Do not use different types of batteries together or mix old and new batteries.
- Handle the remote with care. Do not drop or step on it, or spill liquid of any kind onto it.
- Do not place the remote in a location near a heat source, or in a place subject to direct sunlight, or in a damp room.

# 2: Connecting an aerial/VCR

## Connecting an aerial only

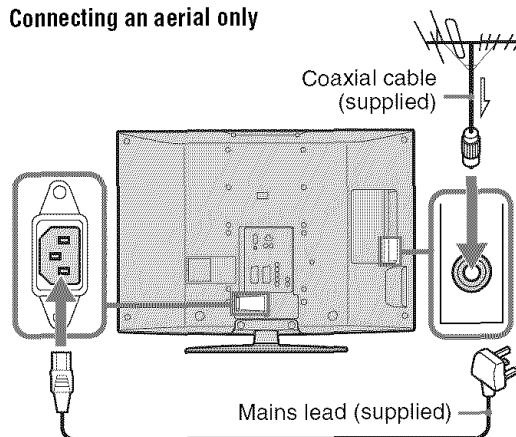

## Connecting an aerial and VCR

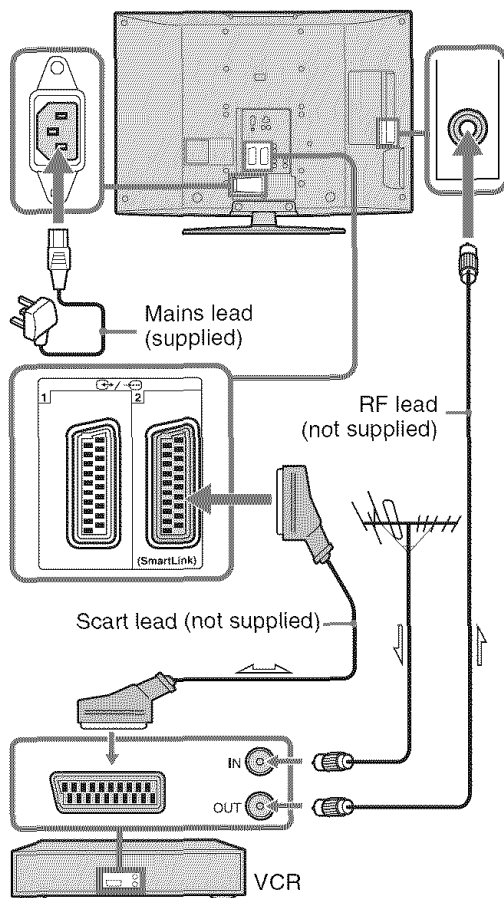

### 3: Bundling the cables

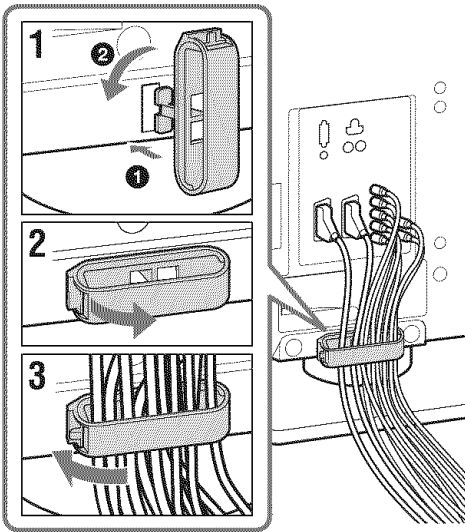

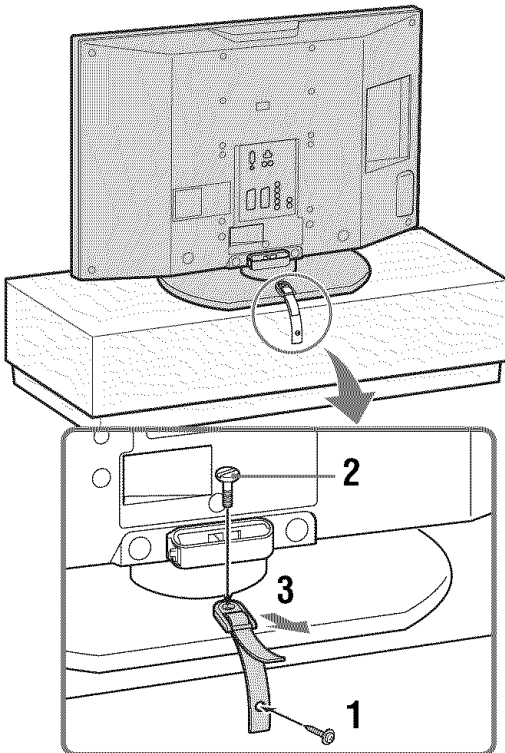

### 4: Preventing the TV from toppling over

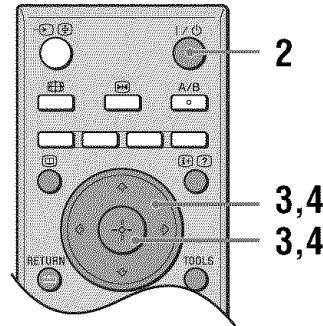
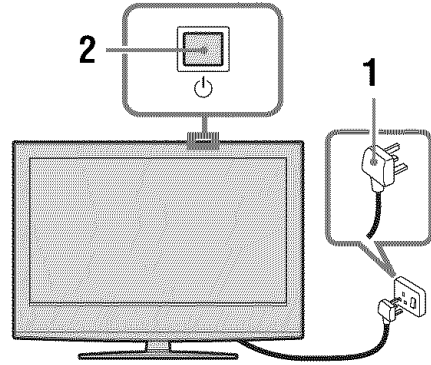

### 5: Selecting the language and country/region



- 1** Connect the TV to your mains socket (220-240V AC, 50Hz).
- 2** Press  on the TV (top side).  
When you switch on the TV for the first time, the Language menu appears on the screen.  
When the TV is in standby mode (the  (standby) indicator on the TV (front) is red), press  on the remote to switch on the TV.

Continued

- 3 Press  $\uparrow/\downarrow$  to select the language displayed on the menu screens, then press  $\oplus$ .



- 4 Press  $\uparrow/\downarrow$  to select the country/region in which you will operate the TV, then press  $\oplus$ .



If the country/region in which you want to use the TV does not appear in the list, select “-” instead of a country/region.

The message confirming the TV start auto-tuning appears on the screen, then go to “6: Auto-tuning the TV”.

- 1 Before you start auto-tuning the TV, insert a pre-recorded tape into the VCR connected to the TV (page 4) and start play back.

The video channel will be located and stored on the TV during auto-tuning.

If no VCR is connected to the TV, this procedure is not required. Go to step 2.

- 2 Select “OK”, then press  $\oplus$ .

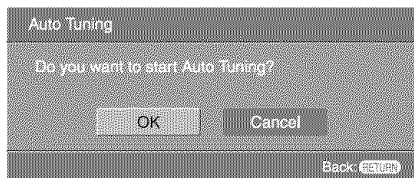

The TV starts searching for all available digital channels, followed by all available analogue channels. This may take some time, please be patient and do not press any buttons on the TV or remote.

#### If a message appears for you to confirm the aerial connections

No digital or analogue channels were found.

Check all the aerial connections and press  $\oplus$  to start auto-tuning again.

- 3 When the Programme Sorting menu appears on the screen, follow the steps of “Programme Sorting” (page 29).

If you do not wish to change the order in which the analogue channels are stored on the TV, go to step 4.

- 4 Press MENU to exit.

The TV has now tuned in all the available channels.

## 6: Auto-tuning the TV

The TV will now search for and store all available TV channels.

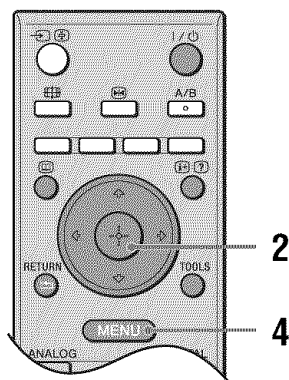

# Safety information

## Mains lead

- Unplug the mains lead when moving the TV set. Do not move the TV set with the mains lead plugged in. It may damage the mains lead and result in fire or electric shock.
- If you damage the mains lead, it may result in fire or electric shock.
  - Do not pinch, bend, or twist the mains lead excessively. The core conductors may be exposed or broken, causing a short-circuit, which may cause fire or electric shock.
  - Do not modify or damage the mains lead.
  - Do not put anything heavy on the mains lead. Do not pull the mains lead.
  - Keep the mains lead away from heat sources.
  - Be sure to grasp the plug when disconnecting the mains lead.
- If the mains lead is damaged, stop using it and ask your dealer or Sony service centre to exchange it.
- Do not use the supplied mains lead on any other equipment.
- Use only an original Sony mains lead, not other brands.

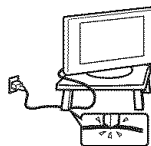
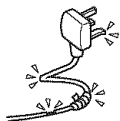
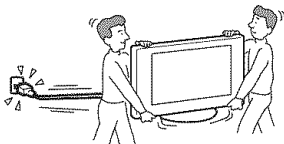

## Mains lead/cable protection

Pull out the mains lead/cable by the plug. Do not pull on the mains lead/cable itself.

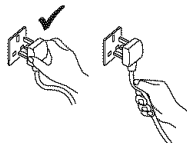

## Mains

Do not use a poor fitting mains socket. Insert the plug fully into the mains socket. A poor fit may cause arcing and result in fire. Contact your electrician to have the mains socket changed.

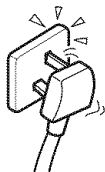

## For the TV set with a three-wire grounding type AC mains plug

This TV set must be connected to an AC mains socket with a protective earthing connection.

## Optional accessories

Observe the following when installing the TV set using a wall-mount bracket. If you do not do so, the TV set may fall and cause serious injury.



- It is strongly recommended that you use Sony accessories for safety reasons:
  - **KDL-46S2000/KDL-46S2010/KDL-40S2000/KDL-40S2010:**  
Wall-mount bracket SU-WL51
  - **KDL-32S2000/KDL-32S2010/KDL-32S2020/KDL-26S2000/KDL-26S2010/KDL-26S2020:**  
Wall-mount bracket SU-WL31
- It is strongly recommended that you use the official Sony wall-mount bracket to allow adequate air circulation and to avoid dust build up around the TV, wall and ceiling.
- Secure the TV set properly, following the instructions supplied with your wall-mount bracket when installing the TV set.

## Installation

- If the TV set is to be installed on a wall, have the installation carried out by qualified service men. Improper installation may render the TV set unsafe.
- The TV should be installed near an easily accessible mains socket.

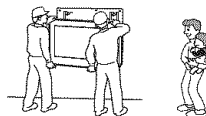

## Medical institutions

Do not place this TV set in a place where medical equipment is in use. It may cause malfunction of medical instruments.

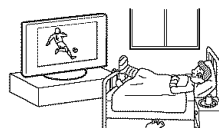

## Carrying

- Before carrying the TV set, disconnect all the cables from the TV set.
- When you carry the TV set by hand, hold the TV set as illustrated on the right. If you do not do so, the TV set may fall and be damaged or cause serious injury. If the TV set has been dropped or damaged, have it checked immediately by qualified service personnel.
- When transporting it, do not subject the TV set to jolts or excessive vibration. The TV set may fall and be damaged or cause serious injury.
- When you carry the TV set in for repair or when you move it, pack it using the original carton and packing material.
- Carrying the TV set requires two or more people.

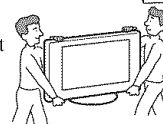

## Ventilation

- Never cover the ventilation holes in the cabinet. It may cause overheating and result in fire.
- Unless proper ventilation is provided, the TV set may gather dust and get dirty. For proper ventilation, observe the following:
  - Do not install the TV set turned backwards or sideways.
  - Do not install the TV set turned over or upside down.
  - Do not install the TV set on a shelf or in a closet.
  - Do not place the TV set on a rug or bed.
  - Do not cover the TV set with cloth, such as curtains, or items such as newspapers, etc.



Continued

- Leave some space around the TV set. Otherwise, air-circulation may be inadequate and cause overheating, which may cause fire or damage to the TV set.

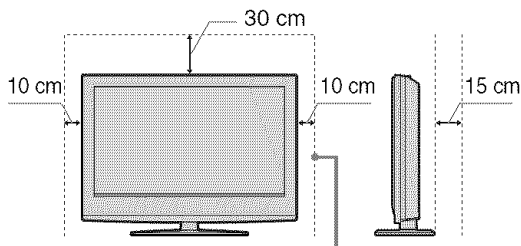

Leave at least this much space.

- When installing the TV set on the wall, leave at least 10 cm space from the bottom, and at least 5.5 cm between the back of the TV set and the wall.
- Never install the TV set as follows:

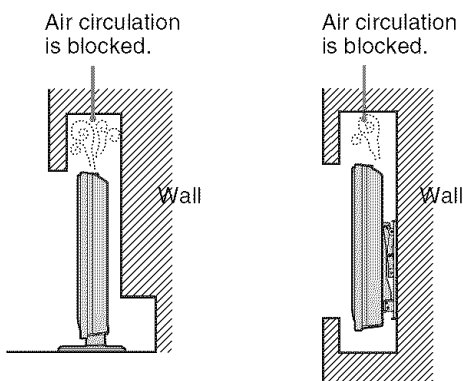

### Ventilation holes

Do not insert anything in the ventilation holes. If metal or liquid is inserted in these holes, it may result in fire or electric shock.



### Placement

- Never place the TV set in hot, humid or excessively dusty places.
- Do not install the TV set where insects may enter.
- Do not install the TV set where it may be exposed to mechanical vibration.
- Place the TV set on a stable, level surface. Otherwise, the TV set may fall and cause injury.
- Do not install the TV set in a location where it may protrude, such as on or behind a pillar, or where you might bump your head on it. Otherwise, it may result in injury.



### Water and moisture

- Do not use this TV set near water – for example, near a bathtub or shower room. Also do not expose to rain, moisture or smoke. This may result in fire or electric shock.

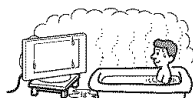

- Do not touch the mains lead and the TV set with wet hands. Doing so may cause electric shock or damage to the TV set.



### Moisture and flammable objects

- Do not let this TV set get wet. Never spill liquid of any kind on the TV set. If any liquid or solid object does fall through openings in the cabinet, do not operate the TV set. It may result in electric shock or damage to the TV set. Have it checked immediately by qualified service personnel.
- To prevent fire, keep flammable objects (candles, etc.) and electric bulbs away from the TV set.

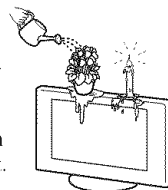

### Oils

Do not install this TV set in restaurants that use oil. Dust absorbing oil may enter and damage the TV set.

### Fall

Place the TV set on a secure, stable stand. Do not hang anything on the TV set. If you do, the TV set may fall from the stand or wall-mount bracket, causing damage or serious injury.

Do not allow children to climb on the TV set.



### Vehicle or ceiling

Do not install this TV set in a vehicle. The motion of the vehicle may cause the TV set to fall down and cause injury. Do not hang this TV set from the ceiling.

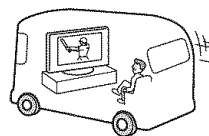

### Ships and other vessels

Do not install this TV set on a ship or other vessel. If the TV set is exposed to seawater, it may cause fire or damage the TV set.

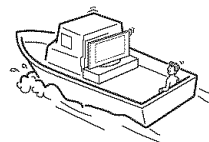

### Outdoor use

- Do not expose the TV set to direct sunlight. The TV set may heat up and this may result in damage to the TV set.
- Do not install this TV set outdoors.

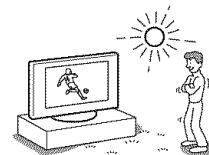

### Wiring

- Unplug the mains lead when wiring cables. When hooking up, be sure to unplug the mains lead for your safety.
- Take care not to catch your feet on the cables. It may damage the TV set.

### Cleaning

- Unplug the mains lead when cleaning the mains plug and this TV set. If you do not, it may result in electric shock.
- Clean the mains plug regularly. If the plug is covered with dust and it picks up moisture, its insulation may deteriorate and result in fire.

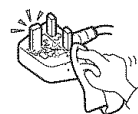



## Lightning storms

For your own safety, do not touch any part of the TV set, mains lead, or aerial lead during lightning storms.

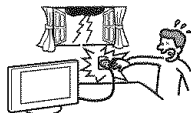

## Damage requiring service

If the surface of the TV set cracks, do not touch it until you have unplugged the mains lead. Otherwise electric shock may result.

## Servicing

Do not open the cabinet. Entrust the TV set to qualified service personnel only.



## Small accessories removal and fittable

Keep accessories out of children's reach. If they are swallowed, choking or suffocation may occur. Call a doctor immediately.

## Broken pieces

Do not throw anything at the TV set. The screen glass may break by the impact and cause serious injury.

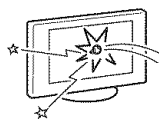

## When not in use

For environmental and safety reasons, it is recommended that the TV set is not left in standby when unused. Disconnect from the mains. However, some TV sets may have features which need the TV set to be left in standby to work correctly. The instructions in this manual will inform you if this applies.

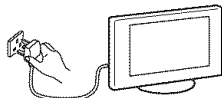

## Viewing the TV

- To view the TV comfortably, the recommended viewing position is from four to seven times the screen's vertical length away from the TV set.
- View the TV in moderate light, as viewing the TV in poor light strains your eyes. Watching the screen continuously for long periods of time can also strain your eyes.
- If the angle of the TV set is to be adjusted, steady the base of the stand with your hand to prevent the TV set from becoming separated from the stand. Be careful not to get your fingers caught between the TV set and the stand.

## Volume adjustment

- Adjust the volume so as not to trouble your neighbours. Sound carries very easily at night time. Therefore, closing the windows or using headphones is suggested.
- When using headphones, adjust the volume so as to avoid excessive levels, as hearing damage may result.

## Overloading

This TV set is designed to operate on a 220–240 V AC supply only. Take care not to connect too many appliances to the same mains socket as this could result in fire or electric shock.

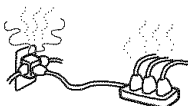

## Heat

Do not touch the surface of the TV set. It remains hot, even after the TV set has been turned off for some time.

## Corrosion

If you use this TV set near the seashore, salt may corrode metal parts of the TV set and cause internal damage or fire. It may also shorten the life of the TV set. Steps should be taken to reduce the humidity and moderate the temperature of the area where the TV set is located.

## Handling

- When lifting the TV set or moving the panel of the TV set, hold it firmly from the bottom.
- For the KDL-46S2000/KDL-46S2010, when lifting or moving the TV, be sure to hold the panel firmly as illustrated. Place your palm directly under the panel, from the rear of the TV.

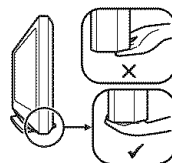
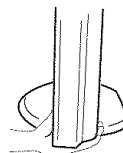

# Precautions

## LCD Screen

- Although the LCD screen is made with high-precision technology and 99.99% or more of the pixels are effective, black dots may appear or bright points of light (red, blue, or green) may appear constantly on the LCD screen. This is a structural property of the LCD panel and is not a malfunction.
- Do not expose the LCD screen surface to the sun. Doing so may damage the screen surface.
- Do not push or scratch the front filter, or place objects on top of this TV set. The image may be uneven or the LCD panel may be damaged.
- If this TV set is used in a cold place, a smear may occur in the picture or the picture may become dark. This does not indicate a failure. These phenomena disappear as the temperature rises.
- Ghosting may occur when still pictures are displayed continuously. It may disappear after a few moments.
- The screen and cabinet get warm when this TV set is in use. This is not a malfunction.
- The LCD contains a small amount of liquid crystal and mercury. The fluorescent tube used in this TV set also contains mercury. Follow your local ordinances and regulations for disposal.

## Fluorescent lamp

This TV set uses a special fluorescent lamp as its light source. If the screen image becomes dark, flickers, or does not appear, the fluorescent lamp has worn out and the LCD screen should be replaced. For replacement, consult qualified service personnel.

## Installing the TV set

- Do not install the TV set in places subject to extreme temperature, for example in direct sunlight, or near a radiator, or heating vent. If the TV set is exposed to extreme temperature, the TV set may overheat and cause deformation of the casing or cause the TV set to malfunction.
- The TV set is not disconnected from the mains when the TV set is switched off. To disconnect the TV set completely, pull the plug from the mains.
- To obtain a clear picture, do not expose the screen to direct illumination or direct sunlight. If possible, use spot lighting directed down from the ceiling.
- Do not install optional components too close to the TV set. Keep optional components at least 30 cm away from the TV set. If a VCR is installed in front of the TV set or beside the TV set, the picture may become distorted.
- Picture distortion and/or noisy sound may occur if the TV set is positioned in close proximity to any equipment emitting electromagnetic radiation.

## Handling and cleaning the screen surface/cabinet of the TV set

To avoid material degradation or screen coating degradation, observe the following precautions.

- Do not push on the screen, scratch it with a hard object, or throw anything at it. The screen may be damaged.
- Do not touch the display panel after operating the TV set continuously for a long period as the display panel becomes hot.
- We recommend that the screen surface be touched as little as possible.
- To remove dust from the screen surface/cabinet, wipe gently with a soft cloth. If dust is persistent, wipe with a soft cloth slightly moistened with a diluted mild detergent solution.
- Never use any type of abrasive pad, alkaline/acid cleaner, scouring powder, or volatile solvent, such as alcohol, benzene, thinner or insecticide. Using such materials or maintaining prolonged contact with rubber or vinyl materials may result in damage to the screen surface and cabinet material.
- The ventilation holes can accumulate dust over time. To ensure proper ventilation, we recommend removing the dust periodically (once a month) using a vacuum cleaner.

## Disposal of the TV set

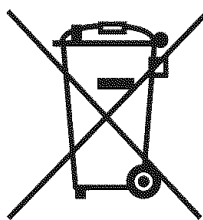

### Disposal of Old Electrical & Electronic Equipment (Applicable in the European Union and other European countries with separate collection systems)

This symbol on the product or on its packaging indicates that this product shall not be treated as household waste. Instead it shall be handed over to the applicable collection point for the recycling

of electrical and electronic equipment. By ensuring this product is disposed of correctly, you will help prevent potential negative consequences for the environment and human health, which could otherwise be caused by inappropriate waste handling of this product. The recycling of materials will help to conserve natural resources. For more detailed information about recycling of this product, please contact your local Civic Office, your household waste disposal service or the shop where you purchased the product.

# Overview of the remote

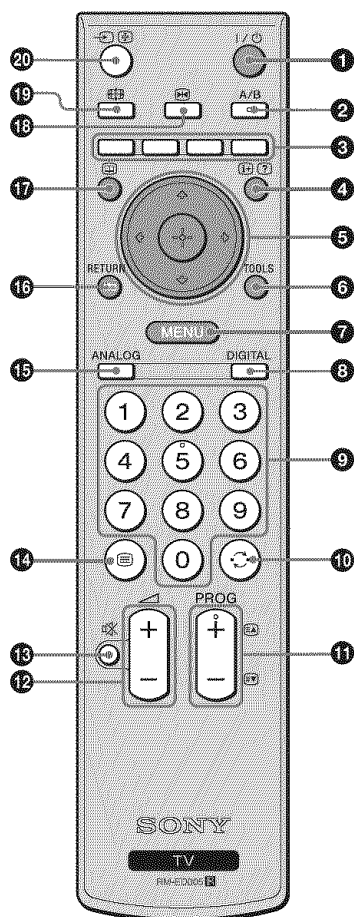

- 1 I/⏻ – TV standby**  
Switches off the TV temporarily and on from standby mode.
- 2 A/B – Dual Sound (page 24)**
- 3 Coloured buttons**
  - In digital mode (page 16, 18): Selects the options at the bottom of the Favourite and EPG digital menus.
  - In Analogue Text mode (page 14): Used for Fastext.
- 4 – Info / Text reveal**
  - In digital mode: Displays brief details of the programme currently being watched.
  - In analogue mode: Displays information such as current channel number and screen mode.
  - In Analogue Text mode (page 14): Reveals hidden information (e.g., answers to a quiz).
- 5 (page 13, 20)**
- 6 TOOLS (page 15, 19, 35)**  
Enables you to access various viewing options and change/make adjustments according to the source and screen mode.
- 7 MENU (page 20)**
- 8 DIGITAL – Digital mode (page 13)**
- 9 Number buttons**
  - In TV mode: Selects channels. For channel numbers 10 and above, enter the second digit within two seconds.
  - In Analogue Text mode: Enters the three digit page number to select the page.
- 10 – Previous channel**  
Returns to the previous channel watched (for more than five seconds).
- 11 PROG +/- (page 13)**
  - In TV mode: Selects the next (+) or previous (-) channel.
  - In Analogue Text mode: Selects the next (+) or previous (-) page.
- 12 +/- – Volume**
- 13 – Mute (page 13)**
- 14 – Text (page 14)**
- 15 ANALOG – Analogue mode (page 13)**
- 16 / RETURN**  
Returns to the previous screen of any displayed menu.
- 17 – EPG (Digital Electronic Programme Guide) (page 16)**
- 18 – Picture freeze (page 14)**  
Freezes the TV picture.
- 19 – Screen mode (page 14)**
- 20 – Input select / Text hold**
  - In TV mode (page 19): Selects the input source from equipment connected to the TV sockets.
  - In Analogue Text mode (page 14): Holds the current page.

## Tip

The A/B, PROG + and number 5 buttons have tactile dots. Use the tactile dots as references when operating the TV.

# Overview of the TV buttons and indicators

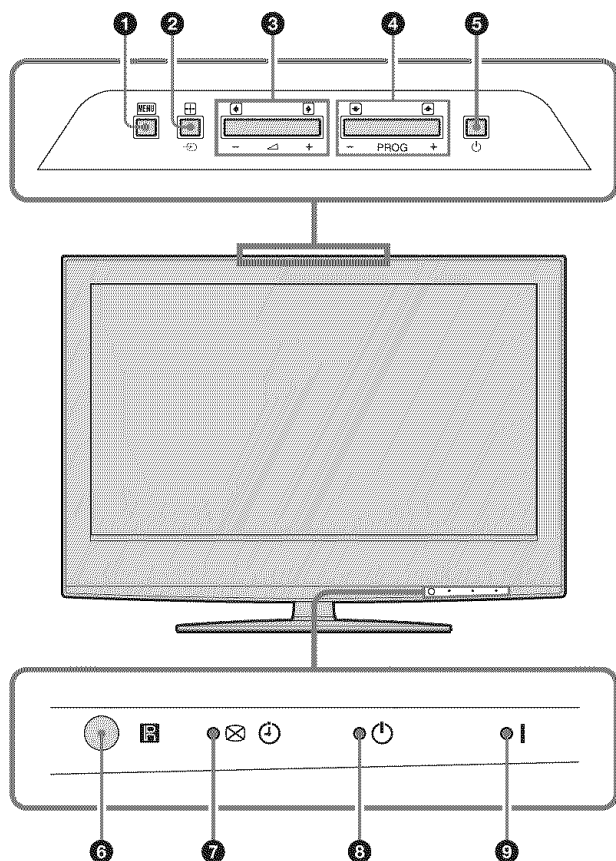

- 1 **MENU** (page 20)
- 2 **→/+/+ – Input select/OK**
  - In TV mode (page 19): Selects the input source from equipment connected to the TV sockets.
  - In TV menu: Selects the menu or option, and confirm the setting.
- 3 **∧ +/-/◀/▶**
  - Increases (+) or decreases (-) the volume.
  - In TV menu: Moves through the options left (◀) or right (▶).
- 4 **PROG +/-/⬆/⬇**
  - In TV mode: Selects the next (+) or previous (-) channel.
  - In TV menu: Moves through the options up (⬆) or down (⬇).
- 5 **⏻ – Power**  
Switches the TV on or off.
- 6 **Remote control sensor**
- 7 **⊗ ⏻ – Picture Off/Timer indicator**
  - Lights up in green when the picture is switched off (page 27).
  - Lights up in orange when the timer is set (page 26).
- 8 **⏻ – Standby indicator**  
Lights up in red when the TV is in standby mode.
- 9 **I – Power indicator**  
Lights up in green when the TV is switched on.

## Note

Make sure that the TV is completely switched off before unplugging the mains lead. Unplugging the mains lead while the TV is turned on may cause the indicator to remain lit or may cause the TV to malfunction.

# Watching TV

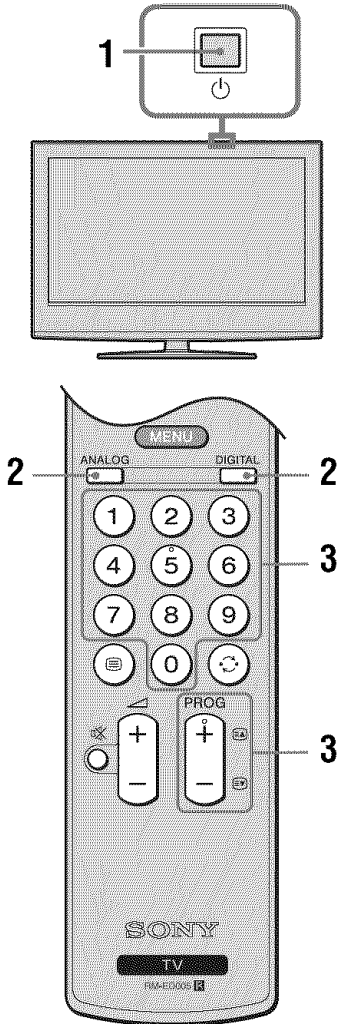

**1** Press on the TV (top side) to switch on the TV.

When the TV is in standby mode (the (standby) indicator on the TV (front) is red), press on the remote to switch on the TV.

**2** Press DIGITAL to switch to digital mode or ANALOG to switch to analogue mode.

The channels available vary depending on the mode.

**3** Press the number buttons or PROG +/- to select a TV channel.

To select channel numbers 10 and above using the number buttons, enter the second and third digits within two seconds.

To select a digital channel using the Digital Electronic Programme Guide (EPG), see page 16.

### In digital mode

An information banner appears briefly. The following icons may be indicated on the banner.

- : Interactive service is available (MHEG Digital Text)
- : Interactive service (MHEG Digital Text) is currently disabled
- : Radio service
- : Scrambled/Subscription service
- : Multiple audio languages available
- : Subtitles available
- : Subtitles available for the hearing impaired
- : Recommended minimum age for current programme (from 4 to 18 years)
- : Parental Lock
- : Current programme is being recorded

### Additional operations

To	Do this
Turn off the TV temporarily (Standby mode)	Press .
Turn on the TV from Standby mode without sound	Press . Press  +/- to set the volume level.
Turn off the TV completely	Press  on the TV (top side).
Adjust the volume	Press  + (increase)/ - (decrease).
Mute the sound	Press . Press again to restore.
Access the Programme index table (in analogue mode only)	Press . To select an analogue channel, press , then press . To access the Input signal index table, see page 19.

## To access Digital Text





Many broadcasters provide a Digital Text service. Digital Text offers graphically rich contents, compared to Analogue Text.

Select a digital channel which provides Digital Text, then press .

When a broadcaster provides a dedicated Digital Text channel, select this channel to access Digital Text.

To navigate through Digital Text, follow the instructions on the screen.



To exit Digital Text, press RETURN.

To move around, press ///.

To select items, press  and the number buttons.



To access shortcuts, press the coloured buttons.



## To access Analogue Text

In analogue mode, press . Each time you press , the display changes cyclically as follows:

Text → Text over the TV picture (mix mode) → No Text (exit the Text service)

To select a page, press the number buttons or PROG +/-.

To hold a page, press /.







To reveal hidden information, press /.

### Tips

- Ensure that the TV is receiving a good signal, or some text errors may occur.
- Most TV channels broadcast a Text service. For information on the use of the service, select the index page.
- When four coloured items appear at the bottom of the Text page, Fastext is available. Fastext allows you to access pages quickly and easily. Press the corresponding coloured button to access the page.

## Picture Freeze

Freezes the TV picture (e.g. to make a note of a telephone number or recipe).

- 1 Press  on the remote control.
- 2 Press /// to adjust the position of the window.
- 3 Press  to remove the window.
- 4 Press  again to return to normal TV mode.

## To change the screen mode manually to suit the broadcast

Press  repeatedly to select Smart, 4:3, Wide, Zoom, or 14:9.

### Smart\*

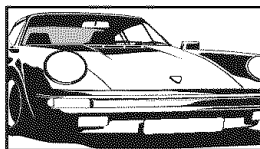

Displays conventional 4:3 broadcasts with an imitation wide screen effect. The 4:3 picture is stretched to fill the screen.

### 4:3

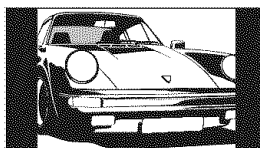

Displays conventional 4:3 broadcasts (e.g., non-wide screen TV) in the correct proportions.

### Wide

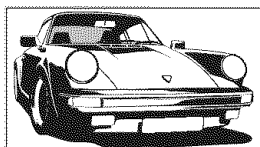

Displays wide screen (16:9) broadcasts in the correct proportions.

### Zoom\*

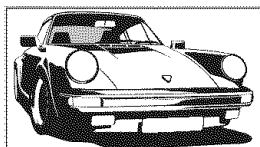

Displays cinemascope (letter box format) broadcasts in the correct proportions.

### 14:9\*

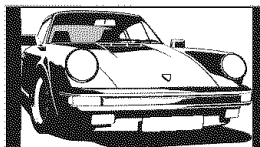

Displays 14:9 broadcasts in the correct proportions. As a result, black border areas are visible on the screen.

\* Parts of the top and bottom of the picture may be cut off.

**Tips**

- Alternatively, you can set “Auto Format” to “On”. The TV will automatically select the best mode to suit the broadcast (page 25).
- You can adjust the position of the picture when selecting 14:9 or Zoom. Press  $\uparrow/\downarrow$  to move up or down (e.g., to read subtitles).
- Some characters and/or letters at the top and the bottom of the picture may not be visible in Smart mode. In such a case, you can select “Vertical Size” using the “Screen” menu and adjust vertical size to make it visible.

**Using the Tools menu**

Press TOOLS to display the following options when viewing the TV programme.

<b>Options</b>	<b>Description</b>
Power Saving	See page 27.
Subtitle Setting (in digital mode only)	See page 32.
Digital Favourites (in digital mode only)	See page 18.
Picture Mode	See page 21.
Sound Mode	See page 23.
Auto Clock Set (in analogue mode only)	Allows you to switch to digital mode and obtain the time.
Sleep Timer	See page 26.
$\updownarrow$ Volume	See page 24.

# Checking the Digital Electronic Programme Guide (EPG) DV3\*

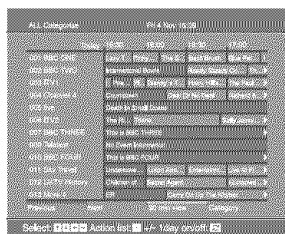

Digital Electronic Programme Guide (EPG)

\* Please note that this function may not be available in some countries.

- 1 In digital mode, press to display the Digital Electronic Programme Guide (EPG).
- 2 Perform the desired operation, as shown in the following table.

#### Note

Programme information will only be displayed if the TV station is transmitting it.

To	Do this
Turn off the EPG	Press .
Move through the EPG	Press , , , .
Watch a current programme	Press  while the current programme is selected.
Sort the programme information by category – Category list	<ol style="list-style-type: none"> <li>1 Press the blue button.</li> <li>2 Press , , ,  to select a category. The category name is displayed on the side. The categories available include: “Favourite”: Contains all the channels that have been stored in the Favourite list (page 18). “All Categories”: Contains all available channels. “News”: Contains all news channels.</li> <li>3 Press .</li> </ol> <p>The Digital Electronic Programme Guide (EPG) now only displays the current programmes from the category selected.</p>
Set a programme to be recorded – Timer REC	<ol style="list-style-type: none"> <li>1 Press , , ,  to select the future programme you want to record.</li> <li>2 Press .</li> <li>3 Press ,  to select “Timer REC”.</li> <li>4 Press  to set the TV and your VCR timers. A  symbol appears by that programme’s information. The  indicator on the TV (front) lights up.</li> </ol>

#### Notes

- You can set VCR timer recording on the TV only for Smartlink compatible VCRs. If your VCR is not Smartlink compatible, a message will be displayed to remind you to set your VCR timer.
- Once a recording has begun, you can switch the TV to standby mode, but do not switch off the TV completely or the recording may be cancelled.
- If an age restriction for programmes has been selected, a message asking for pin code will appear on the screen. For more details refer to “Parental Lock” on page 32.



To	Do this
Set a programme to be displayed automatically on the screen when it starts – Reminder	<ol style="list-style-type: none"> <li>1 Press /↓/←/→ to select the future programme you want to display.</li> <li>2 Press .</li> <li>3 Press /↓ to select “Reminder”.</li> <li>4 Press  to automatically display the selected programme when the programme starts. A  symbol appears by that programme’s information.</li> </ol> <p><b>Note</b> If you switch the TV to standby mode, it will automatically turn itself on when the programme is about to start.</p>
Set the time and date of a programme you want to record – Manual timer REC	<ol style="list-style-type: none"> <li>1 Press .</li> <li>2 Press /↓ to select “Manual timer REC”, then press .</li> <li>3 Press /↓ to select the date, then press .</li> <li>4 Set the start and stop time in the same way as in step 3.</li> <li>5 Press /↓ to select the programme, then press  to set the TV and your VCR timers. A  symbol appears by that programme’s information. The  indicator on the TV (front) lights up.</li> </ol> <p><b>Notes</b></p> <ul style="list-style-type: none"> <li>• You can set VCR timer recording on the TV only for Smartlink compatible VCRs. If your VCR is not Smartlink compatible, a message will be displayed to remind you to set your VCR timer.</li> <li>• Once a recording has begun, you can switch the TV to standby mode, but do not switch off the TV completely or the recording may be cancelled.</li> <li>• If an age restriction for programmes has been selected, a message asking for pin code will appear on the screen. For more details refer to “Parental Lock” on page 32.</li> </ul>
Cancel a recording/reminder – Timer list	<ol style="list-style-type: none"> <li>1 Press .</li> <li>2 Press /↓ to select “Timer list”.</li> <li>3 Press /↓ to select the programme you want to cancel, then press .</li> </ol> <p>A display appears to confirm that you want to cancel the programme.</p> <ol style="list-style-type: none"> <li>4 Press  to select “Yes”, then press  to confirm.</li> </ol>

**Tip**

You can also display the Digital Electronic Programme Guide (EPG) by selecting “Digital EPG” in the “MENU” (page 20).

# Using the Favourite list DV3\*



Favourite list

The Favourite feature allows you to select programs from a list of up to 8 channels you specify. To display the Favourite list, see “Navigating through menus” (page 20).

\* Please note that this function may not be available in some countries.

To	Do this
Create your Favourite list for the first time	<p>A message appears asking if you want to add channels to the Favourite list when you select “Digital Favourites” in the “MENU” for the first time.</p> <ol style="list-style-type: none"> <li>1 Press <b>+</b> to select “Yes”.</li> <li>2 Press <b>↑/↓</b> to select the channel you want to add. If you know the channel number, you can use the number buttons to directly select a channel.</li> <li>3 Press <b>+</b>. Channels that are stored in the Favourite list are indicated by a <b>♥</b> symbol.</li> </ol>
Turn off the Favourite list	Press <b>RETURN</b> .
See brief details on current programmes	Press <b>+</b> while selecting a channel. Press again to cancel.
Watch a channel	Press <b>+</b> while selecting a channel.
Add or remove channels in the Favourite list	<ol style="list-style-type: none"> <li>1 Press the blue button. Channels that are stored in the Favourite list are indicated by a <b>♥</b> symbol.</li> <li>2 Press <b>↑/↓</b> to select the channel you want to add or remove. If you know the channel number, you can use the number buttons to directly select a channel.</li> <li>3 Press <b>+</b>.</li> <li>4 Press the blue button to return to the Favourite list.</li> </ol>
Remove all channels from the Favourite list	<ol style="list-style-type: none"> <li>1 Press the blue button.</li> <li>2 Press the yellow button. A display appears to confirm that you want to delete all channels from the Favourite list.</li> <li>3 Press <b>↔</b> to select “Yes”, then press <b>+</b> to confirm.</li> </ol>

# Viewing pictures from connected equipment

Switch on the connected equipment, then perform one of the following operation.

## For equipment connected to the scart sockets using a fully-wired 21-pin scart lead

Start playback on the connected equipment.

The picture from the connected equipment appears on the screen.

## For an auto-tuned VCR (page 6)

In analogue mode, press PROG +/-, or the number buttons, to select the video channel.

## For other connected equipment

Press repeatedly until the correct input symbol (see below) appears on the screen.

AV1 / AV1, AV2 / AV2:

Audio/video or RGB input signal through the scart socket 1 or 2. appears only if an RGB source has been connected.

AV3:

Component input signal through the Y, Pb/Cb, Pr/Cr sockets 3, and audio input signal through the L, R sockets 3.

AV4:

Digital audio/video signal is input through the HDMI IN 4 socket. Audio input signal is analogue only if the equipment has been connected using the DVI and audio out socket.

AV5 / AV5:

Video input signal through the video socket 5, and audio input signal through the L (MONO), R audio sockets 5. appears only if the equipment is connected to the S video socket 5 instead of the video socket 5, and S video input signal is input through the S video socket 5.

## Additional operations

To	Do this
Return to the normal TV operation	Press DIGITAL or ANALOG.
Access the Input signal index table	Press  to access the Input signal index table. (Then, only in analogue mode, press .) To select an input source, press /, then press .

## Using the Tools menu

Press TOOLS to display the following options when viewing pictures from connected equipment other than PC.

Options	Description
Power Saving	See page 27.
Picture Mode	See page 21.
Sound Mode	See page 23.
Auto Clock Set (in analogue mode only)	Allows you to switch to digital mode and obtain the time.
Sleep Timer	See page 26.
Volume	See page 24.

## Navigating through menus





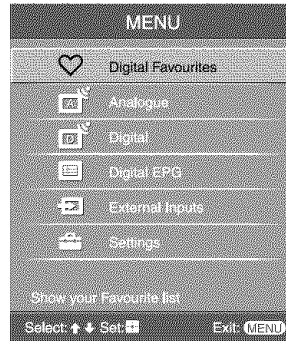
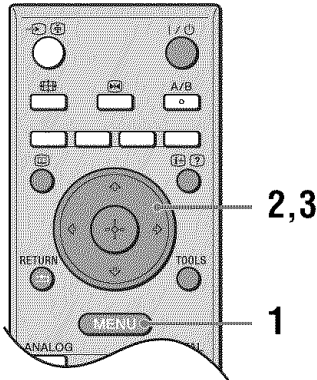

“MENU” allows you to enjoy various convenient features of this TV. You can easily select channels or external inputs with the remote. Also, settings for your TV can be changed easily using “MENU”.

**1** Press MENU to display the menu.



**2** Press  $\uparrow/\downarrow$  to select an option.

**3** Press  $\oplus$  to confirm a selected option.  
To exit the menu, press MENU.

Menu	Description
 Digital Favourites (only in areas with digital broadcasting)	Launches the Favourite list. For details about settings, see page 18.
 Programme List (only in areas with analogue broadcasting)	Allows you to select TV programs from a list of channel labels. <ul style="list-style-type: none"> <li>To watch the desired channel, select the channel, then press <math>\oplus</math>.</li> <li>To assign a label to a program, see page 29.</li> </ul>
 Analogue (only in areas with digital broadcasting)	Returns to the last viewed analogue channel.
 Digital (only in areas with digital broadcasting)	Returns to the last viewed digital channel.
 Digital EPG (only in areas with digital broadcasting)	Launches the Digital Electronic Programme Guide (EPG). For details about settings, see page 16.
 External Inputs	Selects equipment connected to your TV. <ul style="list-style-type: none"> <li>To watch the desired external input, select the input source, then press <math>\oplus</math>.</li> <li>To assign a label to an external input, see page 26.</li> </ul>
 Settings	Opens the Settings menu screen where most of advanced settings and adjustments are performed. Select a menu icon, select an option and make the desired change or adjustment using $\uparrow/\downarrow/\leftarrow/\rightarrow$ . For details about settings, see page 21 to 32.

# Picture menu

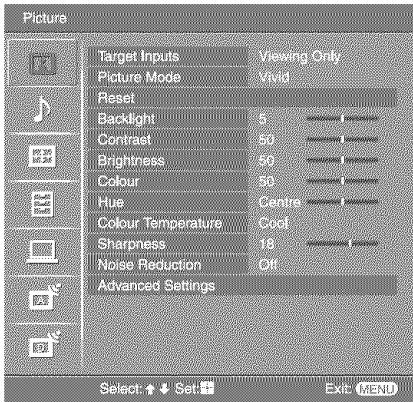

You can select the options listed below on the Picture menu. To select options in “Settings”, see “Navigating through menus” (page 20).

## Target Inputs

Selects whether to apply settings made in the Picture menu to all inputs, or only to the input currently being watched.

“All”: Applies settings to all inputs.

“Viewing Only”: Applies settings only to the current input.

## Picture Mode

Selects the picture mode.

“Vivid”: For enhanced picture contrast and sharpness.

“Standard”: For standard picture. Recommended for home entertainment.

“Custom”: Allows you to store your preferred settings.

## Reset

Resets all picture settings except “Picture Mode” to the factory settings.

## Backlight

Adjusts the brightness of the backlight.

## Contrast

Increases or decreases picture contrast.

## Brightness

Brightens or darkens the picture.

## Colour

Increases or decreases colour intensity.

## Hue

Increases or decreases the green tones.

### Tip

“Hue” can only be adjusted for an NTSC colour signal (e.g., U.S.A. video tapes).

## Colour Temperature

Adjusts the whiteness of the picture.

“Cool”: Gives the white colours a blue tint.

“Neutral”: Gives the white colours a neutral tint.

“Warm1”/“Warm2”: Gives the white colours a red tint. “Warm2” gives a redder tint than “Warm1”.

### Tip

“Warm1” and “Warm2” can only be selected when you set “Picture Mode” to “Custom”.

*Continued*

---

## Sharpness

Sharpens or softens the picture.

---

## Noise Reduction

Reduces the picture noise (snowy picture) in a weak broadcast signal.

“Auto”: Automatically reduces the picture noise.

“High”/“Medium”/“Low”: Modifies the effect of the noise reduction.

“Off”: Turns off the Noise Reduction feature.

---

## Advanced Settings

Customizes the Picture function in more detail. When you set “Picture Mode” to “Custom”, you can set/change these settings.

“Reset”: Resets all the advanced video settings to the factory settings.

“Black Corrector”: Enhances black areas of the picture for stronger contrast.

“Contrast Enhancer”: Automatically adjusts “Contrast” to the most suitable settings judging from the brightness of the screen. This setting is especially effective for dark images, increasing vibrancy in the picture.

“Gamma”: Adjusts the balance between bright and dark areas of the picture.

“Clear White”: Emphasizes white colours.

“Live Colour”: Makes colours more vivid.

“MPEG Noise Reduction”: Reduces the picture noise in MPEG-compressed video (in digital mode only).

---

# Sound menu

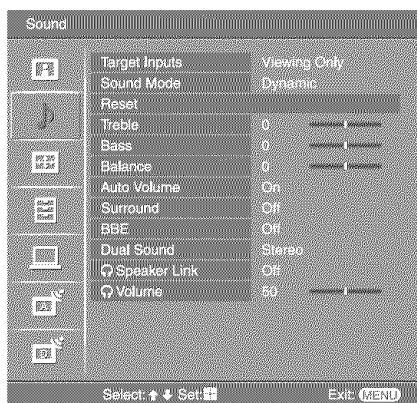

You can select the options listed below on the Sound menu. To select options in “Settings”, see “Navigating through menus” (page 20).

## Target Inputs

Selects whether to apply settings made in the Sound menu to all inputs, or only to the input currently being watched.

“All”: Applies settings to all inputs.

“Viewing Only”: Applies settings only to the current input.

## Sound Mode

Selects the sound mode.

“Dynamic”: Enhances treble and bass.

“Standard”: For standard sound. Recommended for home entertainment.

“Custom”: Flat response. Also allows you to store your preferred settings.

## Reset

Resets the sound settings except “Sound Mode”, “Dual Sound”, “Speaker Link” and “Volume” to the factory settings.

## Treble

Adjusts higher-pitched sounds.

## Bass

Adjusts lower-pitched sounds.

## Balance

Emphasizes left or right speaker balance.

## Auto Volume

Keeps a constant volume level even when volume level gaps occur (e.g., adverts tend to be louder than programmes).

## Surround

Selects the surround mode.

“TruSurround XT”: For surround sound (for stereo programmes only).

“Simulated Stereo”: Adds a surround-like effect to mono programs.

“Off”: For normal stereo or mono reception.

## BBE

Gives sound more impact by compensating for phase effects in speakers using the “BBE High Definition Sound System”.

*Continued*

---

## Dual Sound

Selects the sound from the speaker for a stereo or bilingual broadcast.

“Stereo”, “Mono”: For a stereo broadcast.

“A”/“B”/“Mono”: For a bilingual broadcast, select “A” for sound channel 1, “B” for sound channel 2, or “Mono” for a mono channel, if available.

### Tip

If you select other equipment connected to the TV, set “Dual Sound” to “Stereo”, “A” or “B”.

---

## Speaker Link (headphone speaker link)

Switches on/off the TV’s internal speakers when headphones are connected.

---

## Volume (headphone volume)

Adjusts the volume of the headphones.

---

### Tip

“Treble”, “Bass”, “Balance”, “Auto Volume”, “Surround” and “BBE” cannot be used for headphones and audio output sockets.



# Screen menu

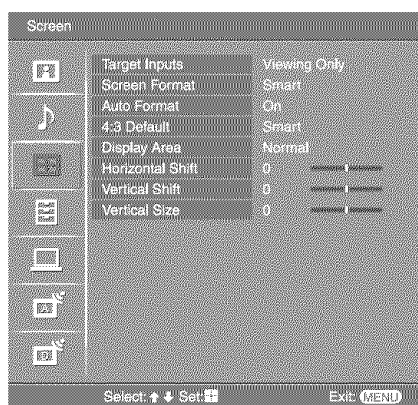

You can select the options listed below on the Screen menu. To select options in “Settings”, see “Navigating through menus” (page 20).

## Target Inputs

Selects whether to apply settings made in the Screen menu to all inputs, or only to the input currently being watched.

“All”: Applies settings to all inputs.

“Viewing Only”: Applies settings only to the current input.

## Screen Format

For details about the screen format, see “To change the screen mode manually to suit the broadcast” (page 14).

## Auto Format

Automatically changes the screen format according to the broadcast signal. To keep your setting, select “Off”.

### Tips

- Even if you have selected “On” or “Off” in “Auto Format”, you can always modify the format of the screen by pressing  repeatedly.
- “Auto Format” is available for PAL and SECAM signals only.

## 4:3 Default

Selects the default screen mode for use with 4:3 broadcasts.

“Smart”: Displays conventional 4:3 broadcasts with an imitation wide screen effect.

“4:3”: Displays conventional 4:3 broadcasts in the correct proportions.

“Off”: Keeps the current “Screen Format” setting when the channel or input is changed.

### Tip

This option is available only if “Auto Format” is set to “On”.

## Display Area

Adjusts the screen area displaying the picture.

“Normal”: Displays the picture in the original size.

“-1”/“-2””: Enlarges the picture to hide the edge of the picture.

## Horizontal Shift

Adjusts the horizontal position of the picture for each screen format.

## Vertical Shift

Adjusts the vertical position of the picture when the screen format is set to Zoom or 14:9.

## Vertical Size

Adjusts the vertical size of the picture when the screen format is set to Smart, Zoom or 14:9.

# Set-up menu

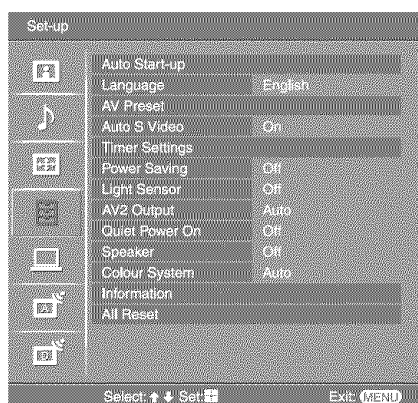

You can select the options listed below on the Set-up menu. To select options in “Settings”, see “Navigating through menus” (page 20).

## Auto Start-up

Starts the “first time operation menu” to select the language and country/region, and tune in all available digital and analogue channels. Usually, you do not need to do this operation because the language and country/region will have been selected and channels already tuned when the TV was first installed (page 5, 6). However, this option allows you to repeat the process (e.g., to retune the TV after moving house, or to search for new channels that have been launched by broadcasters).

## Language

Selects the language in which the menus are displayed.

## AV Preset

Assigns a name to any equipment connected to the side and rear sockets. The name will be displayed briefly on the screen when the equipment is selected. You can skip an input source that is not connected to any equipment.

- 1 Press  $\uparrow/\downarrow$  to select the desired input source, then press  $\oplus$ .
- 2 Press  $\uparrow/\downarrow$  to select the desired option below, then press  $\oplus$ .

Equipment labels: Uses one of the preset labels to assign a name to connected equipment.

“Edit”: Creates your own label. Follow steps 2 to 4 of “Programme Labels” (page 29).

“Skip”: Skips an input source that is not connected to any equipment when you press  $\rightarrow$  to select the input source.

## Auto S Video

Selects the input signal from S video sockets S- $\rightarrow$ 5 when S- $\rightarrow$ 5/ $\rightarrow$ 5 sockets are both connected.

## Timer Settings

Sets the timer to turn on/off the TV.

### Sleep Timer

Sets a period of time after which the TV automatically switches itself into standby mode.

When the Sleep Timer is activated, the  $\text{⌚}$  (Timer) indicator on the TV (front) lights up in orange.

### Tips

- If you switch off the TV and switch it on again, “Sleep Timer” is reset to “Off”.
- “TV will soon turn off by sleep timer.” appears on the screen one minute before the TV switches to standby mode.

---

**On Timer**

Sets the timer to turn on the TV.

“Day”: Selects the day on which you want to activate the On Timer.

“Time”: Sets the time to turn on the TV.

“Duration”: Selects the time period after which the TV automatically switches to standby mode again.

“Volume Set-up”: Sets the volume for when the timer turns on the TV.

**Clock Set**

Allows you to adjust the clock manually. When the TV is receiving digital channels, the clock cannot be adjusted manually since it is set to the time code of the broadcasted signal.

---

**Power Saving**

Selects the power saving mode to reduce the power consumption of the TV.

When “Picture Off” is selected, the picture is switched off and the  (Picture Off) indicator on the TV (front) lights up in green. The sound remains unchanged.



---

**Light Sensor**

Automatically optimizes the picture settings according to the ambient light in the room.

---

**AV2 Output**

Sets a signal to be output through the socket labelled  2 on the rear of the TV. If you connect a VCR or other recording equipment to the  2 socket, you can then record from the equipment connected to other sockets of the TV.

“TV”: Outputs a broadcast.

“AV1”: Outputs signals from equipment connected to the  1 socket.

“AV5”: Outputs signals from equipment connected to the  5 socket.

“Auto”: Outputs whatever is being viewed on the screen (except signals from the  3 and HDMI IN 4 sockets).

---

**Quiet Power On**

Sets the volume control at a low level when the TV is first turned on, gradually increasing the sound to a preset level.

---

**Speaker**

Switches on/off the TV’s internal speakers.

“On”: The TV speakers are turned on in order to listen to the TV’s sound through TV’s speakers.

“Off”: The TV speakers are turned off in order to listen to the TV’s sound only through your external audio equipment connected to the audio output sockets.

---

**Colour System**

Selects the colour system (“Auto”, “PAL”, “SECAM”, “NTSC3.58”, “NTSC4.43”, or “PAL60”) according to the input signal from the input source.

---

**Information**

Displays your TV’s system information.

---

**All Reset**

Resets all the Set-up settings to the factory settings and then launches the Auto Start-up screen.

---

# PC Settings menu

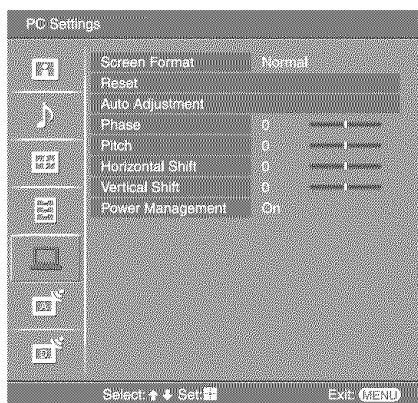

You can select the options listed below on the PC Settings menu. To select options in “Settings”, see “Navigating through menus” (page 20).

---

## Screen Format

Selects a screen mode for displaying input from your PC.

“Normal”: Displays the picture in its original size.

“Full1”: Enlarges the picture to fill the display area, keeping its original horizontal-to-vertical aspect ratio.

“Full2”: Enlarges the picture to fill the display area.

---

## Reset

Resets the PC settings except “Screen Format” and “Power Management” to the factory settings.

---

## Auto Adjustment

Automatically adjusts the display position and phase of the picture when the TV receives an input signal from the connected PC.

**Tip**

Auto Adjustment may not work well with certain input signals. In such cases, manually adjust “Phase”, “Pitch”, “Horizontal Shift” and “Vertical Shift”.

---

## Phase

Adjusts the phase when the screen flickers.

---

## Pitch

Adjusts the pitch when the picture has unwanted vertical stripes.

---

## Horizontal Shift

Adjusts the horizontal position of the picture for each screen format.

---

## Vertical Shift

Adjusts the vertical position of the picture for each screen format.

---

## Power Management

Switches the TV to standby mode if no signal is received for 30 seconds.

---

# Analogue Set-up menu (Analogue mode only)

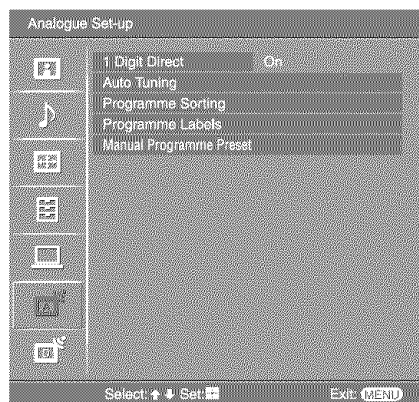

You can change/set the analogue settings using the Analogue Set-up menu. To select options in “Settings”, see “Navigating through menus” (page 20).

## 1 Digit Direct

When “1 Digit Direct” is set to “On”, you can select an analogue channel using one preset number button (0 - 9) on the remote.

### Note

When “1 Digit Direct” is set to “On”, you cannot select channel numbers 10 and above entering two digits using the remote.

## Auto Tuning

Tunes in all the available analogue channels.

Usually you do not need to do this operation because the channels are already tuned when the TV was first installed (page 5, 6). However, this option allows you to repeat the process (e.g., to retune the TV after moving house, or to search for new channels that have been launched by broadcasters).

## Programme Sorting

Changes the order in which the analogue channels are stored on the TV.

- 1 Press  $\uparrow/\downarrow$  to select the channel you want to move to a new position, then press  $\oplus$ .
- 2 Press  $\uparrow/\downarrow$  to select the new position for your channel, then press  $\oplus$ .

## Programme Labels

Assigns a channel name of your choice up to five letters or numbers. The name will be displayed briefly on the screen when the channel is selected. (Names for channels are usually taken automatically from Analogue Text (if available).)

- 1 Press  $\uparrow/\downarrow$  to select the channel you want to name, then press  $\oplus$ .
- 2 Press  $\uparrow/\downarrow$  to select the desired letter or number (“\_” for a blank space), then press  $\rightarrow$ .

### If you input a wrong character

Press  $\leftarrow/\rightarrow$  to select the wrong character. Then, press  $\uparrow/\downarrow$  to select the correct character.

### To delete all the characters

Select “Reset”, then press  $\oplus$ .

- 3 Repeat the procedure in step 2 until the name is complete.
- 4 Select “OK”, then press  $\oplus$ .

*Continued*

---

## Manual Programme Preset

Before selecting “Label”/“AFT”/“Audio Filter”/“Skip”, press PROG +/- to select the programme number with the channel. You cannot select a programme number that is set to skip (see below).

### Programme/System/Channel

Presets programme channels manually.

- 1 Press  $\uparrow/\downarrow$  to select “Programme”, then press  $\oplus$ .
- 2 Press  $\uparrow/\downarrow$  to select the programme number you want to manually tune (if tuning a VCR, select channel 00), then press RETURN.
- 3 Press  $\uparrow/\downarrow$  to select “System”, then press  $\oplus$ .
- 4 Press  $\uparrow/\downarrow$  to select one of the following TV broadcast systems, then press  $\leftarrow$ .

B/G: For western European countries/regions

D/K: For eastern European countries/regions

L: For France

I: For the United Kingdom

- 5 Press  $\uparrow/\downarrow$  to select “Channel”, then press  $\oplus$ .
- 6 Press  $\uparrow/\downarrow$  to select “S” (for cable channels) or “C” (for terrestrial channels), then press  $\rightarrow$ .
- 7 Tune the channels as follows:

#### If you do not know the channel number (frequency)

Press  $\uparrow/\downarrow$  to search for the next available channel. When a channel has been found, the search will stop. To continue searching, press  $\uparrow/\downarrow$ .

#### If you know the channel number (frequency)

Press the number buttons to enter the channel number of the broadcast you want or your VCR channel number.

- 8 Press  $\oplus$  to jump to “Confirm”, then press  $\oplus$ .
- 9 Press  $\downarrow$  to select “OK”, then press  $\oplus$ .

Repeat the procedure above to preset other channels manually.

### Label

Assigns a name of your choice, up to five letters or numbers, to the selected channel. This name will be displayed briefly on the screen when the channel is selected. To input characters, follow steps 2 to 4 of “Programme Labels” (page 29).

### AFT

Allows you to fine-tune the selected programme number manually if you feel that a slight tuning adjustment will improve the picture quality.

You can adjust the fine tuning over a range of -15 to +15. When “On” is selected, the fine tuning is performed automatically.

### Audio Filter

Improves the sound for individual channels in the case of distortion in mono broadcasts. Sometimes a non-standard broadcast signal can cause sound distortion or intermittent sound muting when watching mono programmes.

If you do not experience any sound distortion, we recommend that you leave this option set to the factory setting “Off”.

### Notes

- You cannot receive stereo or dual sound when “Low” or “High” is selected.
- “Audio Filter” is not available when “System” is set to “L”.

### Skip

Skips unused analogue channels when you press PROG +/- to select channels. (You can still select a skipped channel using the number buttons.)

### Confirm

Saves changes made to the “Manual Programme Preset” settings.

---

# Digital Set-up menu DV3

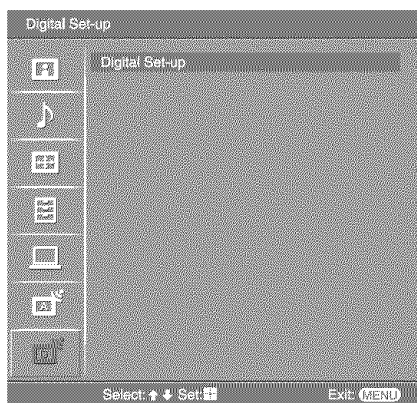

You can change/set the digital settings using the Digital Set-up menu. Select “Digital Set-up” and press  $\oplus$  to display the following menus. To select options in “Settings”, see “Navigating through menus” (page 20).

## Digital Tuning

Displays the “Digital Tuning” menu.

### Digital Auto Tuning

Tunes in all the available digital channels.

Usually you do not need to do this operation because the channels are already tuned when the TV was first installed (page 6). However, this option allows you to repeat the process (e.g., to retune the TV after moving house, or to search for new channels that have been launched by broadcasters).

### Programme List Edit

Removes any unwanted digital channels stored on the TV, and changes the order of the digital channels stored on the TV.

- 1 Press  $\uparrow/\downarrow$  to select the channel you want to remove or move to a new position.

#### If you know the programme number (frequency)

Press the number buttons to enter the three-digit programme number of the broadcast you want.

- 2 Remove or change the order of the digital channels as follows:

#### To remove the digital channel

Press  $\oplus$ . A message that confirms whether the selected digital channel is to be deleted appears. Press  $\leftarrow$  to select “Yes”, then press  $\oplus$ .

#### To change the order of the digital channels

Press  $\rightleftarrows$ , then press  $\uparrow/\downarrow$  to select the new position for the channel and press  $\leftarrow$ . Repeat the procedure in steps 1 and 2 to move other channels if required.

- 3 Press RETURN.

### Digital Manual Tuning

Tunes the digital channels manually.

- 1 Press the number button to select the channel number you want to manually tune, then press  $\uparrow/\downarrow$  to tune the channel.
- 2 When the available channels are found, press  $\uparrow/\downarrow$  to select the channel you want to store, then press  $\oplus$ .
- 3 Press  $\uparrow/\downarrow$  to select the programme number where you want to store the new channel, then press  $\oplus$ .

Repeat the procedure above to tune other channels manually.

Continued

---

## Digital Set-up

Displays the “Digital Set-up” menu.

### Subtitle Setting\*

Displays digital subtitles on the screen.

When “For Hard Of Hearing” is selected, some visual aids may also be displayed with the subtitles (if TV channels broadcast such information).

### Subtitle Language\*

Selects which language subtitles are displayed in.

### Audio Language\*

Selects the language used for a programme. Some digital channels may broadcast several audio languages for a programme.

### Audio Type\*

Increases the sound level when “For Hard Of Hearing” is selected.

### Parental Lock\*

Sets an age restriction for programmes. Any programme that exceeds the age restriction can only be watched after a PIN Code is entered correctly.

- 1 Press the number buttons to enter your existing PIN code.  
If you have not previously set a PIN, a PIN code entry screen appears. Follow the instruction of “PIN Code” below.
- 2 Press  $\uparrow/\downarrow$  to select the age restriction or “None” (for unrestricted watching), then press  $\oplus$ .
- 3 Press RETURN.

### PIN Code\*

Sets a PIN code for the first time, or allows you to change your PIN code.

- 1 Enter a PIN as follows:  
**If you have previously set a PIN**  
Press the number buttons to enter your existing PIN.  
**If you have not set a PIN**  
Press the number buttons to enter the factory setting PIN of 9999.
- 2 Press the number buttons to enter the new PIN code.  
A message appears to inform you that the new PIN has been accepted.
- 3 Press RETURN.

### Tip

PIN code 9999 is always accepted.

### Technical Set-up

Displays the Technical Set-up menu.

“Auto Service Update”: Enables the TV to detect and store new digital services as they become available.

“Software Download”: Enables the TV to automatically receive software updates, free through your existing aerial (when issued). Sony recommends that this option is set to “On” at all times. If you do not want your software to be updated, set this option to “Off”.

“System Information”: Displays the current software version and the signal level.

“Time Zone”: Allows you to manually select the time zone you are in, if it is not the same as the default time zone setting for your country.

### CA Module Set-up

Allows you to access a Pay Per View service once you obtain a Conditional Access Module (CAM) and a view card. See page 33 for the location of the  (PCMCIA) socket.

---

\* Please note that this function may not be available in some countries.



# Connecting optional equipment

You can connect a wide range of optional equipment to your TV. Connecting cables are not supplied.

## Connecting to the TV (side)

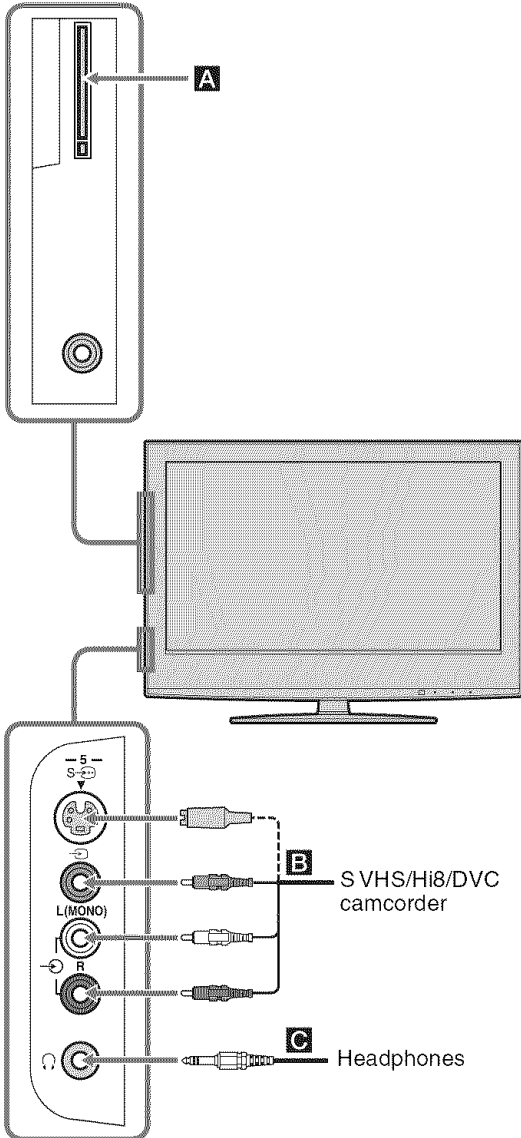

To connect	Do this
Conditional Access Module (CAM) <b>A</b>	To use Pay Per View services. For details, refer to the instruction manual supplied with your CAM. To use the CAM, remove the rubber cover from the CAM slot. Switch off the TV when inserting your CAM into the CAM slot. When you do not use the CAM, we recommend that you replace the cover on the CAM slot. <b>Note</b> CAM is not supported in all countries. Please check with your authorized dealer.
S VHS/Hi8/DVC camcorder <b>B</b>	Connect to the S video socket S-5 or the video socket 5, and the audio sockets 5. To avoid picture noise, do not connect the camcorder to the video socket 5 and the S video socket S-5 at the same time. If you connect mono equipment, connect to the L socket 5.
Headphones <b>C</b>	Connect to the 5 socket to listen to sound from the TV on headphones.

Continued

## Connecting to the TV (rear)

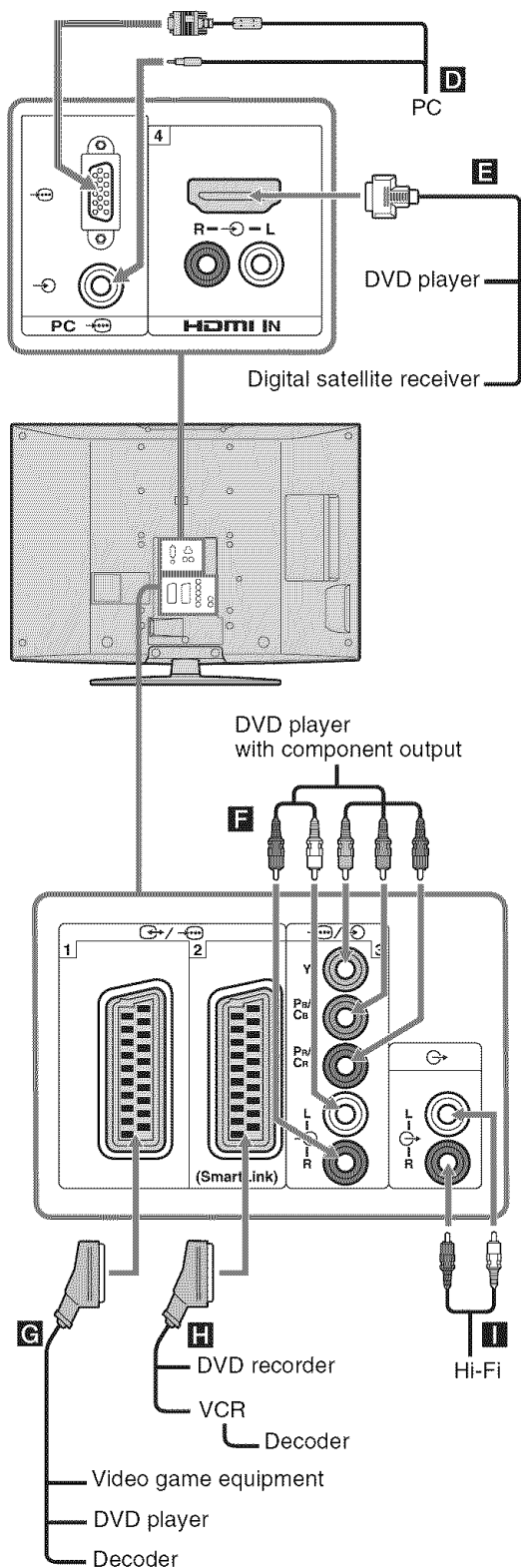

### To connect

### Do this

#### PC **D**

Connect to the PC sockets. It is recommended to use a PC cable with ferrites.

#### Digital satellite receiver or DVD player **E**

Connect to the HDMI IN 4 socket if the equipment has a HDMI socket. The digital video and audio signals are input from the equipment. If the equipment has a DVI socket, connect the DVI socket to the HDMI IN 4 socket through a DVI - HDMI adaptor interface (not supplied), and connect the equipment's audio out sockets to the audio in HDMI IN 4 sockets.

#### Note

The HDMI sockets only support the following video inputs: 480i, 480p, 576i, 576p, 720p and 1080i. To connect a PC, please use the PC input socket.

#### DVD player with component output **F**

Connect to the component sockets and the audio sockets /1-3.

#### Video game equipment, DVD player or decoder **G**

Connect to the scart socket /1. When you connect the decoder, the scrambled signal from the TV tuner is output to the decoder, then the unscrambled signal is output from the decoder.

#### DVD recorder or VCR that supports SmartLink **H**

Connect to the scart socket /2. SmartLink is a direct link between the TV and a VCR/DVD recorder.

#### Hi-Fi audio equipment **I**

Connect to the audio output sockets to listen to the sound from the TV on Hi-Fi audio equipment.

## Using the Tools menu in PC input mode

Press TOOLS to display the following options when viewing pictures input from the connected PC.

Options	Description
Power Saving	See page 27.
Picture Mode	See page 21.
Sound Mode	See page 23.
Auto Adjustment	See page 28.
Horizontal Shift	See page 28.
Vertical Shift	See page 28.
Auto Clock Set (in analogue mode only)	Allows you to switch to digital mode and obtain the time.
 Volume	See page 24.

# Specifications

### Display Unit

Power Requirements:

220–240 V AC, 50 Hz

Screen Size:

KDL-46S2000/KDL-46S2010:

46 inches (Approx. 116.9 cm measured diagonally)

KDL-40S2000/KDL-40S2010:

40 inches (Approx. 101.6 cm measured diagonally)

KDL-32S2000/KDL-32S2010/KDL-32S2020:

32 inches (Approx. 80.1 cm measured diagonally)

KDL-26S2000/KDL-26S2010/KDL-26S2020:

26 inches (Approx. 66.1 cm measured diagonally)

Display Resolution:

1,366 dots (horizontal) × 768 lines (vertical)

Power Consumption:

KDL-46S2000/KDL-46S2010: 249 W

KDL-40S2000/KDL-40S2010: 180 W

KDL-32S2000/KDL-32S2010/KDL-32S2020: 125 W

KDL-26S2000/KDL-26S2010/KDL-26S2020: 100 W

Standby Power Consumption:

0.3 W

Dimensions (w × h × d):

KDL-46S2000/KDL-46S2010:

Approx. 1,120 × 805 × 334 mm (with stand)

Approx. 1,120 × 755 × 116 mm (without stand)

KDL-40S2000/KDL-40S2010:

Approx. 988 × 716 × 334 mm (with stand)

Approx. 988 × 664 × 103 mm (without stand)

KDL-32S2000/KDL-32S2010/KDL-32S2020:

Approx. 792 × 593 × 219 mm (with stand)

Approx. 792 × 546 × 99 mm (without stand)

KDL-26S2000/KDL-26S2010/KDL-26S2020:

Approx. 658 × 516 × 219 mm (with stand)

Approx. 658 × 470 × 94 mm (without stand)

Mass:

KDL-46S2000/KDL-46S2010:

Approx. 34 kg (with stand)

Approx. 28 kg (without stand)

KDL-40S2000/KDL-40S2010:

Approx. 27 kg (with stand)

Approx. 21 kg (without stand)

KDL-32S2000/KDL-32S2010/KDL-32S2020:

Approx. 17 kg (with stand)

Approx. 15 kg (without stand)

KDL-26S2000/KDL-26S2010/KDL-26S2020:

Approx. 13 kg (with stand)

Approx. 11 kg (without stand)

### Panel System

LCD (Liquid Crystal Display) Panel

### TV System

Analogue: Depending on your country/region selection:

B/G/H, D/K, L, I

Digital: DVB-T

### Colour/Video System

Analogue: PAL, SECAM

NTSC 3.58, 4.43 (only Video In)

Digital: MPEG-2 MP@ML

### Aerial

75 ohm external terminal for VHF/UHF

### Channel Coverage

Analogue: VHF: E2–E12

UHF: E21–E69

CATV: S1–S20

HYPER: S21–S41

D/K: R1–R12, R21–R69

L: F2–F10, B–Q, F21–F69

I: UHF B21–B69

Digital: VHF/UHF

### Terminals

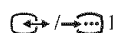

21-pin Scart connector (CENELEC standard) including audio/video input, RGB input, and TV audio/video output.

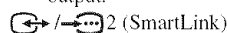

21-pin Scart connector (CENELEC standard) including audio/video input, RGB input, selectable audio/video output, and SmartLink interface.



Supported formats: 1080i, 720p, 576p, 576i, 480p, 480i

Y: 1 V<sub>p-p</sub>, 75 ohms, 0.3V negative sync

P<sub>B</sub>/C<sub>B</sub>: 0.7 V<sub>p-p</sub>, 75 ohms

P<sub>R</sub>/C<sub>R</sub>: 0.7 V<sub>p-p</sub>, 75 ohms



Audio input (phono jacks)

500 mV<sub>rms</sub>

Impedance: 47 kilo ohms

### HDMI IN 4

Video: 1080i, 720p, 576p, 576i, 480p, 480i

Audio: Two channel linear PCM

32, 44.1 and 48 kHz, 16, 20 and 24 bits, or analogue audio input (phono jacks)

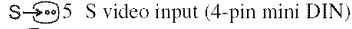

S video input (4-pin mini DIN)



Video input (phono jack)



Audio input (phono jacks)



Audio output (Left/Right) (phono jacks)



PC Input (15 Dsub) (see page 37)

G: 0.7 V<sub>p-p</sub>, 75 ohms, non Sync on Green

B: 0.7 V<sub>p-p</sub>, 75 ohms, non Sync on Green

R: 0.7 V<sub>p-p</sub>, 75 ohms, non Sync on Green

HD: 1-5 V<sub>p-p</sub>

VD: 1-5 V<sub>p-p</sub>



PC audio input (minijack)



Headphones jack



CAM (Conditional Access Module) slot

## Sound Output

10 W + 10 W

## Supplied Accessories

Refer to “1: Checking the accessories” on page 4.

## Optional Accessories

- Wall-Mount Bracket  
SU-WL51 (for KDL-46S2000/KDL-46S2010/  
KDL-40S2000/KDL-40S2010)  
SU-WL31 (for KDL-32S2000/KDL-32S2010/  
KDL-32S2020/KDL-26S2000/KDL-26S2010/  
KDL-26S2020)

Design and specifications are subject to change without notice.

## PC Input Signal Reference Chart

Signals	Horizontal (Pixel)	Vertical (Line)	Horizontal frequency (kHz)	Vertical frequency (Hz)	Standard
VGA	<b>640</b>	<b>480</b>	<b>31.5</b>	<b>60</b>	<b>VGA</b>
	640	480	37.5	75	VESA
	720	400	31.5	70	VGA-T
SVGA	<b>800</b>	<b>600</b>	<b>37.9</b>	<b>60</b>	<b>VESA Guidelines</b>
	800	600	46.9	75	VESA
XGA	<b>1024</b>	<b>768</b>	<b>48.4</b>	<b>60</b>	<b>VESA Guidelines</b>
	1024	768	56.5	70	VESA
	1024	768	60	75	VESA
WXGA	<b>1280</b>	<b>768</b>	<b>47.4</b>	<b>60</b>	<b>VESA</b>
	<b>1280</b>	<b>768</b>	<b>47.8</b>	<b>60</b>	<b>VESA</b>
	<b>1360</b>	<b>768</b>	<b>47.7</b>	<b>60</b>	<b>VESA</b>



- This TV's PC input does not support Sync on Green or Composite Sync.
- This TV's PC input does not support interlaced signals.
- This TV's PC input supports the boldfaced signals in the above chart with a 60 Hz vertical frequency.
- For the best picture quality, it is recommended to use signals with a 60 Hz vertical frequency from a personal computer. In plug and play, signals with a 60 Hz vertical frequency will be selected automatically.

# Troubleshooting

Check whether the  (standby) indicator is flashing in red.

## When it is flashing









The self-diagnosis function is activated.

- 1 Measure how long the  (standby) indicator flashes and stops flashing.  
For example, the indicator flashes for two seconds, stops flashing for one second, and flashes for two seconds.
- 2 Press  on the TV (top side) to switch it off, disconnect the mains lead, and inform your dealer or Sony service centre of how the indicator flashes (duration and interval).

## When it is not flashing

- 1 Check the items in the tables below.
- 2 If the problem still persists, have your TV serviced by qualified service personnel.

## Picture

Problem	Cause/Remedy
No picture (screen is dark) and no sound	<ul style="list-style-type: none"> <li>• Check the aerial connection.</li> <li>• Connect the TV to the mains, and press  on the TV (top side).</li> <li>• If the  (standby) indicator lights up in red, press .</li> </ul>
No picture or no menu information from equipment connected to the scart connector	<ul style="list-style-type: none"> <li>• Check that the optional equipment is on and press / repeatedly until the correct input symbol is displayed on the screen.</li> <li>• Check the connection between the optional equipment and the TV.</li> </ul>
Double images or ghosting	<ul style="list-style-type: none"> <li>• Check aerial/cable connections.</li> <li>• Check the aerial location and direction.</li> </ul>
Only snow and noise appear on the screen	<ul style="list-style-type: none"> <li>• Check if the aerial is broken or bent.</li> <li>• Check if the aerial has reached the end of its serviceable life (three to five years in normal use, one to two years at the seaside).</li> </ul>
Distorted picture (dotted lines or stripes)	<ul style="list-style-type: none"> <li>• Keep the TV away from electrical noise sources such as cars, motorcycles, hair-dryers or optical equipment.</li> <li>• When installing optional equipment, leave some space between the optional equipment and the TV.</li> <li>• Make sure that the aerial is connected using the supplied coaxial cable.</li> <li>• Keep the aerial cable away from other connecting cables.</li> </ul>
Picture noise when viewing a TV channel	<ul style="list-style-type: none"> <li>• Select "Manual Programme Preset" in the "Analogue Set-up" menu and adjust "AFT" (Automatic Fine Tuning) to obtain better picture reception (page 30).</li> </ul>
Some tiny black points and/or bright points on the screen	<ul style="list-style-type: none"> <li>• The picture of a display unit is composed of pixels. Tiny black points and/or bright points (pixels) on the screen do not indicate a malfunction.</li> </ul>
No colour on programmes	<ul style="list-style-type: none"> <li>• Select "Reset" in the "Picture" menu to return to the factory settings (page 21).</li> </ul>
No colour or irregular colour when viewing a signal from the Y, PB/CB, PR/CR jacks of 	<ul style="list-style-type: none"> <li>• Check the connection of the Y, PB/CB, PR/CR jacks of .</li> <li>• Make sure that the Y, PB/CB, PR/CR jacks of  are firmly seated in their respective sockets.</li> </ul>

## Sound

Problem	Cause/Remedy
No sound, but good picture	<ul style="list-style-type: none"><li>• Press <math>\triangleleft</math> +/- or <math>\text{M}</math> (Mute).</li><li>• Check that “Speaker” is set to “On” in the “Set-up” menu (page 27).</li></ul>
Noisy sound	<ul style="list-style-type: none"><li>• See the “Picture noise” causes/remedies on page 38.</li></ul>

## Channels

Problem	Cause/Remedy
The desired channel cannot be selected	<ul style="list-style-type: none"><li>• Switch between digital and analogue mode and select the desired digital/analogue channel.</li></ul>
Some channels are blank	<ul style="list-style-type: none"><li>• Scrambled/Subscription only channel. Subscribe to the Pay Per View service.</li><li>• Channel is used only for data (no picture or sound).</li><li>• Contact the broadcaster for transmission details.</li></ul>
Digital channel is not displayed	<ul style="list-style-type: none"><li>• Contact a local installer to find out if digital transmissions are provided in your area.</li><li>• Upgrade to a higher gain aerial.</li></ul>

## General

Problem	Cause/Remedy
The TV turns off automatically (the TV enters standby mode)	<ul style="list-style-type: none"><li>• Check if the “Sleep Timer” is activated, or confirm the “Duration” setting of “On Timer” (page 26).</li><li>• If no signal is received and no operation is performed in the TV mode for 10 minutes, the TV automatically switches to standby mode.</li></ul>
The TV turns on automatically	<ul style="list-style-type: none"><li>• Check if the “On Timer” is activated (page 27).</li></ul>
Some input sources cannot be selected	<ul style="list-style-type: none"><li>• Select “AV Preset” in the “Set-up” menu and cancel “Skip” of the input source (page 26).</li></ul>
The remote does not function	<ul style="list-style-type: none"><li>• Replace the batteries.</li></ul>

# Index

## Numerics

- 1 Digit Direct 29
- 14:9 14
- 4:3 Default 25
- 4:3 14

## A

- Advanced Settings 22
- Aerial, connecting 4
- AFT 30
- All Reset 27
- Analogue Set-up menu 29
- Analogue Text 14
- Audio Filter 30
- Audio Language 32
- Audio Type 32
- Auto Adjustment 28
- Auto Clock Set 15, 19, 35
- Auto Format 25
- Auto S Video 26
- Auto Start-up 26
- Auto Tuning
  - analogue and digital channels 6
  - analogue channels only 29
  - digital channels only 31
- Auto Volume 23
- AV Preset 26
- AV2 Output 27

## B

- Backlight 21
- Balance 23
- Bass 23
- Batteries, inserting into the remote 4
- BBE 23
- Black Corrector 22
- Brightness 21

## C

- CA Module Set-up 32
- Category list 16
- Channels
  - auto-tuning 6
  - selecting 13
  - Skip 30
- Clear White 22
- Clock Set 27
- Colour 21
- Colour System 27
- Colour Temperature 21
- Confirm 30
- Connecting
  - an aerial/VCR 4
  - optional equipment 33
- Contrast Enhancer 22
- Contrast 21
- Country 5

## D

- Digital Auto Tuning 31
- Digital Manual Tuning 31
- Digital Set-up 32
- Digital Set-up menu 31
- Digital Text 14
- Digital Tuning 31
- Display Area 25
- Dual Sound 24

## E

- EPG (Digital Electronic Programme Guide) 16
- Equipment labels 26

## F

- Fastext 14
- Favourite list 18

## G

- Gamma 22

## H

- Headphones
  - connecting 33
  - Speaker Link 24
  - Volume 24
- Horizontal Shift 25, 28
- Hue 21

## I

- Information 27
- Input signal index table 19
- Interactive service 13

## L

- Label 30
- Language 5, 26
- Light Sensor 27
- Live Colour 22

## M

- Manual Programme Preset 30
- Manual timer REC 17
- MENU 20
- MPEG Noise Reduction 22

## N

- Noise Reduction 22

## O

- On Timer 27

## P

- Parental Lock 32
- PC Settings menu 28
- Phase 28
- Picture menu 21
- Picture Mode 21
- Picture Off (⊠) indicator 12
- PIN Code 32
- Pitch 28

- Power (⏻) indicator 12
- Power (⏻) switch 12
- Power Management 28
- Power Saving 27
- Programme index table 13
- Programme Labels 29
- Programme List Edit 31
- Programme Sorting 29

## Q

- Quiet Power On 27

## R

- Reminder 17
- Remote control
  - inserting batteries 4
  - overview 11
  - sensor 12
- Reset
  - PC settings 28
  - picture 21
  - sound 23

## S

- Screen Format 25, 28
- Screen menu 25
- Screen mode 14
- Set-up menu 26
- Sharpness 22
- Skip 26, 30
- Sleep Timer 26
- Smart 14
- Sound menu 23
- Sound Mode 23
- Speaker 27
- Specifications 36
- Standby (⏻) indicator 12
- Subtitle Language 32
- Subtitle Setting 32
- Surround 23

## T

- Target Inputs
  - picture 21
  - screen 25
  - sound 23
- Technical Set-up 32
- Timer (⌚) indicator 12
- Timer list 17
- Timer REC 16
- Timer Settings 26
- Tools 15, 19, 35
- Treble 23

## V

- VCR
  - connecting 4
  - recording 16
- Vertical Shift 25, 28
- Vertical Size 25



**W**

Wide 14

**Z**

Zoom 14



<http://www.sony.net/>

**KDL-46S2000 KDL-46S2010**  
**KDL-40S2000 KDL-40S2010**  
**KDL-32S2000 KDL-32S2010**  
**KDL-32S2020 KDL-26S2000**  
**KDL-26S2010 KDL-26S2020**



268495311

2-684-953-11(1)

**U**

Printed in Slovak Republic