

---

# Kodak EasyShare C643/C603 zoom digital camera

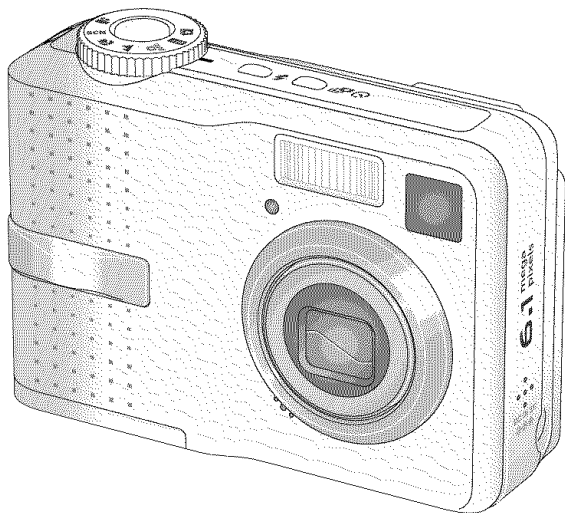

## User's guide

[www.kodak.com](http://www.kodak.com)

For interactive tutorials, [www.kodak.com/go/howto](http://www.kodak.com/go/howto)

For help with your camera, [www.kodak.com/go/c643support](http://www.kodak.com/go/c643support) or  
[www.kodak.com/go/c603support](http://www.kodak.com/go/c603support)



Eastman Kodak Company

Rochester, New York 14650

© Eastman Kodak Company, 2005

All screen images are simulated.

Kodak and EasyShare are trademarks of Eastman Kodak Company.

P/N 4J4308\_en

## Front view

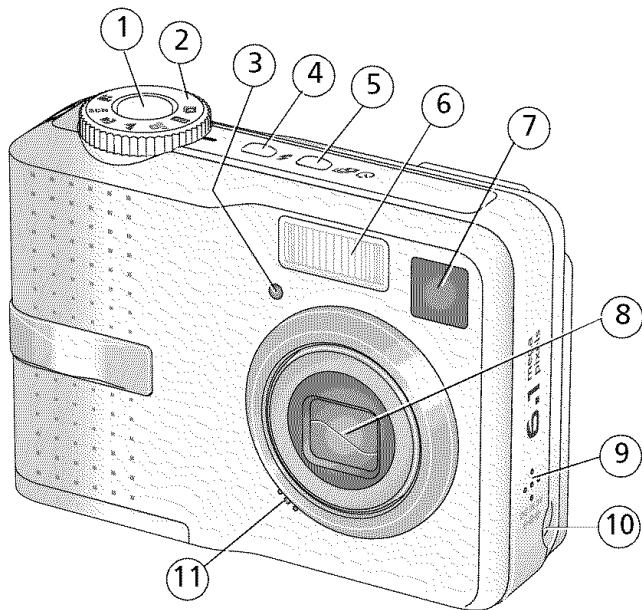

- |   |                         |    |  |
|---|-------------------------|----|--|
| 1 | Shutter button          | 7  | Viewfinder   |
| 2 | Mode dial               | 8  | Lens   |
| 3 | Self-timer/Video light  | 9  | Speaker  |
| 4 | Flash button            | 10 | DC-In (3V)  , for <b>optional</b> AC adapter |
| 5 | Self-timer/Burst button | 11 | Microphone   |
| 6 | Flash                   |    |  |

## Back view

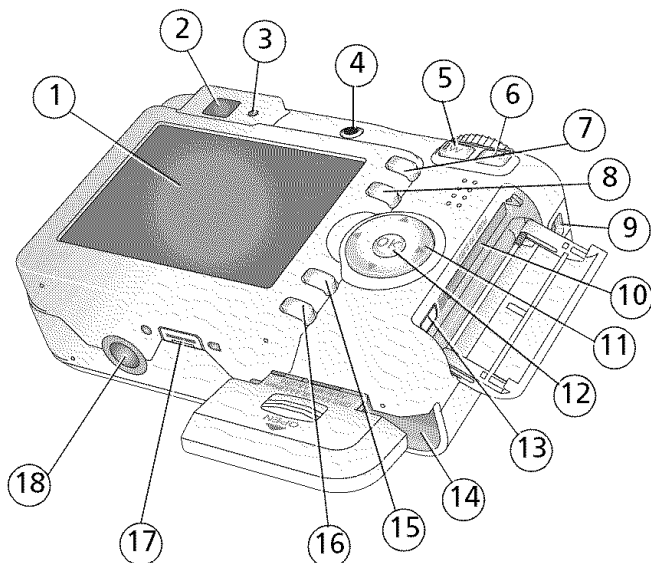

- |   |                   |    |   |
|---|-------------------|----|---|
| 1 | LCD               | 10 | Slot for optional SD or MMC card  |
| 2 | Viewfinder        | 11 |  |
| 3 | Ready light       | 12 | OK button   |
| 4 | Share button      | 13 | USB, A/V Out  |
| 5 | Wide angle button | 14 | Battery compartment   |
| 6 | Telephoto button  | 15 | Menu button   |
| 7 | Delete button     | 16 | Review button   |
| 8 | LCD/Info button   | 17 | Dock connector  |
| 9 | Strap post        | 18 | Tripod socket   |

---

# Table of contents

1	Setting up your camera .....	1
	Attaching the strap .....	1
	Loading the battery .....	1
	Turning on the camera .....	2
	Setting the language, date/time.....	2
	Storing pictures on an SD or MMC card .....	3
2	Taking pictures and videos .....	4
	Taking a picture .....	4
	Using the flash .....	8
	Reviewing pictures and videos on your camera .....	9
3	Transferring and printing pictures .....	12
	Installing the software.....	12
	Transferring pictures with the USB cable .....	13
	Printing pictures .....	14
	Dock compatibility for your camera.....	17
4	Doing more with your camera .....	18
	Using optical zoom .....	18
	Picture-taking modes .....	19
	Using exposure compensation to adjust brightness .....	21
	Using the self-timer .....	21
	Using burst .....	22
	Changing picture-taking settings .....	23
	Customizing your camera .....	27
	Running a slide show .....	29
	Cropping pictures.....	31
	Viewing picture/video information .....	31
	Copying pictures and videos .....	32
	Pre-tagging for album names .....	32
	Sharing your pictures.....	34

5	Troubleshooting .....	40
	Camera problems .....	40
	Camera ready light status .....	42
	Camera/computer communications .....	43
	LCD screen messages .....	44
6	Getting help .....	47
	Helpful links .....	47
	Telephone customer support .....	48
7	Appendix .....	49
	Camera specifications .....	49
	Storage capacities .....	52
	Important safety instructions .....	53
	Battery life .....	54
	Upgrading your software and firmware .....	55
	Additional care and maintenance .....	55
	Warranty .....	56
	Regulatory compliance .....	58

# 1

## Setting up your camera

### Attaching the strap

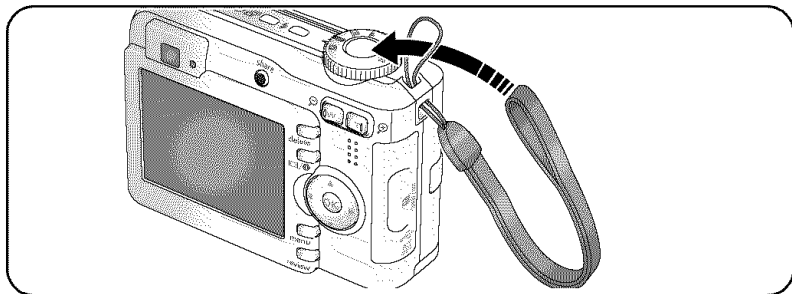

### Loading the battery

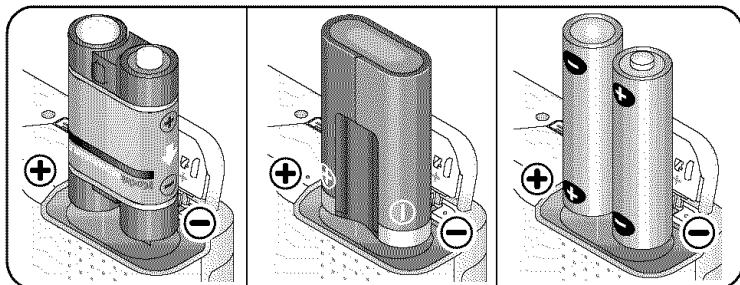

Ni-MH  
(rechargeable)

CRV3 lithium  
(non-rechargeable)

2 AA (rechargeable or  
non-rechargeable)

For battery types, see page 51. To extend battery life, see page 55

## Turning on the camera

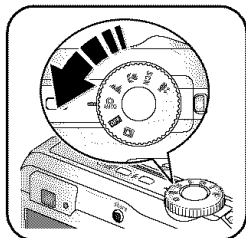

## Setting the language, date/time

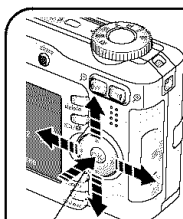

OK (press)

- 1 to change.  
 for previous/next field.
- 2 OK to accept.

## Setting the language, date/time in the future

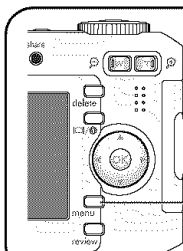

- 1 Press Menu.
- 2 to highlight Setup Menu then press OK.
- 3 to highlight Language or Date/Time , then press OK.



## Storing pictures on an SD or MMC card

Your camera has 32 MB of internal memory. You can purchase an SD or MMC card to conveniently store more pictures and videos.

NOTE: When using the card for the first time, format it in this camera before taking pictures (see Format on page 29). We recommend Kodak SD or MMC cards.

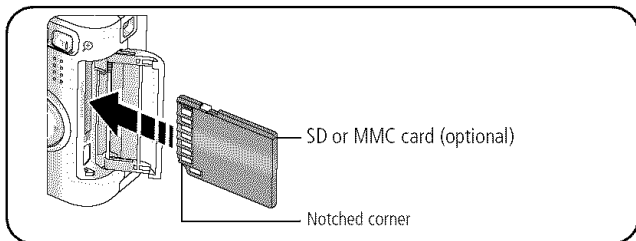



### CAUTION:

**A card can only be inserted one way; forcing it may cause damage. Inserting or removing a card when the Ready light is blinking may damage the pictures, the card, or the camera.**

See page 52 for storage capacities. Purchase SD or MMC cards at a dealer of Kodak products or at [www.kodak.com/go/c643accessories](http://www.kodak.com/go/c643accessories) or [www.kodak.com/go/c603accessories](http://www.kodak.com/go/c603accessories).

## 2 Taking pictures and videos

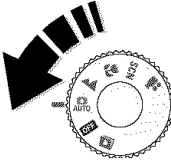
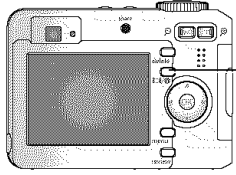
### Taking a picture

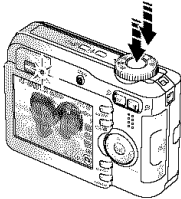
<p>1</p> 	<p>2</p>  <p>Use the LCD or viewfinder. Press LCD/Info   for:</p> <ul style="list-style-type: none"><li>• LCD on, status icons on</li><li>• LCD on, status icons off</li><li>• LCD off (use the viewfinder)</li></ul>	<p>3</p>  <p>Press the Shutter button halfway to focus and set exposure. When the Ready light turns green, press the Shutter button completely down.</p>
--	--	---

### Taking a video

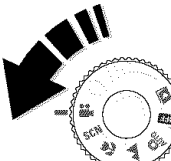
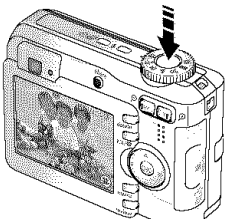
<p>1</p> 	<p>2</p>  <p>Press the Shutter button completely down and release. To stop recording, press and release the Shutter button again.</p>
---	---

## Reviewing the picture or video just taken

After you take a picture or video, the LCD displays a quickview for approximately 5 seconds.

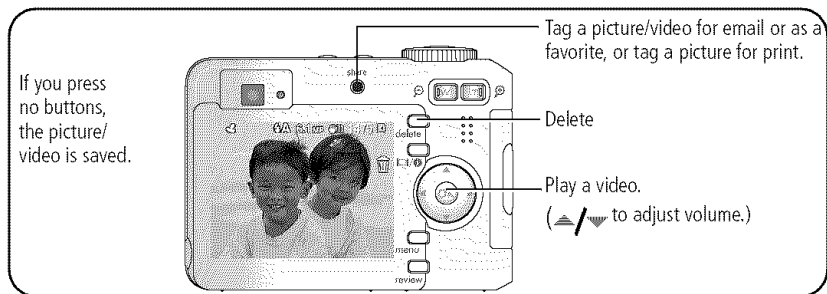

To review pictures and videos anytime, see page 9.

### Understanding blur warning icons

If the feature is turned on (see page 28), a picture blur warning icon  is displayed during quickview and review.

**Green**—Picture is sharp enough for an acceptable 4 x 6-inch (10 x 15 cm) print.

**Yellow**—Picture may be sharp enough for an acceptable 4 x 6-inch print or sharpness is not determined.

**Red**—Picture is not sharp enough for an acceptable 4 x 6-inch print.

**White**—Printability is still being determined.

## Understanding picture-taking icons

In capture mode—no buttons pressed

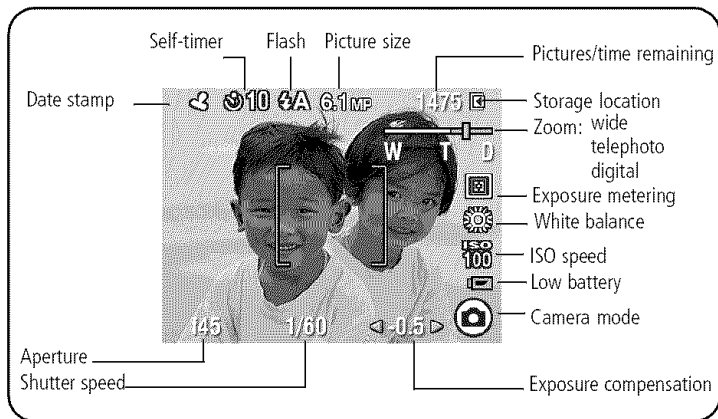

In capture mode—shutter pressed halfway

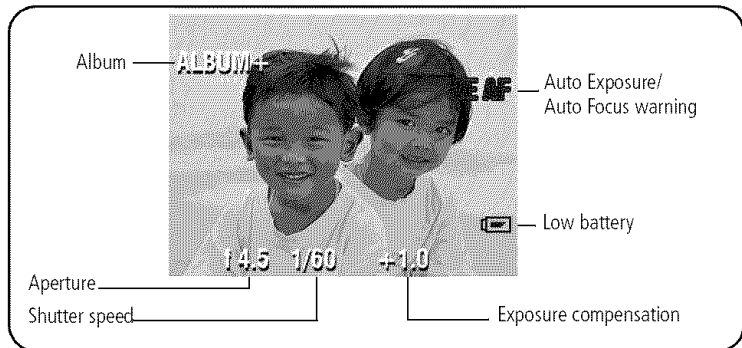

## Using the auto-focus framing marks (to take pictures)

When using the LCD as a viewfinder, framing marks indicate the camera focus area. The camera attempts to focus on foreground subjects, even if the subjects are not centered in the scene.

- 1 Press the Shutter button **halfway**.

*When the framing marks turn green, focus is accomplished.*

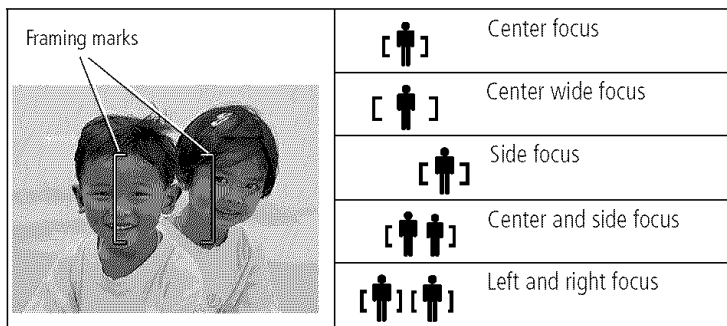



- 2 If the camera is not focusing on the desired subject (or if the framing marks disappear), release the Shutter button and recompose the scene.
- 3 Press the Shutter button **completely down** to take the picture.

NOTE: Framing marks do not appear in Landscape or Video mode. When you use Focus Zone (see page 25) and set Center Zone, the framing marks are fixed at Center Wide.

## Using the flash

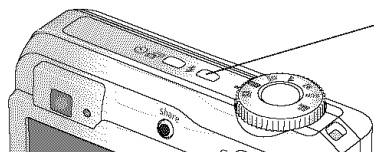



Use the flash when you take pictures at night, indoors, or outdoors in heavy shadows.



Press the  button repeatedly to scroll through flash modes (see Flash modes below).

The current flash mode is shown in the LCD status area.

Flash-to-subject distance	
Zoom position	Flash distance
Wide angle	2–11.8 ft (0.6–3.6 m) @ ISO 140
Telephoto	2–6.9 ft (0.6–2.1 m) @ ISO 140

Flash modes	Flash fires	
 <b>Auto Flash</b>	When the lighting conditions require it.	
 <b>Fill</b>	Every time you take a picture, regardless of the lighting conditions. Use when the subject is in shadow or is "backlit" (when the light is behind the subject). In low light, hold the camera steady or use a tripod.	
 <b>Red-eye</b>	If the Red-eye Pre-flash feature is turned off:	If the Red-eye Pre-flash feature is turned on:
	<ul style="list-style-type: none"> <li>■ The flash fires once.</li> <li>■ The camera then automatically corrects red-eye in the picture.</li> </ul>	<ul style="list-style-type: none"> <li>■ The flash fires once so the eyes become accustomed to the flash, then fires again when the picture is taken.</li> <li>■ The camera then automatically corrects red-eye in the picture.</li> </ul>
	To turn the Red-eye Pre-flash feature on/off, see page 28.	
 <b>Off</b>	Never	

## Reviewing pictures and videos on your camera

Press the Review button to view and work with your pictures and videos.

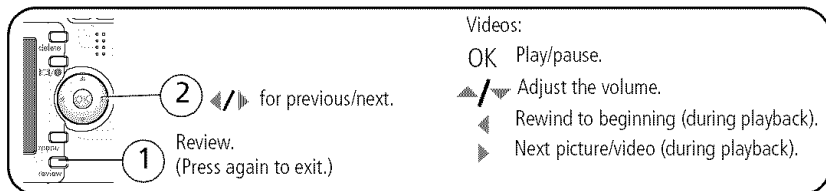

To save battery power, use an optional Kodak EasyShare dock or Kodak 3-volt AC adapter. (See [www.kodak.com/go/c643accessories](http://www.kodak.com/go/c643accessories) or [www.kodak.com/go/c603accessories](http://www.kodak.com/go/c603accessories).)

NOTE: Pictures taken at the 5.4 MP (3:2) quality setting are displayed at a 3:2 aspect ratio with a black bar at the top of the screen. A video's duration is displayed at the top of the LCD.

### Magnifying a picture during review

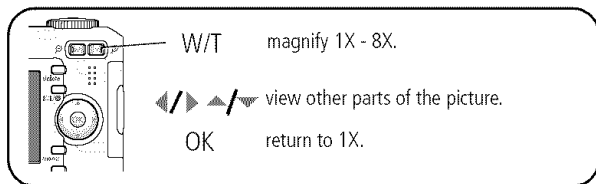

### Viewing multi-up (thumbnails) during review

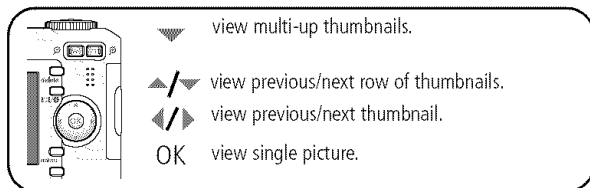

## Understanding review icons

### Pictures

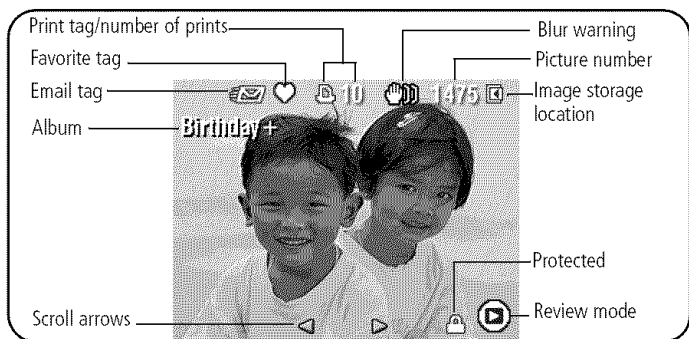

### Videos

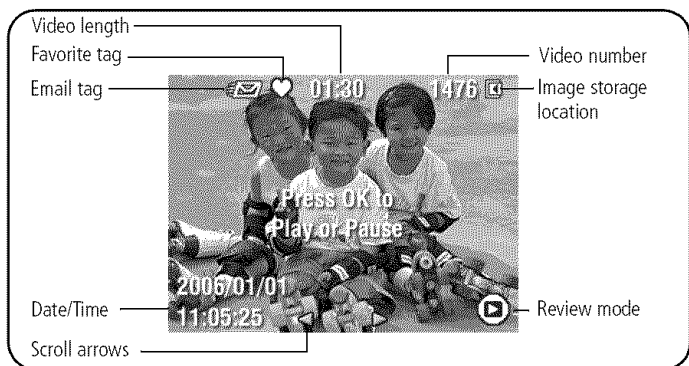



## Deleting pictures and videos during review

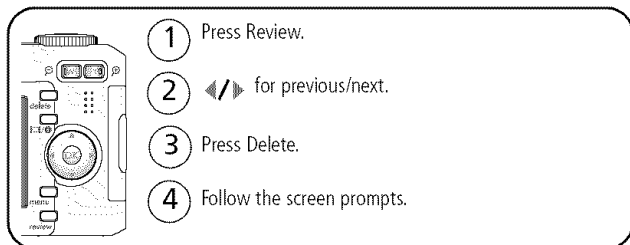

### Using the undelete feature

If you accidentally delete a picture/video, you can use Undo Delete to retrieve it. This feature is only available immediately after you delete a picture/video.

### Protecting pictures and videos from deletion

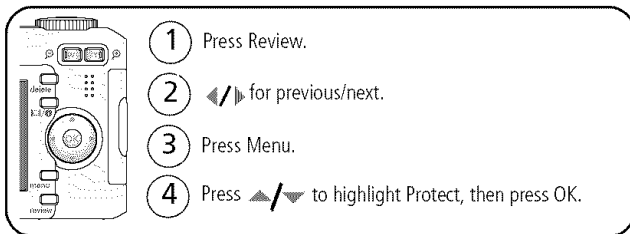

*The picture or video is protected and cannot be deleted. The Protect icon  appears with the protected picture or video.*

Press the Menu button to exit the menu.

# 3

## Transferring and printing pictures

### Installing the software



#### CAUTION:

**Install EasyShare software *before* connecting the camera to the computer. Failure to do so may cause the software to load incorrectly.**

- 1 Close all software applications that are open on your computer (including anti-virus software).
- 2 Place the EasyShare software CD into the CD-ROM drive.
- 3 Load the software:

**Windows OS**—if the install window does not appear, choose Run from the Start menu and type **d:\setup.exe** where **d** is the drive letter that contains the CD.

**Mac OS X**—double-click the CD icon on the desktop, then click the Install icon.

- 4 Follow the on-screen instructions to install the software.

**Windows OS**—select Complete to automatically install the most commonly used applications, or Custom to choose the ones you wish to install.

**Mac OS X**—follow the on-screen instructions.

- 5 If prompted, restart the computer. If you turned off anti-virus software, turn it back on. See the anti-virus software manual for details.

For information on the software applications included on the EasyShare software CD, click the Help button in EasyShare software.

## Transferring pictures with the USB cable

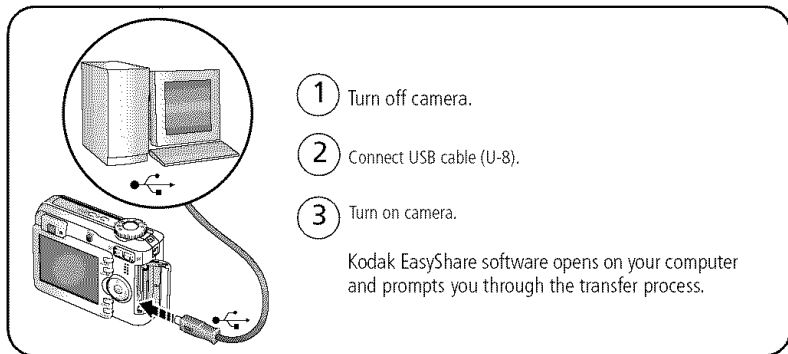

NOTE: Visit [www.kodak.com/go/howto](http://www.kodak.com/go/howto) for an online tutorial on connecting.

### Also available for transferring

You can also use these Kodak products to transfer your pictures and videos.

- Kodak EasyShare camera dock, Kodak EasyShare printer dock (see page 17)
- Kodak multi-card reader, Kodak SD multimedia card reader-writer

Purchase these and other accessories at a dealer of Kodak products or [www.kodak.com/go/c643accessories](http://www.kodak.com/go/c643accessories) or [www.kodak.com/go/c643accessories](http://www.kodak.com/go/c643accessories).

## Printing pictures

### Printing with a Kodak EasyShare printer dock

Dock your camera to the Kodak EasyShare printer dock and print directly—with or without a computer. Purchase this and other accessories at a dealer of Kodak products or visit [www.kodak.com/go/c643accessories](http://www.kodak.com/go/c643accessories) or [www.kodak.com/go/c603accessories](http://www.kodak.com/go/c603accessories).

### Direct printing with a PictBridge enabled printer

Your camera is compatible with PictBridge technology, so you can print directly to PictBridge enabled printers. You need:

- Camera with fully charged batteries
- PictBridge enabled printer
- USB cable (may be sold separately)



### Connecting the camera to a PictBridge enabled printer



- 1 Turn off the camera and printer.
- 2 Connect the appropriate USB cable from the camera to the printer. (See your printer user guide or visit [www.kodak.com/go/c643accessories](http://www.kodak.com/go/c643accessories) or [www.kodak.com/go/c603accessories](http://www.kodak.com/go/c603accessories).)

## Printing from a PictBridge enabled printer

- 1 Turn on the printer. Turn on the camera.

*The PictBridge logo is displayed, followed by the current picture and menu. (If no pictures are found, a message is displayed.) If the menu interface turns off, press any button to redisplay it.*

- 2 Press / to choose a printing option, then press the OK button.

<b>Current Picture</b>	Press  /  to choose a picture. Choose the number of copies.
<b>Tagged Pictures</b>	If your printer is capable, print pictures that you tagged for printing and choose a print size.
<b>Index Print</b>	Print thumbnails of all pictures. This option requires one or more sheets of paper. If the printer is capable, choose a print size.
<b>All Pictures</b>	Print all pictures in internal memory, on a card, or in Favorites. Choose the number of copies.
<b>Image Storage</b>	Access internal memory, a card, or Favorites.

NOTE: During direct printing, pictures are not permanently transferred or saved to the computer or printer.

## Disconnecting the camera from a PictBridge enabled printer

- 1 Turn off the camera and printer.
- 2 Disconnect the USB cable from the camera and the printer.

## Using a printer that is not PictBridge enabled

For details on printing pictures from your computer, click the Help button in EasyShare software.

## **Ordering prints online**

*Kodak EasyShare* Gallery ([www.kodakgallery.com](http://www.kodakgallery.com)) is one of the many online print services offered in the *Kodak EasyShare* software. You can easily:

- Upload your pictures.
- Edit, enhance, and add borders to your pictures.
- Store pictures, and share them with family and friends.
- Order high-quality prints, photo greeting cards, frames, and albums—and have them delivered to your door.

## **Printing from an optional SD/MMC card**

- Automatically print tagged pictures when you insert your card into a printer with an SD/MMC card slot. See your printer user's guide for details.
- Make prints at an SD/MMC-capable Kodak picture maker/picture kiosk. (Contact a location prior to visiting. See [www.kodak.com/go/picturemaker](http://www.kodak.com/go/picturemaker).)
- Take the card to your local photo retailer for professional printing.

## Dock compatibility for your camera

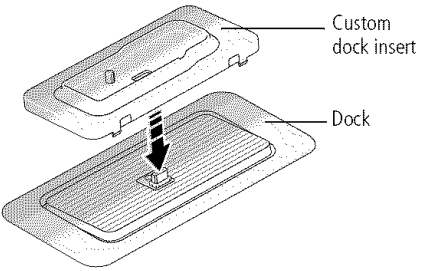
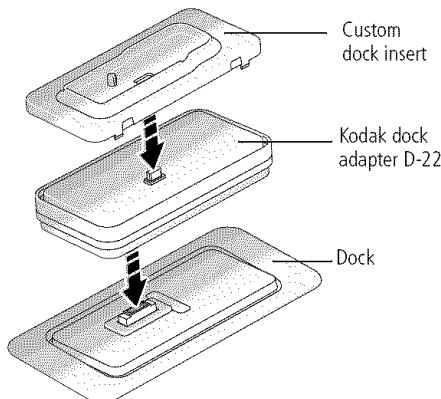
Kodak EasyShare dock	Docking configuration
<ul style="list-style-type: none"> <li>■ printer dock plus series 3</li> <li>■ printer docks and camera docks series 3</li> </ul>	 <p>Custom dock insert</p> <p>Dock</p>
<ul style="list-style-type: none"> <li>■ printer dock</li> <li>■ printer dock plus</li> <li>■ printer dock 6000</li> <li>■ camera dock 6000</li> </ul>	 <p>Custom dock insert</p> <p>Kodak dock adapter D-22</p> <p>Dock</p>
<ul style="list-style-type: none"> <li>■ printer dock 4000</li> <li>■ camera dock II</li> <li>■ LS420, LS443 camera dock</li> </ul>	Not compatible

Purchase camera docks, printer docks, and other accessories at a dealer of Kodak products or [www.kodak.com/go/c643accessories](http://www.kodak.com/go/c643accessories) or [www.kodak.com/go/c603accessories](http://www.kodak.com/go/c603accessories).

# 4

## Doing more with your camera

### Using optical zoom

Use optical zoom to get up to 3X closer to your subject. Optical zoom is effective when the lens is no closer than 24 in. (60 cm) to the subject or 5.1 in. (12.9 cm) in Close-up mode. You can change optical zoom before (but not during) video recording.

Use the viewfinder or LCD to frame your subject.

Press Telephoto (T) to zoom in. Press Wide Angle (W) to zoom out.

*The zoom indicator shows zoom status.*

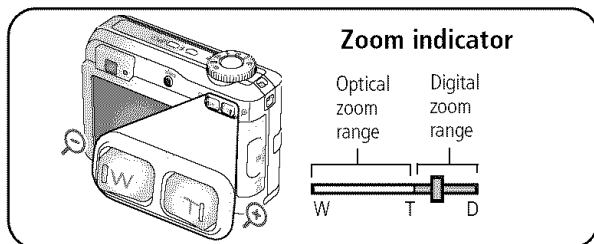

Take the picture or video.

### Using digital zoom

Use digital zoom in any Still mode to get up to 15X magnification.





- 1 Press the Telephoto (T) button to the optical zoom limit (3X). Release the button, then press it again.
- 2 Take the picture or video.

**NOTE:** You cannot use digital zoom for video recording. You may notice decreased image quality when using digital zoom. The blue slider on the zoom indicator pauses and turns red when the picture quality reaches the limit for an acceptable 4 x 6-in. (10 x 15 cm) print.

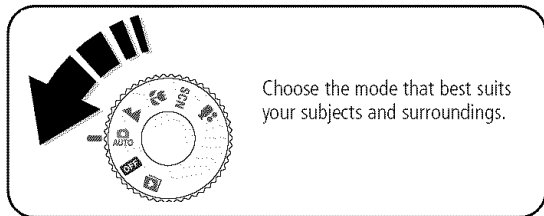

## Picture-taking modes



Use this mode	For
 <b>Auto</b> AUTO	General picture-taking—offers an excellent balance of image quality and ease of use.
 <b>Landscape</b>	Far-away scenes. The camera uses infinity auto-focus. Auto-focus framing marks are not available in Landscape.
 <b>Close-up</b>	Close range. Use available light instead of flash if possible. The camera automatically sets the focus distance depending on the zoom position.
<b>SCN</b> <b>Scene</b>	Point-and-shoot simplicity when taking pictures under special conditions. (See page 20.)
 <b>Video</b>	Capturing video with sound. (See page 4.)

## Scene modes

- 1 Turn the Mode dial to Scene **SCN**.
  - 2 Press to display Scene mode descriptions.
- NOTE: If the Help text turns off, press the OK button.
- 3 Press the OK button to choose a Scene mode.

Use this SCN mode	For
	<b>Portrait</b> Full-frame portraits of people.
	<b>Sport</b> Subjects that are in motion.
	<b>Children</b> Action pictures of children in bright light.
	<b>Party</b> People indoors. Minimizes red eye.
	<b>Beach</b> Bright beach scenes.
	<b>Snow</b> Bright snow scenes.
	<b>Fireworks</b> Flash does not fire. Place the camera on a flat, steady surface or use a tripod.
	<b>Self-Portrait</b> Close-ups of yourself. Assures proper focus and minimizes red eye.
	<b>Backlight</b> Subjects that are in shadow or “backlit” (when light is behind the subject).
	<b>Night Portrait</b> Reduces red eye of people in night scenes or low-light conditions. Place the camera on a flat, steady surface or use a tripod.

## Using exposure compensation to adjust brightness

In Auto or SCN, you can adjust exposure compensation to make your pictures darker or lighter. Press ▲ to increase exposure compensation, and ▼ to decrease exposure compensation.

The exposure compensation level is shown on the LCD <-2.0> and the LCD gets brighter or dimmer.

## Using the self-timer

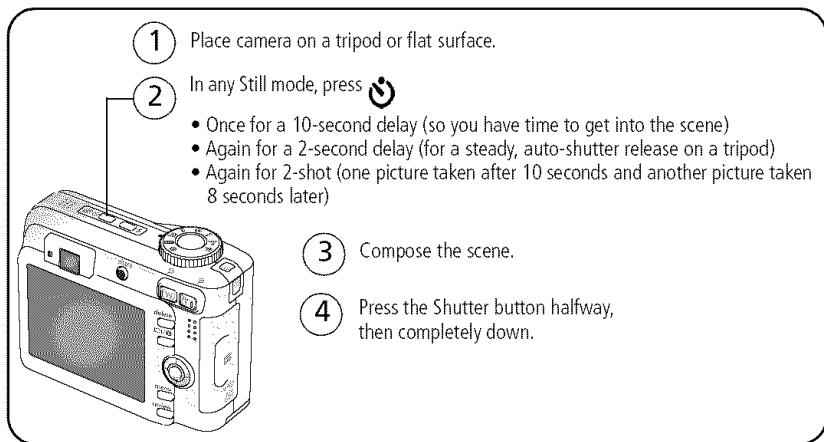



To cancel the Self-timer before the picture is taken, press the Self-timer button. (The Self-timer setting remains active.)

### Use the same procedure to take a video, but:

- Turn the Mode dial to Video .
- Press the Shutter button completely down.

NOTE: The video stops when no storage space remains. Only the 2- and 10-second options are available in video mode.

## Using burst

Option	Description	Purpose
 <b>Burst</b>	Camera takes up to 4 pictures (2 per second) while the Shutter button is pressed.  First 4 pictures are saved.	Capture an expected event.  <b>Example:</b> A person swinging a golf club.



- 1 In most Still modes, press the Burst button repeatedly to choose an option.
- 2 Press the Shutter button **halfway** to focus and set exposure.
- 3 Press the Shutter button **completely down and hold it** to take pictures.

*The camera stops taking pictures when you release the Shutter button, when the pictures are taken, or when there is no more storage space.*

NOTE: During quickview, you can delete all pictures in the burst series. To delete selectively, do so in Review (see page 11).

## Changing picture-taking settings

You can change settings to get the best results from your camera:

- 1 Press the Menu button.
- 2 Press / to highlight a setting, then press the OK button.
- 3 Choose an option, then press the OK button.
- 4 Press the Menu button to exit.

NOTE: Some settings are unavailable in some modes.

Setting	Options
<p><b>Exposure Bracketing</b></p> <p>Determine the best exposure level for your conditions based on your evaluation of 3 pictures.</p> <p><i>This setting remains until you turn the Mode dial.</i></p>	<p><b>Off</b></p> <p>+/- 0.5</p> <p>+/- 1.0</p> <p>The camera takes 3 pictures—at +, at 0, and at - exposure.</p>
<p><b>Exposure Compensation</b></p> <p>Control how much light enters the camera.</p> <p><i>This setting remains until you turn the Mode dial.</i></p>	<p>-2.0 to +2.0 (in 0.5 increments)</p>

Setting	Options
<p><b>Picture Size</b> Choose a picture resolution. <i>This setting remains until you change it.</i></p>	<p><b>6.1 MP (default)</b>—for printing up to 20 x 30 in. (51 x 76 cm); pictures are highest resolution and largest file size.</p> <p><b>5.4 MP (3:2)</b>—ideal for printing 4 x 6 in. (10 x 15 cm) prints without cropping. Also for printing up to 20 x 30 in. (51 x 76 cm).</p> <p><b>4.0 MP</b>— for printing up to 20 x 30 in. (51 x 76 cm); pictures are medium resolution with smaller file size.</p> <p><b>1.9 MP</b>—for printing up to 11 x 14 in. (28 x 36 cm); pictures are medium resolution with smaller file size.</p> <p><b>0.8 MP</b>—for printing 4 x 6 in. (10 x 15 cm), emailing, Internet, screen display, or for conserving space.</p>
<p><b>White Balance</b> Choose your lighting condition. <i>This setting remains until you turn the Mode dial.</i></p>	<p><b>Auto (default)</b>—automatically corrects white balance. Ideal for general picture taking.</p> <p><b>Daylight</b>—for pictures in natural lighting.</p> <p><b>Tungsten</b>—corrects the orange cast of household light bulbs. Ideal for indoor pictures under tungsten or halogen lighting without flash.</p> <p><b>Fluorescent</b>—corrects the green cast of fluorescent lighting. Ideal for indoor pictures under fluorescent lighting without flash.</p>
<p><b>ISO Speed</b> Control the camera's sensitivity to light <i>This setting remains until you turn the Mode dial.</i></p>	<p>Choose a lower ISO setting in brightly lit scenes; use a higher ISO for low-light scenes. Choose Auto (default), 80, 100, 200, 400, 800 (800 available only for smallest picture size setting).</p> <p>NOTE: ISO returns to Auto when the camera is set to Sport, Portrait, or SCN mode, or during Long Time Exposure.</p> <p>Unavailable in Video mode.</p>



Setting	Options
<p><b>Focus Zone</b> Select a large or concentrated area of focus. <i>This setting remains until you turn the Mode dial.</i></p>	<p><b>Multi-zone (default)</b>—evaluates 3 zones to give an even picture focus. Ideal for general picture taking. <b>Center-zone</b>—evaluates the small area centered in the viewfinder. Ideal when precise focus of a specific area in the picture is needed. NOTE: For the best pictures, the camera is set to Multi-zone when in Landscape mode.</p>
<p><b>Color Mode</b> Choose color tones. <i>This setting remains until you turn the Mode dial.</i></p>	<p><b>Color</b> <b>Black &amp; White</b> <b>Sepia</b>—for pictures with a reddish-brown, antique look. NOTE: EasyShare software also lets you change a color picture to black-and-white or sepia. Unavailable in Video mode.</p>
<p><b>Long Time Exposure</b> Choose how long the shutter stays open. <i>This setting remains until you turn off the camera.</i></p>	<p><b>0.7 - 8.0</b> seconds</p>
<p><b>Set Album</b> Choose Album names. <i>This setting remains until you change it. You can apply different Set Album choices to videos and to pictures.</i></p>	<p><b>On or Off</b> Pre-select album names before you take pictures or videos. Then, all the pictures or videos you take are tagged with those album names. See page 32.</p>

Setting	Options
<b>Image Storage</b> Choose a storage location for pictures/videos. <i>This setting remains until you change it.</i>	<b>Auto (default)</b> —the camera uses the card if one is in the camera. If not, the camera uses internal memory. <b>Internal Memory</b> —the camera uses internal memory, even if a card is installed. <b>NOTE:</b> If you fill up your card while taking pictures, your camera's memory plus feature prompts you to switch to internal memory, if space is available. Memory plus is unavailable in Video mode.
<b>Video Size</b>	<b>640 x 240</b> <b>320 x 240</b> Available only in Video mode.
<b>Video Length</b>	<b>Continuous (default)</b> <b>5 seconds</b> <b>15 seconds</b> <b>30 seconds</b> Available only in Video mode.
<b>Setup Menu</b> Choose additional settings.	See Customizing your camera on page 27.



## Customizing your camera

Use Setup to customize your camera settings.

- 1 In any mode, press the Menu button.
- 2 Press  to highlight Setup , then press the OK button.
- 3 Press  to highlight the setting you wish to change, then press the OK button.
- 4 Choose an option, then press the OK button.
- 5 Press the Menu button to exit.

NOTE: These settings remain until you change them.

Setting	Options
<b>Return</b> to previous menu.	
<b>Liveview</b> Change liveview default to on or off. NOTE: In some modes, the LCD turns on even if the liveview option is set to Off. (To turn the LCD on/off any time, press the LCD/Info button.)	<b>On (default)</b> <b>Off</b>
<b>Camera Sounds</b> Choose sound effects.	<b>Theme</b> —applies the same sound effect set to all functions. <b>Individual</b> —choose a sound effect for each function.
<b>Sound Volume</b>	<b>Off</b> <b>Low (default)</b> <b>Medium</b> <b>High</b>





Setting	Options
<p><b>Auto Power Off</b> Choose inactivity time until camera turns off.</p>	<p><b>10 minutes</b> <b>5 minutes</b> <b>3 minutes (default)</b> <b>1 minute</b></p>
<p><b>Date &amp; Time</b></p>	<p>See page 2.</p>
<p><b>Video Out</b> Choose the regional setting that lets you connect the camera to a television or other external device.</p>	<p><b>NTSC (default)</b>—used in North America and Japan; most common format. <b>PAL</b>—used in Europe and China.</p>
<p><b>Orientation Sensor</b> Orient pictures so that they are displayed with the correct side up.</p>	<p><b>On (default)</b> <b>Off</b></p>
<p><b>Red-eye Pre-flash</b> Choose if the Red-eye flash fires automatically before a picture is taken.  NOTE: The camera automatically corrects red-eye, even if the Red-eye Pre-flash is set to Off.</p>	<p><b>On</b> <b>Off (default)</b></p>
<p><b>Date Stamp</b> Imprint the date on pictures.</p>	<p>Choose a date option, or turn off the feature. (Default is off.)</p>
<p><b>Video Date Display</b> Display Date/Time at the start of video playback.</p>	<p><b>On (default)</b>—choose from date formats. <b>Off</b></p>
<p><b>Blur Warning</b> Choose if image sharpness warning icon is displayed during quickview and review.</p>	<p><b>On (default)</b> <b>Off</b> (See page 5.)</p>
<p><b>Language</b></p>	<p>See page 2.</p>

Setting	Options
<b>Format</b>   <b>CAUTION:</b> <b>Formatting deletes all pictures/videos, including those that are protected. Removing a card during formatting may damage the card.</b>	<b>Memory Card</b> —deletes everything on the card; formats the card. <b>Cancel</b> —exits without making a change. <b>Internal Memory</b> —deletes everything in internal memory including email addresses, album names, and favorites; formats the internal memory.
<b>About</b> View camera information.	

## Running a slide show

Use the Slide Show to display your pictures/videos on the LCD. To run a slide show on a television or on any external device, see page 30. To save battery power, use an optional Kodak 3V AC adapter. (Visit [www.kodak.com/go/c643accessories](http://www.kodak.com/go/c643accessories) or [www.kodak.com/go/c603accessories](http://www.kodak.com/go/c603accessories).)

### Starting the slide show

- 1 Press the Review button, then press the Menu button.
- 2 Press / to highlight Slide Show , then press the OK button.
- 3 Press / to highlight Begin Show, then press the OK button.

*Each picture and video is displayed once.*

To interrupt the Slide Show, press the OK button.

## Changing the slide show display interval

The default interval setting displays each picture for 5 seconds. You can set the display interval from 3 to 60 seconds.

- 1 On the Slide Show menu, press **▲/▼** to highlight Interval, then press the OK button.
- 2 Select a display interval.  
To scroll through the seconds quickly, press and hold **▲/▼**.
- 3 Press the OK button.  
*The interval setting remains until you change it.*

## Running a continuous slide show loop

When you turn on Loop, the slide show is continuously repeated.

- 1 On the Slide Show menu, press **▲/▼** to highlight Loop, then press the OK button.
- 2 Press **▲/▼** to highlight On, then press the OK button.  
*The slide show repeats until you press the OK button or until battery power is exhausted. The Loop feature remains until you change it.*

## Displaying pictures and videos on a television

You can display pictures/videos on a television, computer monitor, or any device equipped with a video input. (Image quality on a television screen may not be as good as on a computer monitor or when printed.)

NOTE: Ensure that the Video Out setting (NTSC or PAL) is correct (see Video Out on page 27). The slide show stops if you connect a cable while the slide show is running.

- 1 Connect the audio/video cable (included) from the camera USB, A/V Out port to the television video-in port (yellow) and audio-in port (white). See your television user's guide for details.
- 2 Review pictures/videos on the television.

## Cropping pictures

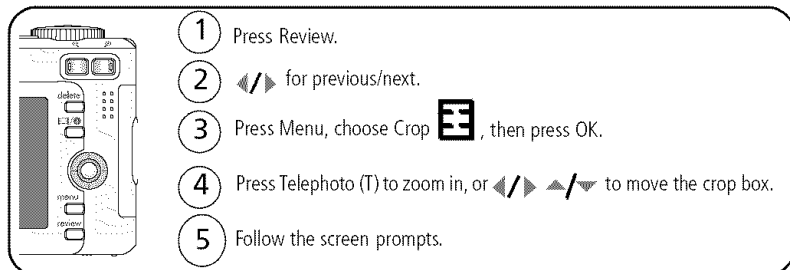

*The picture is copied, then cropped. The original picture is saved. A cropped picture cannot be cropped again on the camera.*

Press the Menu button to exit the menu.

## Viewing picture/video information

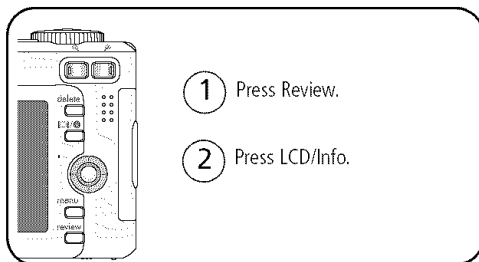

To exit Review, press the Review button.





## Copying pictures and videos

You can copy pictures/videos from a card to internal memory or from internal memory to a card.

### Before you copy, make sure that:

- A card is inserted in the camera.
- The camera's picture storage location is set to the location **from** which you are copying. (See Image Storage on page 26.)

### Copy pictures or videos:

- 1 Press the Review button, then press the Menu button.
- 2 Press / to highlight Copy , then press the OK button.
- 3 Press / to highlight an option.
- 4 Press the OK button.

NOTE: Pictures/videos are copied, not moved. To remove pictures/videos from the original location after copying, delete them (see page 11). Tags that you applied for print, email, and favorites are not copied. Protection settings are not copied. To apply protection to a picture or video, see page 11.

## Pre-tagging for album names

Use the Set Album (Still or Video) feature to pre-select album names before you take pictures or videos. Then, all the pictures or videos you take are tagged with those album names.

### First—on your computer

Use the EasyShare software that was packaged with your camera to create album names on your computer. The next time you connect the camera to the computer, copy up to 32 albums to the album name list. See EasyShare software Help for details.

## Second—on your camera

- 1 In any mode, press the Menu button.
- 2 Press ▲/▼ to highlight Set Album , then press the OK button.
- 3 Press ▲/▼ to highlight an album name, then press the OK button. Repeat to mark pictures or videos for albums.

*Selected albums are noted with a check mark.*

- 4 To remove a selection, highlight an album name and press the OK button. To remove all album selections, select Clear All.
- 5 Highlight Exit, then press the OK button.  
*Your selections are saved. If you turn on the LCD, your album selection is displayed on the screen. A plus (+) after the album name means more than one album is selected.*
- 6 Press the Menu button to exit the menu.

## Third—transfer to your computer

When you transfer the tagged pictures or videos to your computer, EasyShare software opens and categorizes your pictures in the appropriate album. See EasyShare software Help for details.



## Tagging pictures/videos for albums

Use the Album feature in Review mode to tag the pictures/videos in your camera with album names.

### First—on your computer

Use EasyShare software to create albums on your computer, then copy up to 32 album names to the camera's internal memory. See EasyShare software Help for details.

## Second—on your camera

- 1 Press the Review button, then locate the picture or video.
- 2 Press the Menu button.
- 3 Press  to highlight Album , then press the OK button.
- 4 Press  to highlight an album folder, then press the OK button.

To add other pictures to the same album, press  to scroll through the pictures. When the picture you want is displayed, press the OK button.

To add the pictures to more than one album, repeat step 4 for each album.

*The album name appears with the picture. A plus (+) after the album name means the picture was added to more than one album.*

To remove a selection, highlight an album name and press the OK button. To remove all album selections, select Clear All.

## Third—transfer to your computer

When you transfer the tagged pictures/videos to your computer, EasyShare software opens and categorizes your pictures/videos in the appropriate album folder. See EasyShare software Help for details.







## Sharing your pictures





Press the Share button to “tag” your pictures and videos. When they are transferred to your computer, you can share them. Use the Share button:

- Any time. (The most recent picture/video taken is then displayed.)
- Just after you take a picture/video, during quickview.
- After pressing the Review button.



## Tagging pictures for printing

- 1 Press the Share button. Press   to locate a picture.
- 2 Press   to highlight Print , then press the OK button.\*
- 3 Press   to select the number of copies (0-99). Zero removes the tag for that picture.

**Optional:** You can apply a print quantity to other pictures. Press   to locate a picture. Press   to change the print quantity. Repeat until the desired print quantity is applied to pictures.

- 4 Press the OK button.

*The Print icon  appears in the status area.*

- 5 Press the Share button to exit the menu.

\* To tag all pictures in the storage location, highlight Print All, press the OK button, then indicate the number of copies. Print All is not available in quickview. To remove print tagging for all pictures in the storage location, highlight Cancel Prints, then press the OK button. Cancel Prints is not available in quickview.

## Printing tagged pictures

When you transfer the tagged pictures to your computer, Kodak EasyShare software print screen opens. For details, click the Help button in EasyShare software.

For more information on printing from your computer, printer dock, PictBridge enabled printer, or card, see page 14.



NOTE: For the best 4 x 6 in. (10 x 15 cm) prints, set the camera to the 5.4 MP (3:2) print quality setting. (See Picture Size on page 23.)

## Tagging pictures and videos for emailing

### First—on your computer

Use Kodak EasyShare software to create an email address book on your computer. Then copy up to 32 email addresses to the camera's internal memory. For details, click the Help button in EasyShare software.

## Second—tag pictures/videos on your camera

- 1 Press the Share button. Press ◀/▶ to locate a picture/video.
- 2 Press ▲/▼ to highlight Email , then press the OK button.  
*The Email icon  appears in the status area.*

- 3 Press ▲/▼ to highlight an email address, then press the OK button.

To tag other pictures/videos with the same address, press ◀/▶ to scroll through them. When the picture you want is displayed, press OK.

To send the pictures/videos to more than one address, repeat step 3 for each address.

*Selected addresses are checked.*

- 4 To remove a selection, highlight a checked address and press the OK button. To remove all email selections, highlight Clear All.
- 5 Press ▲/▼ to highlight Exit, then press the OK button.
- 6 Press the Share button to exit the menu.









## Third—transfer and email

When you transfer the tagged pictures/videos to your computer, the Email screen opens and lets you send them to the addresses you specified. For details, click the Help button in Kodak EasyShare software.

## Tagging pictures as favorites

You can preserve your favorite pictures in the Favorites  section of your camera's internal memory, then share them with friends and family.





NOTE: When you transfer pictures from your camera to your computer, all pictures (including favorites) are stored on your computer at full size. Favorite pictures - smaller copies of your originals - are loaded back to your camera, so you can share and enjoy more.

<b>1. Tag pictures as favorites</b>	<ol style="list-style-type: none"> <li>1 Press the Share button. Press   to locate a picture.</li> <li>2 Press   to highlight Favorite , then press the OK button. <i>The Favorite icon  appears in the status area. To remove the tag, press the OK button again.</i></li> </ol> <p>Press the Share button to exit the menu.</p>
<b>2. Transfer pictures to your computer</b>	<ol style="list-style-type: none"> <li>1 To enjoy full functionality, load and use the EasyShare software that was packaged with this camera. (See page 12.)</li> <li>2 Connect the camera to the computer using the USB cable (see page 13) or an EasyShare dock. <i>The first time you transfer pictures, the software helps you make choices about your favorite pictures. Then, your pictures are transferred to the computer. Favorite pictures (smaller versions of the originals) are loaded to the Favorites section of your camera's internal memory.</i></li> </ol>
<b>3. View favorites on your camera</b>	<ol style="list-style-type: none"> <li>1 Turn the Mode dial to Favorites .</li> <li>2 Press   to scroll through favorites.</li> </ol>

NOTE: The camera holds a limited number of favorites. Use Camera Favorites in the EasyShare software to customize the size of your camera Favorites  section. Videos tagged as favorites remain in the Favorites folder in EasyShare software. For details, click the Help button in EasyShare software.



## Optional settings

In Favorites mode, press the Menu button to access optional settings.

	Slide Show (page 29)		Remove all favorites (page 38)
	Multi-up (page 9)		Setup Menu (page 27)

NOTE: Pictures taken at the 5.4 MP (3:2) quality setting are displayed at a 3:2 aspect ratio with a black bar at the top of the screen.

## Removing all favorites from your camera

- 1 Turn the Mode dial to Favorites .
- 2 Press the Menu button.
- 3 Highlight Remove Favorites , then press the OK button.

*All pictures stored in the Favorites section of internal memory are removed. Favorites are restored the next time you transfer pictures to the computer.*

- 4 Press the Menu button to exit the menu.

## Preventing favorites from transferring to the camera

- 1 Open Kodak EasyShare software. Click the My Collection tab.
- 2 Go to the Albums view.
- 3 Click the Camera Favorites Album for your camera.
- 4 Click Remove Album.

*The next time you transfer pictures from your camera to the computer, use the Camera Favorites Wizard/Assistant to either recreate your Camera Favorites Album or to turn off the Camera Favorites feature.*

## Printing and emailing favorites

- 1 Turn the Mode dial to Favorites . Press /  to locate a picture.
- 2 Press the Share button.
- 3 Highlight Print  or Email , then press the OK button.

NOTE: Favorites that were taken on this camera (not imported from another source) are good for prints up to 4 x 6 in. (10 x 15 cm).

# 5 Troubleshooting

For step-by-step product support, visit [www.kodak.com/go/c643support](http://www.kodak.com/go/c643support) or [www.kodak.com/go/c603support](http://www.kodak.com/go/c603support) and select Interactive Troubleshooting & Repairs.

## Camera problems

If...	Try one or more the following
Camera does not turn on.	<ul style="list-style-type: none"><li>■ Install new batteries (page 1).</li><li>■ Charge rechargeable batteries.</li></ul>
Camera does not turn off.	<ul style="list-style-type: none"><li>■ Remove the battery, then reinsert or replace it. If the cameras still does not function, visit <a href="http://www.kodak.com/go/c643support">www.kodak.com/go/c643support</a> or <a href="http://www.kodak.com/go/c603support">www.kodak.com/go/c603support</a> and select Interactive Troubleshooting &amp; Repairs</li></ul>
Pictures remaining number does not decrease after taking a picture.	<ul style="list-style-type: none"><li>■ The camera is operating normally. Continue taking pictures.</li><li>■ Use the Refresh feature on your camera dock series 3 or printer dock series 3.</li></ul>
Short battery life with Kodak Ni-MH rechargeable digital camera batteries.	<ul style="list-style-type: none"><li>■ Wipe the contacts with a clean, dry cloth (page 55) before loading batteries in the camera.</li></ul>
Stored pictures are corrupted.	<ul style="list-style-type: none"><li>■ Retake picture. Do not remove card while the ready light is blinking. Keep rechargeable batteries charged.</li></ul>
In Review mode, you do not see a picture (or the expected picture) on the LCD screen.	<ul style="list-style-type: none"><li>■ Check the image storage location setting (page 27).</li></ul>

If...	Try one or more the following
In Review mode, a blue or black screen is displayed instead of a picture.	<ul style="list-style-type: none"> <li>■ Transfer the picture to the computer (page 13), then format the card in the camera (page 29).</li> </ul> <p><b>Caution: Formatting a card deletes all pictures and videos, including protected files.</b></p>
Shutter button does not work.	<ul style="list-style-type: none"> <li>■ Turn on the camera (page 2).</li> <li>■ Wait until the ready light stops blinking red before attempting to take another picture.</li> <li>■ Transfer pictures to the computer (page 13), delete pictures from the camera (page 13), switch image storage locations (page 27), or insert a card with available memory (page 3).</li> <li>■ For best pictures, see page 4.</li> </ul>
Slide show does not run on external video device.	<ul style="list-style-type: none"> <li>■ Adjust the camera Video Out setting (NTSC or PAL, page 27).</li> <li>■ See the external device's user's guide.</li> </ul>
Picture is too light.	<ul style="list-style-type: none"> <li>■ Move so there is at least 24 in. (0.6 m) between camera and subject.</li> <li>■ Decrease Exposure Compensation (page 27).</li> </ul>
Picture is not clear.	<ul style="list-style-type: none"> <li>■ Clean the lens (page 55).</li> <li>■ Move so there is at least 24 in. (0.6 m) between the camera and the subject.</li> <li>■ Place the camera on a flat, steady surface or use a tripod.</li> </ul>
Picture is too dark.	<ul style="list-style-type: none"> <li>■ Turn on the flash (page 8).</li> <li>■ Move so there is no more than 7.9 ft (2.4 m) between the camera and the subject.</li> <li>■ Use Fill flash (page 8) or change your position so light is not behind the subject.</li> <li>■ Increase Exposure Compensation (page 27).</li> </ul>

If...	Try one or more the following
Camera does not recognize SD/MMC card.	<ul style="list-style-type: none"> <li>■ Purchase a certified SD/MMC card.</li> <li>■ Reformat the card (page 27).</li> </ul> <p><b>Caution: Formatting a card deletes all pictures and videos, including protected files.</b></p> <ul style="list-style-type: none"> <li>■ Insert a card into the slot, then push to seat (page 3).</li> </ul>
Camera freezes up when a card is inserted or removed.	<ul style="list-style-type: none"> <li>■ Turn the camera off, then back on. Make sure the camera is turned off before inserting or removing a card.</li> </ul>
Memory card full.	<ul style="list-style-type: none"> <li>■ Insert a new card (page 3), transfer pictures to the computer (page 13), or delete pictures (page 11).</li> </ul>
Memory card and internal memory full.	<p>Transfer pictures to the computer (page 13), then format the card or internal memory (page 27).</p> <p>Caution: Formatting a card deletes all pictures and videos, including protected files.</p>

## Camera ready light status

If...	Try one or more of the following
Ready light does not turn on and the camera does not work.	<ul style="list-style-type: none"> <li>■ Turn on the camera (page 2).</li> <li>■ Install new batteries (page 1) or charge rechargeable batteries.</li> <li>■ Turn camera off, then back on.</li> </ul>
Ready light blinks green.	<ul style="list-style-type: none"> <li>■ Camera is operating normally.</li> </ul>
Ready light blinks amber.	<ul style="list-style-type: none"> <li>■ Wait. Resume picture taking when the light stops blinking and turns green.</li> </ul>
Ready light blinks red and camera turns off.	<ul style="list-style-type: none"> <li>■ Install new batteries (page 1) or charge rechargeable batteries.</li> </ul>



If...	Try one or more of the following
Ready light glows steady red.	<ul style="list-style-type: none"> <li>■ Transfer pictures to the computer (page 13), delete pictures from the camera (page 11), switch image storage locations (page 27), or insert a card with available memory (page 3).</li> <li>■ Wait. Resume picture taking when the light turns green.</li> <li>■ Change the image storage location to internal memory (page 27), or use a different card.</li> </ul>
Ready light glows steady green.	<ul style="list-style-type: none"> <li>■ Camera is operating normally.</li> </ul>

## Camera/computer communications

If...	Try one or more of the following
The computer does not communicate with the camera.	<ul style="list-style-type: none"> <li>■ Visit <a href="http://www.kodak.com/go/c643support">www.kodak.com/go/c643support</a> or <a href="http://www.kodak.com/go/c603support">www.kodak.com/go/c603support</a>.</li> <li>■ Turn on the camera (page 2).</li> <li>■ Install new batteries (page 1) or charge rechargeable batteries.</li> <li>■ See the Power Management section of the laptop user's guide to disable this feature.</li> <li>■ Connect cable to camera and computer port (page 13).</li> <li>■ Install the software (page 12).</li> <li>■ Disconnect the USB cable. Close all open applications. Re-install the software (page 12).</li> <li>■ Disconnect camera from the computer. Close all software applications, reconnect camera.</li> </ul>
Cannot transfer pictures. (The Add New Hardware Wizard cannot locate drivers.)	<ul style="list-style-type: none"> <li>■ Disconnect USB cable. (If using camera dock or printer dock, disconnect cable and remove camera from dock). Close all open applications. Re-install the software (page 12).</li> <li>■ Disconnect the USB cable. Close all open applications. Re-install the software (page 12).</li> </ul>

## LCD screen messages

If...	Try one or more of the following
No images to display	<ul style="list-style-type: none"> <li>■ Change image storage location setting (page 27).</li> </ul>
Memory card requires formatting	<ul style="list-style-type: none"> <li>■ Insert a new card (page 3) or format the card (page 27).</li> </ul> <p><b>Caution: Formatting a card deletes all pictures and videos, including protected files.</b></p>
Memory card cannot be read (Please format memory card or insert another card)	
Only one USB connection allowed. Disconnect cable or rem. (remove) camera from dock.	<ul style="list-style-type: none"> <li>■ Unplug the USB cable from the camera.</li> </ul>
Internal memory requires formatting	<ul style="list-style-type: none"> <li>■ Format the internal memory (page 27).</li> </ul> <p><b>Caution: Formatting deletes all pictures and videos, including protected files. (Formatting internal memory also deletes email addresses, album names, and Favorites. To restore them, see the Kodak EasyShare software Help.)</b></p>
Internal memory cannot be read (Please format internal memory)	
No memory card (Files not copied)	<ul style="list-style-type: none"> <li>■ Insert a card (page 3).</li> </ul>
Not enough space to copy files (Files not copied)	<ul style="list-style-type: none"> <li>■ Delete pictures from the image storage location you are copying to (page 11), or insert a new card (page 3).</li> </ul>

If...	Try one or more of the following
<p>Memory card is locked (Insert new memory card)</p> <p>Read-only memory card.</p> <p>Remove write protection to capture or write to card.</p>	<ul style="list-style-type: none"> <li>■ Insert a new card (page 3), move the switch on the card to unlock the card, or change the image storage location to internal memory (page 27).</li> </ul>
<p>Memory card is unusable (Insert new memory card)</p>	<ul style="list-style-type: none"> <li>■ Insert a new card (page 3) or format the card (page 27).</li> </ul> <p><b>Caution: Formatting a card deletes all pictures and videos, including protected files.</b></p>
<p>Date and time have been reset</p>	<ul style="list-style-type: none"> <li>■ Reset the clock (page 2).</li> </ul>
<p>No address book on camera (Connect with computer to import address book)</p>	<ul style="list-style-type: none"> <li>■ Create and copy address book from computer. See the Kodak EasyShare software Help.</li> </ul>
<p>No album names on camera (Connect with computer to import album names)</p>	<ul style="list-style-type: none"> <li>■ Create and copy album names from computer. See the Kodak EasyShare software Help.</li> </ul>
<p>High camera temperature. (Camera will be turned off.)</p>	<ul style="list-style-type: none"> <li>■ Leave the camera off until it's cool to the touch, then turn it back on. If the message reappears, visit <a href="http://www.kodak.com/go/c643support">www.kodak.com/go/c643support</a> or <a href="http://www.kodak.com/go/c603support">www.kodak.com/go/c603support</a> and select Interactive Troubleshooting &amp; Repairs.</li> </ul>

<b>If...</b>	<b>Try one or more of the following</b>
Can only mark image with 32 album names. Only the first 32 album names will be saved	■ Delete one or more album names associated with the image (page 33).
Unrecognized file format	■ Transfer the picture to the computer (page 13), or delete it (page 11).
Camera error #XXXX. See user's guide.	Turn camera off, then back on. If the message reappears, visit <a href="http://www.kodak.com/go/c643support">www.kodak.com/go/c643support</a> or <a href="http://www.kodak.com/go/c603support">www.kodak.com/go/c603support</a> and select Interactive Troubleshooting & Repairs.

# 6 Getting help

## Helpful links

### Camera

Email Kodak customer support	<a href="http://www.kodak.com/go/c643support">www.kodak.com/go/c643support</a> or <a href="http://www.kodak.com/go/c603support">www.kodak.com/go/c603support</a>
Get support for your product (FAQs, troubleshooting information, arrange for repairs, etc.)	<a href="http://www.kodak.com/go/c643support">www.kodak.com/go/c643support</a> or <a href="http://www.kodak.com/go/c603support">www.kodak.com/go/c603support</a>
Purchase camera accessories (camera docks, printer docks, lenses, cards, etc.)	<a href="http://www.kodak.com/go/c643accessories">www.kodak.com/go/c643accessories</a> or <a href="http://www.kodak.com/go/c603accessories">www.kodak.com/go/c603accessories</a>
Download the latest camera firmware and software	<a href="http://www.kodak.com/go/c643downloads">www.kodak.com/go/c643downloads</a> or <a href="http://www.kodak.com/go/c603downloads">www.kodak.com/go/c603downloads</a>
See online demonstrations of your camera	<a href="http://www.kodak.com/go/howto">www.kodak.com/go/howto</a>

### Software

Get information on EasyShare software	<a href="http://www.kodak.com/go/easysharesw">www.kodak.com/go/easysharesw</a> (or click the Help button in EasyShare software)
Get help with the Windows operating system and working with digital pictures	<a href="http://www.kodak.com/go/pcbasics">www.kodak.com/go/pcbasics</a>

### Other

Get support for other cameras, software, accessories	<a href="http://www.kodak.com/go/support">www.kodak.com/go/support</a>
Get information on Kodak EasyShare printer docks	<a href="http://www.kodak.com/go/printerdocks">www.kodak.com/go/printerdocks</a>
Get information on Kodak inkjet products	<a href="http://www.kodak.com/go/inkjet">www.kodak.com/go/inkjet</a>
Optimize your printer for truer, more vibrant colors	<a href="http://www.kodak.com/go/onetouch">www.kodak.com/go/onetouch</a>
Register your camera	<a href="http://www.kodak.com/go/register">www.kodak.com/go/register</a>

## Telephone customer support

If you have questions concerning this product, contact your customer support representative and have this information available:

- Operating system
- Processor speed (MHz)
- Computer model
- Amount of memory (MB)
- Exact error message you received
- Version of Kodak EasyShare software CD
- Camera serial number

Australia	1800 147 701
Austria	0179 567 357
Belgium	02 713 14 45
Brazil	0800 150000
Canada	1 800 465 6325
China	800 820 6027
Denmark	3 848 71 30
Ireland	01 407 3054
Finland	0800 1 17056
France	01 55 1740 77
Germany	069 5007 0035
Greece	00800 44140775
Hong Kong	800 901 514
India	91 22 617 5823
Italy	02 696 33452
Japan	03 5540 9002
Korea	00798 631 0024

Netherlands	020 346 9372
New Zealand	0800 440 786
Norway	23 16 21 33
Philippines	1 800 1 888 9600
Poland	00800 4411625
Portugal	021 415 4125
Singapore	800 6363 036
Spain	91 749 76 53
Sweden	08 587 704 21
Switzerland	01 838 53 51
Taiwan	0800 096 868
Thailand	001 800 631 0017
Turkey	00800 448827073
United Kingdom	0870 243 0270
United States	1 800 235 6325 585 781 6231 (toll)
International Toll Line	+44 131 458 6714
International Toll Fax	+44 131 458 6962

For the most up-to-date listings, visit: [www.kodak.com/include/international.shtml](http://www.kodak.com/include/international.shtml)

# 7 Appendix

## Camera specifications

For more specifications, visit [www.kodak.com/go/c643support](http://www.kodak.com/go/c643support) or [www.kodak.com/go/c603support](http://www.kodak.com/go/c603support).

<b>Kodak EasyShare C643/C603 digital camera</b>	
<b>CCD</b> (charge-coupled device)	
CCD	1/2.5 in. CCD, 4:3 aspect ratio
Output image size	6.1 MP: 2848 x 2134 pixels 5.4 MP (3:2): 2848 x 1896 pixels 4.0 MP: 2304 x 1728 pixels 1.9 MP: 1600 x 1200 pixels 0.8 MP: 1024 x 768 pixels
<b>Displays</b>	
Color display	6.1 cm (2.4 in) color hybrid LCD, 112 K pixels
Preview	Frame rate: 30 fps; Field-of-view: 100%.
<b>Lens</b>	
Taking lens	3X optical zoom lens f/2.7 - f/4.8 Aperture: maximum - f/2.7; minimum - f/8.5 36 mm - 108 mm (35 mm equivalent)
Lens barrier	Automatic built-in
Focus system	TTL-AF; Multi-zone AF, and Center-zone AF. Working range: 0.6 m (24 in.)-infinity @ normal 0.13 - 0.7 m (5.1-27.6 in.) @ wide close-up 0.22 - 0.7 m (8.7-27.6 in.) @ telephoto close-up 10 m (32.8 ft.)-infinity @ Landscape

<b>Kodak EasyShare C643/C603 digital camera</b>	
Digital zoom	5.0X continuous with 0.2X increments Not supported for movie capture
<b>Exposure</b>	
Exposure metering	TTL-AE; Center-weighted
Exposure compensation	+/-2.0 EV with 0.5 EV step
Shutter speed	Mechanical shutter with CCD electrical Auto: 4 - 1/1400 sec.
ISO speed	Auto, Portrait, Close-up, Landscape: 80 - 160; Sport: 80 - 200; Night Portrait, Long Time Exposure: 80 Selectable: 80, 100, 200, 400, 800 (800 available only for smallest picture size setting)
<b>Flash</b>	
Electronic flash	Guide no. 8.5 (@ ISO 100) Auto flash with pre-flash Working range at ISO 140: 0.6-3.6 m (2-11.8 ft.) @ Wide 0.6-2.1 m (2-6.9 ft.) @ Tele
Flash modes	Auto, Fill, Red-eye, Off
<b>Capture</b>	
Capture modes	Auto, Landscape, Close-up, SCN (Scene Modes), Video
Video capture	VGA (640 x 480) @ 30 fps QVGA (320 x 240) @ 30 fps
Image file format	Still: EXIF 2.21 (JPEG compression); file organization: DCF Video: QuickTime (CODEC MPEG4)
Image storage	Optional SD/MMC Card  . (The SD logo is a trademark of the SD Card Association.)
Internal storage capacity	32 MB internal memory/28 MB available for image storage (1 MB equals one million bytes)



<b>Kodak EasyShare C643/C603 digital camera</b>	
<b>Review</b>	
Quickview	Yes
Video output	NTSC or PAL selectable
<b>Power</b>	
2 Kodak oxy-alkaline digital camera batteries AA ZR6 (non-rechargeable); 2-AA lithium digital camera batteries; 2-AA alkaline batteries; 2 Kodak Ni-MH rechargeable digital camera batteries AA; 1 Kodak lithium digital camera battery CRV3 (non-rechargeable); 1 Kodak Ni-MH rechargeable digital camera battery KAA2HR, 3V AC adapter	
<b>Communication with computer</b>	
USB 2.0 (PIMA 15740 protocol), via USB cable model U-8, EasyShare camera dock or printer dock	
<b>Other features</b>	
PictBridge support	Yes
Self Timer	2 seconds, 10 seconds, or 2-shot
White balance	Auto, Daylight, Tungsten, Fluorescent
Auto power off	Selectable 1, 3, 5, 10 minutes
Color modes	Color, Black & White, Sepia
Date stamp	None, YYYY/MM/DD, MM/DD/YYYY, DD/MM/YYYY
Tripod mount	1/4 inch
Viewfinder	Optical, real-image; 83% field of view
Operating temperature	32-104°F (0-40°C)
Size	32.4 mm (1.3 in.) x 65.7 mm (2.6 in.) x 92.2 mm (3.6 in.) @ power off
Weight	145 g (5.1 oz.) without battery or card

## Storage capacities

Actual storage capacity varies depending on subject composition, card brand, and other factors. You may be able to store more or fewer pictures and videos. Favorites take up additional space in internal memory.

### Picture storage capacity

	Number of pictures				
	6.1 MP	5.4 MP (3:2)	4.0 MP	1.9 MP	0.8 MP
Internal memory	25	28	39	71	151
32 MB SD/MMC	28	32	44	80	170
64 MB SD/MMC	56	64	88	160	340
128 MB SD/MMC	112	128	176	320	680
256 MB SD/MMC	224	256	352	640	1360
512 MB SD/MMC	448	512	704	1280	2720
1 GB MB SD/MMC	896	1024	1408	2560	4000

### Video storage capacity

	Minutes/seconds of video	
	VGA (640 x 480)	QVGA (320 x 240)
Internal memory	1 min. 11 sec.	4 min. 05 sec.
32 MB SD/MMC	1 min. 20 sec.	4 min. 36 sec.
64 MB SD/MMC	2 min. 41 sec.	9 min. 13 sec.
128 MB SD/MMC	5 min. 22 sec.	18 min. 26 sec.
256 MB SD/MMC	10 min. 44 sec.	36 min. 52 sec.
512 MB SD/MMC	21 min. 24 sec.	73 min. 44 sec.
1 GB MB SD/MMC	42 min. 48 sec.	147 min. 28 sec.

## Important safety instructions



### CAUTION:

Do not disassemble this product; there are no user-serviceable parts inside. Refer servicing to qualified service personnel. Do not expose this product to liquid, moisture, or extreme temperatures. Kodak AC adapters and battery chargers are intended for indoor use only. The use of controls, adjustments, or procedures other than those specified herein may result in exposure to shock and/or electrical or mechanical hazards. If the LCD breaks, do not touch the glass or liquid. Contact Kodak customer support.

## Using this product

- The use of an accessory attachment that is not recommended by Kodak, such as an AC adapter, may cause fire, electric shock, or injury.
- Use only a USB-certified computer. Contact your computer manufacturer if you have questions.
- If using this product in an airplane, observe all instructions of the airline.

## Battery safety and handling



### CAUTION:

**When removing the battery, allow it to cool; it may be hot.**

- Use only batteries approved for this product to avoid risk of explosion.
- Keep batteries out of the reach of children.
- Do not allow batteries to touch metal objects, including coins. Otherwise, a battery may short circuit, discharge energy, become hot, or leak.
- Do not disassemble, install backward, or expose batteries to liquid, moisture, fire, or extreme temperature.
- Do not charge non-rechargeable batteries.

- Remove the battery when the product is stored for an extended period of time. In the unlikely event that battery fluid leaks inside the product, contact Kodak customer support.
- In the unlikely event that battery fluid leaks onto your skin, wash immediately with water and contact your local health provider. For additional health-related information, contact your local Kodak customer support.
- Dispose of batteries according to local and national regulations.

For more information on batteries, see

[www.kodak.com/global/en/service/batteries/batteryUsage.jhtml](http://www.kodak.com/global/en/service/batteries/batteryUsage.jhtml)

## Battery life

Use these Kodak batteries. (Battery types are also molded into the battery door.)

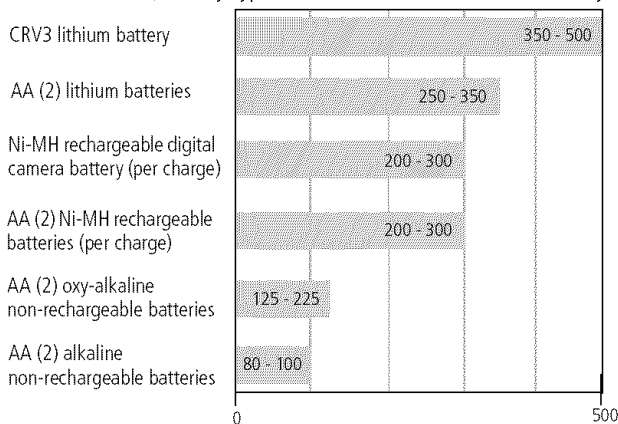

Battery life per CIPA testing method (Approx. number of pictures in Auto mode, using 128 MB SD card.). Actual life may vary based on usage.

For acceptable battery life, and to make sure your camera operates dependably, use the batteries listed.

## Extending battery life

- See Auto Power Off on page 27.
- Limit the following activities that quickly deplete battery power:
  - Reviewing your pictures on the LCD (see page 5)
  - Using the LCD as a viewfinder (see page 7)
  - Excessive use of the flash
- Dirt on the battery contacts can affect battery life. Wipe the contacts with a clean, dry cloth before loading batteries in the camera.
- Battery performance is reduced at temperatures below 41° F (5° C). When using your camera in cold weather, carry spare batteries and keep them warm. Do not discard cold batteries that do not work; when they return to room temperature, they may be usable.

## Upgrading your software and firmware

Download the latest versions of the software included on the Kodak EasyShare software CD and the camera firmware (the software that runs on the camera). See [www.kodak.com/go/c643downloads](http://www.kodak.com/go/c643downloads) or [www.kodak.com/go/c603downloads](http://www.kodak.com/go/c603downloads).

## Additional care and maintenance

- If the camera has been subjected to inclement weather or you suspect water has gotten inside the camera, turn off the camera and remove the battery and card. Allow all components to air-dry for at least 24 hours before using the camera again.
- Blow gently on the lens or LCD to remove dust and dirt. Wipe gently with a soft, lint-free cloth or an untreated lens-cleaning tissue. Do not use cleaning solutions unless designed specifically for camera lenses. Do not allow chemicals, such as suntan lotion, to contact painted surfaces.

- Service agreements may be available in your country. Contact a dealer of Kodak products for more information.
- For digital camera disposal or recycling information, contact your local authorities. In the US, visit the Electronics Industry Alliance Web site at [www.eiae.org](http://www.eiae.org) or the Kodak Web site at [www.kodak.com/go/c643downloads](http://www.kodak.com/go/c643downloads) or [www.kodak.com/go/c603downloads](http://www.kodak.com/go/c603downloads).

## Warranty

### Limited warranty

Kodak warrants Kodak EasyShare digital cameras and accessories (excluding batteries) to be free from malfunctions and defects in both materials and workmanship for one year from the date of purchase.

Retain the original dated sales receipt. Proof of the date of purchase will be required with any request for warranty repair.

### Limited warranty coverage

This limited warranty will be honored only within the geographical location that Kodak digital cameras and accessories were purchased.

Kodak will REPAIR or REPLACE Kodak EasyShare digital cameras and accessories if they fail to function properly during the warranty period, subject to any conditions and/or limitations stated herein. Such repair service will include all labor as well as any necessary adjustments and/or replacement parts. Such repair or replacement is the sole remedy under this warranty.

If replacement parts are used in making repairs, these parts may be remanufactured, or may contain remanufactured materials. If it is necessary to replace the entire product, it may be replaced with a remanufactured product.

## Limitations

Request for Warranty service will not be accepted without proof of date of purchase, such as a copy of the original dated Kodak EasyShare digital camera or accessory sales receipt. (Always keep the original for your records.)

This warranty does not apply to the battery(s) used in digital cameras or accessories. This warranty does not cover circumstances beyond Kodak's control, nor problems caused by failure to follow the operating instructions in the Kodak EasyShare digital cameras and accessories User's Guides.

This warranty does not apply when failure is due to shipping damage, accident, alteration, modification, unauthorized service, misuse, abuse, use with incompatible accessories or attachments, failure to follow Kodak's operation, maintenance or repacking instructions, failure to use items supplied by Kodak (such as adapters and cables), or claims made after the duration of this warranty.

Kodak makes no other express or implied warranty for this product. In the event that the exclusion of any implied warranty is ineffective under the law, the duration of the implied warranty will be one year from the purchase date.

The option of replacement is Kodak's only obligation. Kodak will not be responsible for any special, consequential or incidental damages resulting from the sale, purchase, or use of this product, regardless of the cause. Liability for any special, consequential or incidental damages (including but not limited to loss of revenue or profit, downtime costs, loss of the use of the equipment, cost of substitute equipment, facilities or services, or claims of your customers for such damages resulting from the purchase, use or failure of the product), regardless of cause or for breach of any written or implied warranty is expressly disclaimed and excluded herefrom.

## Your rights

Some states or jurisdictions do not allow exclusion or limitation of incidental or consequential damages, so the above limitation or exclusion may not apply to you. Some states or jurisdictions do not allow limitations on how long an implied warranty lasts, so the above limitation may not apply to you.

This warranty gives you specific rights, and you may have other rights which vary from state to state or by jurisdiction.

## Outside the United States and Canada

In countries other than the United States and Canada, the terms and conditions of this warranty may be different. Unless specific Kodak warranty is communicated to the purchaser in writing by a Kodak company, no warranty or liability exists beyond any minimum requirements imposed by law, even though defect, damage, or loss may be by negligence or other act.

## Regulatory compliance

### FCC compliance and advisory



Kodak EasyShare C643/C603 zoom digital camera

This equipment has been tested and found to comply with the limits for a Class B digital device, pursuant to Part 15 of the FCC Rules. These limits are designed to provide reasonable protection against harmful interference in a residential installation.

This equipment generates, uses, and can radiate radio frequency energy and, if not installed or used in accordance with the instructions, may cause harmful interference to radio communications. However, there is no guarantee that interference will not occur in a particular installation.

If this equipment does cause harmful interference to radio or television reception, which can be determined by turning the equipment off and on, the user is encouraged to try to correct the interference by one or more of the following measures: 1) reorient or relocate the receiving antenna; 2) increase the separation between the equipment and the receiver; 3) connect the equipment to an outlet on a circuit different from that to which the receiver is connected; 4) consult the dealer or an experienced radio/TV technician for additional suggestions.



Any changes or modifications not expressly approved by the party responsible for compliance could void the user's authority to operate the equipment. Where shielded interface cables have been provided with the product or specified additional components or accessories elsewhere defined to be used with the installation of the product, they must be used in order to ensure compliance with FCC regulation.

## Australian C-Tick



## Canadian DOC statement

**DOC Class B Compliance**—This Class B digital apparatus complies with Canadian ICES-003.

**Observation des normes-Class B**—Cet appareil numérique de la classe B est conforme à la norme NMB-003 du Canada.

## Waste Electrical and Electronic Equipment labeling



In the European Union, do not discard this product as unsorted municipal waste. Contact your local authorities or go to [www.kodak.com/go/recycle](http://www.kodak.com/go/recycle) for recycling program information.

## Korean Class B ITE

이 기기는 가정용으로 전자파적합등록을 한 기기로서 주거지역에서는 물론 모든 지역에서 사용할 수 있습니다.

English translation: As this equipment has obtained EMC registration for household use, it can be used in any area including residential areas.

## VCCI Class B ITE

この装置は、情報処理装置等電波障害自主規制協議会（VCCI）の基準に基づきクラスB情報技術装置です。この装置は、家庭環境で使用することを目的としていますが、この装置がラジオやテレビジョン受信機に近接して使用されると、受信障害を引き起こすことがあります。  
取扱説明書に従って正しい取り扱いをして下さい。

English translation: This is a Class B product based on the standard of the Voluntary Control Council for Interference from Information Technology Equipment (VCCI). If this is used near a radio or television receiver in a domestic environment, it may cause radio interference. Install and use the equipment according to the instruction manual.

## MPEG-4

Use of this product in any manner that complies with the MPEG-4 visual standard is prohibited, except for use by a consumer engaging in personal and non-commercial activities.

---

# Index

## A

- A/V out, 30
- AA battery, loading, 1
- about picture, video, 31
- about this camera, 29
- accessories, 13
  - battery, 55
  - buying, 47
  - printer dock, 14
  - SD/MMC card, 3
- album
  - set, 25
  - tagging pictures, 32
- appendix, 49
- auto, 19
  - flash, 8
  - focus framing marks, 7

## B

- backlight, 20
- batteries
  - expected life, 54
  - extending life, 55
  - loading, 1
  - types, 51, 54
- battery
  - safety, 53
- battery compartment, ii
- battery life, 54
- beach, 20
- blur, 5
- blur warning, 28

- burst button, i
- burst, using, 22
- button
  - burst, i, 22
  - delete, ii, 5
  - flash, flash button, i
  - flash/status, 8
  - info, ii
  - LCD/Info, ii
  - menu, ii
  - OK, ii
  - review, ii, 9
  - self-timer, self-timer button, i
  - Share, ii
  - shutter, i
  - telephoto, ii
  - wide angle, ii
  - zoom, 18

## C

- cable
  - audio/video, 30
  - USB, 13
- camera screen
  - error messages, 44
  - reviewing videos, 9
- camera sounds, 27
- caring for your camera, 55
- caution
  - formatting, 11
- children, 20
- Class B ITE, 59

clock, setting, 2  
color mode, 25  
compatibility, dock, 17  
copy pictures  
    card to memory, 32  
    memory to card, 32  
    to computer, 12  
cropping pictures, 31  
CRV3 battery  
    loading, 1  
customer support, 47  
customizing camera settings, 27

## D

date setting, 2  
date stamp, 28  
DC-in, i  
delete button, ii  
deleting  
    during quickview, 5  
    pictures, videos, 11  
    protecting pictures, videos, 11  
digital zoom, using, 18  
displaying slide show, 29  
disposal, recycling, 56, 59  
dock  
    connector, ii  
    printer, 14  
dock compatibility, 17  
doing more with your camera, 18  
download pictures, 12

## E

EasyShare software

installing, 12  
emailing pictures, videos, 35  
error messages, 44  
expected battery life, 54  
exposure  
    compensation, 21  
    long time, 25  
exposure bracketing, 23  
exposure compensation, 23  
external video device  
    viewing pictures, videos, 30

## F

favorites  
    removing, 38  
    settings, 38  
    tagging, 37  
fireworks, 20  
firmware, upgrading, 55  
flash  
    settings, 8  
focus  
    framing marks, 7  
    zone, 25  
format, 29  
formatting  
    caution, 11

## G

guidelines, battery, 55

## H

help, 40  
    camera, 40  
    web links, 47

**I**

- icon
  - blur, 5
- icons
  - picture-taking, 6
  - reviewing pictures, 10
- icons, mode dial, 19
- image storage, 26
- info button, ii
- information
  - about pictures, videos, 31
- installing
  - batteries, 1
  - SD/MMC card, 3
  - software, 12
- internal memory
  - storage capacity, 52
- interval, slide show, 30

**K**

- Kodak EasyShare software
  - upgrading, 55
- Kodak web sites, 47
- Korean Class B ITE, 59

**L**

- LCD, ii
- LCD/Info button, ii
- lens
  - cleaning lens, 55
- light
  - ready, 42
- light sensor, i
- liveview, 27

- loading
  - batteries, 1
  - SD/MMC card, 3
  - software, 12
- long time exposure, 25
- loop, slide show, 30

**M**

- Macintosh, installing software on, 12
- magnify picture, 9
- maintenance, camera, 55
- memory
  - full, 26
  - inserting card, 3
  - storage capacities, 52
- memory plus, 26
- menu button, ii
- microphone, i
- mode dial, i, 19
- modes
  - auto, 19
  - backlight, 20
  - beach, 20
  - children, 20
  - fireworks, 20
  - night portrait, 20
  - party, 20
  - SCN, 19
  - self-portrait, 20
  - snow, 20
  - text, 20
- multi-up, 9

## N

night portrait, 20

## O

OK button, ii

online prints, ordering, 16

optical zoom, 18

orientation sensor, 28

## P

party, 20

PictBridge enabled printer, 14

picture

    magnify, 9

picture size, 24

pictures

    copying, 32

    cropping, 31

    deleting, 11

    emailing tagged, 35

    printing, 15

    protecting, 11

    reviewing, 9

    storage capacity, 52

    tagging, 32

    taking, modes, 19

    transfer, 12

picture-taking settings, 23

power

    camera, 2

power light, i

printer dock, 14

printing

    from a card, 16

    from computer, 15

    optimizing printer, 47

    order online, 16

    PictBridge technology, 14

    tagged pictures, 16

    with EasyShare printer dock, 14

problem-solving, 40

protecting pictures, videos, 11

## Q

quickview

    using, 5

## R

ready light, 42

recycling, disposal, 56, 59

red-eye, flash, 8

regulatory information, 58

    Class B ITE, 59

removing favorites, 38

repair, 47

return, 27

review button, ii, 9

reviewing pictures

    as you take them, 5

    camera screen, 9

reviewing pictures, videos

    slide show, 29

reviewing videos

    camera screen, 9

running slide show, 29

## S

safety, battery, 53

scene modes, 20

- SCN, 19
- SD/MMC card
  - inserting, 3
  - printing from, 16
  - slot, ii
  - storage capacities, 52
- self-portrait, 20
- self-timer
  - with pictures, 21
- setting
  - about, 29
  - album, 25
  - blur warning, 28
  - camera sounds, 27
  - color mode, 25
  - date and time, 2
  - date stamp, 28
  - exposure bracketing, 23
  - exposure compensation, 23
  - flash, 8
  - focus zone, 25
  - image storage, 26
  - liveview, 27
  - long time exposure, 25
  - orientation sensor, 28
  - picture size, 24
  - picture taking mode, 19
  - return, 27
  - self-timer, 21
  - setup menu, 26
  - sound volume, 27
  - video date display, 28
  - video out, 28
  - video size, 26
  - white balance, 24
- settings
  - picture taking, 23
- setup menu, 26
- setup mode, using, 27
- shaking hand, 5
- Share button, ii
- sharing pictures, videos, 34
- shutter
  - problems, 41
  - self-timer delay, 21
- shutter button, i
- slide show
  - continuous loop, 30
  - interval, 30
  - problems, 41
  - running, 29
- snow, 20
- software
  - installing, 12
  - upgrading, 55
- sound volume, 27
- sounds, 27
- specifications, camera, 49
- status
  - blur, 5
  - camera ready light, 42
- storage capacity, 52
- storage location
  - switching, 26
- support, technical, 47
- switching storage location, 26

## T

- tagging
  - favorites, 37
  - for albums, 32
  - for email, 35
  - for print, 35
- taking a picture, 4
- taking a video, 4
- telephoto button, ii
- television, slide show, 30
- text, 20
- thumbnails, 9
- time, setting, 2
- timer, shutter delay, 21
- transferring pictures, videos, 12
- trash can, deleting, 5
- tripod socket, ii
- troubleshooting, 40
  - camera, 40
  - camera/computer communications, 43
  - error messages, 44
  - ready light status, 42
- turning camera on and off, 2

## U

- undelete, 11
- undo, 11
- upgrading software, firmware, 55
- URLs, Kodak web sites, 47
- USB cable, 13
- USB, A/V out, ii

## V

- VCCI compliance, 60
- video
  - copying, 32
  - date display, 28
  - out, 28
  - protecting, 11
  - reviewing, 9
  - storage capacities, 52
  - viewing, 9
- video size, 26
- videos
  - deleting, 11
  - emailing tagged, 35
  - transfer, 12
- viewfinder, i
- viewing picture
  - after taking, 5, 9
- volume, 27

## W

- warranty, 56
- WEEE, 59
- white balance, 24
- wide angle button, ii
- Windows OS-based computers
  - installing software, 12
- wrist strap, 1
- wrist strap post, ii

## Z

- zoom
  - digital, 18
  - optical, 18