



Bowflex® TreadClimber® 1000, 3000 & 5000



Owner's Manual



Ver página 2

Español Americano Latino

Preface

CONGRATULATIONS!

Thank you for making the Bowflex® TreadClimber® fitness machine a part of your exercise and fitness activities. For years to come, you will be able to rely on Bowflex® craftsmanship and durability as you pursue your personal fitness goals.

The Bowflex® TreadClimber® fitness machine enables you to shape and monitor your workouts to:

- Increase your energy level
- Increase cardiovascular and aerobic fitness
- Increase your muscle strength
- Decrease your overall percentage of body fat

Whether you are just getting started in an exercise program or are already in good shape, the Bowflex® TreadClimber® fitness machine is designed to be an efficient, easy and fun way to achieve an enhanced level of fitness. Accurately monitor your progress while you exercise your way to a slimmer and healthier body.

This Owner's Manual contains all the information you need to operate and enjoy your Bowflex® TreadClimber® fitness machine. Please read this Owner's Manual before getting onto the Bowflex® TreadClimber® fitness machine and working out.

Take your time and have fun!

To validate warranty support, keep the original proof of purchase and record the following information:

Serial Number _____ **Date of Purchase** _____

To register your product warranty, go to: www.bowflex.com/register
Or call 1 (800) 605-3369.

If you have questions or problems with your product, please call 1 (800) 605-3369.

Español Americano Latino

Para obtener este manual en Español Latino Americano vaya a:
<http://www.bowflex.com>

Nautilus, Inc., (800) NAUTILUS / (800) 628-8458, www.NautilusInc.com - Customer Service: North America (800) 605-3369, tcinquiries@nautilus.com | outside U.S. +01-360-859-5180 | Printed in China | © 2007 Nautilus, Inc., All rights reserved. ™ and ® indicate a trademark or registered trademark. Nautilus, Inc. (www.NautilusInc.com) trademarks include NAUTILUS®, BOWFLEX®, SCHWINN® and UNIVERSAL® and respective logos. Other trademarks are the property of their respective owners.

Table of Contents

Important Safety Instructions	1
Emergency Stop Procedures	2
Grounding Instructions	2
Safety Warning Labels and Serial Number	3
Product Specifications	4
Product Features	5
Care of the Machine	6
Helpful Hints.....	6
Initial Service.....	6
Accessories.....	6
Cleaning.....	6
Inspecting.....	6
Moving and Storage.....	7
Getting Started	8
Before You Start.....	8
Hydraulic Cylinder Adjustment (Workout Level).....	9
Pausing or Stopping.....	10
TC 5000 Displays.....	11
Quick Start.....	11
Remote Heart Module (TC 5000 Only).....	12
Information About Heart Rate Calculations.....	13
TC3000 Features.....	14
TC3000 Displays.....	14
TC1000 Features.....	14
TC1000 Displays.....	14
Setting English or Metric Measurement Units (TC3000 and TC5000).....	15
Workout Instructions	16
Determining Your Fitness Level.....	16
Treadmill Workout.....	18
Locking the Treadles for Treadmill Workout.....	18
Starting a Treadmill Workout.....	19
Starting a Stair-Stepper Workout.....	20
Bowflex® TreadClimber® Workout.....	21
Preliminary TreadClimber® Workout.....	23
Maintenance	25
Routine Maintenance.....	25
Walking Belt and Deck Lubrication.....	25
Walking Belt Adjustment.....	26
Belt Alignment.....	26
Belt Tension.....	26
Walking Belt Electrostatic Reduction.....	27
Speed Sensor Verification (TC1000 only).....	28
Calibration (TC3000 and TC5000 only).....	29
If Calibration Fails (Screen Displays “Cal Fail” Message).....	30
Explanation of Calibration Display Messages (for information only).....	30
Determining Hours Used.....	30
Troubleshooting	31
Hot or Burning Odors.....	31
Getting Access to the TC5000/3000 Motor Control Board (MCB).....	31
Troubleshooting Procedures.....	32
Parts	36
Bowflex® TreadClimber® 100% Satisfaction Guarantee	39

Important Safety Instructions



This icon means a potentially hazardous situation which, if not avoided, could result in death or serious injury.

Before using this equipment, obey the following warnings:



To decrease the risk of burns, electric shock, or injury to persons, read and understand the complete Owner's Manual. Failure to follow these guidelines can cause a serious or possibly fatal electrical shock or other serious injury. Keep Owner's Manual for future reference.

Read and understand all warnings on this machine. If at any time the Warning stickers become loose, unreadable or dislodged, contact Nautilus® Customer Service for replacement stickers.

-  **DANGER** To reduce the risk of electrical shock or unsupervised usage of the equipment, always unplug the power cord from the wall outlet and/or the machine and wait 5 minutes before cleaning, maintaining or repairing the machine. Place the power cord in a secure location.
- Children must not be let on or near to this machine. Moving parts and other features of the machine can be dangerous to children.
- Not intended for use by anyone under 14 years of age.
- Consult a physician before you start an exercise program. Stop exercising if you feel pain or tightness in your chest, become short of breath, or feel faint. Contact your doctor before you use the machine again. Use the values calculated or measured by the machine's computer for reference purposes only.
- Before each use, examine this machine for damage to power cord, power receptacle, loose parts or signs of wear. Do not use if found in this condition. Contact Nautilus® Customer Service for repair information.
- Maximum user weight limit: 300 lb. (136 kg). Do not use if you are over this weight.
- This machine is for home use only.
- Do not wear loose clothing or jewelry. This machine contains moving parts. Do not put fingers or other objects into moving parts of the exercise equipment.
- Always wear rubber soled athletic shoes when you use this machine. Do not use the machine with bare feet or only wearing socks.
- Set up and operate this machine on a solid, level, horizontal surface.
- Use caution when you step on and off the machine. Use the supplied foot support platforms for stability before walking on the moving belt.
- Do not operate this machine outdoors or in moist or wet locations.
- Keep at least 39" (1 m) on each side of the machine and 79" (2 m) behind the machine clear. This is the recommended safe distance for access and passage around and emergency dismounts from the machine. Keep third parties out of this space when machine is in use.
- Do not over exert yourself during exercise. Operate the machine in the manner described in this manual.
- Read, understand, and test the Emergency Stop Procedure before use.
- Keep the walking belt clean and dry.
- Keep power cord away from heat source and hot surfaces.
- Do not drop or put objects into any opening of the machine.

Important Safety Instructions

- Always connect the power cord to a circuit capable of handling 10 amperes with no other loads applied.
- Connect this machine to a correctly grounded outlet; consult a licensed electrician for assistance.
- Do not operate where aerosol products are being used.
- Do not let liquid touch the electronic controller. If it does, the controller must be inspected and tested for safety by an approved technician before it can be used again.
- The electrical wiring for the residence in which the machine will be used must obey the applicable local and provincial requirements.
- This machine is designed for walking. Do not try to run on this machine.

Emergency Stop Procedures

The TreadClimber® machine is equipped with a Safety Key that can prevent serious injury, as well as prevent children from playing with and/or being injured on the machine. If the Safety Key is not fully inserted into the safety keyhole, the TreadClimber® machine will NOT power up.

⚠ To prevent unsupervised operation of the machine, always remove the Safety Key and disconnect the power cord from the wall outlet or AC input.

Always attach the Safety Key clip to your clothing during your workout.

When you use the machine, only remove the Safety Key in an emergency. When the key is removed while the machine is in operation, it will stop quickly, which could cause the loss of balance and possible injury.

Be sure to remove the Safety Key for safe storage when not in operation.

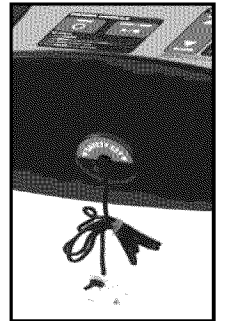

Safety Key with Clip

Grounding Instructions

This product must be electrically grounded. If a malfunction occurs, correct grounding decreases the risk of electric shock. The power cord is equipped with an equipment-grounding conductor, and must be connected to an outlet that is properly installed and grounded.

⚠ DANGER The electrical wiring must comply with all applicable local and provincial requirements. Incorrect connection of the equipment-grounding conductor can result in a risk of electric shock. Consult a licensed electrician if you are not sure that the machine is correctly grounded. Do not change the plug on the machine – if it does not fit the outlet, have a correct outlet installed by a licensed electrician.

If you connect the machine to an outlet with GFI (ground fault interrupt) or AFI (arc fault interrupt), machine operation can cause the circuit to trip.

⚠ If an extension cord or surge protector is used with this machine, make sure that it is a heavy duty model rated at 15A operation, and accepts an equipment-grounding conductor. Do not connect other appliances or devices to the extension cord or surge protector in combination with this machine.

Important Safety Instructions

Safety Warning Labels and Serial Number

Make sure that you have the serial number when you contact Customer Service. Newer models have the serial number on the bottom of the console.

Note: On older models, the console, base, and/or treadle assembly can each have their own serial number label. Look on the bottom of the console, on the base next to the treadle locking lever, or on the treadle assembly below the rear roller.

Safety labels



Serial number

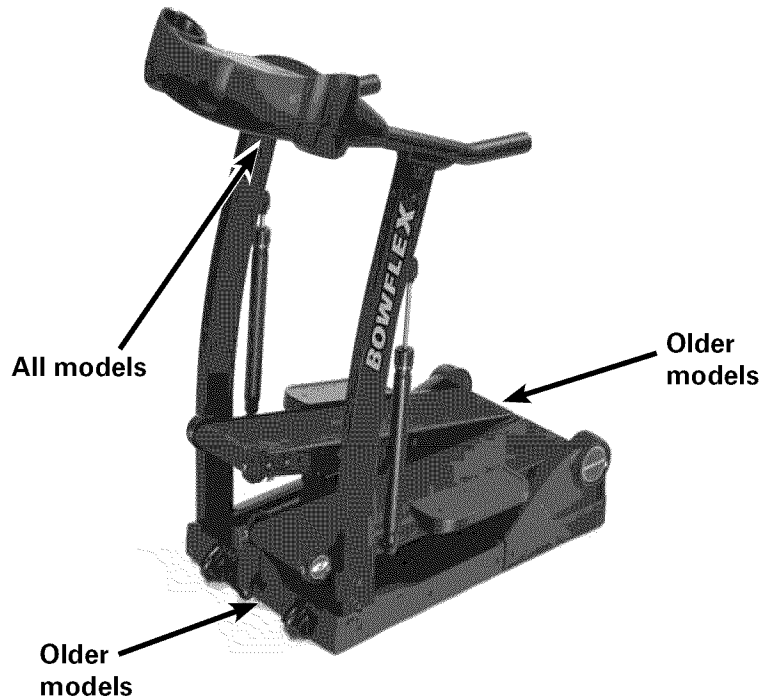

1	WARNING	<ol style="list-style-type: none"> 1. Remove control key when not in use and store out of reach of children. 2. If you feel any unusual chest pain or tightness in your chest, shortness of breath, or dizziness, feel faint or have any discomfort while you exercise, STOP!
	CAUTION	<ol style="list-style-type: none"> 1. To avoid injury, stand on the foot platforms before starting TreadClimber. 2. Read and understand the Owner's Manual and operation instructions prior to use. If you do not have an Owner's Manual, call 800-792-6784 to obtain one. 3. Keep children and pets away. 4. Max user wt. 300 lbs. / 136 kg
2	DANGER	<p>HAZARDOUS VOLTAGE.</p> <p>Contact will cause electric shock or burn.</p> <p>Turn off and Lock out power before servicing.</p>
3	WARNING	<p>Moving parts can crush and cut.</p> <p>Lock out power before servicing.</p>

Product Specifications

Physical Dimensions

Length	46 in. (117 cm)
Width	28.5 in. (72.5 cm)
Height	55.25 in. (140.5 cm)
Assembled Weight	185 lbs. (84 kg)
Shipping Weight	220 lbs. (100 kg)

System Capacities

Maximum Weight Capacity	300 lbs (136 kg)
Speed	
TC1000	0.5 to 3.8 mph (0.8 to 6.1 kmh)
TC3000 and TC5000	0.7 to 4.0 mph (1.1 to 6.4 kmh)
Treadmill Incline	0% grade
Workout Resistance Levels	1 to 12
Warranty Length	See the Warranty sheet for full information per machine type.

Component Specifications

Belt	7.75 in. x 38.5 in. (19.5 cm x 98 cm)
Motor	0.5 hp continuous duty
Frame	Powder-coated steel
Operational Voltage	95 to 130 VAC 50 - 60 Hz
Operational Current	12A Max

Regulatory Approvals Marks

c-ETL-US The standard for **Safety for Motor-Operated Massage and Exercise Machines**
UL 1647, 3rd Ed. and Motor-Operated Appliances
CAN/CSA-C22.2 No. 68-92

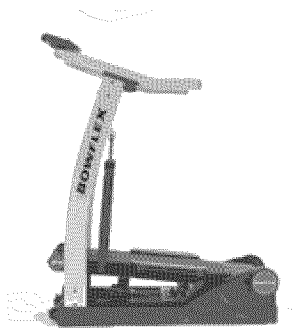

TC1000



TC3000

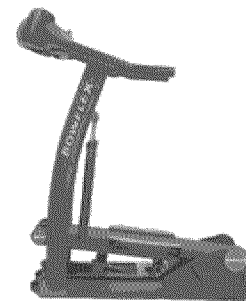

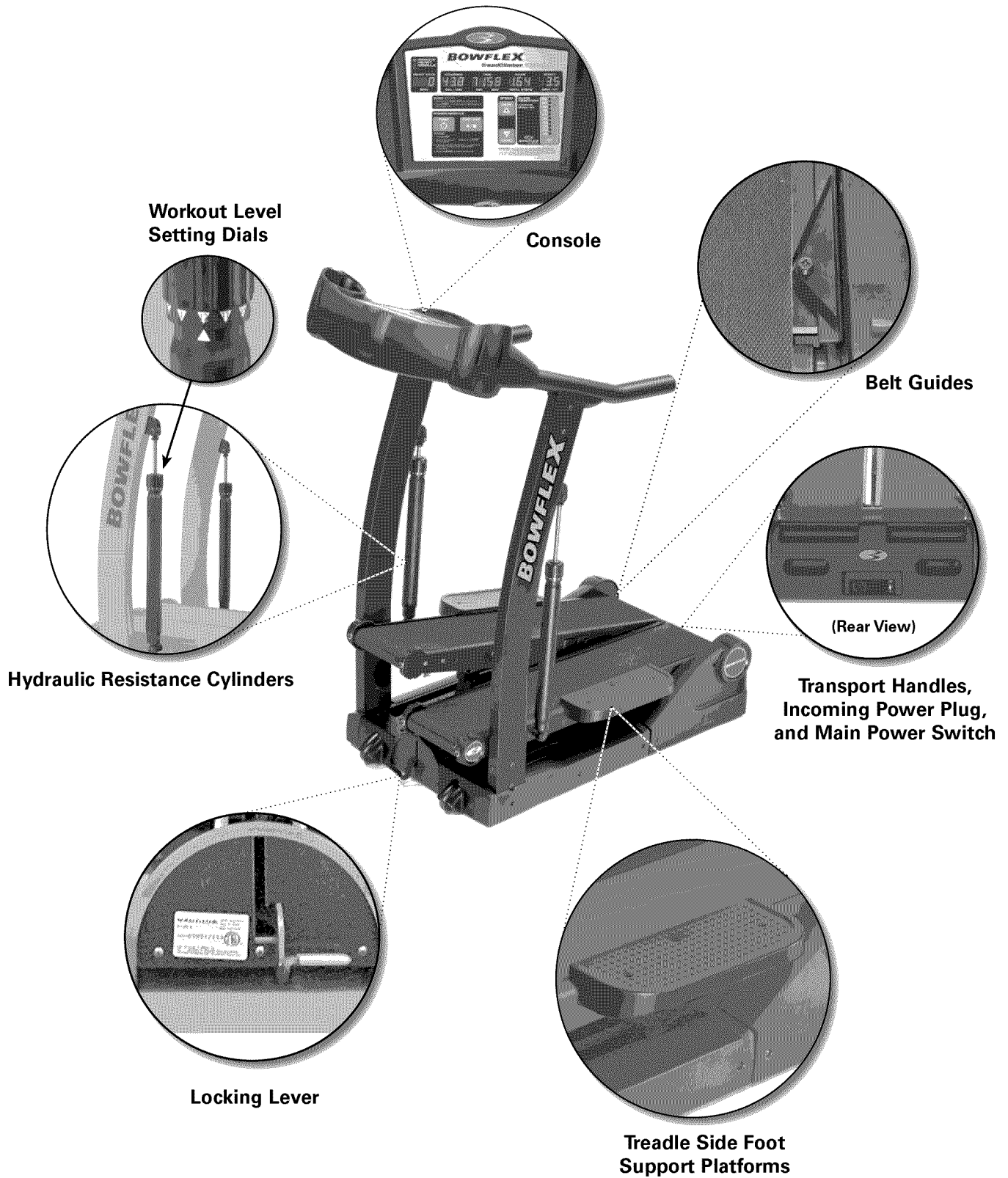

TC5000

Product Features



Care of the Machine

 The safety and integrity designed into a machine can only be maintained when the equipment is regularly examined for damage and repaired. It is the sole responsibility of the owner to ensure that regular maintenance is performed. The owner is responsible to make sure that regular maintenance is done. Worn or damaged components must be repaired or replaced immediately. Only manufacturer supplied components should be used to maintain/repair the equipment.

 To reduce the risk of electrical shock or unsupervised usage of the equipment, always unplug the power cord from the wall outlet and/or the machine and wait 5 minutes before cleaning, maintaining or repairing the machine. Place the power cord in a secure location.

Helpful Hints

Read all of the maintenance instructions thoroughly before assembling or using the TreadClimber® exercise machine. In some cases, an assistant is required to perform the necessary maintenance tasks. All references to the right or left side, and to the front or back are made as if you were on the TreadClimber® machine ready to exercise.

Initial Service

Use a soft, clean towel to wipe off the dust that may have accumulated during shipping. The TreadClimber® machine will require minor assembly. Refer to the Assembly Manual for details.

Accessories

For the best performance, we recommend that the TreadClimber® machine be placed on a rubber mat. The rubber mat will help keep dust and debris away from the TreadClimber® machine's motor and belts, reduce noise and increase stability. The Bowflex® TreadClimber® Machine Mat is professional quality and is designed specifically to fit under the Bowflex® TreadClimber® fitness machine. The mat protects floors from scratches and perspiration and it gives workout areas a clean, finished look.

For more information on this accessory and other Bowflex® products available from Nautilus, Inc. visit: www.bowflex.com or www.treadclimber.com.

Cleaning

General cleaning of the TreadClimber® machine will prolong the life of the machine and improve performance. Keep the unit clean by dusting regularly. Be sure to dust the exposed part of the deck on either side of the walking belts and the side rails.

Clean the top of the belt with a damp, soapy cloth and wipe carefully and thoroughly with a dry cloth. Be careful to keep liquid away from inside the base frame and beneath the belts.

NOTICE: Do not clean with a petroleum based solvent or an automotive cleaner. Be sure to keep the Console free of moisture.

 Do not use the machine until the Walking Belts are dry.

Inspecting

1. Visually inspect the TreadClimber® machine every time you use it for wear, damage, or loose parts.
2. Inspect the frame for any rust, bubbling, or paint chips during the weekly cleaning. The salt in perspiration can damage the unpainted surfaces.
3. Inspect the belts for excessive wear during lubrication. Adjust the belt tension if necessary.

Care of the Machine

Moving and Storage

The TreadClimber® machine weighs 185 pounds (84 kg.) when fully assembled, and should never be moved or lifted without taking some precautionary care.

There are two handles for lifting on the back of the base and two wheels on either side of the front of the base beneath the console.

The TreadClimber® machine requires 90 pounds (41 kg.) of force to lift the base to achieve the 30 degree angle necessary to roll it on the front wheels. As this is a considerable amount of force, it is highly recommended that you do not attempt to ever lift or move the TreadClimber® machine without help.

When lifted correctly, your TreadClimber® machine can be rolled on the wheels for storage and/or cleaning. Failure to follow precautions could result in physical injury to you, or damage to the machine, or both.

⚠ Do not use the uprights, arms, or console to lift or move the TreadClimber® machine. Doing so could cause physical injury to you, and could damage or destroy the TreadClimber® machine.

Do not move the machine without aid. Injury to you or damage to the machine can occur.

Put the power cord alongside the machine, out of your way when you dismount the machine. Prevent stepping on the power cord and plug.

Be sure to lock the treadles and remove the Safety Key for safe storage to prevent unsupervised use.

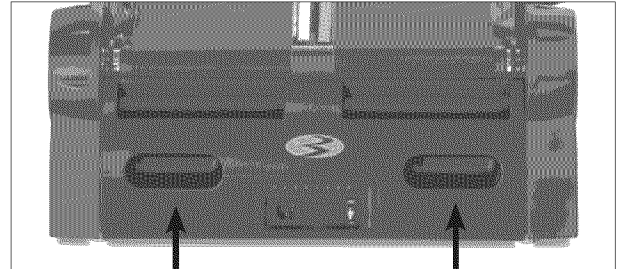

**TreadClimber® Base
Rear Lift Handles**

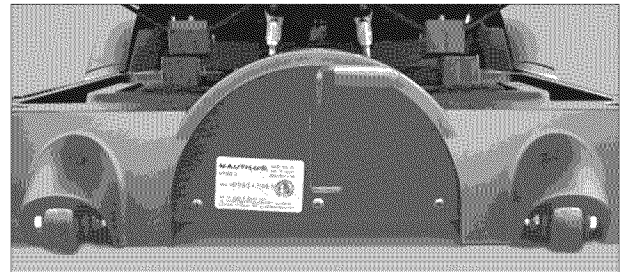

TreadClimber® Base – Front Wheels

Getting Started

! Read and follow the Important Safety Information in this manual. Make sure that any other machine users review the same Important Safety Information and that the manual is available to them.

Before You Start

1. Make sure you have verified or calibrated your machine as outlined in Step 19 of the Assembly Manual or the “Maintenance” section in this manual before using your Bowflex® TreadClimber® exercise machine for the first time.
2. Determine your workout mode (treadmill, stair-stepper or TreadClimber® mode).

Note: If you are working out in treadmill mode, you must lock the treadles by following the locking procedure in the Locking the Treadles section in this manual.

3. Follow the procedure in the Adjusting Workout Level Settings section in this manual to adjust the workout level settings on the Hydraulic Cylinders.

! Do not stand on the machine while adjusting hydraulic resistance settings.

4. If you are using the Heart Rate Monitor, obey the heart rate transmitter chest-strap directions in the Remote Heart Module section in this manual.
5. Plug the power cord into the base of the machine and into a grounded AC wall outlet. Always plug into the machine before plugging into the wall outlet.

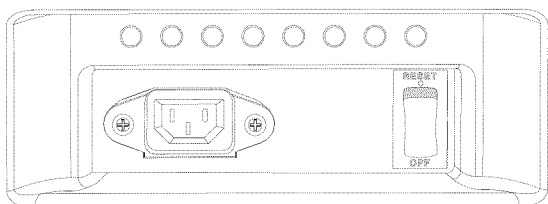

Main Power Switch “Off”

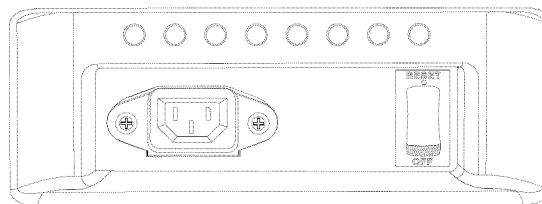

Main Power Switch “On”

Note: The TreadClimber® machine may be equipped with an external circuit breaker.

6. Main Power Switch.
 - Power is switched on using the Main Power Switch near the incoming power cord plug.
 - Power is supplied to the motor and console only when the unit is plugged in and the Main Power Switch is turned on.

Note: The console will not light up until you insert the Safety Key and turn on the console by pressing the POWER Button.

 - Put the power cord along the side of the TreadClimber® machine, making sure that it is out of your way when you dismount the machine. Be careful when securing the power plug to prevent stepping on it. Always check the position of the cord and plug before beginning your workout.
7. Straddle the belts and stand on the Side Foot Support Platforms. Insert the Safety Key into the Safety Keyhole and clip the Safety Key cord to your clothing.
 - The console will NOT power up if the Safety Key is not properly inserted into the Safety Keyhole.
 - In the event of an emergency, you may need to pull the Safety Key out while the TreadClimber® machine is in motion. Be aware that this will cut all power to the console and the belts will stop quickly (brace yourself—this is an abrupt stop).

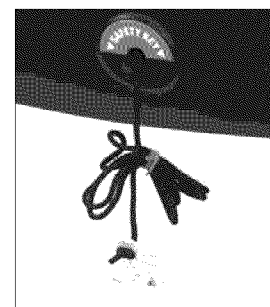

Safety Key and Cord

Getting Started

- Always wear the Safety Key clip attached to your clothing during workouts to be prepared to stop the belts quickly, if ever necessary.

8. Begin your workout using the appropriate instructions for your selected workout mode.

Note: Resistance and weight settings are what your Bowflex® TreadClimber® exercise machine uses to calculate your calories burned. If your Workout Level or weight changes, you must remember to change your settings on the console to ensure accurate calorie burn calculation.

! Keep your hands on the support Handlebars and stay as near the front of the machine as is comfortable in order to stay in balance on the Treadles.

Keep your foot in the center of each Treadle. Do not let your feet cross in front of your body as you increase the speed.

When you are experienced and comfortable with the action of the machine, you can allow your arms to swing freely in a natural walking motion. This workout will activate your core muscles. It should only be done by those comfortable with not holding on to the Handlebars.

Hydraulic Cylinder Adjustment (Workout Level)

! **CONSULT YOUR PHYSICIAN BEFORE STARTING ANY EXERCISE PROGRAM.** Only he or she can determine the exercise program that is appropriate for your particular age and condition. If you are new to exercise, are pregnant, have a heart condition or any physical limitation, failure to consult your physician before engaging in physical exercise, such as using the Bowflex TreadClimber® exercise machine, could result in serious injury or death. If while using the Bowflex® TreadClimber® exercise machine you have any pain, tightness in your chest, an irregular heartbeat, shortness of breath, feel faint, light-headed, dizzy or have any pain or discomfort, **STOP** and consult your physician immediately.

Your TreadClimber® machine uses Hydraulic Cylinders to absorb your steps and cushion your joints, decreasing your overall fatigue and reducing muscle strain. The displacement of the Treadles is adjusted by the dials on the Hydraulic Cylinders. Workout Level settings range from 1 to 12. The 1 setting is the minimum amount of Treadle movement; the 12 setting is the maximum movement. More treadle movement results in a more intense workout

Begin with each cylinder set to 6 on the dial. If this setting allows too much Treadle travel, adjust the dial toward 1 (counterclockwise) until you are comfortable with the amount of travel. If you find that the Treadles do not move enough to cushion your steps, adjust the dial setting toward the 12 (clockwise), to allow more Treadle movement. The Treadles should be set so they displace enough to absorb the impact of your stepping motion, approximately 3 inches.

Note: Although the Workout Level dial can move continuously in either direction, it is recommended that you only rotate the dial clockwise to setting 12 and counterclockwise to setting 1.

! **Do not change the intensity settings of the Cylinders during a workout. Stop the TreadClimber® belts and step off the machine before you adjust the resistance level. Failure to do so could result in injury.**

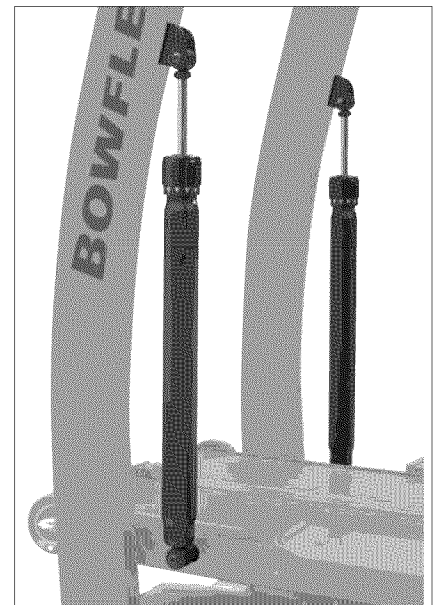

Hydraulic Cylinders

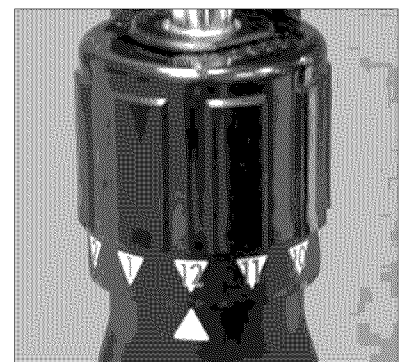

Resistance Arrow

Getting Started

The suggested Workout Level Guide shown is based on average fitness levels and a belt speed of 2 MPH (3.2 KMH) or slower. You should always assess whether that setting is right for you based on your individual needs and fitness level and adjust your Workout Level settings accordingly.

Your personal setting will depend on four factors:

- Your weight
- Your fitness level
- The average speed of the belts during your workout
- How deep you want to step

Workout Level settings may be adjusted incrementally if that best suits your body weight, fitness level and workout preferences (for example, midway between Levels 2 and 3).

To increase your overall calorie burn, raise your belt speed or raise your Workout Level setting one or two levels above your suggested level. Raising your Workout Level allows you to take deeper steps, helping your abdominal, gluteus, quadriceps and lower back muscles to work harder, burning more calories, particularly at higher belt speeds.

As your endurance levels increase, you may find that your Workout Level has risen; however, make sure that you select a low enough setting that you don't "bottom out" the treadles.

Note: "Bottoming out" occurs when the Treadle travels through too great a range of motion. When this occurs, the Treadles hit against the base on the down step. To reduce Treadle travel, turn the setting dial counterclockwise (to a lower number) or increase the belt speed.

It may be helpful to record your dial setting for future reference when there are multiple users of the machine.

TC3000 or TC5000 only—Any time you change the Workout Level dial settings, you also need to input that Workout Level into the console during setup so that the CALORIE display accurately reflects calories burned.

Note: If your actual Workout Level Setting is incremental, input your level as the nearest whole number.

Pausing or Stopping

Pausing or Stopping the TC3000 and TC5000

1. Step off of the belts onto the Side Foot Support Platforms on either side of the treadles.
2. Press START/STOP to stop the belts and console displays, (if you are in stair-stepper mode, pressing START/STOP will stop the console displays).

Belts will slow down to a complete stop. Final workout information will be displayed in the display windows: HEART RATE (TC5000 only), TIME, TOTAL CALORIES BURNED, TOTAL STEPS and TOTAL DISTANCE/MILES.

Windows that display multiple workout information (such as CALORIES/CAL PER MIN) will toggle between their final results every 6 seconds until the workout is resumed or the console is turned off.

3. You may restart your workout by pushing the START/STOP button again.

If you do not push START/STOP again to resume your workout within 5 minutes, your Bowflex® TreadClimber® exercise machine will automatically power off the console. Workout information will be cleared when power to the console is shut off.

4. You may shut off power to the console manually by pushing the POWER button. If this is done during the workout, the console will turn off and the belt will slow to a complete stop. All information from your workout will be cleared.
5. Turn off the Main Power Switch at the base of the machine.

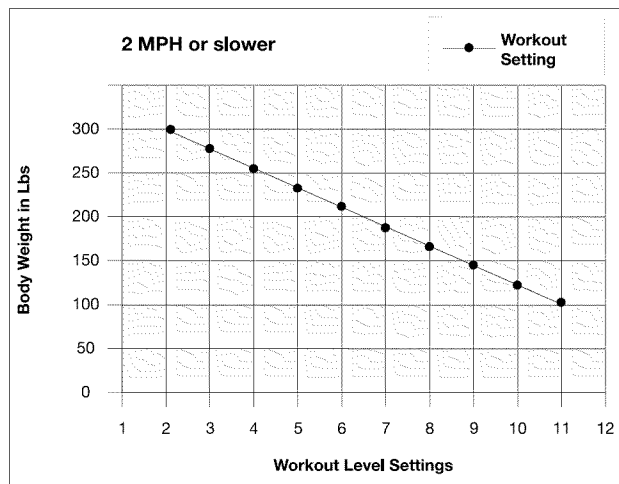

Workout Level Guide

Getting Started

6. Lock the treadles and remove the Safety Key for safe storage when not in use.

Note: In case of emergency, you may shut off power by pulling out the Safety Key but this will abruptly stop the belts as well as clearing all workout information from the display windows.

Pausing or Stopping the TC1000

1. Step off the treadles onto the side foot support platforms.
2. Press START/STOP to slow the belts to a stop.
3. If you wish to reset your workout numbers, press the RESET button. RESET only works when the belts are not moving.
4. Make sure to turn off the base power switch and unplug the TreadClimber® machine when you have finished your workout.
5. Lock the treadles and remove the Safety Key for safe storage when not in use.

TC 5000 Displays

- HEART RATE/BEATS PER MIN – Displays your heart rate in beats per minute when you are correctly wearing and using the TreadClimber® heart rate transmitter chest-strap or a TreadClimber® compatible heart rate transmitter chest-strap.
- CALORIES/CALORIES PER MINUTE – This screen will toggle between total calories burned (whole number) and calories per minute (includes one decimal place—e.g. 15.5).
- TIME – Counts up in minutes and seconds the total time of your workout (e.g. 24:22 minutes).
- MILES/TOTAL STEPS – This is the miles (or kilometers) displayed to one decimal point (e.g. 0.8) and Total Steps Taken for the entire length of your workout, displayed as a whole number.
- SPEED – Displays your climbing rate in miles (MPH) or kilometers (KPH) per hour to one decimal point (e.g. 3.2 MPH). When unit is used in stair stepper mode, SPEED display will show Steps per Minute.
- CLIMB INDICATOR – This display shows the total height of your workout in feet (200 Steps Taken = 100 feet or 30 meters). After 1000 feet (305 meters), this display starts over again at 100 feet (30 meters).

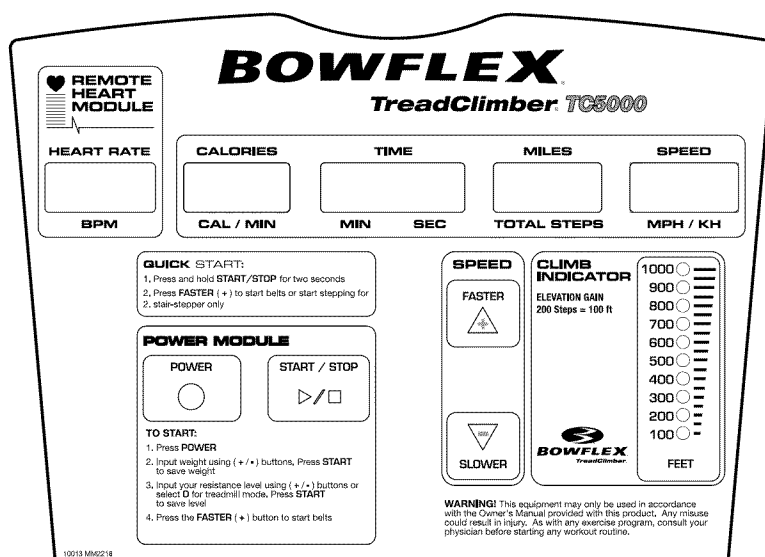

Quick Start

QUICK START – The TC5000 has a Quick Start function for your TreadClimber® machine or treadmill workouts that will bypass having to verify your weight and Workout Level Settings. Make sure you lock the treadles following the Locking the Treadles instructions on Page 20 before starting a treadmill workout.

Note: Quick Start always reverts to the last workout mode used. If you are not going to use TreadClimber® machine in the same mode as your last usage, you cannot use the Quick Start function.

1. Push and hold the START/STOP button for two seconds—this will revert weight and Workout Level to the last numbers saved. (Note: The console will NOT power up if the Safety Key is not properly inserted into the Safety Keyhole.)
2. Press the FASTER button to start the belts at 0.7 MPH (1.1 KPH), or start stepping for a stair-stepper workout.
3. Once the belts have started, you may step onto the treadles at any time.
4. Press FASTER again to increase belt speed (for treadmill and TreadClimber® modes).

Getting Started

Remote Heart Module (TC5000 Only)

The Remote Heart Module and Heart Rate Transmitter are features on the TC5000 only. You may use the TC5000 Heart Rate Transmitter or any other Heart Rate Transmitter that is compatible with the TreadClimber® TC5000 to help keep yourself within your target fat-burning heart rate zone during your workout.

Note: A Heart Rate Strap with a non-replaceable battery is included. It will work with Polar® watches. To promote contact it should be wet with perspiration, gel or saliva. To promote maximum life, it must be rinsed with clean water and dried after each use. A one year life is expected, replacement part T41 is available from Polar® or Nautilus, Inc.

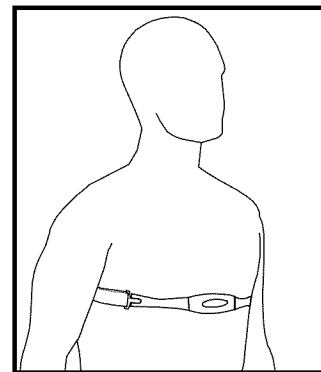

How to Use Your Chest Strap: Using the Bowflex® TreadClimber® heart rate transmitter chest strap, you can monitor your heart rate at any time during your workout

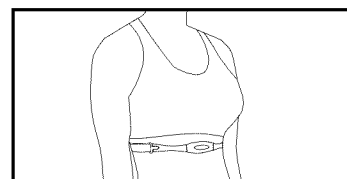
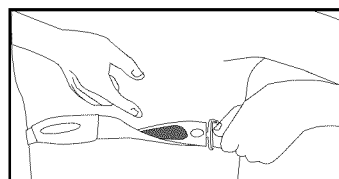
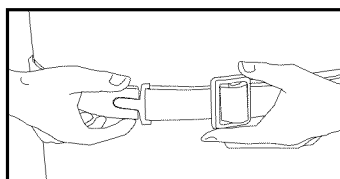
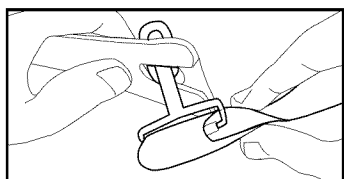

1. The heart rate transmitter is attached to a chest strap to keep your hands free during your workout.

Attach the transmitter to the elastic chest strap.

2. Adjust the strap length to fit snugly and comfortably against your skin. Secure the strap around your chest, just below the chest muscles, and buckle it.

3. Lift the transmitter off your chest and moisten the two grooved electrode areas on the back.

4. Check that the wet electrode areas are firmly against your skin.

5. The transmitter will send your heart rate to the TreadClimber® machine's receiver and your Beats Per Minute (BPM) will be displayed in the HEART RATE display within a matter of several seconds.
6. Always remove the transmitter before cleaning the chest strap. Clean the chest strap regularly with mild soap and water and thoroughly dry it. Residual sweat and moisture keep the transmitter active and drain the battery in the transmitter.

Note: Do not use abrasives or chemicals such as steel wool or alcohol for cleaning, as they can damage the electrodes permanently.

Replacement chest straps are available by calling your TreadClimber® Representative at 1-800-NAUTILUS (1-800-628-8458).

NOTICE: Never immerse the Heart Rate Transmitter in water—doing so could permanently damage the monitor and cause it to malfunction.

If the Heart Rate Transmitter is not sending a signal to your console, check to make certain that the metal electrodes on the chest strap are connecting with your skin. You may need to lightly wet the circles so they adhere.

If no signal appears or you need further information, please call a TreadClimber® Representative at 1-800-NAUTILUS (1-800-628-8458).

Getting Started

Information About Heart Rate Calculations

Your maximum heart rate generally declines with age from about 220 Beats Per Minute (BPM) in childhood to about 160 BPM at age 60. This fall in heart rate is fairly linear, decreasing by approximately one BPM per year. There is no strong evidence to suggest that training influences the decline in maximum heart rate. It should be remembered that individuals of the same age might have quite different maximum heart rates. It is more accurate to calculate this value by undergoing a stress test than by using an age-related formula.

On the other hand, your resting heart rate is greatly influenced by endurance training. The typical adult has a resting heart rate of about 72 BPM whereas highly trained runners may have readings of 40 BPM or lower.

The heart rates below are based on average fitness of persons of the age indicated. You may be more or less fit, and your actual maximum heart rate and zones may be correspondingly higher or lower. You should therefore consult your physician for the maximum heart rate that is right for you and the heart rates that you can safely exercise at.

The best way to burn fat during exercise is to start slowly with a less intense exercise and gradually increase your intensity until your heart rate during exercise is between 60 – 85% of your maximum heart rate, and continue at that pace, keeping your heart rate in that target zone for over 20 minutes.

The longer you maintain your target heart rate, the more fat your body will burn.

The graph below is merely a guideline, showing the generally suggested target heart rate for persons your age. As noted above, your optimal target rate may be higher or lower, depending on your fitness. Consult your physician for your individual target heart rate.

Using the graph below as a guideline, raise and lower the intensity of your workout to keep within the suggested target heart rate for your age.

FAT-BURNING TARGET HEART RATE

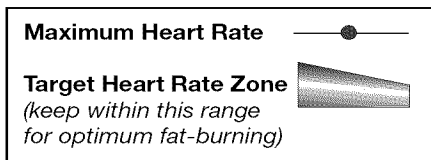
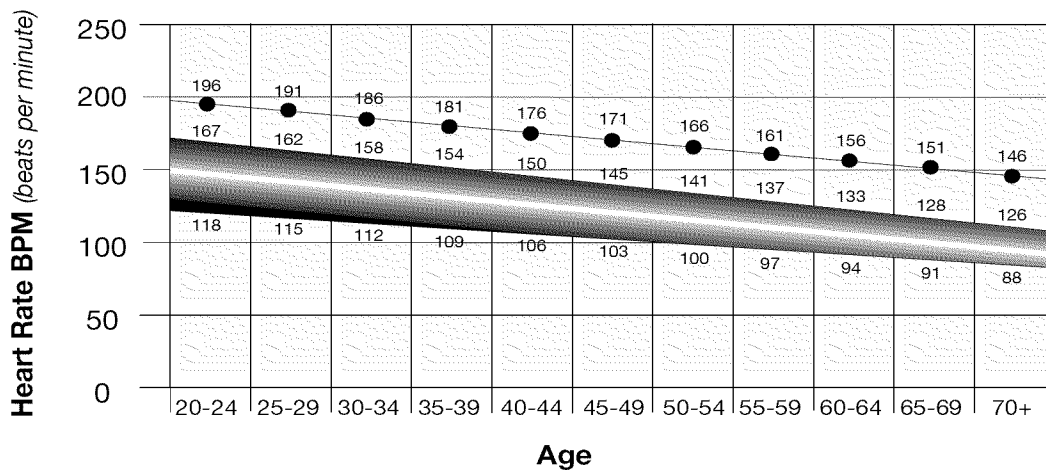

Note: As with all exercises and fitness regimens, always use your best judgment when increasing intensity or endurance.

Getting Started

TC3000 Features

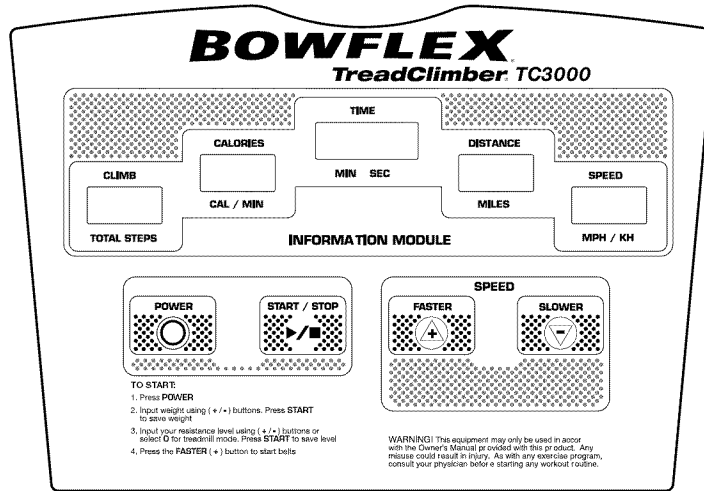

TC3000 Displays

- **CLIMB/TOTAL STEPS** – This displays the total steps you have taken since starting your workout.
- **CALORIES/CALORIES PER MINUTE:** This screen toggles between the total calories burned (whole number) and calories per minute (to one decimal place).
- **TIME** – Counts up the total time of your workout in minutes and seconds (e.g. 24:22 minutes).
- **DISTANCE** – The total distance you have traveled in miles (to one decimal point, e.g. 3.4 Miles) for this workout.
- **SPEED/MPH/KH** – Displays your climbing rate in miles or kilometers per hour (e.g. 3.2 MPH).

TC1000 Features

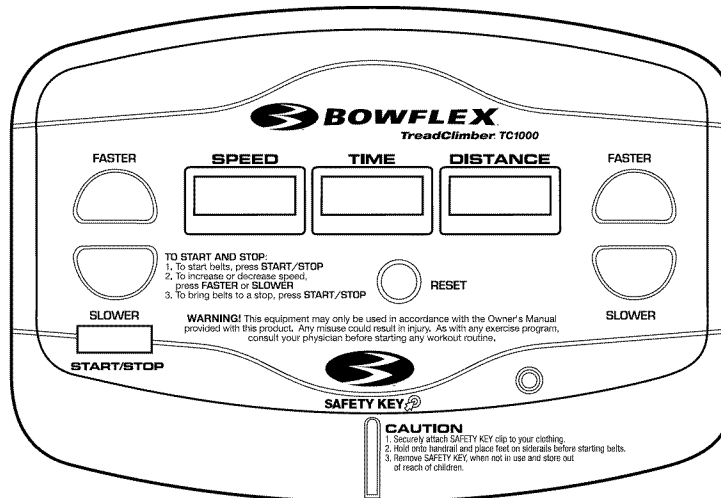

TC1000 Displays

- **SPEED** – Displays the Speed of your workout in MPH (e.g. 2.4 MPH).
- **TIME** – Counts up the total time of your workout in minutes and seconds (e.g. 24:22 minutes).
- **DISTANCE** – The total distance you have traveled in Miles (to one decimal point, e.g. 3.4 Miles) for this workout.
- **RESET** – This button resets all values in the Displays to zero after you have Paused or Stopped your workout.

Getting Started

Setting English or Metric Measurement Units (TC3000 and TC5000)

You can configure the TC5000 and TC3000 Consoles to display in Miles or Kilometers:

1. Turn the Main Power Switch on the Bowflex® TreadClimber® base to 'On'.
2. Remove the Safety Key.
3. Press and hold the START/STOP button.
4. Insert the Safety Key while holding down the START/STOP button.
5. Console will power up and show "EngL" text in the TIME display.
6. Continue to hold the START/STOP button and the console will toggle between "EngL" and "MET" every three seconds.

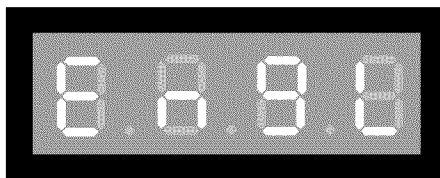

English Measurement Display

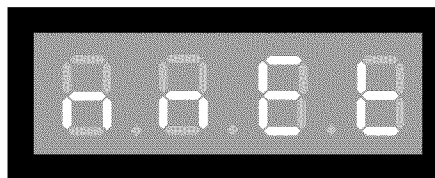

Metric Measurement Display

7. Release the START/STOP button when desired measurement unit type is displayed.
8. Remove and re-insert the Safety Key to clear the TIME display.

The below is an example of how weight will display in both English Standard and Metric

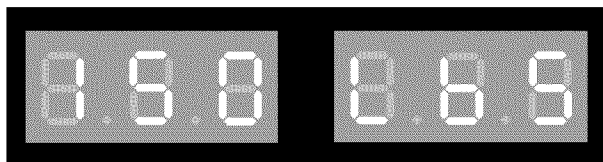

English Measurement—150 Pounds

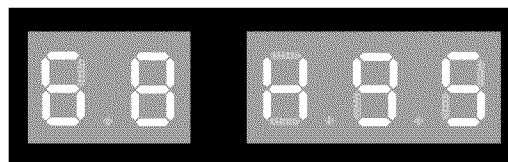

Metric Measurement—68 Kilograms

Workout Instructions

Determining Your Fitness Level

Endurance is an important way to determine your fitness level. Before you begin exercising on your Bowflex® TreadClimber® exercise machine, you will want to benchmark your current endurance level, based on how well you feel after you take these quick tests on your TreadClimber® machine. To do these tests, you'll need to use your TreadClimber® machine in all exercise modes (TreadClimber®, treadmill and stair-stepper modes).

⚠️ CONSULT YOUR PHYSICIAN BEFORE STARTING ANY EXERCISE PROGRAM. Only he or she can determine the exercise program that is appropriate for your particular age and condition. If you are new to exercise, are pregnant, have a heart condition or any physical limitation, failure to consult your physician before engaging in physical exercise, such as using the Bowflex TreadClimber® exercise machine, could result in serious injury or death. If while using the Bowflex® TreadClimber® exercise machine you have any pain, tightness in your chest, an irregular heartbeat, shortness of breath, feel faint, light-headed, dizzy or have any pain or discomfort, STOP and consult your physician immediately.

These three quick tests should help you determine at what level you should start training:

Test 1

1. Start a TreadClimber® workout (belts and treadles engaged) at 0.7 MPH (0.5 for TC1000), using the easiest Workout Level Setting for your weight (see the Workout Level Settings table on Page 10), and gradually increase your speed for the next 30 seconds until you reach 2 MPH or until you feel that you are at your personal maximum exertion.
2. Continue for another 15 seconds at that speed, then step off the treadles onto the Side Foot Support Platforms and press START/STOP to stop the belts.
3. Once the belts have stopped, breathe in and out slowly a few times, and then review your level of exertion based on the below scale:

RATE OF PERCEIVED EXERTION SCALE

1. Sluggish – heart rate not raised
2. Comfortable – strolling rather than exercising
3. Alert and moving – not exerting yourself
4. Heart rate up – feel activated
5. Moderate exercise – feel aerobic and warmed up
6. Invigorated and healthy but could tire out soon
7. Breathing heavier – pushing yourself
8. Panting hard – feeling muscle burn
9. Sharp increase in exertion – almost at maximum effort
10. Maximum effort – could collapse if pace continued

Based on the above scale:

- Beginner Level perceives exertion at 8, 9 or 10
- Intermediate Level perceives their exertion at 4, 5, 6 or 7
- Advanced Level perceives exertion at 1, 2 or 3

Workout Instructions

Test 2

1. Change over to Treadmill mode (see Locking the Treadles section in this manual) and begin a workout at 0.7 MPH (0.5 for TC1000), gradually increasing your speed for the next 30 seconds, raising speed until you reach 2 MPH or until you feel that you are at your personal maximum exertion.
2. Continue for another 15 seconds at that speed, then step off the treadles onto the Side Foot Support Platforms and press START/STOP to stop the belts.
3. Once the belts have stopped, breathe in and out slowly a few times, and then review your level of exertion based on the Perceived Exertion Scale listed under Test 1 of the Workout Instructions section of this manual.

Test 3

1. Change over to the Stair-Stepper mode using the easiest workout resistance for your weight (see the Workout Level Guide table in the Select Your Workout Level section of this manual), and gradually increase your rate of stepping for the next 30 seconds, taking steps at a moderate depth and height while stepping more quickly until you feel that you are at your personal maximum exertion.
2. Continue for another 15 seconds at that speed and then stop stepping and step off the treadles and onto the Side Foot Support Platforms.
3. Breathe in and out slowly a few times, and then review your level of exertion based on the Perceived Exertion Scale listed under Test 1 of the Workout Instructions section of this manual.

Assessment

After finishing all endurance tests, add the totals of your perceived exertion for Tests 1, 2 and 3 together and divide by three. If your score is:

8 - 10: use the BEGINNER LEVEL workouts on Page 24.

4 - 7: use the INTERMEDIATE LEVEL workouts on Page 24.

1 - 3: use the ADVANCED LEVEL workouts on Page 24.

If at any time you wish to raise your endurance, you should retest your Perceived Exertion Level.

If you follow our workout program, you should see a marked improvement in your endurance after just a few workouts on your Bowflex® TreadClimber® exercise machine.

Workout Instructions

Treadmill Workout

Treadles

Each Bowflex® TreadClimber® treadle is a separate treadmill with its own belt, however both treadles are driven by the same axle and motor. This assures that each belt travels at the same speed. Further, the treadles are interconnected, which provides a balanced relationship between the left and right sides during the workout to give the most cushioned effect to your joints.

! Keep your foot in the center of each Treadle. Do not let your feet cross in front of your body as you increase the speed.

Locking the Treadles for Treadmill Workout

The right and left treadles can be locked together to get a treadmill workout.

! Do not change from or into treadmill mode while the belts are in movement or the machine is powered up. To change the modes, stop the power. Unplug the cord from the wall outlet, line up the Treadles, and then lock or release the Treadle Locking Lever.

The TreadClimber® machine is equipped with a treadle-locking lever that can be manipulated with your foot.

1. Turn off all power to the TreadClimber® machine and unplug the power cord from the wall outlet.
2. Move the locking lever downward and to the left and then upward into the 'locked' position with your foot. Stand on each treadle individually until they drop to the horizontal position. There will be a 'click' when they lock into position.
3. Insert power cord into the wall outlet and turn on the Main Power Switch. Follow the Starting a Treadmill Workout instructions for your model to work out in treadmill mode.

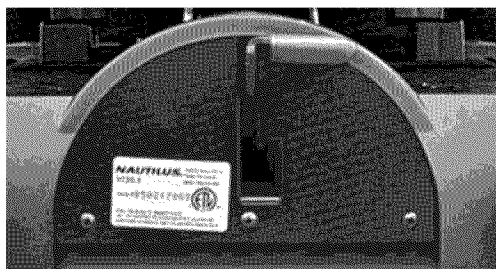

Lever in locked position for treadmill mode

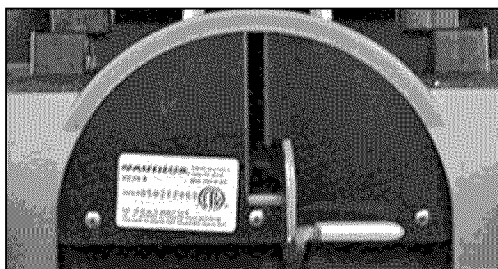

Lever in unlocked position for TreadClimber® mode

4. To release the treadles, turn off the Main Power switch and push the lever downward and to the right with your foot. The treadles will return to inclined position.

Note: You will not need to manually change the Workout Level Settings on the Hydraulic Cylinders for a treadmill workout.

Workout Instructions

Starting a Treadmill Workout (TC3000 and TC5000)

1. Make sure you have locked the treadles, following the guidelines in the Locking the Treadles section in this manual.
2. Push POWER to turn on the Console. The console will NOT power up if the Safety Key is not properly inserted into the Safety Keyhole.

 **To avoid injury, do not stand on the walking belts while starting or stopping them.**

3. Input your weight. For first time use, follow the weight-input instructions for Starting a TreadClimber® Workout.
4. When your weight is displayed accurately, push START/STOP one time.
5. Input a Workout Level Setting of 0 for treadmill workout once you have locked the treadles. Remember to change your Workout Level Setting to 0 every time you work out in treadmill mode in order to insure that the CALORIE display accurately shows your calories burned.
6. When your Workout Level is displayed accurately, push START/STOP once again. This will start the clock counting your workout TIME.
7. Press FASTER to start the belts. Starting belt speed is 0.7 mph.
8. Once the belts have started, you may step onto the treadles at any time.

Note: If you are new to the TreadClimber® machine, make sure to start your workout at a slower speed, gradually increasing belt speed as your endurance and fitness levels increase.

9. Press FASTER or SLOWER to increase or decrease belt speed as needed.

Starting a Treadmill Workout (TC1000)

1. Make sure you have locked the treadles, following the guidelines in the Locking the Treadles section in this manual.
2. Push START/STOP to start the walking belts (the console will NOT power up if the Safety Key is not properly inserted into the Safety Keyhole)—TIME starts counting as soon as you start the belts. Starting belt speed is 0.5 mph.
3. Once the belts have started, you may step onto the treadles at any time.

Note: If you are new to the TreadClimber® machine, make sure to start your workout at a slower speed, gradually increasing belt speed as your endurance and fitness levels increase.

4. Press FASTER or SLOWER to increase or decrease belt speed as needed.

Workout Instructions

Starting a Stair-Stepper Workout (TC3000 and TC5000)

1. Push POWER to turn on the Console (the console will NOT power up if the Safety Key is not properly inserted into the Safety Keyhole).
2. Input your weight. For first time use, follow the weight-input instructions for Starting a TreadClimber® Workout.
3. When your weight is displayed accurately, push START/STOP one time.
4. Input your Workout Level Setting. For first time use, follow the Workout Level-input instructions for Starting a TreadClimber® Workout.
5. When your Workout Level is displayed accurately, push START/STOP once again. This will start the clock counting your workout TIME.
6. Do not press the FASTER button to start the belts. Instead, start stepping for your stair-stepper workout.

The console will calculate your calories burned for a stair-stepper workout, and the MILES/TOTAL STEPS will show total steps taken.

Note: Miles/Total Steps display will toggle between miles and total steps every 6 seconds.

Starting a Stair-Stepper Workout (TC1000)

1. DO NOT press START/STOP.
2. Begin stepping, however, remember that the TIME, SPEED and DISTANCE displays will not display your workout information.

Workout Instructions

Bowflex® TreadClimber® Workout

A TreadClimber® workout combines stair-stepping with moving belts and gently supported resistance, providing you a workout that burns calories faster than almost any cardiovascular exercise machine you have ever experienced. While you may use your TreadClimber® machine in treadmill and stair-stepping modes in addition to the TreadClimber® mode, you will experience the best calorie and fat-burning when working out in TreadClimber® mode.

Starting a TreadClimber® Workout (TC3000 and TC5000)

⚠ To avoid injury, do not stand on the walking belts while starting or stopping them.

1. Push POWER to turn on the Console. The console will NOT power up if the Safety Key is not properly inserted into the Safety Keyhole.
2. Input your weight.
FOR FIRST TIME USE: A default weight of 150 lbs will show in the digital displays.

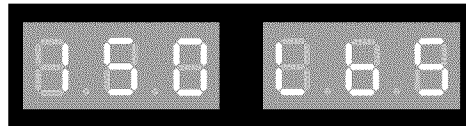

Display: 150 lbs

Use the FASTER or SLOWER buttons to increase or decrease to your actual weight. The TreadClimber® machine will remember the last weight you input and display that weight upon startup the next time you exercise.

3. When your weight is displayed accurately, push START/STOP one time.
4. Input your Workout Level Setting.

FOR FIRST TIME USE: A default workout level of 6 will show in the digital displays.



Display: Workout Level 12

Use the FASTER or SLOWER buttons to change the digital display setting to your actual workout level setting.

Note: Actual Workout Level Settings are changed manually, using the Workout Level dials located on each Hydraulic Cylinder, but you will also need to input your Workout Level into the console for calorie burn calculations.

5. When your Workout Level is displayed accurately, push START/STOP once again. This will start the clock counting your workout TIME.

Note: Your TreadClimber® machine uses your Workout Level and weight settings to calculate your calories burned. If your Workout Level or weight changes, you must remember to change your settings on the console to insure accurate calorie burn calculation.

Workout Instructions

6. Press FASTER to start the belts. Starting belt speed is 0.7 MPH (1.1 KPH).

Note: Belts may take two to three seconds to start.

7. Once the belts have started, you may step onto the treadles at any time.

Note: If you are new to the Bowflex® TreadClimber® machine, make sure to start your workout at a slower speed, gradually increasing belt speed as your endurance and fitness levels increase.

8. Press FASTER or SLOWER to increase or decrease belt speed as needed.

Starting a TreadClimber® Workout (TC1000)

 **To avoid injury, do not stand on the walking belts while starting or stopping them.**

1. Push START/STOP to start the walking belts—TIME starts counting as soon as you start the belts.

Note: The console will NOT power up if the Safety Key is not properly inserted into the Safety Keyhole.

2. Once the belts have started, you may step onto the treadles at any time.
3. Press FASTER to increase your speed. Starting belt speed is 0.5 MPH (0.8 KPH).

Note: If you are new to the TreadClimber® machine, make sure to start your workout at a slower speed, gradually increasing belt speed as your endurance and fitness levels increase.

4. Press FASTER or SLOWER to increase or decrease belt speed as needed.

Workout Instructions

Preliminary TreadClimber® Workout

First 4 Weeks

Based on your Perceived Exertion Level (see the Determining Your Fitness Level section at the beginning of the Workout Instructions section of this manual), follow the Preliminary Workout guidelines to ease yourself into a weekly Bowflex® TreadClimber® regimen. This regimen may include varying stair-stepper, treadmill and TreadClimber® modes (combination elliptical, stair-stepping and treadmill) workouts or any one of those workouts that suits your own unique and ever-changing exercise-regimen needs.

Remember to always use your own, best personal judgment and the advice of your physician or health care professional to determine how intense and how long your daily workout should be.

Warming Up

Before you begin any workout, you should prepare your body for increased activity by slowly raising your heart rate.

Stair-stepping is one way to warm up your body slowly without fatiguing. Follow the directions in the Stair-Stepper Workout section in this manual to begin a stair-stepper warm-up. When you are ready to begin your TreadClimber® workout, all you will need to do is:

- a) Step off the treadles onto the Side Foot Support Platforms
- b) Engage the belts by pressing the FASTER button (START/STOP for the TC1000)

Beginning Your Workout

Interval Training and Steady State are two types of workouts that you may perform on the TreadClimber® machine while in TreadClimber® mode (stepping and using the belts at the same time). You may also wish to combine Interval Training with Steady State Training to get a varied workout.

Interval Training involves adjusting your speed for specific lengths of time to raise and lower your heart rate and calorie burn. Interval training varies the intensity of your workout during one exercise session. Alternating high-intensity training with low-intensity rest periods will boost your metabolism and help you continue to burn calories even after your workout is over.

Interval training also helps prevent the injuries often associated with repetitive endurance exercise, and allows you to increase your training intensity without over-training or burning out.

Try varying your belt speed or rate of stepping from fast speeds to slower recovery speeds to begin building your own Interval Training regimen.

Steady State workout involves performing one exercise at the same speed and intensity for a long period of time. While there are risks to repetitive workouts, the TreadClimber® machine is designed to cushion your joints and muscles from those stress injuries. Further, repetitive workouts can help you build your endurance, stamina and strength while continuing to hone and improve the tone and lean muscle mass in your long muscles.

Workout Instructions

Beginner Level	Intermediate Level	Advanced Level
Week 1	Week 1	Week 1
<ul style="list-style-type: none"> • 3 x per week – treadmill workout with treadles locked at 2 MPH pace for 30 minutes <p>Once this has become easier, retest your Fitness Level to determine if you are ready to progress to Week 2 – your perceived exertion should have improved at least one point.</p>	<ul style="list-style-type: none"> • 3 x per week, perform a TreadClimber® workout at steady, constant pace for 30 minutes 	<ul style="list-style-type: none"> • 2 days interval training – 30 minutes • 1 day steady pace – 30 minutes <p>Increase workout level setting during training weeks, if needed, to maximize TreadClimber® fitness benefits.</p>
Week 2	Week 2	Week 2
<ul style="list-style-type: none"> • 3 x per week, perform a TreadClimber® workout at steady, constant pace – 30 minutes <p>Once this has become easier, retest your Fitness Level to determine if you are ready to progress to Week 3 – your perceived exertion should have improved at least one point.</p>	<ul style="list-style-type: none"> • 2 days steady pace – 30 minutes • 1 day interval training – 30 minutes <p>Increase your workout levels during training weeks, if needed, to maximize TreadClimber® fitness benefits.</p>	<p>Use Weeks 1 as a guide to help you begin building your own long-term fitness routine, adjusting your interval speeds, resistance, step depth, etc. in order to maximize TreadClimber® benefits.</p>
Week 3	Week 3	
<ul style="list-style-type: none"> • 2 days steady pace – 30 minutes • 1 day interval training – 30 minutes <p>Increase workout level setting.</p>	<p>Use Weeks 1 and 2 as a guide to help you begin building your own long-term fitness routine, adjusting your interval speeds, resistance, step depth, etc. in order to maximize TreadClimber® benefits.</p>	
Week 4		
<ul style="list-style-type: none"> • 2 days interval training – 30 minutes • 1 day steady pace – 30 minutes <p>Increase workout levels 1-2 levels during training weeks, if needed, to maximize fitness benefits.</p>		
Week 5		
<p>Use Weeks 1, 2, 3 and 4 as a guide to help you begin building your own long-term fitness routine, adjusting your interval speeds, resistance, step depth, etc. in order to maximize TreadClimber® benefits.</p>		

Maintenance

 The safety and integrity designed into a machine can only be maintained when the equipment is regularly examined for damage and repaired. It is the sole responsibility of the owner to ensure that regular maintenance is performed. The owner is responsible to make sure that regular maintenance is done. Worn or damaged components must be repaired or replaced immediately. Only manufacturer supplied components should be used to maintain/repair the equipment.

This product, its packaging, and components contain chemicals known to the State of California to cause cancer, birth defects, or reproductive harm. This Notice is provided in accordance with California's Proposition 65. If you would like additional information, please refer to our website at www.nutilus.com/prop65.

 Always unplug your TreadClimber® machine from the outlet and let sit for 5 minutes before cleaning or servicing the unit. To prevent unsupervised operation of the machine always remove the Safety Key and disconnect the power cord from the wall outlet or machine AC inlet.

Routine Maintenance

For general routine maintenance and cleaning see the Care of the Machine section of this manual.

Walking Belt and Deck Lubrication

The TreadClimber® machine is equipped with a pre-lubricated, low maintenance deck and belt system. Belt friction may affect the function and life of the TreadClimber® machine. For the best results from the TreadClimber® machine, lubricate the treadles periodically with a silicone lubricant, using the following instructions:

1. Unplug the TreadClimber® machine completely from the wall outlet, and remove the power cord from the incoming power plug.

 **DANGER** Always unplug the power cord from the wall outlet and wait 5 minutes after unplugging the machine before removing or installing parts to avoid the risk of electrocution, shock or mechanical injury.

2. While the TreadClimber® machine's treadle surfaces are still warm (not hot), apply a very thin layer of silicone lubricant directly onto the treadle beneath each belt. Gently lift each side of the belt and apply a few drops of the lubricant.

 Always use a silicone-based lubricant. Never use a de greaser like WD-40® on the Bowflex® TreadClimber® exercise machine as this could seriously impact performance.

3. Plug the TreadClimber® machine back into the machine base and then into the wall outlet.
4. Stand to one side of your TreadClimber® machine.
5. Turn on your TreadClimber®, and start the belts at the slowest speed. Let the belts run for approximately 15 seconds.
6. Turn off your TreadClimber® machine.
7. Take care to wipe up any excess lubricant from the treadles and surrounding floor. We also recommend a periodic inspection of the treadle surfaces under the belts. If the decks appear worn, contact Nautilus® Customer Service.

 To reduce the possibility of slipping, be sure the treadle area is free from grease or oil. Wipe off any excess oil from the machine surfaces.

Use the following timetable as a guide to lubricate the decks:

Maintenance

- Light user (fewer than 3 hours/week): every 6 months
- Medium user (3-5 hours/week): every 3 months
- Heavy user (more than 5 hours/week): every month

We recommend that you use the following:

- Lube-N-Walk® Treadmill Lubrication Kit, available from Nautilus, Inc.
- 100% pure silicone spray, available at most hardware and auto parts stores.

Walking Belt Adjustment

The walking belts need to be adjusted if they are out of center enough to cause a rubbing or scraping sound. Adjustments can be made at the front roller of each treadle.

Belt Alignment

1. Visual Test – Stand beside the unit and set the speed at 1.5 mph. Stand in front of the unit to see the adjustment bolts on each end of each front roller (Figure 1).
2. If the belt tracks too far to the right, use 3/16" hex key to turn the right adjustment bolt (see Figure 2) clockwise in full turn increments until the belt is aligned.

Note: The belt will always move away from the tension bolt being tightened.

NOTICE: Do not turn bolts counterclockwise to adjust belt alignment. Bolts are turned counterclockwise **only** to decrease belt tension.

3. If the belt tracks too far to the left, do the same thing on the left adjustment bolt for that roller.

Belt Tension

Check the walking belt tension only when the machine is unplugged. From the belt's midpoint, a correctly tensioned belt should only have 1" (2.5 cm) of give. To check, pull the belt upward at its midpoint and measure the distance to the deck.

If the distance is more than 1" (2.5 cm), the belt is loose. To tighten, turn both bolts clockwise one half turn and check tension again. Repeat this step if necessary.

If a belt is too tight, loosen (turn counterclockwise) the adjustment bolts one half turn and check the tension again. Repeat this step if necessary.

NOTICE: Bolts are turned counterclockwise only to decrease belt tension. Do not turn bolts counterclockwise to adjust belt alignment.

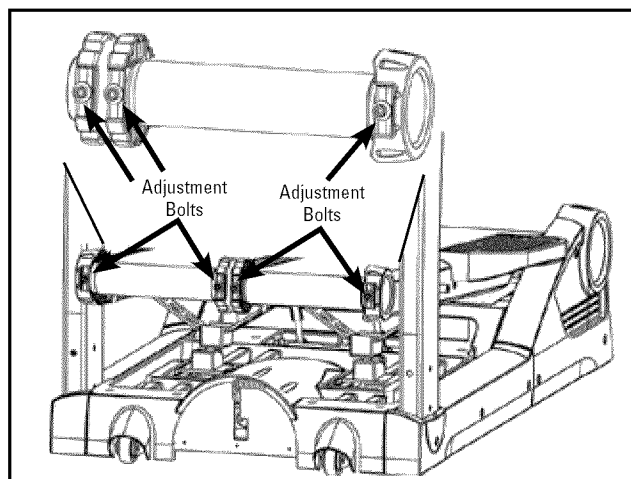

Figure 1 - Walking belt alignment (exploded view)

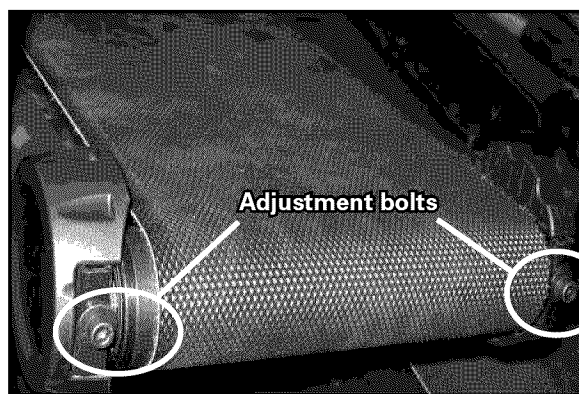

Figure 2

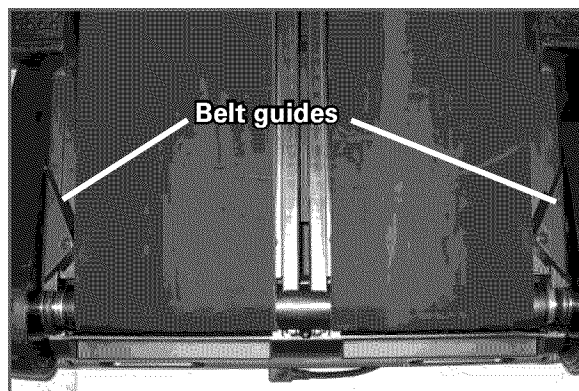

Figure 3 - Rear roller

Maintenance

Walking Belt Electrostatic Reduction

This procedure provides important instructions on how to apply anti-static spray to the walking belts on your TreadClimber® machine. This will reduce static electric charges caused by the movement of the walking belts.

- ⚠ Do not operate where aerosol products are being used.
- Read and understand all Warnings for the anti-static spray in the product information from the manufacturer.

Tools

- 3/16" Hex Key
- Anti-static spray—aerosol (for example, Static Guard® spray) or liquid pump-spray

1. Unplug the machine from the wall.

⚠ DANGER To reduce the risk of electrical shock, always unplug the power cord from the wall outlet and/or the machine, and wait 5 minutes before cleaning, maintaining or repairing the machine. Place the power cord in a secure location.

2. Loosen the tension adjustment bolts for the walking belts to let the belts slide easily. Turn the bolts counterclockwise to decrease the tension. See Figure 1.
3. Carefully apply the anti-static spray to cover the top surface of the walking belt farthest from the motor. See Figure 2.

NOTICE: Hold the spray dispenser approximately 6" (13 cm) above the walking belt and point the spray away from the motor. Keep the spray only on the belt, not on the deck or mechanism. If spray goes off the belt, wipe the excess spray off the other parts of the machine.

4. Using your leg, manually advance the walking belts to the next unsprayed section of belt.
5. Do steps 3 and 4 again until all sections of the belts are coated with anti-static spray.
6. Wait until the belt dries fully (approximately 2-4 hours).
7. Tighten the tension adjustment bolts for the walking belts. Turn the bolts clockwise to increase the tension. See Figure 1.
8. Plug in the machine and turn on the power.
9. Inspect the walking belt alignment and tension before using the machine. Refer to "Walking Belt Adjustment" in this manual.

Note: Repeat the procedure to apply anti-static spray if static electric discharge occurs again. The machine will accumulate more static electric charge when the surrounding air is drier. Be sure to obey the manufacturer safety instructions for the anti-static product.

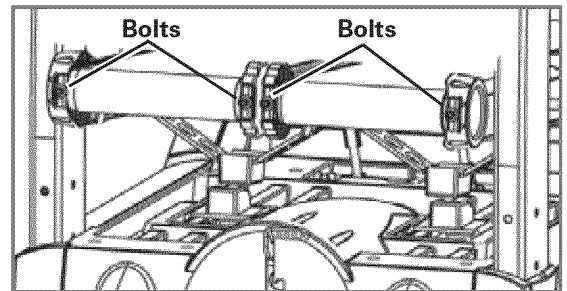

Figure 1 - Tension adjustment bolts

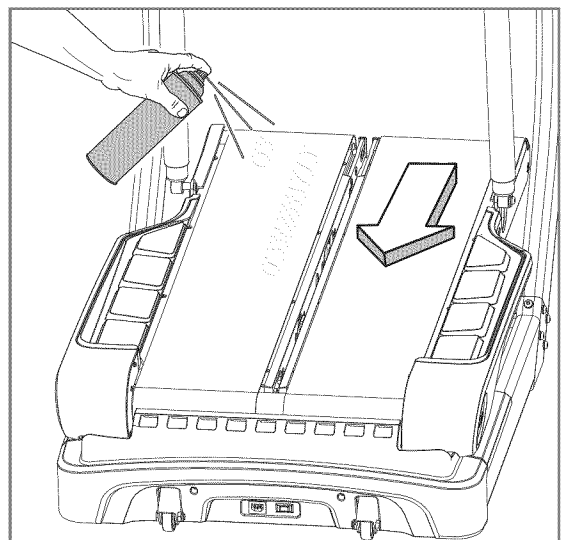





Figure 2 - Walking belts

Maintenance

Speed Sensor Verification (TC1000 only)

-  Do not use the machine for exercise purposes without completing Speed Sensor Verification (TC1000).
-  It is important to verify speed sensor operation (TC1000) after a power outage or after any electrical repair or replacement. Failure to follow this procedure prior to use could result in machine failure and could cause injury.
-  Do not stand on the Walking Belts during speed sensor verification. During the entire process, stand on the side foot support platforms or beside the machine.

1. Insert yellow safety key, plug the power cord into a wall outlet, and turn on the red Power Switch at the rear of machine.
2. Standing to the left of the machine, activate the Start/Stop switch. Belts should begin moving within a few seconds.
3. Allow belts to continue to turn for at least 15 seconds (elapsed time will be displayed on Console). If belts stop, note any error codes displayed on Console and turn power off at rear of machine. Contact customer service for assistance immediately at 1-800-605-3369.
4. Push FASTER button until SPEED display reads 1.5. Verify that belt speed increases and then holds constant at new speed.
5. Remove safety key. Belts should slow to a complete stop.
6. Replace safety key. Belts should remain stopped.
7. Push RESET button on Console. Your TC1000 is now ready to use. Review Owner's Manual for operating instructions.

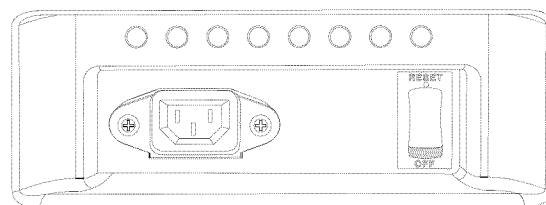

Main Power Switch "On"

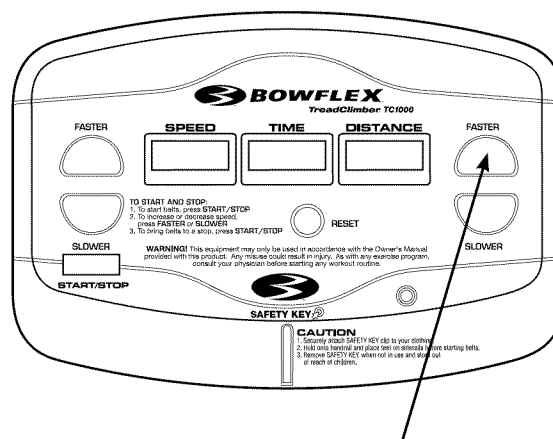

TC1000 Faster Button

NOTICE: If your TreadClimber® machine does not operate correctly as described in the above steps, do not use machine. Contact Customer Service for assistance immediately at 1-800-605-3369.

Maintenance

Calibration (TC3000 & TC5000)

- ⚠ Do not use the machine for exercise purposes without completing Calibration (TC3000/5000).
- ⚠ It is important to calibrate (TC3000/5000) after a power outage or after any electrical repair or replacement. Failure to follow this procedure prior to use could result in machine failure and could cause injury.
- ⚠ Do not stand on the Walking Belts during calibration. During the entire process, stand on the side foot support platforms or beside the machine.

Note: During calibration, observe the walking belt alignment. Belts do not need to be perfectly centered, but if they are far enough from center to cause a scraping sound, follow the Belt Alignment instructions in the Owner's Manual.

1. Plug the power cord into the the wall outlet. Turn on the red Power Switch at the rear of the machine.
2. Stand on the side foot support platforms or beside the machine. **DO NOT STAND ON THE WALKING BELTS.**
3. Press and hold down the POWER and SLOWER buttons.
4. Insert the Safety Key.

Note: If the Safety Key is not fully inserted into the safety keyhole, the TreadClimber® machine will not operate.

5. Release the POWER and SLOWER buttons. The TIME display will show "CAL", PrSS", "Strt".
6. Press the START/STOP button to start calibration.

Note: The belts will start and stop and the displays will show various numbers that relate to the calibration process. Do NOT interrupt calibration. If calibration is interrupted, turn off the power switch at the rear of machine and go back to Calibration Step 1.

7. Calibration will take about 30 seconds. When calibration has completed, belts will stop and calibration results will show in the TIME display.
8. If the display shows "CAL PASS" or "CAL DONE", remove and re-insert the safety key. Machine is ready to use. Review Owner's Manual for operating instructions.

If the display shows "CAL FAIL" or any other message, do not use machine. Contact Customer Service for assistance immediately at 1-800-605-3369.

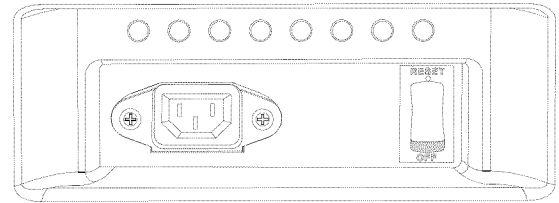

Main Power Switch "On"

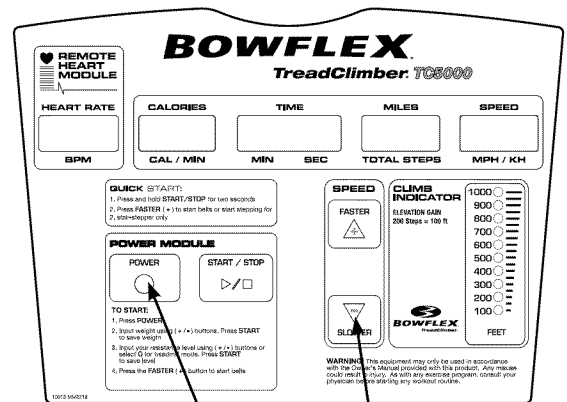

TC5000 Power & Slower Buttons

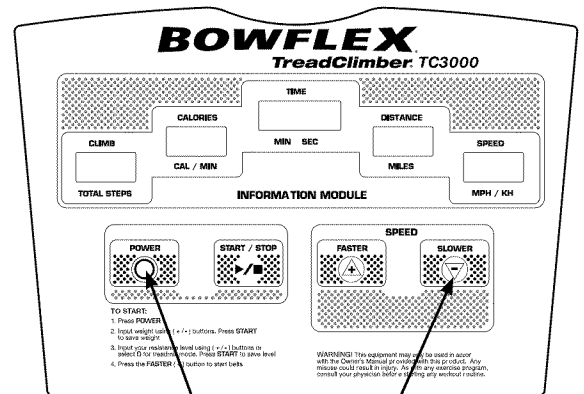

TC3000 Power & Slower Buttons

Note: During calibration the 30 meter LED on the TC5000 signifies the belt speed sensor, 305 meters LED is the step sensor. Some models of the TC 3000 will show the step sensor in the DISTANCE window as a heart and the speed sensor in the SPEED window as a heart.

Maintenance

If Calibration Fails (Screen Displays “Cal Fail” Message):

This error usually indicates that the console is unable to determine the speed of the belts. Take the following steps:

1. Unplug the unit and remove the three back covers.
2. Leave plastic covers off and contact customer care for assistance immediately at 1-800-605-3369.

Explanation of Calibration Display Messages (for information only):

During calibration, the TIME display will show you text messages updating you as to the status of calibration. When there is no text message in the TIME display window, the other displays will show the following:

HEART RATE (TC5000 Only) – will show the status of the motor control relay.

- “ON” signifies the power relay is on and energizing the motor.
- “OFF” signifies the motor control relay is off and not energizing the motor.

CALORIES/CAL PER MIN – will show the version number of the software.

TIME – will show either a text message regarding auto-calibration (“dOnE”, “Strt”, etc.) or the actual Pulse Width Modulation (PWM) number (a number that provides digital information about base unit functions to the console) if START/STOP, FASTER or SLOWER is pressed during calibration.

MILES/TOTAL STEPS (DISTANCE/MILES for TC3000) – will show the calibration of the total step count.

SPEED – will display the actual belt speed during the calibration function.

Determining Hours Used

To determine the number of hours you have used your TreadClimber® machine:

1. Stand on the side foot support platforms with the TreadClimber® Main Power Switch turned on.
2. Remove and re-insert the SAFETY KEY.
3. The total whole hours used will be displayed in the TIME display window. No fractions of, or partial hours will be displayed.
4. The software version will also be displayed in the MILES display window.
5. The display will only be visible for 3-5 seconds. Repeat removing and re-inserting the SAFETY KEY to view the display again.

Troubleshooting

Hot or Burning Odor

First check whether machine can calibrate and run properly. If machine calibrates and no error codes are displayed, this indicates that there are no problems with the motor, motor control board, or console.

Note: In most cases these are normal odors generated as the machine breaks in. There are various coatings that emit odors when they are new and subjected to the heat of normal machine operation. This process can be hastened by running the TreadClimber® fitness machine at 3 mph for approximately one hour. This should give the odors a chance to dissipate. Also, odors may occur any time a motor or motor control board is replaced. If machine is not new and no parts have recently been replaced, an odor may indicate belt lubrication is required. Refer to Walking Belt and Deck Lubrication for procedure and frequency.



Never attempt to make any diagnostic repairs on your own. Always contact a Bowflex® TreadClimber® representative at 1-800-605-3369. Allow them to guide you through the diagnostic process.

Getting Access to the TC5000/TC3000 Motor Control Board (MCB)

It is possible that you will need to be able to locate the Motor Control Board (MCB) during a service call to a TreadClimber® Representative at 1-800-605-3369.

The TC5000 MCB is located behind the right Plastic Drive Cover. Remove the right Plastic Drive Cover by using a #2 Phillips head screwdriver to unscrew the (3) #10 Phillips head screws attaching the Drive Cover to the base. Gently pull the right Plastic Drive Cover from the base of the unit, carefully setting the Drive Cover and the screws aside until you have completed your diagnostics with a TreadClimber® Representative.

Once you remove the Drive Cover, you will see the MCB.

A TreadClimber® Representative at 1-800-605-3369 will help you locate the LED lights on the MCB and guide you through basic diagnostic maintenance from this point—never attempt to repair or diagnose the TreadClimber® Machine without making a call to a TreadClimber® Representative.

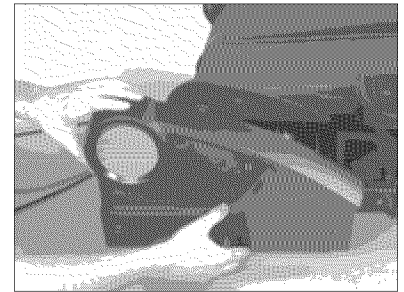

Removing the Right Plastic Drive Cover



MCB – MCB Cover not shown for clarity

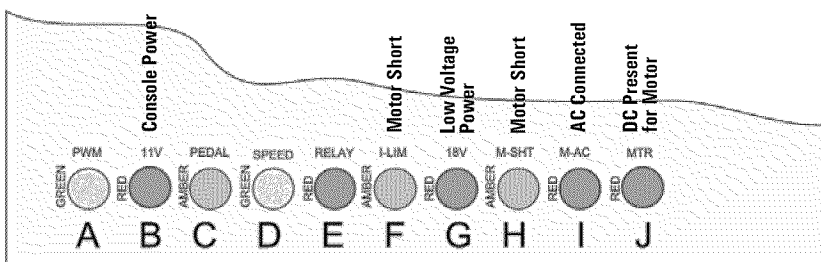

LEDs on Motor Control Board

Troubleshooting

Troubleshooting Procedures



Unless it is necessary to turn on the machine to do the procedure, always unplug the power cord from the wall outlet, and wait 5 minutes before performing repairs.



Some components of the equipment can be heavy or awkward. Enlist the service of a second person when you do maintenance steps involving these components. Do not try to do heavy or awkward steps on your own.

Condition / Problem	Things to Check	Solution
Unit will not power up/turn on/start	Outlet	Make sure outlet is functioning correctly. Verify this by plugging another object (ex: lamp) into the outlet. If outlet is connected to a light switch, check to make sure it is on. If outlet is not functioning find a working outlet.
	Power cord not plugged in	Make sure the power cord is firmly secured to AC inlet on the unit and firmly inserted into a non-GFI (and non-AFI) wall socket.
	Power switch turned off	Make sure the power switch at the rear of the unit is in the "ON" position.
	Safety key not plugged in	Plug Safety Key into console. (See Emergency Stop Procedure within the Important Safety Precautions section.)
Speed displayed is not accurate	LED Diagnostic needed	Remove rear plastic covers and contact customer service for assistance.
	Display set to wrong unit of measure (English/Metric)	Change display units (See Owner's Manual).
Heart rate not displayed while using chest strap (TC5000 only)	Out of calibration	Re-calibrate machine. (See Calibration procedure in this manual.)
	Transmitter not making good contact with skin	Make sure heart rate monitor is under clothing, against the skin, and as high under the pectoral muscles as is comfortable. Use saline solution (saliva or contact lens solution) to wet the electrode areas on the sensor unit.
	Electromagnetic interference	Turn off any television, AM radio, microwave, or computer within 6 feet (2 meters) of the TreadClimber® fitness machine. Try positioning the machine in another area.
	Chest strap transmitter	Test chest strap with another HR monitoring device such as HR watch or a machine at a gym. If transmitter has good skin contact and still is not found to be emitting HR signal, replace chest strap transmitter.
	HR receiver	If chest strap is known to work with other devices and no sources of interference are present, or console has been tested with a Pulse Simulator and is not receiving the signal, replace the HR receiver.
Walking belt misalignment	Rear belt guides	Belts should ride on top of triangular black belt guides at rear of treadles.
	Tracking adjustment	Belts are not required to be perfectly centered and are typically farther out in the rear than they are in the front. This may vary depending on user's stride. If belt is tracking to one side far enough to cause rubbing of belt, follow Belt Alignment procedure in this manual.

Troubleshooting

Condition / Problem	Things to Check	Solution
Speed dependent grinding or scraping noise in all modes	Belt alignment	Check walking belt alignment. Belt contact with metal guides under treadle can make loud grinding sound. If belts are misaligned, follow Belt Alignment procedure in this manual.
	Rollers or motor	Contact customer service for further assistance.
Hesitation or belt slipping when walking on unit	Belt tension	If belt hesitates or slips when walking on unit, it may be caused by either a loose walking belt or a loose drive belt. To determine the cause, do the following test: 1. Stand beside TreadClimber® fitness machine and set speed to 2 MPH. 2. Step on one treadle and attempt to stop movement. If one belt stops but roller at rear and other belt continue to turn, adjust walking belt tension. If both belts stop but motor is still turning, the drive belt tension should be adjusted.
	Walking belt tension	Adjust walking belt tension at the front of the unit using the 3/16 hex key on the adjustment bolts on each side of each front roller. Tighten (turn clockwise) each adjustment bolt in full turn increments. Be sure to adjust both bolts on each roller the same amount to keep belt alignment. After each adjustment, restart unit and check to see if belt slippage has been eliminated. Repeat if necessary. If slipping feel persists after several adjustments, stop and refer to drive belt checklist.
	Drive belt	<p>▲DANGER Disconnect power cord from machine and wait 5 minutes to ensure no residual power remains.</p> <p>Turn unit on its side to expose its underside. Verify motor is installed securely with shipping bolt removed:</p> <ul style="list-style-type: none"> - Motor bracket mounting tabs visible on underside of machine - Motor keeper in place - Shipping bolt removed <p>Return machine to upright position. Remove left rear plastic cover to expose “v” belt drive line and motor. Check belt installation. The grooved side of the belt should be in contact with the drive and motor pulleys; the smooth side should be facing out.</p> <p>Check motor tensioning assembly:</p> <ul style="list-style-type: none"> - Verify plastic bushings are not broken. If broken, replace motor tension bolt kit. - Verify bushings and spring are oriented correctly. <p>If belt is still loose, use a 1/2” wrench or socket to tighten motor tension nut. Check belt tension after each full turn. Belt should feel taut, but should still allow 1/8” - 1/2” deflection when pressed at the mid point. DO NOT OVER TIGHTEN. Replace cover when finished.</p>
“Tick” sound once per revolution or scraping noise from under treadle	Belt alignment	Belt seam may be contacting metal belt guide under treadle. Slight adjustment of belt should alleviate noise. Follow Belt Alignment procedure in this manual.

Troubleshooting

Condition / Problem	Things to Check	Solution
Climb Indicator display not updating (TC5000 only)	Size of steps taken	In order for a step to register, the pedals must pass each other completely. This ensures that the magnet on the treadle passes the step sensor. Make sure treadles are not locked in treadmill mode and that they are moving enough to register a step.
	Step sensor	Be sure step sensor wire is connected at rear of machine.
Knocking noises when unit is operating in TreadClimber® or stepper mode, but not in treadmill mode	Treadle alignment	Make sure treadles are centered between uprights and treadle is not contacting upright during use. If not centered, remove rear plastic covers to access rear baseplate bolts. Loosen bolts slightly to allow treadles to be centered. Once centered, tighten outer two bolts securely then tighten inner bolts securely.
	Drive pulley and motor pulley	<p>▲ DANGER Disconnect power cord from machine and wait 5 minutes to ensure no residual power remains.</p> <p>Remove left side plastic drive cover to expose “v” belt drive line.</p> <p>Using a ½” wrench, tighten the bolt that attaches the 4½” drive pulley to the drive shaft while holding the drive rollers still. Reinstall plastic drive cover.</p>
	Igus bushing	If knocking sound seems to be coming directly from the rear roller, check igus bushings and replace if cracked.
	Hydraulic cylinder bolts	Check and tighten both upper and lower bolts that connect the hydraulic cylinders to the unit. Make sure that the spacers on the cylinder studs are installed.
Belts stop turning and “err LS” or “err OS” is displayed	Calibration	Re-calibrate machine using Calibration procedure in this manual.
	Speed sensor	<ol style="list-style-type: none"> 1. Cycle power off and on. 2. Put the machine in calibration mode (see Calibration procedure in this manual) but do not start the Calibration routine. 3. Remove right rear plastic cover to view LED diagnostics on motor control board (MCB). <p>▲ Machine is on. Current is active. Do not touch electrical components, to avoid risk of electrical shock.</p> <ol style="list-style-type: none"> 4. Locate LEDs C & D on the motor controller board. LEDs may be lit or unlit. 5. Manually advance the treadle with your foot, and check if either LED is blinking. If C is blinking, then speed and step sensor jumper wire connections are reversed. Unplug both and switch to the correct locations. 6. If neither LED is blinking, then the speed sensor signal is not reaching the MCB. Check that the speed sensor wire is connected securely to the jumper wire at rear of machine. Make sure wire is not crimped or cut, and make sure other end is connected securely to P1 on the MCB. If LED D still does not flash, contact customer service. <p>Note: Do not progress to next step until D light is flashing and speed sensor has been properly adjusted.</p>

Troubleshooting

Condition / Problem	Things to Check	Solution
	I/O cables (cables connected in assembly Step 8)	<p>If LED D is flashing when the belts are turning but belts stop with err LS or OS displayed, the speed sensor signal is not reaching the console. This indicates a problem with the I/O cables.</p> <p>Turn off the power switch and unplug the machine.</p> <p>▲ DANGER To reduce the risk of electrical shock or unsupervised usage of the equipment, always unplug the power cord from the wall outlet and/or the machine and wait 5 minutes before cleaning, maintaining or repairing the machine. Place the power cord in a secure location.</p> <p>Inspect connections for signs of visible damage to any of the I/O cables. If no damage, check continuity using a multi-meter. If a multi-meter is not available, contact customer service for replacement cables and further assistance.</p>

Parts

Ordering Replacement Parts

Call a Bowflex® TreadClimber® Representative at 1-800-605-3369 to order replacement parts and get assistance with your specific replacement or service requirements. Refer to the Parts exploded views in this section or the TreadClimber® Parts Reference Guide, and Hardware and Tool List in the Assembly Manual.

TC1000 Console Assembly (Not illustrated)

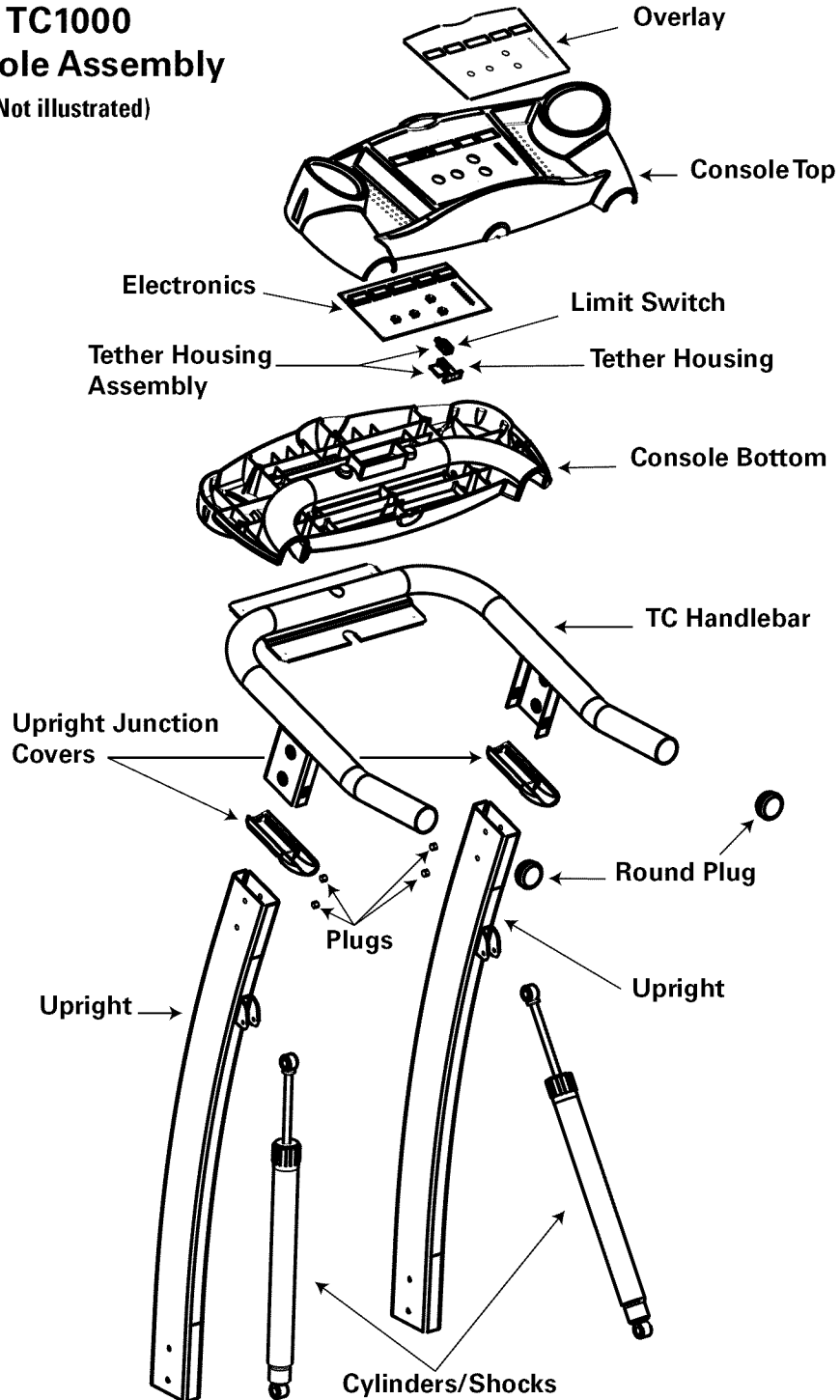

Parts

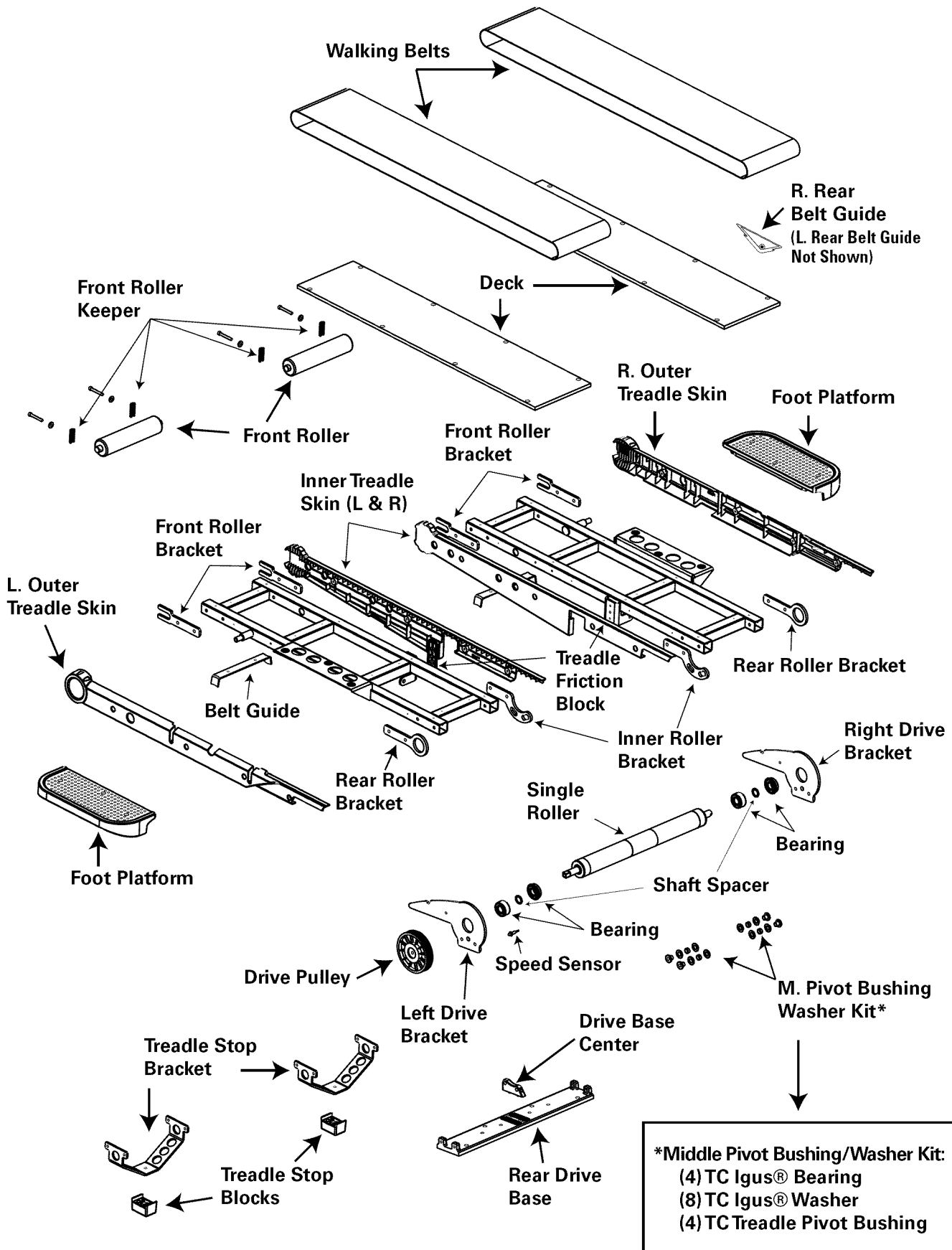

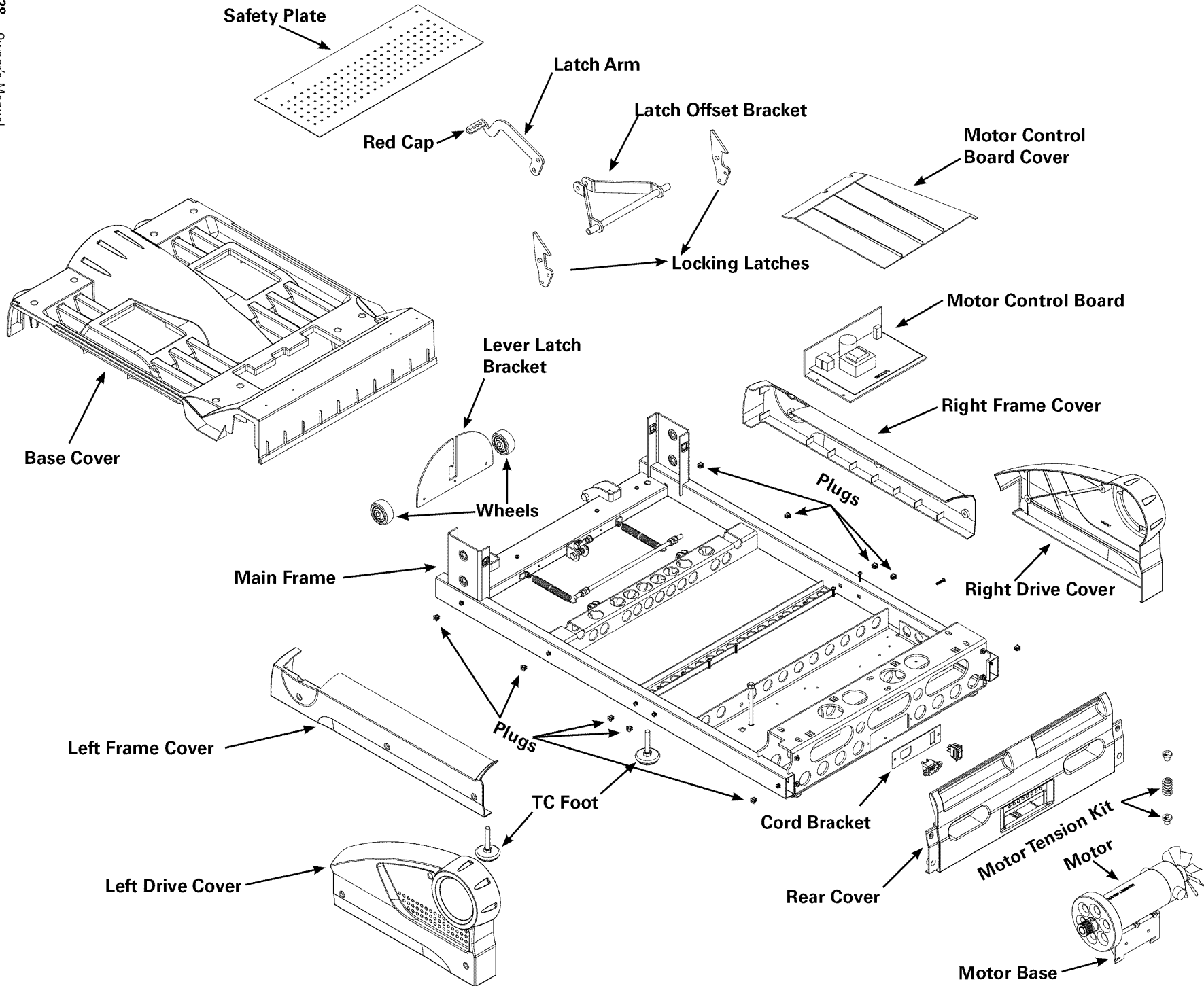

Bowflex® TreadClimber® 100% Satisfaction Guarantee

We want you to know that your Bowflex® TreadClimber® machine is a superior product. Your satisfaction is guaranteed. If, for any reason, you are not 100% satisfied with your TreadClimber® machine, please follow the instructions below to return your merchandise and receive a refund of the purchase price, less shipping and handling.

This TreadClimber® Satisfaction Guarantee applies only to merchandise purchased by consumers directly from Nautilus, Inc. This guarantee does not apply to sales made by dealers or distributors.

1. Call a TreadClimber® Representative at 1-800-NAUTILUS (1-800-628-8458) for a Return Authorization Number (RMA). An RMA will be granted if:
 - a. The Bowflex® TreadClimber® exercise machine was purchased directly from Nautilus, Inc.
 - b. The request to return the product is within 6 weeks of the delivery date of your merchandise.
2. If an RMA is granted, the following instructions will prevent delays in the processing of your refund.
 - a. The merchandise must be returned to the address given to you at the time of the Return Authorization Call.
 - b. All returned merchandise must be properly packaged in good condition, preferably in the original boxes.
 - c. The exterior of the boxes should be marked clearly with:
 - Return Authorization Number
 - Your Name
 - Your Address
 - Your Phone Number
 - d. Additionally, a piece of paper with your name, address and phone number or copies of your original invoice should be placed in each box of merchandise.
 - e. Your RMA number is time sensitive. Your shipment must be post marked within two weeks from the date the TreadClimber® Representative issued the Return Authorization Number.

NOTE: You are responsible for return shipping and for any damage or loss to merchandise that occur during return shipment. Nautilus recommends that you obtain tracking numbers and insure your shipment.

Unauthorized Returns

Nautilus, Inc. defines an unauthorized return as any merchandise returned to our facilities without a valid and current Return Merchandise Authorization (RMA) number issued by Nautilus. Failure to properly mark packages with a valid RMA number, or allowing an RMA number to expire, will cause Nautilus, Inc. to consider a return unauthorized. Any merchandise returned without a RMA number will not be subject to a refund or credit and Nautilus will discard the product. The customer assumes all shipping and handling charges for any unauthorized return.

