

CRAFTSMAN®

**12.5 Horsepower
33 Inch Dual Stage
120V. Electric Start
SNOW THROWER**

**MODEL NO.
536.881230**

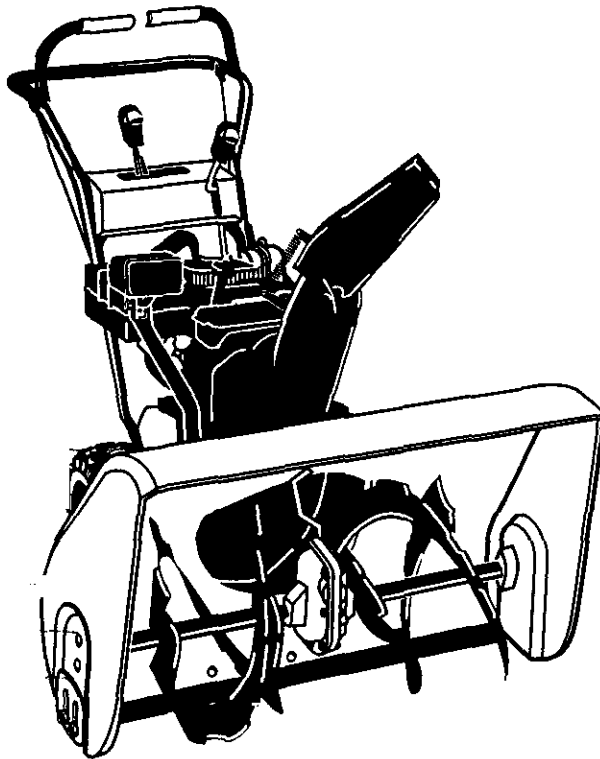

**Caution:
Read and follow all Safety
Rules and Operating
Instructions before first use
of this product.**

SEARS, ROEBUCK AND CO., Hoffman Estates, IL 60179 U.S.A.

F-001059J 07/23/99

SAFETY

ASSEMBLY

OPERATION

MAINTENANCE

PARTS LIST

ESPAÑOL

TABLE OF CONTENTS

Table of Contents	2	Service and Adjustments	18-22
Warranty	2	Storage	23
Safety Rules	2-4	Troubleshooting	24
Contents of Shipping Carton	4-5	Snow Thrower Repair Parts	25-36
Assembly	5-8	Engine Repair Parts	37-41
Operation	9-14	Spanish(Español)	42-67
Maintenance	15-17	Parts Ordering/Service	Back Cover

WARRANTY STATEMENT

LIMITED TWO-YEAR WARRANTY ON CRAFTSMAN SNOW THROWER

For two years from the date of purchase, when this Craftsman Snow Thrower is maintained, lubricated, and tuned up according to the operating and maintenance instructions in the owner's manual, Craftsman will repair, free of charge, any defect in material or workmanship.

If this Craftsman Snow Thrower is used for commercial or rental purposes, this warranty applies for only 90 days from the date of purchase.

This warranty does not cover the following:

- Items which become worn during normal use, such as spark plugs, drive belts and shear pins.
- Repairs necessary because of operator abuse or negligence, including bent crank shafts and the failure to maintain the equipment according to the instructions contained in the owner's manual.

WARRANTY SERVICE IS AVAILABLE BY RETURNING THE CRAFTSMAN SNOW THROWER TO THE NEAREST CRAFTSMAN SERVICE CENTER/DEPARTMENT IN THE UNITED STATES. THIS WARRANTY APPLIES ONLY WHILE THIS PRODUCT IS IN USE IN THE UNITED STATES.

This warranty gives you specific legal rights, and you may also have other rights which may vary from state to state.

Sears, Roebuck and Co., D817WA, Hoffman Estates, IL 60179



SAFETY RULES



Look for this symbol to point out important safety precautions. It means—ATTENTION!!! Become alert!!! Your safety is involved.

CAUTION: Always disconnect spark plug wire and place wire where it cannot contact spark plug to prevent accidental starting when setting-up, transporting, adjusting or making repairs.

IMPORTANT: Safety standards require operator presence controls to minimize the risk of injury. Your snow thrower is equipped with such controls. Do not attempt to defeat the function of the operator presence control under any circumstances.



California Proposition 65

WARNING: The engine exhaust from this product contains chemicals known to the State of California to cause cancer, birth defects or other reproductive harm.

TRAINING

1. Read the operator's manual carefully. Be thoroughly familiar with the controls and the proper use of the snow thrower. Know how to stop the snow thrower and disengage the controls quickly.
2. Never allow children to operate the snow thrower and keep them away while it is operating. Never allow adults to operate the snow thrower without proper instruction. Do not carry passengers.
3. Keep the area of operation clear of all persons, particularly small children and pets.
4. Exercise caution to avoid slipping or falling, especially when operating in reverse.

PREPARATION

1. Thoroughly inspect the area where the snow thrower is to be used and remove all doormats, sleds, boards, wires and other foreign objects.
2. Disengage all clutches before starting the engine (motor).
3. Do not operate the snow thrower without wearing adequate winter outer garments. Wear footwear that will improve footing on slippery surfaces.
4. Handle fuel with care; it is highly flammable.
 - (a) Use an approved fuel container.
 - (b) Never remove fuel tank cap or add fuel to a running engine or hot engine.
 - (c) Fill fuel tank outdoors with extreme care. Never fill fuel tank indoors.
 - (d) Replace fuel tank cap securely and wipe up spilled fuel.
 - (e) Never store fuel or snow thrower with fuel in the tank inside of a building where fumes may reach an open flame or spark.
 - (f) Check fuel supply before each use, allowing space for expansion as the heat of the engine (motor) and/or sun can cause fuel to expand.
5. Use extension cords and receptacles as specified by the manufacturer for all snow throwers with electric drive motors or electric starting motors.
6. Adjust the snow thrower height to clear gravel or crushed rock surfaces.
7. Never attempt to make any adjustments while the engine (motor) is running (except when specifically recommended by the manufacturer).
8. Let engine (motor) and snow thrower adjust to outdoor temperatures before starting to clear snow.
9. Always wear safety glasses or eye shields during operation or while performing an adjustment or repair to protect eyes from foreign objects that may be thrown from the snow thrower.

OPERATION

1. Do not operate this machine if you are taking drugs or other medication which can cause drowsiness or affect your ability to operate this machine.
2. Do not use this machine if you are mentally or physically unable to operate this machine safely.
3. Do not put hands or feet near or under rotating parts. Keep clear of the discharge opening at all times.
4. Exercise extreme caution when operating on or crossing gravel drives, walks, or roads. Stay alert for hidden hazards or traffic.
5. After striking a foreign object, stop the engine (motor), remove the wire from the spark plug, disconnect the cord on electric motors, thoroughly inspect the snow thrower for any damage, and repair the damage before restarting and operating the snow thrower.
6. If the snow thrower should start to vibrate abnormally, stop the (motor) and check immediately for the cause. Vibration is generally a warning of trouble.
7. Stop the engine (motor) whenever you leave the operating position, before unclogging the auger/impeller housing or discharge guide, and when making any repairs, adjustments, or inspections.
8. When cleaning, repairing, or inspecting, make certain the auger/impeller and all moving parts have stopped. Disconnect the spark plug wire and keep the wire away from the plug to prevent accidental starting.
9. Take all possible precautions when leaving the snow thrower unattended. Disengage the auger/impeller, stop engine, and remove key.
10. Do not run the engine indoors, except when starting the engine and for transporting the snow thrower in or out of the building. Open the outside doors; exhaust fumes are dangerous (containing CARBON MONOXIDE, an ODORLESS and DEADLY GAS).
11. Do not clear snow across the face of slopes. Exercise caution when changing direction on slopes. Do not attempt to clear steep slopes.
12. Never operate the snow thrower without proper guards, plates or other safety protective devices in place.
13. Never operate the snow thrower near glass enclosures, automobiles, window wells, drop-offs, and the like without proper adjustment of the snow discharge angle. Keep children and pets away.
14. Do not overload the machine capacity by attempting to clear snow at too fast a rate.
15. Never operate the snow thrower at high transport speeds on slippery surfaces. Look behind and use care when backing.
16. Never direct discharge at bystanders or allow anyone in front of the snow thrower.

17. Disengage power to the auger/impeller when snow thrower is transported or not in use.
18. Use only attachments and accessories approved by the manufacturer of the snow thrower (such as tire chains, electric start kits, etc).
19. Never operate the snow thrower without good visibility or light. Always be sure of your footing, and keep a firm hold on the handles. Walk; never run.

MAINTENANCE AND STORAGE

1. Check shear bolts and other bolts frequently for proper tightness to be sure the snow thrower is in safe working condition.
2. Never store the snow thrower with fuel in the fuel tank inside a building where ignition sources are present such as hot water and space heaters, clothes dryers, and the like. Allow the engine to cool before storing in any enclosure.
3. Always refer to operator's manual instructions for important details if the snow thrower is to be stored for an extended period.

Contents of Parts Bag

- 1 - Owner's Manual (not shown)
- 1 - Parts Bag (not shown)
- 1 - Packet of Fuel Stabilizer (not shown)
- Non Assembly parts are found in toolbox located on top of belt cover.
- 1 - Warranty Card (not shown)

4. Maintain or replace safety and instruction labels, as necessary.
5. Run the snow thrower a few minutes after throwing snow to prevent freeze-up of the auger/impeller.

⚠ WARNING: This snow thrower is for use on sidewalks, driveways and other ground level surfaces.

Caution should be exercised while using on steep sloping surfaces. **DO NOT USE SNOW THROWER ON SURFACES ABOVE GROUND LEVEL** such as roofs of residences, garages, porches or other such structures or buildings.

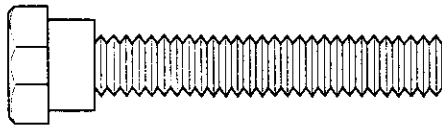
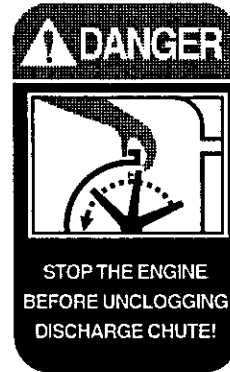

* 2 - Spare Shear Bolts



* 2- Spare Shear Nuts

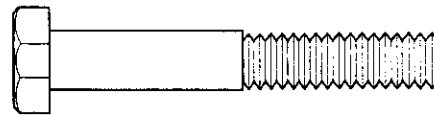

1-3/8-16 x 2 In. Hex Head Bolt



1 -3/8 In. Flatwasher

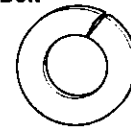

1 - 3/8 In. Lockwasher



1- 3/8 In. Hex Nut

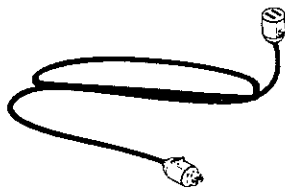

1 - Starter Motor Cord

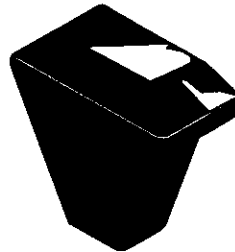

2- Shifter Knobs

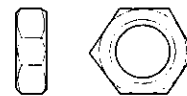

2 - 3/8-16 Hex Jam Nuts

Parts packed separately in carton (not shown full size)



2 - Ignition Keys
(Attached to engine in plastic bag)

ASSEMBLY

⚠ CAUTION: Always wear safety glasses or eye shields while assembling snow thrower.

TOOLS REQUIRED FOR ASSEMBLY

- 1 - Knife to cut carton and plastic ties
- 2 - 1/2 inch wrenches (or adjustable wrenches)
- 2 - 9/16 inch wrenches (or adjustable wrenches)
- 1 - Pliers (to spread cotter pin)
- 1 - Screwdriver
- 1 - Air pressure gauge
- 1 - Measuring tape or ruler

The figure below shows the snow thrower in the shipping carton.

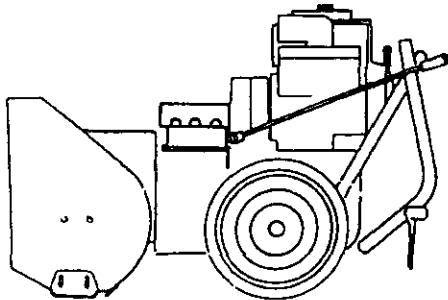

The figure below shows the snow thrower completely assembled.

References to the right or left hand side of the snow thrower are from the viewpoint of the operator's position behind the unit.

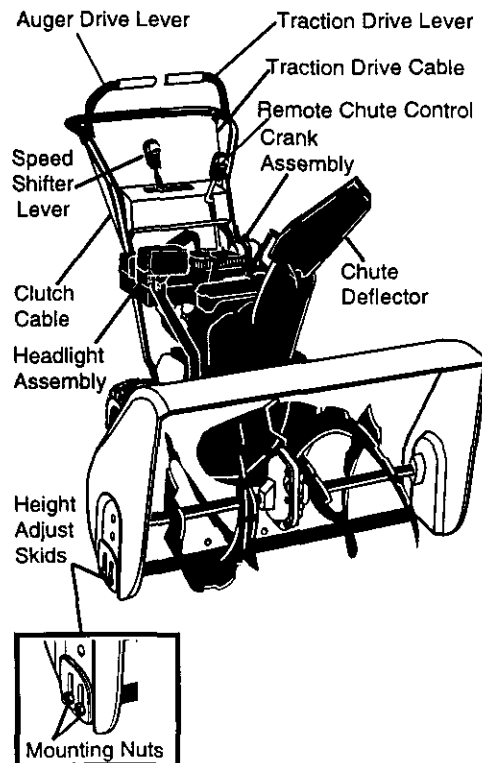

HOW TO SET UP YOUR SNOW THROWER

NOTE: Place fuel stabilizer in a safe place until needed for storage.

- Remove top pallet from carton.
- Cut and discard the plastic ties securing the chute rod to the upper pallet and place aside. Discard pallet.
- Cut all four corners of the carton from top to bottom and lay the panels flat.
- Cut the bands holding the snow thrower to the lower pallet.
- Remove snowthrower from lower pallet.
- Remove the packing material from the handle assembly and all protective material from the unit and discard.
- Cut ties securing the clutch control cables.

TO INSTALL THE UPPER HANDLE AND CRANK ASSEMBLY

- Loosen, but do not remove the screws, flatwashers, lockwashers and hex nuts in the upper holes of the lower handle. See figure below.

NOTE: Make sure the cables are not caught between the upper and lower handle.

- Raise upper handle into operating position. Upper handle should be to the outside of the lower handle.

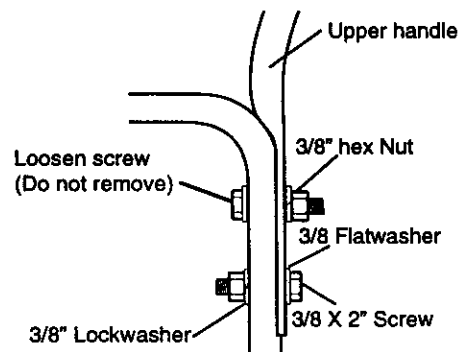

- Install hardware supplied in the parts bag (Screw, flatwasher, lockwasher, and hex nut) into lower hole on right hand side of handles. Do not tighten until all screws are in place. See figure above.

NOTE: If the cables have become disconnected from the clutch levers, reinstall the cables as shown in next figure.

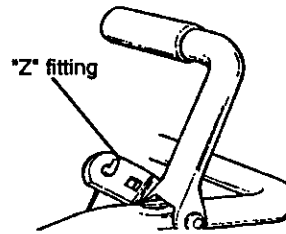

NOTE: If control cables have become unattached from motor mount frame, reconnect cables as show in figure below.

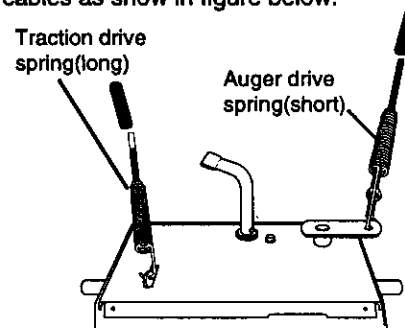

- Locate crank assembly removed earlier and remove the 3/8" nylon locknut and flatwasher from the eye bolt assembly. See figure below.
- Reinstall flatwasher and adapter. Install eye bolt through lower hole in the left hand side of the handle. See figure below.
- Install the 3/8" flatwasher and the 3/8" nylon locknut on the eye bolt as shown in figure below.

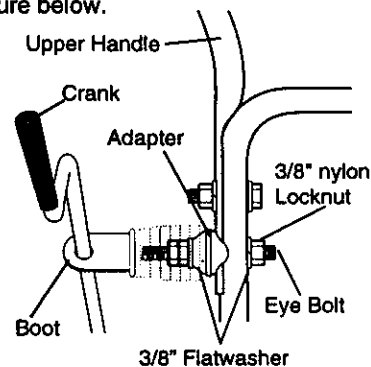

- Carefully remove cotter pin, clevis pin and universal joint pin from yoke end of crank rod assembly as shown in first figure on page 7.
- Place universal joint into end of worm gear lining up large holes. Insert universal joint pin (ensure opening in pin is in line with small openings in universal joint).

- Place yoke end of crank rod around universal joint, lining up openings. Insert clevis pin through assembly and secure with cotter pin. Spread ends of cotter pin to lock in place. See figure below.
- Tighten nut on eye bolt, keeping eye in line with the rod while tightening the inside securely.
- Tighten all handle bolts with a 9/16" wrench.

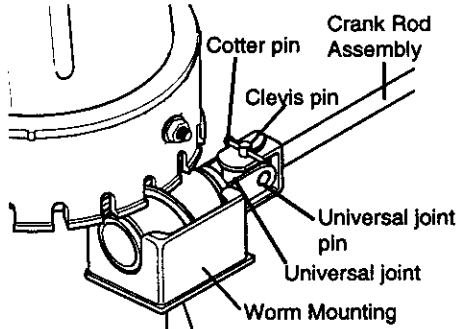

ASSEMBLE SNOW CHUTE

- Remove back carriage bolt, see figure below.

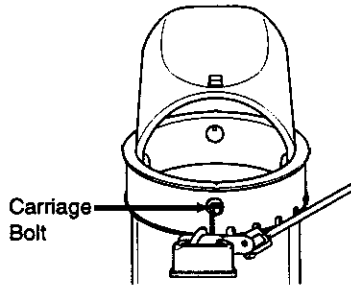

- Tilt chute back into operating position. See figure below.

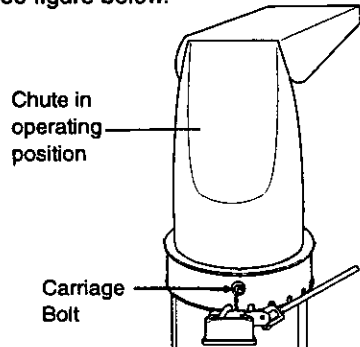

- Replace carriage bolt.
- Tighten carriage bolt securely. **NOTE:** Check all bolts in chute ring for tightness.
- Remove and discard packaging used to protect chute.

NOTE: DO NOT cut tie strap located on chute deflector at this time.

- Push remote chute control lever into "Chute Deflector Down" position.
- Cut tie strap on chute deflector as shown in figure below.

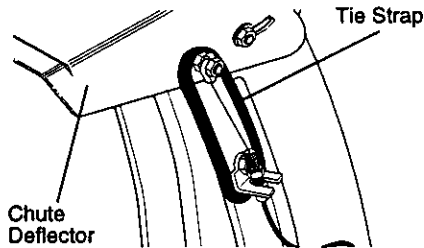

SPEED SELECTOR ROD

- Cut plastic tie securing shifter lever assembly to the shifter bracket. See figure below.

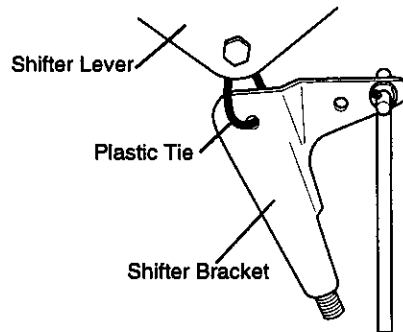

- Remove locknut, washer, spring and the bolt. See figure below.

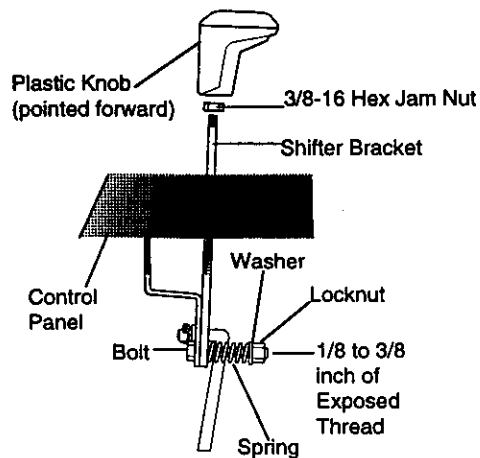

- Position shifter lever assembly as shown in figure below.

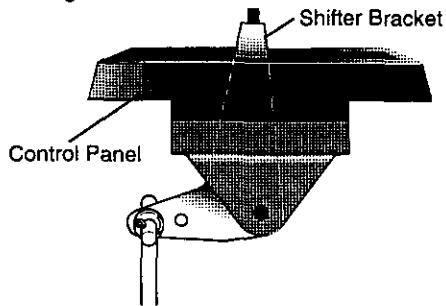

- Reinstall bolt, spring, washer and locknut. See last figure on page 7.
- Tighten locknut until 1/8 to 3/16 inch of the bolt threads protrude past the locknut.
- Thread the 3/8-16" hex jam nut onto the lever until the nut reaches the end of the thread. See last figure on page 7.
- Thread the plastic knob as far as possible and ensure that the knob points forward.
- Tighten the 3/8-16" hex jam nut against the knob securely.
- Move shifter through all speeds to ensure proper tension of the spring. If shifter lever sticks in any of the notches, loosen locknut 1/2 turn at a time until shifter lever moves more freely.

REMOTE CHUTE CONTROL KNOB

- Thread the 3/8-16" hex jam nut onto the lever until the nut reaches the end of the thread. See figure below.
- Thread the plastic knob as far as possible and ensure that the knob points forward.
- Tighten the 3/8-16" hex jam nut against the knob securely.

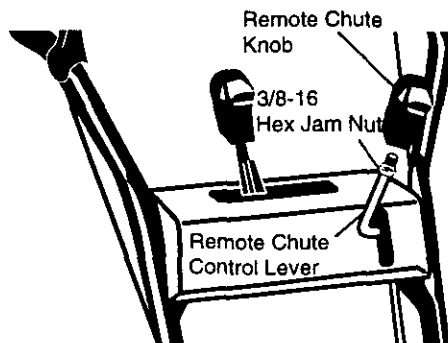

HEADLIGHT

The headlight on your snowthrower is positioned in down position for packaging purposes. Rotate upwards for operating position.

✓ CHECKLIST

Before you operate your new snow thrower, to ensure that you receive the best performance and satisfaction from this quality product, please review the following checklist:

- ✓ All assembly instructions have been completed.
- ✓ The discharge chute rotates freely.
- ✓ No remaining loose parts in carton.

While learning how to use your snow thrower, pay extra attention to the following important items:

- ✓✓ Engine oil is at proper level.
- ✓✓ Make sure gas tank is filled properly with clean, fresh, unleaded gasoline.
- ✓✓ Become familiar with all controls-their location and function. Operate controls before starting engine.

OPERATION

KNOW YOUR SNOW THROWER

READ THIS OWNER'S MANUAL AND SAFETY RULES BEFORE OPERATING YOUR SNOW THROWER. Compare the illustrations with your SNOW THROWER to familiarize yourself with the location of various controls and adjustments. Save this manual for future reference.

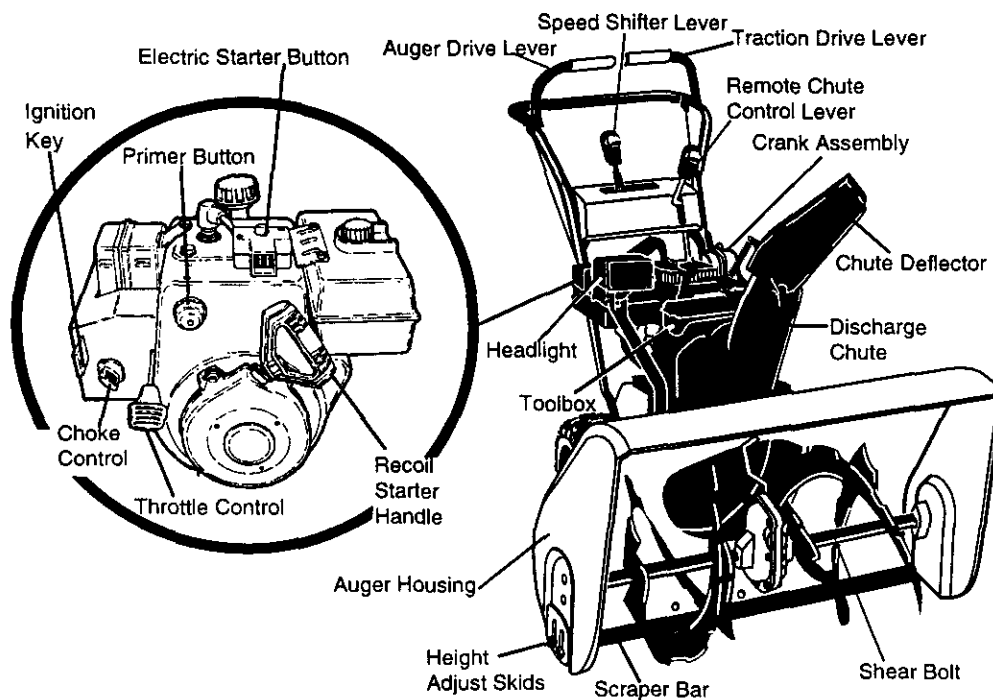
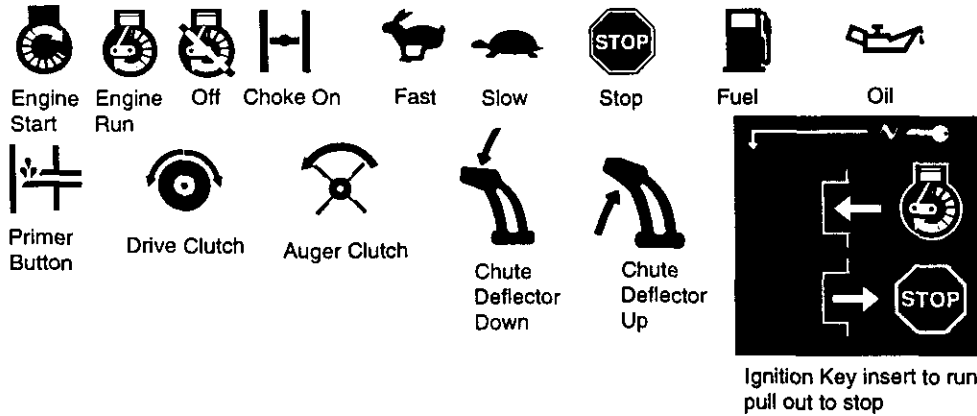

The operation of any snow thrower can result in foreign objects being thrown into the eyes, which can result in severe eye damage. Always wear safety glasses or eye shields while operating the snow thrower.

We recommend standard safety glasses or a wide vision safety mask for over your glasses, available at Craftsman Retail Stores or Service Centers.

Auger Drive Lever – Starts and stops the auger and impeller (snow gathering and throwing).

Traction Drive Lever – Propels the snow thrower forward and in reverse.

Speed Select Lever – Selects the speed of snow thrower (6 speeds forward and 2 speeds reverse).

Crank Assembly – Changes the direction of snow throwing through the discharge chute.

Chute Deflector – Changes the distance the snow is thrown.

Discharge Chute – Changes the direction the snow is thrown.

Choke Control – Used to start a cold engine.

Height Adjust Skids – Adjusts the ground clearance of the auger housing.

Ignition Key – Must be inserted to start the engine.

Primer Button – Injects fuel directly into the carburetor manifold for fast starts in cold weather.

Recoil Starter Handle – Starts the engine manually.

Throttle Control – Controls the engine speed.

Electric Starter Button – Used to start the engine using the 120 V. electric starter.

Remote Chute Control Lever- Push forward to discharge snow high and far. Pull remote lever back to discharge snow down.

Shear Bolts - Are special bolts that are designed to break (to protect the machine) if an object becomes lodged in the auger housing. Use of a harder bolt will destroy the protection provided by the shear bolt.

Toolbox - Spare shear pins and spacers are located in toolbox.

CAUTION: Read owner's manual before operating machine. Never direct discharge toward bystanders. Release the auger control bar and stop the engine before unclogging discharge chute or auger housing and before leaving the machine.

HOW TO USE YOUR SNOW THROWER

TO STOP YOUR SNOW THROWER

- To stop throwing snow, release the auger drive lever (see figure below).
- To stop the wheels, release the traction drive lever.
- To stop the engine, push the throttle control lever to off and pull out (**DO NOT TURN**) the ignition key, see figure on page 9.

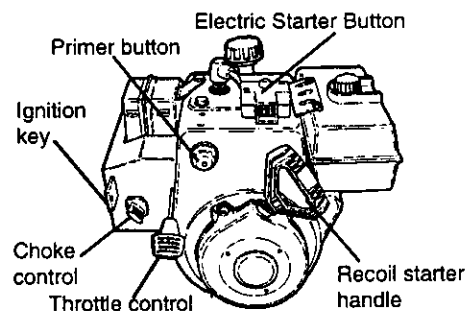

TO CONTROL SNOW DISCHARGE

- Turn the crank assembly to set the direction of the snow throwing.
- Adjust snow chute deflector to set the distance. Push remote lever forward to discharge snow down. Pull remote lever back to discharge snow high and far. See figure below.

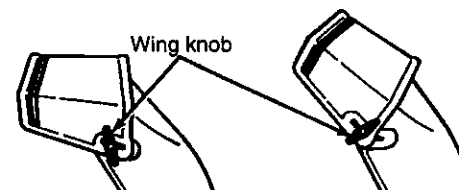

TO MOVE FORWARD AND BACKWARD

- To shift, release the traction drive lever and move the speed shifter lever to the speed you desire. Ground speed is determined by snow conditions. Select the speed you desire by moving the speed shifter lever into the appropriate area on the control panel.
 - Speeds 1, 2 - Wet, Heavy, Extra Deep
 - Speed 3 - Light
 - Speed 4 - Very Light
 - Speeds 5, 6 - Transport only

- Engage the traction drive lever as shown in next figure, left hand. As the snow thrower starts to move, maintain a firm hold on the handles, and guide the snow thrower along the clearing path. Do not attempt to push the snow thrower.
- To move the snow thrower backward, move the speed shifter lever into first or second reverse and engage the traction drive lever (left hand).

IMPORTANT: Never move the speed shifter lever while the traction lever is down.

TO THROW SNOW

- Push down the auger drive lever, see figure below, release to stop throwing snow.

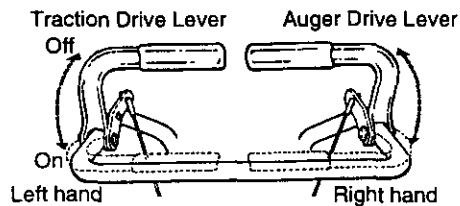

TO USE WHEEL LOCKOUT PIN

- The left hand wheel is secured to the axle with a klick pin, see figure below. This unit was shipped with this klick pin in the locked position (klick pin through hole in wheel).

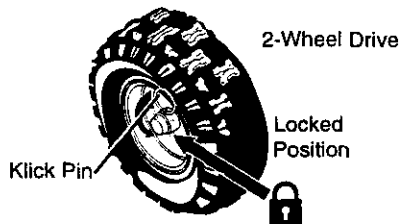

- For ease of maneuverability in light snow conditions, disconnect the klick pin from the wheel locked position and push into the single wheel drive position (klick pin through axle hole only), see figure below.

NOTE: Make sure that the klick pin is in the single wheel drive position, through axle hole only and not through the hole in wheel.

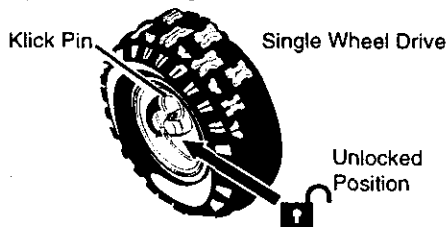

BEFORE STARTING THE ENGINE

- If the snow thrower must be moved without the aid of the engine, it is easier to pull the snow thrower by the handles rather than pushing.
- Before you service or start the engine, familiarize yourself with the snow thrower. Be sure you understand the function and location of all controls.

NOTE: Check tension of clutch cables before starting the engine (See To Adjust The Control Cables paragraph on page 19).

- Be sure that all fasteners are tight.
- Make sure the height adjust skids are properly adjusted (See To Adjust Skid Height paragraph on page 18).
- Check tire pressure (14 to 17 pounds). See side of tire for maximum inflation. Do not exceed listed maximum pressure.

CHECK THE OIL

NOTE: The engine was shipped from the factory filled with oil. Check the level of the oil. Add oil as needed.

- Make sure the unit is level.
 - NOTE:** Do not check the level of the oil while the engine runs.
- Remove the oil fill cap/dipstick. Check the oil.

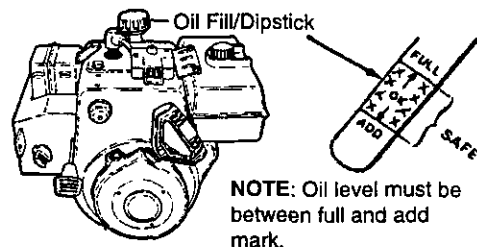

- If necessary, add oil until the oil reaches the FULL mark on the oil fill cap/dipstick (see figure above). Do not add too much oil.
- Tighten the fill cap/dipstick securely each time you check the oil level.

NOTE: For extreme cold operating conditions of 0°F and below, use a partial synthetic 0W30 motor oil for easier starting.

NOTE: S.A.E. 5W30 motor oil may be used to make starting easier in areas where temperature is consistently 20°F or lower.

FILL GAS

NOTICE: ENGINES WHICH ARE CERTIFIED TO COMPLY WITH CALIFORNIA AND US EPA EMISSION REGULATIONS FOR ULGE ENGINES: Are certified to operate on regular unleaded gasoline. Include the following emission control system(s): EM, TWC (if so equipped). Include any adjustable features - therefore no other adjustments are needed.

WARNING: Experience indicates that alcohol blended fuels (called gasohol or those using ethanol or methanol) can attract moisture which leads to separation and formation of acids during storage. Acidic gas can damage the fuel system of an engine while in storage.

To avoid engine problems, the fuel system should be emptied before storage for 30 days or longer. Start the engine and let it run until the fuel lines and carburetor are empty. Use the carburetor bowl drain to empty residual gasoline from the float chamber. Use fresh fuel next season (See Storage instructions on page 23 for additional information).

For extreme cold operating conditions of 0°F and below, use a partial synthetic 0W30 motor oil for easier starting.

Never use engine or carburetor cleaner products in the fuel tank or permanent damage may occur.

Fill the fuel tank with a fresh, clean, unleaded regular, unleaded premium, or reformulated automotive gasoline only. **DO NOT** use leaded gasoline. Be sure that the container you pour the gasoline from is clean and free from rust or other foreign particles.

 Never use gasoline that may be stale from long periods of storage in the container.

CAUTION: Gasoline is flammable and caution must be used when handling or storing it.

Do not fill fuel tank while snow thrower is running, when it is hot, or when snow thrower is in an enclosed area.

Keep away from open flame or an electrical spark and **DO NOT SMOKE** while filling the fuel tank.

Never fill the tank completely. Fill the tank to within 1/4" - 1/2" from the top to provide space for expansion of fuel.

Always fill fuel tank outdoors and use a funnel or spout to prevent spilling.

Make sure to wipe up any spilled fuel before starting the engine.

Store gasoline in a clean, approved container. **TO STOP ENGINE** keys in place on the container.

- To stop engine, move the throttle control lever to  (STOP) position and remove key. Keep the key in a safe place. The engine will not start without the key.



NOTE: DO NOT turn key.

TO START ENGINE (Electric Starter)

Be sure that the engine has sufficient oil. The snow thrower engine is equipped with a 120 volt A.C. electric starter and recoil starter. Before starting the engine, be certain that you have read the following information:

 **CAUTION:** This starter is equipped with a three-wire power cord and plug and is designed to operate on 120 volt AC household current. It must be properly grounded at all times to avoid the possibility of electrical shock which may be injurious to operator. Follow all instructions carefully as set forth in the "To Start Engine" section. Determine that your house wiring is a three-wire grounded system. Ask a licensed electrician if you are not sure. If your house wire system is not a three-wire system, do not use this electric starter under any conditions. If your system is grounded and a three-hole receptacle is not available at the point your starter will normally be used, one should be installed by a licensed electrician. When connecting 120 volt AC power cord, always connect the cord to the switch box on the engine first, then plug the other end into the three-hole grounded receptacle. When disconnecting power cord, always unplug the end in the three-hole grounded receptacle first.

COLD START

- Be sure the auger drive and traction drive levers are in the disengaged (released) position.
- Move the throttle control to  (FAST) position. See figure on page 9.
- Remove the keys from the plastic bag. Insert one key into the ignition slot. Be sure it snaps into place. **DO NOT TURN KEY.** Keep the second key in a safe place.
- Rotate the choke knob to  choke ON position. See figure on page 9.

- Connect the power cord to the switch box on the engine.
- Plug the other end of the power cord into a three-hole, grounded 120 volt A.C. receptacle.
- Push the primer button while covering the vent hole as follows: (Remove finger from primer button between primes). See figure on page 9 for location.
 - One time if temperature is above 50°F.
 - Two times if temperature is 50°F to 15°F.
 - Four times if temperature is below 15°F.
- Push down on the starter button until the engine starts. Do not crank for more than 10 seconds at a time. This electric starter is thermally protected. If overheated it will stop automatically and can be restarted only when it has cooled to a safe temperature (a wait of about 5 to 10 minutes is required).
- When the engine starts, release the starter button and move choke lever to "1/2 choke" position. When engine runs smoothly, move choke lever to "No Choke" Position.
- Disconnect the power cord from the receptacle first and then from the switch box on engine.



NOTE: Allow the engine to warm up for several minutes before blowing snow in temperatures below 0°F.

- Run the engine at full throttle  (FAST) when throwing snow.

TO START ENGINE (Recoil Starter)

Be sure that the engine has sufficient oil. The snow thrower engine is equipped with a recoil starter. Before starting the engine, be certain that you have read the following information:

COLD START

- Be sure the auger drive and traction drive levers are in the disengaged (released) position.
- Move the throttle control to  (FAST) position. See figure on page 9 for location.
- Remove the keys from the plastic bag. Insert one key into the ignition slot. Be sure it snaps into place. **DO NOT TURN KEY.** Keep the second key in a safe place.
- Rotate the choke knob to  choke ON position. See figure on page 9.

- Push the primer button, see figure on page 9, while covering the vent hole as follows: (Remove finger from primer button between primes).
 - One time if temperature is above 50°F.
 - Two times if temperature is 50°F to 15°F.
 - Four times if temperature is below 15°F.
 - Pull the recoil starter handle rapidly. Do not allow the handle to snap back, but allow it to rewind slowly while keeping a firm hold on the starter handle.
 - As engine starts warm up move choke lever to "1/2 choke" position. When engine runs smoothly, move choke lever to "No Choke" Position.
- NOTE:** Allow the engine to warm up for several minutes before blowing snow in temperatures below 0°F.
- Run the engine at full throttle  (FAST) when throwing snow.

WARM START

If restarting a warm engine after a short shutdown, leave choke at (OFF) and do not push the primer button. If the engine fails to start, follow the Cold Start Instructions on page 13.

FROZEN RECOIL STARTER

If the starter is frozen and will not turn engine:

- Pull as much rope out of the starter as possible.
- Release the starter handle and let it snap back against the starter.

If the starter still fails to turn engine, repeat the two previous steps until the starter engages. Then continue with the directions for cold start.

To help prevent possible freeze-up of recoil starter and engine controls, proceed as follows after each snow removal job.

- **With the engine running**, pull the starter rope hard with a continuous full arm stroke three or four times. Pulling of starter rope will produce a loud clattering sound. This is not harmful to the engine or starter.
- **With the engine not running**, wipe all snow and moisture from the carburetor cover in area of control levers. Also move throttle control, choke control, and starter handle several times.

 **CAUTION:** Never run engine indoors or in enclosed, poorly ventilated areas. Engine exhaust contains carbon monoxide, an odorless and deadly gas. Keep hands, feet, hair and loose clothing away from any moving parts on engine and snow thrower.

WARNING: Temperature of muffler and nearby areas may exceed 150° F. Avoid these areas.

DO NOT allow children or young teenagers to operate or be near snow thrower while it is operating.

 **CAUTION:** Do no attempt to remove any item that may become lodged in auger without taking the following precautions:

- Release auger drive and traction drive levers.
- Move throttle lever to stop position.
- Remove **(DO NOT TURN)** ignition key.
- Disconnect spark plug wire.
- Do not place your hands in the auger or discharge chute. Use a pry bar.

SNOW THROWING TIPS

- For maximum snow thrower efficiency in removing snow, adjust ground speed, **NEVER** the throttle. Go slower in deep, freezing, or wet snow. If the wheels slip, reduce forward speed. The engine is designed to deliver maximum performance at full throttle and should be run at this power setting at all times. Most efficient snow blowing is accomplished when the snow is removed immediately after it falls.
- For complete snow removal, slightly overlap each path previously taken. Use more overlap in deep snow to prevent overloading.
- The snow should be discharged down wind whenever possible. In windy conditions, lower the chute deflector to direct discharged snow close to the ground, where it is less likely to blow into unwanted areas.
- For normal usage, set the skids so that the scraper bar is 1/8" above the skids. For extremely hard-packed snow surfaces, adjust the skids upward so that the scraper bar touches the ground.
- On gravel or crushed rock surfaces, set the skids at 1-1/4" below the scraper bar (See To Adjust Skids Height paragraph on page 18). Stones and gravel must not be picked up and thrown by the machine.
- After the snow throwing job has been completed, allow the engine to idle for a few minutes, which will melt snow and accumulated ice off the engine.
- Clean the snow thrower thoroughly after each use.
- Remove ice and snow accumulation and all debris from the entire snow thrower, and flush with water (if possible) to remove all salt or other chemicals. Wipe snow thrower dry.

MAINTENANCE

CUSTOMER RESPONSIBILITIES

SERVICE RECORDS Fill in dates as you complete regular service	SCHEDULE								SERVICE DATES	
	After first 2 Hours	Before Each Use	As Needed	Every 5 Hours	Every 10 Hours	Every 25 Hours	Each Season	Before Storage		
Tighten All Screws & Nuts			✓							
Lubricate Pivot Points					✓			✓		
Lubricate Auger Shaft (See Shear Bolt Replacement)					✓			✓		
Lubricate Disc Drive Plate Zerk						✓		✓		
Check Spark Plug						✓	✓			
Check Engine Oil Level		✓		✓			✓			
Change Engine Oil						✓	✓			
Check Fuel		✓								
Drain Fuel								✓		
Check Auger Clutch Cable Adjustment (See Cable Adj)	✓						✓			
Check Traction Clutch Cable Adjustment (See Cable Adj)	✓						✓			
Check Drive Belts	✓					✓	✓			

PRODUCT SPECIFICATIONS

HORSE POWER:	12.5 HP
DISPLACEMENT:	21.82 cu. in.
GASOLINE CAPACITY:	4 quart (unleaded)
OIL (26 oz. Capacity):	5W-30
SPARK PLUG:	Champion RJ19LM (Gap .030) or Equivalent
VALVE CLEARANCE:	Intake: 0.10 In. Exhaust: .010 In.

Some adjustments will need to be made periodically to properly maintain your snow thrower.

LUBRICATION CHART

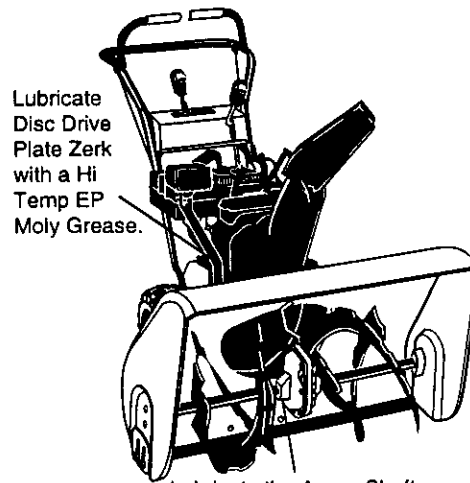

Lubricate Disc Drive Plate Zerk with a Hi Temp EP Moly Grease.

Lubricate the Auger Shaft. Coat with a clinging type grease such as Lubriplate or fiber impregnated grease.

GENERAL RECOMMENDATIONS

The warranty on this snow thrower does not cover items that have been subjected to operator abuse or negligence. To receive full value from the warranty, the operator must maintain the snow thrower as instructed in this manual. The above chart is provided to assist the operator in properly maintaining the snow thrower.

SNOW THROWER AFTER FIRST USE

- Check for any loose or damaged parts after each use.
- Tighten any loose fasteners.
- Check and maintain the auger.

AFTER EACH USE

- Remove all snow and slush off the snow thrower to prevent freezing of auger or controls.
- Check controls to make sure they are functioning properly.
- If any parts are worn or damaged, replace immediately.

SNOW THROWER

LUBRICATION - EVERY 10 HOURS

- Auger Shaft – Using a hand grease gun, lubricate the auger shaft zerk fittings (See figure below) every ten (10) operating hours. Each time a shear bolt is replaced (See To Replace Auger Shear Bolt on page 22), the auger shaft **MUST** be greased.

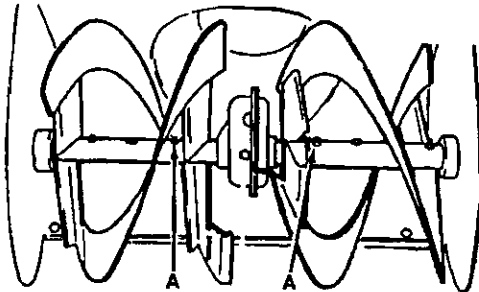

- For storage or when replacing shear bolts, remove shear bolts and lubricate auger shaft zerks. Rotate augers several times on the shaft and reinstall the shear bolts.
- See Lubrication Chart diagram on page 15 for lubrication points and type of lubricant.

LUBRICATION - EVERY 25 HOURS

- Lubricate Disc Drive Plate every twenty-five (25) hours and at the end of the season and/or before storage.

To Lubricate:

- Position speed selector lever in first gear.
- Stand the snow thrower up on the auger housing end.

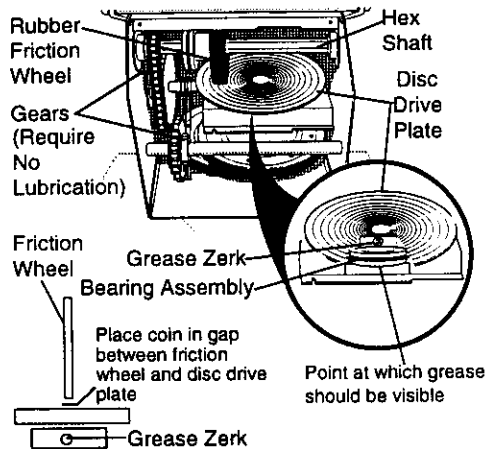

- Remove the bottom panel (see second figure on page 20).
- Turn disc drive plate clockwise by hand until grease zerk is clearly visible at front center. See figure above.
- Place a coin or (a shim of equal thickness) between the rubber friction wheel and disc drive plate to prevent rubber friction wheel contacting the drive disc.
- To grease zerk, use a hand grease gun, lubricate with a Hi Temp EP Moly grease. See inset of figure above. **DO NOT** over fill or allow grease to come in contact with the disc drive plate or friction wheel or damage will result. Fill zerk only until grease becomes visible below bearing assembly located under grease zerk see insert above.

IMPORTANT: Remove coin and ensure that a gap exists between friction wheel and disc drive plate.

NOTE: Clean all excess grease found on friction disc hub.

CAUTION: Do not allow grease to contact friction wheel and disc drive plate.

LUBRICATION - BEFORE STORAGE

- Remove both wheels, grease (any automotive type grease) both axles, see figure below, and replace wheels. Do this at least once a year and/or prior to storage.

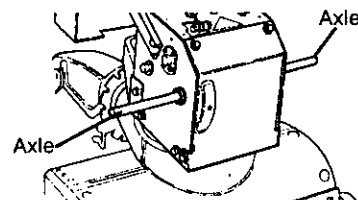

LUBRICATION

- Hex Shaft and Gears - Hex shaft and gears require no lubrication. All bearings and bushings are lifetime lubricated and require no maintenance.

NOTE: Any greasing or oiling of the above components can cause contamination of the friction wheel. If the disc drive plate or friction wheel comes in contact with grease or oil, damage to the friction wheel will result.

Should grease or oil come in contact with the disc drive plate or friction wheel, be sure to clean the plate and wheel thoroughly.

NOTE: For storage, the hex shaft and gears should be wiped with 5W-30 motor oil to prevent rusting. See second figure on page 16.

- Auger Gear Box - The auger gear box is lubricated at the factory and should not require additional lubrication. If for some reason the lubricant should leak out, or if the auger gear box has been serviced, add Lubriplate No. 630-AA or equivalent. Maximum 3-1/4 ounces should be used. Remove filler plug as seen in figure below once a year. If grease is visible, do not add. If grease is not visible, use a piece of fine wire like a dipstick, to check if there is grease in the gearbox. Add grease if necessary. Reinstall gear box filler.

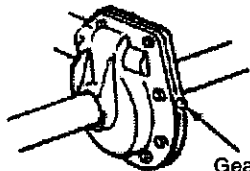

Gear Box Filler Plug

ENGINE

LUBRICATION

Check the crankcase oil level (see figure below) before starting the engine and after each five (5) hours of continuous use. Add S.A.E. 5W30 motor oil as needed. Tighten fill cap/dipstick securely each time you check the oil level.

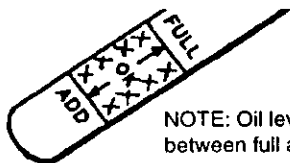

NOTE: Oil level must be between full and add mark

OIL RECOMMENDATION

Only use high quality detergent oil rated with API service classification SG. Select the oil's viscosity grade according to your expected operating temperature:

NOTE: For extreme cold operating conditions of 0° and below, use a partial synthetic 0W30 motor oil for easier starting.

Change the oil every twenty-five (25) hours thereafter, and at the beginning of each season.

- Position the snow thrower so that the oil drain plug is at the lowest point on the engine. Remove the oil drain plug and the oil fill cap/dipstick. Drain the oil into a suitable container. Oil will drain more freely when warm.
- Replace the oil drain plug and tighten securely.

SPARK PLUG

- Make sure that the spark plug is tightened securely into the engine and the spark plug wire is attached to the spark plug.
- If a torque wrench is available, torque plug to 18 to 23 foot pounds.
- Clean the area around the spark plug base before removal to prevent dirt from entering the engine.
- Clean the spark plug and reset the gap periodically at .030 inch.

SERVICE AND ADJUSTMENTS

⚠ CAUTION: Always disconnect the spark plug wire and tie back away from the plug before making any adjustments or repairs.

TO ADJUST SKID HEIGHT

This snow thrower is equipped with two height adjustment skids, located on the outside of the auger housing (see figure below). These skids elevate the front of the snow thrower.

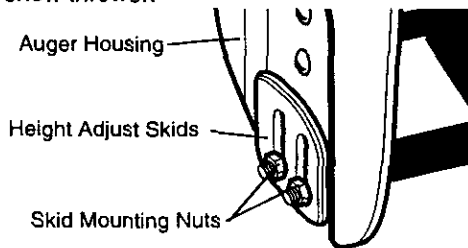

For normal hard surfaces, adjust the skids as follows:

- Check tire pressure (14 pounds). See side of tire for maximum inflation. Do not exceed maximum pressure on side of tire.
- Place the extra shear bolts supplied (found in parts bag) under each end of the scraper bar near but not under the skid.
- Loosen the skid mounting nuts (see figure above) and adjust the skids up to bring the front of the snow thrower down.
- Re-tighten the mounting nuts.
- Set the skid on the other side at the same height.

For rocky or uneven surfaces, adjust the skids as follows:

- Raise the front of the snow thrower by moving the skids down. This will help prevent rocks and other debris from being picked up and thrown by the auger.

NOTE: Be sure that snow thrower is set at same height on both sides.

TO ADJUST SCRAPER BAR

After considerable use, the metal scraper bar will have a definite wear pattern. The scraper bar in conjunction with the skids should always be adjusted to allow 1/8" be-

tween the scraper bar and the sidewalk or area to be cleaned. The scraper bar may have to be returned to its original lower setting to maintain the original performance level. To adjust:

- Position the snow thrower on a level surface.
- Make sure both tires are equally inflated.
- Loosen the carriage bolts and nuts securing the scraper bar to the auger housing.
- Adjust the scraper bar to the proper position.
- Tighten the carriage bolts and nuts, making sure that the scraper bar is parallel with the working surface.
- For extended operation, the scraper bar may be reversed. If the scraper bar must be replaced due to wear, remove the carriage bolts and nuts and install a new scraper bar.

⚠ CAUTION: Be certain to maintain proper ground clearance for your particular area to be cleared. Objects such as gravel, rocks or other debris, if struck by the impeller, may be thrown with sufficient force to cause personal injury, property damage or damage to the snow thrower.

TO ADJUST THE CLUTCH CONTROL CABLES

Periodic adjustment of the cables may be required due to normal stretch and wear on the belts. To check for correct adjustment, disconnect "Z" Fitting at clutch lever, move clutch lever to the full forward position, just contacting the plastic bumper. The control cables are correctly adjusted when the center of the "Z" fitting is between the center and top of the hole and there is no droop in the cable (see figure below). If adjustment is necessary:

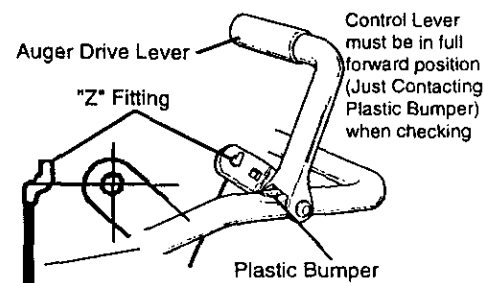

- Remove fuel from tank, and stand blower on end.
- Pull rubber boot off the top of the spring. Push the cable through the spring (see figure below) to expose the threaded portion of the cable.

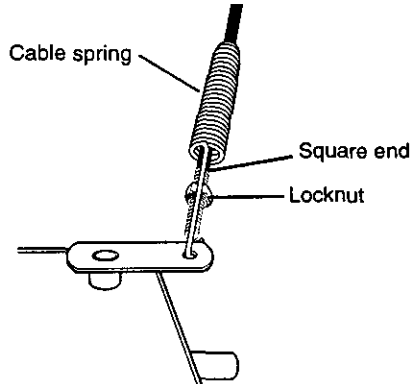

- Hold the square end of the threaded portion with pliers and adjust the locknut in or out until the excess slack is removed.
- Pull the cable back through the spring and connect the cable.
- Do the same for the other lever cable, if needed.

NOTE: Whenever the traction drive or auger belts are adjusted or replaced, the cables will need to be adjusted.

TO ADJUST BELTS

Belts stretch during normal use. If you need to adjust the belts due to wear or stretch, proceed as follows:

AUGER DRIVE BELT

If your snow thrower will not discharge snow, check the control cable adjustment. If it is correct, then check the condition of the auger drive belt. It may be loose or damaged. If it is damaged, replace it (see To Replace Belts paragraph on this page).

TRACTION DRIVE BELT

The traction drive belt (see next figure) has constant spring pressure and does not require adjustment.

- Replace the traction drive belt if it is slipping (see To Replace Belts paragraph on this page).

TO REPLACE BELTS

The drive belts on this snow thrower are of special construction and should be replaced with original equipment belts available from your nearest Craftsman Store or Service Center.

You will need the assistance of a second person while replacing the belts.

Drain the gasoline from the fuel tank by removing the fuel line at the carburetor. Drain the gas into a container and reinstall the fuel line.

CAUTION: Drain the gasoline outdoors, away from the fire or flame.

AUGER DRIVE BELT

If your snow thrower will not discharge snow, and the auger drive belt (see figure below for location) is damaged, replace it as follows:

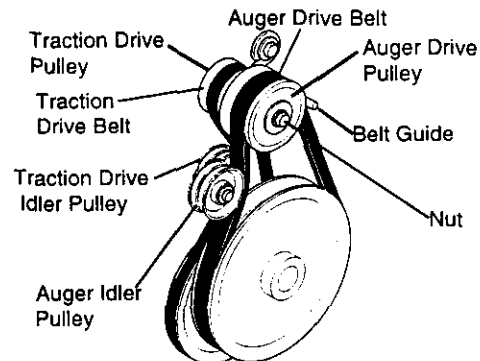

- Disconnect the spark plug wire.
- Remove the belt cover (See figure below).

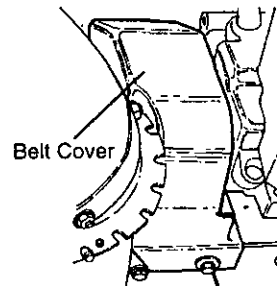

1/4 X 1/2 Inch self-tapping Screw

- Loosen the belt guide (see first figure this column) and pull away from the engine drive pulley.
- Loosen nut on the auger idler pulley (see first figure this column) and pull idler pulley away from the belt.

- Remove top two bolts that secure auger housing to motor mount frame. Loosen bottom two bolts. Auger housing and motor mount frame will separate, hinged by bottom two bolts.
- Remove old belt from auger drive pulley.
- Install the original equipment replacement belt in reverse order of removal.
- Position drive belt onto the auger drive pulley.
- Adjust the belt guide (see To Adjust The Belt Guide paragraph).
- Reinstall the belt cover.

NOTE: You may have to move the auger idler pulley more than once to obtain the correct tension.

- Check the clutch control cable adjustment.
- Reconnect the spark plug wire.

TRACTION DRIVE BELT

If your snow thrower will not move forward, check the traction drive belt (see second figure on page 19) for wear (Check other causes also in the Trouble Shooting Points section). If the traction drive belt needs to be replaced, proceed as follows:

- Disconnect the spark plug wire.
- Remove the belt cover (see second figure).
- Loosen the belt guide and pull away from auger drive pulley (see second figure on page 19).
- Remove auger drive belt from auger pulley (see second figure on page 19).
- Pull the traction drive belt idler pulley away from the traction drive belt (see second figure on page 19).
- Remove the traction drive belt.
- Position new traction drive belt onto traction pulley.
- Pull idler pulley away from belt, allowing belt to be positioned onto auger pulley.
- Check clutch control cable adjustment, see page
- Reconnect the spark plug wire.

TO ADJUST THE BELT GUIDE

- Disconnect the spark plug wire.
- Remove the belt cover (see third figure on page 19).
- Engage the auger drive clutch lever.

- Measure the distance between the belt guide and the belt (see figure below). The distance should be 1/8".
- If adjustment is necessary, loosen the belt guide mounting bolt. Move the belt guide to the correct position and tighten the mounting bolt.
- Reinstall the belt cover.
- Reconnect the spark plug wire.

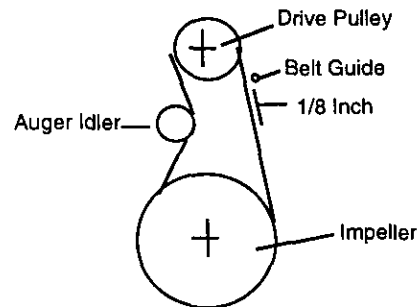

TO ADJUST THE FRICTION WHEEL

If the snow thrower will not move forward, you need to check the traction drive belt, the traction drive cable or the friction wheel. If the friction wheel is damaged, it will need to be replaced (see the To Replace Friction Wheel paragraph on page 21). If the friction wheel is not worn, check the adjustment, as follows:

- Disconnect the spark plug wire.
- Drain the gasoline from the gas tank.
- Stand snow thrower on the auger housing end.
- Remove the bottom panel (see figure below).

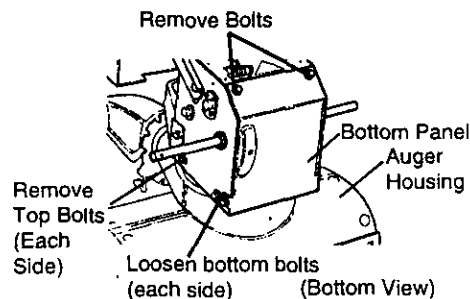

- Position the shifter lever in first (1) forward gear.
- Note the position of the friction wheel on the disc drive plate. Proper position from the right outer side of disc drive plate to the center of friction wheel should be 3" (76 mm) (see next figure).

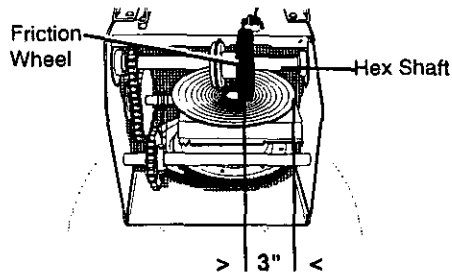

- Remove the bottom panel (see last figure on page 20).
- Remove the three (3) fasteners securing the friction wheel to the hub (see next figure).
- Remove the four bolts securing the bearing plates (**both sides**), (see figure below).

If adjustment is necessary:

- Remove washer and cotter pin connecting trunnion nut to speed rod (see figure below).
- Twist trunnion nut up or down on shift rod to obtain the correct friction wheel position.
- Put end of trunnion nut through hole in speed control rod and reattach washer and cotter pin.
- Replace bottom panels.

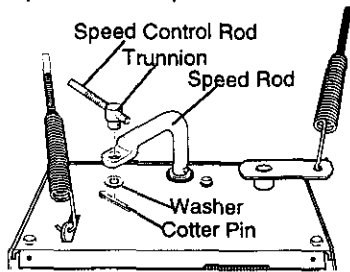

TO REPLACE FRICTION WHEEL

If the snow thrower will not move forward, and the friction wheel is worn or damaged, you need to replace it as follows: (First allow the engine to cool).

- Drain the gasoline from the fuel tank by removing the fuel line at the carburetor. Drain the fuel in a container and reinstall the fuel line.
- CAUTION:** Drain gasoline outdoor away from fire or flame.
- Disconnect the spark plug wire.
- Stand the snow thrower up on the auger housing end.
- Disconnect speed control rod from speed rod by removing cotter pin (see figure above). Keep trunnion in same position on speed control rod. Movement of the trunnion will result in speed changes.

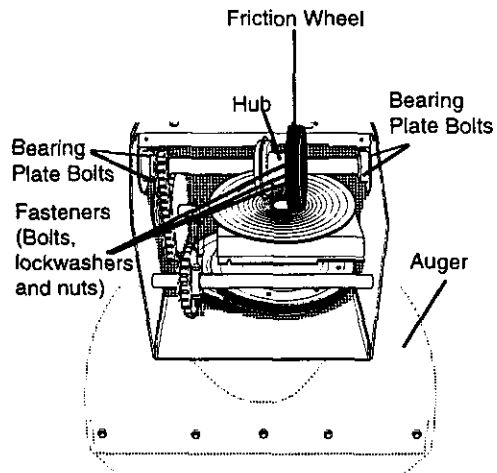

- Remove right side bearing plate. Leave hex shaft in original position.
- Remove friction wheel from hub. Slip friction wheel off hex shaft towards right side.
- Position new friction wheel onto hub (see first figure on page 22).
- Install bearing plates to original position. Ensure hex shaft is engaged with both bearing plates.
- Secure bearing plates, using bolts removed earlier.
- Secure friction wheel to hub using fasteners removed earlier. Ensure hex shaft turns freely.
- Replace bracket to speed control lever.
- Reconnect speed control rod to speed rod by reassembling the trunnion assembly and cotter pin.
- NOTE:** Ensure friction wheel and friction disc are free from grease or oil.
- Replace bottom panel.
- Lower the snow thrower onto the tires.

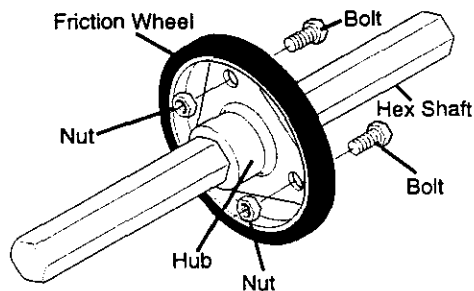

TO REPLACE AUGER SHEAR BOLT

The augers are secured to the auger shaft with special bolts (see figure below) that are designed to break (to protect the machine) if an object becomes lodged in the auger housing. Use of a harder bolt will destroy the protection provided by the shear bolt.

IMPORTANT: To ensure safety and performance levels, only original equipment shear bolts should be used.

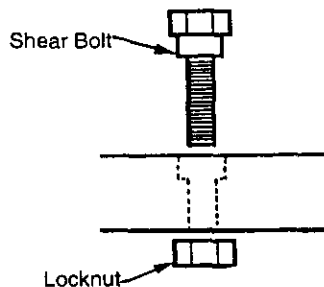

- To replace a broken shear bolt, proceed as follows:
- Move the throttle to **STOP** (STOP) and turn off all controls.
- Disconnect the spark plug wire. Be sure all moving parts have stopped.
- Lubricate the auger shaft zerk fitting (See the Maintenance section).
- Align the hole in the auger with the hole in the auger shaft. Install the new shear bolt and nut found in toolbox located on top of belt cover.
- Reconnect the spark plug wire.

TO ADJUST OR REPLACE

THE SPARK PLUG

NOTICE: This spark ignition system meets all requirements of the Canadian Interference-Causing Equipment Regulations.

NOTICE: This engine complies with all current Australian and New Zealand limitations regarding electromagnetic interference.

If you have difficulty starting your snow thrower, you may need to adjust or replace the spark plug. Follow the instructions below.

Replace the spark plug if the electrodes are pitted or burned or if the porcelain is cracked.

TO ADJUST:

- Clean the spark plug by carefully scraping the electrodes (do not sand blast or use a wire brush).
- Be sure the spark plug is clean and free of foreign material. Check the electrodes gap (see figure below) with a wire feeler gauge and reset the gap to .030 inch if necessary.

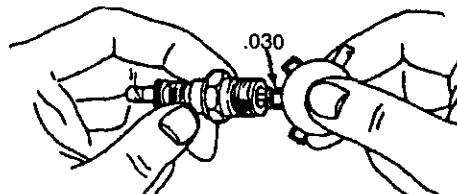

TO REPLACE:

- If you need a new spark plug, use only the proper replacement spark plug (see page 15).
- Set the gap to .030 inches.
- Before installing the spark plug, coat its threads lightly with oil or grease to insure easy removal.
- Tighten the plug firmly into the engine.
- If a torque wrench is available, torque the plug to 18 to 23 ft. - lbs.

TO ADJUST CARBURETOR

If you think your carburetor needs adjusting, see your nearest Authorized Craftsman Service Center. Engine performance should not be affected at altitudes up to 7,000 feet. For operation at higher elevations, contact your nearest Craftsman Service Center.

STORAGE

⚠ CAUTION: Never store your snow thrower indoors or in an enclosed, poorly ventilated area if gasoline remains in the tank. fumes may reach an open flame, spark or pilot light from a furnace, water heater, clothes dryer, cigarette, etc.

To prevent engine damage (if snow thrower is not used for more than 30 days) follow the steps below.

SNOW THROWER STORAGE

- Thoroughly clean the snow thrower.
- Lubricate all lubrication points (see the Maintenance section on pages 15-17).
- Be sure that all nuts, bolts and screws are securely fastened. Inspect all visible moving parts for damage, breakage and wear. Replace if necessary.
- Touch up all rusted or chipped paint surfaces; sand lightly before painting.
- Cover the bare metal parts of the blower housing auger and the impeller with rust preventative, such as a spray lubricant.

NOTE: A yearly checkup or tune-up by a Craftsman Service Center is a good way to insure that your snow thrower will provide maximum performance for the next season.

ENGINE STORAGE

Gasoline must be removed or treated to prevent gum deposits from forming in the tank, filter, hose, and carburetor during storage. Also during storage, alcohol blended gasoline that uses ethanol or methanol (**sometimes called gasohol**) attracts water. It acts on the gasoline to form acids which damage the engine.

- To remove gasoline, run the engine until the tank is empty and the engine stops. Then drain remaining gasoline from carburetor by pressing upward on bowl drain located on the bottom of carburetor (see next figure).
- If you do not want to remove gasoline, a fuel stabilizer (such as **Craftsman Fuel Stabilizer No. 33500**) may be added to any gasoline left in the tank to minimize gum deposits and acids. If the tank is almost empty, mix stabilizer with fresh gasoline in a separate container and add some to the tank.

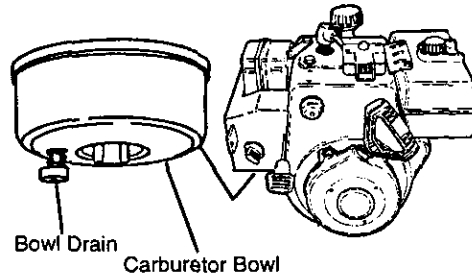

Always follow instructions on stabilizer container. Then run engine at least 10 minutes after stabilizer is added to allow mixture to reach carburetor. Store snow thrower in a safe place. See Caution on this page.

You can keep your engine in good operating condition during storage by:

- Changing oil (see page 17).
- Lubricating the piston/cylinder area. This can be done by first removing the spark plug and squirting a few drops of clean engine oil into the spark plug hole. Then cover the spark plug hole with a rag to absorb oil spray. Next, rotate the engine by pulling the starter rope fully out two or three times. Finally, reinstall spark plug and attach spark plug wire.

OTHER

- If possible, store your snow thrower indoors and cover it to give protection from dust and dirt.
- If the machine must be stored outdoors, block up the snow thrower to be sure the entire machine is off the ground.
- Cover the snow thrower with a suitable protective cover that does not retain moisture. Do not use plastic or vinyl.

IMPORTANT: Never cover snow thrower while engine and exhaust areas are still warm.

TROUBLE SHOOTING

TROUBLE	CAUSE	CORRECTION
Difficult starting	Defective spark plug	Replace defective plug
	Water or dirt in fuel system	Use carburetor bowl drain to flush and refill with fresh fuel
Engine runs erratically	Blocked fuel line or low on fuel	Clean fuel line; check fuel supply; add fresh gasoline (gasoline/oil mixture if 2-cycle engine)
Engine stalls	Unit running on CHOKE	Move choke lever to OFF position
Engine runs erratically; Loss of power	Water or dirt in fuel system	Use carburetor bowl drain to flush and refill with fresh fuel
Excessive vibration	Loose parts; damaged impeller	Stop engine immediately and disconnect spark plug wire. Tighten all bolts and make all necessary repairs. If vibration continues, have the unit serviced by a Craftsman service repairman
Units fails to propel itself	Drive belt loose or damaged	Adjust auger drive belt: Replace if damaged
	Incorrect adjustment of auger control cable	Adjust traction drive cable
	Worn or damaged friction wheel	Repair friction wheel
Unit fails to discharge snow	Auger drive belt loose or damaged	Replace auger drive belt
	Auger control cable not adjusted correctly	Adjust auger control cable
	Shear bolt broken	Replace shear bolt
	Discharge chute clogged	Stop engine immediately and disconnect spark plug wire. Clean discharge chute and inside of auger housing
	Foreign object lodged in auger	Stop engine immediately and disconnect spark plug wire. Remove object from auger.
Headlight does not work	Loose wire connection	Tighten connection
	Bulb burned out	Replace headlight bulb