

DRAWER CADDY W/OVERLOCK LEAF

Portion of

DUAL SEWING CENTER

OWNER'S MANUAL

Assembly Instructions

**Model Numbers 272.98400.490 (Oak)
272.98401.490 (White)**

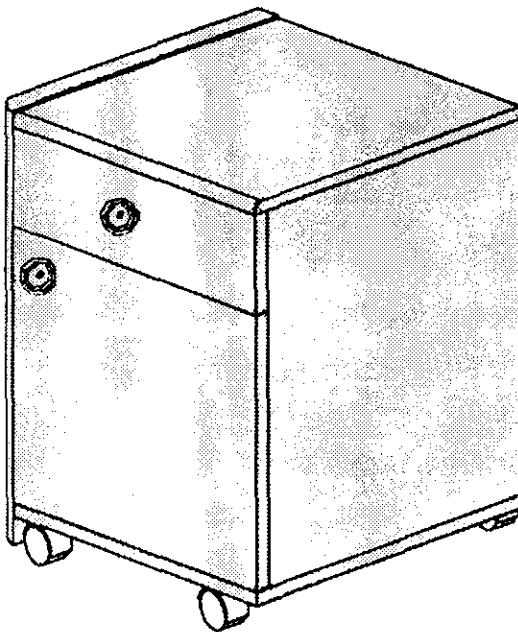

**IMPORTANT: Please read these instructions
Before assembling.**

**98400-20
98401-20**

Notice to Customer:

Before beginning assembly, remove all parts from the carton. Check closely with illustrations below to determine that all the parts are included.

For assembly or operating assistance, or to report any missing or damaged parts, you may call or write to:

1-800-533-7347

API Specialty Furniture

(A division of ARROW Products Inc.)

P.O. Box 410, Elkhorn, WI 53121

TO ORDER REPLACEMENT PARTS CALL

1-800-366-7278

PLEASE NOTE: To assure proper handling of replacement parts please include the following information:

Model Number of Unit - 272.98400.490 (Oak)

272.98401.490 (White)

Production ID Number

Number of Part Required

Your Name, Address, and Phone Number

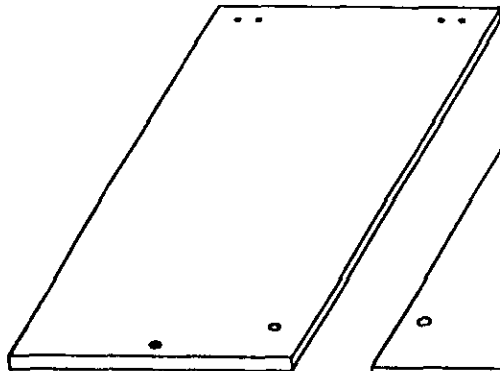

Overlock Leaf

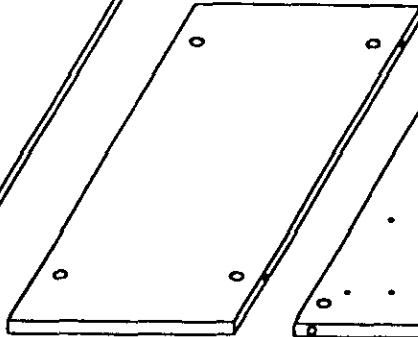

Back

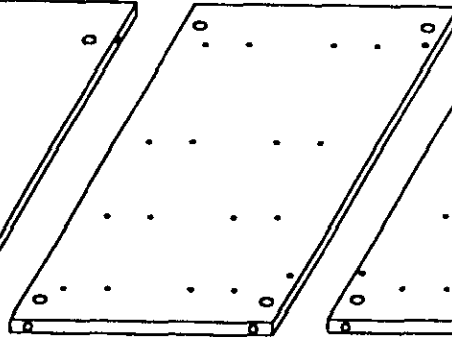

Left Side

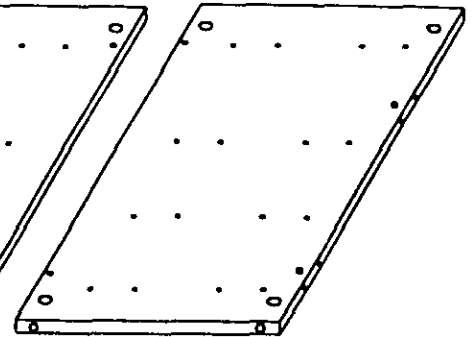

Right Side

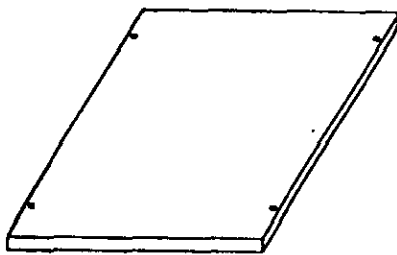

Top

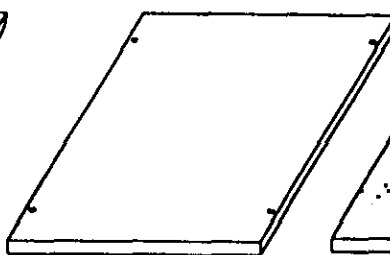

Bottom

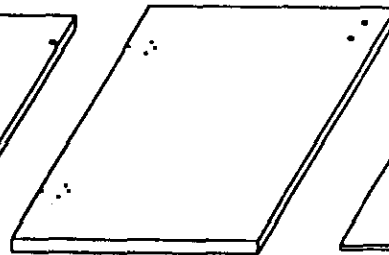

Door

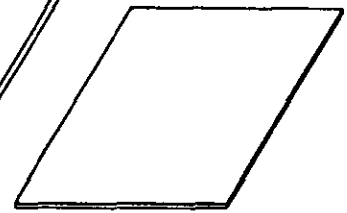

Drawer Bottom



Drawer Front

Hardware Included

(16) #8x1/2" Panhead Screw

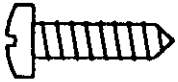

(15) #4x1/2" Flathead Screw

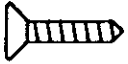

(8) #6x1/2" Ovalhead Screw



(2) #8x7/8" Machine Screw
Ceramic Knob (98401 only)

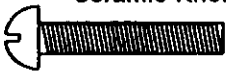

(8) #6x1" Flathead Screw

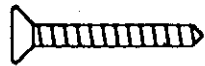

(2) #6x5/8" Panhead Screw

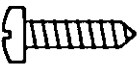

(12) Connecting Bolt



(4) Drawer Connector

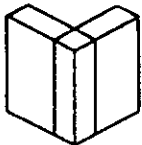

(2) 8/32x1" Bolts (98400 only)



(12) Cams

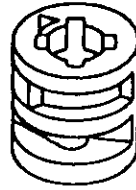

(4) Plate Casters

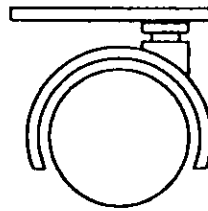

(1) Magnet

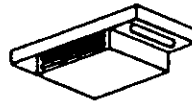

(1) Tack Glide



(1) Drawer Back (11-9/16" long)

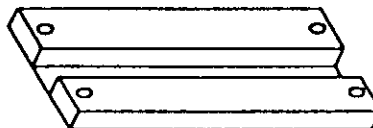

(2) Door Hinge

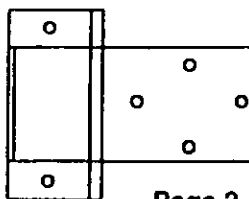

(2) Drawer Runners

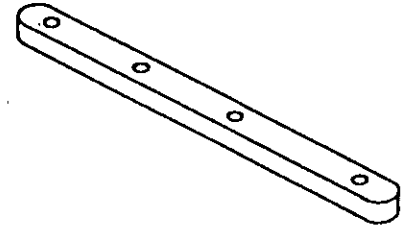

(1) Allen Key

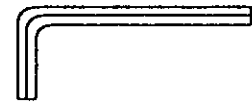

(1) Strike Plate



2 Pc.
(2) Knobs



Metal Knob 98400



Ceramic Knob 98401

(2) Drawer Sides (13" long)

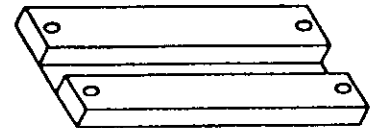

(2) Overlock Hinge

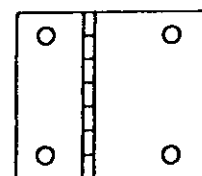

Understanding How the "ARROW-LOC" Cam Fastener Works.

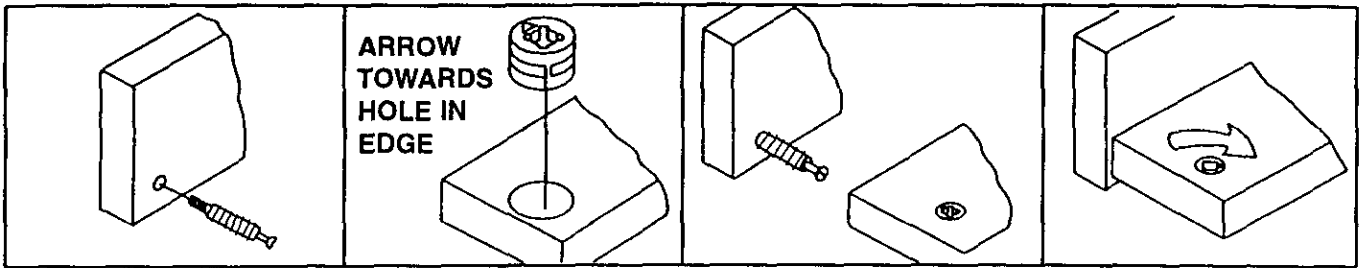

1. Position bolt in pre-drilled hole and turn until tight.
2. Press cam into pre-drilled hole until flush with surface.
3. Insert bolt through pre-drilled hole in edge of panel.
4. To lock, rotate cam until tight, using allen key provided.

Cabinet Assembly

Step 1. Place Top, Bottom, Back Left and Right Sides on a flat protected surface (to prevent scratching of parts). Thread Connecting Bolts (12 total) into pre-drilled holes (as shown in FIG. 1). Install Cams (12 total) by pushing a Cam into each, hole flush with surface. The arrow on the Cams should be turned to face the hole, in each edge where the Connecting Bolts will enter, using a regular screwdriver or Allen Key provided.

NOTE:

- = Connecting Bolt
- ⊕ = Cam

FIG. 1

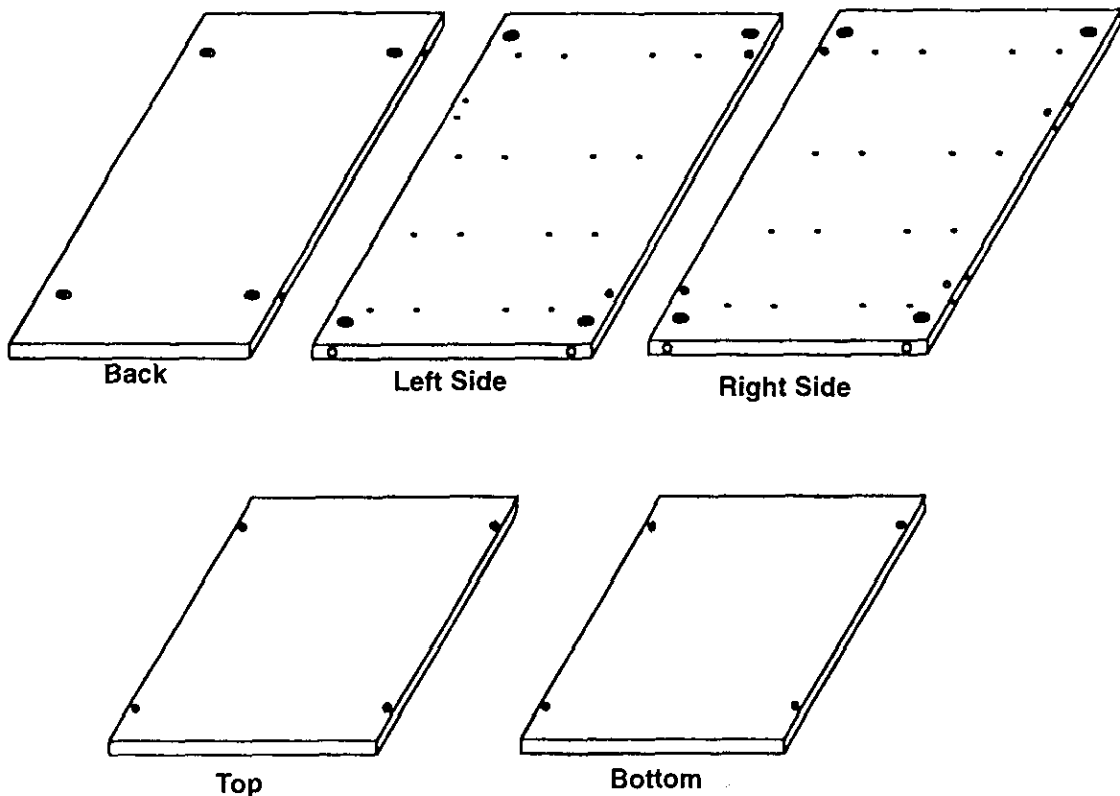

STEP 2. Attach (2) Drawer Runners to Left and Right Sides using (8) #6x1" Flathead Screws. Attach on Right Side (2) Door Hinges using (6) #4x1/2" Flathead Screws. Attach on Left Side (1) Magnetic Catch using (2) #6x5/8" Panhead Screws (as shown in FIG. 2).

FIG. 2

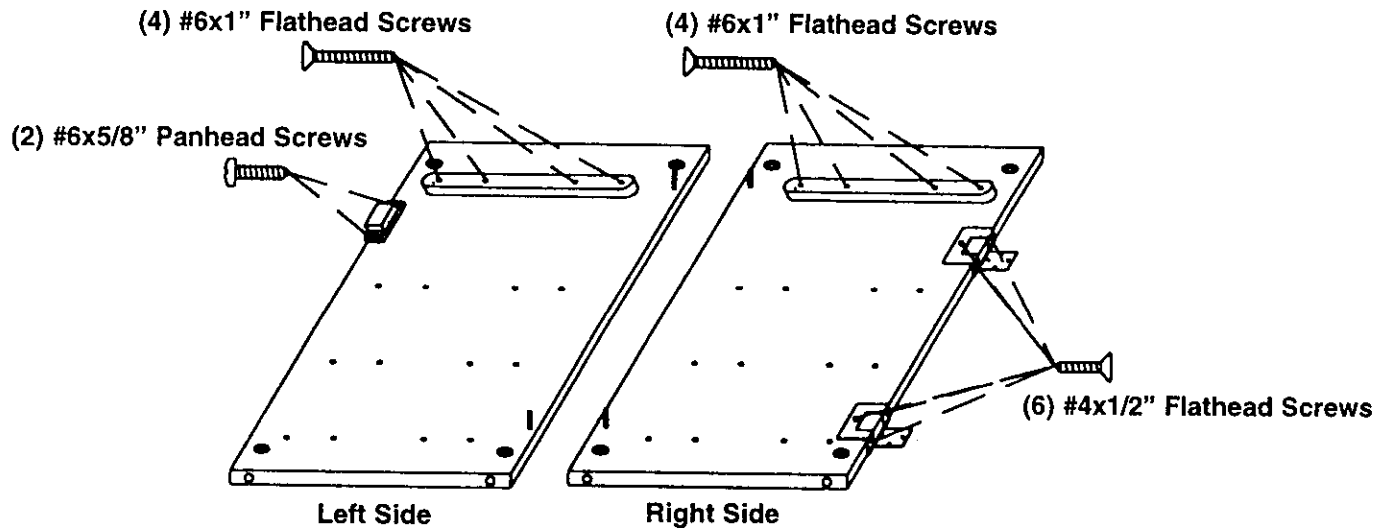

STEP 3. Attach (4) Plate Casters to Bottom using (16) #8x1/2" Panhead Screws into holes provided (as shown in FIG. 3).

FIG. 3

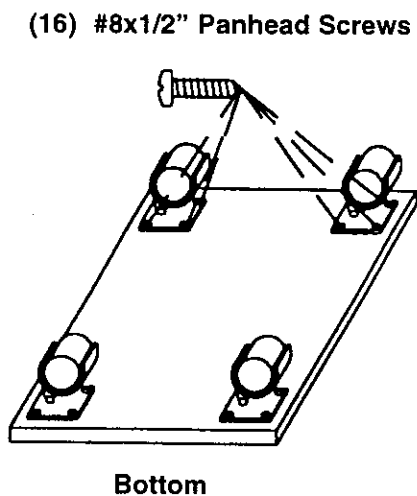

STEP 4. Attach Left Side to Back, guide Connecting Bolts into holes in Back, turn Cams to Locked position. Attach Right Side to Back, Guide Connecting Bolts into holes in Back, turn Cams to Locked position (as shown in FIG. 4).

FIG. 4

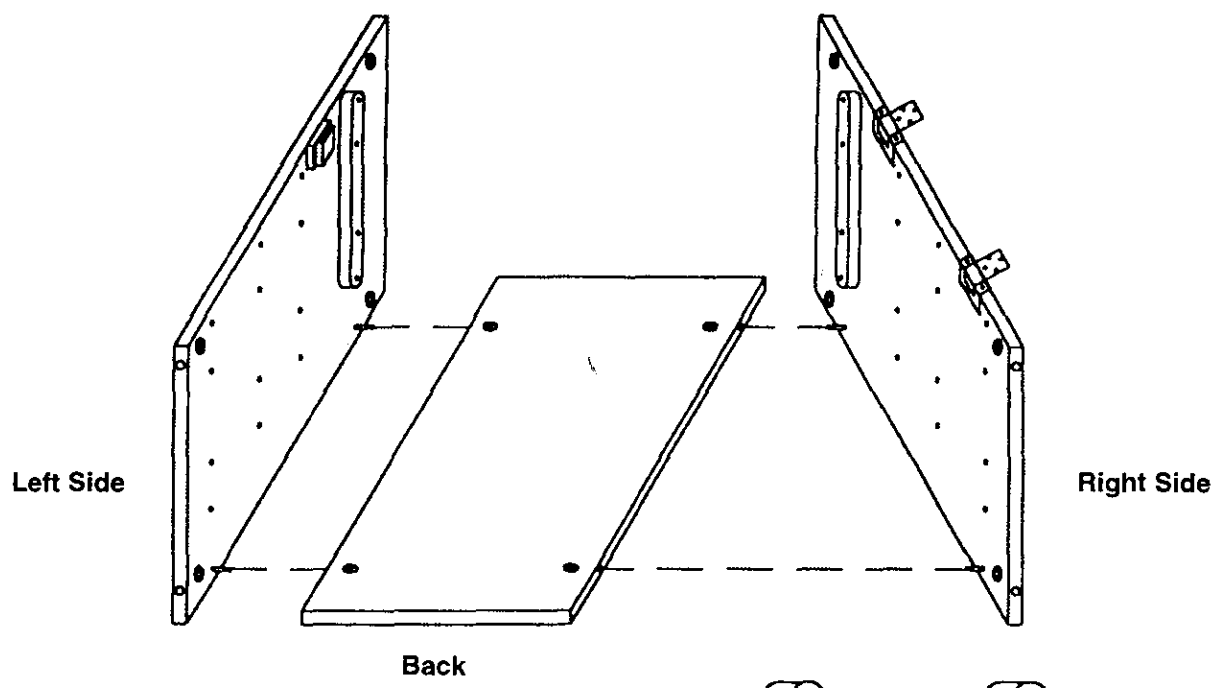

STEP 5. Place Top on floor, guide Side and Back assembly onto Connecting Bolts, turn Cams to locked position. Attach Bottom w/casters, guide Connecting Bolts into Holes in Sides, turn Cams to locked position (as shown in FIG. 5).

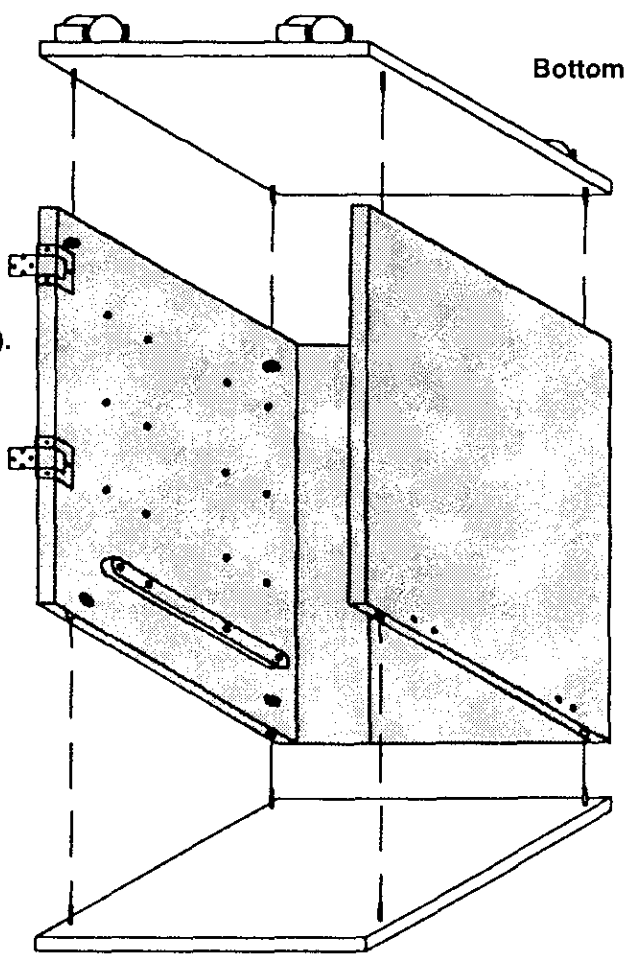

STEP 6. Attach (2) Overlock Hinges to Overlock Leaf, using (4) #6x1/2" Ovalhead Screws. Tap in Tack Glide with hammer (as shown in FIG. 4).

FIG. 6

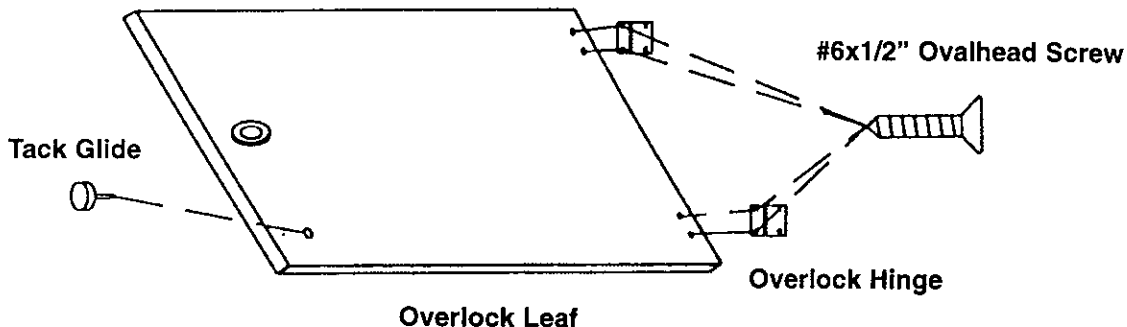

STEP 7. Laying Caddy on it's Back, attach Door using (8) #4x1/2" Flathead Screws. Attach Knob using (1) 7/8" Bolt for White Ceramic Knob, or (1) 8/32x1" Bolt for 2 Pc. Metal Knob slide the Sleeve End onto the Post End of the Knob (as shown in FIG. 7 A). Attach Strike Plate with (1) #4x1/2" Flathead Screw (as shown in FIG. 7).

FIG. 7
View from Top

FIG. 7 A
Post Sleeve

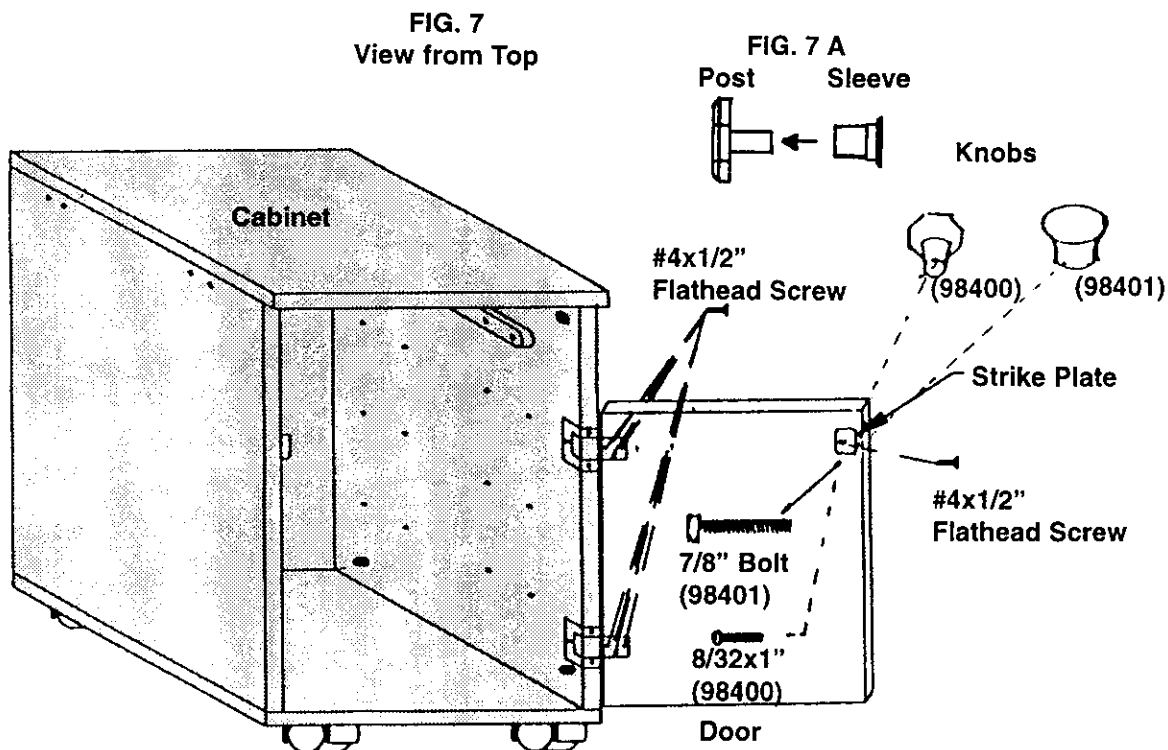

STEP 8. Flip Caddy onto Top, attach Overlook Leaf using (4) #6x1/2" Ovalhead Screws (as shown in FIG.8).

FIG. 8

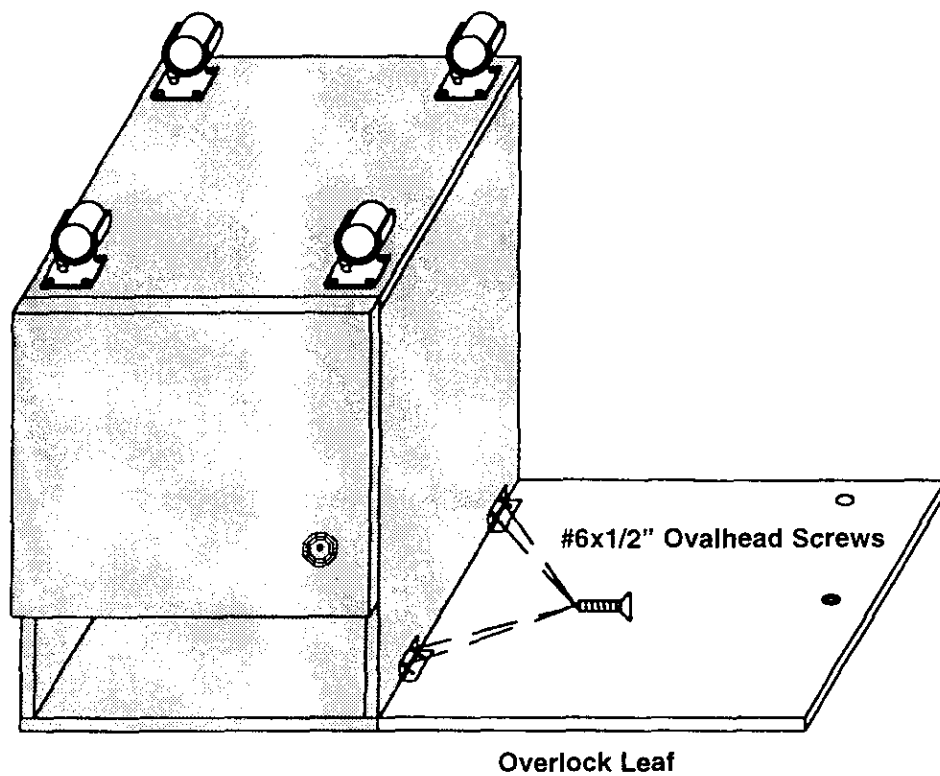

PLEASE NOTE:

BE SURE TO KEEP GROOVES IN DRAWER PART (FOR DRAWER BOTTOM) ALIGNED WHEN ASSEMBLING THE DRAWER.

Assembling the Drawer

Begin Drawer assembly by inserting (4) Drawer Connectors into the ends of the Drawer Back, (as shown in FIG. A). Push Connectors all the way into the Drawer Back until the tabs lock into place.

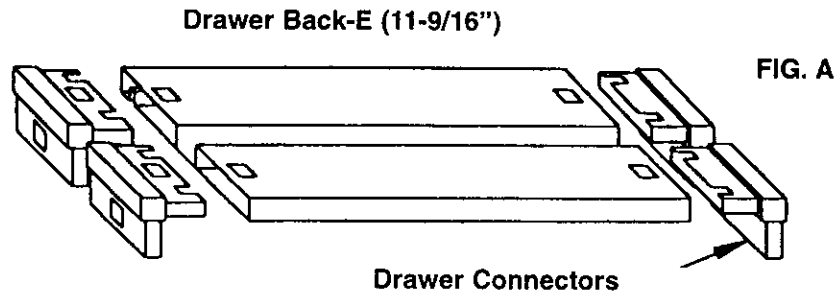

Drawer Assembly

- STEP 1. Attach DRAWER Sides B and C to Drawer Front-A. Align Drawer Bottom grooves in Sides with Drawer Bottom groove in Drawer Front. Snap Drawer Sides onto clips on Drawer Front (see FIG. B).
 - STEP 2. Slide Drawer Bottom-D along grooves on the Sides into the Groove in Drawer Front.
 - STEP 3. Align groove in Back-E with the Drawer Bottom-D and snap Back corner clips into Sides-B and C.
 - STEP 4. Attach the Knob to the Drawer Front using (1) 7/8" Bolt, for White Ceramic Knob or (1) 8/32x1" Bolt for Metal Knob, this is a 2 Pc. Knob assembly as shown in Fig. B.A. Slide the Sleeve End onto the Post End of the Knob and attach to Drawer.
- Slide the Sleeve End onto the Post End of the Knob and attach to Drawer.

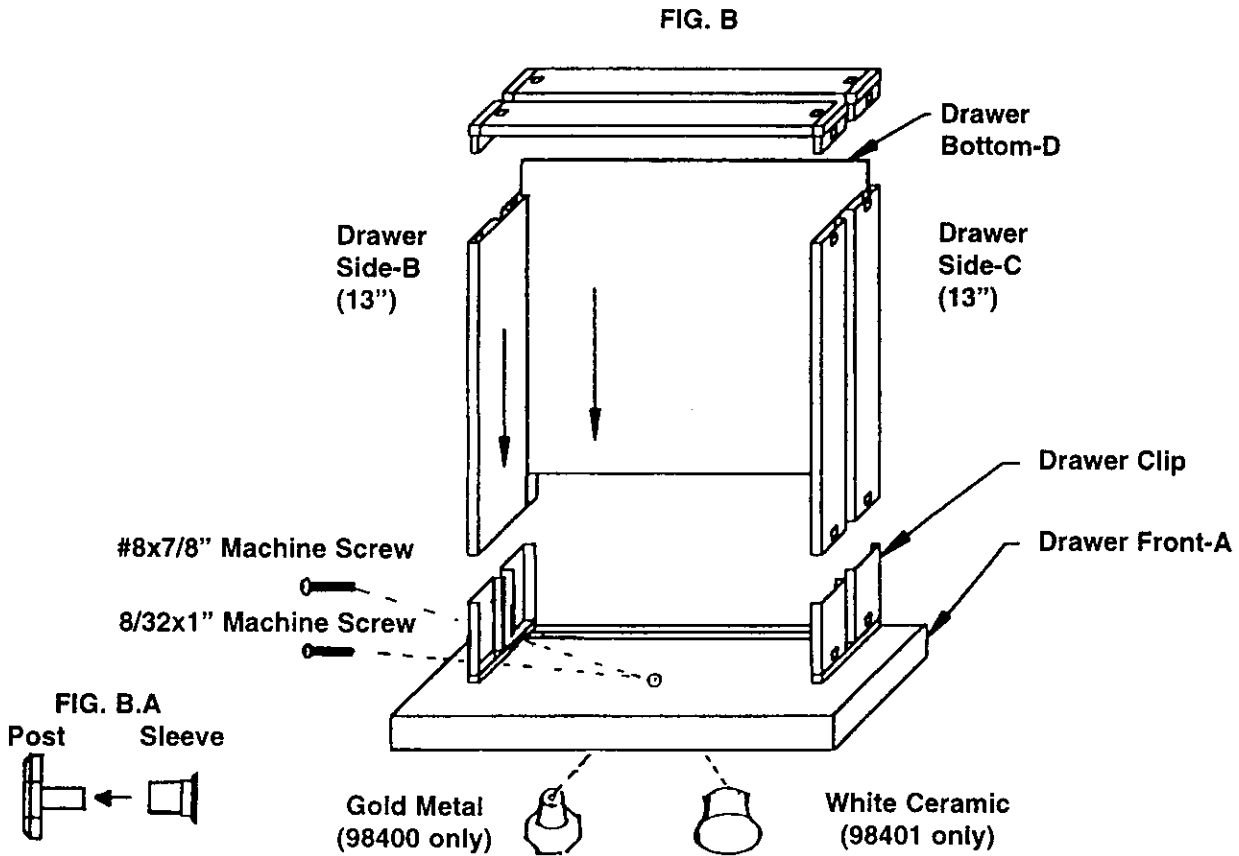

The Drawer may now be installed into your cabinet.

AN OPTIONAL 3 DRAWER KIT IS AVAILABLE (ORDER STOCK #99190)

Wood Parts and Part Numbers

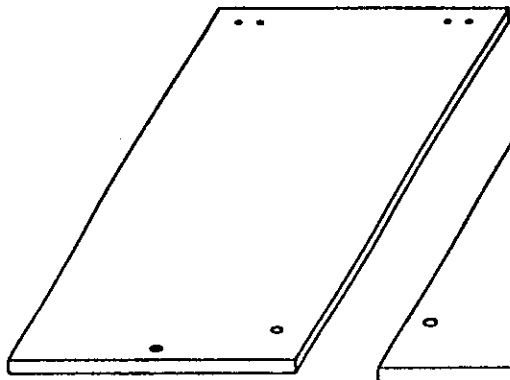

(A) Overlock Leaf

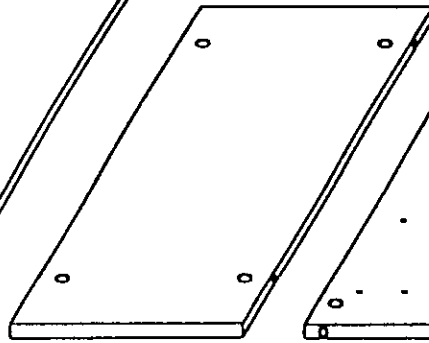

(B) Back

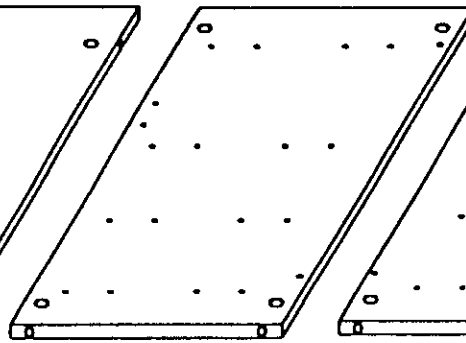

(C) Left Side

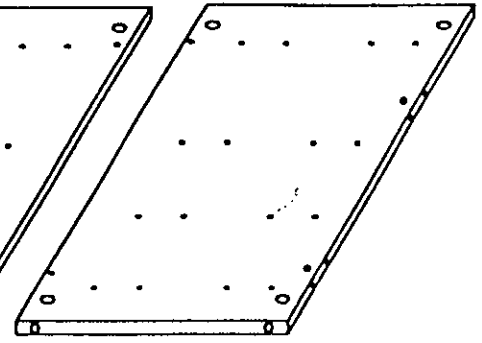

(D) Right Side

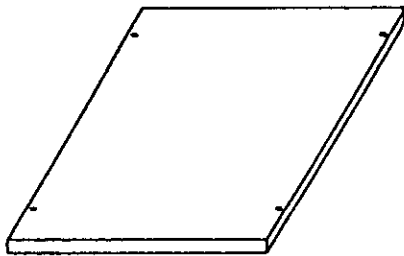

(E) Top

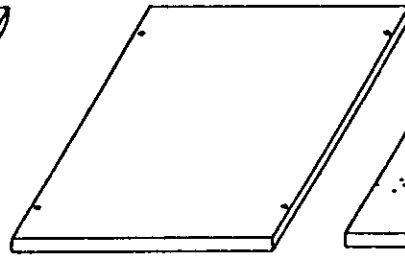

(F) Bottom

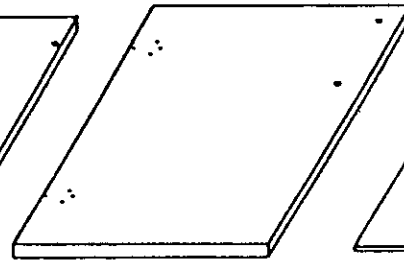

(G) Door

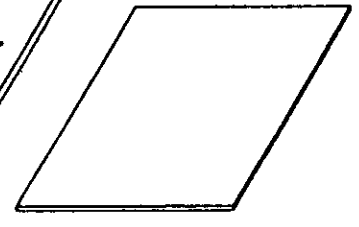

(H) Drawer Bottom



(I) Drawer Front

REF.	DESCRIPTION	PART #	PART #
		98400(OAK)	98401(WHITE)
A	Overlock Leaf	003060	003100
B	Back	003056	003137
C	Left Side	003055	003096
D	Right Side	003054	003095
E	Top	003058	003098
F	Bottom	003057	003097
G	Door	003059	003099
H	Drawer Bottom	003022	003076
I	Drawer Front	003061	003101

Hardware Included with Part Numbers

(A) #8x1/2" Panhead Screw

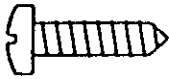

(B) #4x1/2" Flathead Screw

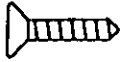

(C) #6x1/2" Ovalhead Screw

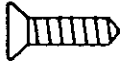

(D) #8x7/8" Machine Screw



(E) #6x1" Flathead Screw

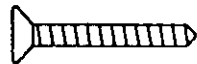

(F) #6x5/8" Panhead Screw

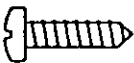

(G) Connecting Bolt

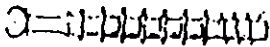

(H) Drawer Connector

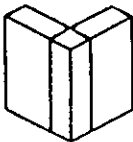

(I) Manual



(J) Plastic Insert

(K) Cam

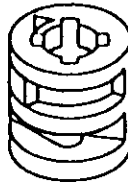

(L) Plate Caster

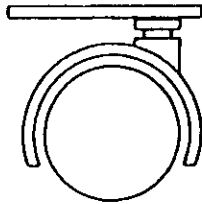

(M) Magnet

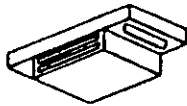

(N) Tack Glide



(X) 8/32x1" Bolt



(O) Drawer Back (11-9/16")

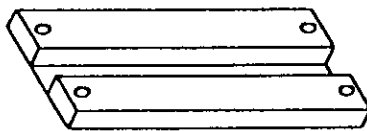

(P) Door Hinge

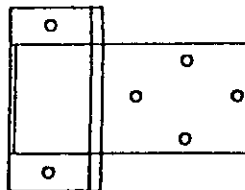

(Q) Drawer Runners

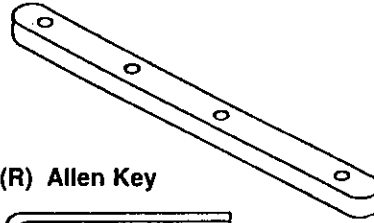

(R) Allen Key

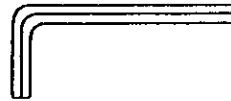

(S) Strike Plate



(T) Knob Metal (98400 only)

(V) Overlook Hinge

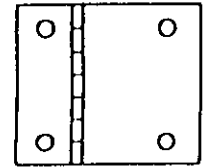

(U) Drawer Side (13")



(W) Knob White Ceramic (98401 only)



Item	Description	Part No.
A	#8x1/2" Panhead Screw	002614
B	#4x1/2" Flathead Screw	002705
C	#6x1/2" Ovalhead Screw	000297
D	#8x7/8" Machine Screw (98401 only)	000185
E	#6x1" Flathead Screw	001325
F	#6x5/8" Panhead Screw	000083
G	Connecting Bolts	002892
H	Drawer Connector	002422
I	Manual	003151
J	Plastic Insert	001015
K	Cam	000766
L	Plate Caster	002739
M	Magnet	001644
N	Tack Glide	000068
O	Drawer Back	003154
P	Door Hinge	002730
Q	Drawer Runner	002397
R	Allen Key	000712
S	Strike Plate	002192
T	Knob Metal (98400 only)	003170
U	Drawer Side	003153
V	Overlock Hinge	000913
W	Knob White Ceramic (98401 only)	003165
X	8/32x1" Bolt (98400 only)	003192

API Specialty Furniture

(A Division of ARROW PRODUCTS, Inc.)

P.O. Box 410, Elkhorn, WI 53121

1-800-533-7347

12-98

**98400-BC
98401-BC**