

# ***Trinitron® Color TV***

---

## Operating Instructions

*KV-32S42*    *KV-32V42*    *KV-35S42*    *KV-35V42*  
*KV-32S66*                      *KV-35S66*

# Table of Contents

<b>Important Safeguards</b> .....	<b><i>i</i></b>
<b>Welcome!</b> .....	<b>1</b>
<b>Precautions</b> .....	<b>1</b>
<b>Using This Manual</b> .....	<b>1</b>

---

## **Connecting and Installing the TV**

Making Connections .....	2
Note about the AC Power Cord .....	3
Cable or Antenna Connections .....	3
Cable Box Connections .....	4
VCR Connections .....	5
Satellite Receiver Connections .....	7
DVD Player Connections .....	8
Additional Connections .....	9
Using Special Sony Features .....	10

---

## **Basic Set Up**

Inserting batteries .....	11
Using the remote control move & select buttons .....	11
Front panel menu control .....	11





---

## **Using Your New TV**

Setting up the TV automatically .....	12
Watching the TV .....	13
Using Picture-in-Picture — PIP .....	15

---

## **Using Your Menus**

Learning menu selection .....	16
Quick start to the menus .....	17
Using the VIDEO  menu .....	18
Using the AUDIO  menu .....	19
Using the TIMER  menu .....	20
Using the SET UP  menu .....	21
Using the CHANNEL SET UP menu ...	23
Using the PARENTAL CONTROL menu .....	26

---

## **Operating Video Equipment**

Programming the remote .....	28
------------------------------	----

---

## **Operating a Cable Box or Satellite Receiver**

Programming the remote control .....	30
--------------------------------------	----

---

## **Troubleshooting** .....

<b>Specifications</b> .....	<b>32</b>
-----------------------------	-----------

<b>Index</b> .....	<b>34</b>
--------------------	-----------

# Remote Control

Keep this flap unfolded and use this page for reference.

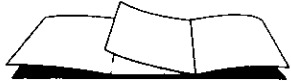

- SYSTEM OFF**  
(page 14)
- TV/VTR** (page 14)
- ANT** (pages 3 and 14)
- PICTURE MODE**  
(pages 13 and 18)
- SLEEP** (page 13)
- JUMP** (page 13)
- TV/SAT**  
(page 14)
- RESET** (page 13)
- VOL +/-**
- CODE SET**  
(pages 28-30)

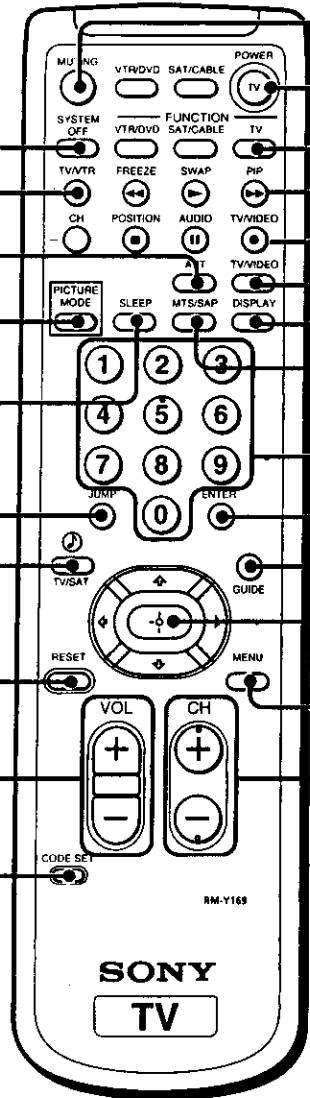

- MUTING**
- TV (POWER)**
- TV (FUNCTION)**
- PIP** (page 15)
- TV/ VIDEO** (page 14)
- DISPLAY** (page 14)
- MTS/SAP**  
(pages 14 and 19)
- 0 - 9 buttons**
- ENTER**
- GUIDE** (page 14)
- Select buttons**  
(pages 11 and 16)
- MENU**
- CH +/-**

## Getting to know the buttons on the remote control

Names of the buttons on the remote control are in different colors to represent the available functions.

### Button color

- Clear ..... Indicates which equipment is currently being controlled
- Green ..... Buttons relevant to power operations



### Label color

- White ..... TV/VTR (VCR)/DVD/SAT/CABLE operation buttons
- Yellow ..... PIP operation buttons
- Blue ..... SAT operation buttons
- Green ..... SYSTEM OFF operation button

*All references to buttons on the remote control will be highlighted with bold text.*

## WARNING

To reduce the risk of fire or shock hazard, do not expose the TV to rain or moisture.

	<b>CAUTION</b> RISK OF ELECTRIC SHOCK DO NOT OPEN	
<b>ATTENTION</b> RISQUE DE CHOC ELECTRIQUE, NE PAS OUVRIR		
<b>PRECAUCION</b> RIESGO DE CHOQUE ELECTRICO NO ABRIR		
CAUTION: TO REDUCE THE RISK OF ELECTRIC SHOCK, DO NOT REMOVE COVER (OR BACK). NO USER-SERVICEABLE PARTS INSIDE. REFER SERVICING TO QUALIFIED SERVICE PERSONNEL.		



This symbol is intended to alert the user to the presence of uninsulated "dangerous voltage" within the product's enclosure that may be of sufficient magnitude to constitute a risk of electric shock to persons.



This symbol is intended to alert the user to the presence of important operating and maintenance (servicing) instructions in the literature accompanying the appliance.

## CAUTION

TO PREVENT ELECTRIC SHOCK, MATCH WIDE BLADE OR PLUG TO WIDE SLOT, FULLY INSERT.

## CAUTION

When using TV games, computers, and similar products with your TV, keep the brightness and picture contrast functions at low settings. If a fixed (non-moving) pattern is left on the screen for long periods of time at a high brightness or picture contrast setting, the image can be permanently imprinted onto the screen. Continuously watching the same program can cause the imprint of station logos onto the TV screen. These types of imprints are not covered by your warranty because they are the result of misuse.

### Note on Caption Vision

This television receiver provides display of television closed captioning in accordance with §15.119 of the FCC rules.

### Note on cleaning the TV

Clean the TV with a soft dry cloth. Never use strong solvents such as thinner or benzine, which might damage the finish of the cabinet.

### Note to CATV system installer

This reminder is provided to call the CATV system installer's attention to Article 820-40 of the NEC that provides guidelines for proper grounding and, in particular, specifies that the cable ground shall be connected to the grounding system of the building, as close to the point of cable entry as practical.

Use of this television receiver for other than private viewing of programs broadcast on UHF or VHF or transmitted by cable companies for the use of the general public may require authorization from the broadcaster/cable company and/or program owner.

## NOTIFICATION

This equipment has been tested and found to comply with the limits for a Class B digital device pursuant to Part 15 of the FCC Rules. These limits are designed to provide reasonable protection against harmful interference in a residential installation.

This equipment generates, uses, and can radiate radio frequency energy and, if not installed and used in accordance with the instructions, may cause harmful interference with radio communications. However, there is no guarantee that interference will not occur in a particular installation. If this equipment does cause harmful interference to radio or television reception, which can be determined by turning the equipment off and on, the user is encouraged to try to correct the interference by one or more of the following measures:

- Reorient or relocate the receiving antennas.
- Increase the separation between the equipment and receiver.
- Connect the equipment into an outlet on a circuit different from that to which the receiver is connected.
- Consult the dealer or an experienced radio/TV technician for help.

You are cautioned that any changes or modifications not expressly approved in this manual could void your authority to operate this equipment.

This document is for the remote control RM-Y168, 169.  
MODELS: KV-32S42, 32S66, 32V42, 35S42, 35S66, 35V42



As an ENERGY STAR® Partner, Sony has determined that this product or product models meets the ENERGY STAR® guidelines for energy efficiency.

ENERGY STAR® is a U.S. registered mark.

## Owners Record

The model and serial numbers are located on the front of this instruction manual and the rear panel of the TV.

Model Number \_\_\_\_\_  
Serial Number \_\_\_\_\_

# Important Safeguards

For your protection, please read these instructions completely, and keep this manual for future reference.

Carefully observe and comply with all warnings, cautions and instructions placed on the set, or described in the operating instructions or service manual.

## WARNING

To guard against injury, the following basic safety precautions should be observed in the installation, use, and servicing of the set.

### Use

#### Power Sources

This set should be operated only from the type of power source indicated on the serial/model plate. If you are not sure of the type of electrical power supplied to your home, consult your dealer or local power company. For those sets designed to operate from battery power, refer to the operating instructions.



#### Grounding or Polarization

This set is equipped with a polarized AC power cord plug (a plug having one blade wider than the other), or with a three-wire grounding type plug (a plug having a third pin for grounding).

Follow the instructions below:

#### For the set with a polarized AC power cord plug

This plug will fit into the power outlet only one way. This is a safety feature. If you are unable to insert the plug fully into the outlet, try reversing the plug. If the plug should still fail to fit, contact your electrician to have a suitable outlet installed. Do not defeat the safety purpose of the polarized plug by forcing it in.



### Alternate Warning

#### For the set with a three-wire grounding type AC plug

This plug will only fit into a grounding-type power outlet. This is a safety feature. If you are unable to insert the plug into the outlet, contact your electrician to have a suitable outlet installed. Do not defeat the safety purpose of the grounding plug.

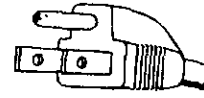

#### Overloading

Do not overload wall outlets, extension cords or convenience receptacles beyond their capacity, since this can result in fire or electric shock.

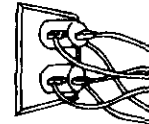

Always turn the set off when it is not to be used. When the set is left unattended and unused for long periods of time, unplug it from the wall outlet as a precaution against the possibility of an internal malfunction that could create a fire hazard.



#### Object and Liquid Entry

Never push objects of any kind into the set through the cabinet slots as they may touch dangerous voltage points or short out parts that could result in a fire or electric shock. Never spill liquid of any kind on the set.



#### Attachments

Do not use attachments not recommended by the manufacturer, as they may cause hazards.

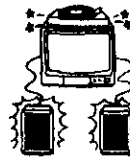

#### Cleaning

Unplug the set from the wall outlet before cleaning or polishing it. Do not use liquid cleaners or aerosol cleaners. Use a cloth lightly dampened with water for cleaning the exterior of the set. If a snapping or popping sound from a TV set is continuous or frequent



while the TV is operating, unplug the TV and consult your dealer or service technician. It is normal for some TV sets to make occasional snapping or popping sounds, particularly when being turned on or off.

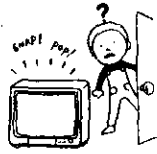

### Installation

#### Water and Moisture

Do not use power-line operated sets near water — for example, near a bathtub, washbowl, kitchen sink, or laundry tub, in a wet basement, or near a swimming pool, etc.



#### Accessories

Do not place the set on an unstable cart, stand, table or shelf. The set may fall, causing serious injury to a child or an adult, and serious damage to the set. Use only a cart or stand recommended by the manufacturer for the specific model of TV. An appliance and cart combination should be moved with care. Quick stops, excessive force, and uneven surfaces may cause the appliance and cart combination to overturn.



#### Ventilation

The slots and openings in the cabinet and in the back or bottom are provided for necessary ventilation. To ensure reliable operation of the set, and to protect it from overheating, these slots and openings must never be blocked or covered.



- Never cover the slots and openings with a cloth or other materials.



- Never block the slots and openings by placing the set on a bed, sofa, rug or other similar surface.

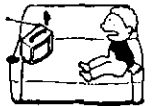

## Important Safeguards (continued)

- Never place the set in a confined space, such as a bookcase, or built-in cabinet, unless proper ventilation is provided.
- Do not place the set near or over a radiator or heat register, or where it is exposed to direct sunlight.

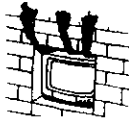

### Power-Cord Protection

Do not allow anything to rest on or roll over the power cord, and do not place the set where the power cord is subject to wear or abuse.

### Antennas

#### Outdoor Antenna Grounding

If an outdoor antenna is installed, follow the precautions below.

An outdoor antenna system should not be located in the vicinity of overhead power lines or other electric light or power circuits, or where it can come in contact with such power lines or circuits.

**WHEN INSTALLING AN OUTDOOR ANTENNA SYSTEM, EXTREME CARE SHOULD BE TAKEN TO KEEP FROM CONTACTING SUCH POWER LINES OR CIRCUITS AS CONTACT WITH THEM IS ALMOST INVARIABLY FATAL.**

Be sure the antenna system is grounded so as to provide some protection against voltage surges and built-up static charges. Section 810 of the National Electrical Code (NEC) in USA and Section 54 of the Canadian Electrical Code in Canada provides information with respect to proper grounding of the mast and supporting structure, grounding of the lead-in wire to an antenna discharge unit, size of grounding conductors, location of antenna discharge unit, connection to grounding electrodes, and requirements for the grounding electrode.

Antenna Grounding According to the NEC  
Refer to section 54-300 of Canadian Electrical Code for Antenna Grounding.

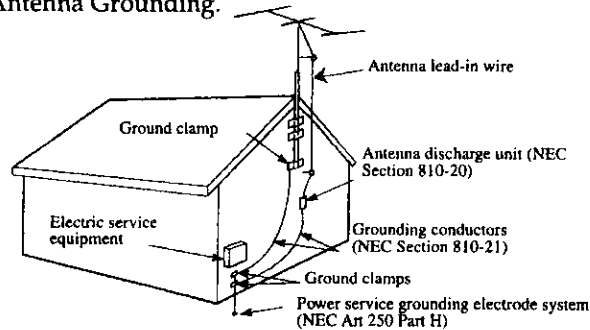

NEC: National Electrical Code

### Lightning

For added protection for this television receiver during a lightning storm, or when it is left unattended and unused for long periods of time, unplug it from the wall outlet and disconnect the antenna. This will prevent damage to the receiver due to lightning and power-line surges.

### Service

#### Damage Requiring Service

Unplug the set from the wall outlet and refer servicing to qualified service personnel under the following conditions:

- When the power cord or plug is damaged or frayed.
- If liquid has been spilled into the set.
- If the set has been exposed to rain or water.

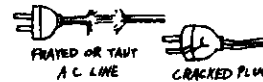

- If the set has been subject to excessive shock by being dropped, or the cabinet has been damaged.
- If the set does not operate normally when following the operating instructions. Adjust only those controls that are specified in the operating instructions. Improper adjustment of other controls may result in damage and will often require extensive work by a qualified technician to restore the set to normal operation.
- When the set exhibits a distinct change in performance — this indicates a need for service.

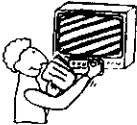
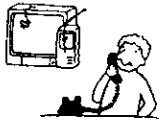

### Servicing

Do not attempt to service the set yourself since opening the cabinet may expose you to dangerous voltage or other hazards.

Refer all servicing to qualified service personnel.

### Replacement Parts

When replacement parts are required, be sure the service technician certifies in writing that he has used replacement parts specified by the manufacturer that have the same characteristics as the original parts. Unauthorized substitutions may result in fire, electric shock, or other hazards.

### Safety Check

Upon completion of any service or repairs to the set, ask the service technician to perform routine safety checks (as specified by the manufacturer) to determine that the set is in safe operating condition, and to so certify. When the set reaches the end of its useful life, improper disposal could result in a picture tube implosion. Ask a qualified service technician to dispose of the set.



## Welcome!

Thank you for purchasing the Sony Trinitron® Color TV. Before reading, check the model number located on the front of this manual.

The menus and illustrations used in these instructions are for KV-35S66. Differences in operation or features will be indicated in the text, for example, "KV-35S66 only."

Model Number	PICTURE IN PICTURE (PIP)	SRS	SURROUND	AUTO VOLUME CONTROL
KV-32S42			•	
KV-32S66	•		•	
KV-32V42		•	•	•
KV-35S42			•	
KV-35S66	•		•	
KV-35V42		•	•	•

## Precautions

### Safety

- Operate the TV only with 120 V AC .
- The plug is designed, for safety purposes, to fit in the wall outlet only one way. If you are unable to insert the plug fully into the outlet, contact your dealer.
- If any liquid or solid object should fall inside the cabinet, unplug the TV immediately and have it checked by qualified personnel before operating it further.

### Installing

- To prevent internal heat build-up, do not block the ventilation openings.
- Do not install the TV in a hot or humid place, or in a place subject to excessive dust or mechanical vibration.
- The AC power cord is attached to the rear of the TV with hooks. Do not attempt to remove the cord from these hooks. Doing so could cause damage to the TV.

## Using This Manual

This manual is divided into five major sections. We recommend that you review the contents before you begin to use your new TV.

### 1 Connecting and Installing the TV

This section guides you through your initial set up. It shows how to connect to your antenna or cable, and connect any accessories.

### 2 Basic Set Up

This section teaches you the basic skills needed to operate your new TV.

### 3 Using your New TV

This section shows the initial setup screen and how to use your remote control.

### 4 Using your Menus

This section teaches you how to access on-screen menus and adjust your TV's settings.

### 5 Troubleshooting

This section helps you to correct problems you may encounter with your TV.

## **Making Connections**

Refer to the table below, it will direct you to the diagram suitable to the equipment you will be connecting.

<b>If you will be connecting</b>	<b>See page</b>
Cable or antenna only	3
Cable and antenna	3
Cable box	4
Cable box and cable to view scrambled channels	4
VCR and cable or antenna	5
VCR and cable box	5
Two VCRs for tape editing	6
Satellite Receiver	7
VCR and Satellite Receiver	7
DVD Player	8
Audio system	9
Camcorder to view tapes	9
VCR using S-Link	10
Satellite Receiver using S-Link	10



## Cable or Antenna Connections

### Connecting directly to cable or an antenna

The connection you choose will depend on the cable found in your home. Newer homes will be equipped with standard coaxial cable (see **A**); older homes will probably have 300-ohm twin lead cable (see **B**); still other homes may contain both (see **C**).

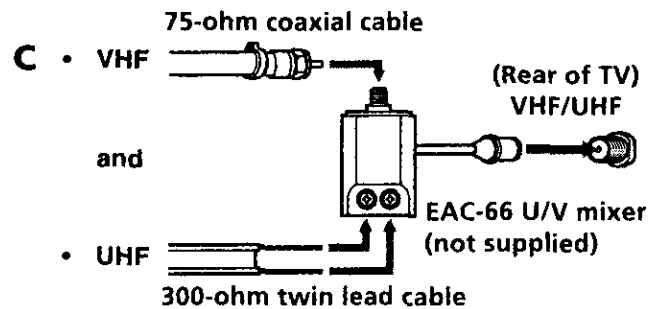
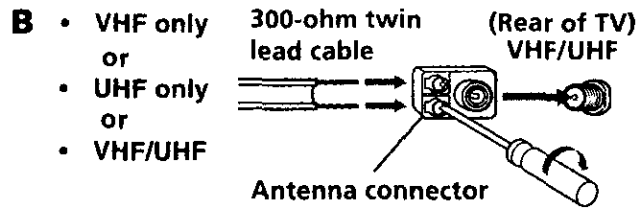
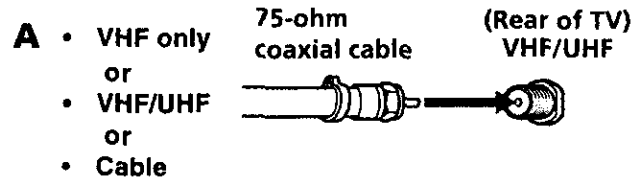

### Cable and antenna

#### KV-32S66, 35S66 only

If your cable provider does not feature local channels, you may find this set up convenient.

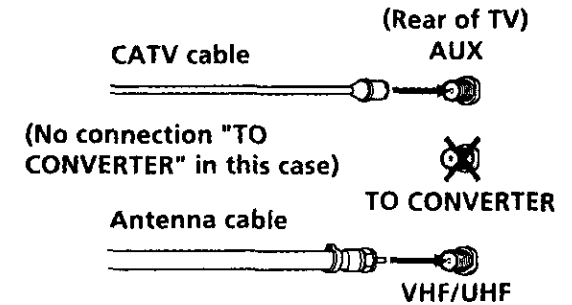

Select CABLE or antenna (ANT) mode by pressing ANT on the remote control.

#### Note

In order to receive channels with an antenna, you will need to turn your CABLE to OFF and perform the AUTO PROGRAM function, (see page 23).

## Connecting and Installing the TV (continued)

### Cable Box Connections

Some pay cable TV systems use scrambled or encoded signals that require a cable box to view all channels.

#### Cable box

- 1 Connect the coaxial connector from your cable to the IN on your cable box.
- 2 Using a coaxial cable, connect OUT on your cable box to VHF/UHF on your TV.

*If you will be controlling all channel selection through your cable box, you should consider using the CHANNEL FIX feature, (see page 23).*

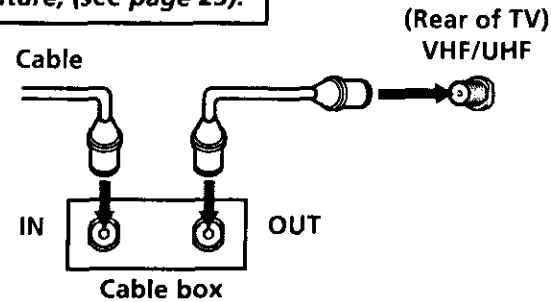

#### Cable box and cable

##### KV-32S66, 35S66 only

For this set up, you can switch between scrambled channels (through your cable box), and normal (CATV) channels by pressing ANT on your remote control.

#### Notes

- Your Sony remote control can be programmed to operate your cable box, (see page 30).
- When using PIP, you cannot view the AUX input in the window picture.

#### Tip

Pressing ANT switches between these inputs.

*If you are connecting a cable box through the AUX input and would like to switch between the AUX and normal (CATV) input you should consider using the CHANNEL FIX feature, (see page 23).*

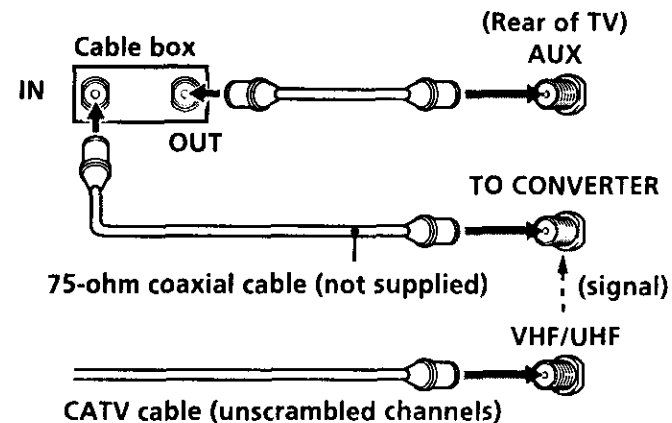

## VCR Connections

### Connecting an antenna/cable TV system with a VCR

- 1 Attach the coaxial connector from your cable or antenna to IN on your VCR.
- 2 Using A/V connectors, connect AUDIO and VIDEO OUT on your VCR to AUDIO and VIDEO IN on your TV.
- 3 Using a coaxial connector, connect OUT on your VCR to VHF/UHF on your TV.

#### Tip

If you are connecting a monaural VCR, connect only the single white audio output to the left input on your TV.

### Connecting a VCR and TV with a cable box

- 1 Connect the coaxial cable from the wall to IN on your cable box.
- 2 Using a coaxial connector, connect OUT on your cable box to IN on your VCR.
- 3 Connect a coaxial cable (not supplied) from the OUT jack on your VCR to VHF/UHF on your TV.
- 4 Using A/V connectors, connect AUDIO and VIDEO OUT on your VCR to AUDIO and VIDEO IN on your TV.

For optimum picture quality, use S VIDEO instead of the yellow A/V cable. S VIDEO does not provide sound, your audio connectors must still be connected.

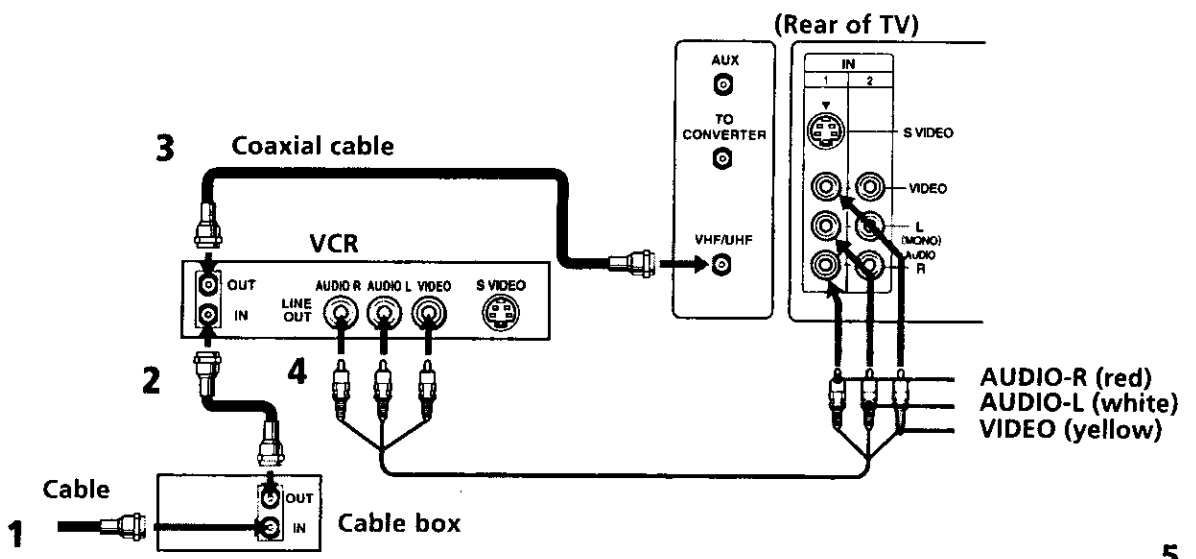
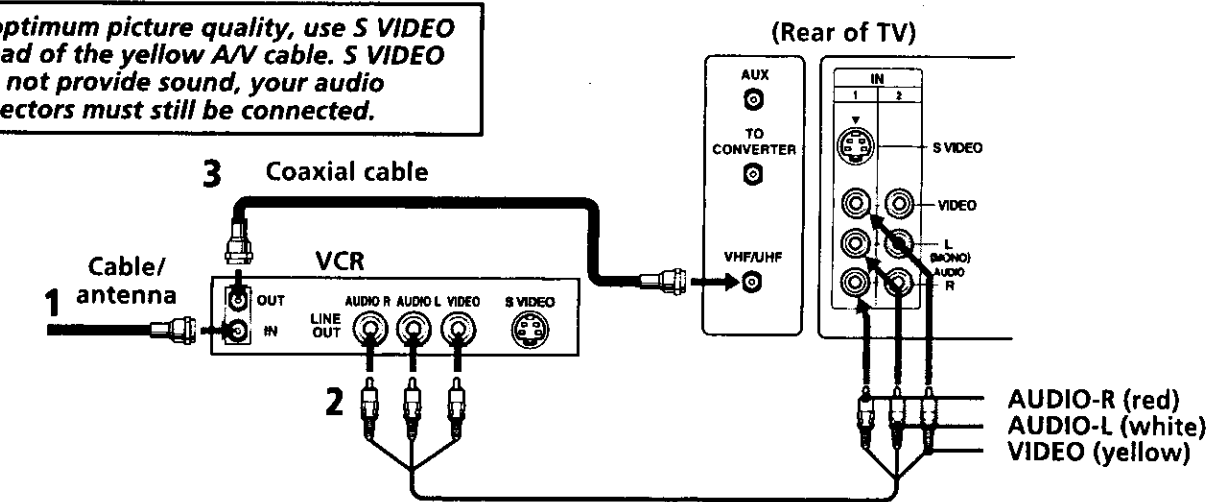

## Connecting and Installing the TV (continued)

### Connecting two VCRs for tape editing

**KV-32V42, 35V42 only**

MONITOR OUT gives you the ability to use a second VCR to record a program being played by the primary VCR or to perform tape editing and dubbing.

- 1 Connect the VCR intended for playback using the connection instructions on page 5 of this manual.
- 2 Using A/V connectors, connect AUDIO and VIDEO IN on your VCR intended for recording to MONITOR AUDIO and VIDEO OUT on your TV.

*To perform tape editing; set the TV to the video input intended for playback by pressing TV/VIDEO.*

(Rear of KV-35V42)

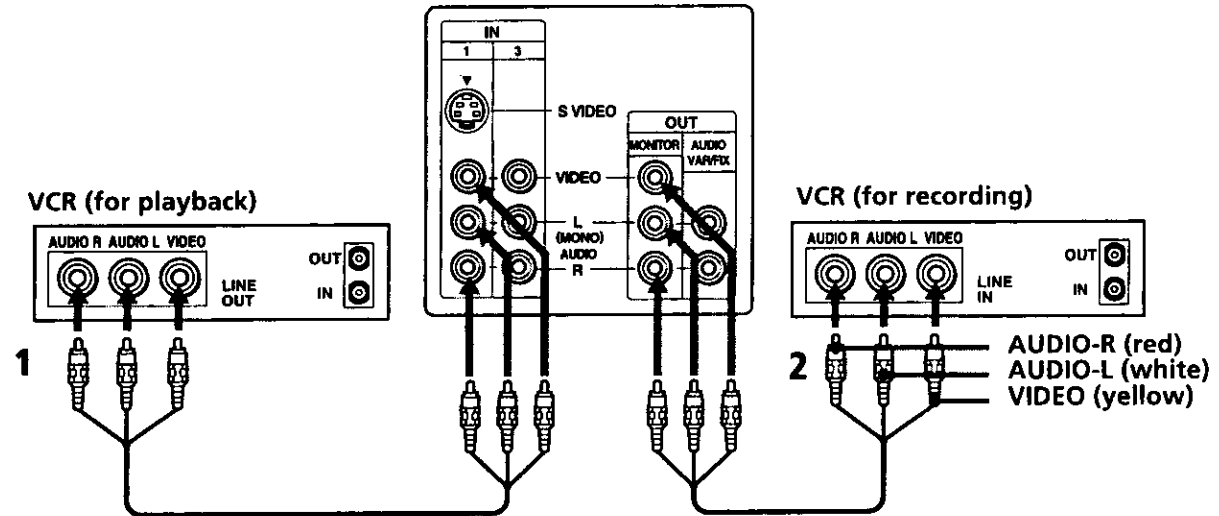

## Satellite Receiver Connections

### Connecting a satellite receiver

- 1 Connect the cable from your satellite antenna to SATELLITE IN on your receiver.
- 2 Attach the coaxial connector from your cable or antenna to VHF/UHF on your TV.
- 3 Using A/V connectors, connect AUDIO and VIDEO OUT on your receiver to AUDIO and VIDEO IN on your TV.

*For optimum picture quality, use S VIDEO instead of the yellow A/V cable. S Video does not provide sound, your audio connectors must still be connected.*

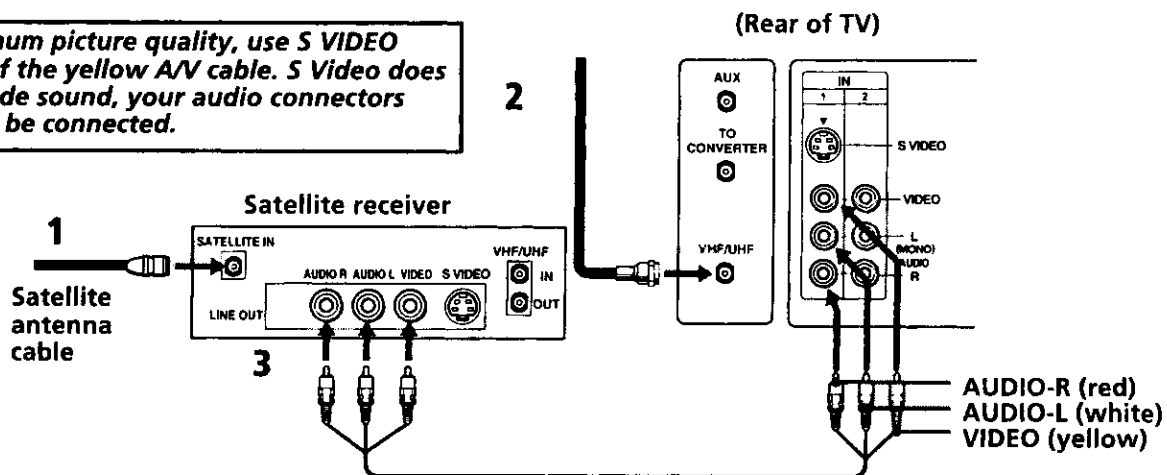

### Connecting a satellite receiver and a VCR

- 1 Connect the cable from your satellite antenna to SATELLITE IN on your receiver.
- 2 Attach the coaxial connector from your cable or antenna to IN on your VCR.
- 3 Using a coaxial connector, connect OUT on your VCR to VHF/UHF on your TV.
- 4 Using A/V connectors, connect AUDIO and VIDEO OUT on your receiver to AUDIO and VIDEO IN on your VCR.
- 5 Using A/V connectors, connect AUDIO and VIDEO OUT on your VCR to AUDIO and VIDEO IN on your TV.

*Pressing TV/VIDEO on the remote control will allow you to view from the satellite receiver or VCR.*

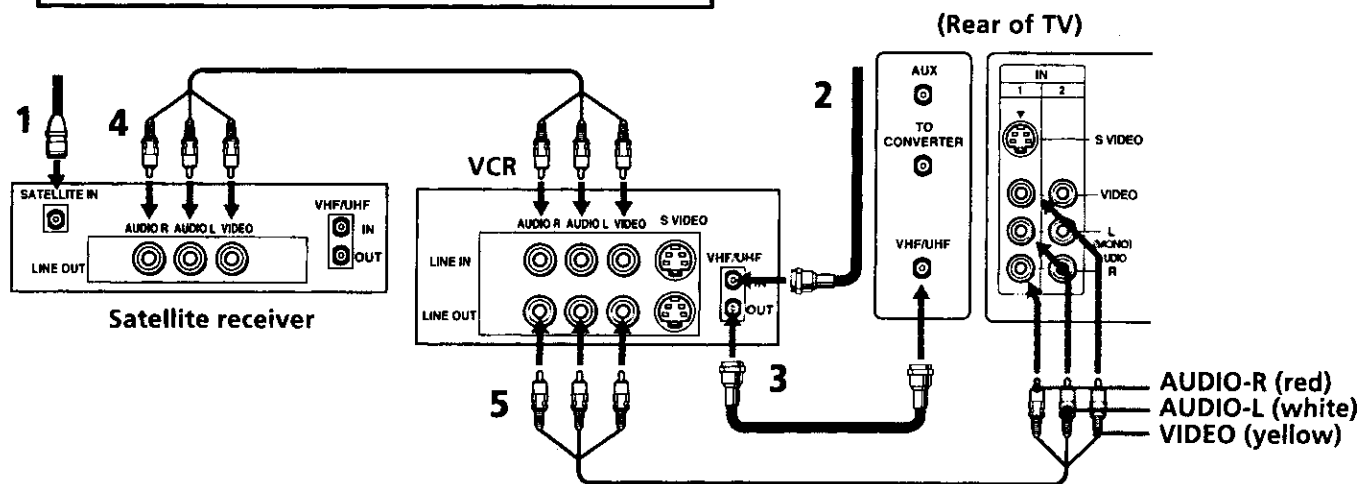

## Connecting and Installing the TV (continued)

### DVD Player Connections

#### Connecting a DVD Player

- 1 Using audio connectors, connect AUDIO OUT on your DVD player to AUDIO IN on your TV.
- 2 Using an S VIDEO cable, connect S VIDEO on your DVD player to S VIDEO on your TV.

#### Note

If you do not have an S Video cable, connect a yellow video cable from LINE OUT VIDEO on your DVD to VIDEO IN on your TV.

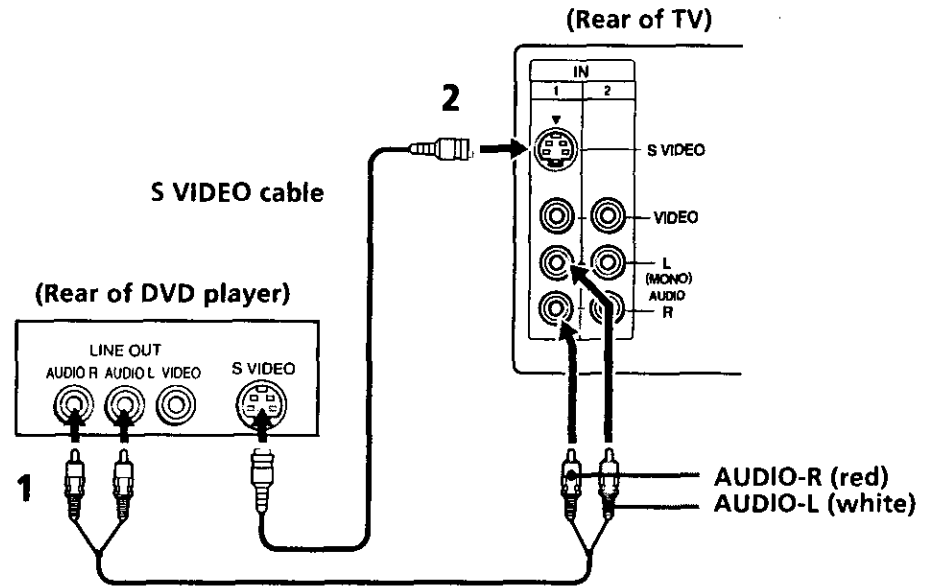

## Additional Connections

### Connecting an audio system

For an enhanced sound, connect your audio system to your TV.

- 1 Using AUDIO connectors, connect AUDIO OUT on your TV to one of the unused Line inputs (e.g. Tape-2, AUX1, etc.) on your stereo.
- 2 Set your stereo to the chosen Line input and use the AUDIO 🎵 menu to set your audio output, (see page 19).

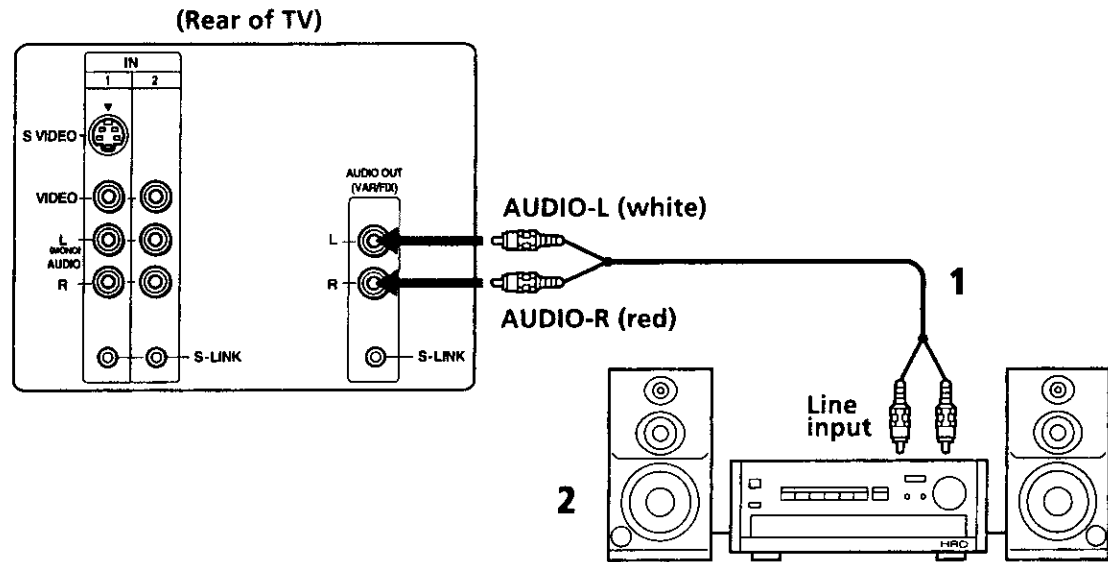

### Connecting a camcorder

This connection is convenient for viewing a picture directly from your camcorder.

Using A/V connectors, connect AUDIO and VIDEO OUT on your camcorder to AUDIO and VIDEO IN on your TV.

Connection can also be made directly to the A/V input located on the rear of the TV.

#### Tip 💡

If you are connecting a monaural camcorder, connect only the single white audio output to the left input on your TV.

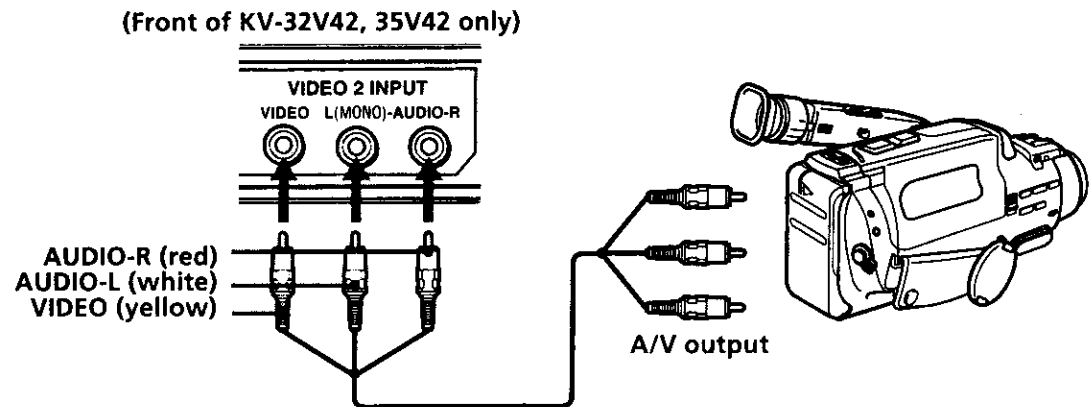

## Connecting and Installing the TV (continued)

### Using Special Sony Features

KV-32S66, 35S66 only

#### Connecting S-Link to a VCR

S-Link automatically powers on the TV and switches to the correct video input when a tape is inserted in the VCR.

- 1 Using A/V connectors, connect AUDIO and VIDEO OUT on your VCR to AUDIO and VIDEO IN on your TV.
- 2 Using an S-Link connector (mono mini plug), connect S-LINK on your VCR to S-LINK/CONTROL S-OUT in the same VIDEO IN column on your TV.

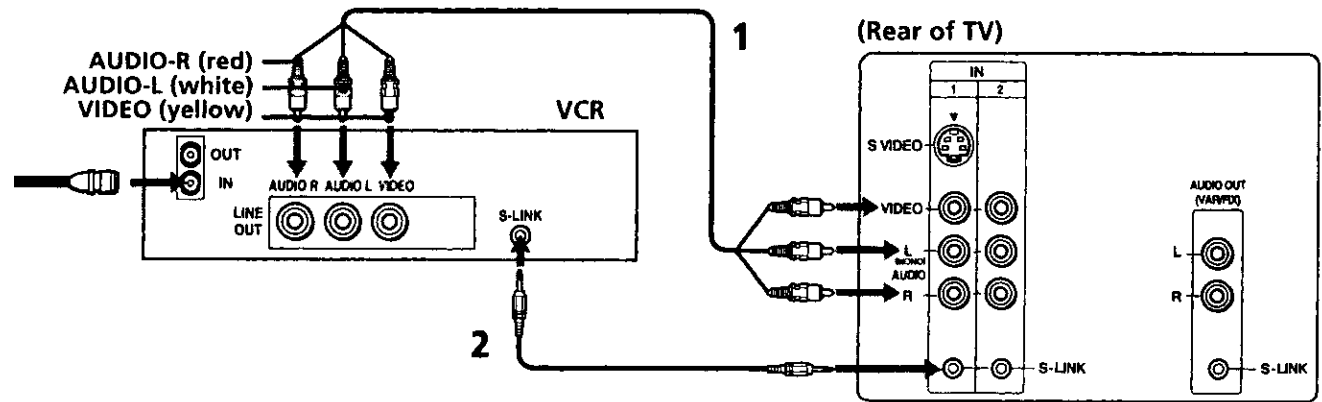

#### Connecting S-Link to a satellite receiver

When you power on the satellite receiver, S-Link automatically powers on the TV and switches to the correct video input.

- 1 Using A/V connectors, connect AUDIO and VIDEO OUT on your satellite receiver to AUDIO and VIDEO IN on your TV.
- 2 Using an S-Link connector (mono mini plug), connect S-LINK on your satellite receiver to S-LINK/CONTROL S-OUT in the same VIDEO IN column on your TV.

**The S-Link connector must be in the same VIDEO-IN column as the connected A/V cables.**

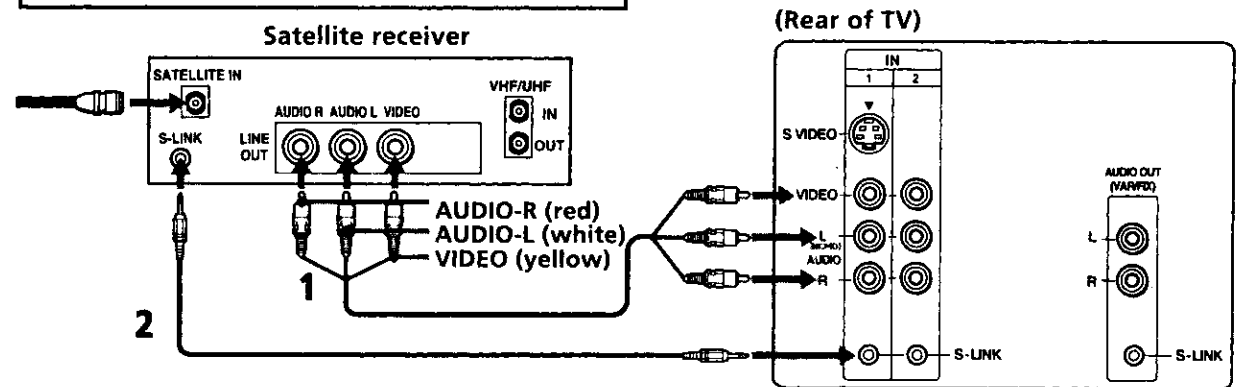

#### Note

The S-Link feature will override the "SKIP" VIDEO LABEL input, (see page 21).



## Basic Set Up

### Inserting batteries

Insert two size AA (R6) batteries (supplied) by matching the + and - on the batteries to the diagram inside the battery compartment.

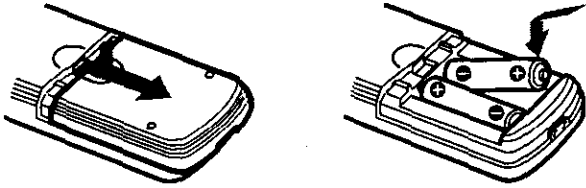

### Notes

- Remove the batteries to avoid damage from possible battery leakage whenever you anticipate that the remote control will not be used for an extended period.
- Handle the remote control with care. Avoid dropping it, getting it wet, or placing it in direct sunlight, near a heater, or where the humidity is high.
- Your remote control can be programmed to operate most video equipment, (see page 28).

### Using the remote control move & select buttons

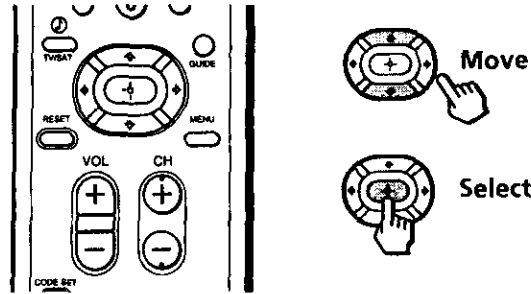

The supplied remote control has "arrow" buttons (↑, ↓, ←, →) which allow for movement of the on-screen (▶) cursor. Pressing on the outer buttons will cause the cursor to *move* in the corresponding direction. Pressing the center button (⊕) will *select* the item.

### Front panel menu control

#### U.S. models only

The front panel controls allow access to the on-screen menus without the use of a remote control.

Press the SET UP button on the TV, then press TV/VIDEO to access the menus. Follow the on-screen instructions to adjust your TV settings.

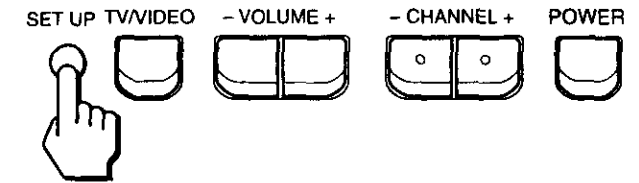

For KV-32V42, 35V42 the control buttons are located on the top of the TV.

## Using Your New TV

### Setting up the TV automatically

After you have finished connecting your TV, you will want to run AUTO PROGRAM to set up your channels.

The AUTO PROGRAM feature does not apply for installations that use a cable box for all channel selection.

#### Tips

- Perform this function during the day, with the antenna and/or cable properly connected, to ensure that all available channels will be broadcasting and receivable.
- If your cable or antenna is connected to AUX, press ANT until AUX appears next to the channel number.

Using the buttons on the front of the TV:



For KV-32V42, 35V42, the control buttons are located on the top of the TV.

- 1 Press POWER to turn on the TV. The initial setup screen appears.

(U.S. models only) (Canadian models only)

ENGLISH: [CH +]	ENGLISH: [CH +]
ESPAÑOL: [CH -]	ESPAÑOL: [CH -]
AUTO SET UP: [VOL +]	FRANÇAIS: [VOL +]
DEMO: [VOL -]	AUTO SET UP: [VOL -]
MENU: [TV/VIDEO]	DEMO: [TV/VIDEO]
First please connect cable/antenna	First please connect cable/antenna

- 2 Make your language selection, the menus will change to reflect your choice.
- 3 Follow the on-screen instructions to continue AUTO SET UP or for a DEMO of the menus.

#### U.S. models only

- 4 Press TV/VIDEO to operate the on-screen menus without the use of a remote control. Follow the on-screen instructions to make adjustments to your TV settings.

### To perform AUTO SET UP again

Press the SET UP button on the TV.

#### Tip

To reset your TV to factory settings, turn the TV on. Then, while pressing the RESET button on your remote control, press the POWER button on your TV. The TV will turn itself off, then back on.

## Watching the TV









The following chart explains more advanced buttons on your remote control.



**REFER TO THE ILLUSTRATION OF THE REMOTE CONTROL ON THE INSIDE FRONT COVER OF THIS MANUAL AS YOU REVIEW THIS CHART**

Using the White Labeled Buttons for TV Operations	
<p>VTR/DVD SAT/CABLE POWER TV</p>	Press when you want to turn connected equipment on and off.
<p>FUNCTION VTR/DVD SAT/CABLE TV</p>	Press when you want to control connected equipment with your remote control, (see pages 28-30 for instructions on programming your remote control).
<p>0 - 9</p>	Use for direct channel selection. Press <b>0-9</b> to select a channel, the channel will change after 2 seconds, or you can press <b>ENTER</b> for immediate selection.
<p>PICTURE MODE</p>	Cycles through the VIDEO MODE settings: VIVID, MOVIE, STANDARD.
<p>JUMP</p>	Alternates back and forth between the last two channels selected with the <b>0-9</b> keys.
<p>MUTING</p>	Instantly turns off the sound. Press again or press <b>VOL +</b> to restore sound.
<p>SLEEP</p>	Turns the TV off in approximately 30, 60, or 90 minutes. Cancel by pressing until <b>SLEEP OFF</b> appears.
<p>RESET</p>	Press to return to factory settings while in an on-screen menu.

## Using Your New TV (continued)

Using the White Labeled Buttons for TV Operations	
DISPLAY 	Press once to display current time and CHANNEL CAPTION (if set) and channel number. Press again to activate current CAPTION VISION setting. To cancel, press <b>DISPLAY</b> until DISPLAY OFF appears.
TV/VIDEO 	Press repeatedly to cycle through available video inputs.
ANT  (AUX input)	Press to change the VHF/UHF input to the AUX input. (KV-32S66, 35S66 only)
TV/VTR 	Press when you are finished using a VCR and you want to switch to the TV input. Your VCR power will remain on.
MTS/SAP 	Cycles through the Multi-channel TV Sound (MTS) options: STEREO, SAP (Second Audio Program), MONO (see page 19).
SYSTEM OFF 	Powers off all Sony equipment at once. <i>This feature may not work with older Sony equipment.</i>
 TV/SAT	Cycles through the available audio settings.
 GUIDE	Brings up the custom guide of your satellite receiver. (Your remote control must be programmed to operate your satellite receiver, see page 30)

## Using Picture-in-Picture – PIP

**KV-32S66, 35S66 only**

Picture-in-Picture (PIP) allows you to watch two channels simultaneously, one in the large main window and another in a small window picture.

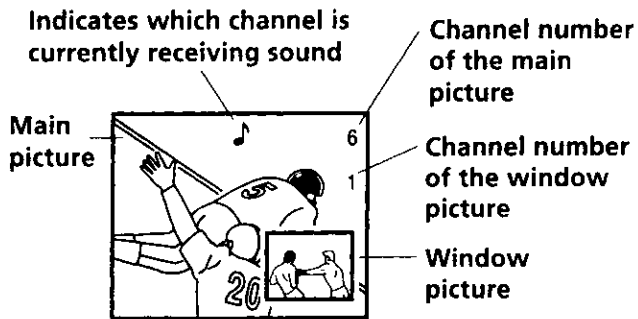

### Notes

- You must press TV (FUNCTION) before you can control PIP with the yellow labeled buttons.
- The AUX input cannot be viewed in the window picture.



**REFER TO THE ILLUSTRATION OF THE REMOTE CONTROL ON THE INSIDE FRONT COVER OF THIS MANUAL AS YOU REVIEW THIS CHART**

Use the Yellow Labeled Buttons for PIP Operations	
PIP 	Displays the window picture. Press again to decrease the size. To cancel, press until the window picture turns off.
TV/VIDEO 	Cycles through available video inputs: TV, VIDEO 1, VIDEO 2
AUDIO 	Alternates sound between the main picture and the window picture. A ♪ will appear to indicate which picture is receiving sound.
TV/VTR + CH -	Changes the channel in the window picture.
POSITION 	Moves the location of the window picture.
FREEZE 	Press to freeze the window picture. Press again to restore the picture.
SWAP 	Switches the position of the main picture with the window picture.

# Using Your Menus

## Learning menu selection

Use the **MENU** button to access a menu and use the arrow buttons (▲ or ▼) to alter settings. Use the following example, in which we activate the **CABLE**, to learn how to modify settings.

- 1 Press the **MENU** button.  
The main menu appears.

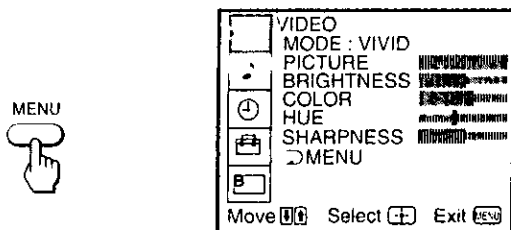

- 2 Press ▲ or ▼ to highlight the desired menu (in this case **SET UP** ) and press (○) to select it.

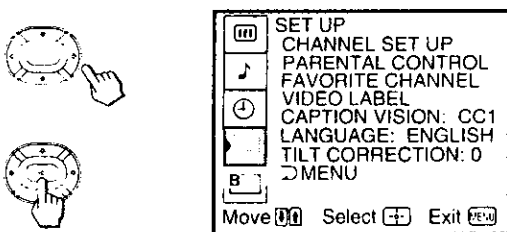

- 3 Press ▲ or ▼ to move to the desired option and press (○).

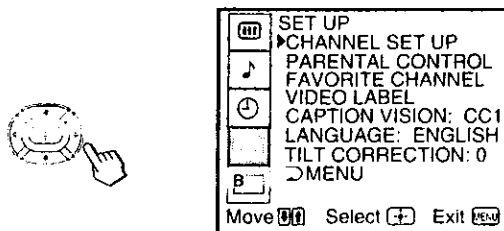

- 4 Press ▲ or ▼ to move to the desired feature and press (○).

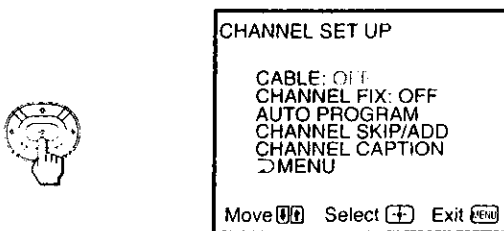

Options for your selection will be highlighted.

- 5 Press ▲ or ▼ to make your selection and press (○).

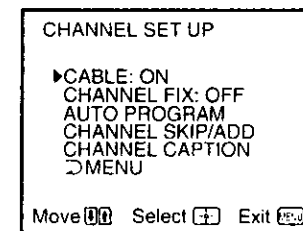

When you are finished making changes to the selected menu, choose >MENU to return to the main menu.

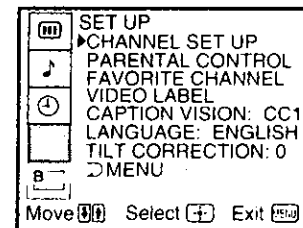

### Tip

Pressing **MENU** on the remote control will allow you to exit from the menus at any time.

## Quick start to the menus

The following is a guide to your menus.

### To select a menu:

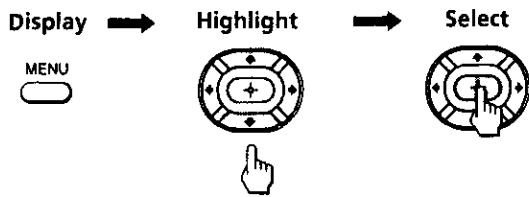

### Note

Menus shown are for KV-35S66, your menus may not look exactly like those illustrated.

	<p>The VIDEO menu will allow you to make adjustments to your picture settings. It will also allow you to customize the picture MODE based on the type of program you are viewing.</p>	
	<p>The AUDIO menu offers enhanced audio options such as listening to second audio programming (SAP), or customizing the EFFECT of the sound on your TV.</p>	
	<p>The TIMER menu sets the clock on your TV and allows you to program your TV for scheduled viewing using the ON/OFF TIMER.</p>	
	<p>The SET UP menu provides several options for setting up your channels, labeling your TV/VIDEO inputs, and selecting the LANGUAGE of your menus.</p> <p>The CHANNEL SET UP menu is a sub-menu which provides further options for setting up your TV.</p>	
	<p>The Basic Menu provides quick access to frequently used settings.</p>	

## Using Your Menus (continued)

### Using the VIDEO menu

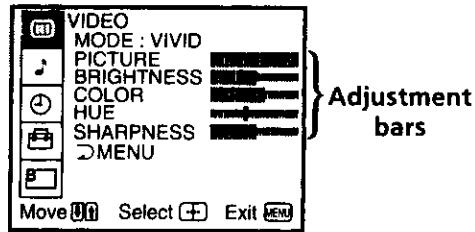

### To select the VIDEO menu:

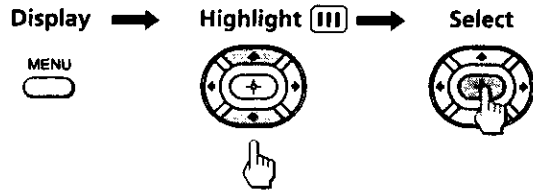

<b>MODE</b> <i>Customized picture viewing</i>	<b>VIVID:</b> Select for enhanced picture contrast and sharpness. <b>MOVIE:</b> Select for a finely detailed picture. <b>STANDARD:</b> Select to receive a standard picture. <i>Press the <b>PICTURE MODE</b> button to access one of the above settings directly.</i>
<b>PICTURE</b> <i>Picture contrast</i>	Adjust left to decrease picture contrast and soften the color. Adjust right to increase picture contrast and create more vivid color.
<b>BRIGHTNESS</b> <i>Picture adjustment</i>	Adjust left to darken the picture. Adjust right to brighten the picture.
<b>COLOR</b> <i>Color saturation</i>	Adjust left to decrease color intensity or saturation. Adjust right to increase color intensity or saturation.
<b>HUE</b> <i>Color tones</i>	Adjust left to increase the red tones. Adjust right to decrease the red tones.
<b>SHARPNESS</b> <i>Picture detail</i>	Adjust left to soften the picture detail. Adjust right to sharpen the picture detail.



## Using the AUDIO 🎵 menu

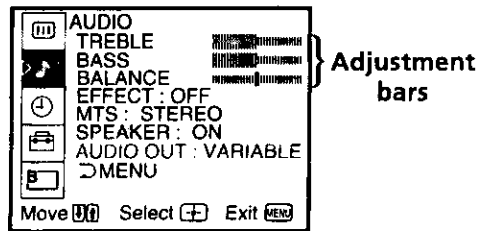

### To select the AUDIO 🎵 menu:

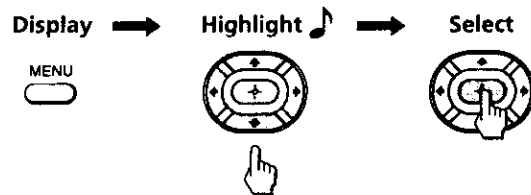

### Tips 💡

- Press to cycle through your AUDIO options.
- Press MTS/SAP on your remote control to cycle through the MTS options.

<b>TREBLE</b>	Adjust left or right to decrease or increase higher frequency sounds.
<b>BASS</b>	Adjust left or right to decrease or increase lower frequency sounds.
<b>BALANCE</b>	Adjust left or right to emphasize left and right speaker balance.
<b>AUTO VOLUME</b> <i>Stabilizes volume</i>	<b>KV-32V42, 35V42 only</b> <b>ON:</b> Select to stabilize the volume. <b>OFF:</b> Select to turn AUTO VOLUME off.
<b>EFFECT</b> <i>Enhanced audio</i>	<b>SURROUND:</b> Simulates theater quality sound for programs broadcast in stereo. (KV-32S42, 32S66, 35S42, 35S66). <b>SIMULATED:</b> Adds a stereo-like effect to mono programs. (KV-32V42, 35V42 only) <b>SRS:</b> Produces a dynamic three dimensional sound for stereo signals. (KV-32V42, 35V42 only) <b>OFF:</b> Normal stereo or mono reception.
<b>MTS</b> <i>Multi-Channel sound</i>	<b>MONO:</b> Select to reduce noise in areas with poor reception. <b>SAP:</b> Select to listen to bilingual broadcast or other Second Audio Programs (SAP). <b>STEREO:</b> Select when viewing a broadcast in stereo.
<b>SPEAKER</b> <i>Custom selection of audio output source</i>	<b>ON:</b> Select to listen to the sound from the TV speakers with or without a separate stereo system. <b>OFF:</b> Select to turn off the TV speakers and listen to the TV's sound only through external audio system speakers.
<b>AUDIO OUT</b> <i>Use to control the TV's volume through a stereo</i>	AUDIO OUT can only be set when SPEAKER is set to OFF. <b>VARIABLE:</b> Adjust the volume through your TV. <b>FIXED:</b> Adjust the TV volume through a connected stereo.

## Using the TIMER ⌚ menu

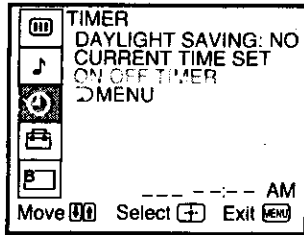

### To select the TIMER ⌚ menu:

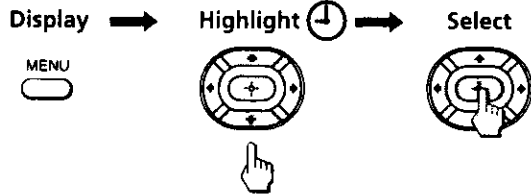

**Tip** 💡

Set **DAYLIGHT SAVING** before setting the clock.

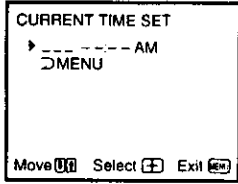
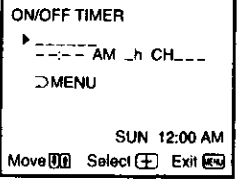
<p><b>DAYLIGHT SAVING</b></p>	<p><b>YES:</b> Select to compensate for Daylight Saving Time.  <b>NO:</b> Select at the end of Daylight Saving Time.</p>
<p><b>CURRENT TIME SET</b>  <i>Necessary for the ON/OFF TIMER</i></p>	<p>With the <b>CURRENT TIME SET</b> menu open:</p> <ol style="list-style-type: none"> <li>1 Press (+).</li> <li>2 Press ⬆ or ⬇ until the current day is displayed. Press (+) to select.</li> <li>3 Press ⬆ or ⬇ until the current hour and AM/PM is displayed. Press (+) to select.</li> <li>4 Press ⬆ or ⬇ until the current minute is displayed, and press (+).</li> </ol> <p><i>Any loss of power will cause these settings to be cleared.</i></p> 
<p><b>ON/OFF TIMER</b>  <i>Wake up or scheduled viewing</i></p>	<p><i>CURRENT TIME SET must be programmed before you can use the ON/OFF TIMER.</i></p> <p>With the <b>ON/OFF TIMER</b> menu open:</p> <ol style="list-style-type: none"> <li>1 Press (+).</li> <li>2 Press ⬆ or ⬇ until the desired day or range of days is displayed. Press (+) to select.</li> <li>3 Indicate the time that you want the TV to turn on (hour, then minutes) by pressing ⬆ or ⬇ and then (+).</li> <li>4 Set the time duration (maximum of 6 hours) by pressing ⬆ or ⬇ and then (+).</li> <li>5 Press ⬆ or ⬇ until you reach the desired channel. Press (+) to select.</li> </ol> <p><i>When you perform AUTO PROGRAM, all ON/OFF TIMER settings will be cleared.</i></p> 

## Using the SET UP menu

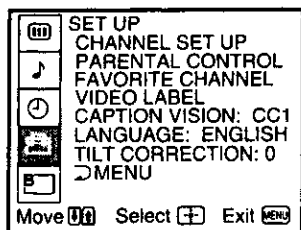



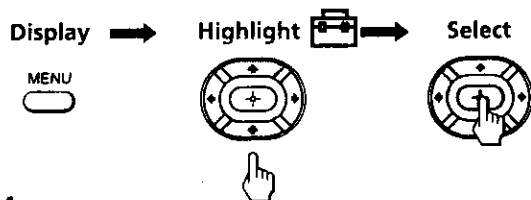







### To select the SET UP menu:



#### Note

The FAVORITE CHANNEL feature is not available for the AUX input.

<b>CHANNEL SET UP</b>	<p>The CHANNEL SET UP menu is a submenu which provides further options for setting up your TV. (see page 23)</p>
<b>PARENTAL CONTROL</b>	<p>The PARENTAL CONTROL feature provides parents several options for programming the TV to block shows based on their rating. (see pages 24-27).</p>
<b>FAVORITE CHANNEL</b> <i>Quick access to favorite channels</i>	<p><b>AUTO:</b> Select to automatically program the last five channels accessed with the 0-9 buttons.  <b>MANUAL:</b> Select to program your channels manually.</p> <div data-bbox="1839 391 2053 558" style="border: 1px solid black; padding: 5px;"> <p>FAVORITE CHANNEL</p> <p>▶ MODE : AUTO          PREVIEW : ON</p> <p>1. 6          2. 5          3. 4          4. 3          5. 2</p> <p>▷MENU</p> <p>Move (left arrow) Select (center) Exit (right arrow)</p> </div> <p><b>Using FAVORITE CHANNEL:</b></p> <ol style="list-style-type: none"> <li>Exit all menus and press , your FAVORITE CHANNEL options will appear.</li> <li>Press  or  to access the channel you want to watch, and press .</li> </ol> <p><b>For KV-32S66, 35S66 only</b>          If PREVIEW is set to ON, a window picture displays your favorite channels as you cycle through the options.</p> <div data-bbox="1839 602 2053 769" style="border: 1px solid black; padding: 5px;"> <p>FAVORITES</p> <p>▶ 125 ESPN          14 ABC          48 CBS          16 NBC          5 CBC</p> <p>▷EXIT</p>  </div>
<b>VIDEO LABEL</b> <i>Label connected equipment for easy recognition</i>	<p><b>With the VIDEO LABEL window open:</b></p> <ol style="list-style-type: none"> <li>Press  or  to access the input you want to label and press .</li> <li>Press  or  to choose the label and press .</li> </ol> <p><b>VIDEO LABEL Options:</b>          VHS, 8mm, BETA, LD, GAME, SAT, DVD, WEB, RECEIVER, DTV, SKIP</p> <p>If you select SKIP, your TV will skip this connection when you press the TV/VIDEO button. (Only available for VIDEO 2, VIDEO 3)</p> <div data-bbox="1839 886 2053 1053" style="border: 1px solid black; padding: 5px;"> <p>VIDEO LABEL</p> <p>▶ VIDEO 1 : VHS          VIDEO 2 : GAME          VIDEO 3 : VIDEO 3</p> <p>▷MENU</p> <p>Move (left arrow) Select (center) Exit (right arrow)</p> </div>

## Using Your Menus (continued)

<b>CAPTION VISION</b> <i>Closed Captioning and channel information</i>	<b>CC1, 2, 3 or 4:</b> Displays a printed version of the dialog or sound effects of a program, (the mode should be set to CC1 for most programs). <b>TEXT1, 2, 3 or 4:</b> Displays network/station information presented using either half or the whole screen. <b>XDS (Extended Data Service):</b> Displays network name, program name, program length, and time of the show if the broadcaster offers this service. <b>To activate CAPTION VISION</b> Press the <b>DISPLAY</b> button on the remote control, until your CAPTION VISION selection is displayed.
<b>LANGUAGE</b>	Select from available languages to display all menus in your language of choice.
<b>TILT CORRECTION</b>	<b>For KV-35S42, 35S66, 35V42 only</b> Press <b>↑</b> or <b>↓</b> to correct any tilt of the picture between +5 and -5 and press <b>⊕</b> .

## Using the CHANNEL SET UP menu

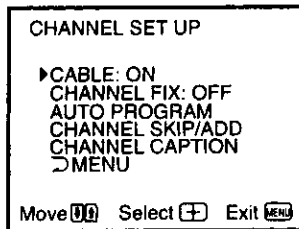

### To select the CHANNEL SET UP menu:

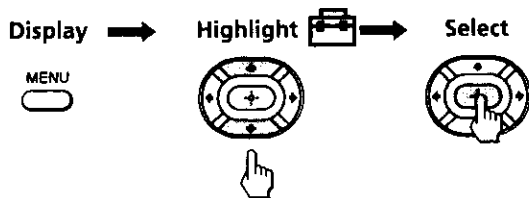

#### Note

Your remote control can be programmed to operate your cable box. (see page 30)

<b>CABLE</b>	<b>ON:</b> Select if you are receiving cable channels with a CATV cable. <b>OFF:</b> Select if you are using an antenna. You will need to run <b>AUTO PROGRAM</b> after changing your <b>CABLE</b> settings.
<b>CHANNEL FIX</b> <i>Useful when you have a cable box or satellite receiver connected</i>	<b>2-6:</b> Select when you want to control all channel selection through a cable box. Select the appropriate channel number (usually 3 or 4) and use the cable box's remote control for selection. <b>AUX 2-6:</b> Select when a cable box is connected to the AUX input, (see page 4). Press the <b>ANT</b> button to alternate between inputs. (KV-32S66, 35S66 only) <b>VIDEO 1:</b> Select from available video inputs when you have video equipment connected (e.g. satellite receiver) and you want your TV fixed to it.
<b>AUTO PROGRAM</b>	Instructs the TV to program all receivable channels.
<b>CHANNEL SKIP/ADD</b>	With the <b>CHANNEL SKIP/ADD</b> window open: <ol style="list-style-type: none"> <li>1 Select the desired channel.</li> <li>2 Press (+) to SKIP or ADD (only one option will be available).</li> </ol> <div data-bbox="1738 662 2039 899" style="border: 1px solid black; padding: 5px;"> <p>CHANNEL SKIP/ADD 33</p> <p>SKIP</p> <p>▶ ADD</p> <p>▷ MENU</p> <p>Use [0-9] or [CH +/-] to select the channel</p> <p>Move (left arrow) Select (+) Exit (MENU)</p> </div>
<b>CHANNEL CAPTION</b> <i>Label up to 12 channels with their call letters</i>	With the <b>CHANNEL CAPTION</b> menu open: <ol style="list-style-type: none"> <li>1 Press (+) and then ↑ or ↓ to access the desired channel, and press (+) again.</li> <li>2 Press ↑ or ↓ to display the first letter or number of the caption and press (+) to select it.</li> <li>3 Press (+) to activate.</li> </ol> <div data-bbox="1738 909 2039 1146" style="border: 1px solid black; padding: 5px;"> <p>CHANNEL CAPTION</p> <p>▶ CHANNEL CAPTION 33</p> <p>-----</p> <p>▷ MENU</p> <p>Move (left arrow) Select (+) Exit (MENU)</p> </div>

## The Parental Guideline Rating System

This table provides a brief overview of the rating systems available for the PARENTAL CONTROL feature.

For detailed information on how to change your TV rating, see pages 26-27.

### Notes

- The content ratings will increase depending on the level of the age-based rating. For example, a program with a TV-PG V (Violence) rating may contain moderate violence, while a TV-14 V (Violence) rating may contain more intense violence.
- If you choose to block unrated TV programs, please be aware that the following programs may be blocked: emergency broadcasts, political programs, sports, news, public service announcements, religious programs and weather.

Overview of the U.S. Ratings		
<p><b>TV RATINGS</b> <i>Block programs by their rating, content or both</i></p>	<p><b>Age based options:</b>  <b>TV-Y:</b> All children.  <b>TV-Y7:</b> Directed to older children.  <b>TV-G:</b> General Audience.  <b>TV-PG:</b> Parental Guidance suggested.  <b>TV-14:</b> Parents Strongly cautioned.  <b>TV-MA:</b> Mature Audience only.</p> <p><b>Content based options:</b>  <b>FV:</b> Fantasy Violence.  <b>D:</b> Suggestive Dialogue.  <b>L:</b> Strong Language.  <b>S:</b> Sexual situations.  <b>V:</b> Violence.</p>	<p><b>TV RATINGS</b>  ▶TV-Y: -      FV: -  TV-Y7: -      TV-G: -  TV-PG: -      D_L_S_V-  TV-14: -      D_L_S_V-  TV-MA: -      L_S_V-  ▷MENU  Select category  Move [Left] Select [Right] Exit [Menu]</p>
<p><b>MOVIE RATINGS</b></p>	<p>(U.S. models only)  <b>G:</b> All children and General Audience.  <b>PG:</b> Parental Guidance suggested.  <b>PG-13:</b> Parental Guidance for children under 13.  <b>R:</b> Restricted viewing, Parental Guidance is suggested for children under 17.  <b>NC-17:</b> No one 17 and under allowed.  <b>X:</b> No one 17 and under allowed.</p>	<p><b>MOVIE RATINGS</b>  ▶G: -  PG: -  PG-13: -  R: -  NC-17: -  X: -  ▷MENU  Select rating  Move [Left] Select [Right] Exit [Menu]</p>
<p><b>UNRATED</b> <i>Block programs or movies that are broadcast without a rating</i></p>	<p>(U.S. models only)  <b>VIEW ALL:</b> Allows all unrated programming.  <b>BLOCK TV:</b> Blocks all unrated TV programs.  <b>BLOCK MOVIES:</b> Blocks all unrated movies.  <b>BLOCK ALL:</b> Blocks all unrated programming.</p>	<p><b>CUSTOM RATINGS</b>  TV RATINGS  MOVIE RATINGS  ▶UNRATED: VIEW ALL  ▷MENU  Select category  Move [Left] Select [Right] Exit [Menu]</p>

## Overview of the Canadian Ratings

<p><b>ENGLISH RATINGS</b> For Canadian programs that are broadcast in English</p>	<p>(Canadian models only)  <b>C:</b> All children.  <b>C8+:</b> Children 8 years and older.  <b>G:</b> General programming.  <b>PG:</b> Parental Guidance.  <b>14+:</b> Viewers 14 and older.  <b>18+:</b> Adult programming.</p>	<p>ENGLISH RATINGS          ▶C: -          C8+: -          G: -          PG: -          14+: -          18+: -          ▷MENU          Select rating          Move [Left] [Right] Select [Enter] Exit [MENU]</p>
<p><b>FRENCH RATINGS</b> For Canadian programs that are broadcast in French</p>	<p>(Canadian models only)  <b>G:</b> General programming.  <b>8 ans+:</b> Not recommended for young children.  <b>13 ans+:</b> Not recommended for ages under 13.  <b>16 ans+:</b> Not recommended for ages under 16  <b>18 ans+:</b> Programming restricted to adults.</p>	<p>FRENCH RATINGS          ▶G: -          8 ans+: -          13 ans+: -          16 ans+: -          18 ans+: -          ▷MENU          Select rating          Move [Left] [Right] Select [Enter] Exit [MENU]</p>
<p><b>U.S.A. RATINGS</b> For programs from the United States</p>	<p>(Canadian models only)          Please see TV RATINGS on page 24 for information on U.S.A. RATINGS.</p>	

## Using the PARENTAL CONTROL menu

This section shows you how to access the PARENTAL CONTROL menu. After you follow the example below, the next section shows you how to adjust your TV's rating.

- 1 Press **MENU** and select the **SET UP** menu.

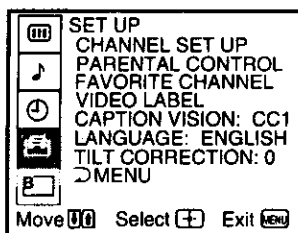

- 2 Point the cursor to **PARENTAL CONTROL** and press **+**.

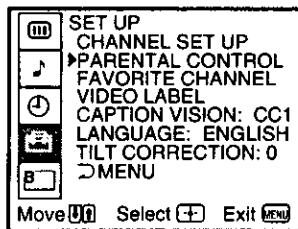
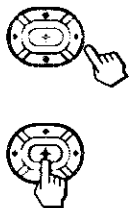

You will be asked to enter a 4-digit password for any future access into the PARENTAL CONTROL menu.

- 3 Press **+** and use the **0-9** buttons to enter your 4-digit password.

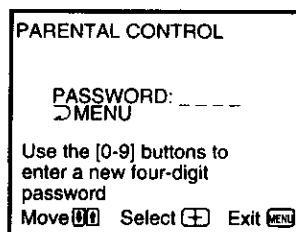
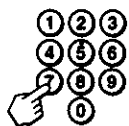

- 4 Confirm your password by entering it again.

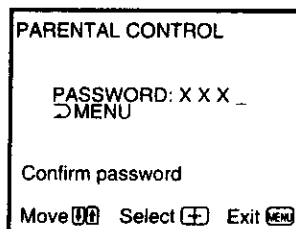
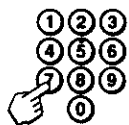

Once your password is set correctly, you will be taken into the PARENTAL CONTROL menu.

In order to change the RATING you will need to set PARENTAL LOCK to ON.

- 5 Point the cursor at **PARENTAL LOCK** and press **+**. Press **↑** or **↓** to **ON** and press **+**.

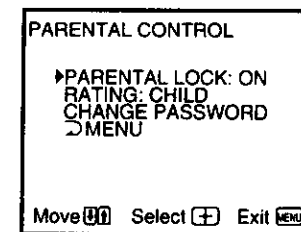

See pages 24-25 for an overview of the Parental Guideline ratings.

### Tip

Keep this instruction manual in a safe place. In the event that you forget your password, please see page 32.



## Setting the TV's RATING

This section provides information on how to set the TV's RATING and how to change your password.

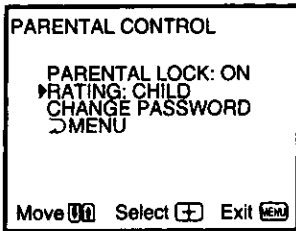

### Notes

- Entering your password to view a blocked program will temporarily turn PARENTAL LOCK to OFF.
- To reactivate your PARENTAL CONTROL settings, turn the TV off then back on; the TV will restore your rating settings.

<b>PARENTAL LOCK</b> <i>Turns ratings on/off</i>	<b>ON:</b> Select to activate the RATING. <b>OFF:</b> Turns off current ratings.
<b>RATING</b>	<p>If you are not familiar with the Parental Guideline rating system, you should use one of the following preselected categories to help simplify the rating selection. <b>The following maximum ratings will be allowed:</b></p> <p><b>CHILD:</b> TV-Y, TV-G, G (U.S. models only), TV-Y, TV-G, G, C (Canadian models only).  <b>YOUTH:</b> TV-PG, PG (U.S. models only), TV-PG, PG, 8 ans+ (Canadian models only).  <b>YOUNG ADULT:</b> TV-14, PG-13 (U.S. models only), TV-14, 14+, 13 ans+ (Canadian models only).</p> <p><b>CUSTOM:</b> If you prefer to set more restrictive ratings, highlight CUSTOM and press (+). See pages 25-26, for an overview of the rating systems available.</p> <p><b>In the CUSTOM RATINGS menu:</b></p> <ol style="list-style-type: none"> <li>1 Select the desired rating category and press (+).</li> <li>2 Press ↑ or ↓ to select the maximum rating or content and press (+).</li> <li>3 Press ↑ or ↓ to block or unblock the rating or content and press (+).</li> </ol> <p><i>Once you have blocked a rating or content, all higher ratings or contents will be automatically blocked.</i></p> <p><b>To view a blocked program:</b>          Press ENTER on the remote control, then use the 0-9 buttons to enter your password.</p>
<b>CHANGE PASSWORD</b>	<p><b>To reset your password:</b></p> <ol style="list-style-type: none"> <li>1 Move the cursor to CHANGE PASSWORD press (+).</li> <li>2 Use the 0-9 buttons to create a new password, enter again to confirm.</li> </ol> <p><i>In the event that you forget your password, see page 32.</i></p>

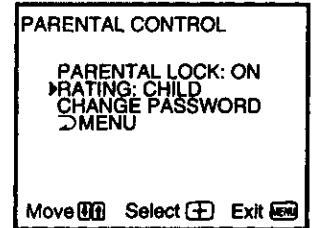

## Programming the remote

You can use the supplied remote control to operate Sony or non-Sony video equipment.

- 1 Press **CODE SET**.
- 2 Press **VTR/DVD (FUNCTION)**.
- 3 Use the **0-9** buttons to key in the manufacturer's code number from the following chart.
- 4 Press **ENTER**.

## VCR code numbers

Manufacturer	Code
Sony	301, 302, 303
Admiral (M. Ward)	327
Aiwa	338, 344
Audio Dynamic	314, 337
Broksonic	319, 317
Canon	309, 308
Citizen	332
Craig	302, 332
Criterion	315
Curtis Mathes	304, 338, 309
Daewoo	341, 312, 309
DBX	314, 336, 337
Dimensia	304
Emerson	319, 320, 316, 317, 318, 341
Fisher	330, 335
Funai	338
General Electric	329, 304, 309
Go Video	322, 339, 340
Goldstar	332

Hitachi	306, 304, 305, 338
Instant Replay	309, 308
JC Penney	309, 305, 304, 330, 314, 336, 337
JVC	314, 336, 337, 345, 346, 347
Kenwood	314, 336, 332, 337
LXI (Sears)	332, 305, 330, 335, 338
Magnavox	308, 309, 310
Marantz	314, 336, 337
Marta	332
Memorex	309, 335
Minolta	305, 304
Mitsubishi/MGA	323, 324, 325, 326
Multitech	325, 338, 321
NEC	314, 336, 337
Olympic	309, 308
Optimus	327
Panasonic	308, 309, 306, 307
Pentax	305, 304
Philco	308, 309
Philips	308, 309, 310
Pioneer	308
Quasar	308, 309, 306
RCA/PROSCAN	304, 305, 308, 309, 311, 312, 313, 310, 329
Realistic	309, 330, 328, 335, 324, 338
Sansui	314
Samsung	322, 313, 321
Sanyo	330, 335
Scott	312, 313, 321, 335, 323, 324, 325, 326
Sharp	327, 328
Shintom	315
Signature 2000 (M. Ward)	338, 327
SV2000	338
Sylvania	308, 309, 338, 310
Symphonic	338
Tashiro	332
Tatung	314, 336, 337

Teac	314, 336, 338, 337
Technics	309, 308
Toshiba	312, 311
Wards	327, 328, 335, 331, 332
Yamaha	314, 330, 336, 337
Zenith	331

Operating a VCR	Buttons on the remote control
To turn on or off	Press <b>VTR/DVD (POWER)</b> .
To select a channel directly	Press the <b>0-9</b> buttons.
To change channels	Press <b>CH +/-</b> .
To record	Press <b>▶</b> and <b>●</b> simultaneously.
To play	Press <b>▶</b> .
To stop	Press <b>■</b> .
To fast forward	Press <b>▶▶</b> .
To rewind the tape	Press <b>◀◀</b> .
To pause	Press <b>  </b> . To resume normal playback, press again or press <b>▶</b> .
To scan	Press <b>▶▶</b> or <b>◀◀</b> during playback. To resume normal playback, release the button.
To change input mode	Press <b>TV/VTR</b> .

## Tips

- In some rare cases, you may not be able to operate your non-Sony video equipment with the supplied remote control. In this case, please use the equipment's own remote control.
- When you remove the batteries, the code number may revert to the factory setting.
- The code numbers for Sony VCRs are assigned at the factory as follows:

VHS VCR	301
	(preset code for the supplied remote control)
8 mm VCR	302
Beta, ED Beta VCRs	303

## Laserdisc code numbers

Manufacturer	Code
Sony	701
Panasonic	704, 710
Pioneer	702

Operating a Laserdisc	Buttons on the remote control
To turn on or off	Press VTR/DVD (POWER).
To play	Press ►.
To stop	Press ■.
To pause	Press ■■. To resume normal playback, press again or press ►.
To scan	Press ►► or ◀◀ during playback. To resume normal playback, press ►.
To search the chapter forward or backward	Press CH +/-.

## Tip

If you will not be programming a satellite receiver or cable box into the SAT/CABLE function of your remote, you can use it to program other video equipment (e.g. DVD, MDP, or second VCR).

## DVD (Digital Versatile Disc) code numbers

Manufacturer	Code
Sony	751
Panasonic	753
Pioneer	752
RCA	755
Toshiba	754

Operating a DVD player	Buttons on the remote control
To turn on or off	Press VTR/DVD (POWER).
To play	Press ►.
To stop	Press ■.
To pause	Press ■■. To resume normal playback, press again or press ►.
To scan	Press ►► or ◀◀ during playback. To resume normal playback, press ►.
To search the chapter forward or backward	Press CH +/-.
To select chapters directly	0-9 + ENTER.
MENU	Press to display DVD menu.
To move cursor in menu	Use your arrow buttons ↑, ↓, ←, →.

# Operating a Cable Box or Satellite Receiver

## Programming the remote control

You can program the supplied remote control to operate a cable box or satellite receiver.

- 1 Press **CODE SET**.
- 2 Press **SAT/CABLE (FUNCTION)**.
- 3 Use the **0-9** buttons to key in the manufacturer's code number from the following chart.
- 4 Press **ENTER**.

## For more details on operating the cable box or satellite receiver

Refer to the operating instructions that were supplied with the equipment.

## If the remote control doesn't work

First, try repeating the setup procedures using the other codes listed for your equipment.

### Tips

- *If more than one code number is listed, try entering them one by one until you come to the correct code for your equipment.*
- *If you enter a new code number, the code number you previously entered at that setting is erased.*
- *In some rare cases, you may not be able to operate your equipment with the supplied remote control. In this case, use the equipment's supplied remote control.*
- *Whenever you remove the batteries, the code numbers may revert to the factory setting.*

## Cable box code numbers

<b>Manufacturer</b>	<b>Code</b>
Hamlin/Regal	222, 223, 224, 225, 226
Jerrold/G. I.	201, 202, 203, 204, 205, 206, 207, 208, 218
Oak	227, 228, 229
Panasonic	219, 220, 221
Pioneer	214, 215
Scientific Atlanta	209, 210, 211
Tocom	216, 217
Zenith	212, 213

## Satellite receiver code numbers

<b>Manufacturer</b>	<b>Code</b>
Sony	801 (preset code for remote control)
General Electric	802
Hitachi	805
Hughes	804
Panasonic	803
RCA/PROSCAN	802, 808
Toshiba	806, 807

## Troubleshooting

Consult the table below; it suggests solutions to specific problems.

Problem	What it could be	What you can do
You want to restore the TV's factory settings		<ul style="list-style-type: none"> <li>• First, turn the TV on. Then while pressing the <b>RESET</b> button on the remote control, press the <b>POWER</b> button on the TV. The TV will turn itself off and then back on. When the TV turns on again, all settings will be reset, and the initial setup screen will appear.</li> </ul>
A red light keeps flashing on the TV for more than a few seconds	<ul style="list-style-type: none"> <li>• Your TV may need service.</li> </ul>	<ul style="list-style-type: none"> <li>• Call your local Sony service center.</li> </ul>
TV makes a noise when turned on	<ul style="list-style-type: none"> <li>• This is a normal function of your TV.</li> </ul>	
Screen is not lit and there is no sound	<ul style="list-style-type: none"> <li>• Power cord may not be plugged in.</li> <li>• Remote control batteries may not be inserted correctly.</li> <li>• TV/VIDEO setting may be incorrect.</li> <li>• Current program may exceed PARENTAL CONTROL settings.</li> </ul>	<ul style="list-style-type: none"> <li>• Check your power cord.</li> <li>• Re-insert the batteries in your remote control.</li> <li>• Press <b>TV/VIDEO</b> until you receive a channel.</li> <li>• Check your PARENTAL CONTROL settings, (page 27).</li> </ul>
Poor or no picture (screen lit), good sound	<ul style="list-style-type: none"> <li>• VIDEO menu settings may not be adjusted correctly.</li> <li>• Antenna/cable connections may be faulty.</li> <li>• VIDEO LABEL inputs may be set to WEB. (This label darkens the screen for ideal WebTV viewing)</li> </ul>	<ul style="list-style-type: none"> <li>• Readjust your VIDEO menu settings, (page 18).</li> <li>• Check your VIDEO LABEL settings, (page 21).</li> </ul>
Good picture, no sound	<ul style="list-style-type: none"> <li>• Sound may be set to MUTE.</li> <li>• Your TV may be set to SAP.</li> <li>• SPEAKER may not be set correctly.</li> </ul>	<ul style="list-style-type: none"> <li>• Press <b>MUTE</b>.</li> <li>• Check the MTS setting in the AUDIO menu, (page 19).</li> <li>• Check your SPEAKER settings, (page 19).</li> </ul>
No color	<ul style="list-style-type: none"> <li>• Color settings may not be adjusted correctly.</li> </ul>	<ul style="list-style-type: none"> <li>• Adjust the COLOR settings in the VIDEO menu, (page 18).</li> </ul>
Only snow and noise appear on the screen	<ul style="list-style-type: none"> <li>• CABLE may not be set correctly in the CHANNEL SET UP menu.</li> <li>• Antenna/cable connections may not be correct.</li> <li>• TV may be set to AUX mode.</li> </ul>	<ul style="list-style-type: none"> <li>• Ensure that you have selected the correct CABLE mode in the CHANNEL SET UP menu, (page 23).</li> <li>• Press <b>ANT</b> on your remote control to change the input mode, (page 14).</li> </ul>

Problem	What it could be	What you can do
Cannot receive upper channels (UHF) when using an antenna	<ul style="list-style-type: none"> <li>CABLE setting may not be correct in the CHANNEL SET UP menu.</li> </ul>	<ul style="list-style-type: none"> <li>Ensure that CABLE is set to OFF in the CHANNEL SET UP menu, (page 23).</li> <li>Use AUTO PROGRAM to add receivable channels that are not presently in TV memory, (page 23).</li> </ul>
Cannot receive any channels when using cable	<ul style="list-style-type: none"> <li>CABLE setting may not be correct in the CHANNEL SET UP menu.</li> </ul>	<ul style="list-style-type: none"> <li>Ensure that CABLE is set to ON in the CHANNEL SET UP menu, (page 23).</li> <li>Use AUTO PROGRAM to add receivable channels that are not presently in TV memory, (page 23).</li> </ul>
Cannot gain enough volume when using a cable box	<ul style="list-style-type: none"> <li>Volume may not be adjusted on your cable box.</li> </ul>	<ul style="list-style-type: none"> <li>Use the remote control supplied with the cable box.</li> </ul>
TV is fixed to one channel	<ul style="list-style-type: none"> <li>CHANNEL FIX settings may not be correct.</li> </ul>	<ul style="list-style-type: none"> <li>Check your CHANNEL FIX settings, (page 23).</li> </ul>
Lost password for PARENTAL CONTROL		<ul style="list-style-type: none"> <li>In the password screen, enter the following master password: 4357. The master password cannot be used to unlock currently blocked channels.</li> </ul>

If, after reading these operating instructions, you have additional questions related to the use of your Sony television, please call our Direct Response Center at 1-800-222-SONY (7669)(U.S. residents only) or (416) 499-SONY (7669)(Canadian residents only).

### Supplied accessories

Remote control RM-Y168 (KV-32S42, 32V42, 35S42, 35V42 only), (1)  
 RM-Y169 (KV-32S66, 35S66 only)(1)

Batteries size AA (R6) (2)

### Optional accessories

Connecting cables

A/V Cable	VMC-810/820/830HG
Audio Cable	RKC-515HG
S-Link Cable	RK-G69HG
S Video Cable	YC-15/30HG

TV Stand

SU-32A4, SU-35A4

	KV - 32S42	KV - 32S66	KV - 32V42	KV - 35S42	KV - 35S66	KV - 35V42
<b>Power requirements</b>	120 V, 60 Hz	120 V, 60 Hz	120 V, 60 Hz	120 V, 60 Hz	120 V, 60 Hz	120 V, 60 Hz
<b>Number of inputs/outputs</b>						
<b>Video <sup>1)</sup></b>	1	2	3	2	2	3
<b>S VIDEO <sup>2)</sup></b>	1	1	1	1	1	1
<b>Audio <sup>3)</sup></b>	1	2	3	2	2	3
<b>Audio out <sup>4)</sup></b>	1	1	1	1	1	1
<b>Monitor out <sup>1)</sup></b>	—	—	1	—	—	1
<b>S-Link</b>	—	3	—	—	3	—
<b>Speaker output (W)</b>	5W x 2	5W x 2	5W x 2	5W x 2	5W x 2	5W x 2
<b>Power consumption (W)</b>						
<b>In use (Max.)</b>	180 W	180 W	180 W	210 W	210 W	210 W
<b>In standby</b>	2 W	2 W	2 W	2 W	2 W	2 W
<b>Dimensions (W/H/D)</b>						
<b>(mm)</b>	791 x 707 x 604.5 mm	791 x 707 x 604.5 mm	821 x 675.3 x 587 mm	870 x 761 x 653 mm	870 x 761 x 653 mm	920 x 730.8 x 641.8 mm
<b>(in.)</b>	31 x 27 13/16 x 23 3/4 in	31 x 27 13/16 x 23 3/4 in	32 3/8 x 26 5/8 x 23 1/8 in	34 1/4 x 30 x 25 5/8 in	34 1/4 x 30 x 25 5/8 in	36 3/4 x 28 3/4 x 25 1/4 in
<b>Mass (kg)</b>	65 kg	65 kg	70 kg	83 kg	83 kg	90 kg
<b>(lb)</b>	143 lbs	143 lbs	154 lbs	183 lbs	183 lbs	203 lbs

**Notes**

- <sup>1)</sup> 1 Vp-p, 75 ohms unbalanced, sync negative
- <sup>2)</sup> Y: 1 Vp-p, 75 ohms unbalanced, sync negative  
C: 0.286 Vp-p (Burst signal), 75 ohms
- <sup>3)</sup> 500 mVrms Impedance: 47 kilohms
- <sup>4)</sup> More than 408 mVrms at the maximum volume setting (variable)  
More than 408 mVrms (fix)  
Impedance (Output): 2 kilohms

**Television system**

American TV standard, NTSC

**Channel coverage**

VHF: 2-13/UHF: 14-69/CATV: 1-125

**Picture tube**

Trinitron® tube

**Visible screen size**

32-inch picture measured diagonally (KV-32S42, 32S66, 32V42 only)

35-inch picture measured diagonally (KV-35S42, 35S66, 35V42 only)

**Actual screen size**

34-inch picture measured diagonally (KV-32S42, 32S66, 32V42 only)

37-inch picture measured diagonally (KV-35S42, 35S66, 35V42 only)

**Antenna**

75 ohm external terminal for VHF/UHF

**(●)® SRS (SOUND RETRIEVAL SYSTEM)**



The (●) SRS (SOUND RETRIEVAL SYSTEM) is manufactured by Sony Corporation under license from SRS Labs, Inc. It is covered by U.S. Patent No. 4,748,669. Other U.S. and foreign patents pending.

The word 'SRS' and the SRS symbol (●) are registered trademarks of SRS Labs, Inc.

Licensed by BBE Sound, Inc. under USP 4638258.4482866. BBE and BBE symbol are trademarks of BBE Sound, Inc.

*Design and specifications are subject to change without notice.*

**A**

Adjusting your menus .....	16
ANT .....	14
Antenna cable .....	3
Antenna connector .....	3
AUDIO  button .....	14, 15, 19
AUDIO menu operations 	
AUDIO OUT .....	19
BALANCE .....	19
BASS .....	19
EFFECT .....	19
MTS .....	19
SPEAKER .....	19
TREBLE .....	19
AUDIO OUT	
FIXED .....	19
VARIABLE .....	19
AUTO PROGRAM .....	23
AUTO VOLUME CONTROL .....	19
AUX Hookup .....	3, 4

**B**

BALANCE .....	19
BASIC menu operations 	17
BASS .....	19
Battery installation .....	11
BRIGHTNESS .....	18

**C**

CABLE .....	23
Cable box .....	4
operation .....	30
CAPTION VISION (closed caption) .....	22
CH +/- .....	15
CHANNEL CAPTION .....	23
CHANNEL FIX .....	23

CHANNEL SET UP MENU .....	23
AUTO PROGRAM .....	23
CABLE .....	23
CHANNEL CAPTION .....	23
CHANNEL FIX .....	23
CHANNEL SKIP/ADD .....	23
COLOR .....	18

**Connecting TV to**

Antenna .....	3
Audio system .....	9
Cable .....	3
Cable box and cable .....	4
Camcorder .....	9
CONTROL S .....	10
DVD player .....	8
Satellite receiver .....	7
Satellite receiver and VCR .....	7
Two VCRs .....	6
VCR .....	5

CURRENT TIME SET .....	20
------------------------	----

**D**

DAYLIGHT SAVING .....	20
DEMO .....	12
DISPLAY button	
CAPTION VISION .....	22
XDS .....	22
DVD operation .....	29

**E**

Editing using MONITOR OUT .....	6
EFFECT	
OFF .....	19
SIMULATED .....	19
SRS .....	19
SURROUND .....	19

**F**

FAVORITE CHANNEL .....	21
FAVORITE CHANNEL w/preview .....	21
FREEZE button .....	15

**H**

HUE .....	18
-----------	----

**I, J, K**

JUMP button .....	13
-------------------	----

**L**

LANGUAGE .....	22
Language selection .....	12, 22
Laserdisc .....	29

**M**

Menu selection .....	16
MODE	

MOVIE .....	18
STANDARD .....	18
VIVID .....	18

MONITOR OUT .....	6
-------------------	---

**MTS**

MONO .....	19
SAP .....	19
STEREO .....	19

MUTING button .....	13
---------------------	----

**O**

ON/OFF TIMER .....	20
Operating video equipment .....	28





**P, Q**

PARENTAL CONTROL	
PARENTAL LOCK .....	27
RATING .....	27
CHANGE PASSWORD .....	27
Picture-in-Picture (PIP)	
Main picture .....	15
Window picture .....	15
PICTURE MODE, button .....	13
PIP connections .....	15
PIP operations	
AUDIO .....	15
CH+/- .....	15
FREEZE .....	15
PIP .....	15
POSITION .....	15
SWAP .....	15
TV/VIDEO .....	15
Programming the remote .....	28, 30

**R**

RATINGS	
ENGLISH .....	25
FRENCH .....	25
MOVIE .....	24
TV .....	24
U.S.A. ....	25
UNRATED .....	24
Remote control .....	11, 13
FUNCTION buttons .....	13
Illustration .....	inside front cover

**S**

SAP .....	19
Safety .....	1
Select buttons .....	11
Adjustment bars .....	11
SET UP menu  .....	21
CAPTION VISION .....	22
CHANNEL SETUP .....	21
FAVORITE CHANNEL .....	21
LANGUAGE .....	22
PARENTAL CONTROL .....	21
TILT CORRECTION .....	22
VIDEO LABEL .....	21
Setting up TV .....	12
SHARPNESS .....	18
SLEEP button .....	13
SPEAKER	
ON .....	19
OFF .....	19
Specifications .....	32, 33
SWAP button .....	15
SYSTEM OFF button .....	14
<b>T, U</b>	
TILT CORRECTION .....	22
TIMER menu operations 	
CURRENT TIME SET .....	20
DAYLIGHT SAVING .....	20
ON/OFF TIMER .....	20
TREBLE .....	19
Troubleshooting .....	31, 32
TV (FUNCTION) button .....	13
TV POWER button .....	13
TV/VIDEO button .....	14
TV OUT .....	9

**V, W, X**

VCR .....	5
VCR codes .....	28
VCR operation .....	28
VIDEO LABEL .....	21
VIDEO menu operations 	
BRIGHTNESS .....	18
COLOR .....	18
HUE .....	18
MODE .....	18
PICTURE .....	18
SHARPNESS .....	18
VOL +/- .....	12
VTR .....	28
XDS .....	22

