

machine numbers | IQB27B42W | IQB32B42W | IQB36B42W
| IQB32B84R | IQB32B86R | IQB36B86R

zenith



table of contents

page 5



how to use on-screen menus

page 6

page 18



glossary

page 52

**RECORD YOUR MODEL NUMBER
(Now, while you can see it)**

The model and serial number of your new TV are located on the back of the TV cabinet. For your future convenience, we suggest that you record these numbers here:

MODEL NO. _____

SERIAL NO. _____



WARNING:

TO REDUCE THE RISK OF ELECTRIC SHOCK DO NOT REMOVE COVER (OR BACK). NO USER SERVICEABLE PARTS INSIDE. REFER SERVICING TO QUALIFIED SERVICE PERSONNEL.



The lightning flash with arrowhead symbol, within an equilateral triangle, is intended to alert the user to the presence of uninsulated "dangerous voltage" within the product's enclosure that may be of sufficient magnitude to constitute a risk of electric shock to persons.



The exclamation point within an equilateral triangle is intended to alert the user to the presence of important operating and maintenance (servicing) instructions in the literature accompanying the appliance.

WARNING:

TO PREVENT FIRE OR SHOCK HAZARDS, DO NOT EXPOSE THIS PRODUCT TO RAIN OR MOISTURE.

POWER CORD POLARIZATION:

CAUTION: To prevent electric shock, match wide blade of plug to wide slot, fully insert.

ATTENTION: Pour éviter les chocs électriques, introduire la lame la plus large de la fiche dans la borne correspondante de la prise et pousser jusqu'au fond.

NOTE TO CABLE/TV INSTALLER:

This reminder is provided to call the cable TV system installer's attention to Article 820-40 of the National Electric Code (U.S.A.). The code provides guidelines for proper grounding and, in particular, specifies that the cable ground shall be connected to the grounding system of the building, as close to the point of the cable entry as practical.

REGULATORY INFORMATION:

This equipment has been tested and found to comply with the limits for a Class B digital device, pursuant to Part 15 of the FCC Rules. These limits are designed to provide reasonable protection against harmful interference when the equipment is operated in a residential installation. This equipment generates, uses and can radiate radio frequency energy and, if not installed and used in accordance with the instruction manual, may cause harmful interference to radio communications. However, there is no guarantee that interference will not occur in a particular installation. If this equipment does cause harmful interference to radio or television reception, which can be determined by turning the equipment off and on, the user is encouraged to try to correct the interference by one or more of the following measures:

- Reorient or relocate the receiving antenna.
- Increase the separation between the equipment and receiver.
- Connect the equipment into an outlet on a circuit different from that to which the receiver is connected.
- Consult the dealer or an experienced radio/TV technician for help.

CAUTION:

Do not attempt to modify this product in any way without written authorization from Zenith Electronics Corporation. Unauthorized modification could void the user's authority to operate this product.

IMPORTANT SAFETY INSTRUCTIONS

Important safeguards for you and your new product

Your product has been manufactured and tested with your safety in mind. However, improper use can result in potential electrical shock or fire hazards. To avoid defeating the safeguards that have been built into your new product, please read and observe the following safety points when installing and using your new product, and save them for future reference.

Observing the simple precautions discussed in this operating guide can help you get many years of enjoyment and safe operation that are built into your new product.

This product complies with all applicable U.S. Federal safety requirements, and those of the Canadian Standards Association.

1. Read Instructions

All the safety and operating instructions should be read before the product is operated.

2. Follow Instructions

All operating and use instructions should be followed.

3. Retain Instructions

The safety and operating instructions should be retained for future reference.

4. Heed Warnings

All warnings on the product and in the operating instructions should be adhered to.

5. Cleaning

Unplug this product from the wall outlet before cleaning. Do not use liquid cleaners or aerosol cleaners. Use a damp cloth for cleaning.

6. Water and Moisture

Do not use this product near water for example, near a bath tub, wash bowl, kitchen sink, or laundry tub, in a wet basement, or near a swimming pool.

7. Accessories

Do not place this product on an unstable cart, stand, tripod, bracket, or table. The product may fall, causing serious injury to a child or adult, and serious damage to the product. Use only with a cart, stand, tripod, bracket, or table recommended by the manufacturer, or sold with the product. Any mounting of the product should follow the manufacturer's instructions, and should use a mounting accessory recommended by the manufacturer.

8. Transporting Product

A product and cart combination should be moved with care. Quick stops, excessive force, and uneven surfaces may cause the product and cart combination to overturn.



PORTABLE CART WARNING

9. Attachments

Do not use attachments not recommended by the product manufacturer as they may cause hazards.

10. Ventilation

Slots and openings in the cabinet are provided for ventilation and to ensure reliable operation of the product and to protect it from overheating, and these openings must not be blocked or covered. The openings should never be blocked by placing the product on a bed, sofa, rug, or other similar surface. This product should not be placed in a built-in installation such as a bookcase or rack unless proper ventilation is provided or the manufacturer's instructions have been adhered to.

11. Power Sources

This product should be operated only from the type of power source indicated on the marking label. If you are not sure of the type of power supply to your home, consult your product dealer or local power company. For products intended to operate from battery power, or other sources, refer to the operating instructions.

12. Line-Cord Polarization

This product is equipped with a polarized alternating-current line plug (a plug having one blade wider than the other). This plug will fit into the power outlet only one way. This is a safety feature. If you are unable to insert the plug fully into the outlet, try reversing the plug. If the plug should still fail to fit, contact your electrician to replace your obsolete outlet. Do not defeat the safety purpose of the polarized plug.

13. Power-Cord Protection

Power-supply cords should be routed so that they are not likely to be walked on or pinched by items placed upon or against them, paying particular attention to cords at plugs, convenience receptacles, and the point where they exit from the product.

(Continued on next page)

IMPORTANT SAFETY INSTRUCTIONS

(Continued from previous page)

14. Outdoor Antenna Grounding

If an outside antenna or cable system is connected to the product, be sure the antenna or cable system is grounded so as to provide some protection against voltage surges and built-up static charges. Article 810 of the National Electrical Code (U.S.A.), ANSI/ NFPA 70 provides information with regard to proper grounding of the mast and supporting structure, grounding of the lead-in wire to an antenna discharge unit, size of grounding conductors, location of antenna-discharge unit, connection to grounding electrodes, and requirements for the grounding electrode.

Example of Grounding According to National Electrical Code Instructions

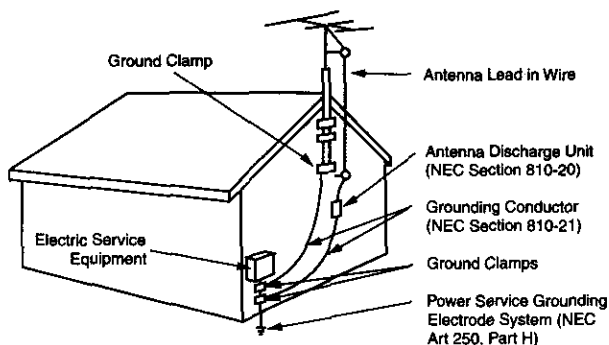

NEC - National Electrical Code

15. Lightning

For added protection for this product (receiver) during a lightning storm, or when it is left unattended and unused for long periods of time, unplug it from the wall outlet and disconnect the antenna or cable system. This will prevent damage to the product due to lightning and power-line surges.

16. Power Lines

An outside antenna system should not be located in the vicinity of overhead power lines or other electric light or power circuits, or where it can fall into such power lines or circuits. When installing an outside antenna system, extreme care should be taken to keep from touching such power lines or circuits as contact with them might be fatal.

17. Overloading

Do not overload wall outlets and extension cords as this can result in a risk of fire or electric shock.

18. Object and Liquid Entry

Never push objects of any kind into this product through openings as they may touch dangerous voltage points or short-out parts that could result in a fire or electric shock. Never spill liquid of any kind on the product.

19. Servicing

Do not attempt to service this product yourself as opening or removing covers may expose you to dangerous voltage or other hazards. Refer all servicing to qualified service personnel.

20. Damage Requiring Service

Unplug this product from the wall outlet and refer servicing to qualified service personnel under the following conditions:

- If the power-supply cord or plug is damaged.
- If liquid has been spilled, or objects have fallen into the product.
- If the product has been exposed to rain or water.
- If the product does not operate normally by following the operating instructions. Adjust only those controls that are covered by the operating instructions as an improper adjustment of other controls may result in damage and will often require extensive work by a qualified technician to restore the product to its normal operation.
- If the product has been dropped or the cabinet has been damaged.
- If the product exhibits a distinct change in performance.

21. Replacement Parts

When replacement parts are required, be sure the service technician has used replacement parts specified by the manufacturer or have the same characteristics as the original part. Unauthorized substitutions may result in fire, electric shock, or other hazards.

22. Safety Check

Upon completion of any service or repairs to this product, ask the service technician to perform safety checks to determine that the product is in proper operating condition.

23. Wall or Ceiling Mounting

The product should be mounted to a wall or ceiling only as recommended by the manufacturer.

24. Heat

The product should be situated away from heat sources such as radiators, heat registers, stoves, or other products (including amplifiers) that produce heat.

Table Of Contents

Turn to the next page to setup your Entertainment Machine™

Safety Warnings	2	Captions, Caption/Text	22
Important Safety Instructions	3 - 4	Language	23
Table of Contents	5	Special Features Menu	
Step 1. Hook Up TV		EZ Timer Setup, Sleep Timer	24
Hookup Directory	6	On and Off Time, On/Off Timer	25
TV and other Equipment Hookups		Channel Labels	26
Antenna	7	XDS Display	27
Cable service	8	Parental Control	28 - 29
Antenna with VCR	9	EZ Demo (On-screen menus overview)	30
Cable service with VCR	10	Audio Menu	31
Super VHS VCR/Digital Video Disk Player	11	Bass, Treble, Balance, Audio Mode,	
Audio Equipment: Stereo	12	Front Surround, Sound Rite, Speakers	
Step 2. Channel Search and Reception Setup	Video Menu	32
EZ Program	13	Contrast, Brightness, Color, Tint, Sharpness, Color Temp,	
(Select Antenna, or cable service and perform channel		EZ Picture	
search)		PIP Menu	33
Remote Control TV Mode Key Functions	14	Color, Tint, Size	
Remote On-Screen Menu Operation	15	Source Menu	34
Front Panel Controls	16	Main Screen Picture, PIP Inset Picture	
Basic TV Operation, Tuners and Picture Sources	17	V-CHIP Plus+ Demo, Setup, Overview, and Operation	
On-Screen Menus/Displays Overview	18	Kid's TV, Block, Watch	35 - 36 - 37- 38 - 39
On-Screen Displays	19	PIP (Picture-in-Picture)	40 - 41 - 42
Step 3. Customize Your TV's Features		Overview, and Operation	
Setup Menu (Starts with page 13, EZ Program)		Remote Control Programming	43 - 49
Add/Del/Surf	20	Maintenance	50
Clock Set	21	Trouble Shooting	51 - 52
		Glossary	53
		EZ Help Menu	54
		Zenith Accessory Products	Inside Back Cover
		Warranty	Back Cover

Features on this TV also include:

- Parental Control - Restricts programs which can appear on your TV, see page 28.
- PIP - 2-Tuner Picture-in-Picture, see page 40.
- Programmable Remote Control - Remote may control up to 7 products, see page 43.
- V-CHIP Plus+ - Kid's TV, Block, and Watch options using the program's VCR+ PlusCodes, see page 35.
- XDS Display - Extended Data Service. Shows current program information, see page 27.

EZ Features: Designed to make your viewing experience less work; see the EZ Help menu on page 54.

- EZ Program** Finds channels in your area automatically.
- EZ Timer** Sets times to turn the TV on and off.
- EZ Picture** Customizes video level settings.
- EZ Demo** Shows menus and displays on this TV.
- EZ SoundRite** Maintains and even sound level.
- EZ Mute** Turns sound off, while picture remains.

Note: Design and specifications are subject to change without prior notice.

Hookup Directory

This page directs you to the appropriate page for hook up your Entertainment Machine

IMPORTANT!!

Use this page to decide where you need to begin your setup. First, find the line below that best describes what you want to do, then go to that page number.

Note: Design and specifications are subject to change without prior notification.

Antenna only If you are using an antenna and no other equipment, go to page 7

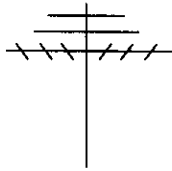

Cable only If you subscribe to cable service and no other equipment, go to page 8

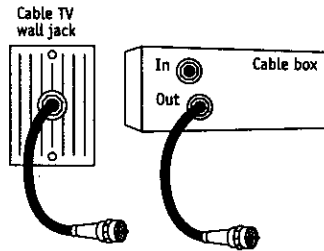

Antenna with VCR If you are using an antenna and have a VCR, go to page 9

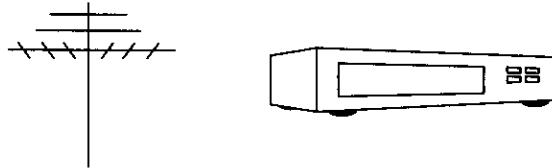

Cable and VCR If you subscribe to cable service and have a VCR, go to page 10

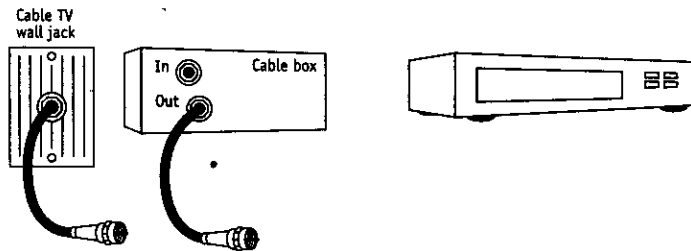

Other If you have a Super VHS VCR, a DVD Player, or Audio equipment, go to pages 11-12

Hook Up an Off Air Antenna

Connect an off air antenna to your Entertainment Machine

1 Hook up your Entertainment Machine, see diagrams at right.

2 Remove the back of the remote and put in two AAA batteries.

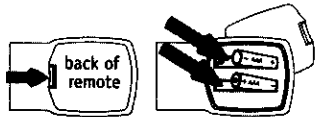

3 Plug in your TV. Do not plug it into a switched outlet.

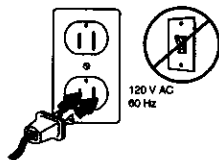

4 Go to page 13 to EZ Program your Entertainment Machine.

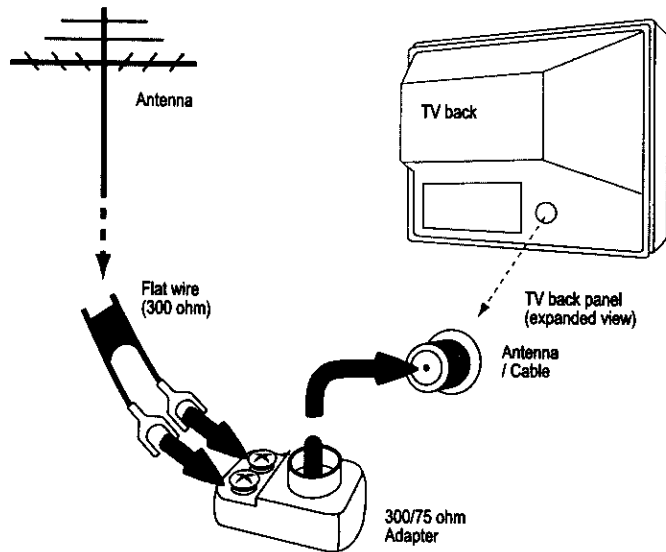

If you have a 75 ohm RF cable, then you don't need any adapters!



Remember, when screwing RF cables onto jacks, clockwise tightens, and counterclockwise loosens.



A 300 to 75 ohm adapter is not included with your Zenith Entertainment Machine.

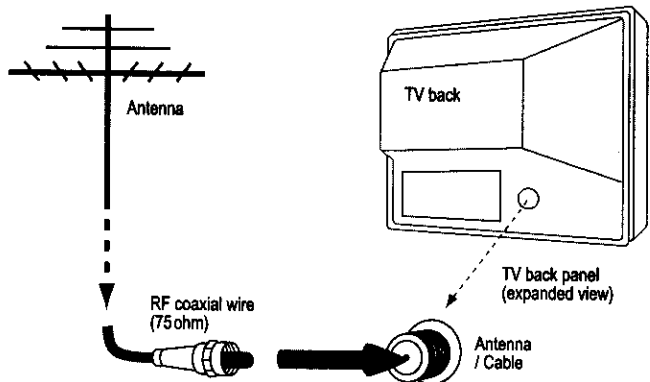

75 OHM RF CABLE

The wire that comes from an off air antenna or cable service provider. Each end looks like a hex shaped nut with a wire sticking through the middle, and it screws onto the threaded jack on the back of your TV.

300-75 OHM ADAPTER

A small device that connects a two-wire 300 ohm antenna to a 75 ohm RF jack. They are usually about an inch long with two screws on one end and a round opening with a wire sticking out on the other end.

Hook Up Cable Service (CATV)

Connect Cable service to your Entertainment Machine

1 Hook up your Entertainment Machine, see diagrams at right.

2 Remove the back of the remote and put in two AAA batteries.

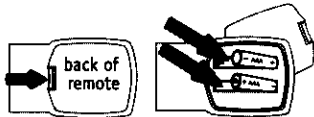

3 Plug in your TV. Do not plug it into a switched outlet.

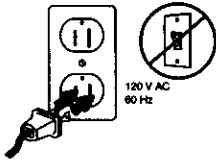

4 Go to page 13 to EZ Program your Entertainment Machine.



If you're using a cable box, leave your TV on channel 3 or 4 and use your cable box to change channels.



Remember to set the cable box output switch to channel 3 or 4.



If you're using a cable box, EZ Program (page 13) might only find the channel your cable service is on (usually channel 3 or 4). Don't worry, that's all you need!

Without Cable Box

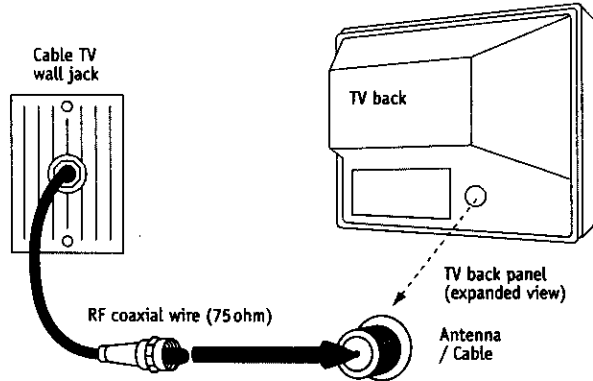

With Cable Box

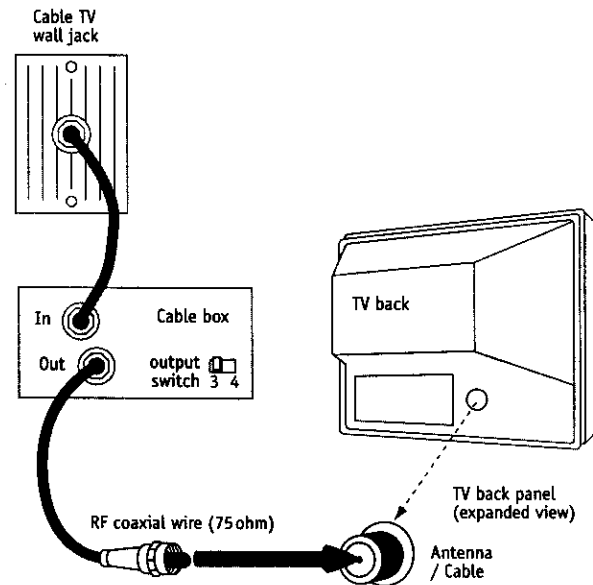

DEFINITIONS

CABLE SERVICE The wire that supplies all your cable TV (CATV) stations.

Hook Up Antenna and a VCR

Connect your off air antenna and VCR to your Entertainment Machine

1 Hook up your Entertainment Machine, see diagrams at right.

2 Remove the back of the remote and put in two AAA batteries.

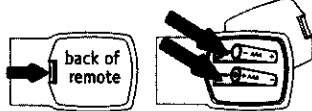

3 Plug in your TV. Do not plug it into a switched outlet.

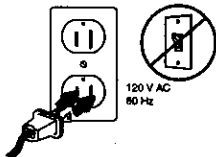

4 Go to page 13 to EZ Program your Entertainment Machine.



Remember to set the VCR output switch to channel 3 or 4.



Video sources provide better picture and sound.



Without A/V cable hookup, VCRs will not play videocassettes in stereo sound.

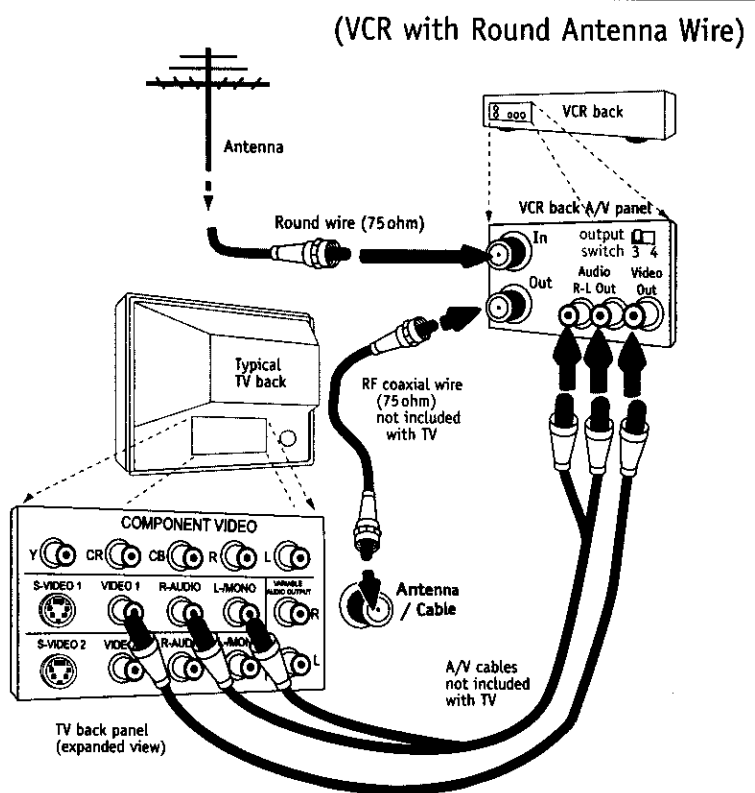
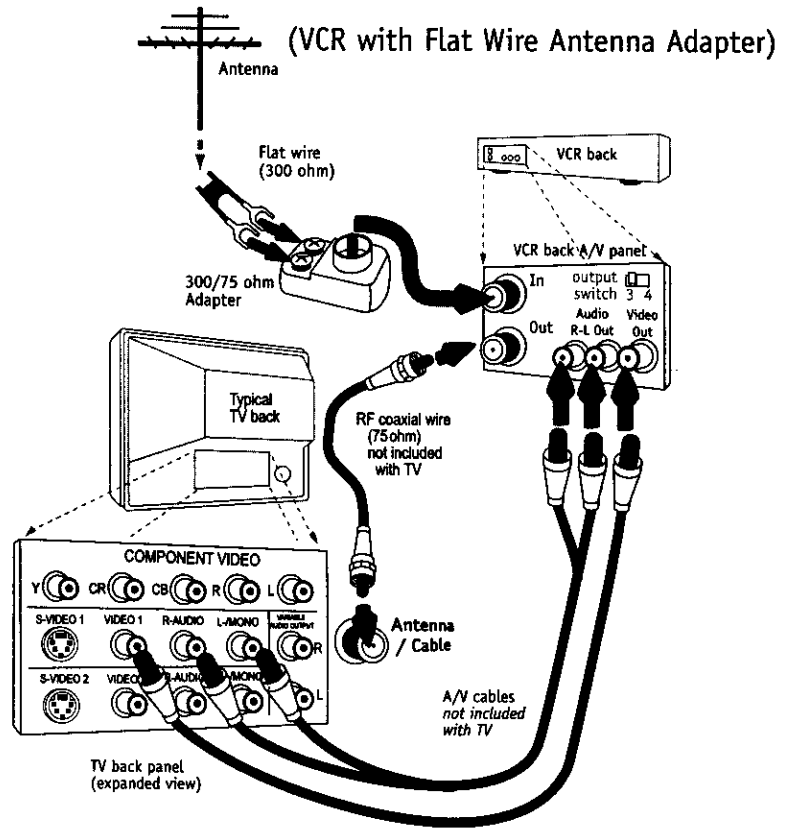

Hook Up Cable (CATV) and a VCR

Connect Cable service and a VCR to your Entertainment Machine

1 Hook up your Entertainment Machine, see diagrams at right.

2 Remove the back of the remote and put in two AAA batteries.

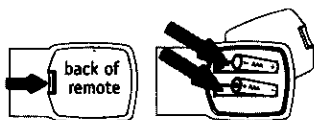

3 Plug in your TV. Do not plug it into a switched outlet.

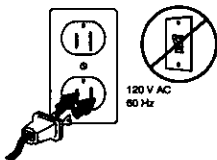

4 Go to page 13 to EZ Program your Entertainment Machine.



Leave your VCR and your television tuned to channel 3 or 4 and use the cable box to change channels.



Remember to set the cable box output switch to channel 3 or 4.



Video sources provide better picture and sound.



No A/V cables are included with your Zenith Entertainment Machine. Without A/V cable hookups, VCRs will not play video-cassettes in stereo sound.

Without Cable Box

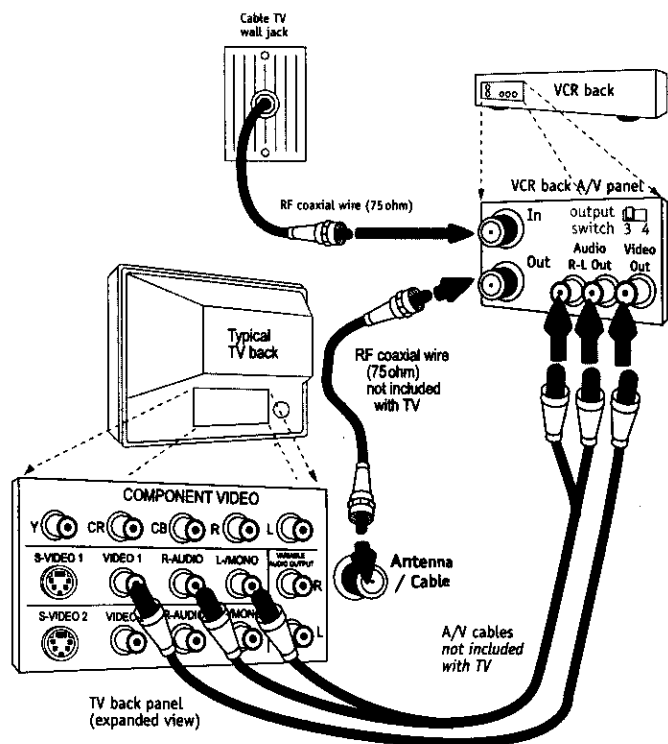

With Cable Box

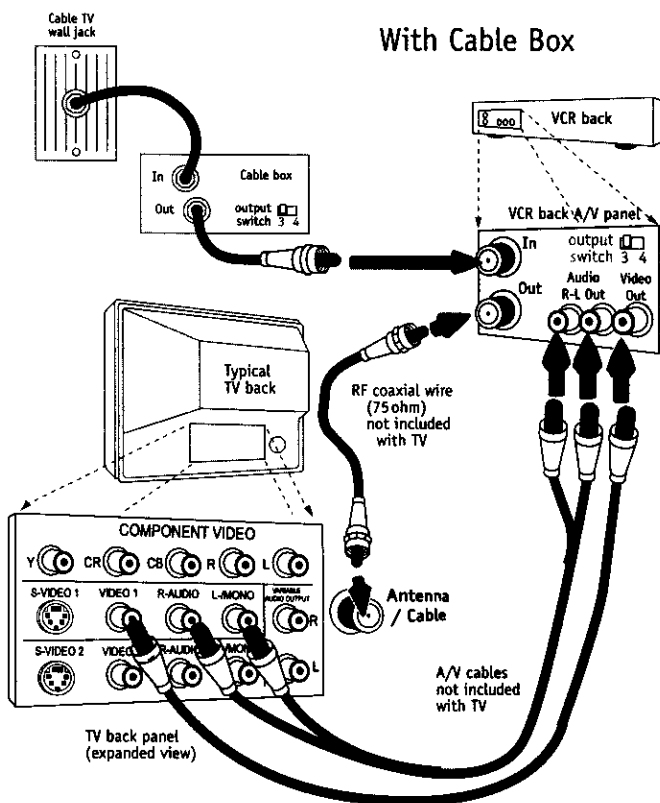

Super VHS VCR/DVD Player

Connecting a S-VHS VCR or DVD player to your Entertainment Machine

Super VHS VCR

- 1** Locate the Ant In jack on the back of your S-VHS VCR. Connect the cable line coming from your wall directly to this jack.
- 2** Now locate the Out to TV jack. Connect a cable from the Out to TV jack to the Antenna/Cable jack on the back of your TV.
- 3** Find the audio and S-Video jacks on the back of your S-VHS VCR, and connect them following the instructions provided with your equipment.

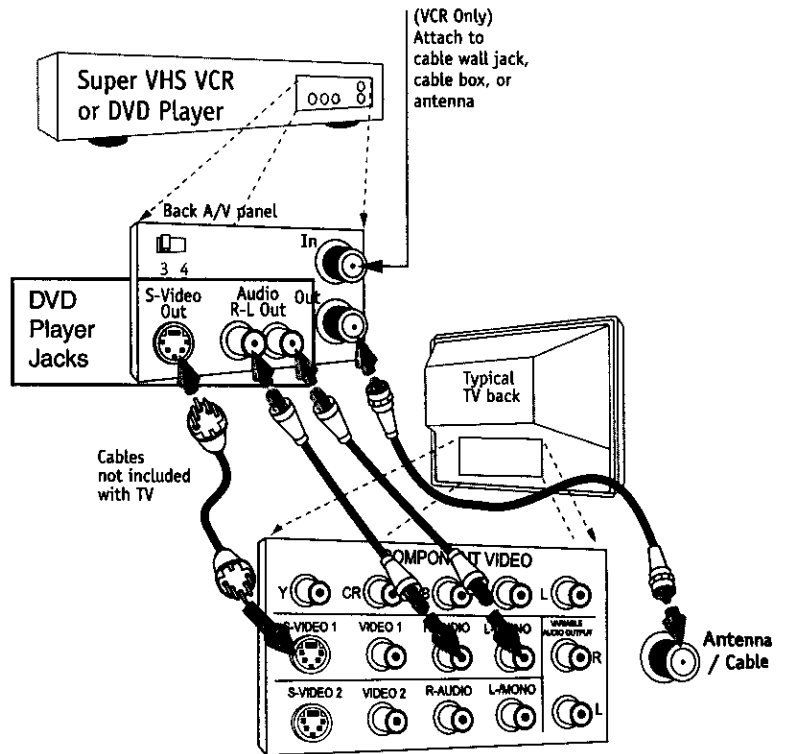

DVD (Digital Video Disk) Player

Simply connect the S-Video/Audio out on the DVD to the S-VIDEO 1, R-L AUDIO or S-VIDEO 2, R-L AUDIO IN on the TV. For Component Video, connect the Component Video Out jacks on the DVD to the COMPONENT VIDEO jacks on the TV.



Use Video/Audio sources for better picture and sound.



To use with PIP: go to the Source Menu (page 34) and choose the jack you've connected your S-VHS (S-VHS 1,-2) as the Main or PIP source.

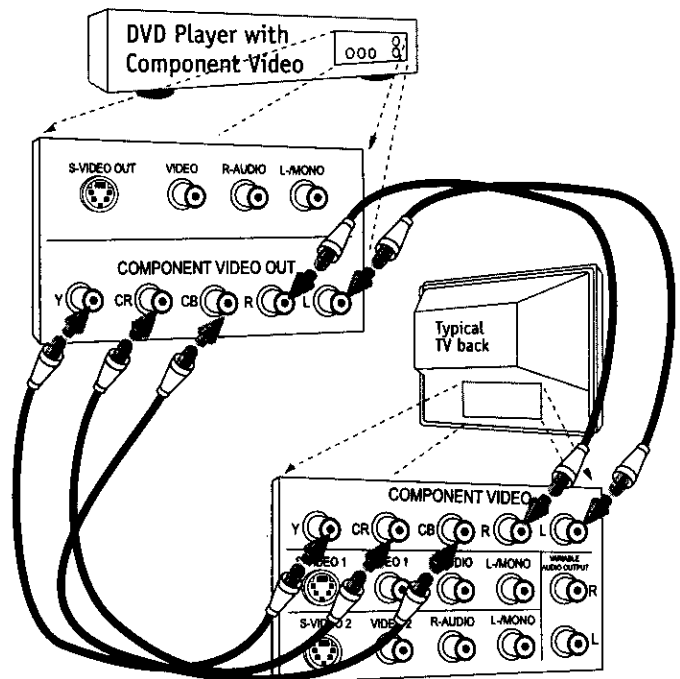

SUPER S-VHS VCR

Provides higher quality picture and sound than an ordinary VCR when connected to the S-Video in jacks.

DVD PLAYER

Digital Video Disks use the S-Video in jacks (or if available on the DVD, Component Video jacks) to provide the highest quality reproduction available from this technology.

Audio Hookups

Use your stereo to play the sound from your Entertainment Machine

Before you begin plugging in your stereo system, it's a good idea to put it in its approximate place first. That way you know how much wire you have or will need.

1

Locate the jacks marked R - L VARIABLE AUDIO OUTPUT. These are for the stereo system. Connect the stereo system's cables, according to their color (red is the right channel, white the left) to these jacks.

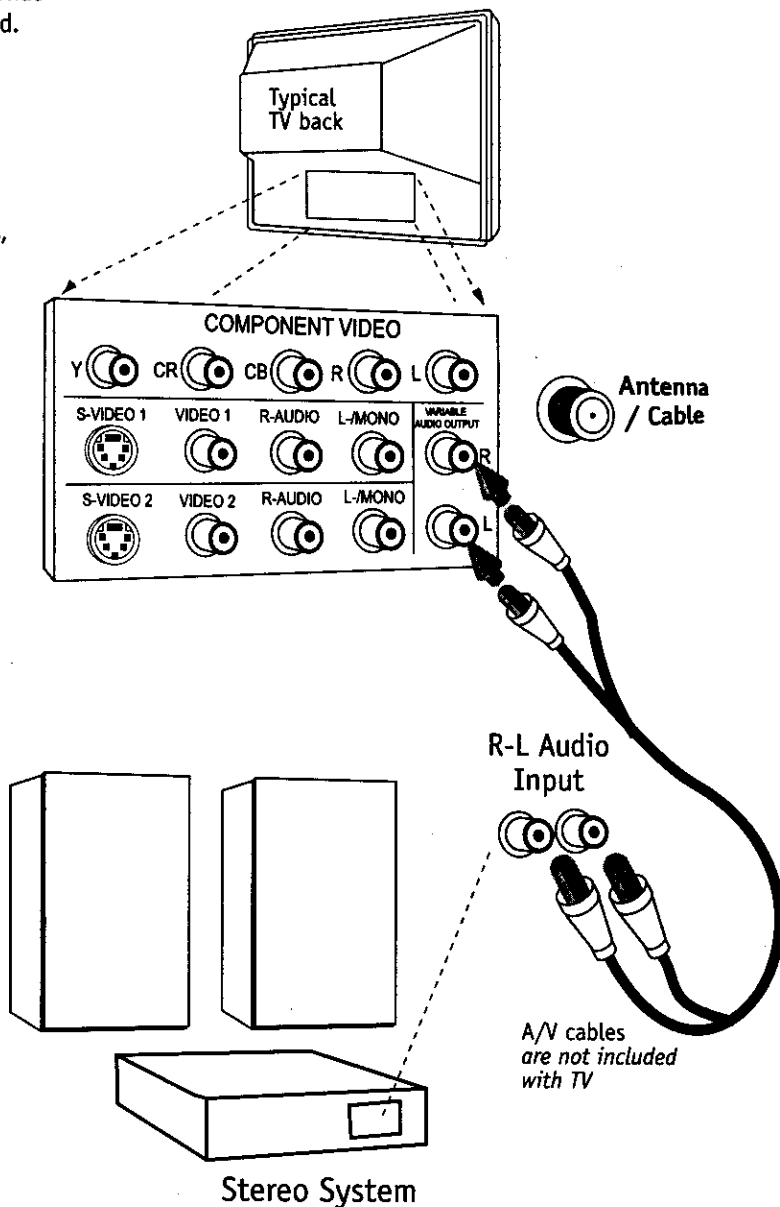

EZ Program (Channel Search)

Use EZ Program to automatically find and store in the TV's memory all the channels in your area.

Select:

Antenna If you receive off air signal reception.

Cable If you subscribe to a cable service.

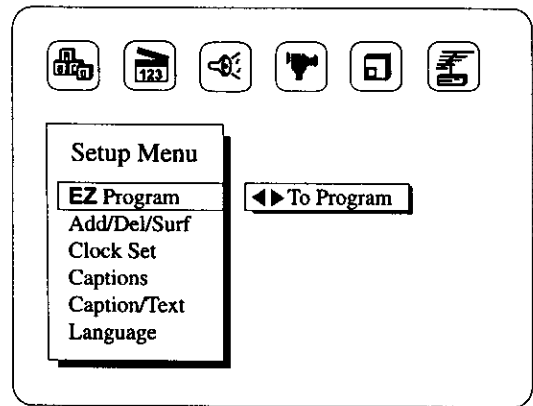

- 1 With the remote control in hand, press POWER to turn on your Entertainment Machine.
- 2 Press MENU repeatedly until the Setup menu appears.
- 3 Using the UP or DOWN arrow on the remote control, select EZ Program on your screen.
- 4 Press the RIGHT or LEFT arrow to show the EZ Program menu.
- 5 Using the UP or DOWN arrow, choose either Off Air Antenna, or Cable on your screen.
Note: The option that is blinking is selected.
- 6 Press the RIGHT or LEFT arrow to begin the channel search.
- 7 When the search is complete, press QUIT to return to TV viewing.



Note: EZ Program finds channels being received by the TV tuner. See page 17 for instructions on using the Cable Box or VCR tuners.



Cable will not work unless you subscribe to a cable service.

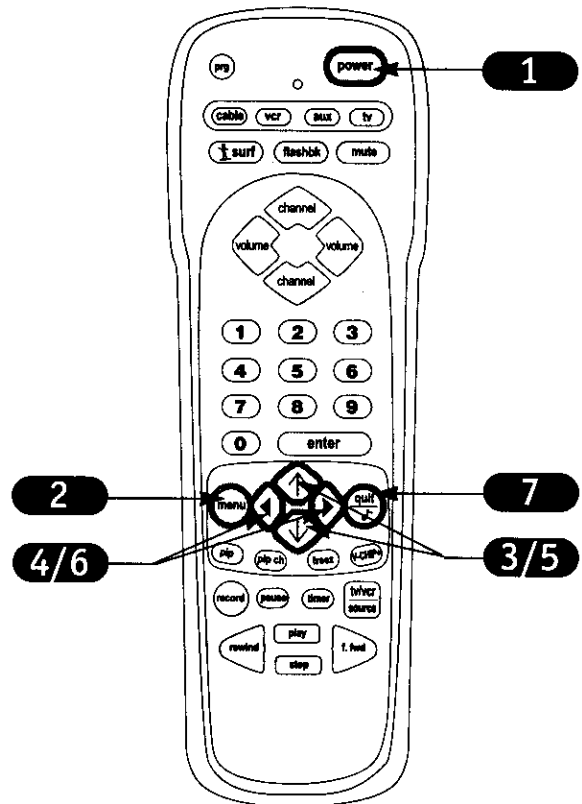

Mini Glossary

- OFF AIR ANTENNA** The device receiving the program signal broadcast over-the-air.
- CABLE** Your EZ Program selection, if you subscribe to a cable service.

Remote Key Functions in TV Mode

Note: Pressing TV puts remote into TV operating mode

A quick list of the keys on your remote and what they do in TV mode, see page 49 for remote key functions in the other modes

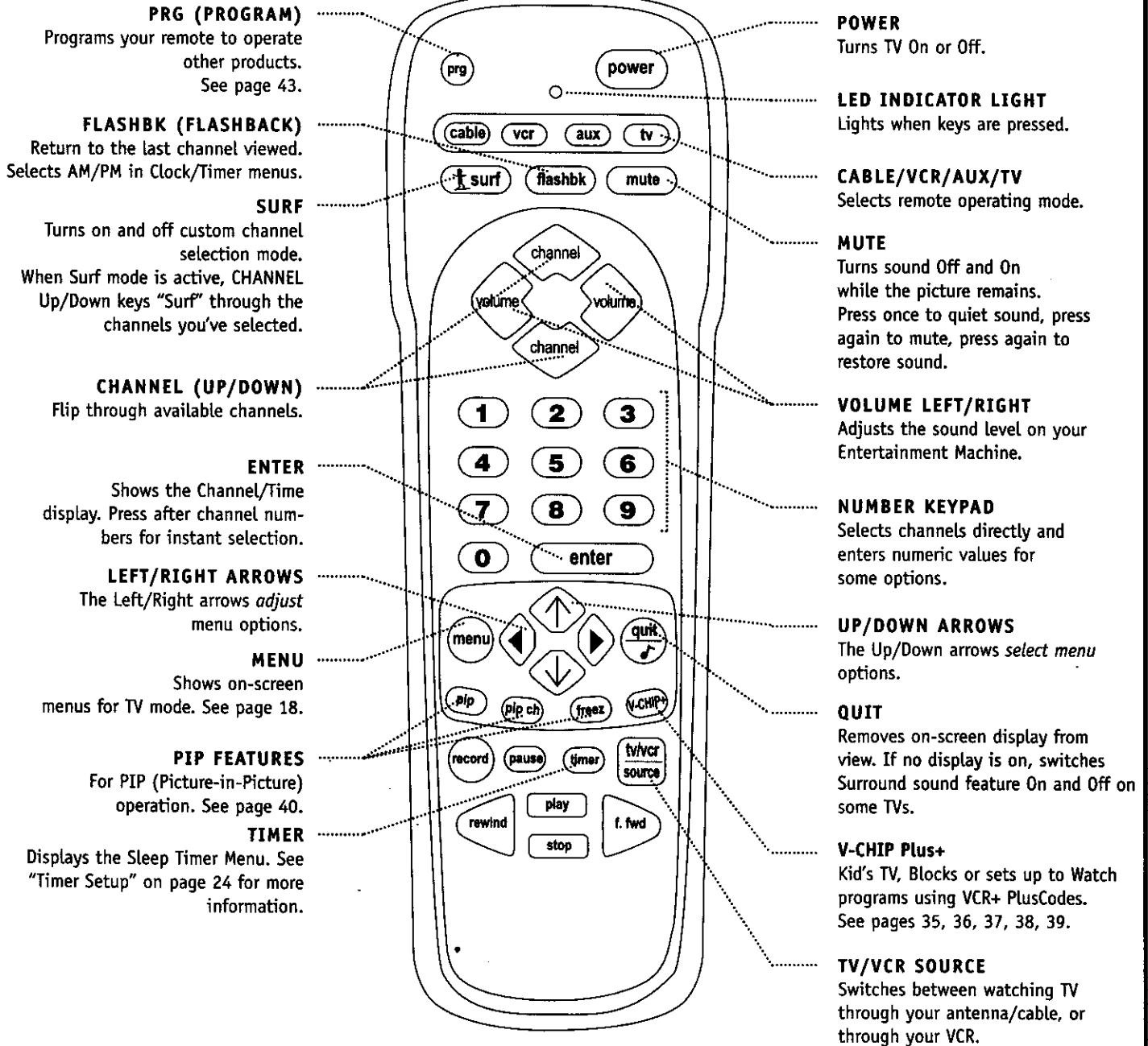

Keys dedicated to VCR functions will still operate your VCR while the remote is in TV mode.

remote control part number
MBR3464Z
(124-233-02)

On-Screen Menu Operation

Use either the remote control or the TV front controls to access the on-screen menus

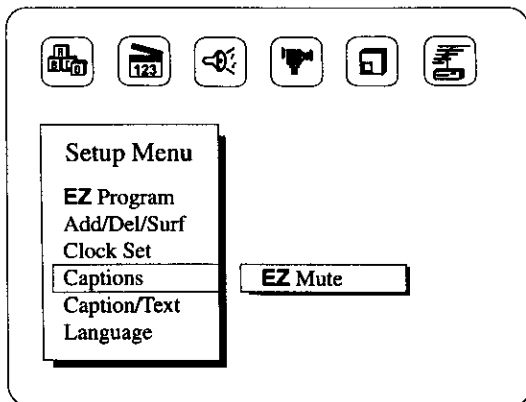

- 1 Press MENU repeatedly until the desired menu appears.
- 2 Use the UP or DOWN arrow on the remote control, to "select" an option like Captions on your screen.
- 3 Use the RIGHT or LEFT arrow to "adjust" the selected option.
- 4 Press QUIT when finished, to return to TV viewing.
- 5 In the Clock, and Timer menus, use the NUMBER keypad to set the clock, and timer features.



On-screen menus automatically disappear after 15 seconds.



Use the NUMBER keypad to enter numerical values for menu adjustments when required.



Remote must be in the TV mode for it to control the TV. Press TV on the remote to select TV mode.

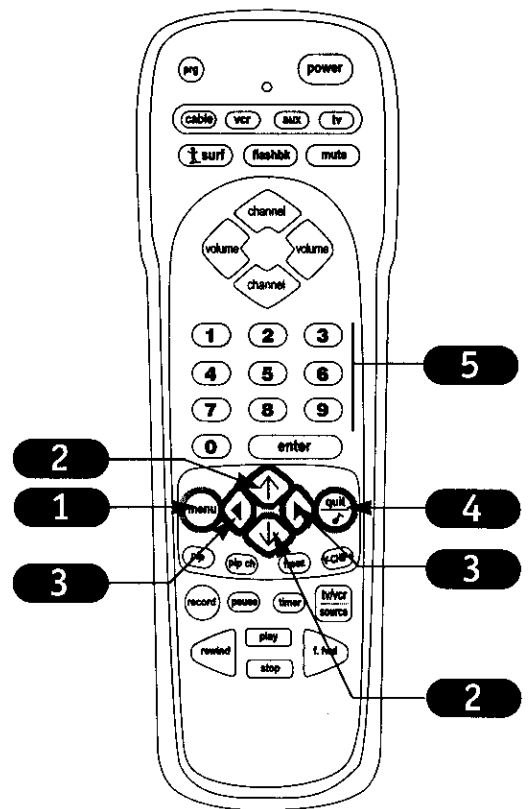

MENU

On-screen displays you use to program the TV features.

SELECT

Pressing the UP or DOWN arrow repeatedly will "select" or highlight menu options.

ADJUST

Use the LEFT or RIGHT arrow to choose or change the selected menu option.

QUIT

When finished with programming, press QUIT to exit on-screen menus and return to TV viewing.

Front Panel Controls

How to use your front control panel to operate the menus

When using the on-screen menus, the buttons on the 6-Button front panel correspond to the remote control keys as follows:

CHANNEL = Select Up/Down
VOLUME = Adjust Left/Right

- 1 To access the on-screen menus, press MENU. Pressing MENU repeatedly will cycle through the available menus.
- 2 Once the menu you want appears, SELECT the feature you want to change using the DOWN or UP arrow Channel buttons.
- 3 ADJUST or change the selected feature using the LEFT or RIGHT Volume buttons.

Note: If the feature you want to change requires you to enter numerical values, use the remote control.



Menus disappear after fifteen seconds. To get them back, press MENU again.



If you've lost your remote, you can get a new one by calling 1-800-255-6790 to purchase a replacement.

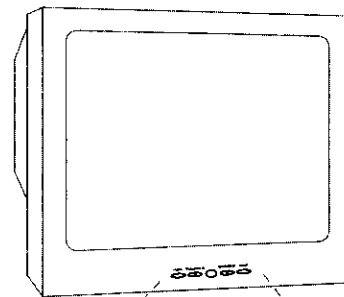

Typical 6-Button Panel

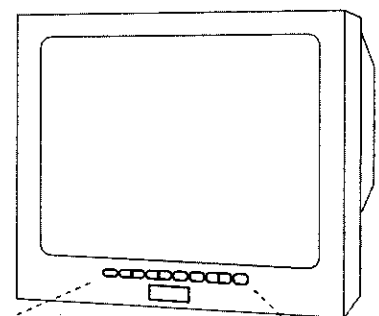
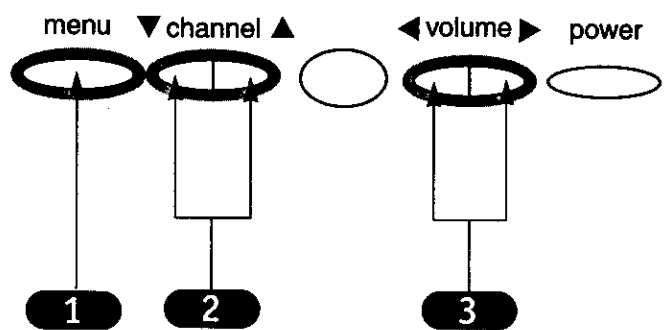

Typical 10-Button Panel

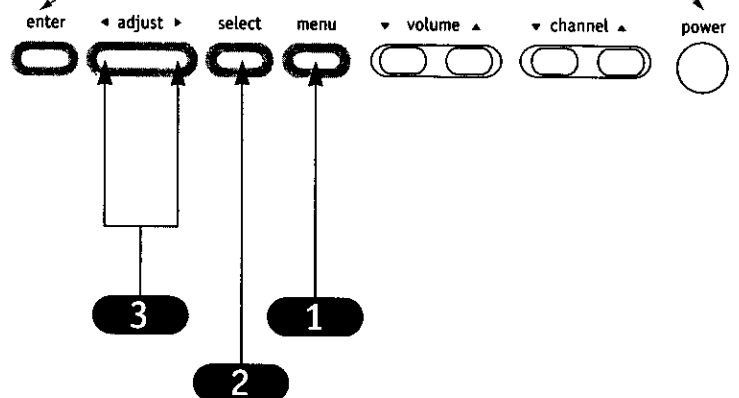

Basic operating information and using your Entertainment Machine with other equipment

- 1 Turn on the TV and other equipment.
- 2 Select your picture and sound source. See information on tuners and picture sources below.
- 3 Adjust controls for picture (Video) and sound (Audio). See short descriptions of the on-screen menus/displays beginning on page 18 and 19; use these to personalize the features of your Entertainment Machine.

Tuner

There are a number of ways you can choose to integrate your Entertainment Machine with the rest of your audio/video equipment. Channels can be changed using the television, the VCR, or the cable box, with advantages to each.

USING THE TELEVISION AS THE TUNER preserves all your channel labels (not available on some models). It also reduces the number of keys on the remote control you need to worry about. (One device, one remote to learn.)

USING THE VCR AS THE TUNER has the advantage of simplifying the recording process. If the VCR is tuned to channel seven, then the VCR will record channel seven.

USING THE CABLE BOX (if you have one) to change the stations sometimes has an advantage, too, especially if your cable provider requires you to use their cable box to descramble their stations.

Source

The source button (TV/VCR/Source) on the remote switches between Video input and Antenna/Cable input. The Channel/Time display will read "Video" in place of a channel number if A/V inputs are selected as the picture source.

Antenna/Cable Input: This setting allows you to change cable or antenna channels and to view videocassettes on channel 3 (or 4) in mono sound.

Video Input: This setting allows stereo playback of videocassettes. The television cannot change channels in the Video mode, but the VCR can.



To view the current input source, press ENTER on your remote. The Channel/Time display should appear in the upper right-hand corner of the screen. If the display reads 'Video,' then the picture and sound source is connected to one set of the Audio/Video input jacks. If the display reads a channel number, then the picture and sound source is the Antenna/Cable jack.

DEFINITIONS

TUNER	The television, VCR, or cable box that you choose to change channels with.
SOURCE	Connection on the TV's back jack connection panel providing picture and sound to the TV.

On-Screen Menus/Displays Overview

Descriptions of the menus and displays on your Entertainment Machine

Menu Name	Page	Description
ON-SCREEN MENUS		
SETUP MENU	13	Adjusts the basic features of your Entertainment Machine.
EZ Program	13	Automatically finds and stores active channels to flip through using Channel Up/Down.
Add/Del/Surf	20	Manually picks and chooses which active channels will appear when using Channel Up/Down and SURF.
Clock Set	21	Sets the time.
Captions	22	Turns closed captioning on, off, or set it to come on when the television is muted.
Caption/Text	22	Chooses a captioning or text option for your Entertainment Machine.
Language	23	Picks the language you want your on-screen menus to appear in.
SPECIAL FEATURES	24	Goes beyond basics and customizes your Entertainment Machine's™ features.
Timer Setup	24	Sleep Timer, programs a time for your Entertainment Machine to turn itself off after a certain amount of time.
	25	On/Off Timer, programs times for your TV to turn itself on and off.
Channel Labels	26	Labels your channels with their network names (ABC, CBS, HBO, etc.).
XDS Display	27	Turns the XDS program information feature on and off, see description below.
Parental Control	28	Allows parents to block any program or A/V source for up to 99 hours, with the use of a password.
EZ Demo	30	Demonstrates the on-screen menus that control TV setup and operational features.
AUDIO MENU	31	Customizes the sound to suit your room and taste. Your options are: Bass, Treble, Balance, Audio Mode, Front Surround, SoundRite, Speakers.
VIDEO MENU	32	Adjusts your picture for any viewing situation. Your options are: Contrast, Brightness, Color, Tint, Sharpness, Color Temp, EZ Picture.
PIP MENU	33	Controls the appearance and size of the PIP inset. Your options are: Color, Tint, Size.
SOURCE MENU	34	Chooses from the available picture and sound sources, the Main screen picture and PIP inset picture.
V-CHIP Plus+	35	Use program's VCR+ PlusCodes to set up the following options: Kid's TV, Block, and Watch.
PIP FEATURE	40	Turns Picture-in-Picture feature on and off, lists PIP options.
EZ HELP	54	Help menu offers several features from different menus that can be adjusted on one convenient menu.
ON-SCREEN DISPLAYS		
Channel/Time	19	Shows the current time, channel, video/audio source, and channel label if available.
PIP/Channel	19	If present, indicates PIP is on.
Volume Display	19	Shows the current sound level.
XDS Display	27	If provided by broadcaster on currently selected channel, may display some or all of the following information: Program name, length of program, time left in program in hours and minutes, and the Channel/Time/Audio display.

On-Screen Displays

The on-screen status displays reveal the current status of your Entertainment Machine

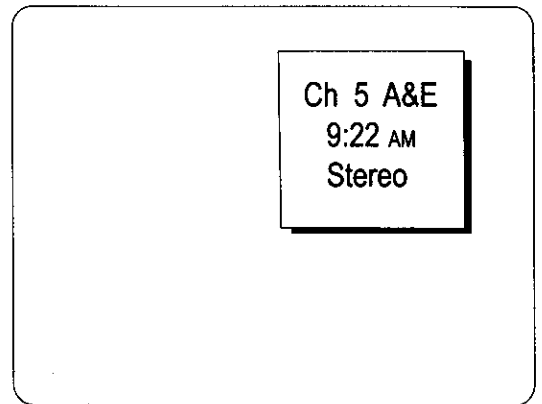

A Channel/Time Display

Press ENTER on the remote control to view the Channel/Time, and audio signal display.

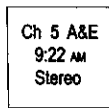

B Mute Displays

Press MUTE on the remote control to quiet the sound (Soft Mute).
Press MUTE a second time to remove the sound entirely (Mute).
Press MUTE a third time to restore the sound.



C Surf (Channel Selection) Mode Displays

Press SURF on the remote control to turn on Surf channel selection mode.
Press SURF again to return to normal channel selection mode.

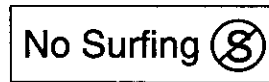
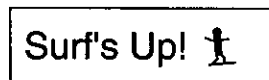

D Volume Display

Press VOLUME LEFT or RIGHT on the remote control, to view the sound status display.



E Sleep Timer Display

Press TIMER on the remote control to view the Sleep Timer Status Display. Press TIMER repeatedly to set the amount of time before the TV automatically turns itself off.

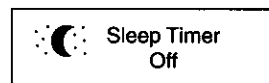

F Remove On-Screen Displays and Menus

Press QUIT to remove displays and return to TV viewing, or wait a few moments and the displays will disappear from the screen.

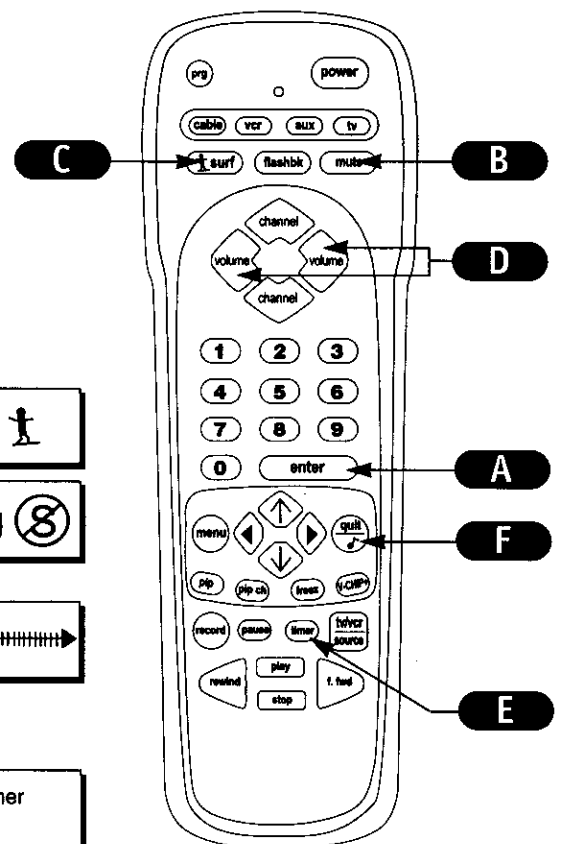

Customize your channel selection

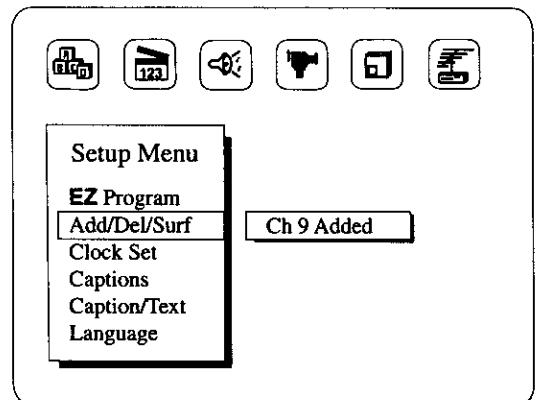

- 1** Press MENU repeatedly on the remote until the Setup menu appears.
- 2** Select the Add/Delete/Surf option with the UP or DOWN arrow.
- 3** Using either the NUMBER keypad and ENTER or the CHANNEL Up/Down arrows on the remote, select a channel. (If adding a deleted channel, you will need to use the NUMBER keypad.)
- 4** Using the RIGHT or LEFT arrow, pick whether that channel is Added, Deleted, or a Surf channel. (Surf channels are automatically "added" channels also.)
- 5** To continue, select another channel and repeat Step 4. If you are finished, press QUIT to return to TV viewing.



If you delete a channel, it isn't gone for good. Just select it using the NUMBER keypad on the remote, or add it later.



Press SURF, with Surf active, you can use channel up/down to scroll the Surf channel list. Press SURF again to return to normal channel scan.

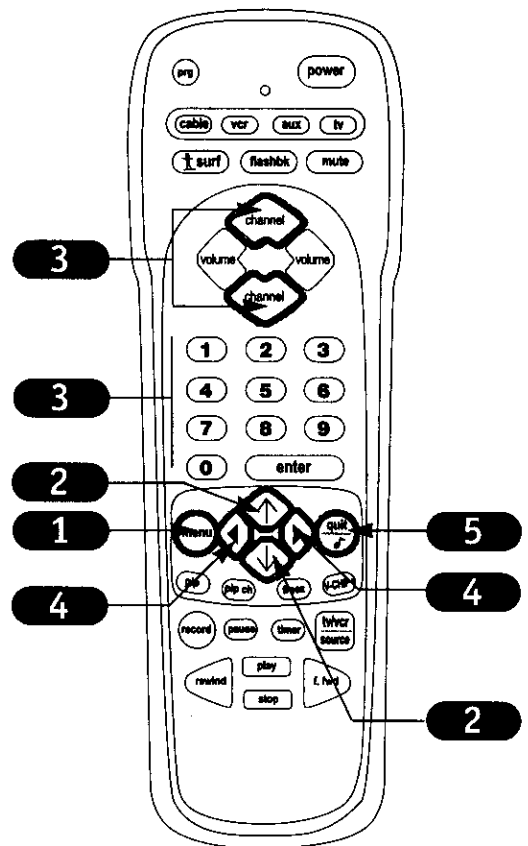

- ADDED** Includes new channels to the channel list that you'll scroll through when using Channel Up/Down.
- DELETED** Removes channels that you don't watch from the channel list you'll scroll through using Channel Up/Down.
- SURF** Adds your most often viewed favorite channels to the Surf channel list.

Clock Set Menu

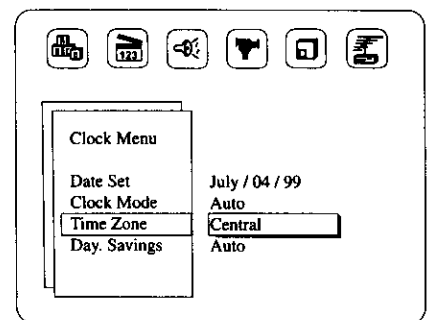
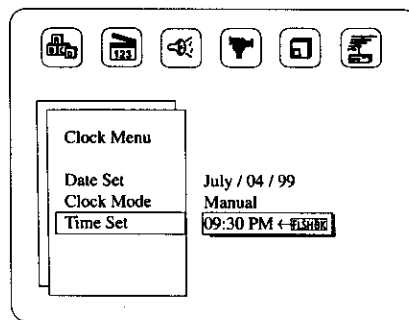
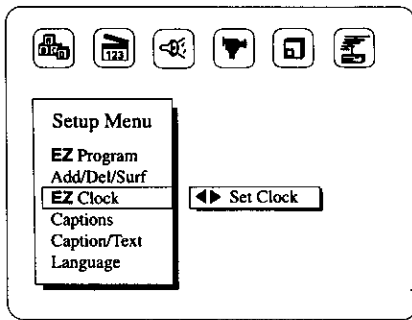

1 In the Setup menu with the EZ Clock option highlighted, use the Adjust LEFT or RIGHT arrow to go to the Clock Menu.

2 Use the Select UP or DOWN arrows, the Adjust LEFT or RIGHT arrows, and the NUMBER keypad to set the clock menu options.

3 As indicated on the menu, use FLSHBK to pick AM or PM.

Date Set:

Using either the NUMBER keypad or the Adjust LEFT or RIGHT arrow on the remote, set the date. The first two numbers are the month, the middle two numbers are the day, and the last two numbers are the year.

Time Set:

Using either the NUMBER keypad or the Adjust LEFT or RIGHT arrow on the remote, set the time. The first two numbers are hours, the last two numbers are minutes. Use FLSHBK to pick AM or PM.

Manual Mode

User sets the EZ Clock options.

- **Date Set:** Set Month, Day, Year using the NUMBER keypad.
- **Clock Mode:** Manual, Auto.
- **Time Set:** Set Hours and minutes using the NUMBER keypad.

Automatic Mode

TV sets the options, but the user can enter the menus and make custom changes if needed.

- **Date Set:** Set Month, Day, Year using the NUMBER keypad.
- **Clock Mode:** Auto, Manual.
- **Time Zone:** Auto, Eastern, Central, Mountain, Pacific.
- **Daylight Savings:** Auto, Off, On.

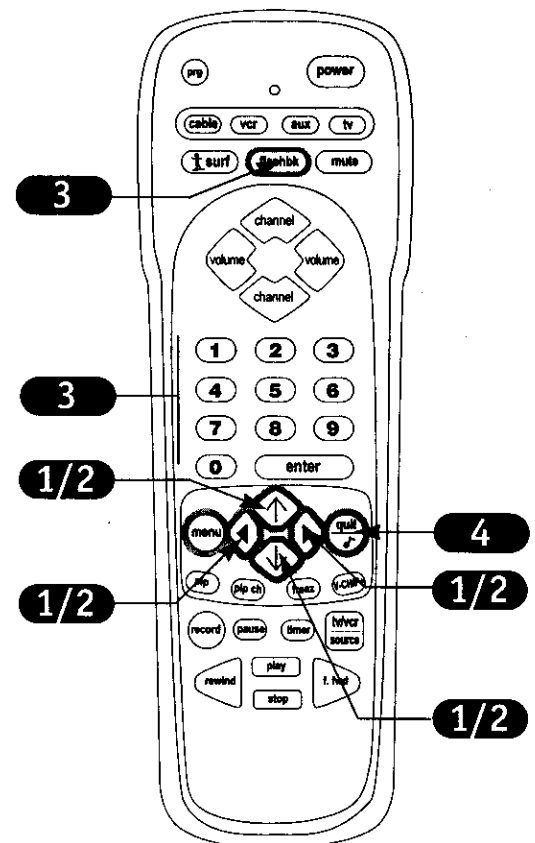

4 Press QUIT to return to TV viewing.

Time Settings

TIME A four-number figure broken down into hours and minutes; first two numbers are hours, last two numbers are minutes.

HOURS First two numbers that are entered when setting the clock.

MINUTES The second two numbers that are entered when setting the clock.

FLASHBK Used to pick AM or PM when setting the clock.

Captions, Caption/Text Menus

Turn on Closed Captioning or Captions When Mute, then select your Closed Captions or Text option

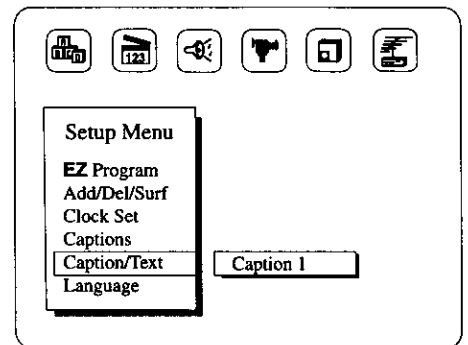
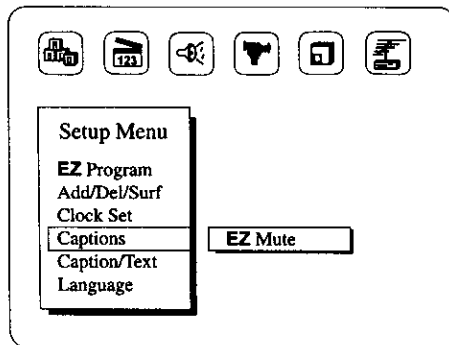

Caption/Text is a feature which allows your Entertainment Machine to receive various closed caption and text options provided by broadcasters. Availability and functionality of Caption/Text is determined only by the broadcaster and may not be available.

- 1 Press MENU on the remote control repeatedly until the Setup menu appears.
- 2 Use the UP or DOWN arrow on the remote control to select Captions.
- 3 Use the RIGHT or LEFT arrow to choose any of the following options: On, Off, or EZ Mute (Captions When Muted).
- 4 Use the UP or DOWN arrow on the remote control to select Caption/Text on your screen.
- 5 Use the RIGHT or LEFT arrow to choose one of the following options: Caption 1, Caption 2, Caption 3, Caption 4, Text 1, Text 2, Text 3, or Text 4.
- 6 Press QUIT to return to TV viewing.



Captions come in handy when the television is on mute. Standard closed captioning is available using the Caption 1 option.



Not all programming has closed captioning or text available; even though Captions 1, 2, 3, 4, and Text 1, 2, 3, 4 are available to broadcasters.

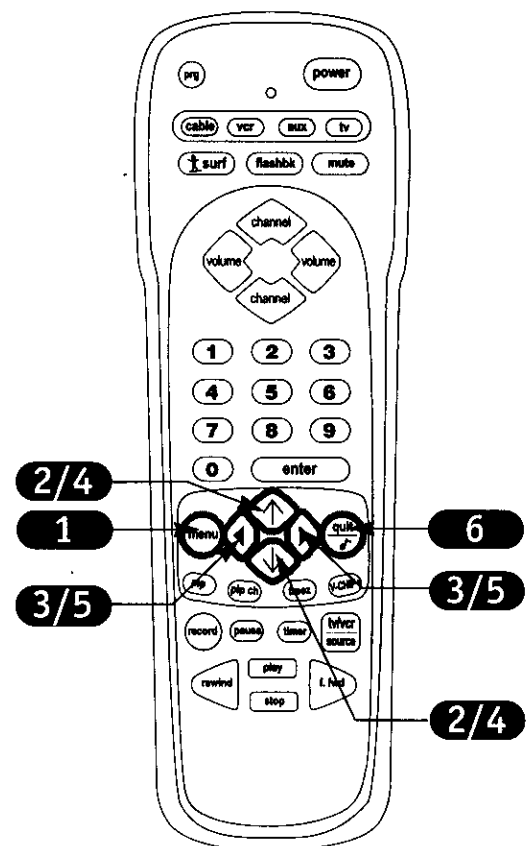

DEFINITIONS

CAPTIONS The term for the words that scroll across the bottom of the TV screen; usually the audio portion of the program provided for the hearing impaired.

TEXT The term for the words that appear in a large black frame and almost cover the entire screen; usually messages provided by the broadcaster.

Language Menu

Choose the language you want the on-screen menus to appear in

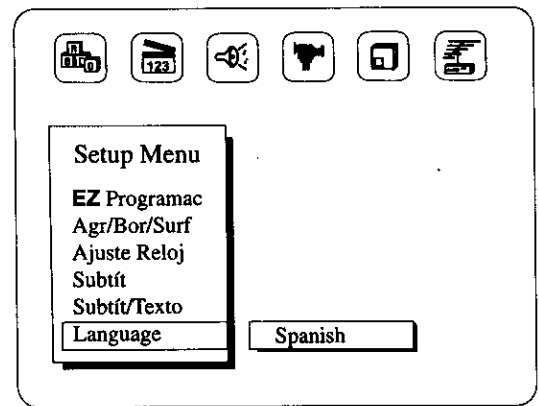

- 1 Press MENU on the remote control repeatedly until the Setup menu appears.
- 2 Use the UP or DOWN arrow on the remote control to select Language on your screen.
- 3 Use the RIGHT or LEFT arrow to choose any of the following options: English, Spanish or French.
- 4 Press QUIT to return to TV viewing.

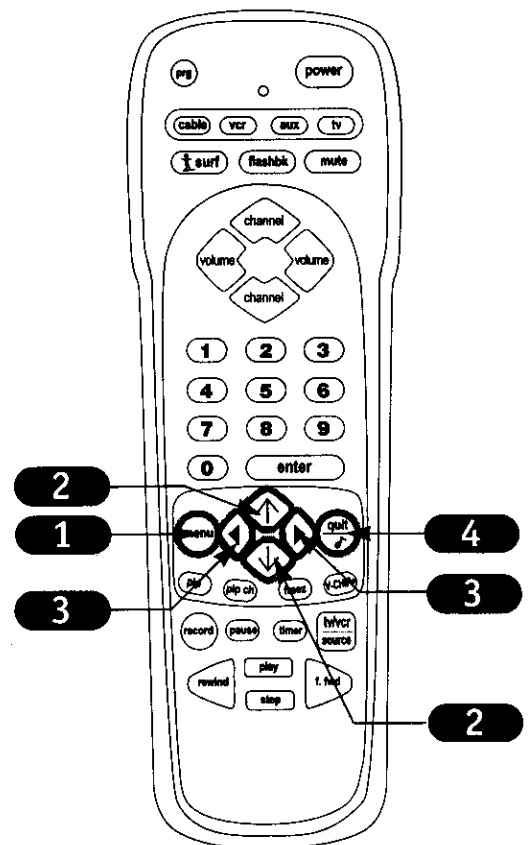

EZ Timer, Sleep Timer Menu

Pick one of the preset times to automatically turn your Entertainment Machine off (If you fall asleep, the TV will automatically turn itself off)

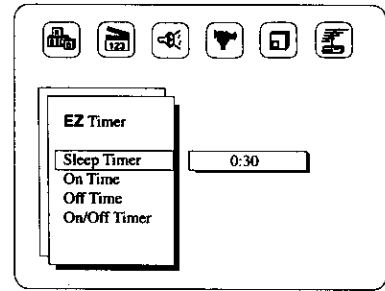
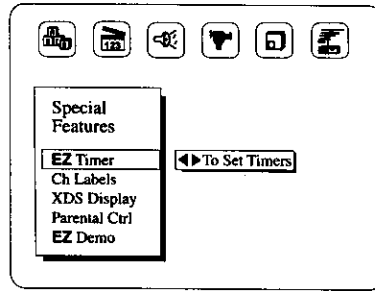

- 1** In the Special Features menu with EZ Timer highlighted, press the RIGHT or LEFT arrow to show the EZ Timer menu.
- 2** Select Sleep Timer using the UP or DOWN arrow.
- 3** Use the RIGHT or LEFT arrow to choose from the preset times, the time you want the TV to turn itself off - - you can choose a time period from 10 minutes to 4 hours.
- 4** Press QUIT to return to TV viewing.
- 5** Press TIMER to go directly to the sleep timer menu. Press TIMER repeatedly to choose one of the preset turn off times.



Another method of setting the Sleep Timer, is to press TIMER and go directly to the Sleep Timer menu. Use the LEFT or RIGHT arrow to select one of the preset shutoff times.

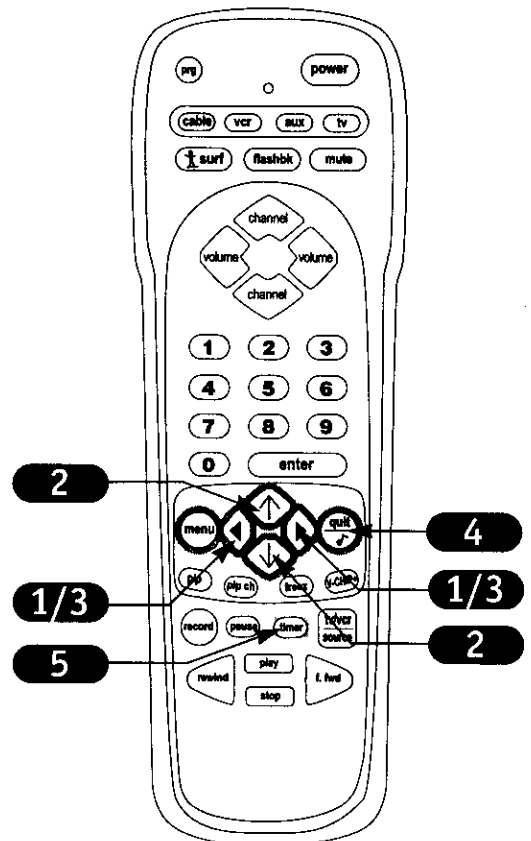

DEFINITIONS

SLEEP TIMER Feature that automatically turns the TV off after a preset time has expired.

EZ Timer, On-Off Time, On/Off Timer

Set the timers to turn your Entertainment Machine on and off each day automatically

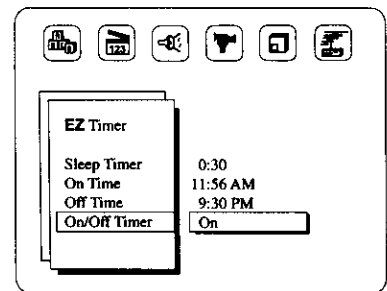
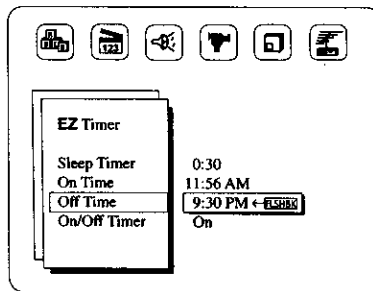
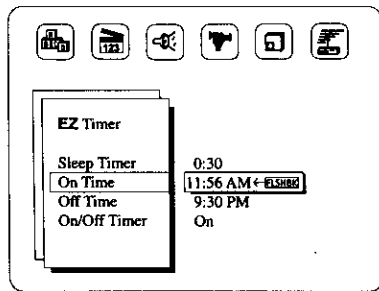

- 1 In the Special Features menu with EZ Timer highlighted, press the RIGHT or LEFT arrow to go to the EZ Timer menu.
- 2 Select On Time, using the UP or DOWN arrow on the remote control.
- 3 On Time: Use the RIGHT or LEFT arrow or the NUMBER keypad to enter the time your TV will automatically turn on.
- 4 Use FLASHBK to select AM or PM.
- 5 Off Time: Repeat the above instructions and select an off time.
- 6 On/Off Timer: Use the UP or DOWN arrow to select the On/Off Timer option.
- 7 Use the LEFT or RIGHT arrow to set the On/Off Timer to either:
On - TV will turn on and off automatically,
Off - TV will not turn on and off automatically.
- 8 Press QUIT to return to TV viewing.



Use the NUMBER keypad to type in time settings.



Use the LEFT or RIGHT arrow to select the preset time.



The On/Off Timer will not work until the Clock on your television has been set.

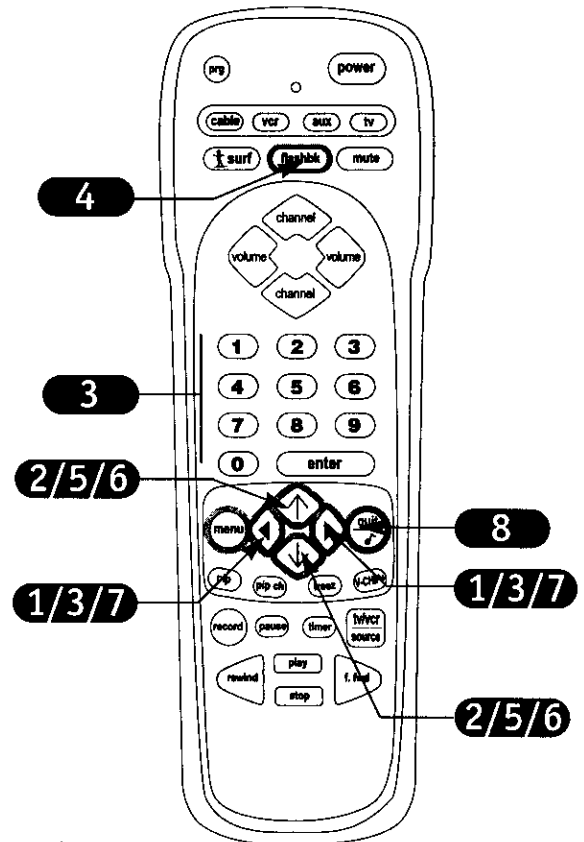

DEFINITIONS

ON TIME	Time setting that automatically turns your TV on at the preset time.
OFF TIME	Time setting that automatically turns your TV off at the preset time.
ON/OFF TIMER	Option that enables or disables the On/Off Timer settings.

Channel Labels Menu

Pick a preset label to help identify the network you just tuned to or are currently watching

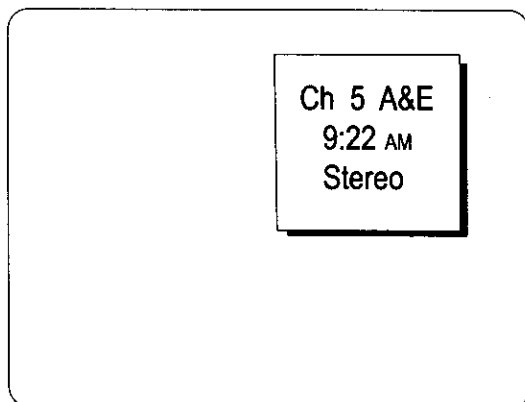

Channel/Time Display with Channel Label

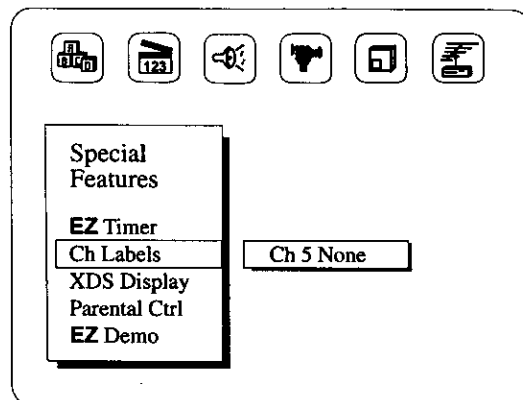

- 1** Using the NUMBER keypad or CHANNEL UP or DOWN, pick the channel you want to label.
- 2** Press MENU repeatedly until the Special Features menu appears.
- 3** Use the UP or DOWN arrow key to select CH. LABELS.
- 4** Select a label for the channel.
Press the RIGHT arrow key (each press will bring up a different label) to go through the alphabetical listing, starting with A - B - C - D, etc.
Or, use the LEFT arrow key to go through the alphabetical listing backwards, starting with Z - Y - X - W, etc.
- 5** Press QUIT to accept the label and return to regular TV viewing.



If a channel label is picked, the Channel Label for the channel you are watching appears when you press ENTER or change to a different channel that also has a channel label; a convenient way to know which network you are viewing.



Some broadcasters provide their own channel labels.



Channel Labels do not appear for video sources.

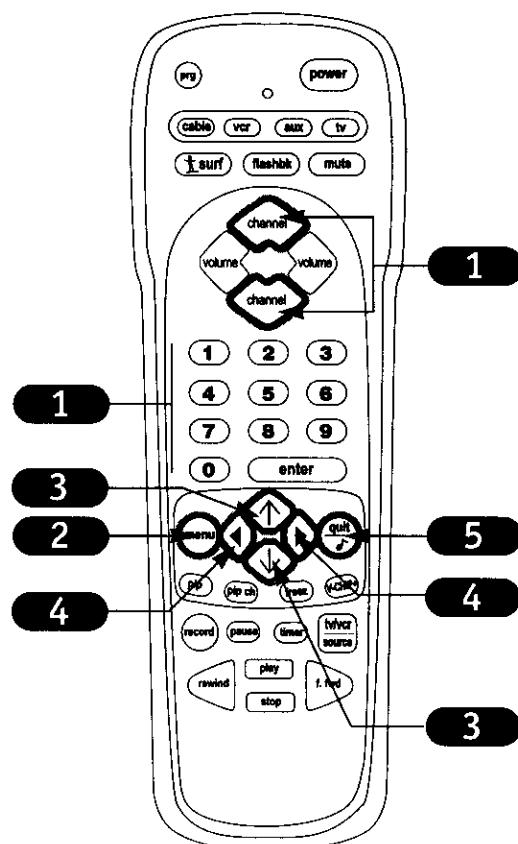

Channel Labels

- This label indicates that your TV will accept the original, broadcast label.
- None This label will block all labeling.

XDS Display Menu

Use the Extended Data Service to show in-depth program information

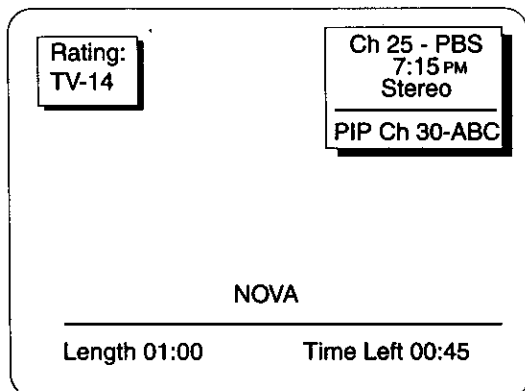

Typical XDS Display with PIP active

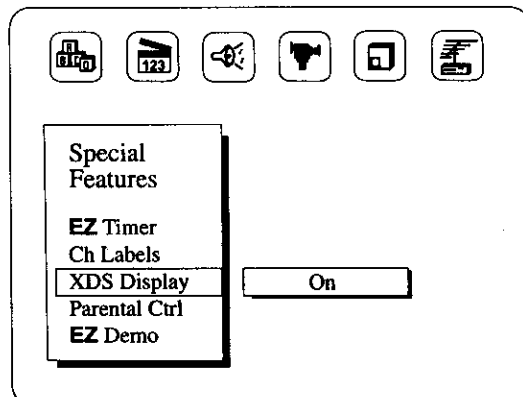

- 1 Press MENU on the remote repeatedly until the Special Features menu appears.
- 2 Highlight the XDS Display option using the Select UP or DOWN arrow.
- 3 Use either the RIGHT or LEFT arrow to specify On or Off. On - - XDS Display will appear as channels are changed. Off - - XDS Display will not appear when channels are changed.
- 4 Press QUIT to return to TV viewing.



At this printing, XDS data is only being provided by some broadcasting stations; and as a result, is only available on some channels.



Even though XDS data may be present, it may not be available during commercial or network breaks.

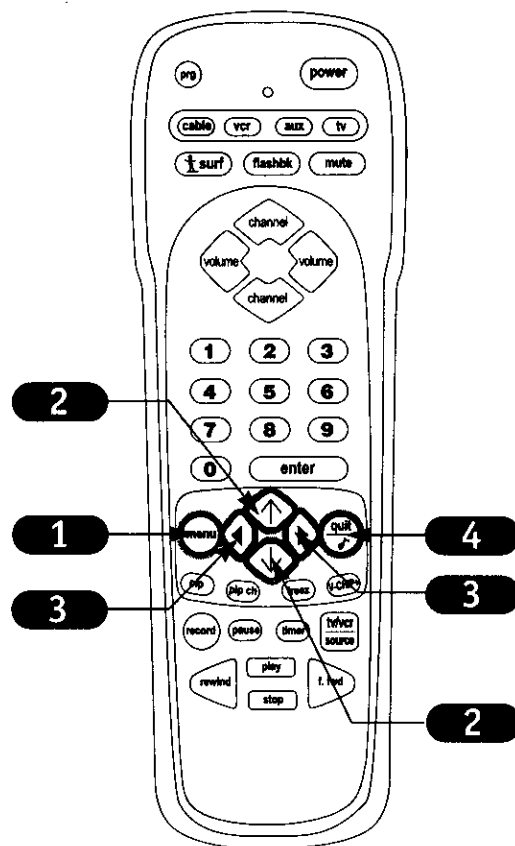

XDS

Extended Data Service - - if provided by the broadcaster, may show some or all of the following information: Channel/Time/Audio display, Network label if present, Title of program, Length of program in hours and minutes, and the Time remaining on the program in hours and minutes, and If PIP is active, the PIP channel number.

Parental Control

This optional feature can be used to "block" undesirable programming from appearing on your TV

Parental Control offers the user a wide variety of options and settings that restrict or "block" the programming that can appear on the TV. Parental control allows the user the capability of defining which program rating they consider acceptable, to the younger or more sensitive viewer. It can be preset and turned either on or off by the user who specifies the secret 4-number code, the password. The number of hours blocked are specified. For complete coverage, General Audience and Children viewer blocks should both be programmed into the TV's memory. Viewer ratings are specified for both TV and the motion picture industry; both rating systems can be used. The ratings are based mainly on the ages of children.

Overview

To insure complete coverage for all TV programs, (movies and regular TV shows) choose a rating for MPAA, from the selections below AND choose ratings from the TV Parental Guidelines Rating System on the next page, using the Age Block option for General Audiences, and for Children. In addition to those, you may wish to include additional restrictions from the Content Block menu. See the Parental Control menu, and submenus example on the next page.

Things to Consider before Setting Up Parental Control

Determine which rating you consider acceptable to the viewer. (For example, if you choose TV-PG, all more restrictive ratings will be automatically blocked; the viewer will not be able to see: TV-PG, TV-14, or TV-MA rated programming.)

Do you want to block the auxiliary video source entirely? (Blocks the signal sent by the equipment, such as a VCR, connected to the TV Audio/Video input jacks; in the Aux. Block option.) Or leave unblocked, and have the restrictions you specified filter the content from the video source.

Block program "Content" based on individual parameters such as: Strong Dialog, Bad Language, Sex Scenes, Violence Scenes, or Fantasy Violence Scenes; in the Content Blk option.

How many hours do you want Parental Control to be active? You can set the Hours option for up to 99 hours.

Select a secret password; in the Set Password option. Use the number keys on the remote. Don't forget the password, it is the only way you can access the Parental Control menu and change rating selections, or turn Parental Control off.

Do you want Parental Control to be active all the time? If not, you can turn it on or off; with the Lock On/Off option.



You should set Parental Control viewing restrictions for General Audiences and for Children - - both should be active at the same time.



If you choose to leave the Aux inputs unblocked, the ratings you specify will still restrict the programming content that appears from the video sources.



Simply specifying one content block such as Sex Scenes, will not automatically block another content in the programs from appearing.



You cannot disable Parental Control by disconnecting the TV from power. Block hours will automatically reset to the original block time setting specified if power is disconnected.

MOTION PICTURE ASSOCIATION OF AMERICA (MPAA) RATING SYSTEM

G	General Audiences	Content not offensive to most viewers.
PG	Parental Guidance Suggested	Content is such that parents may not want their children to view the program.
PG-13	Parental Guidance Suggested	Program is inappropriate for preteens, with a greater degree of offensive material than a PG rated program.
R	Restricted viewing	Not for children under age 17. Strong elements of sex and/or violence.
NC-17	Restricted Viewing	Not for children under age 17 under any circumstances. Strong sexual content.
X	Hard Core Films	Same as NC-17 rating.

Note: Zenith Electronics Corporation is not liable for any program content that appears when using this rating system; as always, user discretion is advised.

Setting Up Parental Control

After you have read the preceding page, follow instructions below to set up and activate Parental Control

1

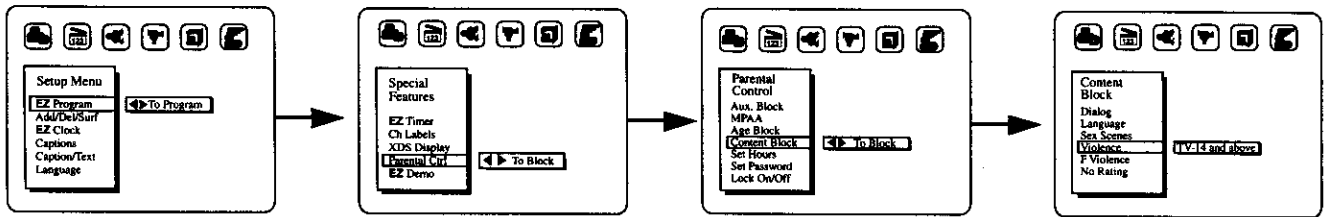

Note: Use the remote control to set up Parental Control.

Follow These Instructions

As shown above in the Special Features menu, highlight the Parental Control option, press the RIGHT arrow to go to the Parental Control menu.

Use the UP or DOWN arrow to select an option, like Content Block for example.

Press the RIGHT or LEFT arrow to go to the Content Block menu.

Use the UP or Down arrow to select a Content Block classification like Violence. Use the RIGHT or LEFT arrow to choose an acceptable rating for that option, TV-14 and Above, for example. (See the Mini Glossary, Ratings Charts on this and the previous page for rating meanings.)

Use the UP or DOWN arrow to select another Content Block classification like Language for example and then choose an acceptable rating. Or, press MENU to return to the Parental Control menu to select and adjust other classifications.

After you have selected and adjusted the Parental Control menu options to your preferences, select and:

- Set the number of hours you want Parental Control on
 - - use the RIGHT or LEFT arrow.
- Set your 4-number password
 - - use the NUMBERS on the remote.
- Set the Lock On/Off option to either on or off
 - - use the RIGHT or LEFT arrow.

Press QUIT to remove menu from screen.



No Content, means the broadcast does not contain any rating information.

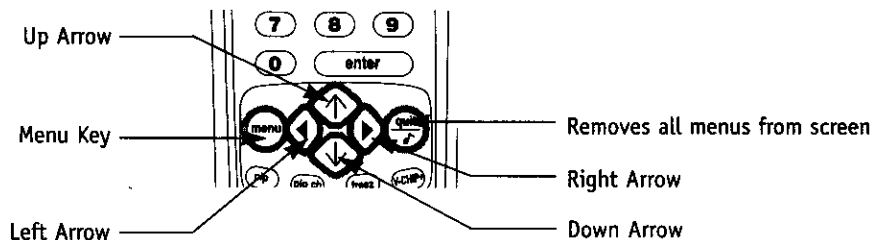

TV PARENTAL GUIDELINE RATING SYSTEM

TV-G	General Audience	Considered suitable for all audiences; children may watch unattended.
TV-PG	Parental Guidance Suggested	Unsuitable for younger children, may contain: Suggestive Dialog, Bad Language, Sex, and Violence Scenes.
TV-14	Parents Strongly Cautioned	Unsuitable for children under 14, may contain: Strong Dialog, Bad Language, Sex, and Violence Scenes.
TV-MA	Mature Audience Only	Adults only, may contain: Strong Dialog, Bad Language, Sex, and Violence Scenes.

CHILDREN'S CLASSIFICATIONS

TV-Y	Children	Considered suitable for all children under 7 years old.
TV-Y7	Children 7 and over	Considered suitable for children over 7, may contain Fantasy Violence Scenes.

Your Entertainment Machine can show you the menus available

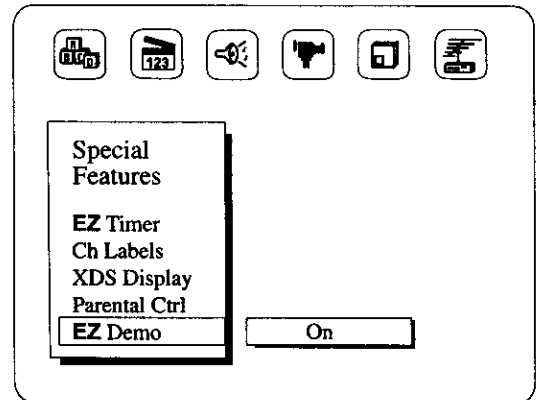

- 1 Press MENU repeatedly on the remote control until the Special Features menu appears.
- 2 Use the Up or Down arrow on the remote control to select EZ DEMO on your screen.
- 3 Press the RIGHT or LEFT arrow to choose either: On; EZ Demo will continue to operate (even if the TV is turned off and on again) until it is turned off in the Special Features menu. Off; EZ Demo will not be active.
- 4 Press QUIT to return to regular TV viewing.



Even if the TV is turned off, the EZ Demo feature will continue to operate when the TV is turned on again.

The only way to turn EZ Demo off is to select Off, in the Special Features menu.

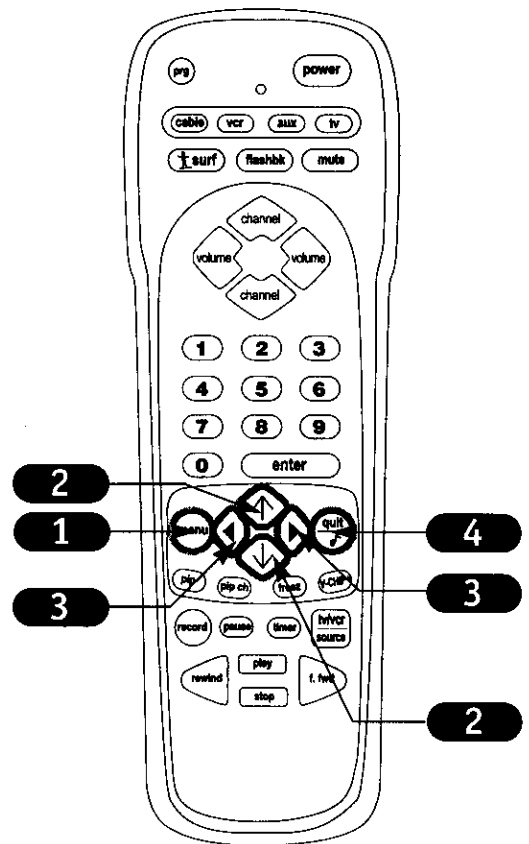

EZ DEMO

Feature provides an automatic demonstration of the on-screen menus on your Entertainment Machine. View and learn what features are available to you as EZ Demo cycles through the on-screen menus.

Audio Menu

Personalize the sound coming from your Entertainment Machine

- 1** Press MENU repeatedly on the remote control until the Audio menu appears.
- 2** Using the UP or DOWN arrow on the remote control, select the setting you want to change. Choose from:
 - **Bass:** Increase/decrease lower-end sounds.
 - **Treble:** Increase/decrease higher-end sounds.
 - **Balance:** Allows you to put the sound more to the left or right channel.
 - **Audio Mode:** Choose sound: Stereo, Mono, 2nd Audio/SAP.
 - **Front Surr:** Turn the front surround sound speakers on or off.
 - **EZ SoundRite:** Scans for changes in sound level during commercials, then adjusts the sound to match your current level.
 - **Speakers:** Turn the regular speakers on or off.
 - **EZ Sound:** Choose from Custom, Normal, Stadium, News, Music, or Theater. (Normal resets all audio settings to original levels.)
- 3** Press the RIGHT or LEFT arrow to change the option you have selected or adjust the sound setting to whatever you prefer.
- 4** Press QUIT to return to TV viewing, or press the UP arrow to return to the Audio Menu to adjust another option.



Not all programming is broadcast in stereo sound, or has Second Audio Programming/SAP.



If 2nd Audio SAP is selected and none is present, audio may not be heard.

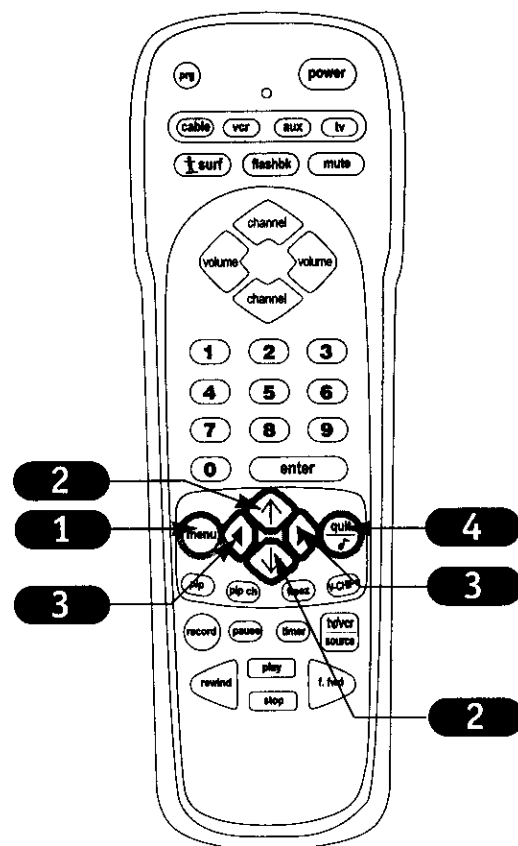
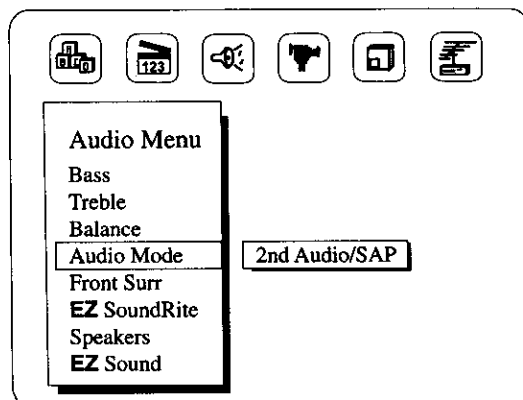

AUDIO MODES

Mono	Sound is broadcast over one audio track.
Stereo	Sound is broadcast over two audio tracks, divided between the left and right speakers.
2nd Audio/SAP	An extra audio signal may be transmitted in addition to the regular audio portion of a broadcast.

Video Menu

Customizes the picture to your personal viewing preference

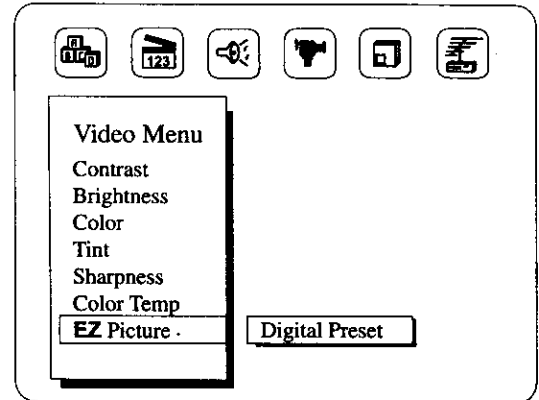

1 Press MENU repeatedly until the Video menu appears.

2 Using the UP or DOWN arrow, select the menu option that you want to change. Your options are:

- **Contrast:** Changes the amount of difference between black levels and white levels in your picture.
- **Brightness:** Increases or decreases the amount of white in your picture.
- **Color:** Adjust levels of all colors.
- **Tint:** Adjust the relative amounts of the color red and green in your picture.
- **Sharpness:** Raise or lower the definition of the picture. The lower the level, the softer the image will appear.
- **Color Temp:** Adjust the color qualities of the entire picture at once, options are: warm, and cool.
- **EZ Picture:** Choose appropriate viewing setting based on the video image provided, options are: Custom, Normal, Movie, Digital Preset, Video Game, Sports, Weak Signal, or Night Time.

3 Use the RIGHT or LEFT arrow to adjust the option you have selected.

4 Press QUIT to return to TV viewing.

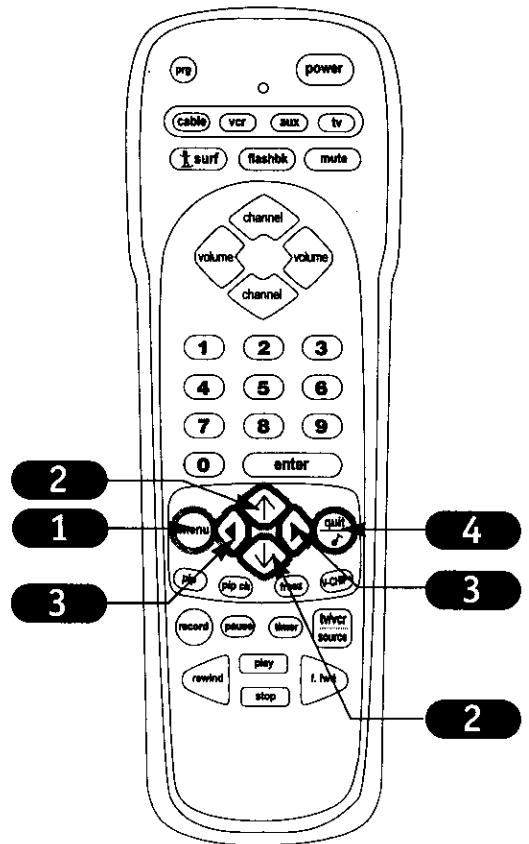

Custom	The settings you change to your personal preferences.
Normal	Select this option to reset the video menu settings to their original levels.
Digital Preset	Use this setting when viewing images provided by digital equipment.
Night Time	Select this setting when you are viewing the TV in dimmed room light.

PIP (Picture-in-Picture) Menu

Customize your PIP Inset picture

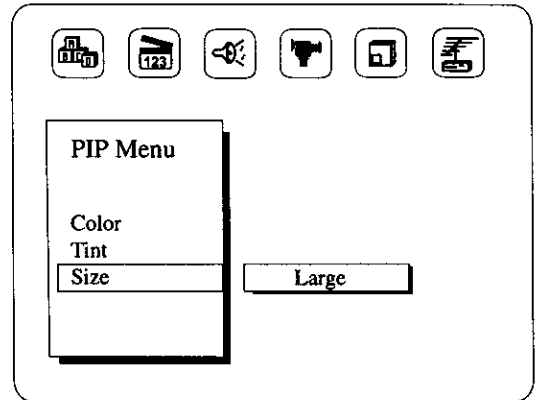

- 1 Press MENU repeatedly on the remote control until the PIP features menu appears.
- 2 Use the UP or DOWN arrow on the remote control to select an option on your screen.
- 3 Use the RIGHT or LEFT arrow to change the option.
 - **Color:** Adjusts the color of the PIP inset.
 - **Tint:** Adjusts the relative amounts of the red and green in the picture.
 - **Size:** Increases or decreases the size of the PIP inset.
- 4 Press QUIT to return to TV viewing.



To access the picture-in-picture (PIP) feature, press PIP on the remote. See pages 40, 41, and 42.

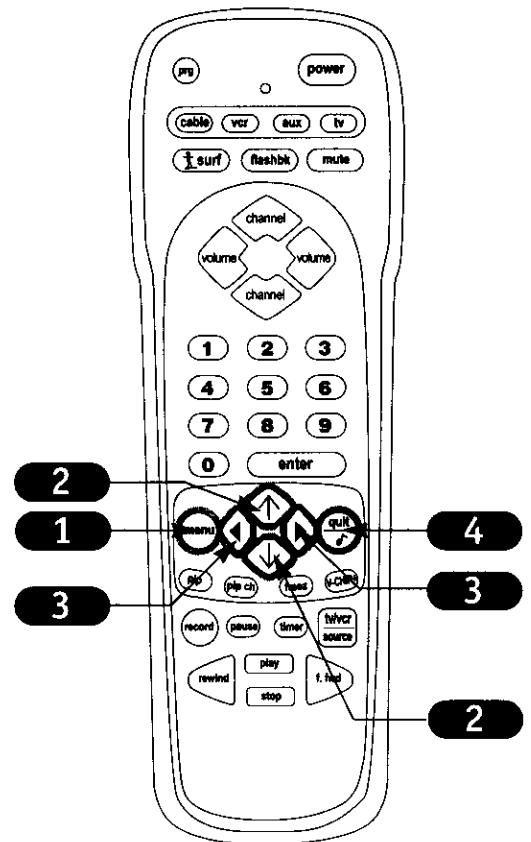

Source Menu

Choose viewing Sources for both the Main Picture and PIP Inset Picture

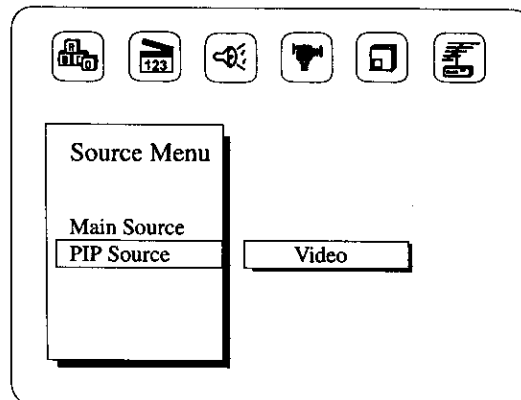

- 1** Press MENU on the remote control repeatedly until the Source menu appears.
- 2** Use the Up or Down arrow to choose:
Main Source (Main picture)
PIP Source (PIP inset picture)
- 3** Use the LEFT or RIGHT arrow to pick the picture and sound for the chosen viewing source.
- 4** Press QUIT to return to TV viewing or pick another source.



You can also press the TV/VCR SOURCE key to change sources, see remote control on page 14.



If you connected component(s) to the S-Video In jacks, then the Source menu will show S-Video 1, S-Video 2, etc. as the available sources (instead of Video 1 and Video 2).

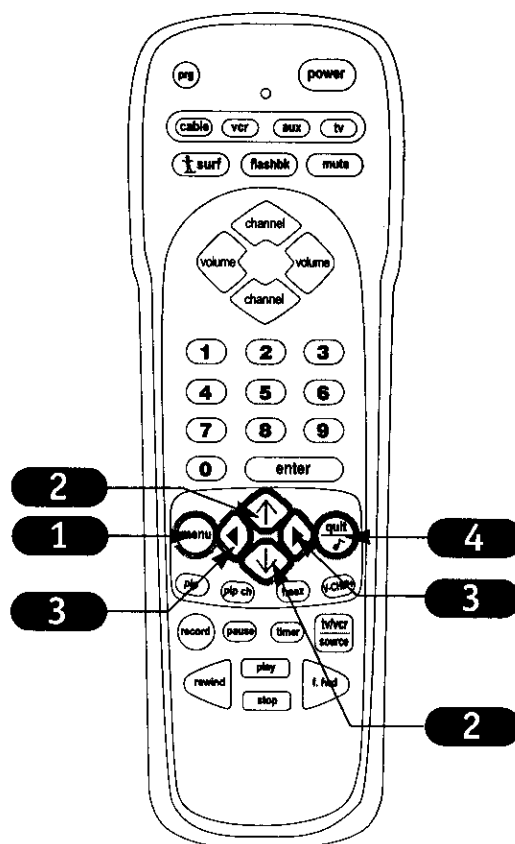

Sources	Refers to the equipment or incoming signal connected to the input jacks on the back of the TV.
Main Picture	The large or main picture on the TV screen.
PIP Picture	The small picture in the PIP inset.

V-CHIP Plus+ Demo and Setup

Set up V-CHIP Plus+ and enjoy the features (listed on the following pages and shown on the Demonstration) that automatically control programming which can appear on your TV, see below

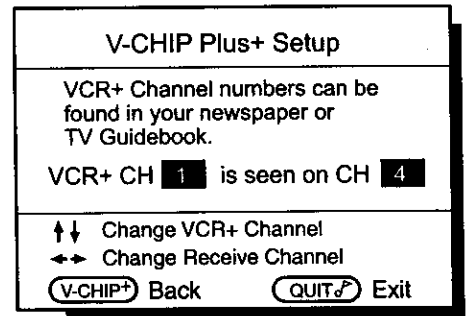
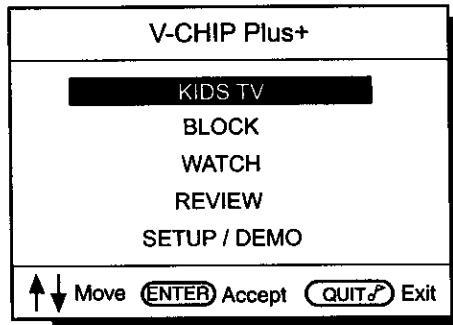

DEMO

- 1 Press V-CHIP+ on the remote control.
- 2 Use the Down arrow to highlight SETUP / DEMO, press ENTER.
- 3 Use the Down arrow to select DEMO, press ENTER.
Watch the demonstration and see the V-CHIP Plus+ options available.
- 4 Press QUIT to turn the demonstration off.

SETUP

Follow the instructions described above but go to the SETUP menu.

- 5 Enter a 4-number password using the NUMBER keypad on the remote control. Repeat the password.
Note: Each time you make a change to the V-CHIP Plus+ Setup, you will need to enter a 4-number password.
- 6 **Channel Mapping** (follow on-screen instructions)
Once the V-CHIP Plus+ Setup menu appears, enter the channel number you receive the network on if it is different than the VCR+ Channel number listed for your local broadcast area. Consult a local TV guide or contact your cable service company.
For example, if the VCR+ Channel number listed for HBO is 1, and you view HBO over Channel 4, then change the "is seen on CH" to number 4. That way when you use the VCR+ PlusCodes to control a program on HBO, the TV will automatically switch and control Channel 4. See typical VCR+ Channels chart above.

IMPORTANT NOTES ABOUT THE 4-NUMBER PASSWORD

REMEMBER YOUR PASSWORD, IT IS THE ONLY WAY YOU CAN USE THE TV. IF YOU FORGET THE PASSWORD, YOU WILL HAVE TO WAIT UNTIL THE 99 HOUR BLOCK TIME HAS EXPIRED BEFORE THE TV WILL BE AVAILABLE FOR USE.

THE SAME PASSWORD WILL BE USED TO ACCESS AND OPERATE THE PARENTAL CONTROL FEATURE.

VCR+ Channel Numbers

HBO	1
ESPN	2
A & E	3
etc.		

(Example of VCR+ Channel Numbers printed in local newspaper or local TV Guide.)

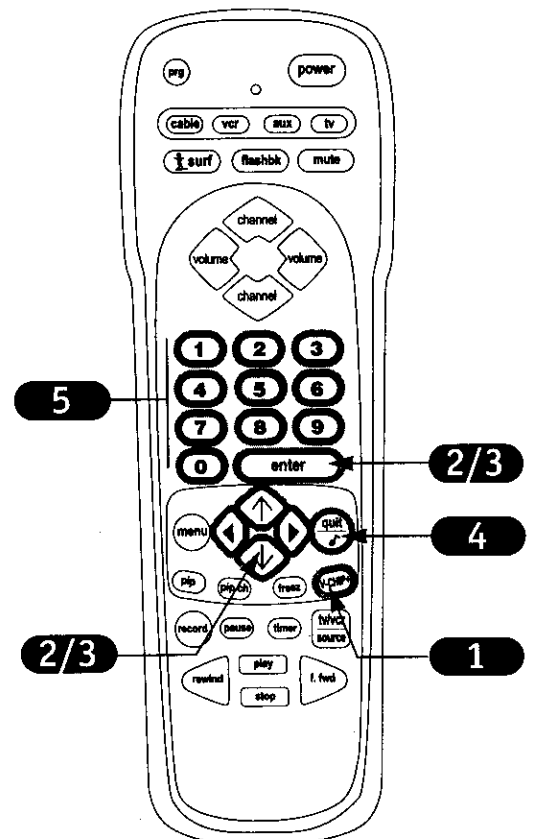

Select (using their VCR+ PlusCodes) programs that you want controlled for Kids TV, Block, or Watch

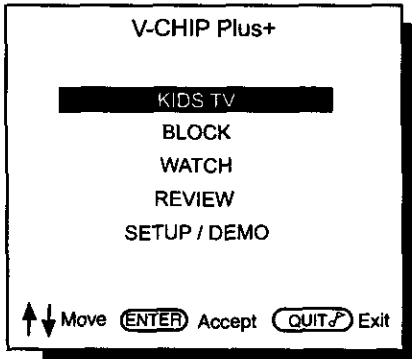

Mon 11:30 a.m. - 12:00 p.m.
Travel World
 Take a tour of Europe by bus,
 with stops at famous castles.
 31426587

Typical program listing including VCR+ PlusCode. Enter numbers on menus.

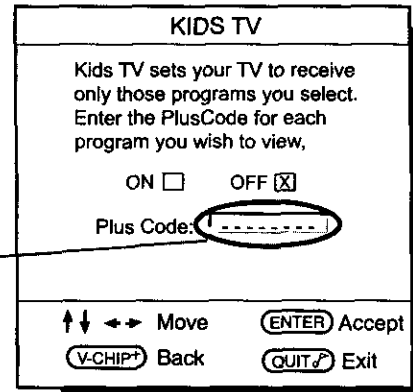

Overview

V-CHIP Plus+ allows you to control the programming which can appear on your TV screen. V-CHIP Plus+ has three options:

- Kid's TV** - Restricts viewing to only up to five programs which can appear on the TV screen.
- Block**- Prevents up to five programs from appearing.
- Watch** - Schedules up to five programs to appear on the TV screen as those programs are broadcast.

Controls Programming Using VCR+ PlusCodes

Although similar to Parental Control, the V-CHIP Plus+ feature use the program's VCR+ PlusCode number which are usually included in your local broadcast area's weekly TV program guide.

Things to Consider Before Using V-CHIP Plus+

- Do you want V-CHIP Plus+ to be active all the time? You can turn the Kid's TV option, on or off.
- Do you want the program to be controlled:
 - Once - Program is controlled one time.
 - Daily - Program is controlled each day, Mon-Sun.
 - Weekly - Program is controlled one time a week.

V-CHIP Plus+ Menu Operation

- Press V-CHIP+ on remote to go to and QUIT to exit the V-CHIP Plus+ menu.
- Use Up, Down, Left, and Right arrows to access options.
- Use NUMBER keypad to enter VCR+ PlusCode numbers.
- Once an option is highlighted, press ENTER to accept the option.
- Press V-CHIP+ to return to previous menu.

 Don't want to allow your family to see a particular R-rated program, select it to be Blocked.

 Don't want to miss the big game, select it to be Watched and it will be tuned to automatically.

 Enter a second weekly time for programs that are broadcast more than once per week; for example, if a program is broadcast on Monday and Wednesday.

 Unhappy with the current selections available in your broadcast area, select only the programs you want to view using the Kid's TV option.

VCR+ PlusCodes

- VCR+ PlusCodes** Your local TV listings usually include a VCR+ PlusCode with programs appearing in your area.
- KIDS TV** Allows you to specify, using their VCR+ PlusCodes, the programs you will allow to appear on your TV.
- BLOCK** Allows you to specify, using their VCR+ PlusCodes, programs you want to prevent from appearing on your TV.
- WATCH** Allows you to schedule programs, using their VCR+ PlusCodes, to appear when they are broadcast; TV will tune to these programs automatically as they are aired.

V-CHIP Plus+ Using the KIDS TV Menu

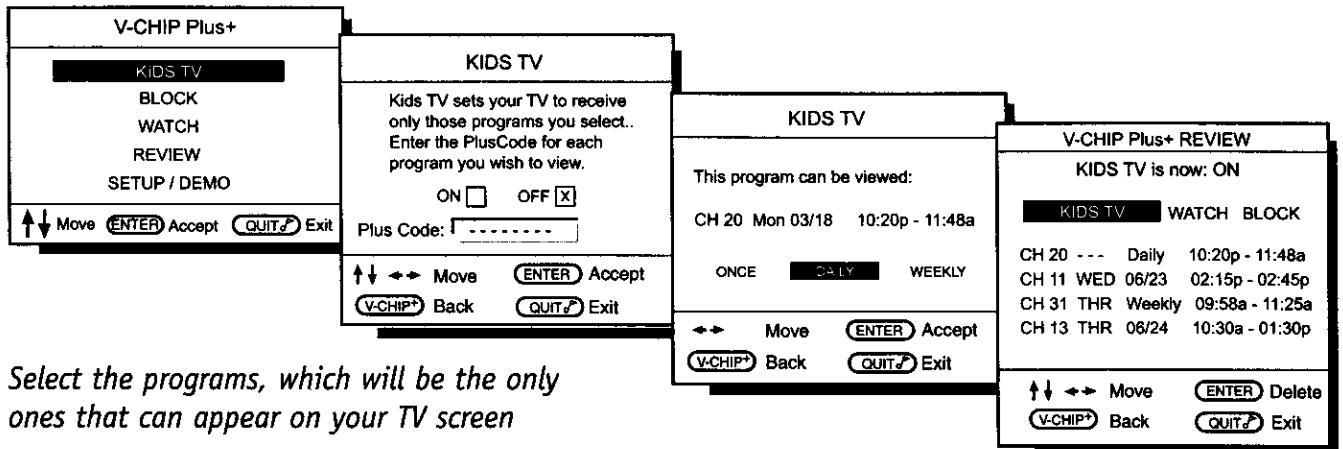

Select the programs, which will be the only ones that can appear on your TV screen

1 Look up the VCR+ PlusCodes for the programs you intend to schedule to be controlled and write them down on a piece of paper.

2 Press V-CHIP+ on the remote to go to the V-CHIP Plus+ menu.

KIDS TV

3 Using the Select Up/Down arrows, highlight the option KIDS TV.

4 Once selected, press ENTER to go to the KIDS TV menu.

5 Using the NUMBER keypad, enter the VCR+ PlusCode of a program you want to control. Press ENTER.

6 Use the Left/Right adjust arrows to choose: Once, Daily, or Weekly. Press ENTER.

Once - Program will appear one time.

Daily - Program will appear each day, Mon - Sun.

Weekly - Program will appear once each week. (See below)

On - KIDS TV will control program.

Off - KIDS TV will not control program.

V-CHIP Plus+ Menu Operation Notes:

Press ENTER to accept your choices.

Press QUIT to return to TV viewing.

Press V-CHIP+ to return to previously selected menu.

To review your selections, highlight REVIEW, then press ENTER.

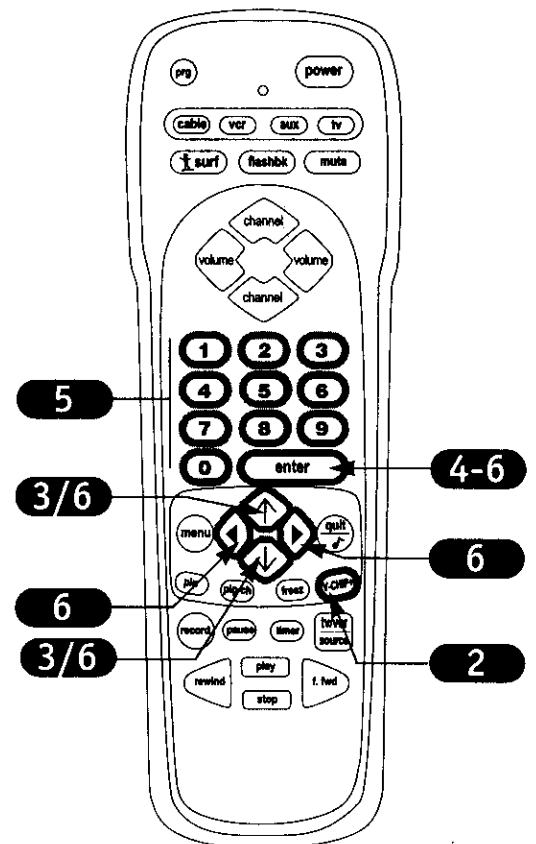

VCR+ PlusCodes Your local TV guide listings usually include a VCR+ PlusCode for programs appearing in your area.

KIDS TV Allows the pre-selected programs to be controlled if KIDS TV is turned on. If KIDS TV is turned off, will not control programs.

WEEKLY For programs appearing more than one time each week, (Monday and Wednesday for example) go to the KIDS TV menu and choose the program's second broadcast day VCR+ PlusCode using the Weekly option to control it the second day that it is broadcast.

V-CHIP Plus+ Using the BLOCK Menu

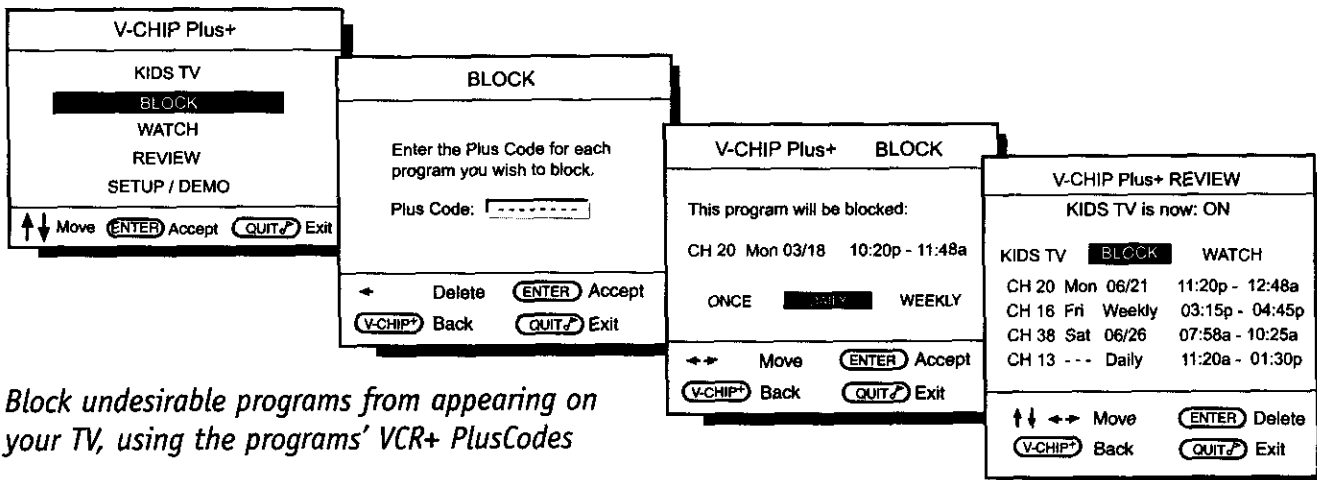

Block undesirable programs from appearing on your TV, using the programs' VCR+ PlusCodes

1 Look up the VCR+ PlusCodes for the programs you intend to schedule to BLOCK and write them down on a piece of paper.

2 Press V-CHIP+ on the remote to go to the V-CHIP Plus+ menu.

BLOCK

3 Using the Select Up/Down arrows, highlight the option BLOCK

4 Once selected, press ENTER to go to the Block menu.

5 Using the NUMBER keypad, enter the VCR+ PlusCode of a program you want to block. Press ENTER.

6 Use the Left/Right adjust arrows to choose: Once, Daily, or Weekly. Press ENTER.

Once - Program will be blocked one time.

Daily - Program will be blocked each day, Mon - Sun.

Weekly - Program will be blocked once each week. (See below)

V-CHIP Plus+ Menu Operation Notes:

Press ENTER to accept your choice.

Press QUIT to return to TV viewing.

Press V-CHIP+ to return to previously selected menu.

To review your selections, highlight REVIEW, then press ENTER.

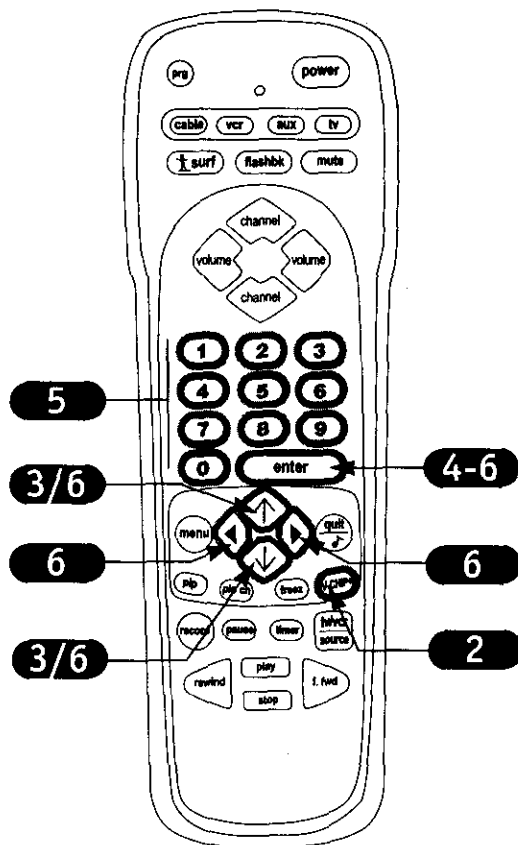

Plus Codes

VCR+ PlusCodes	Your local TV guide listings usually include a VCR+ PlusCode with programs appearing in your area.
BLOCK	Program will not appear on the TV.
WEEKLY	For programs appearing more than one time each week, (Monday and Wednesday for example) go into the Block menu and choose the program's second broadcast day using the Weekly option to block it the second day that it is broadcast.

V-CHIP Plus+ Using the WATCH Menu

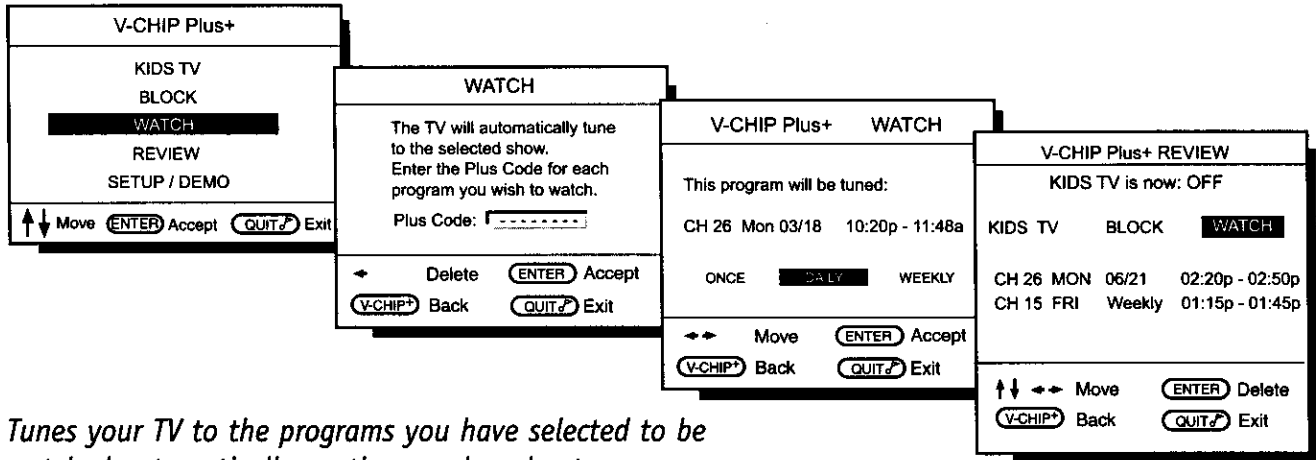

Tunes your TV to the programs you have selected to be watched automatically, as they are broadcast

1 Look up the VCR+ PlusCodes for the programs you intend to schedule to WATCH and write them down on a piece of paper.

2 Press V-CHIP+ on the remote to go to the V-CHIP Plus+ menu.

WATCH

3 Using the Select Up/Down arrows, highlight the option WATCH.

4 Once selected, press ENTER to go to the Watch menu.

5 Using the NUMBER keypad, enter a program's VCR+ PlusCode. Press ENTER.

6 Use the Left/Right adjust arrows to choose: Once, Daily, or Weekly. Press ENTER.

Once - Program will be shown one time.

Daily - Program will be shown each day, Mon - Sun.

Weekly - Program will be shown once each week. (See below)

V-CHIP Plus+ Menu Operation Notes:

Press ENTER to accept your choices.

Press QUIT to return to TV viewing.

Press V-CHIP+ to return to previously selected menu.

To review your selections, highlight REVIEW, then press ENTER.

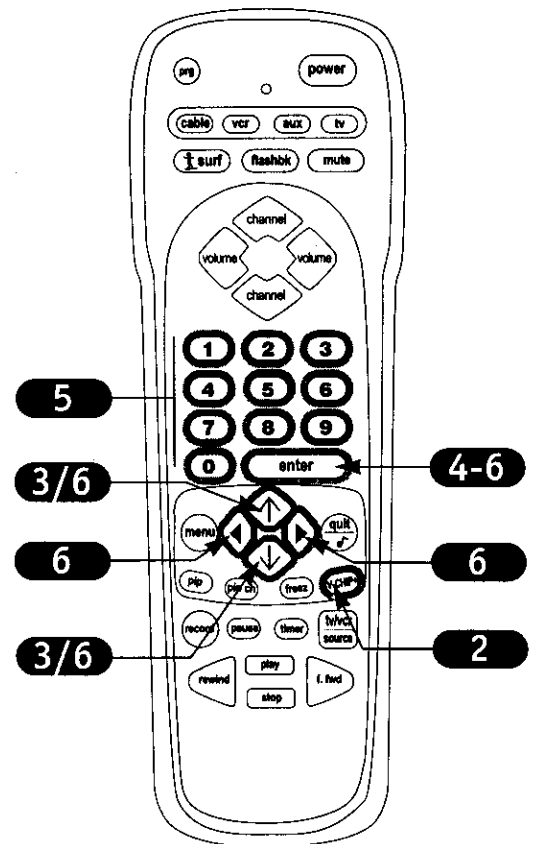

Important

VCR+ PlusCodes Your local TV guide listings usually include a VCR+ PlusCode with programs appearing in your area.

WATCH Program will automatically be tuned to when it is broadcast.

WEEKLY For programs appearing more than one time each week, (Monday and Wednesday for example) go into the Watch menu and choose the program's second broadcast day using the Weekly option to watch it the second day that it is broadcast.

PIP = Picture-In-Picture

Think of PIP as a mini TV screen superimposed onto your main TV screen

YOUR PICTURE-IN-PICTURE FEATURE

The Picture-In-Picture (PIP) function allows you to put a smaller picture, called the "inset," on the bigger screen, or the "main" picture.

Normally you would need some other piece of equipment, like a VCR, to act as a tuner to receive and display a second channel at the same time. Your Entertainment Machine eliminates that need by giving you two tuners on one TV. PIP is always available, no matter what equipment you have.

Don't want to miss any of the big game, but hate commercials? Just put the game in the PIP inset, and surf your favorite channels using the main picture.

WORKING WITH PIP

Just like your Entertainment Machine's main screen, PIP will need a source to take its image from. Set the main screen source to Antenna/Cable, then set the PIP source to Antenna/Cable, as an example. This can be adjusted under the Source menu (see page 34).

PIP can be used in any picture mode. Put Antenna/Cable in the inset while you watch a tape. Attached to Video 1, have a DVD disc going in the PIP inset while you watch a tape on the main screen.

POSSIBLE REASONS FOR ADJUSTING PIP SOURCE

- 1. You want to watch a video tape, but keep scanning for another movie or game. Set the PIP source to VIDEO 1, or 2 and you can watch the VCR and TV, swapping between the two.
- 2. You want to watch your favorite live program on Antenna/Cable on the main picture and when a commercial break appears, swap to the PIP inset which has a videotape in the VCR ready to play, or choose a different channel on Antenna/Cable.



PIP Inset Picture

Main Picture

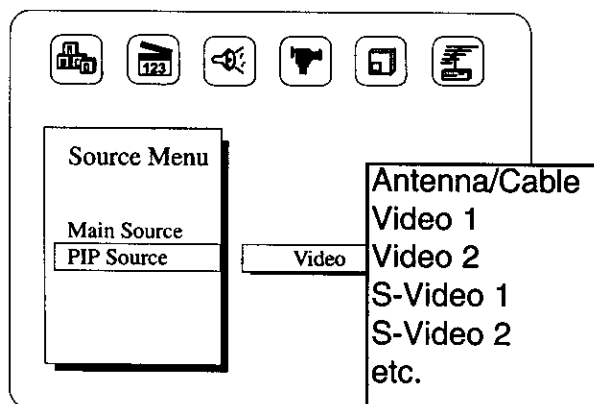

How to use PIP's other features

- 1** Press PIP to place the PIP inset on the main screen. Press PIP again to remove inset.
- 2** With PIP inset on, press PIP ch to switch to PIP inset channel scan, press PIP ch to return channel scan to the main screen.
- 3** With PIP inset on, press FREEZ to freeze the image in the PIP inset, press FREEZ again to resume motion.

WITH PIP ON OPERATIONS

Audio Swap

With no other on-screen menus active, use the QUIT key to switch sound between main picture and the PIP inset; the musical note shows which audio is being heard.

PIP Swap

Use Up/Down arrows to flip PIP image with main picture.

Channels

Press CHANNEL Up/Down to change channels in the PIP inset - - if the source for the PIP inset is Antenna/Cable.

If the source is other equipment connected to the Video 1, or Video 2 jacks, tune channels on that equipment.

PIP Inset Video Source

Press TV/VCR SOURCE to switch video sources for the PIP inset between, Antenna/Cable, Video 1, or Video 2 etc.

Move PIP Inset around Screen

Use the left/right arrows to move the PIP inset to a different location on the main screen.



With PIP on, press FREEZ, the main picture image will be frozen and placed into the PIP inset. (Good for writing down phone numbers that appear on-screen.)

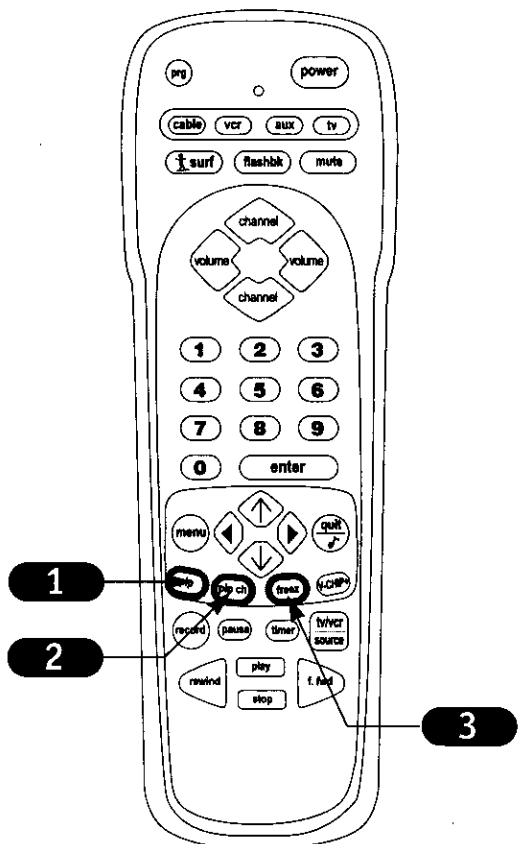

PICTURE

TUNER	Any device that picks up broadcast signals and turns them into picture and sound.
A/V SOURCE	Other equipment connected to the TV source inputs on the TV back connections panel; Video 1, Video 2, S-Video 1, or S-Video 2 etc.

Choosing sources to watch for the Main picture and the PIP Inset picture

1 Press PIP to place the PIP inset on the main screen. Press TV/VCR Source on remote control to switch input source for the PIP inset.

2 Or, go to the Source menu, highlight PIP Source and use RIGHT/LEFT arrows to select PIP inset source. Highlight Main Source and use RIGHT/LEFT arrows to select main picture source.

Main Screen or PIP Inset Sources

You can use:
 Antenna/Cable
 Video 1/S-Video 1
 Video 2/S-Video 2 etc.

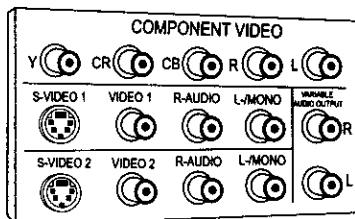

Where "sources" are connected



You can use any input source for the PIP inset that is connected to the TV connections panel. (Antenna/Cable, Video 1, or Video 2 etc.)

Note: If you used the S-Video 1, or the S-Video 2 input, S-VHS 1, or S-VHS 2 will appear as available sources instead of Video 1, or Video 2.



If no equipment is connected to a source you select for the PIP inset, or if it is turned Off, the PIP inset will be black.



PIP Source
 Can be Antenna/Cable and any component connected to any set of audio/video input jacks; such as Video 1, Video 2, S-Video 1, S-Video 2, etc.

Main Picture Source
 Can be Antenna/Cable and any component connected to any set of audio/video input jacks; such as Video 1, Video 2, S-Video 1, S-Video 2, etc.

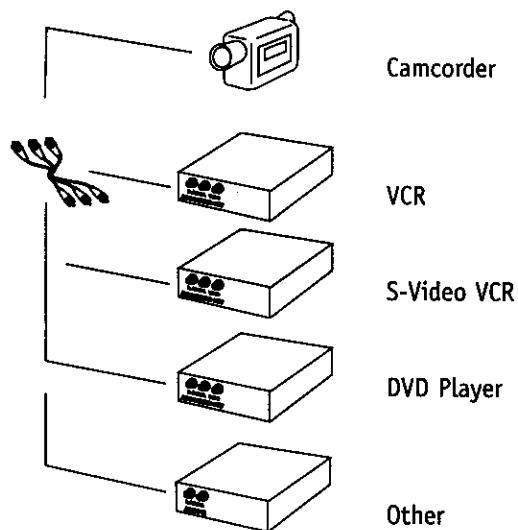

Typical Component Sources

Programming the Remote

Set up your remote to operate other brand name devices

- 1 Turn on the device you want to program.
- 2 On the chart on page 47/48, find the type of device you're programming, and then find the brand name. Make a note of the three-number code, you'll need it soon.
- 3 Press and hold PRG. It's recessed so it doesn't get pushed accidentally. Use a small, blunt object. When the indicator light turns on, you can release PRG.
- 4 Push the key name with the type of device you're programming (VCR, CABLE, AUX, TV).
- 5 Using the NUMBER keypad, enter the three-number code you found on page 47/48.
- 6 Press ENTER to save the code. (The indicator light will flash 3 times, then turn off to indicate the code is valid.)

Point the remote at the device and push POWER. It should turn off. If not, try the other codes listed and continue from step three.

Note: To reset remote to factory settings, enter 9-1-1, in Step 5.

Note: After programming, be sure to press the mode key first to operate the device you have just programmed.



Programming your Zenith remote may allow you to use one remote to work up to 7 different devices.



Not all devices will work with your Zenith remote control.

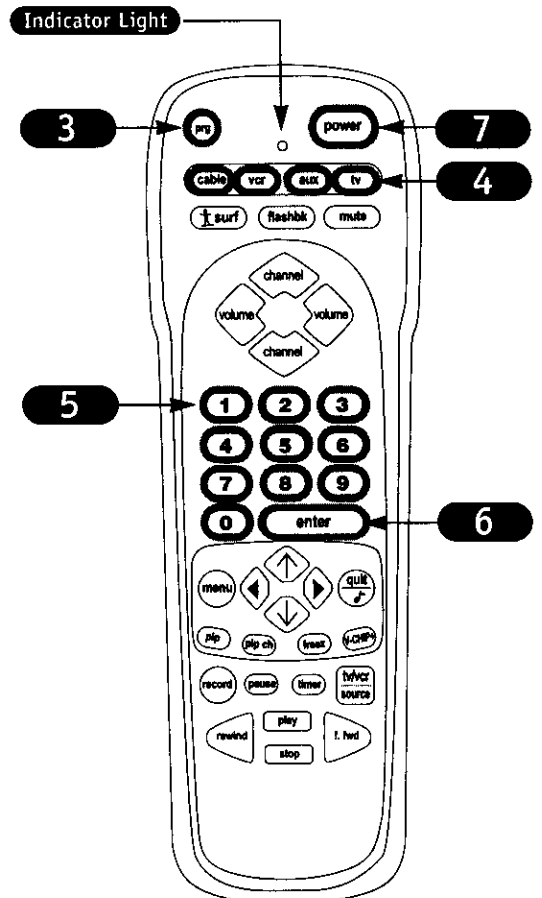

PROGRAMMING	Procedure to set up remote to operate other equipment.
PRG	Programming mode key.
DEVICE	Infra-red remote controllable electronic accessory equipment.

Amplifier Volume Override

Control the volume on your home audio system without changing modes

- 1** Find the code that operates your amplifier. Test it to make sure it's the correct one by following the procedure in "Programming Your Remote" on the previous page.
- 2** Program your audio system into the CABLE or one of the available AUX modes.
- 3** Select the mode you want amplifier volume to appear (e.g. TV).
- 4** Press and hold PRG on your remote until the indicator light stays lit, then release.
- 5** Press 4-9-9; then ENTER on the remote. The indicator light will flash three times the code was accepted.

Audio system volume/mute now appears in the mode selected.

Note: You can also program Cable Box Volume and Mute control (if available) into your cable box mode (CABLE or AUX mode) by repeating the steps for programming on the previous page but entering 3-9-9, instead of a brand code, then pressing ENTER.



To put everything back to normal, reprogram the mode from Step 3 with the original brand code.



If you can't find the code for your amplifier, use the Auto Find feature on page 46.

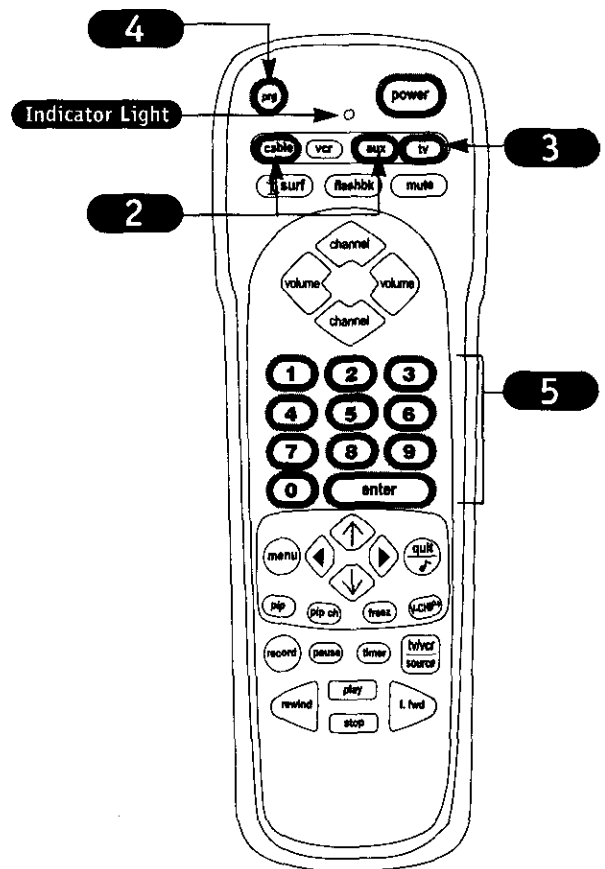

GLOSSARY

AMPLIFIER	Audio device which sends sound to speakers, like an Audio Tuner, Receiver, or Amplifier. See Audio Tuners/Amp list on page 48.
CABLE BOX VOLUME/MUTE	Some cable boxes have volume controls.

Control up to seven different devices with your remote

- 1** Refer to the chart on page 47/48 to find the type and brand name of the device you're programming.
- 2** Press and hold PRG until the indicator light turns on, then release PRG.
- 3** Press AUX and the 1 on the NUMBER keypad at the same time (for AUX +1).
- 4** Using the NUMBER keypad, enter the three-number code for the device you've selected.
- 5** Press ENTER to save the code.
- 6** With the device turned on, point the remote at it and press POWER. It should turn off.
- 7** Repeat the steps for AUX+2, and AUX+3.



Programming your Zenith remote may allow you to use one remote to work up to 7 different products or devices.



Some devices may not work with your Zenith remote control.

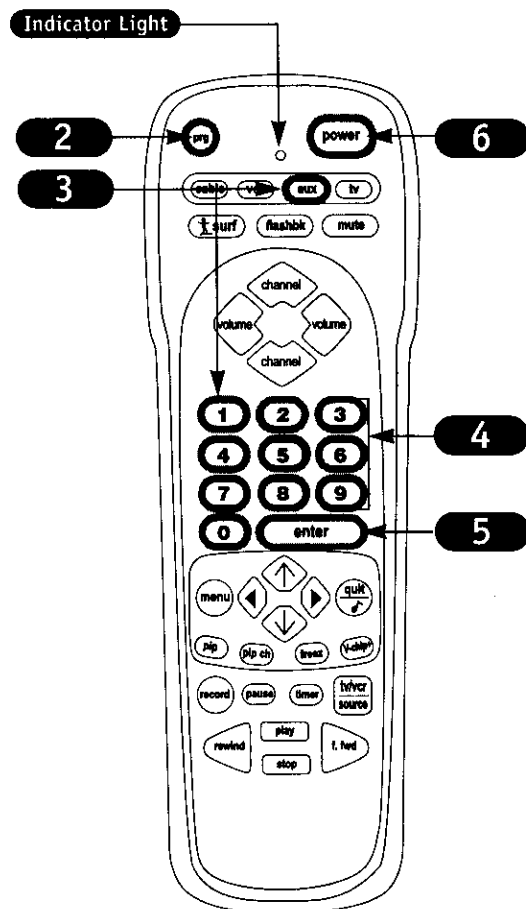

GLOSSARY

AUX Auxiliary equipment. Can be any equipment which does not have a dedicated key on your remote like Cable or VCR. Typically a second VCR, stereo system, audio tape deck, etc.

Remote Control Auto Find

Use Auto Find to automatically search and try all possible brand codes

- 1 Turn on the device you want the remote to control.
- 2 Press and hold PRG until the indicator light turns on, then release PRG.
- 3 Press the key for the device you are trying to program (CABLE, VCR, AUX, TV).
- 4 Press 0-0-0 (zero-zero-zero), then press ENTER right away.
- 5 Aim the remote at the correct device and push the POWER key (The indicator light will turn off while the POWER key is pressed). Allow a second to pass, then push the POWER key again. Repeat until the device turns off.
- 6 Push ENTER to save the code (The indicator light will flash 3 times and then turn off).
- 7 Press POWER to turn the device back on.



You can quickly get out of Auto Find by pressing PRG.



If the indicator light stays on while you press Power instead of turning off, all the codes have been tried and your device can't be controlled.

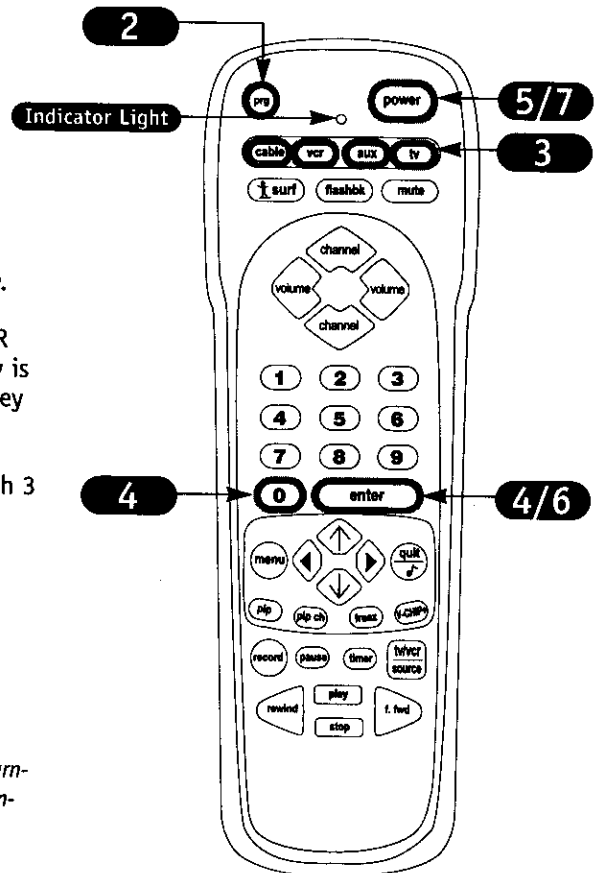

AUTO FIND

Another way of finding a brand code for controlling auxiliary equipment such as a VCR, DVD player, etc. that is not available through the regular remote brand code programming method.

Programming Codes

Find the codes you need to program your remote. On this page: TVs and VCRs

TVs

Admiral	116 121 130 133	Funai TV/VCR	154	MGA/Mitsubishi	104 119 120 130 140 155	Sears	103 108 109 110 111 118 134
Adventura TV/VCR	154	General Electric	106 107 114 116 117 161	Montgomery Ward	103 104 105 113 114 119 121 130 133	Sharp	103 105 122 133 137 156 169
Akai	104	Goldstar	103 104 119 147	NEC	104 119	Signature 2000	103 104 105 113 114 119 121 130 133
Amark	103 146	Goldstar TV/VCR	153	Panasonic	106 107 160 166	Sony	115 143 151 170
AOC	104	Hitachi	102 103 129 163	Panasonic TV/VCR	174	Soundesign	139
Bell & Howell	121	J.C. Penney	104 110 114 117 119	Philco	103 104 112 113 139	Sylvania	112 113 117 119 127 128 139
Broksonic	131 136	JVC	125 132 164	Philips	112 113	Symphonic TV/VCR	154
Candle	139	KMC	103	Pioneer	135	Tatung	106
Centurion	119	KTV	103 104 138	Portland	103	Teknika	103 112 121 124 139
Citizen	121 139	Kurazai	121	ProScan	116 157 162 167	Telerent	103 121
Contec	141	Lodgenet	121	Quasar	106 107	Toshiba	110 111 134 171
Coronado	103	Logik	121	RCA	104 116 126 157 161 162 167 168	XR 1000	121
Crown	103	LXI	133 137	Realistic	105 123 124	Yorx	119
Curtis Mathes	116 119 121	Magnavox	103 112 113 117 119 127 128 139 165	Sampo	119	Zenith	101 149 175
Daewoo	149 159	Magnavox TV/VCR	173	Samsung	103 119 134 141	Zenith TV/VCR	153 154 172
Daewoo TV/VCR	148	Majestic	121	Sanyo	108 109 118		
Daytron	119	Marantz	104 120 155	Scott	119 124		
Elektra	121	Megatron	146				
Emerson	103 104 123 124 131 136 145	Memorex	121				
Emerson TV/VCR	158						
Fisher	109 118						

VCRs

Admiral	208 261	General Electric	214 216 220	NEC	202 218	Sharp	208 261
Adventura	231	Goldstar	209	Orion	250	Shintom	239
Aiwa	231	Go Video	256 262 263	Panasonic	214 251 259	Signature 2000	208 214 216 219 231 249
Akai	223 238 241	Hitachi	215 257	Pentax	215	Sony	217 232 237
Audio Dynamics	202 218	Instant Replay	214 227	Philco	207 214	Sylvania	207 214 227
Bell & Howell	206 247	J.C. Penny	214 215 218 227	Philips	207 214 227	Symphonic	231
Broksonic	221 226 250 255	JVC	202 224 225 258	Pioneer	210 215	Tashiko	209
Canon	214	Kenwood	202	Portland	246	Tatung	202
Citizen	209	Logik	239	ProScan	216 260	Teac	202 231
Craig	212	LXI	*209 231	Quasar	214 259	Teknika	209 234
Curtis Mathes	214 259	Magnavox	207 214 231	RCA	215 216 220 227 240 242 249 260	Toshiba	205 215
Daewoo	244 246 248 254	Marantz	207 218	Realistic	206 208 212 214 231	XR 1000	239
Daytron	236 246	Marta	209	Samsung	220 230 238	Vector Research	204 218
DBX	202 218	Memorex	206 212 214 231	Sansui	239	Yamaha	202 218
Emerson	203 209 221 223 226 233 235 243 250	Mitsubishi	204 222 252 264	Sanyo	206 212 247	Zenith	201 224 225 229 237
Fisher	211 212 213 247	Montgomery Ward	208 214 216 219 231 249	Scott	204 205 233 243		
Funai	231	Multi Tech	239	Sears	206 209 211 212 215		

Programming Codes

Find the codes you need to program your remote.

On this page: Cable, Satellite, CD Players, Tape Decks and Audio Tuners and Amplifiers.

Cable Satellite

Allegro	358 362	Kale Vision	335	RCA DSS	373	Unika	348 362
Allegro A/B Switch	361	Macom	314 321	Regency	329	United Satellite . .	344
Gemini	305 331 338	Magnavox	334	Samsung	335	Universal	358 362
General Electric . .	367	NSC	335 339 368 369 370	Scientific Atlanta	316 323 336 364	Vid Tech	340
General Instrument	304 305 306 307 308 309 310 318	Oak	311 332 342	Sprucer	313	Video Way	349
Hamlin	302 303 345 365 366	Panasonic	313 320	Standard Comp . .	335	Viewstar	354 355 372
Jerrold	304 307 308 309 310 318 360 363	Paragon	333	Stargate	379	Zenith	301 353 374
		Philips	347 350 352 354 355	Texscan	339 356 371	Zenith Satellite . .	312 328 330 351 378
		Pioneer	315 343	Tocom	317 318 346		

Video Disc Players

Pioneer	402 403	Sony	404
Sanyo	401	Zenith	401

Audio CD Players

Akai	409 424		434	Radio Shack	431 436 439 440 441	Teac	446
Crown	410	Mitsubishi	423 424	RCA	437	Technics	432 459
Denon	411	NAD	425 426 447	Sanyo	438 439	Toshiba	447
Fisher	412 438	Nakamichi	427 428	Scott	440	Yamaha	448
Goldstar	460	NEC	429	Sharp	441 442	Zenith	460 461 498 501 502
Harman/Kardon . .	413	Onkyo	430	Sony	443 444 445		
JVC	415	Panasonic	431 432	Soundesign	461 498 501 502		
Kenwood	412 416 417 441	Philips	421 433 434	Sylvania	433		
Magnavox	421 422 433	Pioneer	431 435				
		Quasar	432				

Audio Tape Decks

Denon	455	Onkyo	458
Harman/Kardon . .	456	Philips DCC	454
JVC	457	Pioneer	451 478
Kenwood	450	Sony	452

Audio Tuners/Amps

Denon	462 463	Marantz	472 503	Sanyo	481	Teac	494 495
Fisher	464	Onkyo	473	Scott	482	Technics	497
Goldstar	460	Philips	475 476	Sharp	483	Yamaha	496
Harman/Kardon . .	465	Pioneer	477 478 479	Sony	489 490 491 492	Zenith	460 461 498 501 502
JVC	466	Radio Shack	487 488	Soundesign	461 498 501 502		
Kenwood	468 469	Realistic	480				

Remote Key Functions By Mode

A complete list of key functions for your remote control

KEY NAME	TV Mode Zenith Code 101	VCR Mode Zenith Code 201	Cable Mode Zenith Code 353	AUX Mode Zenith Code 401
POWER	TV On/Off	VCR On/Off	Cable Box On/Off	AUX TV/DISC
CABLE	Selects Cable	Selects Cable	Selects Cable	Selects Cable
VCR	Selects VCR	Selects VCR	Selects VCR	Selects VCR
AUX	Selects Aux	Selects AUX	Selects Aux	Selects AUX
TV	Selects TV	Selects TV	Selects TV	Selects TV
SURF	Surf On/Off	VCR AM/PM	CABLE FC Fav Ch	AUX Audio
FLASHBK	TV Flashback	VCR Flashback	Cable Flashback	AUX Frame/Time
MUTE	TV Mute	TV Mute	TV Mute	TV Mute
CHANNEL UP	TV Channel Up	VCR Channel Up	Cable Channel Up	AUX Skip >>
CHANNEL DN	TV Channel Dn	VCR Channel Dn	Cable Channel Dn	AUX Skip <<
VOLUME (RIGHT)	TV Volume Up	TV Volume Up	TV Volume Up	TV Volume Up
VOLUME (LEFT)	TV Volume Dn	TV Volume Dn	TV Volume Dn	TV Volume Dn
1	TV Digit 1	VCR Digit 1	Cable Digit 1	AUX Digit 1
2	TV Digit 2	VCR Digit 2	Cable Digit 2	AUX Digit 2
3	TV Digit 3	VCR Digit 3	Cable Digit 3	AUX Digit 3
4	TV Digit 4	VCR Digit 4	Cable Digit 4	AUX Digit 4
5	TV Digit 5	VCR Digit 5	Cable Digit 5	AUX Digit 5
6	TV Digit 6	VCR Digit 6	Cable Digit 6	AUX Digit 6
7	TV Digit 7	VCR Digit 7	Cable Digit 7	AUX Digit 7
8	TV Digit 8	VCR Digit 8	Cable Digit 8	AUX Digit 8
9	TV Digit 9	VCR Digit 9	Cable Digit 9	AUX Digit 9
0	TV Digit 0	VCR Digit 0	Cable Digit 0	AUX Digit 0
ENTER	TV Enter	VCR Enter	Cable Enter	Aux Display
MENU	TV Menu	VCR Menu	Cable Menu	AUX Program
UP ARROW	TV Select Up	VCR Select Up	Cable Up Arrow	AUX Part
DOWN ARROW	TV Select Dn	VCR Select Dn	Cable Dn Arrow	AUX Random
LEFT ARROW	TV Adjust Left	VCR Adjust Left	Cable Left Arrow	AUX x3 FAST <
RIGHT ARROW	TV Adjust Right	VCR Adjust Right	Cable Right Arrow	AUX x3 FAST >
QUIT	TV Surr Sound	VCR Quit	Cable Quit	AUX Clear
PIP	TV PIP	VCR+	Day Up	AUX Repeat-Side
PIP CH	TV PIP Channel Swap	VCR Channel Map	Day Down	AUX Repeat-A-B
FREEZ	TV PIP Freeze	VCR Search	Cable Pg Up	AUX Repeat-Chap
V-CHIP+	TV V-Chip+	VCR Memory	Cable Pg Down	AUX Memory
TIMER	TV Timer	VCR Timer	Cable Timer	AUX Still
TV/VCR/SOURCE	TV Sources	TV Tuner or VCR Tuner	Cable Info	AUX TV/Disc
RECORD	VCR Record	VCR Record	Cable Buy	AUX Edit
PAUSE	VCR Pause	VCR Pause	Cable Guide	AUX Pause
REWIND	VCR Rewind	VCR Rewind	VCR Rewind	AUX Scan <<
PLAY	VCR Play	VCR Play	VCR Play	AUX Play
STOP	VCR Stop	VCR Stop	VCR Stop	AUX Stop/Eject
FFWD	VCR Fast Forward	*VCR Fast Forward	VCR Fast Forward	AUX Scan >>



Some of the functions shown above may not be available on your equipment.

Maintenance

Caring for your Entertainment Machine

Early malfunctions can be prevented. Careful and regular cleaning can extend the amount of time you will have with your new Entertainment Machine. Be sure to turn the power off and pull out the plug before you begin any cleaning.

Screen Cleaning

1. Here's a great way to keep the dust off your screen for a while. Wet a soft cloth in a mixture of lukewarm water and a little fabric softener or dish washing detergent. Wring the cloth until it's almost dry, and then use it to wipe the screen.
2. Make sure the excess water is off the screen, and then let it air-dry before you turn on your Entertainment Machine.

Cabinet Cleaning

1. Use a soft cloth with a mild soap solution to wipe the cabinet.
2. Rinse the cloth and wipe the cabinet again.
3. Let the cabinet air-dry before turning your Entertainment Machine on.

Wood Cabinet

Use a quality wood cleaner and polish. This will protect the Entertainment Machine from dirt and dust, as well as keep the cabinet looking new.

Extended Absence



If you leave your Entertainment Machine dormant for a long time (such as a vacation), it's a good idea to unplug the power to protect against possible damage from lightning or power surges. If you use an off-air antenna, you may also want to disconnect it from the back of your TV before leaving.



If you unplug your Zenith Entertainment Machine, you may have to reset the clock using the Clock Set menu described earlier. See page 21.

Trouble Shooting

Some quick and easy tips to fixing problems yourself

SYMPTOMS	SOLUTIONS
Snowy picture and poor sound.	<ul style="list-style-type: none">• Check your antenna connection or location.
Multiple images or 'ghost shadows.'	<ul style="list-style-type: none">• Check your antenna direction and/or location.• Make sure the wire from your antenna to your Entertainment Machine is properly connected.
Interference: Sharp lines across the screen and poor sound.	<p><i>The following may cause image problems or distortion: Electrical appliances, powerful lights, cars, trucks; computers or portable phones; medical equipment</i></p> <ul style="list-style-type: none">• If possible increase the distance between your Entertainment Machine and the offending appliance. Or shut one of them off.
Normal picture but no sound.	<ul style="list-style-type: none">• Check volume levels.• Make sure the TV is not muted.• Try another channel. The problem may be the broadcast, not your Entertainment Machine.• Are the Audio A/V cables properly installed?
No picture and poor sound.	<ul style="list-style-type: none">• Are you in TV or cable tuning mode, and should be in the other?• Make sure output channels on all A/V equipment are on the same channel (3 or 4).• Check that all connections are tight.
No picture and no sound.	<ul style="list-style-type: none">• Is the AC power plugged in?• Check that your AC power outlet works. (Test it by plugging in something else or try another plug.)• Make sure your brightness and audio controls are set properly.• Try another channel. The problem may be with the broadcast.
No color, but the sound is O.K.	<ul style="list-style-type: none">• Check the color control in the Video menu.• Try another channel. The problem may be with the broadcast.
Picture has a big black box on it, but the sound is O.K.	<ul style="list-style-type: none">• Is Text model selected but no text is available on the broadcast?• The CC (closed caption) option may be in Text mode. Select OFF in the Captions menu (see page 22).
Picture has two horizontal black bars, one on top and one on bottom.	<ul style="list-style-type: none">• Your program is in letterbox. This means that the shape of your TV is a square, but the program is a rectangle. Think of the bars as empty space the program doesn't fill; not picture that's blocked out. Because this format is a direct representation of film as you see it in movies, you are actually seeing MORE of the program when you see those bars.
Remote control doesn't work.	<ul style="list-style-type: none">• Make sure the batteries are fresh and installed properly. Does indicator light work, is it nice and bright?• Is remote in TV mode? Press TV for TV mode.
Menu options can't be changed or selected.	<ul style="list-style-type: none">• Try unplugging your Entertainment Machine for a few minutes, then plug it back in. (Don't forget to reset the clock.)
No picture or sound when a non-cable source is selected.	<ul style="list-style-type: none">• Check to see if the source equipment has been turned on.• Make sure that the connections are secure on the back of your TV and on the source.

Trouble Shooting continued

Menu options can't be changed or selected.

- Try unplugging your Entertainment Machine for a few minutes, then plug it back in. (Don't forget to reset the clock.)

No picture or sound when any non-cable source is selected.

- Check to see if the source equipment has been turned on.
- Make sure that the connections are secure on the back of your TV and on the source equipment.

Weak or no Stereo Sound when using a stereo VCR.

- Check to see if all the connections are secure.
- Look in the Audio mode menu to see if all the settings are correct.

The PIP inset is black or lacks contrast when VIDEO 1 is the PIP source.

- You might want to adjust the PIP picture settings under the PIP menu.
- Check that all the wires are connected properly.
- PIP source turned on?

The PIP inset is "snow" when the source is Antenna/Cable, Video 1, or Video 2.

- Look to see if the TV/VCR button on your VCR has the TV selected.

There is no picture in the PIP inset when using VIDEO 1 for the PIP and Antenna/Cable for the main picture.

- Look to see if the TV/VCR button on your VCR has the TV selected.

With no key presses, on-screen menus continue to appear.

- EZ Demo feature is operating. Turn EZ Demo off in the Special Features menu.

V-CHIP Plus+ doesn't work.

- Are Kid's TV, Block, or Watch options set? Is Kid's TV set to Off?

Can only watch five programs.

- Is Kid'sTV set to On, restricting programming which can be viewed to only 5 programs?

Can't tune to programs listed in TV guide.

- Is Block option not allowing programs to appear?
- Parental Control set to block rating?

Another program starts as I am watching a different one.

- Is Watch option set to tune TV to the program which started?

Parental Control doesn't work.

- Has Timer expired. Lock on/off turned Off? No hours set?

Can't watch TV or VCR.

- Is Parental Control block on? Are Aux inputs blocked? Do you know the password to unblock Parental Control or V-CHIP Plus+?

Programs with a rating of PG-13, R NC-17, and X do not appear.

- Is Parental Control or V-Chip+ set to block programs with those ratings.

Can't view TV-PG program.

- Is PG set to be blocked in Parental Control? Reset restrictions to PG-13, then PG programs will appear.

TV turns itself off, or on by itself.

- Sleep Timer set to turn TV off.
- Is the On/Off Timer set to turn TV on and off at preset times?
- Power Failure?.

A list of definitions for some of the words found in this guide

A/V CABLES	Audio and Video cables. Three cables bunched together—Right audio (red), Left audio (white), and Video (yellow). A/V cables are used for stereo playback of video-cassettes and for higher quality picture and sound from other A/V devices.	MONO SOUND	Mono (monaural) sound is one channel of sound. On more than one speaker all the speakers play the same audio.
A/V DEVICE	Equipment that produces picture and sound (VCR, DVD, cable box, or television).	OHM RF CABLE	The wire that comes from an off air antenna or cable service provider. Each end looks like a hex shaped nut with a wire sticking through the middle, and it screws onto the large threaded jack on the back of your TV.
ADD	Includes channels that you want to watch in addition to the channels found by EZ Program.	OUTPUT	Refers to the jack that sends a signal out of a VCR, DVD, or other A/V device.
AMPLIFIER	An external device that amplifies sound from a television, CD player, VCR, DVD, etc.	PIP	This is the most common way to refer to the Picture-in-Picture (PIP) option.
ANTENNA	The physical receiver of television signals sent over the air. A large metal piece of equipment does not always have to be visible for your home to be using an antenna.	SECOND AUDIO PROGRAMMING/SAP	Second Audio Programming (SAP) is another, separate, audio channel available with some programming. Choosing 2nd Audio/SAP often refers to listening to audio in another language, such as Spanish or French.
CABLE	Cable Box operating mode on the remote.	SIGNAL	Picture and sound traveling through cable, or over the air, to your television screen.
CABLE SERVICE	Programming provided by a cable company.	SOURCE	The term for the equipment or connection that provides audio and video (picture and sound) to your Entertainment Machine. VCR, DVD players, or Cable Boxes are examples of sources.
CAPTIONS/TEXT	A form of subtitling that writes out the dialog for your program.	STEREO SOUND	Stereo (Stereophonic) sound refers to audio that's divided into right and left sides or channels.
DELETE	Remove channels that you don't watch from the channels found by EZ Program.	SURF	Use the Surf feature to create a special list of your favorite channels. You can access the "Surf" channels by pushing SURF on the remote.
ICON	A small picture on your screen representing a function or menu item.	TUNER	Device that picks up broadcast signals and turns them into picture and sound.
INPUT	Refers to the jack that receives a signal into the TV, VCR or other A/V device.		
JACK	A connection on the back of a TV, VCR, or other A/V device. This includes the RF jack that is threaded with a place for a small wire in the center, and the Audio/Video jacks that have a bigger opening and are color-coded.		
MODE	The equipment that the remote control is currently controlling (TV, VCR, Cable, etc.) is the remote's operating "mode."		

EZ Help provides access to the EZ Features in one convenient on-screen menu

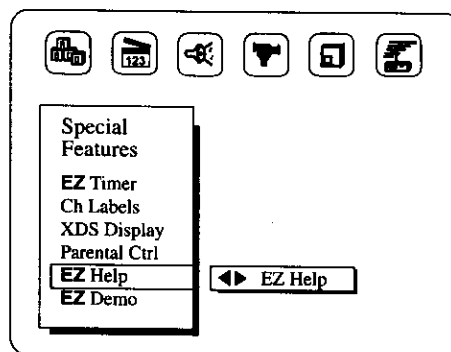

- 1** Press MENU repeatedly until the Special Features menu appears.
- 2** Use the Up/Down arrow to select EZ Help.
- 3** Press the Right arrow to go to the EZ Help menu.
- 4** Use the Up/Down arrow to select the option, and the Left/Right arrow to make adjustments. Choose from the following options:

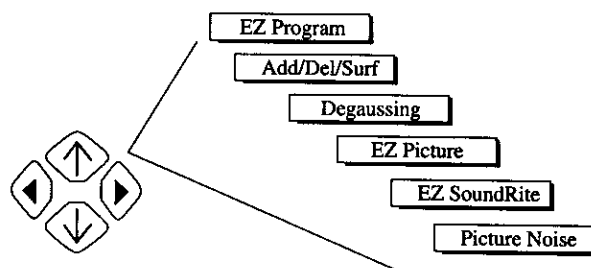

EZ Program

Performs channel search.
See page 13.

Add/Delete/Surf

Includes and removes channels and adds channels to the Surf channel list.
See page 20.

Degaussing

Resets the picture color alignment.

EZ Picture

Adjusts picture viewing setting.
See page 32.

EZ SoundRite

Maintains an even sound level.
See page 31.

Picture Noise

Removes video noise from picture.

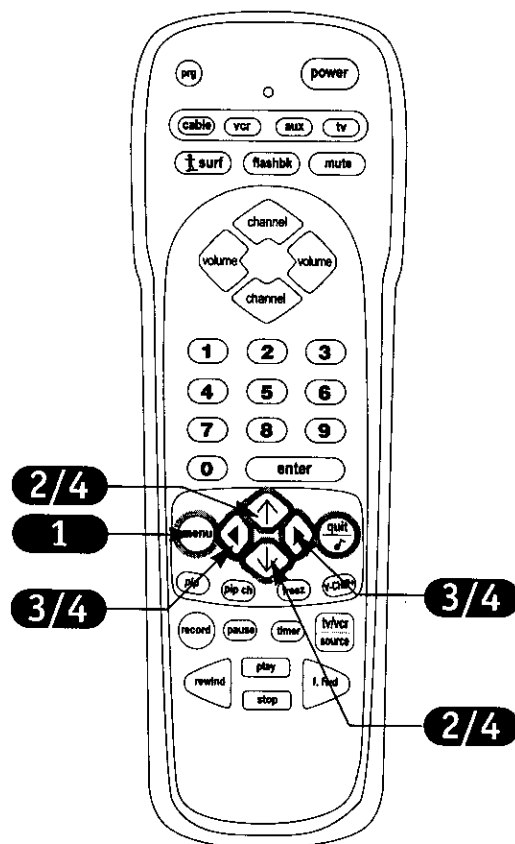

Recommended Video Accessories

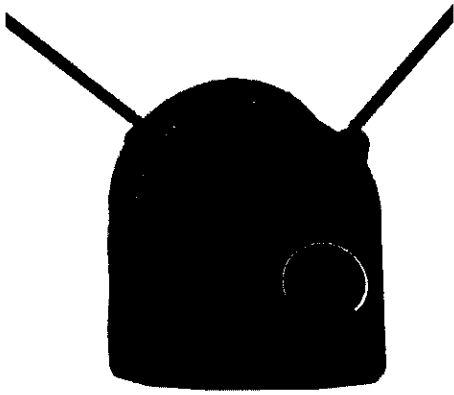

INDOOR AMPLIFIED ANTENNA

Receive Local programming NOT available on your Satellite system!!! Perfect backup antenna for cable outages. Enhanced quality picture and stereo sound in weak signal areas.

- Amplified VHF/UHF/FM Antenna includes 4 feet of 75 ohm cable for easy hookup.

ATS 775 **ONLY \$34.95** PLUS \$6.95 SHIPPING & HANDLING

TELEVISION WALL MOUNTS

Set up your game room or spare room in style!! Sturdy black wall mounts keep the TV off your furniture and in easy view. All mounts have 90 degree and 10 degree tilt angles.

- ALGW27 fits most 25" to 27" TVs - **ONLY \$59.99**
- ALGW20 fits most 19" and 20" TVs - **ONLY \$49.99**
- ALGW13 fits most 13" Televisions - **ONLY \$39.99**

Available in White, just add "-WH" to part number (e.g. ALGW27-WH)

FOR ALL ORDERS ADD \$6.95
SHIPPING & HANDLING

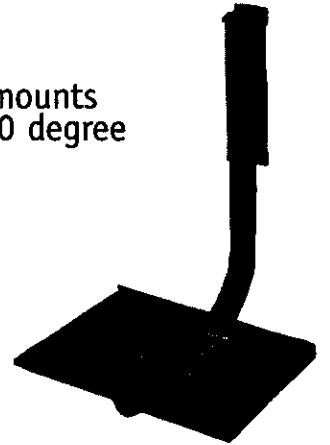

ZENITH 5 FUNCTION REMOTE

Broken or lost remote? Need a second remote or more functions? Order direct from Zenith!!

- Operates TV, VCR, CD, DVD, DIVX, DSS & Cable Box
- Operates PIP and Most Screen Menus
- Extended Range & MORE!!!

Orders 1 year or more after product purchase may receive upgraded models. Other Remotes with 3, 4, 5 & 7 Functions Available Upon Request

ZEN 525 **ONLY \$19.99** PLUS \$6.95 SHIPPING & HANDLING

ORDER TODAY!
CALL OR FAX TOLL-FREE
1.800.255.6790
Fax 1.888.693.6484
email: parts.sales@zenith.com

zenith



Use Your Visa or MasterCard to Order

PLEASE ALLOW 3-4 WEEKS FOR DELIVERY



Your Zenith Direct-View TV Warranty

Direct-View Color TV Welcome to the Zenith family! We believe that you will be pleased with your new Zenith Entertainment Machine™. Please read this warranty carefully, it is a "LIMITED WARRANTY" as defined under Federal Law. This warranty gives you specific legal rights, and you may also have other rights that vary from state-to-state within the U.S.A.

ZENITH'S RESPONSIBILITY

- Service Labor** During a period of 90 days from effective warranty date, Zenith will provide service labor by a Zenith authorized service center when needed, as determined by the Zenith service center, as a result of manufacturing defects.
- Parts** New or remanufactured replacements for factory-defective parts will be supplied by a Zenith authorized service center for one year from effective warranty date (color picture tube — two years). Such replacement parts are warranted for the remaining portion of the original warranty period.
- Home Service** Warranty service for 21" diagonal (U.S.A.) or larger screen size models is provided in the home in most cases. (Some repairs may require the unit to be taken by the servicer to the repair facility and returned, at no additional charge.)
- Not Covered** This warranty covers manufacturing defects and does not cover installation, adjustment of customer controls in the home, installation or repair of home antenna systems, cable converters or cable company-supplied equipment; it also does not cover damage due to misuse, abuse, negligence, acts of God or other causes beyond the control of Zenith. Any alteration of the product voids this warranty in its entirety.

THIS WARRANTY IS IN LIEU OF ANY OTHER WARRANTY, EXPRESSED OR IMPLIED, INCLUDING WITHOUT LIMITATION, ANY WARRANTY OF MERCHANTABILITY OR FITNESS FOR A PARTICULAR PURPOSE, AND ZENITH SHALL NOT BE LIABLE FOR ANY CONSEQUENTIAL, INDIRECT, OR INCIDENTAL DAMAGES OF ANY KIND, INCLUDING LOST REVENUES OR PROFITS IN CONNECTION WITH THIS PRODUCT. SOME STATES DO NOT ALLOW LIMITATIONS ON HOW LONG AN IMPLIED WARRANTY LASTS OR THE EXCLUSION OR LIMITATION OF INCIDENTAL OR CONSEQUENTIAL DAMAGES, SO THE ABOVE LIMITATIONS OR EXCLUSIONS MAY NOT APPLY TO YOU.

OWNER'S RESPONSIBILITY

- Effective Warranty Date** Warranty begins on the date of original consumer purchase. For your convenience, keep the dealer's dated bill of sale or delivery ticket as evidence of the purchase date.
- Operating Guide** Read your Operating Guide carefully so that you will understand the operation of your set and how to adjust the customer controls.
- Carry-In Service** Models under 21" diagonal (U.S.A.) screen size must be taken to a Zenith authorized service center for warranty service and must be picked up by the owner.
- Antenna** Reception problems caused by inadequate home antenna or faulty antenna connections are the owner's responsibility.
- Important** Product Registration—Please fill out and mail your Product Registration Card. It is imperative that Zenith know how to reach you promptly if we should discover a safety problem that could affect you.
- Warranty Service** For warranty service information, contact any Zenith authorized service center. Parts and service labor that are Zenith's responsibility (see above) will be provided without charge. Other service is at the owner's expense. If you have any problem in obtaining satisfactory warranty service, call or write the Zenith Response Center. You must provide the model number, serial number and date of purchase or date of original installation. Before you ask for warranty service, read "Maintenance And Troubleshooting" in your operating guide. You might avoid a service call.

ZENITH ELECTRONICS CORPORATION
Zenith Response Center
201 James Record Rd., Building 3
Huntsville, AL 35824
Telephone (256) 772-1515
Mon-Fri, 7:00 a.m.-8:00 p.m. CST
Sat, 8:00 a.m.-5:00 p.m. CST •
www.zenith.com

ZENITH CONSUMER SERVICES

801 E. Roosevelt Rd.
Lombard, IL 60148
Telephone (630) 705-2830

Home & Carry-in Service
Television/VCR
Parts and Accessories
PTV/Camcorders

201 James Record Rd.
Building 4
Huntsville, AL 35824
Telephone (256) 774-4025
Service Hours:
M-F 8-6, Sat 9-2
Will accept UPS shipments

Additional Zenith Picture Tube Protection Plan Available

Zenith offers you the opportunity to obtain additional long-term protection against failure of the picture tube in your new television. Our Picture Tube Protection Plan enables you to avoid any unexpected picture tube repair expenses and keep your television in top condition. It guarantees you a genuine Zenith replacement picture tube and service from a Zenith authorized service center.



Be sure to send in the Product Registration Card. We will send you an application for the Protection Plan near the expiration of the two-year manufacturer's warranty on the picture tube. For additional information call (256) 774-4088.