

machine numbers | VRB211 | VRB411 | VRB412 | VRB421

Zenith



As an ENERGY STAR® Partner, Zenith Electronics Corporation has determined that this product meets the ENERGY STAR® guidelines for energy efficiency.

operating guide / warranty

RECORD YOUR MODEL NUMBER
(Now, while you can see it)

The model and serial number of your new VCR are located on the back of the VCR cabinet. For your future convenience, we suggest that you record these numbers here:

MODEL NO. _____

SERIAL NO. _____



WARNING:

TO REDUCE THE RISK OF ELECTRIC SHOCK DO NOT REMOVE COVER (OR BACK). NO USER SERVICEABLE PARTS INSIDE. REFER SERVICING TO QUALIFIED SERVICE PERSONNEL.



The lightning flash with arrowhead symbol, within an equilateral triangle, is intended to alert the user to the presence of uninsulated "dangerous voltage" within the product's enclosure that may be of sufficient magnitude to constitute a risk of electric shock to persons.



The exclamation point within an equilateral triangle is intended to alert the user to the presence of important operating and maintenance (servicing) instructions in the literature accompanying the appliance.

WARNING:

TO REDUCE THE RISK OF FIRE OR ELECTRIC SHOCK, DO NOT EXPOSE THIS APPLIANCE TO RAIN OR MOISTURE.

POWER CORD POLARIZATION:

CAUTION: To Prevent Electric Shock, match wide blade of plug to wide slot, fully insert.

ATTENTION: Pour éviter les chocs électriques, introduire la lame la plus large de la fiche dans la borne correspondante de la prise et pousser jusqu'au fond.

NOTE TO CABLE/TV INSTALLER:

This reminder is provided to call the cable TV system installer's attention to Article 820-40 of the National Electric Code (U.S.A.). The code provides guidelines for proper grounding and, in particular, specifies that the cable ground shall be connected to the grounding system of the building, as close to the point of the cable entry as practical.

REGULATORY INFORMATION:

This equipment has been tested and found to comply with the limits for a Class B digital device, pursuant to Part 15 of the FCC Rules. These limits are designed to provide reasonable protection against harmful interference when the equipment is operated in a residential installation. This equipment generates, uses and can radiate radio frequency energy and, if not installed and used in accordance with the instruction manual, may cause harmful interference to radio communications. However, there is no guarantee that interference will not occur in a particular installation. If this equipment does cause harmful interference to radio or television reception, which can be determined by turning the equipment off and on, the user is encouraged to try to correct the interference by one or more of the following measures:

- Reorient or relocate the receiving antenna.
- Increase the separation between the equipment and receiver.
- Connect the equipment into an outlet on a circuit different from that to which the receiver is connected.
- Consult the dealer or an experienced radio/TV technician for help.

CAUTION:

Do not attempt to modify this product in any way without written authorization from Zenith Electronics Corporation. Unauthorized modification could void the user's authority to operate this product.

This class B digital apparatus meets all requirements of the Canadian Interference-Causing Equipment Regulations.

"Ce appareil numérique de la class b respecte toutes les exigences du Règlement sur le matériel brouilleur du Canada."

Zenith is a trademark of ZEC © Copyright Zenith Electronics Corporation 1999

IMPORTANT SAFETY INSTRUCTIONS

These simple precautions will help ensure that you get many years of safe enjoyment from your new product.

- 1. Read Instructions**
Read all of the safety and operating instructions before operating the product.
- 2. Retain Instructions**
Keep all safety and operating instructions for future reference.
- 3. Heed Warnings**
Follow warnings on the product and in the operating guide.
- 4. Follow Instructions**
Follow all operating and use instructions.
- 5. Cleaning**
Unplug this product from the wall outlet before cleaning. Do not use liquid cleaners or aerosol cleaners. Use a damp cloth for cleaning.
- 6. Attachments**
Do not use attachments not recommended by product manufacturer as they may cause hazards.
- 7. Water and Moisture**
Do not use this product near water—for example, near a bathtub, wash bowl, sink, or laundry tub, in a wet basement, or near a swimming pool.
- 8. Accessories**
Do not place product on an unstable cart, stand, tripod, bracket, or table. Product may fall, causing serious injury to a child or adult, and serious damage to the product. Use only with a cart, stand, tripod, bracket, or table recommended by the manufacturer or sold with the product. Any mounting of product should follow manufacturer's instructions and should use a mounting accessory recommended by manufacturer.
- 9. Transporting Product**
Move product and cart combinations with care. Quick stops, excessive force, and uneven surfaces may cause product and cart combination to overturn.
- 10. Ventilation**
Slots and openings in cabinet must not be blocked or covered. They are provided for ventilation, to ensure reliable operation, and to protect from overheating. Never block openings by placing product on a bed, sofa, rug, or other similar surface. Do not place product in built-in installation such as a bookcase or rack unless proper ventilation is provided or manufacturer's instructions have been adhered to.



- 11. Power Sources**
Operate product only from type of power source indicated on marking label. If you are not sure of the type of power supply to your home, consult your product dealer or local power company. For products intended to operate from battery power or other sources, refer to manual.
- 12. Line-Cord Polarization**
Product is equipped with a polarized alternating-current line plug (a plug having one blade wider than the other). As a safety feature, this plug will fit into power outlet only one way. If you're unable to insert plug fully into outlet, try reversing the plug. If plug still fails to fit, contact an electrician to replace your obsolete outlet. Do not defeat safety purpose of polarized plug.
- 13. Power-Cord Protection**
Route power-supply cords so they are not likely to be walked on or pinched by items placed upon or against them, paying particular attention to cords at plugs, convenience receptacles, and the point where they exit from product.
- 14. Outdoor Antenna Grounding**
If an outside antenna or cable system is connected to this product, be sure antenna or cable system is grounded so as to provide some protection against voltage surges and built-up static charges. Article 810 of the National Electrical Code (USA), ANSI/NFPA 70 provides information on grounding of mast and supporting structure, grounding of lead-in wire to an antenna discharge unit connection to grounding electrodes, and requirements for grounding electrode. (See Fig. 1 below.)

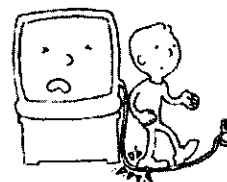
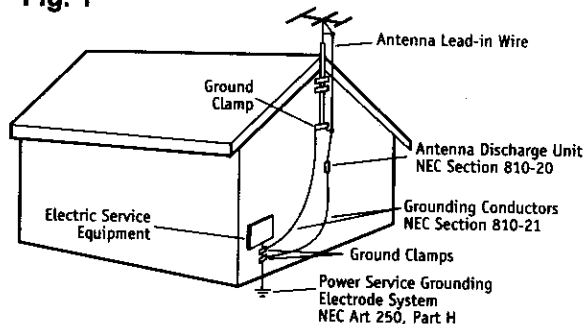

Fig. 1



NEC: National Electrical Code
Antenna grounding per NEC Code, ANSI/NFPA 70

IMPORTANT SAFETY INSTRUCTIONS

These simple precautions will help ensure that you get many years of safe enjoyment from your new product.

15. Lightning

For added protection for this product during a lightning storm, or when product is left unattended and unused for long periods of time, unplug it from the wall outlet and disconnect antenna or cable system. This will prevent damage to product due to lightning and power line surges.

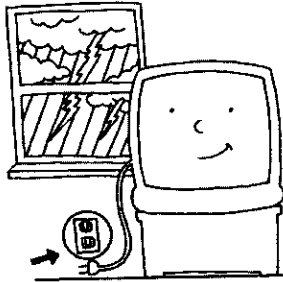

16. Power Lines

An outside antenna system should not be located in the vicinity of overhead power lines or other electric light or power circuits, or where it can fall into such power lines or circuits. When installing an outside antenna system, take extreme care to keep from touching such power lines or circuits, as contact with them might be fatal.

17. Overloading

Do not overload wall outlets, extension cords or integral convenience receptacles, as this can result in risk of fire or electric shock.

18. Object and Liquid Entry

Never push objects of any kind into this product through openings, as they may touch dangerous voltage points or short-out parts that could result in fire or electric shock. Never spill liquid of any kind on product.

19. Servicing

Do not attempt to service this product yourself, as opening or removing covers may expose you to dangerous voltage or other hazards. Refer all servicing to qualified service personnel.

20. Wall or Ceiling Mounting

Mount product to wall or ceiling only as recommended by manufacturer.

21. Replacement Parts

When replacement part(s) are required, be sure service technician has used replacement part(s) specified by manufacturer or have same characteristics as original part(s). Unauthorized substitutions may result in fire, electric shock, or other hazards.

22. Damage Requiring Service

Unplug this product from the wall outlet and refer servicing to qualified service personnel under these conditions:

- If power-supply cord or plug is damaged.
- If liquid has been spilled or objects have fallen into product.
- If product has been exposed to rain or water.
- If product doesn't operate normally by following handbook instructions. Adjust only those controls covered by handbook instructions; improper adjustment of other controls may result in damage and often requires extensive work by a qualified technician to restore product to normal operation.
- If product has been dropped or cabinet has been damaged.
- If product exhibits a distinct change in performance.

23. Heat

Keep product away from heat sources such as radiators, heat registers, stoves, or other products (including amplifiers) that produce heat.

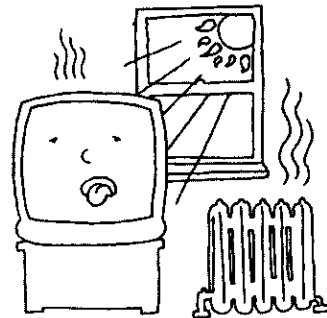

24. Safety Check

Upon completion of any service or repairs to this product, ask service technician to perform safety checks to determine that product is in proper operating condition.

Contents/Index

CONTENTS

SAFETY TIPS 2-4

INSTALLATION 6-12

 VCR Features Chart 6

 Connections for Your VCR 7-8

 Before you operate your VCR 9-12

CONTROLS AND DISPLAYS 13-14

 Front Panel Diagram 13

 VCR Status Displays 14

OPERATION 15-27

 The Buttons on Your Remote 15

 Clock Menu 16

 Timer Menu 17

 Setup Menu 18

 Audio Menu 19

 Watching TV Through the VCR 20

 Camcorder Connected to VCR 21

 Playing Tapes 22-23

 Instant Recording 24-26

 Recording While You're Away 27

TROUBLESHOOTING 28-30

SPECIFICATIONS 31

INDEX

Audio Menu 19

Auto Channel Search 11, 18

Connections 7-8, 21

Channel Add/Del 11, 18

Clock Set 11, 16

Features Chart 6

Front Panel Diagram 13

Instant Recording 24-26

Language Menu 18

Main Menus 9

Playing Tapes 22-23

Remote Control 15

Safety Information 2-4

Setup Menu 18

SpeakEZ Function 10

Timer Menu 17

Timer-Controlled Recording 27

Troubleshooting 28-30

VCR Status Displays 14

Warranty 36

Watching TV through the VCR 20

VCR Features Chart

This page shows the features of your VCR and the differences between the models.

FEATURES	VRB211	VRB411	VRB412	VRB421
SpeakEZ Function	English	English	English/Spanish	English
2-Heads	X	N/A	N/A	N/A
4-Heads (Special Video Effects)	N/A	X	X	X
Full Load/Quick Start	X	X	X	X
Auto Head Cleaner	X	X	X	X
Audio System	Monaural	Monaural	Monaural	MTS Hi-Fi Stereo
Audio/Video (A/V) Jacks	Monaural	Monaural	Monaural	Stereo
Remote Control SC411Z	X	X	X	X
Auto/Manual Band Select	X	X	X	X
Auto/Manual Channel Search	X	X	X	X
Channel Capability (CATV & TV)	181	181	181	181
Record Speeds SP/EP	X	X	X	X
Playback Speeds SP/LP/EP	X	X	X	X
Auto Playback System	X	X	X	X
Auto/Manual Digital Tracking	X	X	X	X
Instant Recording	X	X	X	X
Timer-Controlled Recording	X	X	X	X
Auto Playback Tape Speed Adjust	X	X	X	X
Forward/Reverse Slow-Motion Video (4-head VCR)	N/A	X Variable 1/10 to 1/32	X Variable 1/10 to 1/32	X Variable 1/10 to 1/32
Pause/Still Video	Noise	Clear	Clear	Clear
Real-Time Tape Counter	X	X	X	X
Speed Search	X	X	X	X
CM Skip	X	X	X	X
English/Spanish/French Menus	X	X	X	X
1-Year, 8-Event Timer	X	X	X	X
LED Clock Front Panel Indicator	X	X	X	X
Auto Clock Set System	X	X	X	X
Hook-up Cable (VCR to TV)	X	X	X	X
Energy Saving	X	X	X	X

1. Model VRB421 is used for the description, operation, and details provided in this operating guide.
2. VCR design and specifications are subject to change without prior notice.

X = Feature is provided N/A = Feature is Not Available

Connections for your VCR

Required connections for your VCR.

Connections Without a Cable Box

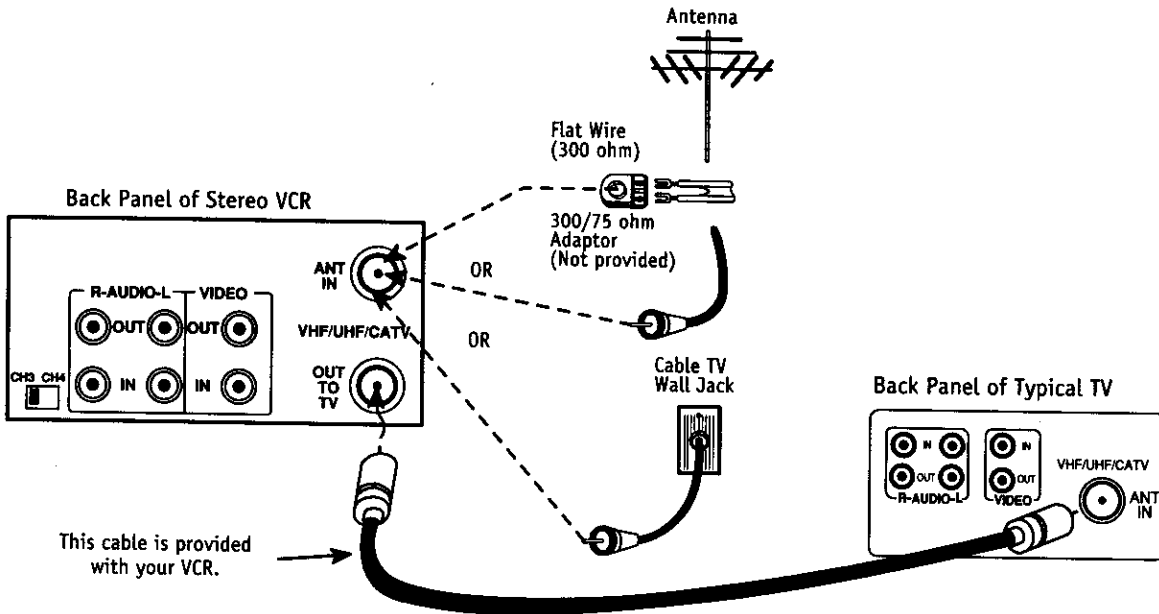

! Turn off power or unplug VCR before making any connections.

Connections With a Cable Box

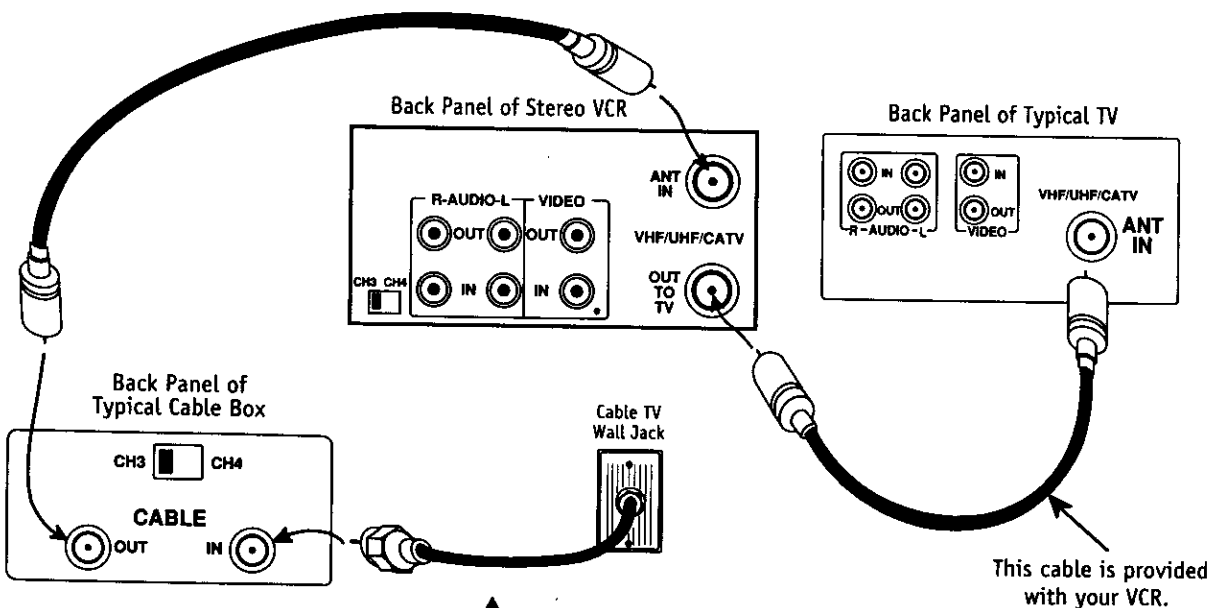

! Turn off power or unplug VCR before making any connections.

Connections for your VCR

Optional connections for your VCR.

Audio/Video (A/V) Connections to TV

Use A/V connections for a better picture.

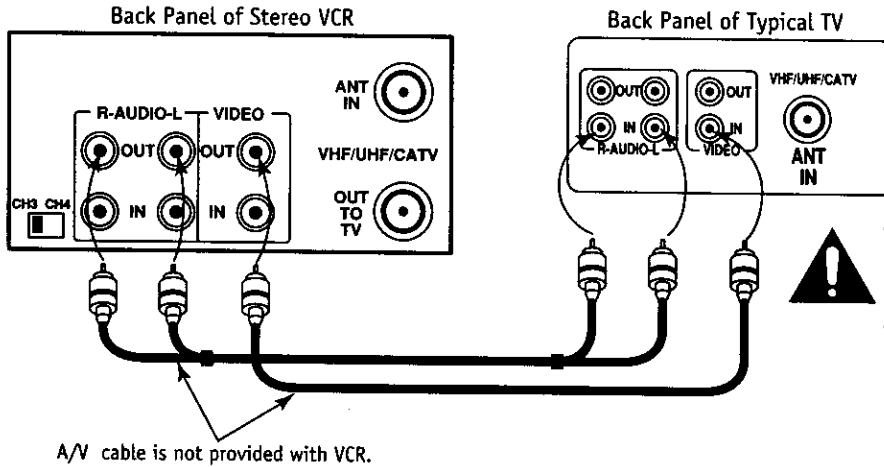

! Turn off power or unplug VCR before making any connections.

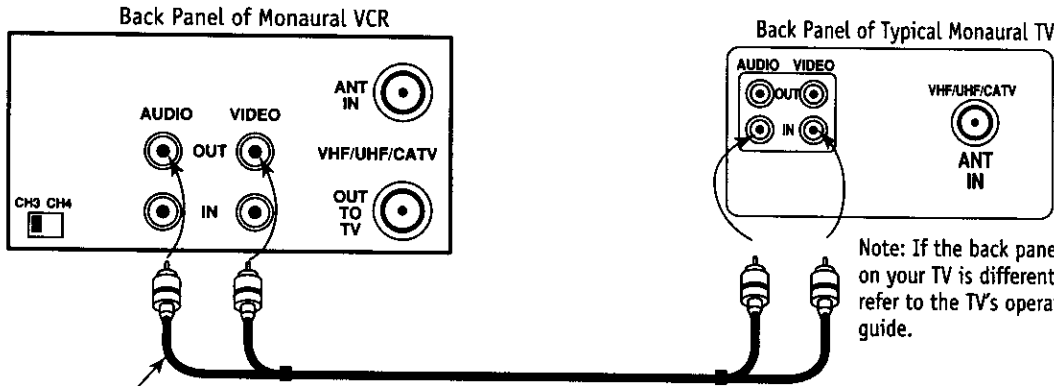

Note: If the back panel on your TV is different, refer to the TV's operating guide.

Accessory Audio/Video (A/V) Connections to VCR

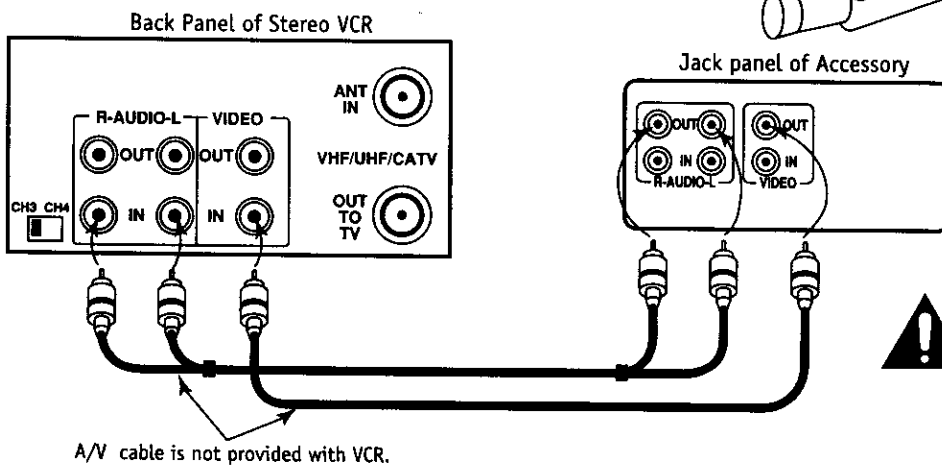

Accessory Component:
Another VCR,
Camcorder,
Video Camera,
Satellite Receiver,
Laser Disc Player

! Turn off power or unplug VCR before making any connections.

Before you operate your VCR

Things you must do before you can operate your VCR.

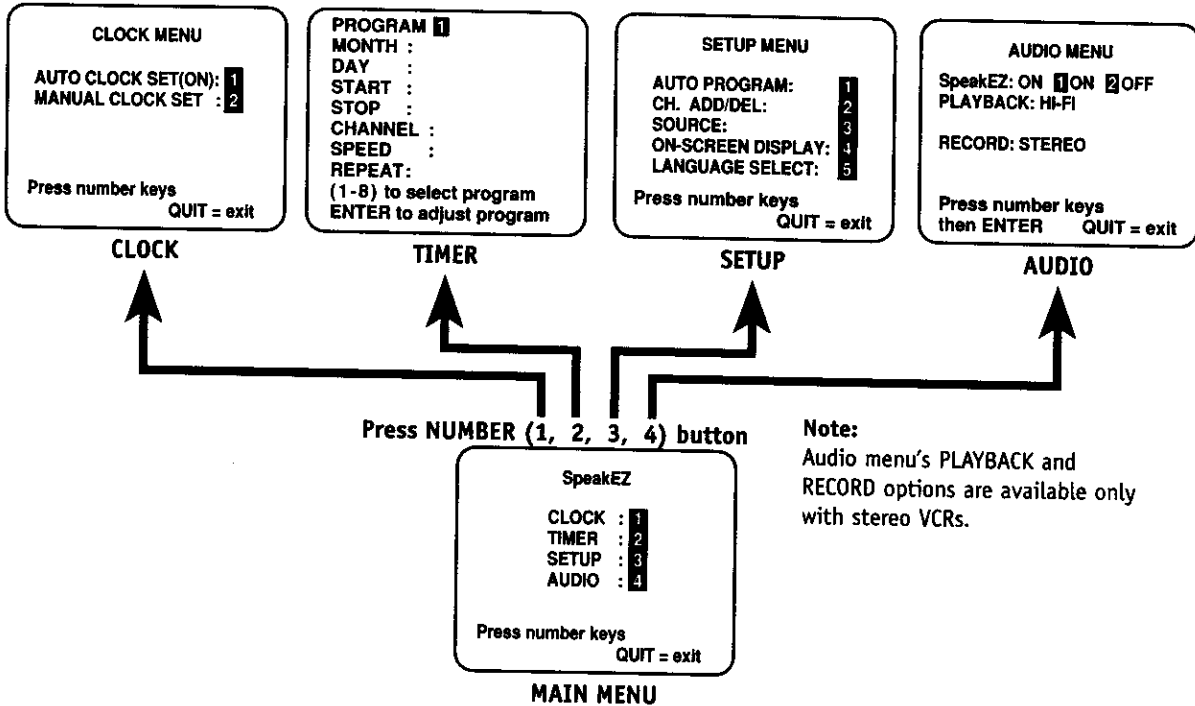

How to Access Menus

Menu operation is easy—just follow the instructions shown at the bottom of the menu.

1. Press MENU to see main menu.
2. Press NUMBER (1, 2, 3, or 4) to see desired sub menu to be used.
3. Press NUMBER to choose desired option to be changed.
4. Press QUIT to exit menu, or wait a few minutes and the VCR returns to normal operation.

Note:

Perform menu operations with the VCR and TV on, and tune the TV to channel 3 or 4. The VCR must also be in the VCR mode of operation. Press the TV/VCR button repeatedly until VCR indicator light appears in the front panel.

Point remote toward VCR

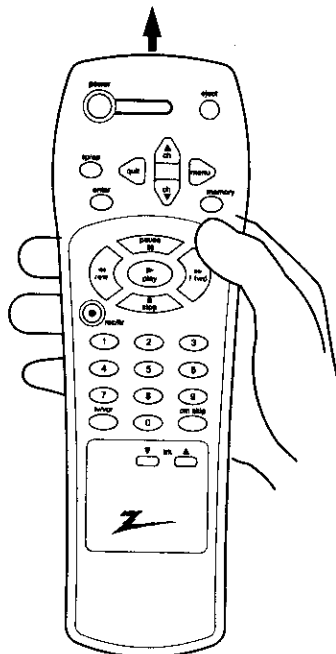

Before you operate your VCR

Things you must do before you can operate your VCR.

1

Connect the Power

(Required) Plug your VCR into an unswitched 120 Vac, 60 Hz household power outlet. Turn on the VCR by pressing the POWER on the remote or on the VCR's front panel. While plugged into an AC outlet, the VCR consumes 3W of electrical power in OFF condition.



Do not plug the VCR into a switched power outlet. Otherwise, when the power is switched off, the VCR turns off. You may then have to reset the time and date, and reprogram operational features.

2

Set Position of the CH3/CH4 Switch

(Required) The CH3/CH4 switch on the VCR's back panel determines which channel the VCR uses to send video signals to your TV. The TV must be tuned to the same channel you set with the CH3/CH4 switch to see tape playback and status displays from the VCR. To determine which video channel provides the best picture for your system, try the switch in CH3 position and tune your TV to channel 3; then try the CH4 position and tune your TV to channel 4.

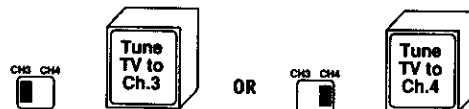
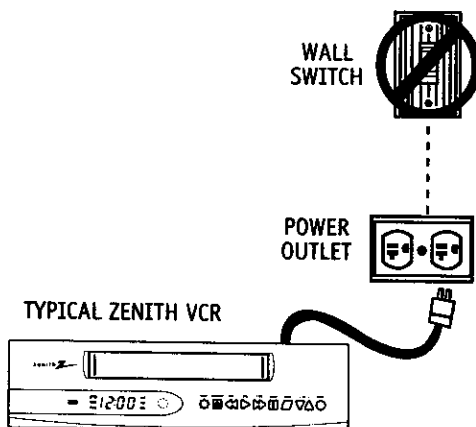

3

Select SpeakEZ Function (On/Off)

A voice tells you how to use the features in the menus if SpeakEZ is ON. (ON is recommended.) See the AUDIO Menu for details.



SpeakEZ only functions with ENGLISH (VRB421/VRB411/VRB211). SpeakEZ functions with ENGLISH and SPANISH (VRB412).

4

Select Language for VCR Menus/Displays

(Optional) Select English, Spanish, or French for VCR menus and status displays. See the LANGUAGE SELECT option on the SETUP menu for details.

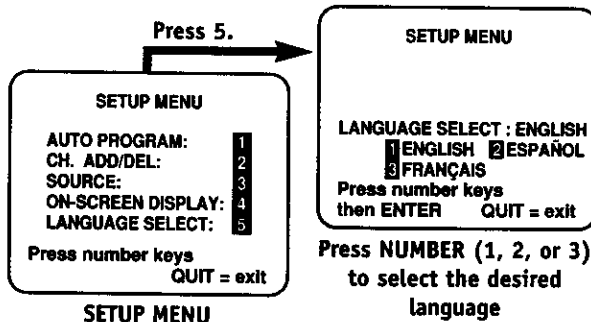
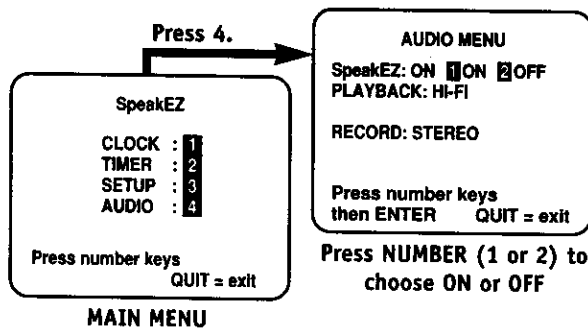

Before you operate your VCR

Some things you must do and others you may want to do before you can operate your VCR.

5 Set Date and Time for Clock

Set the clock in the VCR to the current date and time. See CLOCK Menu on page 16 for details.

Your VCR also has an Auto-Clock Set feature. See CLOCK Menu for details.



The Timer feature will not function unless the Clock has been set.

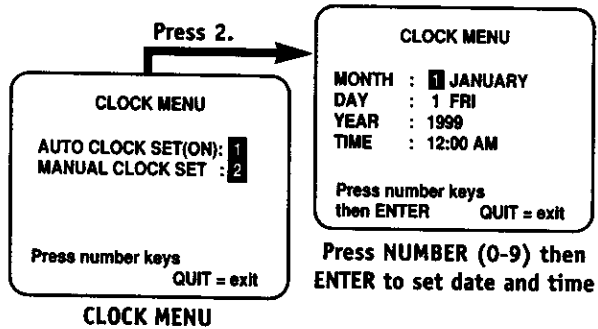

6 Select Source for VCR

(Optional) Set the source of the VCR for the type of program signal you have connected to the ANT IN jack on the back of the VCR. Choose TV if you have an antenna connected to the VCR. Choose CATV if you have a cable system (with or without a cable box) connected to the VCR. Choose AUX if you have an accessory Audio/Video (A/V) connected to the VCR. See SOURCE option on SETUP menu (page 18) for details.

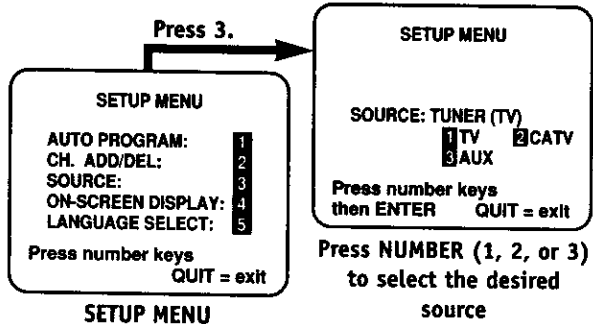

7 Use Auto Program to Find Channels

(Required) Use AUTO PROGRAM to find active channels in your broadcast area. AUTO PROGRAM stores the active channels that you can access by using the CH (▼/▲). See AUTO PROGRAM on the SETUP Menu (page 18) for details.

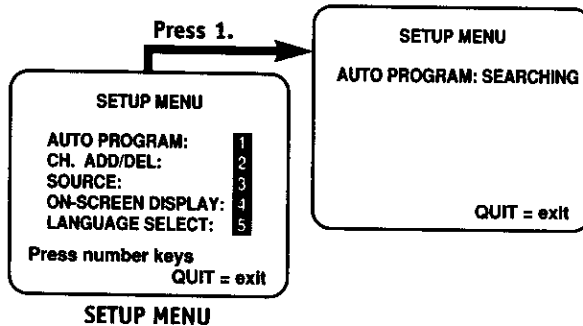

8 Use CH. ADD/DEL to Create Favorite Channels

(Optional) Use CH. ADD/DEL to change the list of active channels found when using AUTO PROGRAM, so you can list your favorites. See CH. ADD/DEL on the SETUP Menu (page 18) for details.

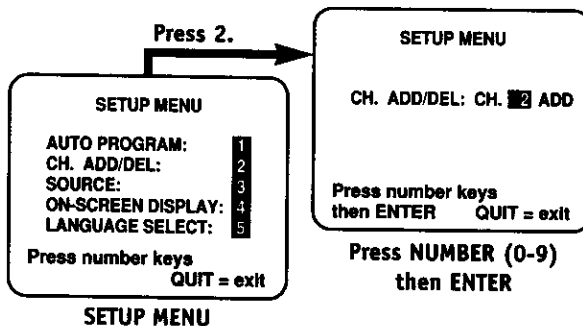

Before you operate your VCR

Things you may want to do before you operate your VCR.

9

Select Other Menu Options

Show or hide the VCR status on your screen by using the ON-SCREEN DISPLAY option on the SETUP menu. We recommend keeping this option ON. See the SETUP menu for details.

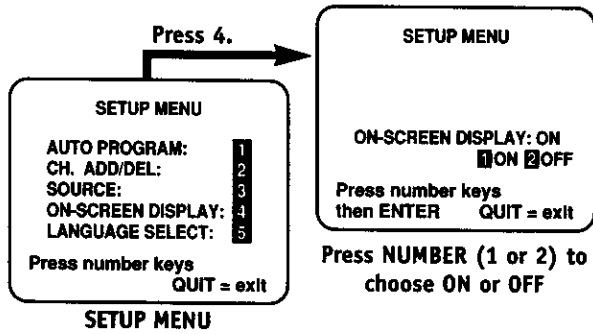

If you have a stereo VCR, press ENTER to select the audio format (HI-FI or NORMAL) to use when you play a tape. We recommend setting this option to HI-FI. See the PLAYBACK MODE option on the AUDIO Menu for details.

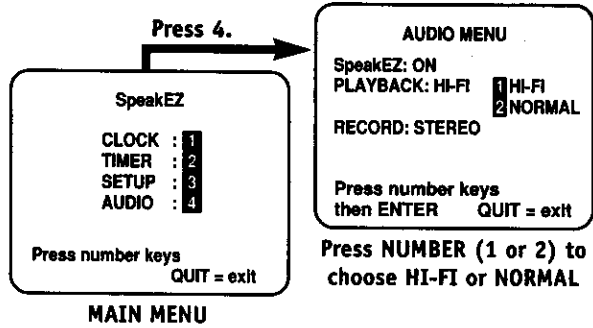

If you have a stereo VCR, press ENTER to select the audio format (STEREO, MONO or SAP) to use when recording. We recommend using STEREO. See the RECORD MODE option on the AUDIO Menu for details.

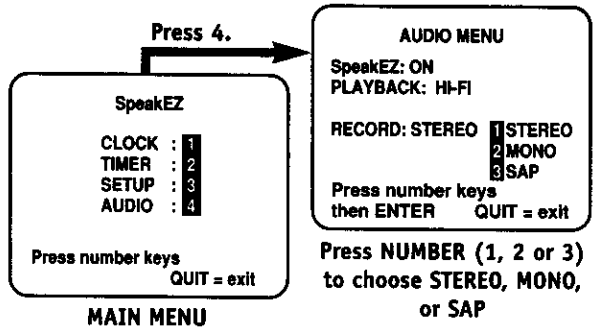

Front Panel Diagram

Descriptions of items you need to know to operate your VCR.

Front Panel Controls

These controls perform basic VCR operations—some of them light up as you use them. The Remote performs basic as well as advanced VCR operations.

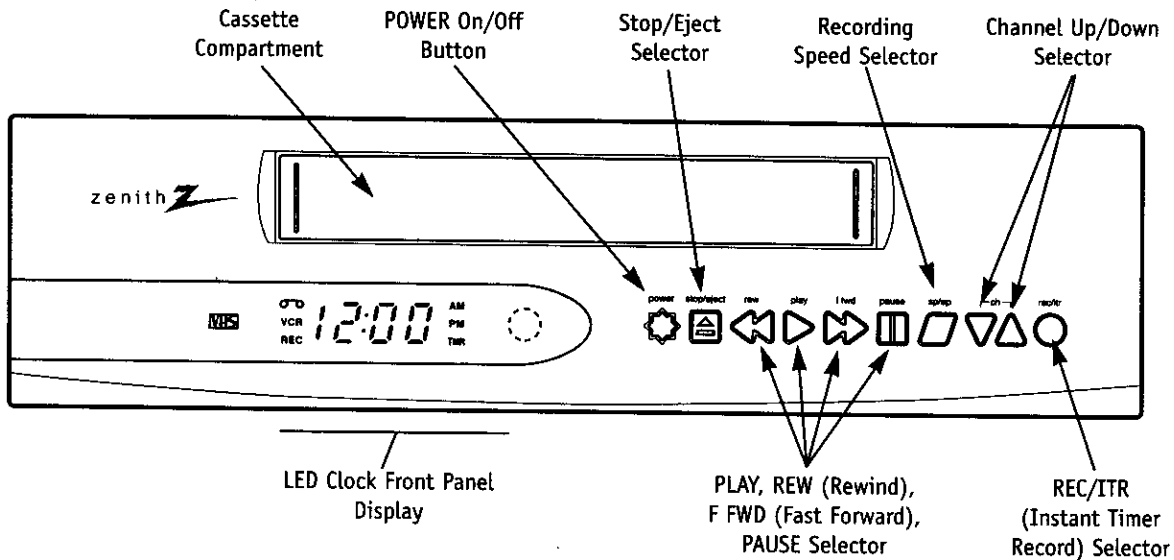

LED Clock Front Panel Indicators

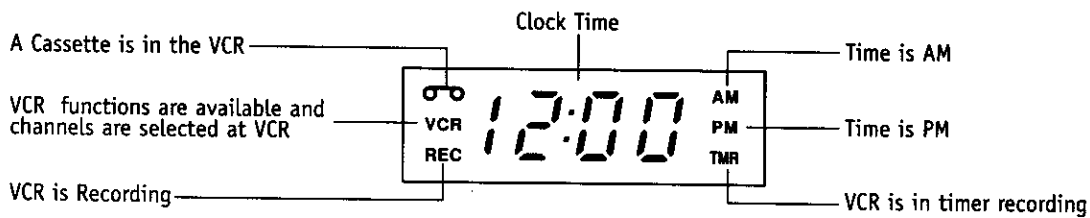

Front Panel Display shows which VCR function you are using. For example, when you press SP/EP, SP or EP appears to indicate the tape speed. As you change channels, the channel numbers appear. The current time shows even while the VCR is off.

Other messages include:

- AU Auxiliary channel is selected for viewing equipment connected to the Audio/Video jack on the front or rear of the VCR.
- EP Extended Play speed is selected.
- SP Standard Play speed is selected.
- :-- Clock is not set.
- Err Error: Turn VCR On and OFF to erase "Err" message. If it is not erased, take VCR to an authorized repair center.

VCR Status Displays

On-Screen displays tell you the status of the tape inserted and VCR functions.

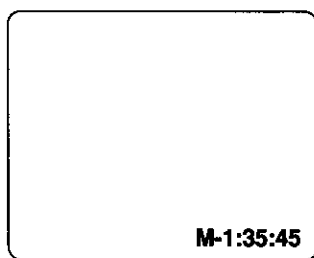
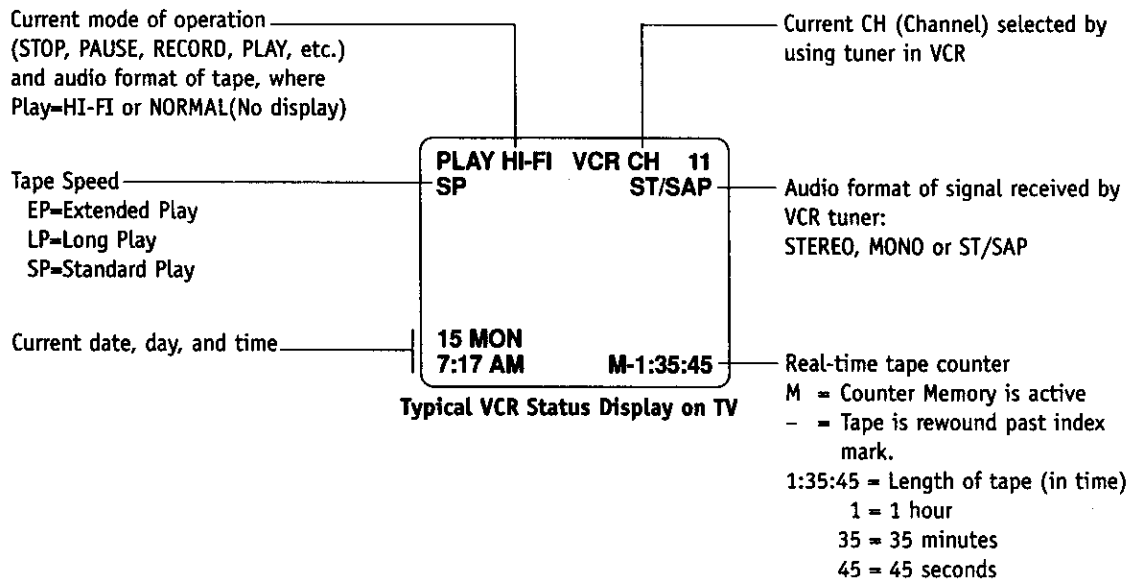

Tape Counter Position

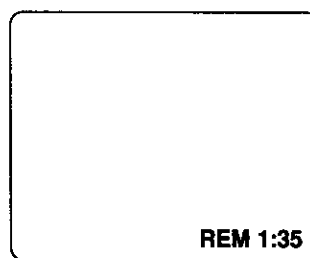

Tape Time Remaining

VCR Status Display

The VCR Status Display appears on the TV when a VCR function starts, like when you change a channel or select a different VCR mode. For example, pressing STOP while the VCR is in PLAY mode shows STOP in the display. Press ENTER on the remote at any time (except Special Effects Playback mode; SLOW, STILL etc.) to see the Status Display.

Note:

If the VCR Status Display does not appear on the TV screen, check the ON-SCREEN DISPLAY option on the SETUP menu. Select ON to see the display. See "Setup Menu" section for details.

VCR Status Display Options

When the Status Display appears, press ENTER repeatedly to see abbreviated displays, as follows:

1. Press ENTER to see Status Display.
2. Press ENTER a second time to show only the tape counter position.
3. Press ENTER a third time to show only the tape time remaining.
4. Press ENTER repeatedly until all displays are removed.

The Buttons on Your Remote

A quick list of all the buttons on your remote control and what they do.

CH (▼/▲) — Channel Selectors. Also selects AUX A/V input channel.

CM SKIP — Fast forwards picture search through 30 seconds of recording.

EJECT — Ejects the tape from the VCR.

ENTER — Programs menu options and shows VCR display.

F FWD (Fast Forward)—Advances tape rapidly.

MEMORY — Returns real-time tape counter to zero (M 0:00:00).

MENU — Shows main menu.

Numbers — Chooses channels and enters programming information.

PAUSE — Pauses tape temporarily during playback or record.

PLAY — Begins tape playback.

POWER — Turns VCR On and Off. Also turns VCR Timer Off and On, if programmed.

QUIT — Exits menu system.

REC/ITR — Begins tape recording.

REW — Rewinds tape to the beginning.

SP/EP — Chooses tape recording speed.

STOP — Cancels playback or record modes.

TRK (▼/▲) — Adjusts tape playback tracking.

TV/VCR — Switches source of TV picture between TV channel and VCR channel selection. VCR functions are available in VCR mode.

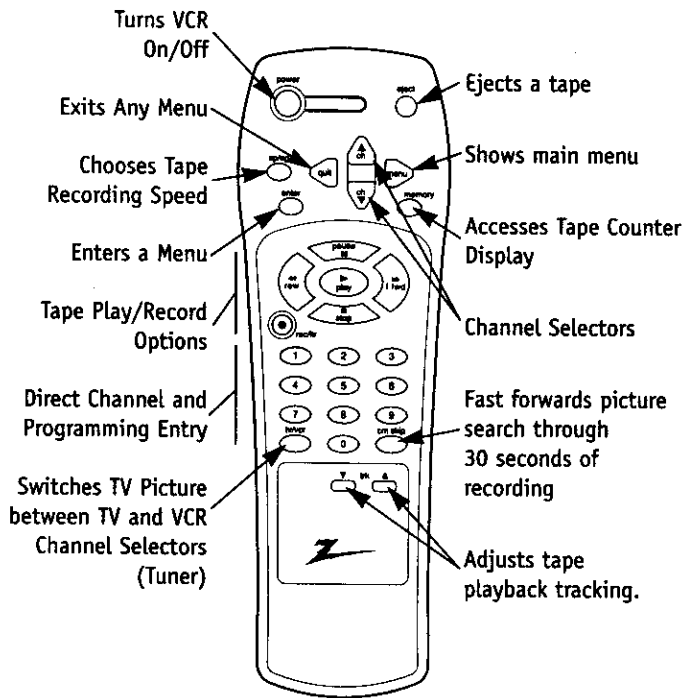

Installing Batteries

Be sure to install the batteries provided with this remote. Match positive (+) and negative (-) with markings shown in battery compartment.

Note: All VCR operations and menu options can be accessed by using the remote control.

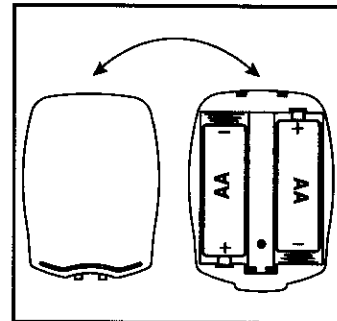

Clock Menu

The Clock Menu sets the clock in the VCR to the current time. There are two options AUTO and MANUAL.

Auto Clock Set

AUTO automatically sets the clock in the VCR to the current time and date. AUTO works only in areas where Data Service (DS) signals are provided along with normal TV signals.

1. Press MENU to see Main Menu.
2. Press 1 to see Clock Menu.
3. Press 1 to set the current time automatically on the Clock Menu.

Notes:

We recommend that you set the clock using the MANUAL method the first time you use your VCR. See MANUAL option for details.

The clock must be set before you can record by using the TIMER.

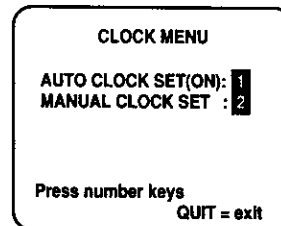

Manual Clock Set

The CLOCK Menu allows you to set the clock in the VCR to the current date and time.

Notes:

The clock must be set before you can record, using the TIMER menu.

You may have to reset the clock and other features if a power outage lasts for more than 3 seconds.

If you use the Manual option. The AUTO CLOCK SET mode will be turned to OFF

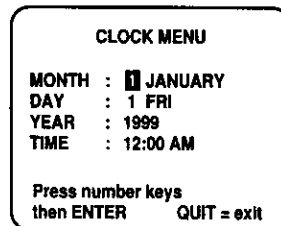

Typical CLOCK Menu with date and time settings

How to Set Clock

1. Press MENU to see Main Menu.
2. Press 1 to see clock options.
3. Press 2 to adjust your options.
4. First insert the month number (5=MAY, 6=JUNE etc).
5. Press ENTER to move to next option.
6. Press QUIT to exit the menu system.

Timer Menu

The **TIMER** Menu tells the VCR when to record a program on a day and at a time you specify. You can specify eight different events to be recorded in a one-year period.

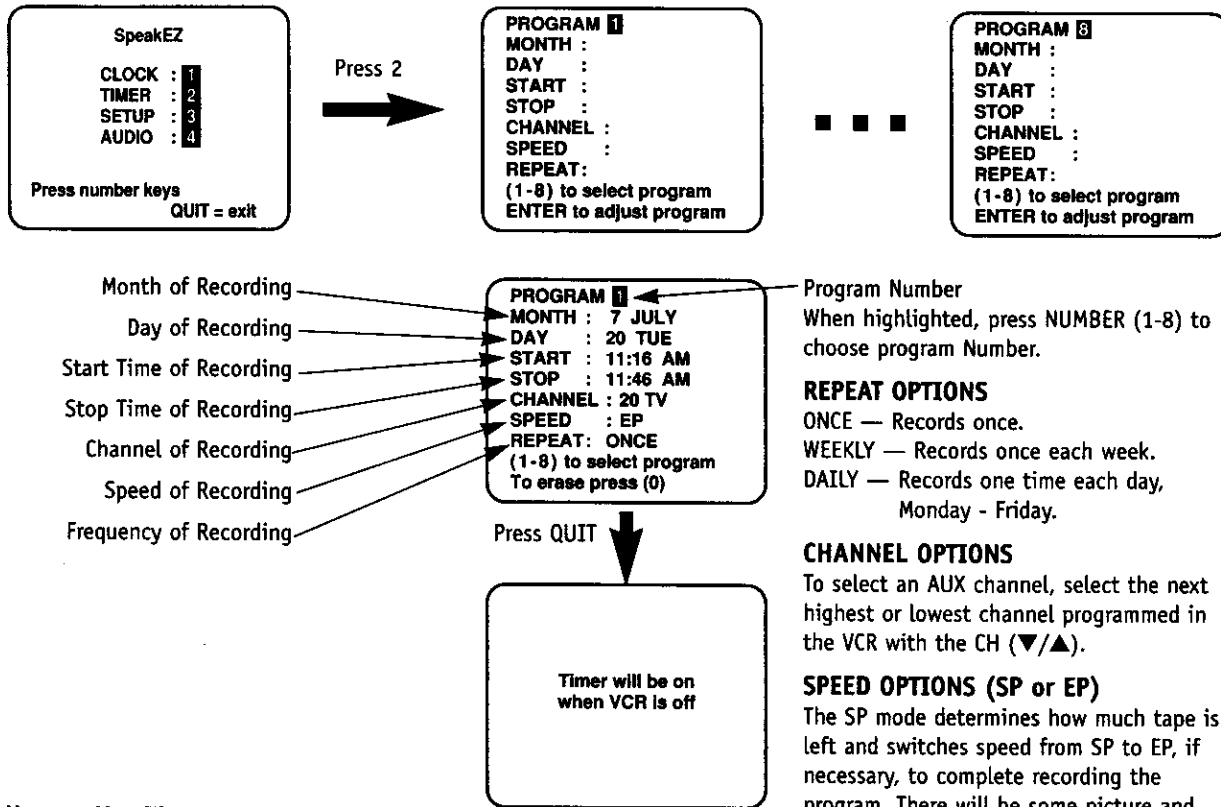

How to Use Timer

1. Choose **TIMER** menu as described in "How to Access Menus" on page 9.
2. When the **TIMER** menu is displayed on screen, press the **ENTER** button to select the correct month, then press the **ENTER** button again to move the next option or setting.
3. When you have entered all of the settings to your satisfaction, press **QUIT** to exit the menu system.

Note:

Set the VCR in **TIMER** mode by pressing **POWER** to turn off the VCR. The **TIMER** indicator light appears in the front panel of the VCR.

 You cannot operate the VCR manually while it is recording. Pressing **POWER** stops the recording.

To Erase a Program

1. Choose **TIMER** menu as described in "How to Access Menus" on page 9.
2. Press **NUMBER(1-8)** to select desired **PROGRAM** to be erased.
3. Press **0** to erase the program.
4. Press **QUIT** to exit the menu system.

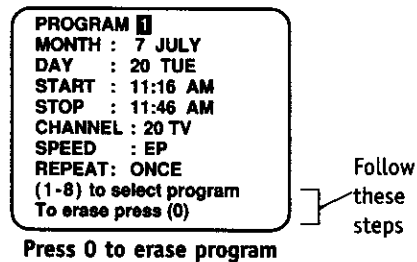

Setup Menu

The SETUP Menu customizes the VCR's operation for your particular needs.

Choose SETUP Menu as described in "How to Access Menus" on page 9.

SETUP MENU

AUTO PROGRAM: 1
CH. ADD/DEL: 2
SOURCE: 3
ON-SCREEN DISPLAY: 4
LANGUAGE SELECT: 5

Press number keys
QUIT = exit

AUTO PROGRAM	Finds all active channels and stores them in the VCR's memory for access by CH (▼/▲). Press 1 to begin search.
CH. ADD/DEL	Edits the channels found by AUTO PROGRAM. Use number keys followed by ENTER to select the channel to be edited (e.g., to ADD channel 3, press 3 then ENTER). Press ENTER to ADD or DEL (Delete) channels to create your own list of favorite channels.
SOURCE	Selects TV, CATV, or AUX as the source of the program to watch or record. Choose TV if you have an antenna connected to the VCR. Choose CATV if you have a cable system (with or without a cable box) connected to the VCR. Choose AUX if you want to see the program from accessory equipment, such as a camcorder, connected to the Audio/Video (A/V) IN jacks on the VCR.
ON-SCREEN DISPLAY	Selects whether or not you see VCR Status Displays on the TV.
LANGUAGE SELECT	Selects English, Spanish or French for VCR menus and displays on the TV.

Audio Menu

The AUDIO Menu specifies the audio format to be used when recording or playing a tape. (Audio menu's PLAYBACK and RECORD options are available only with stereo VCRs.)

The AUDIO Menu indicates the audio format used when recording or playing a tape. Choose AUDIO Menu as described in "How to Access Menus" on page 9.

Press **ENTER** (and repeat) to choose items in the menu (some models).

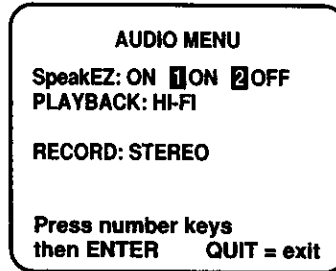

SpeakeZ	Turns SpeakeZ ON or OFF. A voice tells you how to use the features you select in the menus if SpeakeZ is ON. (ON is recommended.)
PLAYBACK	Selects HI-FI or NORMAL for tape playback. HI-FI (High Fidelity) provides stereo sound, if present on the tape, to the left and right VCR AUDIO output jacks on the back of the VCR. NORMAL provides monaural sound, regardless of the audio format present on the tape.
RECORD	Select the STEREO, MONO, or SAP for recording a program. STEREO records sound from the left and right audio tracks in stereophonic format. MONO (Monaural) records sound in monaural format even if the program is in stereo. SAP records the Second Audio Program (SAP) track, if present, in addition to the stereo audio tracks. SAP usually contains audio in another language.

Watching TV Through the VCR

This page shows a typical video system and explains how to select channels.

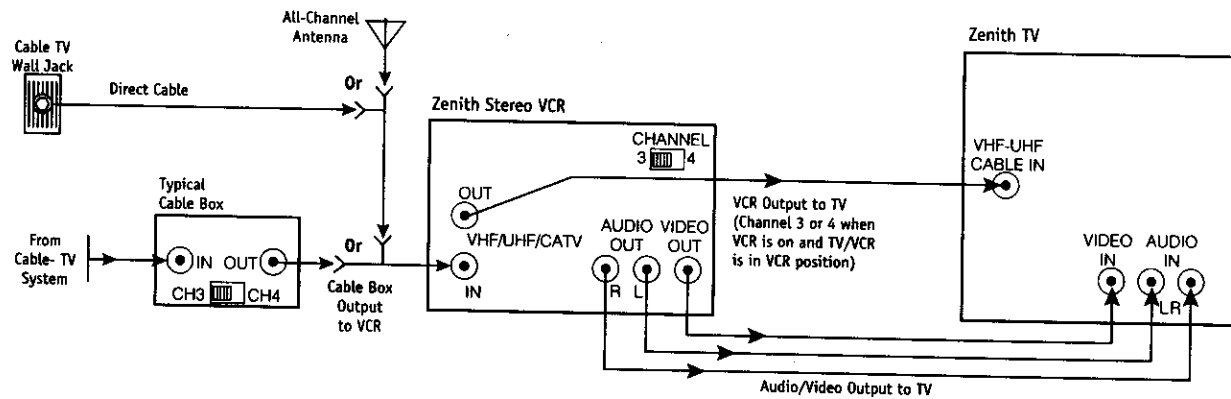

Selecting Channels when the VCR is OFF

1. Turn TV on.
2. Select channel you'd like to watch at the TV. If you have a cable box, select channel 3 or 4 at the TV. Select cable box channels at the cable box.

Selecting Channels at the TV when VCR is ON

1. Turn TV and VCR on.
2. Place VCR in TV mode by pressing the TV/VCR button on the remote control repeatedly until the VCR indicator disappears from the front panel of the VCR.
3. Select channel you'd like to watch at the TV. If you have a cable box, select channel 3 or 4 at the TV. Select cable box channels at the cable box.

Selecting Channels at the VCR when VCR is ON

1. Turn TV and VCR on.
2. Place VCR in VCR mode by pressing the TV/VCR button on the remote control repeatedly until the VCR indicator appears in the front panel of the VCR.
3. Select channels 3 or 4 at the TV. If your TV is equipped with A/V input jacks, check your TV operating manual to select the A/V source for a better picture.
4. Select the channel you'd like to watch at the VCR. If you have a cable box, select channel 3 or 4 at the VCR. Select cable box channels at the cable box.

Camcorder Connected to VCR

This page describes how to connect a camcorder to your VCR.

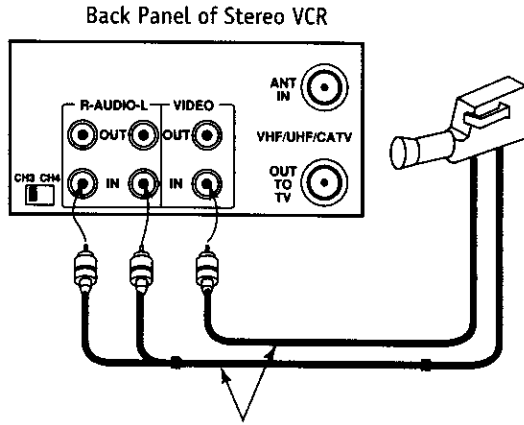

Turn off power or unplug VCR before making any connections.

Select AUX for Viewing an Audio/Video source like a Camcorder

1. With TV and VCR on, place VCR in VCR mode by pressing the TV/VCR button on the remote (and repeat) until the VCR indicator light appears in the VCR's front panel.
2. Select channel 3 (or 4) on the TV. Note: If your TV has A/V jacks, you may get a better picture if you connect your VCR there. (Then, select the A/V source on the TV.)
3. At the VCR, Channel down lower than the lowest channel (or Channel up above the highest) to select "AUX". You can also choose the SETUP menu as described in "How to Access Menus" on page 9.
 Press 3 for the SETUP menu's SOURCE item.
 Press 3 for AUX, then ENTER. (Press QUIT to exit.)

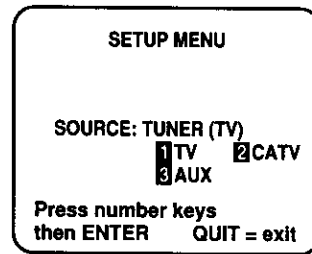

Press 3 to select AUX

Items in the Menu

SOURCE	Shows the program source—TV, CATV, or AUX—selected for the VCR to receive.
TUNER	The VCR is using its Tuner to receive programs from an antenna or cable.
TV	Selects programs for the VCR from a rooftop-type antenna.
CATV	Selects programs for the VCR from Cable TV.
AUX	Selects programs for the VCR from the R-AUDIO-L—VIDEO IN jacks (where you may have connected your camcorder).

Playing Tapes

This page explains the basics of playing tapes in your VCR.

Automatic Playback (No Safety Tab)

1. Tape playback begins automatically, if the safety tab has been removed from the cassette case. For example, most rental movies have no safety tab. Simply insert the prerecorded VHS cassette into the VCR. Power will turn on automatically and playback will begin.
2. Select the channel 3 or 4 at the TV or select the TV's AUX (Auxiliary) source to see the picture, if you are using the A/V jacks. Refer to page 7 and 8.

Manual Playback (Has Safety Tab)

1. Press POWER to turn VCR on.
2. Insert a prerecorded VHS cassette into the VCR.
3. Press PLAY to begin playback.
4. Select the channel 3 or 4 at the TV or select the TV's AUX (Auxiliary) source to see the picture, if you are using the A/V jacks. Refer to your TV operating manual.

Unloading the Cassette from the VCR

1. Press STOP if the tape is playing.
2. Press STOP/EJECT at the VCR until the cassette is ejected.

Note:

This VCR records only in SP and EP speeds. Your VCR sets the playback speed automatically to the speed used to record the tape.

(Continued on next page)



VCR's Controls

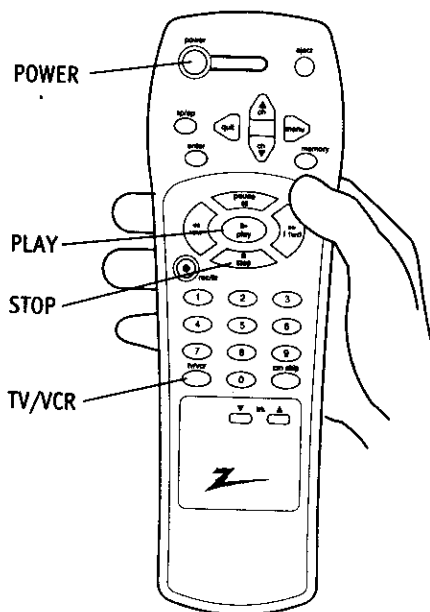
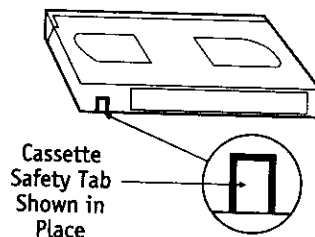

VHS Cassette Playback/Record Times			
Cassette Length	SP (Standard Play)	LP (Long Play)	EP (Extended Play)
T-30	30 Minutes	1 Hour	1 Hour, 30 Minutes
T-60	1 Hour	2 Hours	3 Hours
T-120	2 Hours	4 Hours	6 Hours
T-160	2 Hours, 40 Minutes	5 Hours, 20 Minutes	8 Hours

Playing Tapes

This page explains how to use the remote to play tapes on your VCR.

Auto/Manual Tracking Adjustment

Your VCR adjusts tracking automatically when you play a tape. If the tape was recorded on a different VCR, streaks (video noise) may appear. While the tape is playing, press TRK (▼/▲) to adjust the tracking manually.

Real-Time Tape Counter

Press ENTER twice to keep the tape counter on the TV screen. Press ENTER repeatedly to remove all displays. The counter resets to 0:00:00 when you insert a cassette or when a tape is rewound to its beginning.

Pause/Forward/Reverse Slow-Motion Video

(While in play mode) Press PAUSE for still video. Press PAUSE again, and follow on-screen instructions for Forward or Reverse slow motion. Press F FWD or REW to control slow speed during slow motion. Press PLAY to resume normal tape playing.

Note: When the reverse slow mode continues for more than 30 seconds, the VCR will automatically change to play mode.

Tape Rewind and Fast Forward

(While in Stop mode) Press and release REW or F FWD (Fast Forward), as desired. Press STOP when tape reaches desired location.

Reverse/Forward Search

(While in Play mode) Press and release REW or F FWD, as desired. Press PLAY to resume normal tape playing.

CM Skip (Commercial Skip)

(While in play mode) Pressing CM SKIP on the remote skips commercials or other program material. Pressing 1, 2, 3, or 4 times skips 30, 60, 90, or 120 seconds, respectively. CM SKIP skips a full 120 seconds of commercials in a few seconds, then resumes normal playback.

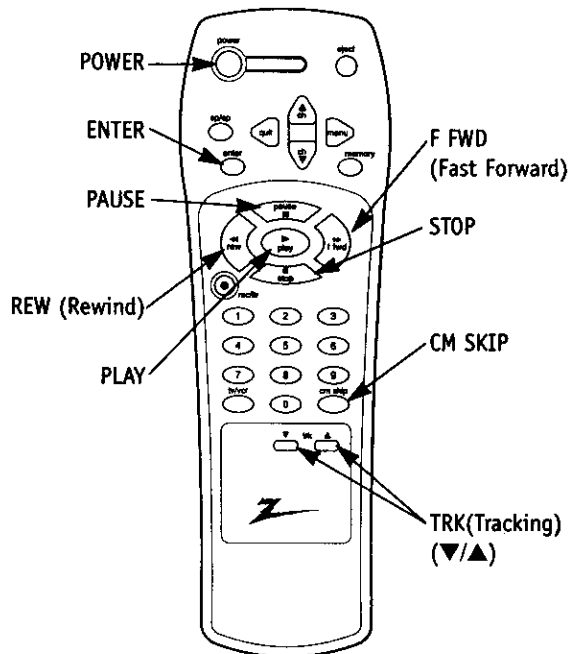

Instant Recording

Recording what you are watching on TV.

Options You Can Use While Recording

Instant recording lets you record until you reach the end of tape or you press STOP to stop recording.

- 1** Turn TV and VCR on.
- 2** Place VCR in VCR mode by pressing the TV/VCR button on the remote repeatedly until the VCR indicator light appears in the VCR front panel.
- 3** Select channel 3 or 4 at the TV. If you have connected your VCR to the TV's A/V input jacks, select the A/V source at the TV for a better picture.
- 4** Select the channel to be watched and recorded at the VCR. If you have a cable box, select the cable box output channel (usually 3 or 4) at the VCR. Select cable box channels at the cable box.
- 5** Insert a VHS cassette tape into the VCR.
- 6** Press SP/EP to select recording speed, if desired. Recording speed is always SP, unless you select EP.
- 7** Press REC/ITR until recording begins. REC indicator light appears in the VCR front panel. Recording continues until you reach the end of the tape, or until you press STOP to stop recording.

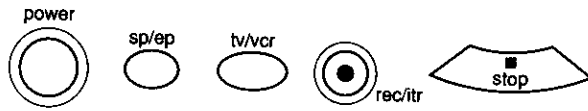

Remote's Controls

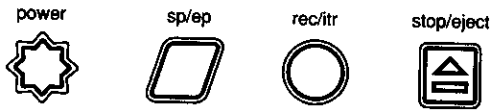

VCR's Controls

Instant Recording (until end of tape)	Instant Timer Recording (Preset recording times)
PAUSE – Momentarily pauses recording. Press PAUSE again to resume recording.	STOP or STOP/EJECT – Stops and exits recording mode.
STOP or STOP/EJECT – Stops and exits recording mode.	

Instant Recording

Recording using preset time periods.

Preset Time Periods for ITR Recording.

Note:

Preset recording time counts down until the recording time is over.

Instant (attended) Timer Recording (ITR) lets you record for a specific preset time period, instead of recording until the end of tape is reached. For example, you can record a 30-minute show using the preset time period.

- 1** Turn TV and VCR on.
- 2** Place VCR in VCR mode by pressing the TV/VCR button on the remote repeatedly until the VCR indicator light appears in the VCR front panel.
- 3** Select channel 3 or 4 at the TV. If you have connected your VCR to the TV's A/V input jacks, select the A/V source at the TV for a better picture.
- 4** Select the channel to be watched and recorded at the VCR. If you have a cable box, select the cable box output channel (usually 3 or 4) at the VCR. Select cable box channels at the cable box.
- 5** Insert a VHS cassette tape into the VCR.
- 6** Press SP/EP to select recording speed, if desired. Recording speed is always SP, unless you select EP.
Note: The SP mode determines how much tape is left and switches speed from SP to EP, if necessary, to complete recording the program. There will be some picture and sound distortion at the point of the speed change.
- 7** Press REC/ITR until recording begins. The REC indicator light appears in the VCR front panel. Recording continues until you reach the end of the tape, or until you press STOP to stop recording.
- 8** Press REC/ITR repeatedly to select a preset recording time period. Each subsequent press of REC/ITR increases the recording time by 30 minutes until you reach a maximum of 4 hours.

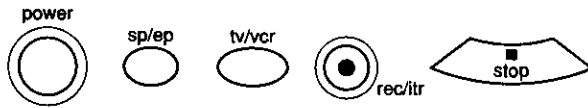

Remote's Controls

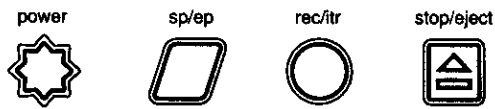

VCR's Controls

Presses of REC/ITR	Display	Preset Time For Recording
1 (Press)	Current Time	Until end of tape
2	0:30	30 minutes
3	1:00	1 hours
4	1:30	1 hour and 30 minutes
5	2:00	2 hours
.	.	.
.	.	.
9	4:00	4 hours
10	No display	normal recording

Instant Recording

Recording one show while watching another.

Note:

If you have a cable box connected to your VCR, you cannot record one show and watch another.

Choose the show you wish to record using the VCR's channel selector. Choose the show you wish to watch using the TV's channel selector.

- 1** Turn TV and VCR on.
- 2** Place VCR in VCR mode by pressing the TV/VCR button on the remote repeatedly until the VCR indicator light appears in the VCR front panel.
- 3** Select channel 3 or 4 at the TV. If you have connected your VCR to the TV's A/V input jacks, select the A/V source at the TV for a better picture.
- 4** Select the channel to be watched and recorded at the VCR. If you have a cable box, select the cable box output channel (usually 3 or 4) at the VCR. Select cable box channels at the cable box.
- 5** Insert a VHS cassette tape into the VCR.
- 6** Press SP/EP to select recording speed, if desired. Recording speed is always SP, unless you select EP.
- 7** Press REC/ITR until recording begins. REC indicator light appears in the VCR front panel. Recording continues until you reach the end of the tape, or until you press STOP to stop recording.
- 8** Place VCR in TV mode by pressing the TV/VCR button on remote to turn off VCR indicator light in the VCR front panel.
- 9** Select the show you wish to watch using the TV's channel selector.

Note:

To return to the show you're recording, select channel 3 or 4 at the TV. Place the VCR in the VCR mode by pressing the TV/VCR button on the remote to show the VCR indicator light in the VCR's front panel.

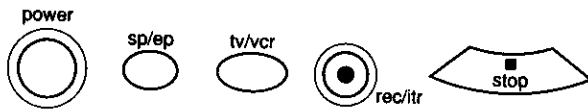

Remote's Controls

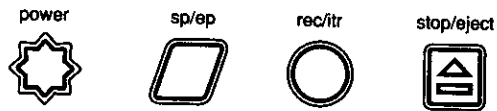

VCR's Controls

Options You Can Use While Recording

Instant Recording (until end of tape)
PAUSE - Momentarily pauses recording. Press PAUSE again to resume recording.
STOP or STOP/EJECT - Stops and exits recording mode.

Recording While You're Away

This page explains how to use the Timer so that you can record while you are away.

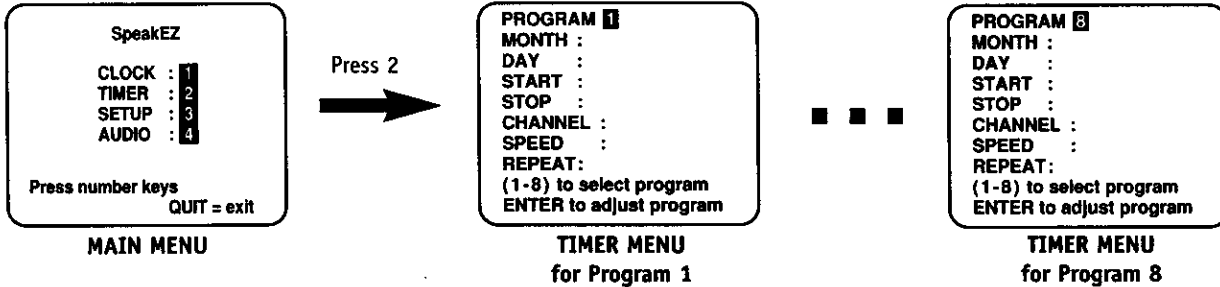

Timer-controlled recording lets you record shows unattended. Pick a day and time up to one year in advance. The show may be recorded once or on multiple days. You can schedule up to eight different events into the PROGRAM TIMER for recording, as long as no events overlap in the same time period.

VCR Operation with Timer Off or On

VCR POWER	TIMER STATUS	VCR OPERATION
On	Off	Disables Timer-controlled recording if an event is scheduled in the Timer. All other VCR operations can be used as desired.
Off	On (or set)	Enables Timer-controlled recording if an event is scheduled in the Timer. You cannot operate the VCR manually while it is in Timer Set mode. If you have scheduled the Timer, you'll be recording at a later time.

- 1 Turn TV and VCR on.
- 2 Place VCR in VCR mode by pressing the TV/VCR button on the remote repeatedly until the VCR indicator light appears in the VCR front panel.
- 3 Select channel 3 or 4 at the TV.
- 4 Insert a VHS cassette tape into the VCR.
- 5 Program events to be recorded with the Timer by following the procedure in the TIMER MENU section. If you have a cable box, select channel 3 or 4 (at the VCR) as the channel to be recorded. Keep your cable box on when using the Timer to record.
- 6 Enable the Timer by pressing POWER to turn off the VCR. The TIMER indicator light appears in the VCR front panel to indicate the VCR is in the TIMER recording mode.

Troubleshooting

Some quick and easy tips to fixing problems yourself.

Before Calling for Service

Please refer to this chart before calling for service. First, turn on the TV and VCR. Select appropriate input for the TV to receive the video signal from the VCR. You will probably use the Antenna In connection to the TV. Select channel 3 or 4 at the TV. Place the VCR in the VCR mode by pressing the TV/VCR button on the remote repeatedly until VCR indicator light appears in the VCR front panel. If you have a cable box, turn it on and select channel 3 or 4 at the VCR.

Operating Problems		
Observed Condition	Possible Cause	Probable Solution
No power to the VCR.	Power cord is not connected.	Connect power cord.
Remote does not function.	Batteries are weak.	Replace with new batteries.
	You are too far away from the VCR.	Move closer to the VCR.
	Remote may be at an awkward angle.	Avoid holding the remote at sharp angle.
No picture appears on TV screen from any VCR function.	Source for TV is not selected properly.	Set INPUT source on TV to Audio/Video In, or tune TV to Channel 3 or 4, as appropriate.
	TV/VCR mode for VCR is set to TV.	Press the TV/VCR button on remote repeatedly to choose VCR mode. VCR indicator light appears in VCR front panel.
VCR features do not function. VCR does not respond to remote functions or VCR keys.	VCR is locked up.	Disconnect VCR power cord for three (3) minutes. Reset clock and other features as necessary.

Playing Tapes (Playback) Problems		
Observed Condition	Possible Cause	Probable Solution
Tape will not rewind or fast forward.	Tape is fully rewound or is at its end.	No action necessary.
Mechanical sound is audible during playback.	Note: This is normal operating sound from internal mechanisms.	No action necessary.
Tape playback does not appear on TV screen.	Source for TV is not selected properly.	Set Input source on TV to Audio/Video In, or tune TV to Channel 3 or 4, as appropriate.
	TV/VCR mode for VCR is set to TV.	Press the TV/VCR button repeatedly to choose VCR mode. VCR indicator light appears in VCR front panel.
Video "noise" (horizontal streaks) appear during normal tape playing.	Tape is a rental or was recorded on another VCR.	Use TRK (▼/▲) for manual tracking adjustment while tape is playing.
	Tape heads are dirty.	Clean video heads.
VCR Status Display flickers when using STILL video during tape playback.	Tape tracking needs to be adjusted while in slow-motion playback.	From STILL video mode, enable slow-motion playback. Use TRK (▼/▲) to adjust tracking for best picture. Return to PLAY mode, then press PAUSE for STILL video.

Troubleshooting

Some quick and easy tips to fixing problems yourself.

Channel Tuning Problems

Observed Condition	Possible Cause	Probable Solution
Some channels are skipped over when using CH (▼/▲).	Those channels were deleted with the CH. ADD/DEL option.	Use CH. ADD/DEL to restore channels. See SETUP Menu on page 18 for details.
Picture and sound are weak or missing.	Antenna or cables are loose.	Tighten connections or replace cable.
	Wrong SOURCE option is being used.	Try all SOURCE options. See SETUP menu on page 18 for details.

Recording Problems

Observed Condition	Possible Cause	Probable Solution
Camcorder image is not shown.	Camcorder is off.	Turn camcorder on and operate properly.
Camcorder image via A/V input to VCR is not shown on TV screen.	VCR SOURCE is not set to AUX.	Use CH (▼/▲) to select AUX A/V input channel.
Timer recording is not possible.	Clock in VCR is not set to correct time.	Set clock to correct time. See CLOCK menu on page 16.
	VCR is on which disables timer.	Turn VCR off to enable timer. TIMER indicator light appears in the VCR front panel.
	Timer has been programmed incorrectly.	Reprogram Timer. See TIMER menu on page 17.
TIMER indicator light does not appear after programming timer.		Reprogram Timer and turn VCR off to enable timer.
TIMER indicator light appears after VCR is turned off.	VCR is in Timer Recording mode.	This is the normal indication that the VCR is in TIMER mode.

Stereo Audio Record and/or Playback Problems

Observed Condition	Possible Cause	Probable Solution
Stereo is not present.	TV is not Stereo-compatible.	No action is possible.
	Program is not in stereo format.	No action is possible.
	VCR A/V Out jacks are not connected to TV A/V In jacks.	Make A/V connections. Stereo is available only via A/V output from VCR.
	VCR Audio/Video Out is not selected for viewing at the TV.	Select AUX or A/V source as TV input.
	VCR AUDIO RECORD mode is set to SAP or MONAURAL.	Set VCR AUDIO RECORD mode to Stereo. See AUDIO Menu on page 19.

Troubleshooting

Some quick and easy tips to fixing problems yourself.

Moisture Condensation

Moisture condensation can occur:	In locations where moisture condensation may occur:
<ul style="list-style-type: none"> • When the video recorder is moved from a cold place to a warm place. • Under extremely humid conditions. 	<ul style="list-style-type: none"> • Keep the power cord plugged into an AC outlet and POWER On. This will help prevent condensation. • When condensation has occurred, wait a few hours for the VCR to dry before using it.

Magnetic Field from Other Equipment

Keep the VCR and videotapes away from strong magnetic fields, such as those produced by a vacuum cleaner, refrigerator, or air conditioner.

Video Head Cleaning

Your VCR automatically cleans the heads as it is used. However, after long periods of use, your video heads may become clogged with accumulated dirt, causing distortion. When this occurs, use a do-it-yourself wet-type head cleaning cassette available from your Zenith dealer.

Caution:

Do not use a dry-type head-cleaning system. It may seriously damage the VCR and cassettes used in the VCR. Snow, streaking in picture, and horizontal pulling indicate the need for professional video head cleaning. See your Zenith approved service center for cleaning.

Cabinet Cleaning

Clean the outside surfaces of the VCR with a soft lint-free cloth as required. Use care not to scratch the VCR during cleaning.

Specifications

GENERAL

Head System		Two head (VRB211), Four head (VRB411, VRB412, VRB421)
Power Source		AC 120V, 60Hz
Power Consumption		Approx. 17 Watts (VRB421), 15 Watts (VRB411, VRB412, VRB211)
Dimensions	(WxHxD)	360 x 94 x 270 mm (14.2" x 3.7" x 10.6")
Operating Temperature		5 °C~35 °C (41 °F~95 °F)
Operating Humidity		Less than 80% RH
Timer		12-hour display type with AM, PM
Weight		Approx. 3.4 kg (7.5 lbs)
Tape Speed	(SP)	33.35 mm/sec
	(LP)	16.67 mm/sec
	(EP)	11.12 mm/sec
Tape Width		12.7 mm
Maximum Recording Time	(SP)	2 HOURS (T-120)
	(EP)	6 HOURS (T-120)
		8 HOURS (T-160)
Rewind Time		Less than 210 seconds (T-120)

TUNER

Antenna	(UHF)	75 ohms
	(VHF)	75 ohms
VHF Output Signal Channel Coverage		Channel 3 or 4
	(VHF)	2-13
	(UHF)	14-69
	(CATV)	1-125 (4A, A-W, W+1~W+84, A-5~A-1)

VIDEO

Video Signal System		EIA Standard (525 lines, 60 fields) NTSC type color signal
Input		1.0 Vp-p 75 ohms unbalanced
Output		1.0 Vp-p 75 ohms unbalanced
Signal to Noise Ratio		More than 43 dB (SP mode)

AUDIO

FM audio (VRB421 only)		
Frequency Range		20Hz to 20kHz
Dynamic Range		More than 83 dB
Channel Separation		More than 55 dB
Conventional audio		
Input	(LINE)	-6.0 dBm more than 47 kohms
Output	(LINE)	-6.0 dBm less than 1.5 kohms
S/N Ratio		More than 43 dB (SP mode)
Frequency Range		200 Hz to 10kHz (SP mode)

Supplied Accessory		Hook-up Cable (VCR to TV) (1) Batteries (2) Remote Control (1)
---------------------------	--	--

* Designs and specifications are subject to change without notice.
* Weight and dimensions shown are approximate.

Recommended VCR Accessories



VHS TAPE REWINDER

Most repair work on VCRs and Camcorders is due to excessive rewinding. Prolong the life of your video equipment with our rewinder!

ZEN 901 **ONLY \$14.99** PLUS \$6.95 SHIPPING & HANDLING

WIRELESS INTERCOM SET

Kids watching movies in another room? Baby in another room as you watch TV? Keep tabs on them with our inexpensive intercom set.

- FM wireless two stations, 3 channels, plug into standard AC outlets
- Relatively noiseless transmission for excellent sound
- Upgrades to four stations with additional set
- Units wall mount or set on table

ALG 1188 **ONLY \$49.99** PLUS \$6.95 SHIPPING & HANDLING

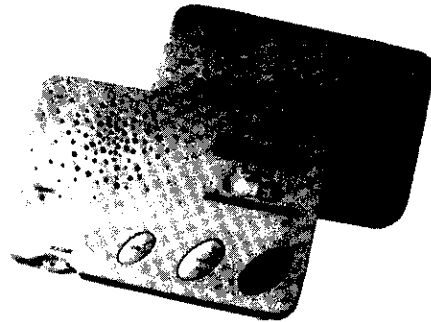

ZENITH 5 FUNCTION REMOTE

Broken or lost remote? Need a second remote or more functions? Order direct from Zenith!!

- Operates TV, VCR, CD, DVD, DIVX, DSS & Cable Box
- Operates PIP and Most Screen Menus
- Extended Range & MORE!!!

Orders 1 year or more after product purchase may receive upgraded models. Other Remotes with 3, 4, 5 & 7 Functions Available Upon Request

ZEN 525 **ONLY \$19.99** PLUS \$6.95 SHIPPING & HANDLING

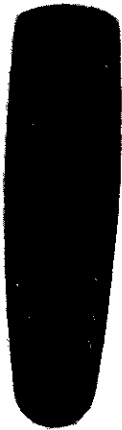

zenith



ORDER TODAY!

CALL OR FAX TOLL-FREE

1.800.255.6790

Fax 1.888.693.6484

mail: parts.sales@zenith.com

Use Your Visa or MasterCard to Order



PLEASE ALLOW 3 - 4 WEEKS FOR DELIVERY



Notes

Notes

A large, empty rectangular box with a thin black border, intended for taking notes. The box is mostly blank, with a small black rounded rectangle at the top left corner containing the word "Notes".

Notes

Your Zenith Limited Warranty

VIDEO CASSETTE RECORDER OR PLAYER

Welcome into the Zenith family! We believe that you will be pleased with your new Zenith Entertainment Machine. Please read this warranty carefully, it is a "LIMITED WARRANTY" as defined under Federal Law. This warranty gives you specific legal rights, and you may also have other rights that vary from state to state within the U.S.A.

ZENITH'S RESPONSIBILITY

- Service Labor** During a period of 90 days from effective warranty date, Zenith will provide service labor by a Zenith authorized service center when needed as determined by Zenith, as a result of manufacturing defects.
- Parts** New or remanufactured replacements for factory-defective parts will be supplied by a Zenith authorized service center for one year from effective warranty date. Such replacement parts are warranted for the remaining portion of the original warranty period.
- Not Covered** This warranty covers manufacturing defects and does not cover installation, adjustment of customer controls in the home, installation or repair of home antenna systems, cable converters or cable company-supplied equipment; it also does not cover damage due to misuse, abuse, negligence, acts of God or other causes beyond the control of Zenith. Any alteration of the product after manufacture voids this warranty in its entirety.

OWNER'S RESPONSIBILITY

- Effective Warranty Date** Warranty begins on the date of original consumer purchase. For your convenience, keep the dealer's dated bill of sale or a delivery ticket as evidence of the purchase date.
- Operating Guide** Read your Operating Guide carefully so that you will understand the operation of your set and how to adjust the customer controls.
- Carry-In Service** The video product must be taken to a U.S. or Canadian Zenith authorized service center for warranty service and must be picked up by the owner.
- TV Set Performance** It is the owner's responsibility to maintain the TV receiver with which the video product is used, and the associated antenna system, in proper operating condition..
- Important** Product Registration—Please fill out and mail your Product Registration Card. It is imperative that Zenith know how to reach you promptly if we should discover a safety problem that could affect you.
- Warranty Service** For warranty service information, contact any Zenith authorized service center. Parts and service labor that are Zenith's responsibility (see above) will be provided without charge. Other service is at the owner's expense. If you have any problem in obtaining satisfactory warranty service, call or write the Zenith Response Center. You must provide the model number, serial number and date of purchase or date of original installation. Before you ask for warranty service, read "Maintenance And Troubleshooting" in your operating guide. You might avoid a service call.

THIS WARRANTY IS IN LIEU OF ANY OTHER WARRANTY, EXPRESS OR IMPLIED, INCLUDING WITHOUT LIMITATION, ANY WARRANTY OF MERCHANTABILITY OR FITNESS FOR A PARTICULAR PURPOSE, AND ZENITH SHALL NOT BE LIABLE FOR ANY CONSEQUENTIAL, INDIRECT, OR INCIDENTAL DAMAGES OF ANY KIND, INCLUDING LOST REVENUES OR PROFITS IN CONNECTION WITH THE PRODUCT.

**Zenith Electronics Corporation
Customer Service Department
1000 Milwaukee Avenue
Glenview, Illinois 60025-2493
Telephone: (847) 391-8752
Mon-Fri, 8:00 a.m. - 4:30 p.m. Central Time**