

Use & Care Guide
Manual de Uso y Cuidado
Guide d'Utilisation et d'Entretien
English / Español / Français

Models/Modelos/Modèles: 795.5109*

Kenmore Elite®

Side-by-Side Refrigerator

Refrigerador de Dos Puertas

Réfrigérateur Phase Par Phase

* = color number, número de color, le numéro de la couleur

P/N MFL63729002

Sears Brands Management Corporation
Hoffman Estates, IL 60179 U.S.A.

www.kenmore.com
www.sears.com

Sears Canada Inc.
Toronto, Ontario, Canada M5B 2B8
www.sears.ca



TABLE OF CONTENTS

Warranty	3	Airtight Crisper and Airtight Crisper cover	26
Protection Agreements	4	Refrigerator Shelves	26 - 27
Important Safety Instructions	5	Freezer Shelf	27
Grounding Requirements	6	Filter	28 - 29
Refrigerator Installation	7 - 14	Water Filter	28
Unpacking your Refrigerator	7	Performance Data Sheet	29
Installation	7	Care and cleaning	30 - 31
Base grille installation	7	General cleaning tips	30
Leveling the refrigerator door	8	Outside	30
Handle removal	8	Inside walls	30
Removing and replacing Refrigerator Doors	9 - 10	Door liners and gaskets	30
Door alignment	11	Plastic parts	30
Connecting the water line	12	Back cover	30
Before you begin	12	Light (LED) replacement	30
What you will need	12	Power interruptions	30 - 31
Installation instructions	13 - 14	When you go on vacation	31
Refrigerator Features	15	When you move	31
Using Your Refrigerator	16 - 28	When you should set the icemaker power switch to OFF (O)	31
Ensuring proper air circulation	16	Normal sounds you may hear	31
Control Panel features	16 - 21	Troubleshooting guide	32 - 36
User Interface Display	16 - 17		
Display Program	18 - 21		
Adjusting Control settings	22		
Food storage guide	23		
Storing frozen food	23		
Water and Ice Dispenser	24		
Ice Storage Bin	25		
Door Rack and Support	25		
Snack Pan	25		
Crisper and Crisper cover	25 - 26		

WARRANTY



SIDE-BY-SIDE REFRIGERATOR

Kenmore Elite Limited Warranty

When installed, operated and maintained according to all instructions supplied with the product, if any non-consumable part of this appliance other than the sealed refrigerant system fails due to a defect in material and workmanship within one year from the date of purchase, call 1-800-4-MY-HOME® to arrange for free repair. This coverage applies for only 90 days from the date of purchase if this appliance is ever used for other than private family purposes.

If the sealed refrigerant system is defective within five years from the purchase date, call 1-800-4-MY-HOME® to arrange for free repair. This coverage applies for only one year from the date of purchase if this appliance is ever used for other than private family purposes.

This warranty covers only defects in material and workmanship. Sears will NOT pay for:

1. Expendable items that can wear out from normal use, including but not limited to filters, belts, light bulbs, and bags.
2. A service technician to instruct the user in correct product installation, operation or maintenance.
3. A service technician to clean or maintain this product.
4. Damage to or failure of this product if it is not installed, operated or maintained according to the all instructions supplied with the product.
5. Damage to or failure of this product resulting from accident, abuse, misuse or use for other than its intended purpose.
6. Damage to or failure of this product caused by the use of detergents, cleaners, chemicals or utensils other than those recommended in all instructions supplied with the product.
7. Damage to or failure of parts or systems resulting from unauthorized modifications made to this product.

Disclaimer of implied warranties; limitation of remedies

Customer's sole and exclusive remedy under this limited warranty shall be product repair as provided herein. Implied warranties, including warranties of merchantability or fitness for a particular purpose, are limited to one year or the shortest period allowed by law. Sears shall not be liable for incidental or consequential damages. Some states and provinces do not allow the exclusion or limitation of incidental or consequential damages, or limitation on the duration of implied warranties of merchantability or fitness, so these exclusions or limitations may not apply to you.

This warranty applies only while this appliance is used in the United States or Canada.

This warranty gives you specific legal rights, and you may also have other rights which vary from state to state.

**Sears Brands Management Corporation, Hoffman Estates, IL 60179
Sears Canada Inc., Toronto, Ontario, Canada M5B 2B8**

PROTECTION AGREEMENTS

Master Protection Agreements

Congratulations on making a smart purchase. Your new Kenmore® product is designed and manufactured for years of dependable operation. But like all products, it may require preventive maintenance or repair from time to time. That's when having a Master Protection Agreement can save you money and aggravation.

The Master Protection Agreement also helps extend the life of your new product. Here's what the Agreement* includes:

- Parts and labor** needed to help keep products operating properly **under normal use**, not just defects. Our coverage goes **well beyond the product warranty**. No deductibles, no functional failure excluded from coverage - **real protection**.
- Expert service** by a force of more than 10,000 authorized **Sears service technicians**, which means someone you can trust will be working on your product.
- Unlimited service calls and nationwide service**, as often as you want us, whenever you want us.
- "No-lemon" guarantee** - replacement of your covered product if four or more product failures occur within twelve months.
- Product replacement** if your covered product can't be Fixed.
- Annual Preventive Maintenance Check** at your Request - no extra charge.
- Fast help by phone** - we call it **Rapid Resolution** - phone support from a Sears representative on all products. Think of us as a "talking owner's manual."
- Power surge protection** against electrical damage due to power fluctuations.
- \$250 Food Loss Protection** annually for any food spoilage that is the result of mechanical failure of any Covered refrigerator or freezer.
- Rental reimbursement** if repair of your covered product takes longer than promised.
- 10% discount** off the regular price of any non-covered repair service and related installed parts.

Once you purchase the Agreement, a simple phone call is all that it takes for you to schedule service. You can call anytime day or night, or schedule a service appointment online.

The Master Protection Agreement is a risk free purchase. If you cancel for any reason during the product warranty period, we will provide a full refund. Or, a prorated refund anytime after the product warranty period expires. Purchase your Master Protection Agreement today!

Some limitations and exclusions apply. For prices and additional information in the U.S.A. call 1-800-827-6655.

***Coverage in Canada varies on some items. For full details call Sears Canada at 1-800-361-6655.**

Sears Installation Service

For Sears professional installation Of home appliances, garage door openers, water heaters, and other major home items, in the U.S.A. or Canada call **1-800-4-MY-HOME®**.

PRODUCT RECORD

In the space below, record the date of purchase, model and serial number of your product. You will find the model and serial number printed on an identification label located on the right-hand side of the refrigerator compartment. Have these items of information available whenever you contact Sears concerning your product.

Model No. _____

Date of Purchase _____

Serial No. _____

Dealer _____

Save these instructions and attach your sales receipt for future reference.

IMPORTANT SAFETY INSTRUCTIONS

This guide contains many important safety messages. Always **read and obey**.



This is the safety alert symbol. It alerts you to safety messages that inform you of hazards that can kill or hurt you or others, or cause damage to the product. All safety messages will be preceded by the safety alert symbol and the hazard signal word DANGER, WARNING, or CAUTION. These words mean:

⚠ DANGER You will be killed or seriously injured if you do not follow instructions.

⚠ WARNING You can be killed or seriously injured if you do not follow instructions.

⚠ CAUTION Indicates an imminently hazardous situation which, if not avoided, may result in minor or moderate injury, or product damage only.

All safety messages will identify the hazard, tell you how to reduce the change of injury and tell you what can happen if the instructions are not followed.

⚠ WARNING

To reduce the risk of fire, electric shock or injury to persons when using your product, basic safety precautions should be followed, including the following. Read all instructions before using this appliance:

- NEVER unplug your refrigerator by pulling on the power cord. Always grip the plug firmly and pull it straight out from the outlet.
- Repair or replace immediately all electric service cords that have become frayed or otherwise damaged. Do not use a cord that shows cracks or abrasion damage along its length or at either the plug or connector end.
- When moving your refrigerator away from the wall, be careful not to roll over or damage it in any way.
- Do not crush or damage the water line.
- Do not store or use gasoline or other flammable vapors or liquids in the vicinity of this or any other appliance.
- Do not allow children to climb, stand or hang on the refrigerator doors or shelves in the refrigerator. They could damage the refrigerator and seriously injure themselves.
- Keep fingers out of 'pinch point' areas; clearances between the doors and cabinet are necessarily small. Be careful when you open the doors when children are in the area.
- Unplug your refrigerator before cleaning or making any repairs.

NOTE: We strongly recommend that any servicing be performed by a qualified individual.

- Do not store bottles in the freezer compartment, they may break when frozen, causing damage.
- The refrigerator-freezer should be positioned so that the supply plug is accessible for quick disconnection if an accident happens.
- For personal safety, this appliance must be properly grounded. Have the wall outlet and the circuit checked by a qualified electrician to make sure the outlet is properly grounded.

- This refrigerator must be properly installed in accordance with the 'Attention Installer' instructions that were taped to the front of the refrigerator.
- After your refrigerator is in operation, do not touch the cold surfaces in the freezer compartment when hands are damp or wet. Skin may adhere to the extremely cold surfaces.
- In refrigerator with automatic icemakers, avoid contact with the moving parts of the ejector mechanism, or with the heating element that releases the cubes. DO NOT place fingers or hands on the automatic ice making mechanism while the refrigerator is plugged in.
- DO NOT refreeze frozen foods which have thawed completely. The United States Department of Agriculture in Home and Garden Bulletin No. 69 says:
"...You may safely refreeze frozen foods that have thawed if they still contain ice crystals or if they are still cold below 40 °F (4 °C)."
"Thawed ground meats, poultry, or fish that have any off-odor or off-color should not be frozen and should not be eaten. Thawed ice cream should be discarded. If the odor or color of any food is poor or questionable, get rid of it. The food may be dangerous to eat."
"Even partial thawing and refreezing reduces the eating quality of foods, particularly fruits, vegetables and prepared foods. The eating quality of red meats is affected less than that of many other foods. Use refrozen foods as soon as possible to save as much of their quality as you can."

SAVE THESE INSTRUCTIONS

⚠ CAUTION

This appliance is not intended for use by persons (including children) with reduced physical, sensory or mental capabilities, or lack of experience and knowledge, unless they have been given supervision or instruction concerning use of the appliance by a person responsible for their safety.

Children should be supervised to ensure that they do not play with the appliance.

⚠ DANGER: RISK OF CHILD ENTRAPMENT

Child entrapment and suffocation are not problems of the past. Junked or abandoned refrigerators are still dangerous... even if they will sit for "just a few days". If you are getting rid of your old refrigerator, please follow the instructions at right to help prevent accidents.

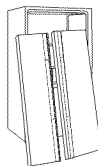

Before you throw away your old Refrigerator or freezer:

- Take off the doors.
- Leave the shelves in place so that children may not easily climb inside.

CFC DISPOSAL

Your old refrigerator may have a cooling system that used CFCs (chlorofluorocarbons). CFCs are believed to harm stratospheric ozone. If you are throwing away your old refrigerator, make sure the CFC refrigerant is removed for proper disposal by a qualified servicer. If you intentionally release this CFC refrigerant, you can be subject to fines and imprisonment under provisions

of environmental legislation. This appliance contains fluid (refrigerant, lubricant), and is made of parts and materials which are reusable and / or recyclable. All the important materials should be sent to the collection center of waste material and can be reused after rework (recycling). To recycle, please contact your local agency.

GROUNDING REQUIREMENTS

IMPORTANT: Please read carefully.

TO CONNECT ELECTRICITY

⚠ WARNING

Electrical Shock Hazard

FOR PERSONAL SAFETY, this appliance must be properly grounded. Have the wall outlet and the circuit checked by a qualified electrician to make sure the outlet is properly grounded.

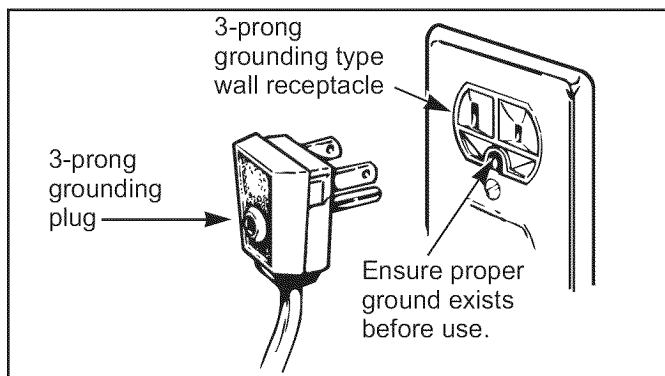

USE OF EXTENSION CORDS

Because of potential safety hazards under certain conditions, we strongly recommend against the use of an extension cord. However, if you still elect to use an extension cord, it is absolutely necessary that it be a UL-listed (in the United States), 3-wire grounding type appliance extension cord having a grounding type plug and outlet, and that the electrical rating of the cord be 15 amperes (minimum) and 120 volts.

Use of an extension cord will increase the clearance needed for the back of the refrigerator. If the supply cord is damaged, it must be replaced by the manufacturer or its service agent or a similarly qualified person in order to avoid any hazard.

RECOMMENDED GROUNDING METHOD

The refrigerator should always be plugged into its own individual properly grounded electrical outlet rated for 115 volts, 60Hz, AC only and fused at 15 or 20 amperes. This provides the best performance and also prevents overloading house wiring circuits which could cause a fire hazard from overheated wires. It is recommended that a separate circuit serving only this appliance be provided. Use a receptacle which cannot be turned off with a switch or pull chain. Do not use an extension cord.

Where a standard two-prong wall outlet is encountered, it is your personal responsibility and obligation to have it replaced with a properly grounded three-prong wall outlet. Do not, under any circumstances, cut or remove the third (Ground) prong from the power cord.

NOTE: Before performing any type of installation or cleaning, turn the control to OFF (Demo Mode), and then disconnect the refrigerator from the electrical source. When you are finished, reconnect the refrigerator to the electrical source and reset the control to the desired setting.

REFRIGERATOR INSTALLATION

⚠ WARNING

Excessive Weight Hazard

Use two or more people to move and install the refrigerator.
Failure to do so can result in back or other injury.

UNPACKING YOUR REFRIGERATOR

Remove tape and any temporary labels from your refrigerator before using. Do not remove any warning type labels, the model and serial number label, or the Technical Data sheet located under the front part of the refrigerator, behind the base grille.

To remove any remaining tape or glue, rub the area briskly with your thumb. Tape or glue residue can also be easily removed by rubbing a small amount of liquid dish soap over the adhesive with your fingers. Wipe with warm water and dry.

Do not use sharp instruments, rubbing alcohol, flammable fluids or abrasive cleaners to remove tape or glue. These products can damage the surface of your refrigerator. For more information, see the **Important Safety Instructions** section.

Refrigerator shelves are installed in the shipping position.

Please reinstall shelves according to your individual storage needs.

⚠ WARNING

When Moving Your Refrigerator

Your refrigerator is heavy. When moving the refrigerator for cleaning or service, be sure to protect the floor. Always pull the refrigerator straight out when moving it. Do not wiggle or walk the refrigerator when trying to move it, as floor damage could occur.

⚠ WARNING



Explosion Hazard

Keep flammable materials and vapors, such as gasoline, away from refrigerator.

Failure to do so can result in death, explosion or fire.

INSTALLATION

1. Avoid placing unit near heat sources, direct sunlight or moisture.
2. To minimize noise and vibration, the refrigerator **MUST** be installed on a solidly constructed floor.
3. Carpeting and soft tile surfaces are not recommended.
4. **NEVER** install the refrigerator on a platform or a weakly supported structure.
5. Install this appliance in an area where the temperature is between 55°F (13°C) and 110°F (43°C). If the temperature around the appliance is too low or high, cooling ability may be adversely affected.

NOTE: For proper air circulation, best cooling and energy consumption results, maintain a minimum distance of 2 inches (5.08cm) from adjacent items and surfaces.

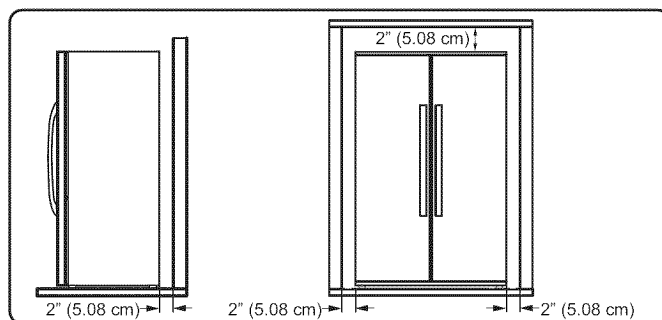

⚠ WARNING

- Be careful when you work with the hinge, base grille, stopper, etc. You may be injured.
- Do not put hands or metal sticks into air vents, base grille or bottom of the refrigerator. You may be injured or receive an electrical shock.

BASE GRILLE INSTALLATION

To install or replace base grille:

1. Remove the 2 screws from the bottom front part of refrigerator.
2. Place base grille into position and insert and tighten screws.

To remove the base grille

1. Open the doors. (Refrigerator and freezer)
2. Once doors are open, remove screws from base grille. Remove base grille and set safely aside.
3. Reattach screws to the base of refrigerator.

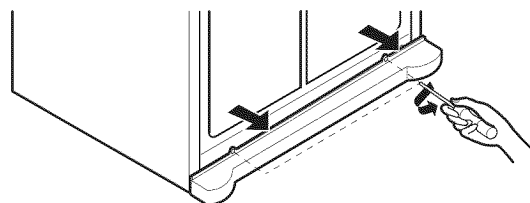

REFRIGERATOR INSTALLATION

LEVELING THE REFRIGERATOR DOOR

Place level on refrigerator shelf as shown below.

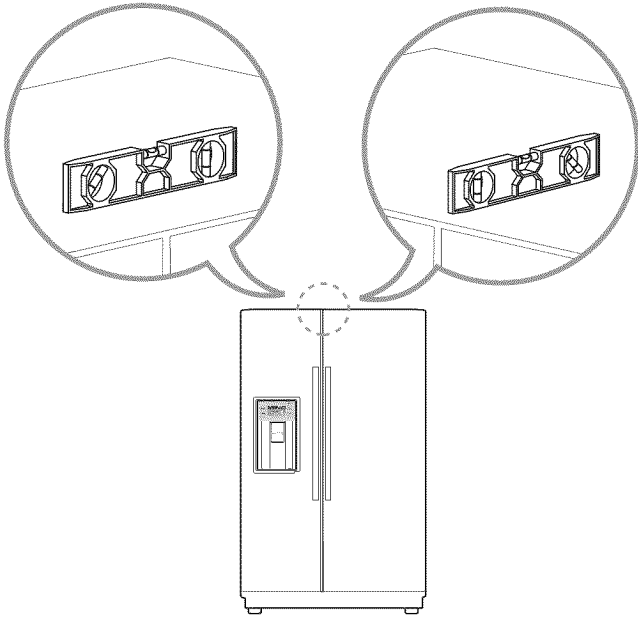

If your refrigerator is not level, insert a flat blade screwdriver into the grooves of the leveling legs (shown in picture below). Rotate legs clockwise to raise or counterclockwise to lower the front of the refrigerator.

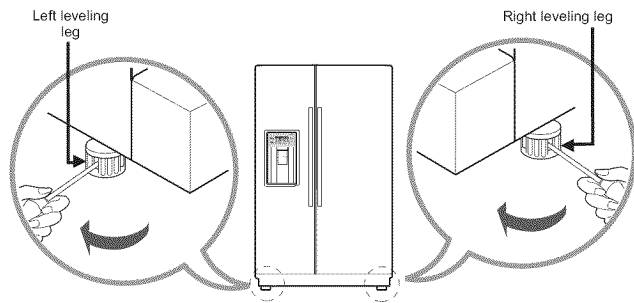

Raise the front of the refrigerator enough so the doors close freely when opened halfway. The refrigerator should slope $\frac{1}{4}$ " (6.35 mm) to $\frac{1}{2}$ " (12.7 mm) from front to back. Then level the refrigerator from side to side.

HANDLE REMOVAL

You may have to remove the door handles to move the refrigerator through a narrow opening. See instructions below.

NOTE: To avoid damaging door surfaces when moving the refrigerator through narrow openings, it is ALWAYS recommended to remove the doors as instructed in the next two pages.

- Loosen the set screws with a $\frac{3}{32}$ " (2.38 mm) Allen wrench and remove the handle.

NOTE: If the handle mounting fasteners need to be tightened or moved, use a $\frac{1}{4}$ " (6.35 mm) Allen wrench.

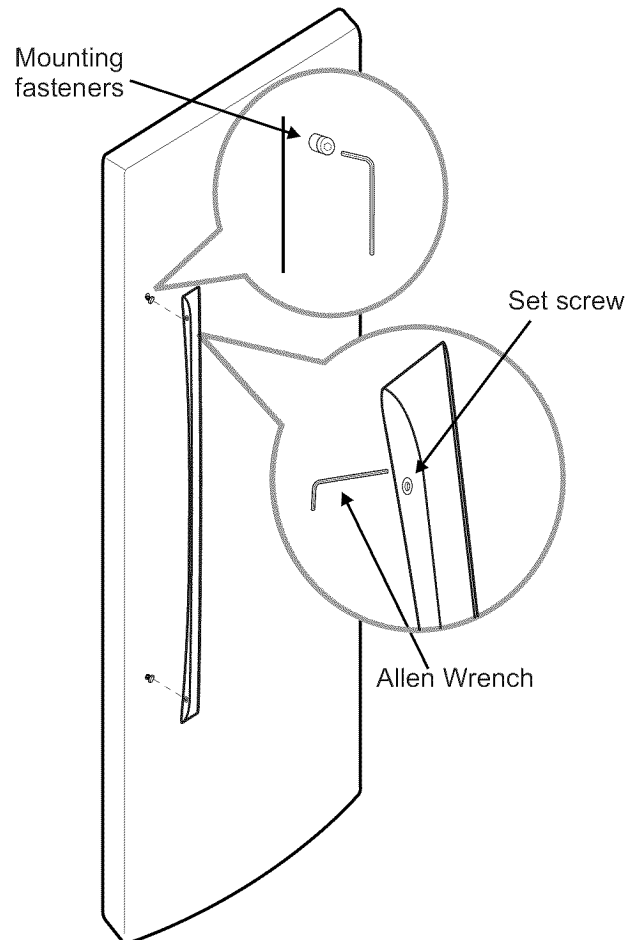

REFRIGERATOR INSTALLATION

⚠ WARNING

Electric Shock Hazard

- Disconnect electrical supply to the refrigerator before installing. Failure to do so could result in death or serious injury.
- Do not put hands, feet or other objects into the air vents, base grille, or bottom of the refrigerator. You may be injured or receive an electrical shock.
- Be careful when you work with the hinge, base grille, and stopper. You may be injured.

REMOVING AND REPLACING REFRIGERATOR DOORS

Before removing the doors, remove the base grille. See **BASE GRILLE INSTALLATION** for reference.

To remove the right (refrigerator) door:

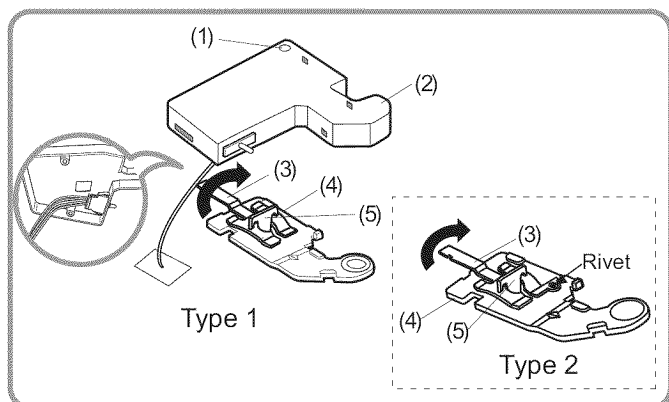

1. Open the door. Remove the top hinge cover screw (1).
2. Use a flat blade screwdriver to pry back the hooks (not shown) on the cabinet underside of the cover (2). Lift up the cover.
3. Rotate the hinge lever (3) clockwise. Lift the top hinge (4) free of the hinge lever latch (5).

NOTE: Regardless of hinge lever type, removal process is the same.

4. Lift the door from the lower hinge pin.
5. Place the door, inside facing up, on a nonscratching surface.

⚠ CAUTION: When lifting the hinge free of the latch, be careful that the door does not fall forward.

Removing the left (freezer) door with water line connection.

- Pull up the water feed tube while pressing area (Figure 1) as shown in the figure below.
- **NOTE:** If a tube end is deformed or abraded, trim the part away. Disconnecting the tube under the door causes about 0.13 gallons (0.5 liters) water to flow out. Put a large container at end of tube to prevent water from draining onto the floor.

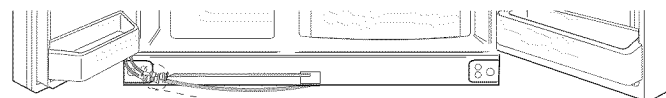
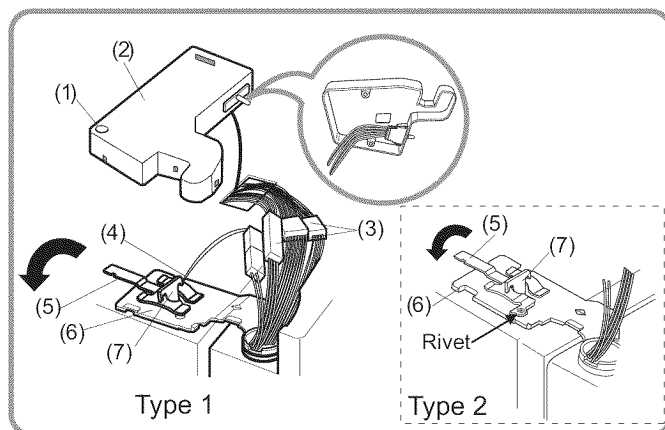
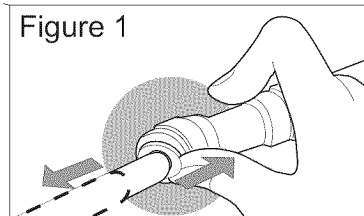

Figure 1



1. Open the door. Remove the top hinge cover screw (1).
2. Use a flat blade screwdriver to pry back the hooks (not shown) on the cabinet underside of the cover (2). Lift up the cover.
3. Disconnect all the wire harnesses (3).
4. Remove the grounding screw (4).
5. Rotate hinge lever (5) counterclockwise. Lift the top hinge (6) free of the hinge lever latch (7).

NOTE: Regardless of hinge lever type, removal process is the same.

⚠ CAUTION: When lifting the hinge free of the latch, be careful that the door does not fall forward.

6. Lift the door from the lower hinge pin being careful to pull the water lines through the lower hinge pin.
7. Place the door, inside facing up, on a nonscratching surface.

REFRIGERATOR INSTALLATION

Reinstalling the right (Refrigerator) door

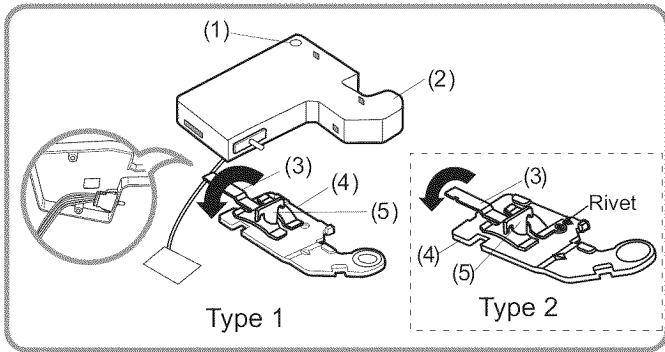

1. Place the door onto the lower hinge pin.
2. Fit top hinge (4) over hinge lever latch (5) into place. Rotate lever (3) counterclockwise to secure hinge.

NOTE: Regardless of hinge lever type, removal process is the same.

3. Hook tab on switch side of corner under edge of wire opening in cabinet top. Position cover (2) into place. Insert and tighten cover screw (1).

3. Install the grounding screw (4) and connect all the wire harnesses (3).
4. Hook tab on door switch side of cover (2) under edge of wire opening in cabinet top. Position cover into place. Insert and tighten cover screw (1).
5. Reconnect the water tubes by inserting the tubes into the connectors.

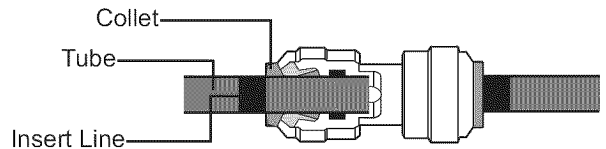

Reinstalling the left (Freezer) door

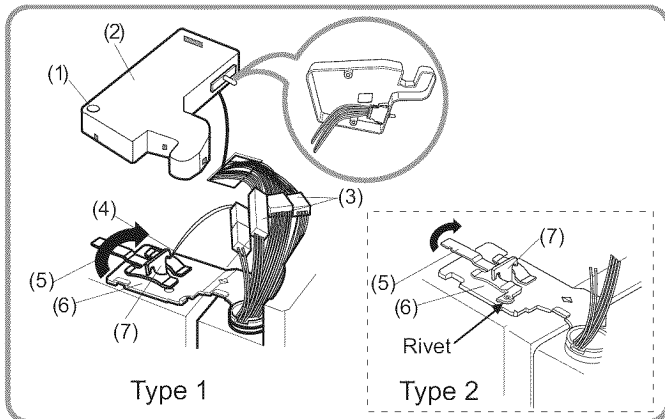

1. Feed the water tubes through the lower hinge pin and place the door onto the lower hinge pin.
2. Fit top hinge (6) over hinge lever latch (7) and into place. Rotate lever (5) clockwise to secure hinge

NOTE: Regardless of hinge lever type, removal process is the same.

REFRIGERATOR INSTALLATION

DOOR ALIGNMENT

Remove the base grille before adjusting the doors. See **BASE GRILLE INSTALLATION** for reference.

Two methods of door alignment are available based on the amount of adjustment needed and installation requirements.

Type 1

Adjusting tool: Flat blade screwdriver

If the freezer compartment door is lower than the refrigerator compartment door, level them by inserting a flat blade screwdriver into the groove of the left leveling leg and rotating it clockwise.

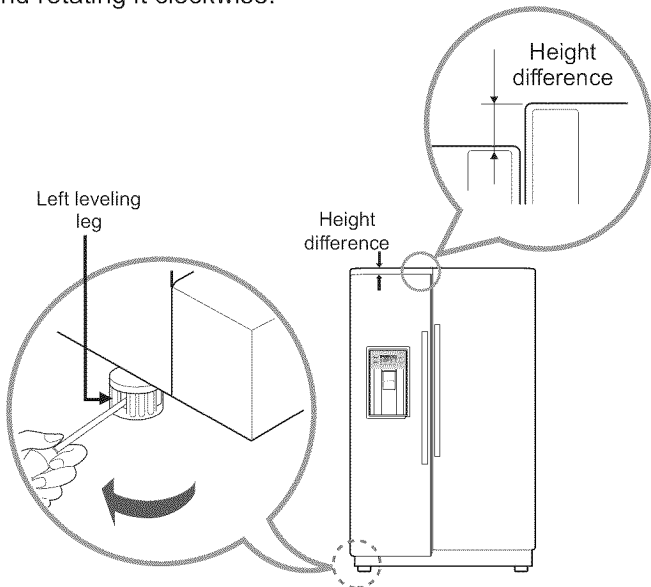

If the freezer compartment door is higher than the refrigerator compartment door, level them by inserting a flat blade screwdriver into the groove of the right leveling leg and rotating it clockwise.

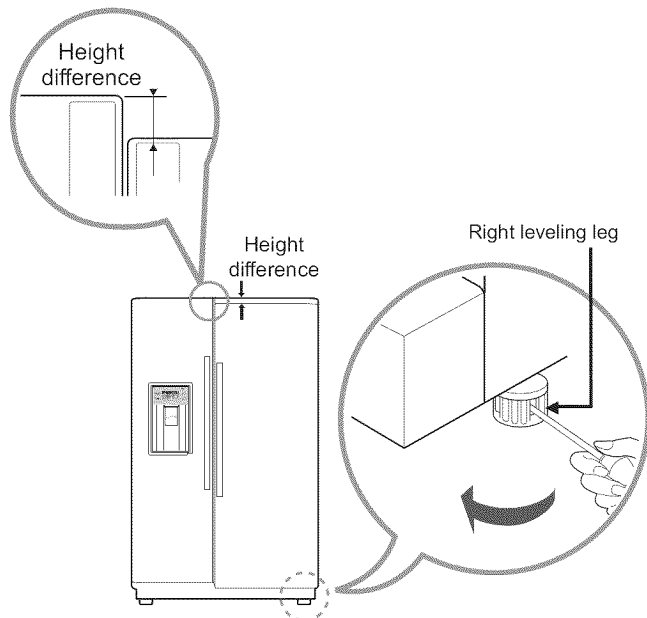

Type 2

Adjusting tools: $\frac{5}{16}$ " (8 mm) Wrench and Wrench $\frac{3}{4}$ " (19 mm)

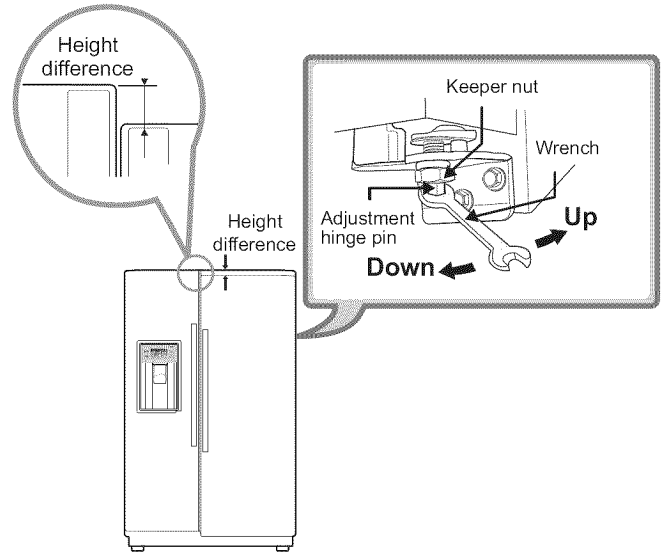

Using a $\frac{3}{4}$ " (19 mm) wrench, turn the keeper nut clockwise to loosen the keeper nut.

Using a $\frac{5}{16}$ " (8 mm) wrench, turn the adjustment hinge pin clockwise or counterclockwise to level the refrigerator and freezer door.

After leveling the door, turn the keeper nut counterclockwise to tighten.

CAUTION: Do not overtighten the door adjustment screw. The hinge pin can be pulled out. (Adjustable range of height is a maximum of $\frac{1}{2}$ " (1.27 cm)).

AFTER LEVELING THE DOOR HEIGHT

Confirm all legs are in contact with the floor.

REFRIGERATOR INSTALLATION

CONNECTING THE WATER LINE

NOTE: Water line installation is needed when the Automatic Icemaker and/or Water Dispenser features are available on your product.

BEFORE YOU BEGIN

This water line installation is not warranted by the refrigerator or icemaker manufacturer or seller. Follow these instructions carefully to minimize the risk of expensive water damage.

Water hammer (water banging in the pipes) in house plumbing can cause damage to refrigerator parts and lead to water leakage or flooding. Call a qualified plumber to correct water hammer before installing the water supply line to the refrigerator.

To prevent burns and product damage, do not hook up the water line to the hot water line.

If you use your refrigerator before connecting the water line, make sure the icemaker power switch is in the **OFF (O)** position.

Do not install the icemaker tubing in areas where temperatures fall below freezing.

When using any electrical device (such as a power drill) during installation, be sure the device is double-insulated or grounded in a manner to prevent the hazard of electric shock, or is battery-powered.

All installations must be in accordance with local plumbing code requirements.

NOTE: Wear eye protection.

• **If a reverse osmosis water filtration system** is connected to your cold water supply, the water line installation is not warranted by the refrigerator or icemaker manufacturer or seller. Follow next instruction carefully to minimize the risk of expensive water damage.

• **If a reverse osmosis water filtration system** is connected to your cold water supply, the water pressure to the reverse osmosis system needs to be a minimum of 40 to 60 PSI (2.8 kg·f/cm² ~ 4.2 kg·f/cm², less than 2~3 sec to fill a cup of 7 oz capacity).

If the water pressure from the reverse osmosis system is less than 21 PSI (1.5 kg·f/cm², more than 4 sec to fill a cup of 7 oz capacity):

- Check to see whether the sediment filter in the reverse osmosis system is blocked. Replace the filter if necessary.
- Allow the storage tank on the reverse osmosis system to refill after heavy usage.
- If the issue about water pressure from reverse osmosis remains, call a licensed, qualified plumber.

WHAT YOU WILL NEED

- **Copper Tubing**, 1/4" (6.35 mm) outer diameter to connect the refrigerator to the water supply. Be sure both ends of the tubing are cut square.

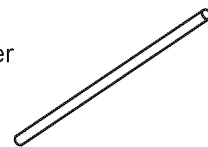

To determine how much tubing you need, measure the distance from the water valve on the back of the refrigerator to the water supply pipe. Then add 8 feet (2.4 m). Be sure there is sufficient extra tubing (about 8 feet [2.4 m] coiled into 3 turns of about 10" [25 cm] diameter) to allow the refrigerator to move out from the wall after installation.

Be sure that the kit you select allows at least 8 feet (2.4 m) as described above.

- **A cold water supply.** The water pressure must be between 20 and 120 PSI (1.4 bar and 8.2 bar) on models without a water filter and between 40 and 120 PSI (2.8 bar and 8.2 bar) on models with a water filter.

- **Power drill.**

- **1/2" (12.7 mm) or Adjustable Wrench.**

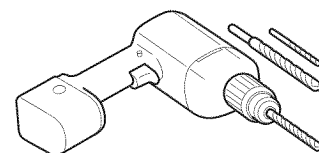

- **Flat head and Phillips screwdrivers.**

- **Two 1/4" (6.35 mm) outer diameter compression nuts and 2 ferrules (sleeves)** to connect the copper tubing to the shutoff valve and the refrigerator water valve.

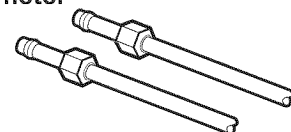

- If your existing copper water line has a flared fitting at the end, you will need an **adapter** (available at plumbing supply stores) to connect the water line to the refrigerator OR you can cut off the flared fitting with a tube cutter and then use a compression fitting.

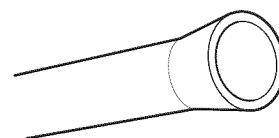

- **Shutoff valve to connect to the cold water line.** The shutoff valve should have a water inlet with a minimum inside diameter of 5/32"

(3.96 mm) at the point of connection to the COLD WATER LINE. Saddle-type shutoff valves are included in many water supply kits. Before purchasing, make sure a saddle-type valve complies with your local plumbing codes.

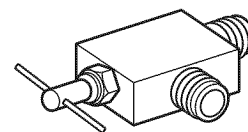

REFRIGERATOR INSTALLATION

INSTALLATION INSTRUCTIONS

Install the shutoff valve on the nearest frequently used drinking water line.

1. SHUTOFF THE MAIN WATER SUPPLY

Turn on the nearest faucet to relieve the pressure on the line.

2. CHOOSE THE VALVE LOCATION

Choose a location for the valve that is easily accessible. It is best to connect into the side of a vertical water pipe. When it is necessary to connect into a horizontal water pipe, make the connection to the top or side, rather than at the bottom, to avoid drawing off any sediment from the water pipe.

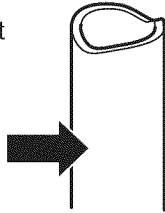

3. DRILL THE HOLE FOR THE VALVE

Drill a 1/4" (6.35 mm) hole in the water pipe using a sharp bit. Remove any burrs resulting from drilling the hole in the pipe. Take care not to allow water to drain into the drill. Failure to drill a 1/4" (6.35 mm) hole may result in reduced ice production or smaller cubes.

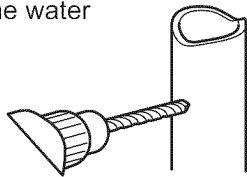

NOTE: Licensed plumbers must use only cooper tubing NDA tubing #49595 or 49499 or Cross Link Polyethylene (PEX) tubing.

4. FASTEN THE SHUTOFF VALVE

Fasten the shutoff valve to the cold water pipe with the pipe clamp.

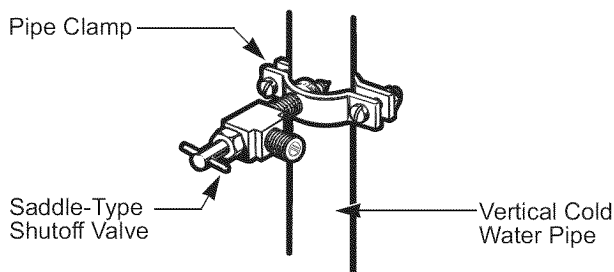

NOTE: Commonwealth of Massachusetts Plumbing Codes 248CMR shall be adhered to. Saddle valves are illegal and use is not permitted in Massachusetts. Consult with your licensed plumber.

5. TIGHTEN THE PIPE CLAMP

Tighten the clamp screws until the sealing washer begins to swell.

NOTE: Do not overtighten or you may crush the tubing.

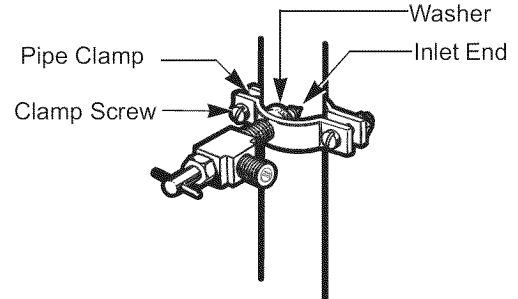

6. ROUTE THE TUBING

Route the tubing between the cold water line and the refrigerator.

Route the tubing through a hole drilled in the wall or floor (behind the refrigerator or adjacent base cabinet) as close to the wall as possible.

NOTE: Be sure there is sufficient extra tubing [about 8 feet (2.4 m) coiled into 3 turns of about 10" (25 cm) diameter] to allow the refrigerator to move out from the wall after installation.

7. CONNECT THE TUBING TO THE VALVE

Place the compression nut and ferrule (sleeve) for copper tubing onto the end of the tubing and connect it to the shutoff valve. Make sure the tubing is fully inserted into the valve. Tighten the compression nut securely.

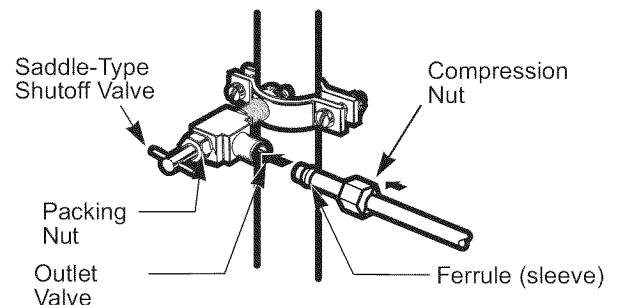

NOTE: Commonwealth of Massachusetts Plumbing Codes 248CMR shall be adhered to. Saddle valves are illegal and use is not permitted in Massachusetts. Consult with your licensed plumber.

REFRIGERATOR INSTALLATION

8. FLUSH OUT THE TUBING

Turn the main water supply on and flush out the tubing until the water is clear.

Shut the water off at the water valve after about one quart of water has been flushed through the tubing.

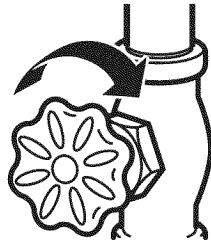

9. CONNECT THE TUBING TO THE REFRIGERATOR

NOTES:

- Before making the connection to the refrigerator, be sure the refrigerator power cord is not plugged into the wall outlet.
 - If your refrigerator does not have a water filter, we recommend installing one. If your water supply has sand or particles that could clog the screen of the refrigerator's water valve, install the filter in the water line near the refrigerator.
 - Do not use old hoses; only use new hoses provided by the manufacturer. For more information call 1-800-4-MY-HOME®.
1. Remove the plastic flexible cap from the refrigerator connection.
 2. Place the compression nut and ferrule (sleeve) onto the end of the tubing. (See figure 1)
 3. Insert the end of the tubing into the connection as far as possible. While holding the tubing, tighten the fitting.

CAUTION: Check to make sure that leaks are not occurring in the water line.

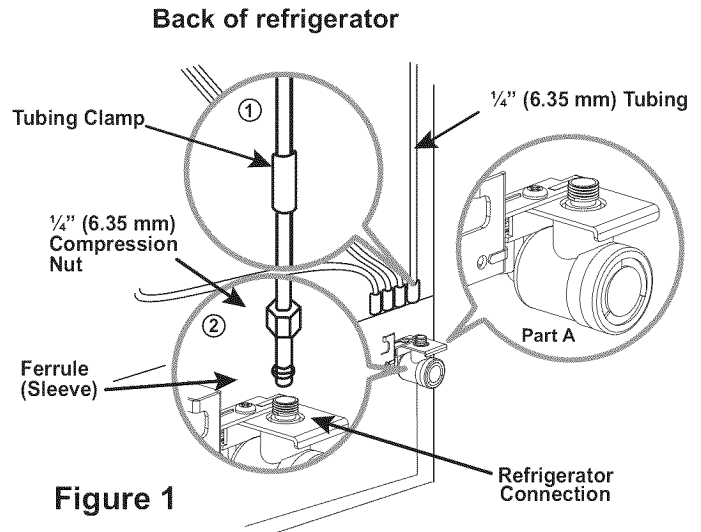

Figure 1

Fasten the tubing into the tubing clamp attached to the back of the refrigerator.

First, loosen the screw fastening the clamp. Next, insert the tubing in the groove. Finally, re-fasten the screw.

10. PLUG IN THE REFRIGERATOR

Arrange the coil of tubing so that it does not vibrate against the back of the refrigerator or against the wall. Push the refrigerator back to the wall.

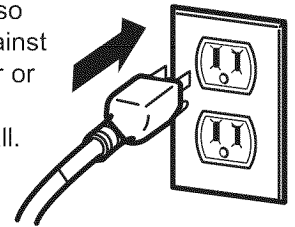

11. START THE ICEMAKER

Set the icemaker power switch to the **ON (I)** position. The icemaker will not begin to operate until it reaches its operating temperature of 15°F (-9°C) or below. It will then begin operation automatically if the icemaker power switch is in the **ON (I)** position.

REFRIGERATOR FEATURES

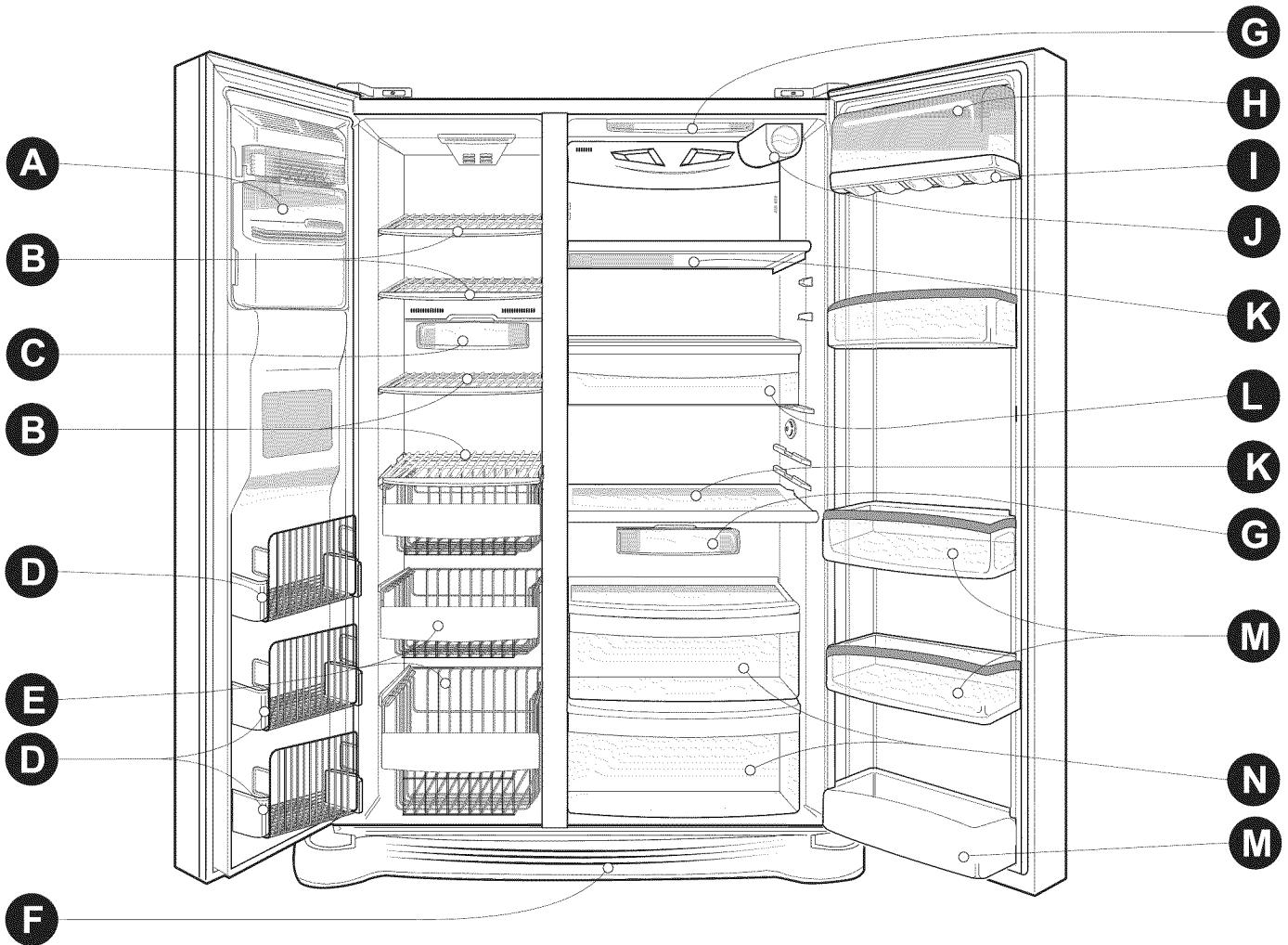

Use this page to become more familiar with the parts and features.

Note: This guide covers several different models. The refrigerator you have purchased may have some or all of the items listed below. The locations of the features shown below may not match your model.

- A** Automatic Icemaker
The ice is produced in the icemaker and sent to the dispenser.
- B** Freezer Shelf
- C** Freezer Light (LED)
- D** Freezer Door Rack
- E** Drawer
- F** Base Grille

- G** Refrigerator Light (LED)
- H** Dairy Corner
For storage of dairy products such as butter and cheese.
- I** Can Rack
- J** Water Filter
- K** Refrigerator Shelf
- L** Snack Pan
For storage of meat or fresh food.
- M** Refrigerator Door Rack
Door racks may be clear or opaque depending on refrigerator model type.
- N** Crisper Drawer

USING YOUR REFRIGERATOR

ENSURING PROPER AIR CIRCULATION

In order to ensure proper temperatures, air must flow between the refrigerator and freezer sections.

- Cool air enters the freezer compartment from the control box located in the top of the inner case, and moves down. Air then exits through the air vents located behind the freezer drawer.
- In refrigerator compartment, a sensor located in the control box opens a gate which allows air to enter the compartment. Air moves down the compartment and exits through the vents located behind the crisper drawers.

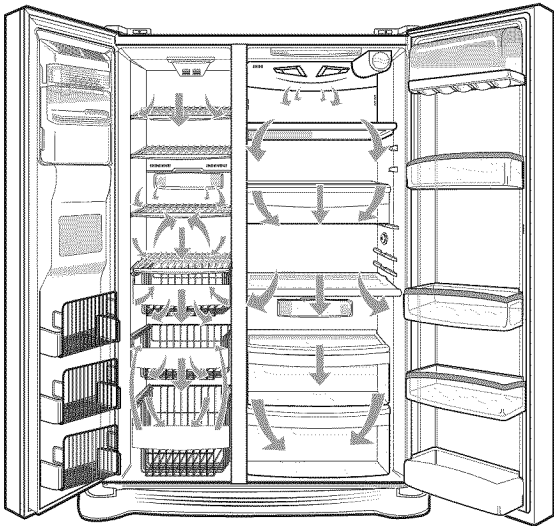

- **Do not block any of these vents** with food packages. If the vents are blocked, airflow will be interrupted and temperature and moisture problems may occur.

IMPORTANT:

Because air circulates between both sections, any odors formed in one section will transfer to the other. You must thoroughly clean both sections to eliminate odors. To prevent odor transfer and dried out food, wrap or cover foods tightly. (See the Food Storage Guide section for details.)

NOTE: If you close the refrigerator door, you may see the freezer door open and close again due to pressure from internal air flow.

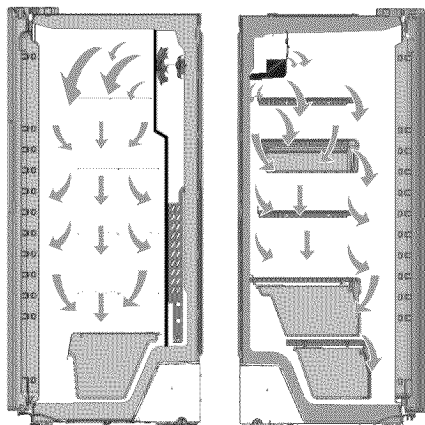

PRIOR TO USE

1. Clean your refrigerator thoroughly and wipe off dust accumulated during shipping.
2. Install accessories such as ice cube bin, drawers, shelves, etc., in their proper places. They are packed together to prevent possible damage during shipment.
3. Let your refrigerator run for at least 2 or 3 hours before putting food in it. Check the flow of cold air in the freezer compartment to ensure proper cooling. Your refrigerator is now ready for use.

CONTROL PANEL FEATURES

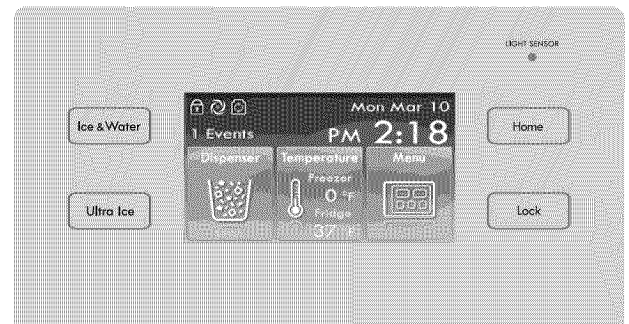

USER INTERFACE DISPLAY

ICE & WATER

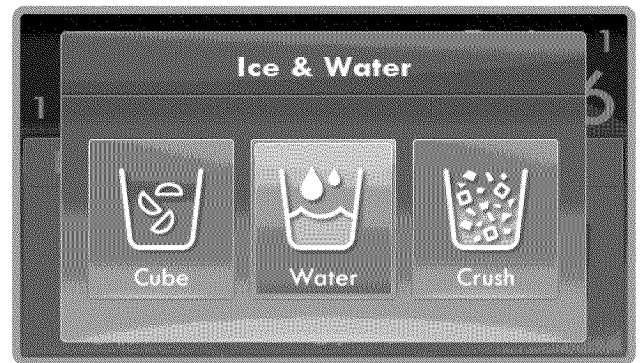

Ice & Water allows you to change between dispensing water or ice. Also allows you to choose the type of ice that will be dispensed, cube or crushed.



- Select cube, water or crush by pressing the **Ice & Water** button, Ice & Water screen will be displayed.
- Press the **Ice & Water** button repeatedly; the selection will switch in the following order: Crush → Water → Cube order.
- To select from the display tap the desired option. The dispenser will change accordingly.

NOTE: If there is no input in 3 seconds, the Ice & Water screen will close and the Home screen will be displayed.

USING YOUR REFRIGERATOR

ULTRA ICE

The Ultra Ice function runs the freezer compartment at the coldest settings for a 24 hour period. Use the Ultra Ice function to increase icemaking production.

- Press the  button to activate the Ultra Ice function, **Processing Ultra Ice...** screen will be displayed.
- When Ultra Ice function is processing the  icon will be displayed at the top left corner of Home screen.



- To turn off the Ultra Ice function, press the  button. The **Stopped Ultra Ice...** screen will display. If there is no further input within 3 seconds, the Home screen will appear.



LOCK

Use the Lock function to lock or unlock the display. All control buttons will be disabled including the display screen.

- To lock the display, press and hold the  button for 3 seconds (Lock button blinks 4 times); the **Display is Locked!** message will appear. If there is no further input in 3 seconds, the Home screen will appear.



- If you touch the screen or press any button while the Lock function is enabled, there will be no response and the **Display is Locked!** message will appear.
- To unlock the display, press and hold the Lock button for 3 seconds, the **Display is Unlocked!** screen will appear.



USING YOUR REFRIGERATOR

DISPLAY PROGRAM SYSTEM BOOTING

When power is supplied to the system, booting screen is displayed on LCD screen. Home screen will be displayed when booting is completed.

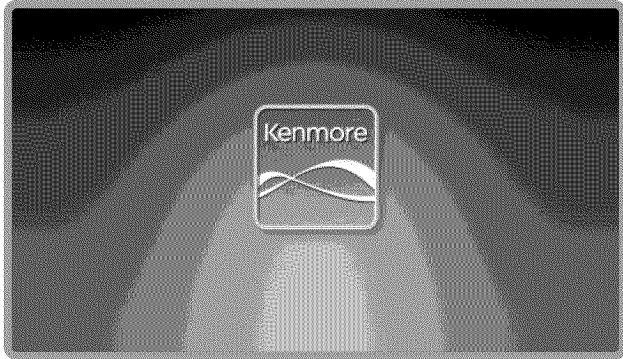

HOME

Press Home button to see the applications. To access tap at any application.

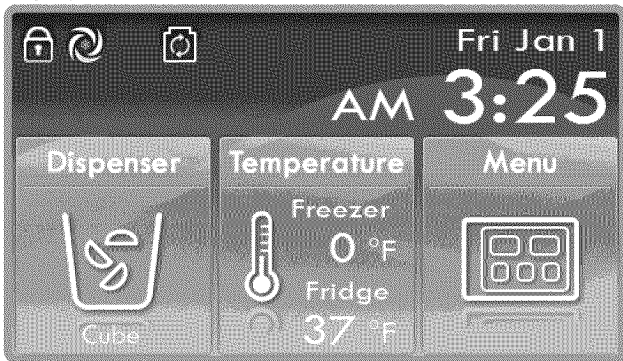

- **Dispenser** Tap the Dispenser application to select among Crush Water Cube.
- **Temperature** Tap the Temperature application to set refrigerator and freezer temperature.
- **Menu** Tap the Menu application to access the Menu screen.
- **Lock** When Lock function is enabled, Lock icon is displayed at the top left corner of Home screen.
- **Ultra Ice** When Ultra Ice function is activated, Ultra Ice icon will be displayed at the top left corner of Home screen. Tap the icon to stop the operation.
- **Filter Reset** If water filter replacement timing of 180 days is reached, Filter Reset icon is displayed at the top left corner of Home screen. Tap this icon to access Filter Reset screen.
- **Time & Date** Tap the time and date displayed area, to switch over to the Time & Date setting screen.

MENU

To access Menu application tap Menu on Home screen.



• Refrigerator

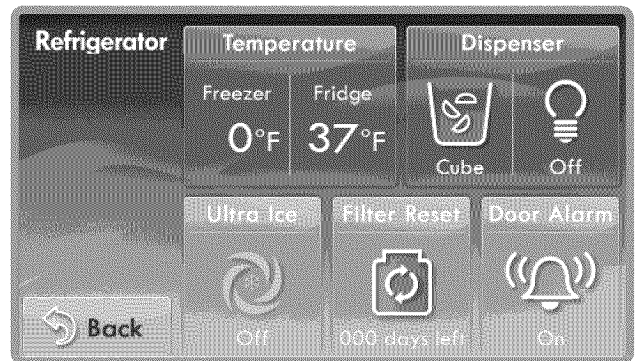

a) Temperature

It is recommended to maintain the preset temperature of 37°F (3°C) on the refrigerator compartment and 0°F (-17°C) on the freezer compartment. Tap Recommended to set these temperatures.

NOTE: The refrigerator temperature can be modified from 33°F to 46°F (1°C to 8°C), freezer temperature can be modified from -6°F to 8°F (-21°C to -13°C). Wait 24 hours before making any additional adjustments. The lower the number, the colder the compartment will be.

Select Temperature to modify refrigerator and freezer compartment. Tap button to change the temperature setting.

- To change temperature unit, tap C for Celsius and F for Fahrenheit.
- Tap OK to set temperatures.

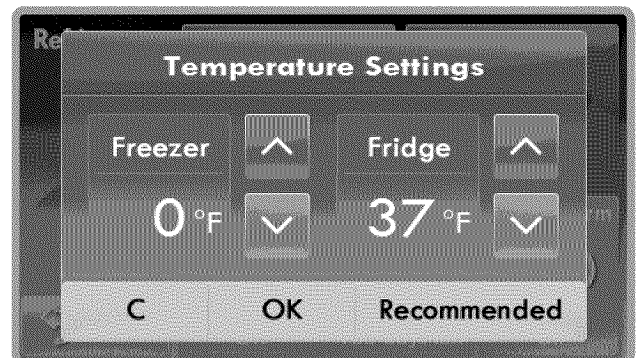

USING YOUR REFRIGERATOR

b) Dispenser



- Allows you to choose between Cube, Water and Crush. Tap the desired icon.
- Tap Light to switch to Off → Auto → On setting. The Mood Light will change accordingly. When Auto is selected, brightness of the room will be detected by the Light Sensor to turn ON when dark and OFF when bright.
- Tap OK to accept the changes or tap Close to exit the application.

c) Filter Reset

Select Filter Reset to verify the remaining filter time or reset it.

- When Reset is selected, it will reset the filter to 6 months.
- Tap Close to exit the application.



d) Door Alarm

When either refrigerator or freezer door is left open for more than 60 seconds, an alarm will sound 5 times at 30 seconds intervals to let you know the door is open. Tap the Door Alarm to activate or deactivate the function.

e) Ultra Ice

Tap the Ultra Ice to activate or deactivate the function.

• Memo Pad







Save your memos in the Memo Pad.

- Select Memo Pad to access the application, memos will be displayed in the screen.



a) New

To create a new memo tap  and Memo Pad editing screen will be displayed.



- To enter text tap on the character.
- Tap  key to toggle the keyboard between upper and lower case.
- For numbers and special character tap the  key switch over to the alphabet by tapping  key.
- Move the cursor in the desired direction by pressing the arrow keys.
- To save the memo tap  or  to exit Memo Pad.

b) Delete All

To delete all saved memos, tap  or tap  to exit the application without deleting any memo.

c) Recycle Bin

To delete a memo on the Memo Pad display, tap the  button in the right side of the memo.

d) Back

To return to Home screen tap Back.

e) Edit

Select a created memo to change to the Memo View screen. Within this screen, you can edit the currently displayed memo. Pressing the  button will display the Edit Memo screen.

USING YOUR REFRIGERATOR

• Freshness Tip

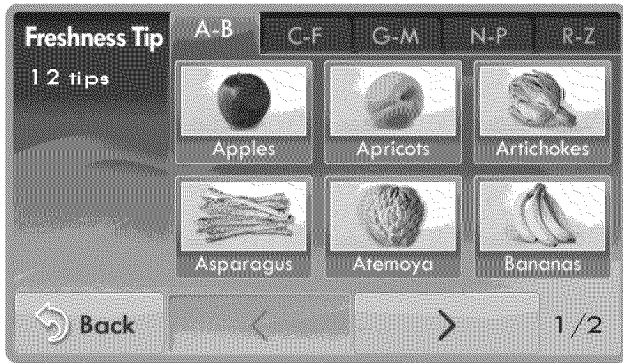

For freshness and storage tips for fruits and vegetables, tap Freshness Tip on Menu screen.

- Use the tabs at the top to sort through the available tips alphabetically.
- Tap the fruit/vegetable of your choice to switch to the Freshness Tip view screen.

a) Freshness Tip View



The Freshness Tip view lists the common temperature ranges for both Room Temperature Storage and Refrigerated Storage as well as the recommended method.



NOTE: If the selected item should not be stored using a specific method (Room Temperature or Refrigerated) a **NO** will appear beneath the respective storage method.

- Select Back to return to Freshness Tip screen.

• Calendar

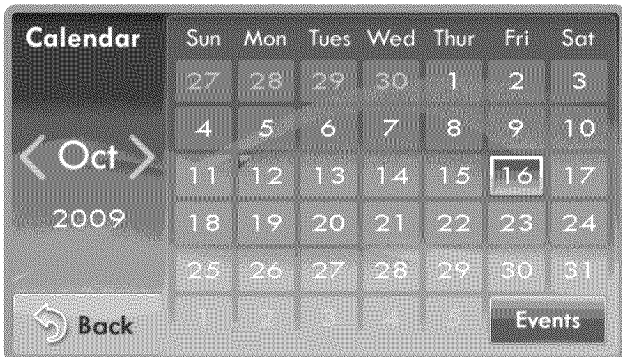

Calendar lets you view monthly calendars. You can view holidays that are already preset as well as your personal events.



Today's date will be displayed inside a square . Holidays will be displayed by  displayed on the top left side of the date.



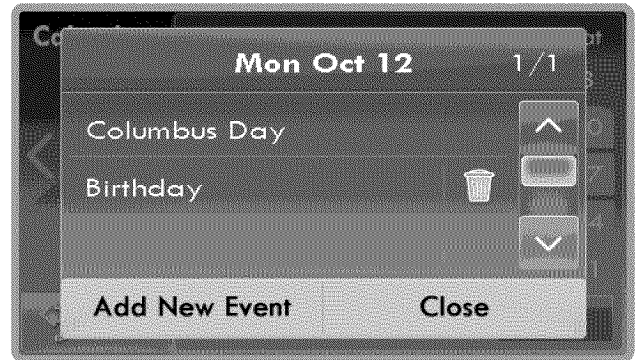

- To view events scheduled for a determined day, tap on the day and Events will be displayed.

a) Events

- Tap  to access Events screen. Tap Add New Events to add events to your list.
- If you want to delete an event, tap the  icon on the right side of the event.
- Select  to return to Calendar screen.



b) Add New Events

- To enter text tap on the character. Tap  key to toggle the keyboard between upper and lower case.
- For numbers and special characters tap the  key; switch over to the alphabet by tapping  key.
- Tap Yearly checkbox for this event to set as a yearly event. For reminder of event tap checkbox Reminder and this event will be displayed on Home screen on its particular date.
- Press  to save the event or  to exit New Events.



USING YOUR REFRIGERATOR

• Service Info ⓘ



Service Info provides you a quick guide for common troubleshooting. For full Service Info tap the category of your interest.

NOTE: For more detailed information refer to the **Troubleshooting** guide section.

- To move through the pages, tap .
- Select Back to return to Home screen.

• Settings ⚙

Settings allows you to customize the display applications.

- Set the time and date, brightness and enter other preferences for your display.



a) Brightness

Current brightness level is displayed on screen; to change setting tap on brightness level displayed area.

- Brightness default value is level 3 (middle).

b) Button Sound

To turn ON and OFF Button Sound, tap the displayed area to switch ON and OFF. Default value for Button Sound is ON.

c) Language

To change screen language, tap on Language displayed area. Select either English, Spanish or French.

d) Time & Date

To set time and date, select Time or Date tab on the top of the screen, and input data accordingly.

- Press tabs to increase or decrease the value.
- To save setting tap OK.



Select Back to switch to Home screen.

NOTE: If Back is selected without tapping OK, any new settings will not be saved.

e) Screen Saver

Screen Saver allows you to choose either Screen Off, Clock or Dimmed setting.



- Screen Off

LCD backlight is turned OFF.

- Dimmed

Brightness of LCD backlight will be darkened.

- Clock

Brightness of LCD backlight will be darkened and Clock screen saver showing current time is displayed.

When Screen Saver is set, touch anywhere on the screen to cancel the function.



- The number of minutes set for Running Time will be the time allowed to before the Screen Saver mode is activated.

- To cancel the Screen Saver mode, press any of the operational buttons or the display.

USING YOUR REFRIGERATOR

Icemaker operation

⚠ WARNING

Personal Injury Hazard

Avoid contact with the moving parts of the ejector mechanism, or with the heating element that releases the cubes. **DO NOT** place fingers or hands on the automatic icemaking mechanism while the refrigerator is plugged in.

A newly-installed refrigerator may take 12 to 24 hours to begin making ice.

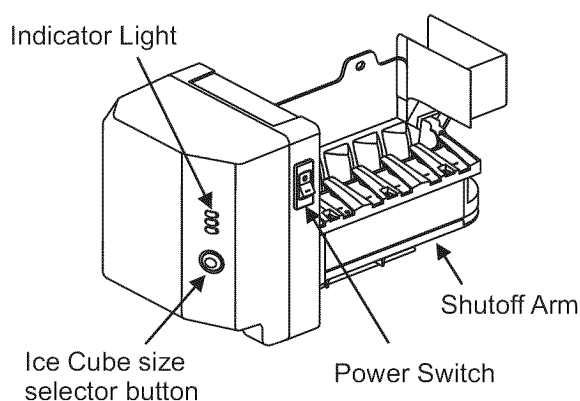

The icemaker will produce 6 cubes per cycle, approximately 100 cubes in a 24 hour period, depending on freezer compartment temperature, room temperature, number of door openings and other operating conditions.

If the refrigerator is used before the water connection is made to the icemaker, set the power switch to **OFF (O)**.

When the refrigerator has been connected to the water the icemaker will fill with water when it cools to freezing.

Throw away the first few batches of ice to allow the water line to clear.

Be sure nothing interferes with the sweep of the shutoff arm.

When the bin fills to the level of the shutoff arm, the icemaker will stop producing ice.

It is normal for several cubes to be stuck together.

If ice is not used frequently, old ice cubes will become cloudy, taste stale, and shrink.

ADJUSTING CONTROL SETTINGS

Give the refrigerator time to cool down completely before making final adjustments. It is best to wait 24 hours before doing this. The initial settings mentioned in **CONTROL PANEL FEATURES** section should be correct for normal household refrigerator use.

The refrigerator control functions as the thermostat for the entire appliance (refrigerator and freezer sections). The colder the setting, the longer the compressor will run to keep the temperature colder. The freezer control adjusts the cold air flow from the freezer to the refrigerator. Setting the freezer control to a lower temperature keeps more cold air in the freezer compartment to make it colder.

If you need to adjust temperatures in the refrigerator or freezer, start by adjusting the refrigerator and allow 24 hours for the temperature to stabilize. If it is too warm or too cold, then adjust the freezer control.

Use the settings listed in the chart below as a guide.

Always remember to wait at least 24 hours between adjustments.

CONDITION/ REASON :	RECOMMENDED ADJUSTMENT :
<ul style="list-style-type: none"> ■ REFRIGERATOR section too warm – Door opened often – Large amount of food added – Room temperature very warm 	Set the Refrigerator control one degree colder; wait 24 hours for the new setting to take full effect before making another adjustment.
<ul style="list-style-type: none"> ■ FREEZER section too warm/ice not made fast enough – Door opened often – Large amount of food added – Very cold room temperature, 55° F (13° C) is the lower temperature limit. (Compressor does not cycle often enough) – Heavy ice usage – Air vents blocked by items 	Set the Freezer control one degree colder; wait 24 hours for the new setting to take full effect before making another adjustment.
<ul style="list-style-type: none"> ■ REFRIGERATOR section too cold – Controls not set correctly for your conditions 	Set the Refrigerator control one degree warmer; wait 24 hours for the new setting to take full effect before making another adjustment.
<ul style="list-style-type: none"> ■ FREEZER section too cold – Controls not set correctly for your conditions 	Set the Freezer control one degree warmer; wait 24 hours for the new setting to take full effect before making another adjustment.

USING YOUR REFRIGERATOR

FOOD STORAGE GUIDE

Wrap or store food in the refrigerator in airtight and moisture-proof material unless otherwise noted. This prevents food odor and taste transfer throughout the refrigerator. For dated products, check date code to ensure freshness.

Items	How to Store
Butter or margarine	▶ Keep opened butter in a covered dish or closed compartment. When storing an extra supply, wrap in freezer packaging and freeze.
Cheese	▶ Store in the original wrapping until you are ready to use it. Once opened, rewrap tightly in plastic wrap or aluminum foil.
Milk	▶ Wipe milk cartons. For best storage, place milk on interior shelf, not on door shelf.
Eggs	▶ Store in original carton or on interior shelf, not on door shelf.
Fruit	▶ Wash, let dry, and store in refrigerator in plastic bags or in the crisper. Do not wash or hull berries until you are ready to use them. Sort and keep berries in their original container in a crisper drawer, or store in a closed and sealed paper bag on a refrigerator shelf.
Leafy vegetables	▶ Remove store wrapping and trim or tear off bruised and discolored areas. Wash in cold water and drain. Place in plastic bag or plastic container and store in crisper drawer.
Vegetables with skins (carrots, peppers)	▶ Place in plastic bags or plastic container and store in crisper drawer.
Fish	▶ Use fresh fish and shellfish the same day purchased.
Leftovers	▶ Cover leftovers with plastic wrap or aluminum foil. Plastic containers with tight lids can also be used.

STORING FROZEN FOOD

NOTE: For further information about preparing food for freezing or food storage times, check a freezer guide or a reliable cookbook.

Packaging

Successful freezing depends on correct packaging. When you close and seal the package, it must not allow air or moisture in or out. If it does, you could have food odor and taste transfer throughout the refrigerator and also dry out frozen food.

Packaging recommendations:

- Rigid plastic containers with "tight-fitting lids"
- Straight-sided canning/freezing jars
- Heavy-duty aluminum foil
- Plastic-coated paper
- Non-permeable plastic wraps
- Specified freezer-grade self-sealing plastic bags

Follow package or container instructions for proper freezing methods.

Do not use

- Bread wrappers
- Containers without tight lids
- Wax paper or wax-coated freezer wrap
- Thin, semi-permeable wrap

⚠ CAUTION: Do not keep beverage cans or plastic food containers in the freezer compartment. They may burst if they freeze.

Freezing

Your freezer will not quick-freeze any large quantity of food. Do not put more unfrozen food into the freezer than will freeze within 24 hours [no more than 2 to 3 lbs of food per cubic foot (0.9 to 1.35 kg per cubic meter) of freezer space]. Leave enough space in the freezer for air to circulate around packages. Be careful to leave enough room at the front so the door can close tightly.

Food storage times will vary according to the quality and type of food, the type of packaging or wrap used (airtight and moisture-proof) and the storage temperature. Ice crystals inside a sealed package are normal. This simply means that moisture in the food and air inside the package have condensed, creating ice crystals.

NOTE: Allow hot foods to cool at room temperature for 30 minutes, then package and freeze. Cooling hot foods before freezing saves energy.

USING YOUR REFRIGERATOR

WATER AND ICE DISPENSER

Your refrigerator has a mechanism that can dispense cool water and ice cubes without opening the door.

- The dispenser tray can easily be removed by pressing down and lifting it out.
- First push the tray in the area labeled 'PUSH', then place your finger in the center hole and lift up to remove the tray.

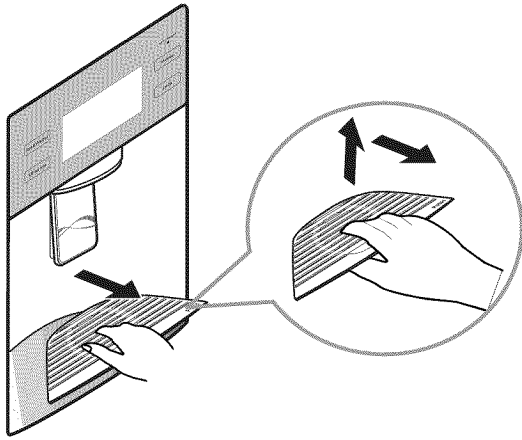
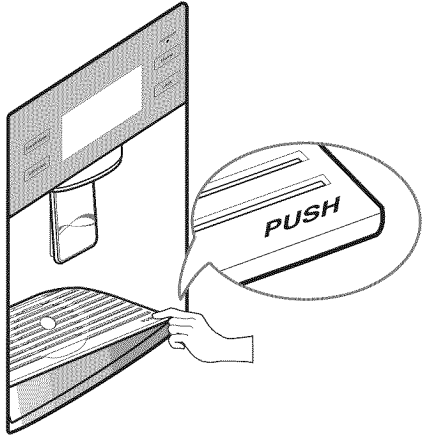

⚠ WARNING

Do not put your hands into the water and ice dispenser opening. Doing so may cause an injury to your hand.

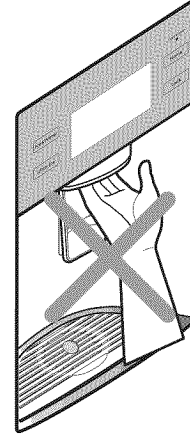

⚠ CAUTION

When using the dispenser with a container with a small opening, place the container as close to the top as possible.

- The dispenser opening has the following dimensions:
 - Depth $4\frac{7}{8}$ " (124 mm)
 - Width $6\frac{7}{8}$ " (174 mm)
 - Height $9\frac{3}{8}$ " (238 mm)For best performance, use a container that is smaller than the dispenser opening.

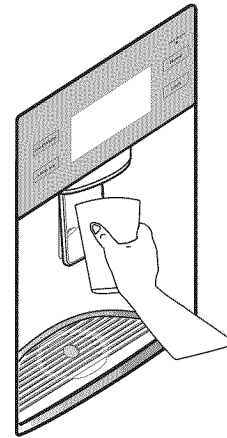

USING YOUR REFRIGERATOR

ICE STORAGE BIN

The ice bin stores the ice cubes made by the icemaker. If you need to remove the ice storage bin, do so as follows:

NOTE: Use both hands to remove the ice bin to avoid dropping it.

- Lift the ice storage bin slightly ① and pull it out ② as shown in the figure.

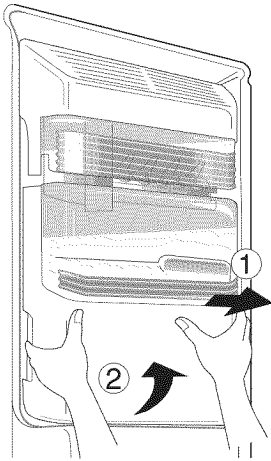

NOTE: Do not remove the ice storage bin unless it is necessary.

DOOR RACK AND SUPPORT

Your refrigerator and freezer features racks which can easily be arranged for packaged products.

- Lift the door rack holding both sides ① and pull it out in ② direction.

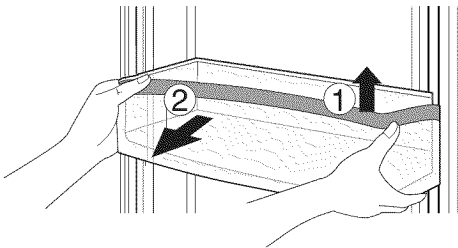

SNACK PAN

- To remove the snack pan cover, pull the snack pan out a bit ①. Lift the front part of the snack pan cover and pull out ②.

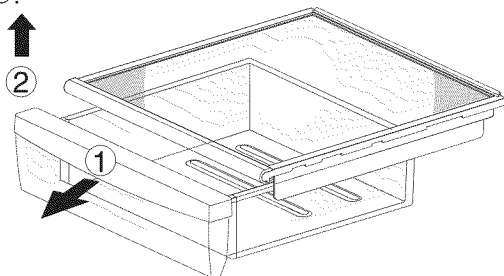

CRISPER AND CRISPER COVER

The crisper allows for better conservation of fruits and vegetables.

- To remove the crisper compartment cover, pull out the crisper compartment a bit to the front ①, lift the front part of the cover as shown in ②, and take it out ③.

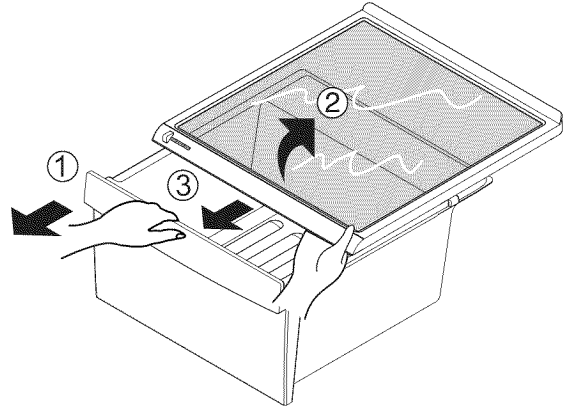

- To remove the crisper compartment, pull the crisper compartment to the front ① until it stops. Then slightly lift the crisper compartment ② while pulling it out ③.

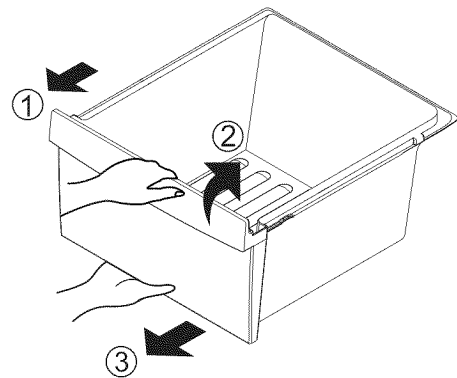

⚠ CAUTION

When removing the crisper compartment you will see the water tank. Do not remove it, or water leakage may result. The water tank is not a removable part.

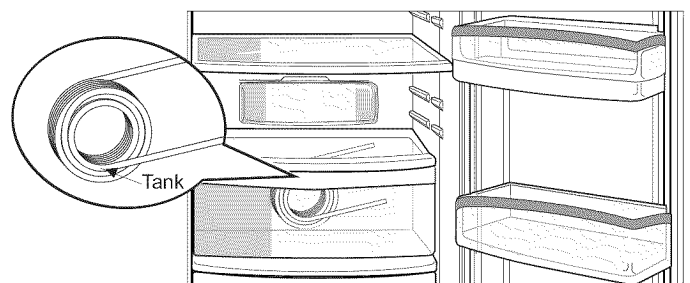

USING YOUR REFRIGERATOR

You can control the amount of humidity in the moisture-sealed crispers. Adjust the control to any setting between "VEGETABLES" and "FRUIT".

- **"VEGETABLES"**: Keeps moist air in the crisper for best storage of fresh, leafy vegetables.
- **"FRUIT"**: Lets moist air out of crisper for best storage of fruits or vegetables with skins.

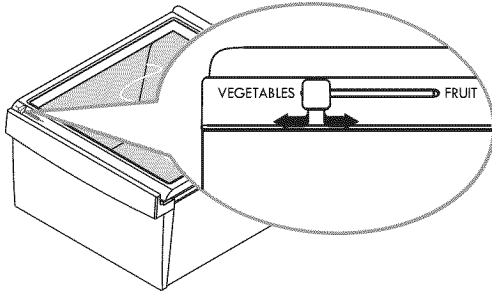

AIRTIGHT CRISPER AND AIRTIGHT CRISPER COVER

Its sealing property allows moisture to stay inside. Ideal to store lettuce, spinach, broccoli, brussels sprouts, celery or any vegetable or fruit that require cold, moist conditions. The airtight crisper will keep vegetables fresh for longer.

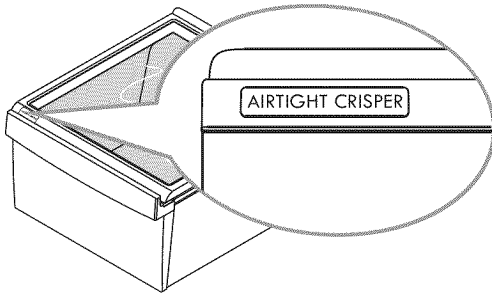

- To remove it, pull the airtight crisper cover out, insert a flatblade screwdriver below the airtight cover hook ① and pull down ②. Repeat same process on opposite side.

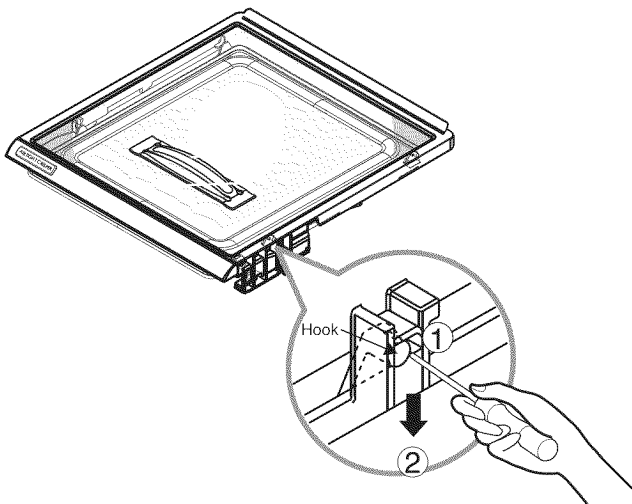

REFRIGERATOR SHELVES

The refrigerator compartment shelf is adjustable so that you can place it at a height according to space requirement of foods.

• Slide shelf

Pull the shelf towards you ①, then lift both the front and rear parts of the shelf upward ② to remove ③.

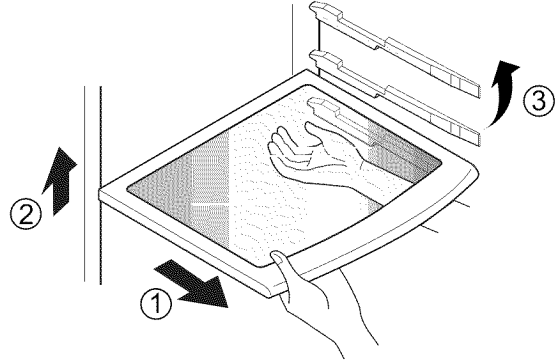

NOTE: Make sure to keep shelf horizontal while removing; otherwise it may drop.

• Folding Shelf:

You can store taller items such as gallon containers or bottles by simply sliding the shelf back.

1. Slightly lift the shelf in the direction ① while pushing it to the back ②.

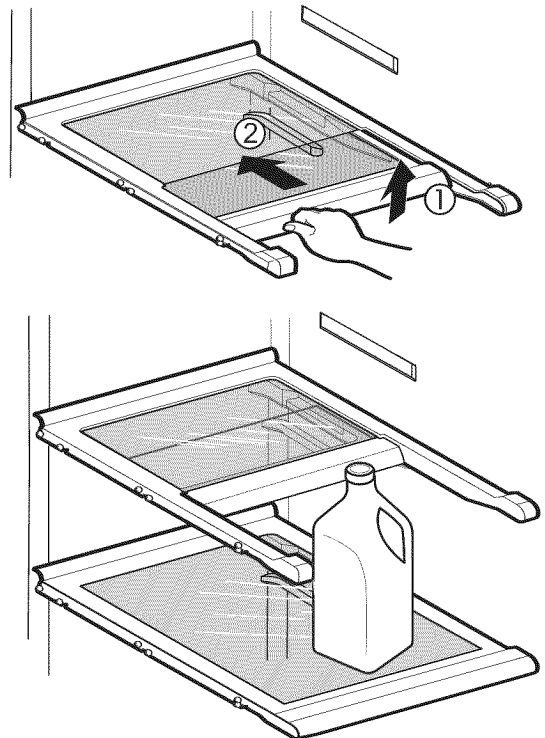

USING YOUR REFRIGERATOR

• Fixed shelf

Lightly lift up the front part of shelf ①, pull the shelf towards you ②, then take it out while lifting the rear part of shelf ③.

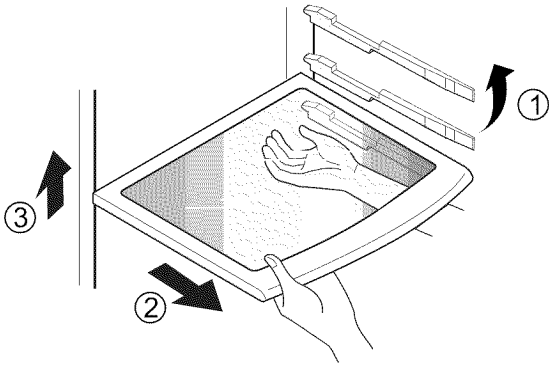

FREEZER SHELF

To assemble or disassemble the freezer shelf, follow the next steps:

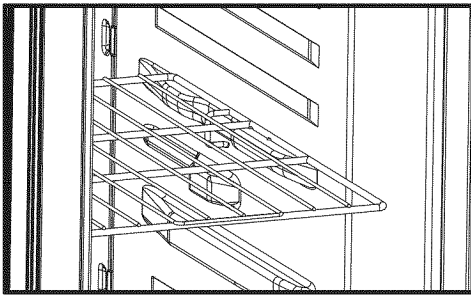

1. Pull the shelf towards the front ①. The shelf hook will contact the support on the guide. Lift the shelf so the hook clears the guide support (view detail), then pull toward you.

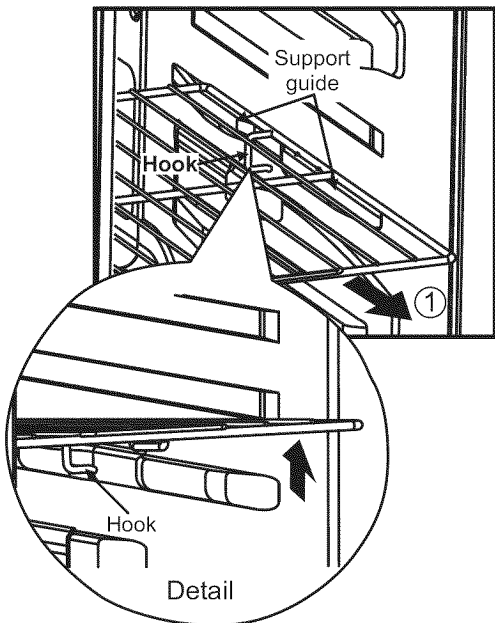

• Fixed shelf

1. Firmly pull the right rear of the shelf up ① to clear the rear shelf support (view detail).

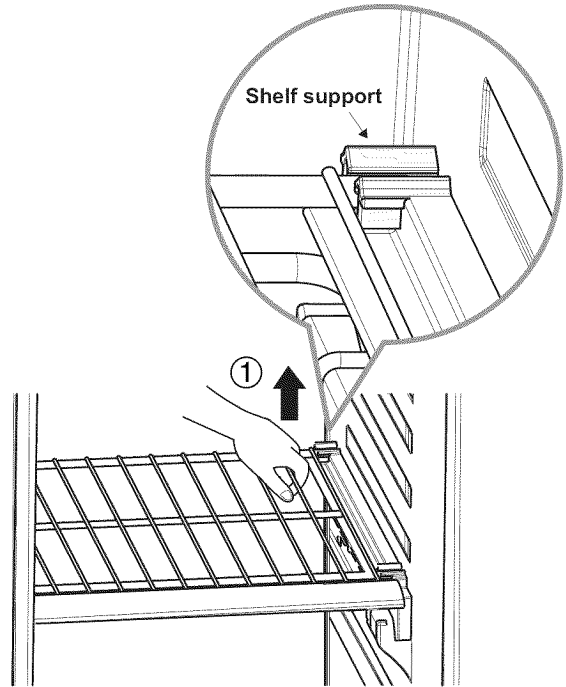

2. Firmly pull the right front part of the shelf up ② to clear the front shelf support.

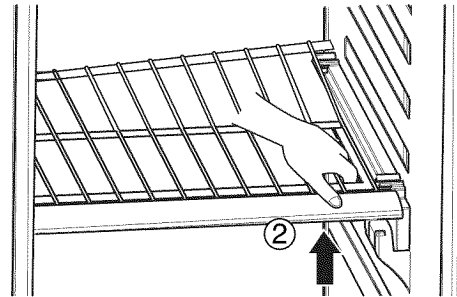

3. Tilt the shelf in the direction ③, and then pull it toward you.

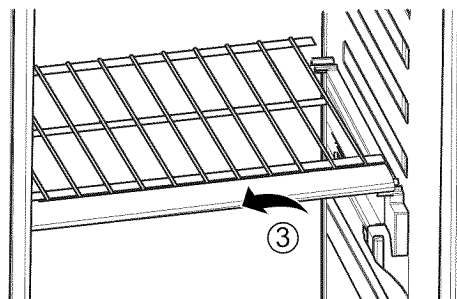

USING YOUR REFRIGERATOR

WATER FILTER

When the Filter Reset icon is displayed on Home screen, you have to change the water filter. Tap the  icon to access Filter Reset screen and reset filter timing.

Before removing or installing water filter:

IMPORTANT: Turn off household water supply.

Removing the water filter.

Rotate the knob of the cartridge counter clockwise. When the cartridge is removed, you will feel it click out of place. Pull out the cartridge.

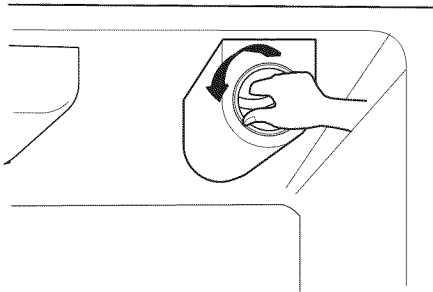

NOTE: Removing the filter causes a small amount of water to flow out. Place a cup below filter receptacle to catch water. Holding cartridge with handle down will minimize spillage.

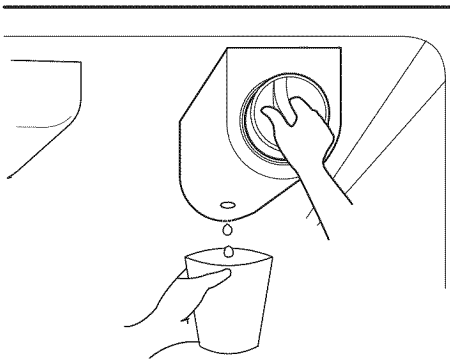

Installing the water filter.

Take the new cartridge out of its package and remove protective cover from the o-rings. With cartridge knob in the vertical position, push the new filter cartridge into the cover until it stops.

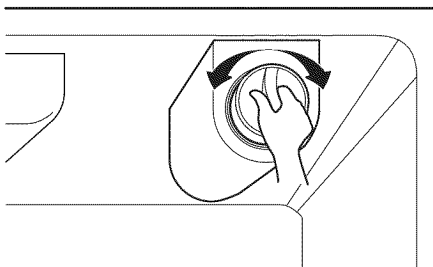

Grasping filter by its handle, twist it about $\frac{1}{4}$ turn until it clicks into place. The filter is not correctly installed if you can wiggle it from side to side. You will hear a snap when it locks securely into place.

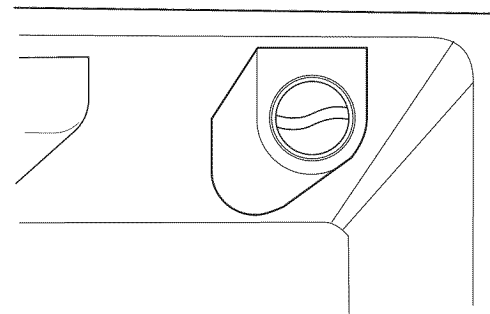
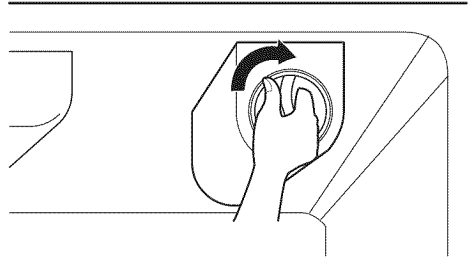

After installing water filter:

1. Turn on household water supply.
2. Dispense 2.5 gallons (9.46 liters) of water to purge the system, depressing and releasing the dispenser pad in cycles of 30 seconds ON and 60 seconds OFF. Open the refrigerator door and shelf area to check for water leaks.

To purchase replacement water filter, call 1-800-4-MY-HOME®.

USING YOUR REFRIGERATOR

Filter Performance Data Sheet Model Number 5231JA2006E

Use with replacement cartridge 5231JA2006E

This system has been tested according to NSF/ANSI 42 for the reduction of the substances listed below. The concentration of the indicated substances in water entering the system was reduced to a concentration less than equal to the permissible limit for water leaving the system, as specified in NSF/ANSI 42.



System tested and certified by NSF International against NSF/ANSI Standard 42 for the reduction of Chlorine, Taste and Odor and Nominal Particulate Class III.

Contaminant Reduction	Average Influent	Influent Challenge concentration. Units apply to each row	Product Water	Average % Reduction	NSF Reduction Requirements	Max. Effluent mg/L	Min. % Reduction	NSF Test
Particulate Class I Particle size: >0.5 to <1 _{um}	5600000	At least 10 000 particles/ml	833333	93.2	≥ 85%	470000	91.6%	511032-03
Chlorine taste and odor	1.9 mg/L	2.0 mg/L ± 10%	0.05 mg/L	97.4	≥ 50%	0.05 mg/L	97.4%	511031-03

* To a capacity of 300 gallons (1.135 L).

* Note that while the testing was performed under standard laboratory conditions, actual performance may vary.

Application Guidelines / Water Supply Parameters	
Water pressure	30 - 100 psi (207 - 689 kPa)
Water temperature	33°F - 100°F (0.6°C - 37.8°C)
Service flow	0.5 gpm (1.9 lpm)

▲ WARNING

To reduce the risk associated with ingestion of contaminants due to use with water that is microbiologically unsafe or of unknown quality.
Do not use with water that is microbiologically unsafe or of unknown quality without adequate disinfection before or after the system.

Systems must be installed and operated in accordance with manufacturer's recommended procedures and guidelines.

▲ CAUTION

To reduce the risk of property damage due to water leakage:

- Read and follow Use instructions before installation and use of this system.
- Install on COLD water lines only.
- Comply with all state and local plumbing codes. Never install or operate where inlet water pressure may exceed 125 psi (862 kPa).
- Protect filter from freezing. Remove filter in temperatures below 34°F (1°C).
- Replace cartridge at specified service interval. Cartridge MUST be replaced at least every 6 months.
- After replacing the water filter cartridge, dispense 2.5 gallons (9.46 liters) of water to purge the system, depressing and releasing the dispenser pad in cycles of 30 seconds ON and 60 seconds OFF. Discard the purged water.

To purchase a replacement filter, visit your local Sears store or call 1-800-4-MYHOME®. Visit us on the web at www.sears.com

Product distributed in the United States
by Sears Brands Management Corporation,
Hoffman Estates, IL 60179

CARE AND CLEANING

⚠ WARNING



Explosion Hazard

Use non-flammable cleaner.
Failure to do so can result in death, explosion, or fire.

Both the refrigerator and freezer sections defrost automatically. However, clean both sections about once a month to prevent odors. Wipe up spills immediately.

GENERAL CLEANING TIPS

- Unplug refrigerator or disconnect power.
- Remove all removable parts, such as shelves, crispers, etc. Refer to sections in **Using Your Refrigerator** for removal instructions.
- Use a clean sponge or soft cloth and a mild detergent in warm water. Do not use abrasive or harsh cleaners.
- Hand wash, rinse and dry all surfaces thoroughly.
- Plug in refrigerator or reconnect power.

OUTSIDE

Waxing external painted metal surfaces helps provide rust protection. Do not wax plastic parts. Wax painted metal surfaces at least twice a year using appliance wax (or auto paste wax). Apply wax with a clean, soft cloth.

Do not use wax on stainless steel exteriors. Use a product specially designed for polishing stainless steel appliances, or clean with a soft cloth or clean sponge and a mild detergent dissolved in warm water. Dry thoroughly with a soft cloth.

NOTE: Avoid door surface contact with chemical products that contain Phosphate or Chlorine, such as degreasers, detergents (containing TSP) and bleachers.

INSIDE WALLS (allow freezer to warm up so cloth will not stick)

To help remove odors, you can wash the inside of the refrigerator with a mixture of baking soda and warm water. Mix 2 tablespoons baking soda to 1 quart of water (26 g soda to 1 liter water.) Be sure the baking soda is completely dissolved so it does not scratch the surfaces of the refrigerator.

DOOR LINERS AND GASKETS

Do not use cleaning waxes, concentrated detergent, bleaches, or cleaners containing petroleum on plastic refrigerator parts.
Use a clean sponge or soft cloth and a mild detergent in warm water. Wash, rinse and dry all surfaces thoroughly.

PLASTIC PARTS (covers and panels)

Do not use window sprays, abrasive cleaners, or flammable fluids. These can scratch or damage the material. Use a clean sponge or soft cloth and a mild detergent in warm water. Wash, rinse and dry all surfaces thoroughly.

BACK COVER

⚠ WARNING

ELECTRICAL SHOCK HAZARD

Before you begin, either unplug the refrigerator or turn off power at the circuit breaker or fuse box. Failure to do so could result in death or serious injury.

NOTE: Back cover should only be removed by a qualified technician.

Clean the vents on the back cover. Use a vacuum cleaner with the brush attachment, at least twice a year to keep your refrigerator working efficiently.

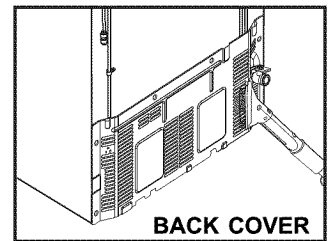

BACK COVER

LED REPLACEMENT

If refrigerator or freezer LED module presents a failure, please call 1-800-4-MY-HOME® for its replacement.

NOTE: Do not remove the LED module, it is only to be removed by a qualified technician.

POWER INTERRUPTIONS

1. If the power will be out for 24 hours or less, keep all refrigerator doors closed to help foods stay cold and frozen.
2. If the power will be out for more than 24 hours:
 - a) Remove all frozen food and store it in a frozen food locker.

CARE AND CLEANING

WHEN YOU GO ON VACATION

If you choose to leave the refrigerator running while you are away, follow these steps to prepare your refrigerator before you leave.

1. Use up any perishables and freeze other items.
2. Empty the ice bin.
3. Turn **OFF** the icemaker. **NOTE:** If the ambient temperature will drop below freezing, have a qualified service technician drain the water supply system (on some models) to prevent serious property damage due to possible flooding from ruptured water lines or connections.

If you choose to unplug your refrigerator before you leave, follow these steps.

1. Remove all food from the refrigerator and empty ice bin.
2. Unplug refrigerator.
3. Clean refrigerator, wipe, and dry well.
4. Tape rubber or wood blocks to the tops of both doors to prop them open far enough for air to get in. This stops odor and mold from building up.

WHEN YOU MOVE

When you are moving your refrigerator to a new home, follow these steps to prepare it for the move.

1. Remove all food from the refrigerator and pack all frozen food in dry ice.
2. Unplug refrigerator.
3. Clean refrigerator, wipe, and dry well.
4. Empty water from the defrost pan.
5. Clean, wipe and dry thoroughly.
6. Take out all removable parts, wrap them well and tape together so they do not shift and rattle during the move. Refer to sections in Using your Refrigerator for removal instructions.
7. Depending on the model, raise the front of the refrigerator so it rolls more easily OR screw in the leveling legs all the way so they don't scrape the floor. See the **DOOR ALIGNMENT** section.
8. Tape the doors shut and tape the power cord to the refrigerator cabinet.
9. If the ambient temperature will drop below freezing, have a qualified service technician drain the water supply system (on some models) to prevent serious property damage due to possible flooding from ruptured water lines or connections.

When you get to your new home, put everything back and refer to the **REFRIGERATION INSTALLATION** section for setup instructions.

WHEN YOU SHOULD SET THE ICEMAKER POWER SWITCH TO OFF (O)

- When the water supply will be shut off for several hours.
- When the ice storage bin is removed for more than a minute or two.
- When the refrigerator will not be used for several days.

NORMAL SOUNDS YOU MAY HEAR

- The icemaker water valve will buzz as the icemaker fills with water. If the power switch is in the **ON (I)** position, it will buzz even if it has not yet been hooked up to water. To stop the buzzing, move the power switch to **OFF (O)** position.

NOTE: Keeping the power switch in the **ON (I)** position before the water line is connected can damage the icemaker.

- You will hear the sound of cubes dropping into the bin and water running in the pipes as the icemaker refills.

TROUBLESHOOTING GUIDE

UNDERSTANDING SOUNDS YOU MAY HEAR

Your new refrigerator may make sounds that your old one did not make. Because the sounds are new to you, you might be concerned about them. Most of the new sounds are normal. Hard surfaces, like the floor, walls and cabinets, can make the sounds seem louder than they actually are. The following list describes the kinds of sounds and what may be making them.

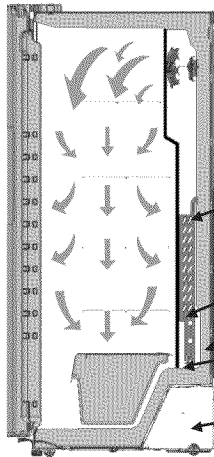

- The defrost timer will click when the automatic defrost cycle begins and ends. The thermostat control (or refrigerator control, depending on the model) will also click when cycling on and off.
- Rattling noises may come from the flow of refrigerant, the water line, or items stored on top of the refrigerator
- Your refrigerator is designed to run more efficiently to keep your food items at the desired temperature. The high efficiency compressor may cause your new refrigerator to run longer than your old one, but it is still more energy efficient than previous models. While running you may hear a pulsating or high-pitched sound.
- You may hear the evaporator fan motor circulating the air through the refrigerator and freezer compartments.
- As each cycle ends, you may hear a gurgling sound due to the refrigerant flowing in your refrigerator.
- Contraction and expansion of the inside walls may cause a popping noise.
- Water dripping on the defrost heater during a defrost cycle may cause a sizzling sound.
- You may hear air being forced over the condenser by the condenser fan.
- You may hear water running into the drain pan during the

REFRIGERATOR DOES NOT OPERATE

Check if...

Then...

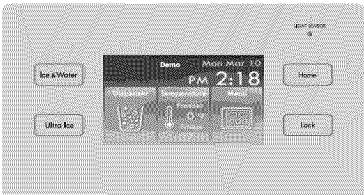
The power supply cord is unplugged.	Firmly plug the cord into a live outlet with proper voltage.
A household fuse has blown or circuit breaker tripped.	Replace the fuse or reset the circuit breaker.
Refrigerator is in the defrost cycle.	Wait about 30 minutes for defrost cycle to end.
Control panel displays DEMO word. 	The refrigerator control has been put into the store Demo (Demonstration) Mode. The Demonstration Mode disables the cooling system, but the compartment lights continue to turn on and the control panel also displays normally. To disable Demo Mode open one door, then press Ultra Ice and Home buttons at the same time for 5 seconds.

VIBRATION OR RATTLING NOISE

Check if...

Then...

The refrigerator is not resting solidly on the floor.	Floor is weak or uneven or leveling legs need adjusting. See DOOR ALIGNMENT Section.
---	---

LIGHTS DO NOT WORK

Check if...

Then...

The power supply cord is unplugged.	Firmly plug the cord into a live outlet with proper voltage.
LED failure.	Refer to the LIGHT (LED) REPLACEMENT section.

TROUBLESHOOTING GUIDE

COMPRESSOR MOTOR SEEMS TO RUN TOO MUCH

Check if...	Then...
The refrigerator that was replaced was an older model.	Modern refrigerators with more storage space require more operating time.
The room temperature is hotter than normal.	The motor will run longer under warm conditions. At normal room temperatures, expect your motor to run about 40% to 80% of the time. Under warmer conditions, expect it to run even more often. These model is still more energy efficient than previous models.
The door is opened often or a large amount of food has just been added.	Adding food and opening the door warms the refrigerator. It is normal for the refrigerator to run longer in order to cool the refrigerator back down. Adding a large amount of food warms the refrigerator. See the FOOD STORAGE GUIDE Section. In order to conserve energy, try to get everything you need out of the refrigerator at once, keep food organized so it is easy to find and close the door as soon as the food is removed.
The refrigerator was recently plugged in and the refrigerator control was set correctly	The refrigerator will take up to 24 hours to cool completely.
The refrigerator control was not set correctly for the surrounding conditions.	See the ADJUSTING CONTROL SETTINGS section.
The doors are not closed completely.	Push the doors firmly shut. If they will not shut all the way, see Doors Will Not Close Completely below.
The condenser coils are dirty.	This prevents air transfer and makes the motor work harder. Clean the condenser coils. Refer to the CARE AND CLEANING section.

DOORS WILL NOT CLOSE COMPLETELY

Check if...	Then...
The refrigerator is not level.	See DOOR ALIGNMENT in the REFRIGERATION INSTALLATION section to level refrigerator.
Food packages are blocking the door open.	Rearrange food containers to clear door and door shelves.
The ice bin, crisper cover, pans, shelves, door bins or baskets are out of position.	Push bins all the way in and put crisper cover, pans, shelves and baskets into their correct positions. See the USING YOUR REFRIGERATOR section.
The gaskets are sticking.	Clean gaskets and the surface that they touch. Rub a thin coat of paraffin wax on the gaskets after cleaning.

THE ICEMAKER IS NOT PRODUCING ICE OR ICE CUBES ARE FREEZING TOO SLOWLY

Check if...	Then...
The freezer temperature is cold enough to produce ice.	Wait 24 hours after hook-up for ice production. See the CONTROL PANEL FEATURES section.
Door left open.	Check to see if something is holding the door open.

TROUBLESHOOTING GUIDE

CUBES PRODUCED BY ICEMAKER ARE TOO SMALL

Check if...

Then...

Water shutoff valve connecting refrigerator to water line may be clogged or water pressure may be too low.	Call a plumber to check the valve and water supply.
Smaller cube size is selected.	Select larger cube size using the Ice Cube Size selector button.

THE DOORS ARE DIFFICULT TO OPEN

Check if...

Then...

The gaskets are dirty or sticky.	Clean gaskets and the surfaces that they touch. Rub a thin coat of appliance polish or paraffin wax on the gaskets after cleaning
The door is reopened within a short time after having been opened.	When you open the door, warmer air enters the refrigerator. As the warm air cools, it can create a vacuum. If the door is hard to open, wait 5 minutes to allow the air pressure to equalize, then see if it opens more easily.

TEMPERATURE IS TOO WARM OR THERE IS INTERIOR MOISTURE BUILDUP

Check if...

Then...

The air vents are blocked. Cold air circulates from the freezer to the fresh food section and back again through air vents in the wall dividing the two sections.	Locate air vents by using your hand to sense airflow and move all packages that block vents and restrict airflow. Refer to ENSURING PROPER AIR CIRCULATION section for the location of air vents.
The doors are opened often.	When the door is opened, warm humid air is allowed into the refrigerator. The more the door is opened, the faster the humidity builds up, and the more warm air the refrigerator must cool. In order to keep the refrigerator cool, try to get everything you need out of the refrigerator at once, keep food organized so it is easy to find and close the door as soon as the food is removed.
The control is not set correctly for the surrounding conditions.	Refer to the CONTROL PANEL FEATURES section. Wait 24 hours for temperatures to stabilize or even out. If the temperature is too cold or too warm, adjust the setting one temperature at a time.
A large amount of food has just been added to the refrigerator or freezer.	Adding food warms the refrigerator. It can take a few hours for the refrigerator to return to normal temperature.
The food is not packaged correctly.	Wrap food tightly and wipe off damp containers prior to storing in the refrigerator to avoid moisture accumulation. If necessary, repackage food according to the guidelines in the FOOD STORAGE GUIDE section.
The doors are not closing completely	See Doors Will Not Close Completely.
The weather is humid.	In humid weather, air carries moisture into refrigerator when doors are opened.
A self-defrost cycle was completed.	It is normal for droplets to form on the back wall after the refrigerator self-defrosts.

TROUBLESHOOTING GUIDE

FROST OR ICE CRYSTALS ON FROZEN FOOD

Check if...	Then...
The door is not closing properly	See Doors Will Not Close Completely above.
The door is opened often.	When the door is opened, warm, humid air is allowed in the freezer resulting in frost.

FROZEN FOOD IN REFRIGERATOR COMPARTMENT

Check if...	Then...
The temperature control in the refrigerator compartment is set too cold.	Access the Refrigerator application, then select Fridge and tap the <input checked="" type="checkbox"/> button to a warmer temperature.
Refrigerator is installed in a cold location.	When room temperature is below 41°F (5°C), food can become frozen. The refrigerator should not be operated in temperatures below 55°F (13°C).
Food with a high water content was placed too close to the air vents.	Place food with a high water content toward the front of the refrigerator.

ICE HAS BAD TASTE OR ODOR

Check if...	Then...
The icemaker was recently installed.	Discard first few batches of ice to avoid discolored or off-flavored ice.
The ice has been stored for too long.	Throw away old ice and make new supply.
The food has not been wrapped tightly in either compartment.	Rewrap foods since odors may migrate to the ice if food is not wrapped properly.
The water supply contains minerals such as sulfur.	A new filter may need to be installed to eliminate taste and odor problems.
The interior of refrigerator needs cleaning.	See CARE AND CLEANING section.
Ice storage bin needs cleaning.	Empty and wash bin. Discard old cubes.

THERE IS WATER IN THE DEFROST DRAIN PAN

Check if...	Then...
The refrigerator is defrosting.	The water will evaporate. It is normal for water to drip into the defrost pan.
It is more humid than normal.	Expect that the water in the defrost pan will take longer to evaporate. This is normal when it is hot or humid.

THE REFRIGERATOR SEEMS TO MAKE TOO MUCH NOISE

Check if...	Then...
The sounds may be normal for your refrigerator.	Refer to the UNDERSTANDING SOUNDS YOU MAY HEAR section.

TROUBLESHOOTING GUIDE

NOT DISPENSING ICE

Check if...	Then...
All the doors are not closed completely.	Ice will not dispense if any of the refrigerator doors are left open.
The dispenser display is locked.	Press and hold the  button for 3 seconds to unlock the control panel and dispenser.
Ice is not selected on the dispenser.	The dispenser can be set for ice or water. Make certain that the control panel is set for the proper operation. Press the Ice & Water button on the control panel to cycle through the ice and water options.
The ice dispenser is not used often.	Check the ice bin for ice cubes clumping/sticking together. If they are, break up the ice cubes allow for proper operation.
Ice bin is not installed correctly.	Be sure to install the ice bin firmly into position.
New installation.	Wait 24 hours after icemaker installation for ice production to begin. Wait 72 hours for full ice production.
Ice cubes are stuck in the delivery chute.	Use a plastic utensil to clear the delivery chute.
The ice dispenser is stalling while dispensing "crushed" ice.	Change the ice button from "crushed" to "cubed". If cubed ice dispenses correctly, depress the button for "crushed" ice and begin dispensing again.
Icemaker power switch in the OFF (O) position.	Move the switch to the ON (I) position.
Water supply turned off or not connected.	See the CONNECTING THE WATER LINE section.

NOT DISPENSING WATER

Check if...	Then...
The dispenser display is locked.	Press and hold the  button for 3 seconds to unlock the control panel and dispenser.
New installation.	Flush and fill the water system.
Refrigerator or freezer doors are not closed properly.	Water will not dispense if any of the refrigerator doors are left open.
Water supply turned off or not connected.	See the CONNECTING THE WATER LINE section.
The water pressure is less than 40 psi.	The water pressure to the home affects the flow from the dispenser.
Home filter or reverse osmosis system is used.	This can decrease water pressure. It is recommended not to connect the supply line to a reverse osmosis system for optimal operation.
The dispenser is not set for water dispensing.	The dispenser can be set for ice or water. Make certain that the control panel is set for the proper operation. Press the dispenser button on the control panel to cycle through the ice and water options.

Get it fixed, at your home or ours!

Your Home

For troubleshooting, product manuals and expert advice:



www.managemylife.com

For repair – **in your home** – of **all** major brand appliances, lawn and garden equipment, or heating and cooling systems, **no matter who made it, no matter who sold it!**

For the replacement parts, accessories and owner's manuals that you need to do-it-yourself.

For Sears professional installation of home appliances and items like garage door openers and water heaters.

1-800-4-MY-HOME[®] (1-800-469-4663)

Call anytime, day or night (U.S.A. and Canada)

www.sears.com www.sears.ca

Our Home

For repair of carry-in items like vacuums, lawn equipment, and electronics, call anytime for the location of your nearest

Sears Parts & Repair Service Center

1-800-488-1222 (U.S.A.)

www.sears.com

1-800-469-4663 (Canada)

www.sears.ca

To purchase a protection agreement on a product serviced by Sears:

1-800-827-6655 (U.S.A.)

1-800-361-6665 (Canada)

Para pedir servicio de reparación a domicilio, y para ordenar piezas:

1-888-SU-HOGAR[®]

(1-888-784-6427)

www.sears.com

Au Canada pour service en français:

1-800-LE-FOYER^{MC}

(1-800-533-6937)

www.sears.ca

The Sears logo, featuring the word "Sears" in a large, stylized, serif font with a distinctive 'S'.