



LCD TV | PLASMA TV OWNER'S MANUAL

LCD TV MODELS

32LC7D
32LC7DC
37LC7D
42LC7D
32LG10

PLASMA TV MODELS

42PC5D
42PC5DC
50PC5D
50PC5DC

Please read this manual carefully before operating your set.

Retain it for future reference.

Record model number and serial number of the set.

See the label attached on the back cover and quote this information to your dealer when you require service.

ENERGY STAR is a set of power-saving guidelines issued by the U.S. Environmental Protection Agency(EPA).



As an ENERGY STAR Partner LGE U. S. A.,Inc. has determined that this product meets the ENERGY STAR guidelines for energy efficiency.

An extended owner's manual that contains information on the advanced features of these LG TV sets is located on the CD-ROM provided in an electronic version.

To read these files, you will need to use personal computer (PC) equipped with a CD-ROM drive.

P/NO : MFL34797033 (0807-REV04)
Printed in Korea

WARNING / CAUTION



WARNING / CAUTION

RISK OF ELECTRIC SHOCK
DO NOT OPEN



**TO REDUCE THE RISK OF ELECTRIC SHOCK
DO NOT REMOVE COVER (OR BACK). NO
USER SERVICEABLE PARTS INSIDE. REFER TO
QUALIFIED SERVICE PERSONNEL.**



The lightning flash with arrowhead symbol, within an equilateral triangle, is intended to alert the user to the presence of uninsulated "dangerous voltage" within the product's enclosure that may be of sufficient magnitude to constitute a risk of electric shock to persons.



The exclamation point within an equilateral triangle is intended to alert the user to the presence of important operating and maintenance (servicing) instructions in the literature accompanying the appliance.

WARNING/CAUTION

TO REDUCE THE RISK OF FIRE AND ELECTRIC SHOCK, DO NOT EXPOSE THIS PRODUCT TO RAIN OR MOISTURE.

NOTE TO CABLE/TV INSTALLER

This reminder is provided to call the CATV system installer's attention to Article 820-40 of the National Electric Code (U.S.A.). The code provides guidelines for proper grounding and, in particular, specifies that the cable ground shall be connected to the grounding system of the building, as close to the point of the cable entry as practical.

WARNING / CAUTION

To prevent fire or shock hazards, do not expose this product to rain or moisture.

FCC NOTICE

Class B digital device

This equipment has been tested and found to comply with the limits for a Class B digital device, pursuant to Part 15 of the FCC Rules. These limits are designed to provide reasonable protection against harmful interference in a residential installation. This equipment generates, uses and can radiate radio frequency energy and, if not installed and used in accordance with the instructions, may cause harmful interference to radio communications. However, there is no guarantee that interference will not occur in a particular installation. If this equipment does cause harmful interference to radio or television reception, which can be determined by turning the equipment off and on, the user is encouraged to try to correct the interference by one or more of the following measures:

- Reorient or relocate the receiving antenna.
- Increase the separation between the equipment and receiver.
- Connect the equipment to an outlet on a circuit different from that to which the receiver is connected.
- Consult the dealer or an experienced radio/TV technician for help.

Any changes or modifications not expressly approved by the party responsible for compliance could void the user's authority to operate the equipment.

CAUTION

Do not attempt to modify this product in any way without written authorization from LG Electronics. Unauthorized modification could void the user's authority to operate this product

SAFETY INSTRUCTIONS

IMPORTANT SAFETY INSTRUCTIONS

Read these instructions.
Keep these instructions.
Heed all warnings.
Follow all instructions.

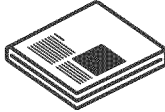

- 1 Do not use this apparatus near water.

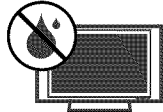

- 2 Clean only with dry cloth.



- 3 Do not block any ventilation openings. Install in accordance with the manufacturer's instructions.

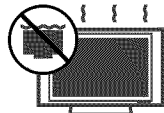

- 4 Do not install near any heat sources such as radiators, heat registers, stoves, or other apparatus (including amplifiers) that produce heat.



- 5 Do not defeat the safety purpose of the polarized or grounding-type plug. A polarized plug has two blades with one wider than the other. A grounding type plug has two blades and a third grounding prong. The wide blade or the third prong are provided for your safety. If the provided plug does not fit into your outlet, consult an electrician for replacement of the obsolete outlet.

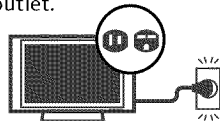

- 6 Protect the power cord from being walked on or pinched particularly at plugs, convenience receptacles, and the point where they exit from the apparatus.

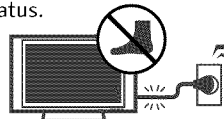

- 7 Only use attachments/accessories specified by the manufacturer.

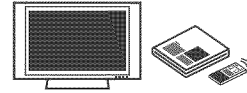

- 8 Use only with the cart, stand, tripod, bracket, or table specified by the manufacturer, or sold with the apparatus. When a cart is used, use caution when moving the cart/apparatus combination to avoid injury from tip-over.

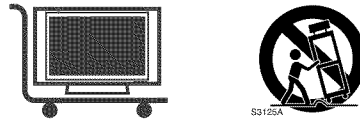

- 9 Unplug this apparatus during lightning storms or when unused for long periods of time.

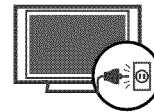

- 10 Refer all servicing to qualified service personnel. Servicing is required when the apparatus has been damaged in any way, such as power-supply cord or plug is damaged, liquid has been spilled or objects have fallen into the apparatus, the apparatus has been exposed to rain or moisture, does not operate normally, or has been dropped.

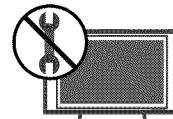

- 11 Never touch this apparatus or antenna during a thunder or lightning storm.

- 12 When mounting a TV on the wall, make sure not to install the TV by the hanging power and signal cables on the back of the TV.

- 13 Do not allow an impact shock or any objects to fall into the product, and do not drop onto the screen with something.

- 14 CAUTION concerning the Power Cord:
It is recommend that appliances be placed upon a dedicated circuit; that is, a single outlet circuit which powers only that appliance and has no additional outlets or branch circuits. Check the specification page of this owner's manual to be certain.

Do not connect too many appliances to the same AC power outlet as this could result in fire or electric shock.

SAFETY INSTRUCTIONS

Do not overload wall outlets. Overloaded wall outlets, loose or damaged wall outlets, extension cords, frayed power cords, or damaged or cracked wire insulation are dangerous. Any of these conditions could result in electric shock or fire. Periodically examine the cord of your appliance, and if its appearance indicates damage or deterioration, unplug it, discontinue use of the appliance, and have the cord replaced with an exact replacement part by an authorized servicer. Protect the power cord from physical or mechanical abuse, such as being twisted, kinked, pinched, closed in a door, or walked upon. Pay particular attention to plugs, wall outlets, and the point where the cord exits the appliance.

Do not make the TV with the power cord plugged in. Do not use a damaged or loose power cord. Be sure do grasp the plug when unplugging the power cord. Do not pull on the power cord to unplug the TV.

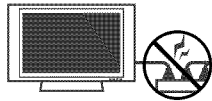

- 15** **WARNING** - To reduce the risk of fire or electrical shock, do not expose this product to rain, moisture or other liquids. Do not touch the TV with wet hands. Do not install this product near flammable objects such as gasoline or candles or expose the TV to direct air conditioning.

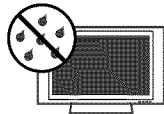

- 16** Do not expose to dripping or splashing and do not place objects filled with liquids, such as vases, cups, etc. on or over the apparatus (e.g. on shelves above the unit).



- 17** **GROUNDING**
Ensure that you connect the earth ground wire to prevent possible electric shock (i.e. a TV with a three-prong grounded AC plug must be connected to a three-prong grounded AC outlet). If grounding methods are not possible, have a qualified electrician install a separate circuit breaker.

Do not try to ground the unit by connecting it to telephone wires, lightning rods, or gas pipes.

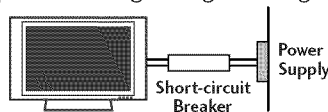

- 18** **DISCONNECTING DEVICE FROM MAINS**
Mains plug is the disconnecting device. The plug must remain readily operable.

- 19** Keep the product away from direct sunlight.

20 ANTENNAS **Outdoor antenna grounding**

If an outdoor antenna is installed, follow the precautions below. An outdoor antenna system should not be located in the vicinity of overhead power lines or other electric light or power circuits, or where it can come in contact with such power lines or circuits as death or serious injury can occur.

Be sure the antenna system is grounded so as to provide some protection against voltage surges and built-up static charges.

Section 810 of the National Electrical Code (NEC) in the U.S.A. provides information with respect to proper grounding of the mast and supporting structure, grounding of the lead-in wire to an antenna discharge unit, size of grounding conductors, location of antenna discharge unit, connection to grounding electrodes and requirements for the grounding electrode.

Antenna grounding according to the National Electrical Code, ANSI/NFPA 70

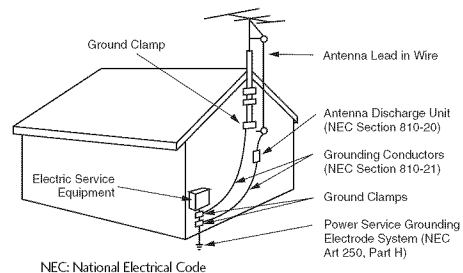

- 21** **Cleaning**
When cleaning, unplug the power cord and scrub gently with a soft cloth to prevent scratching. Do not spray water or other liquids directly on the TV as electric shock may occur. Do not clean with chemicals such as alcohol, thinners or benzene.

- 22** **Moving**
Make sure the product is turned off, unplugged and all cables have been removed. It may take 2 or more people to carry larger TVs. Do not press against or put stress on the front panel of the TV.

- 23** **Ventilation**
Install your TV where there is proper ventilation. Do not install in a confined space such as a bookcase. Do not cover the product with cloth or other materials (e.g.) plastic while plugged in. Do not install in excessively dusty places.

- 24** If you smell smoke or other odors coming from the TV or hear strange sounds, unplug the power cord contact an authorized service center.

On Disposal (Only Hg lamp used LCD TV)

The fluorescent lamp used in this product contains a small amount of mercury. Do not dispose of this product with general household waste. Disposal of this product must be carried out in accordance to the regulations of your local authority.

CONTENTS

WARNING / CAUTION	2
SAFETY INSTRUCTIONS	3

PREPARATION

Accessories	6
Front Panel Information	7
Back Panel Information	8
Remote Control Functions	10
Back Cover for Wire Arrangement	12
Attaching the TV to a wall	14
Desktop Pedestal Installation	14
Stand Installation	15
VESA Wall Mounting	15
Antenna or Cable Connection	16

EXTERNAL EQUIPMENT SETUP

HD Receiver Setup	17
DVD Setup	18

VCR Setup	19
PC Setup	20

WATCHING TV

Turning On TV	21
Channel Selection	21
Volume Adjustment	21
Channel Search	22
On-Screen Menus Selection	23

APPENDIX

Troubleshooting	26
Maintenance	28
Product Specifications	29
Open Source Software Notice	30

HOW TO USE THE OWNER'S MANUAL ON THE CD-ROM

To view the Owner's Manual on the CD-ROM, Adobe Acrobat Reader must be installed on your PC. The "ACRORD" folder on the CD-ROM contains the installation programs for them. If you want to install those programs, Open the "My Computer" → Open the "LG" → Open the "ACRORD" → double-click your language.

TO VIEW THE OWNER'S MANUAL ON THE CD-ROM

The Owner's Manual files are included in the supplied CD-ROM. Load the supplied CD-ROM into the CD-ROM drive of your PC. After a while, the web page of the CD-ROM will open automatically. (for Window only)

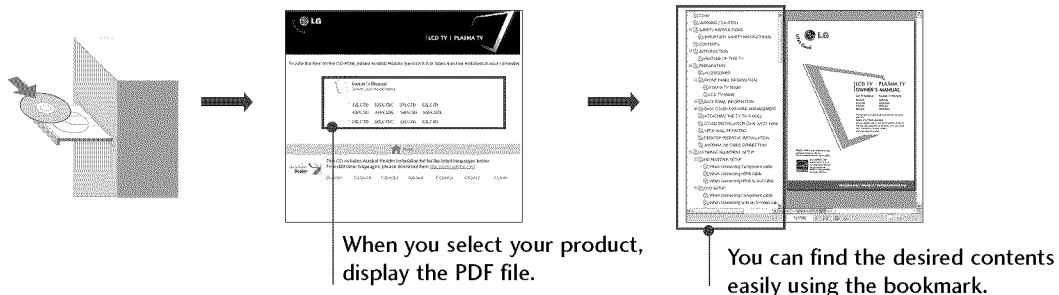

NOTE

▶ If the web page does not appear automatically, open the Owner's Manual file directly. Open the "My computer" → Open the "LG" → Open the "index.htm" file.

PREPARATION

ACCESSORIES

Ensure that the following accessories are included with your product. If an accessory is missing, please contact the dealer where you purchased the product.

User must use shielded signal interface cables (D-sub 15 pin cable) with ferrite cores to maintain standard compliance for the product.

The accessories can be different from the figures shown here.

For further information, see the the Owner's Manual files supplied CD-ROM.

PREPARATION

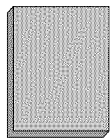

Owner's Manual



CD Manual
(Refer to p.5)

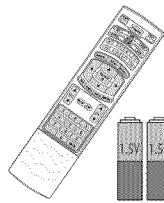

Remote Control,
Batteries

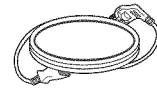

Power Cord



75ohm Round Cable
(This feature is not available for all models)



Polishing Cloth

* Slightly wipe stained spot on the exterior only with the polishing cloth for the product exterior if there is stain or fingerprint on surface of the exterior.

* Do not wipe roughly when removing stain. Please be cautions of that excessive pressure may cause scratch or discoloration.

For Plasma TV models

This feature is not available for all models

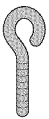

2-Eye-bolts
(Refer to p.14)



2-Wall brackets
(Refer to p.14)

Option Extras

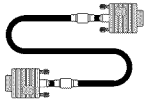

D-sub 15 pin Cable

For LCD TV models



Cable Management

This feature is not available for all models



2- TV Bracket Bolts
(Refer to p.14)



2- TV Brackets,
2- Wall Brackets
(Refer to p.14)



Twist Holder
Arrange the wires with
the twist holder.

32LC7D/7DC, 37LC7D,
32LG10 only



4-Bolts for stand assembly
(Refer to p.15)

FRONT PANEL INFORMATION

- Here shown may be somewhat different from your TV.
- **NOTE:** If your product has a protection tape attached, remove the tape. And then wipe the product with a cloth (If a polishing cloth is included with your product, use it).

Front Panel Controls

Plasma TV Model

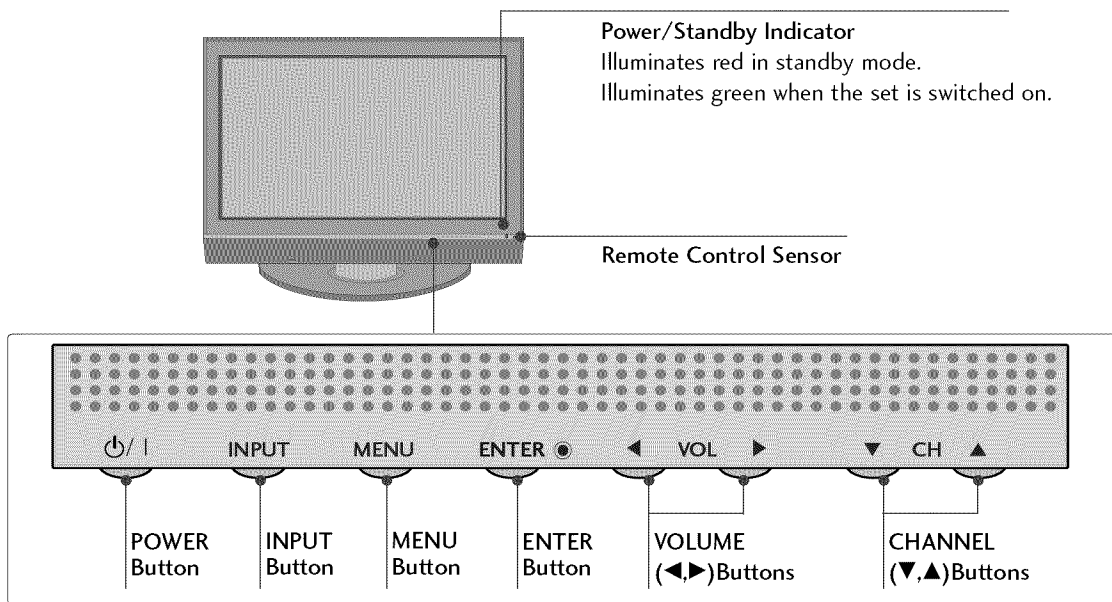

LCD TV Model

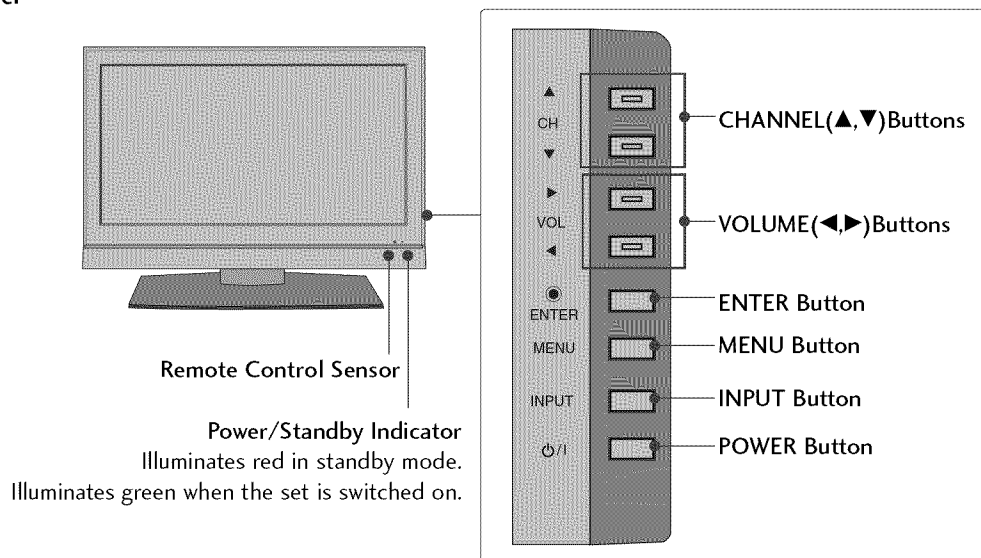

PREPARATION

BACK PANEL INFORMATION

■ Here shown may be somewhat different from your TV.

Plasma TV Model

PREPARATION

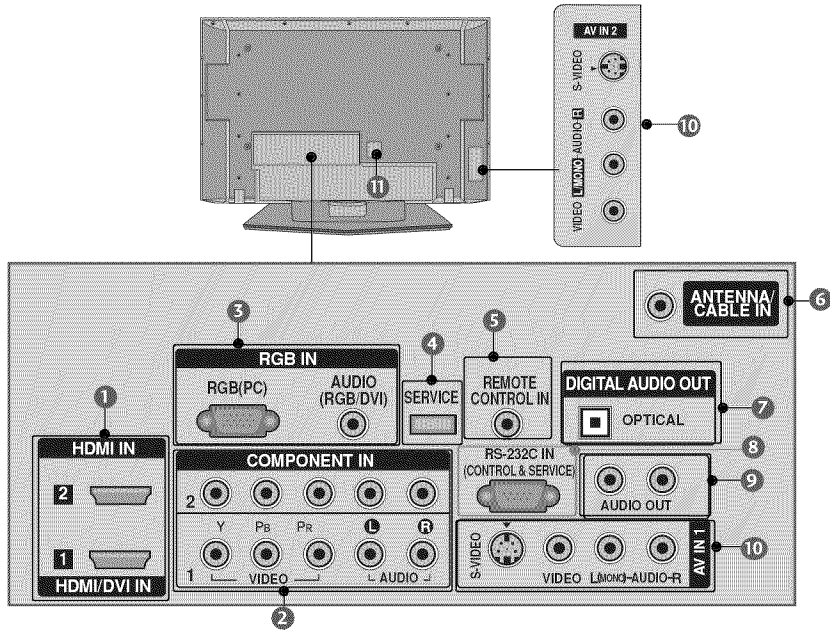

LCD TV Model

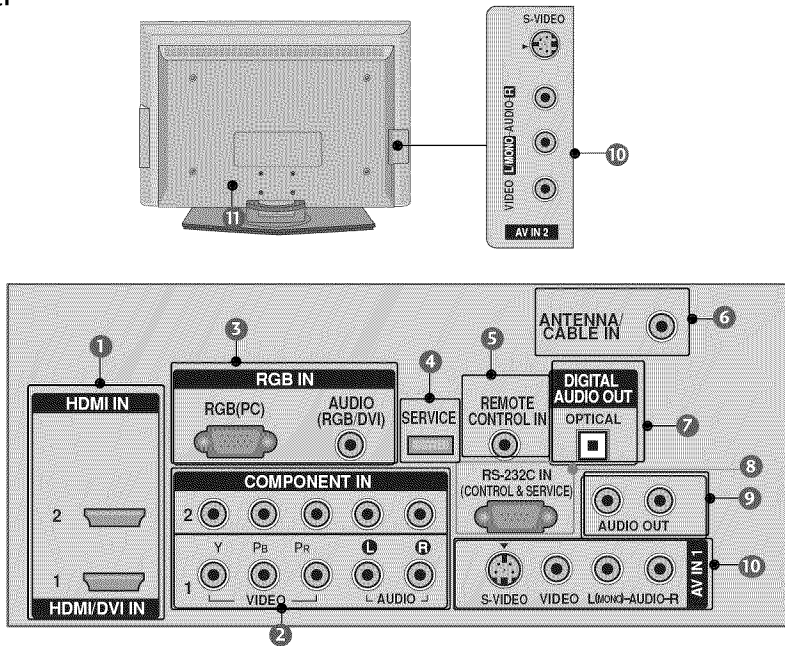

- ① **HDMI/DVI IN 1, HDMI IN 2**
Connect a HDMI (DVI) connection to either input.
- ② **COMPONENT IN**
Connect a component video/audio device to these jacks.
- ③ **RGB (PC)**
Connect the output from a PC.
AUDIO (RGB/DVI)
Connect the audio from a PC or DTV.
- ④ **SERVICE**
- ⑤ **Remote Control Port**
Connect a wired remote control.
- ⑥ **ANTENNA/CABLE IN**
Connect over-the air signals to this jack.
Connect cable signals to this jack.
- ⑦ **DIGITAL AUDIO OUT**
Connect digital audio from various types of equipment.
Note: In standby mode, these ports do not work.
- ⑧ **RS-232C IN (CONTROL & SERVICE) PORT**
For external control devices.
- ⑨ **AUDIO OUT**
Connect analog audio to various types of equipment.
- ⑩ **AV (Audio/Video) IN**
Connect audio/video output from an external device to these jacks.
S-VIDEO
Connect S-Video out from an S-VIDEO device.
- ⑪ **Power Cord Socket**
For operation with AC power.
Caution: Never attempt to operate the TV on DC power.

PREPARATION

REMOTE CONTROL FUNCTIONS

When using the remote control, aim it at the remote control sensor on the TV.

PREPARATION

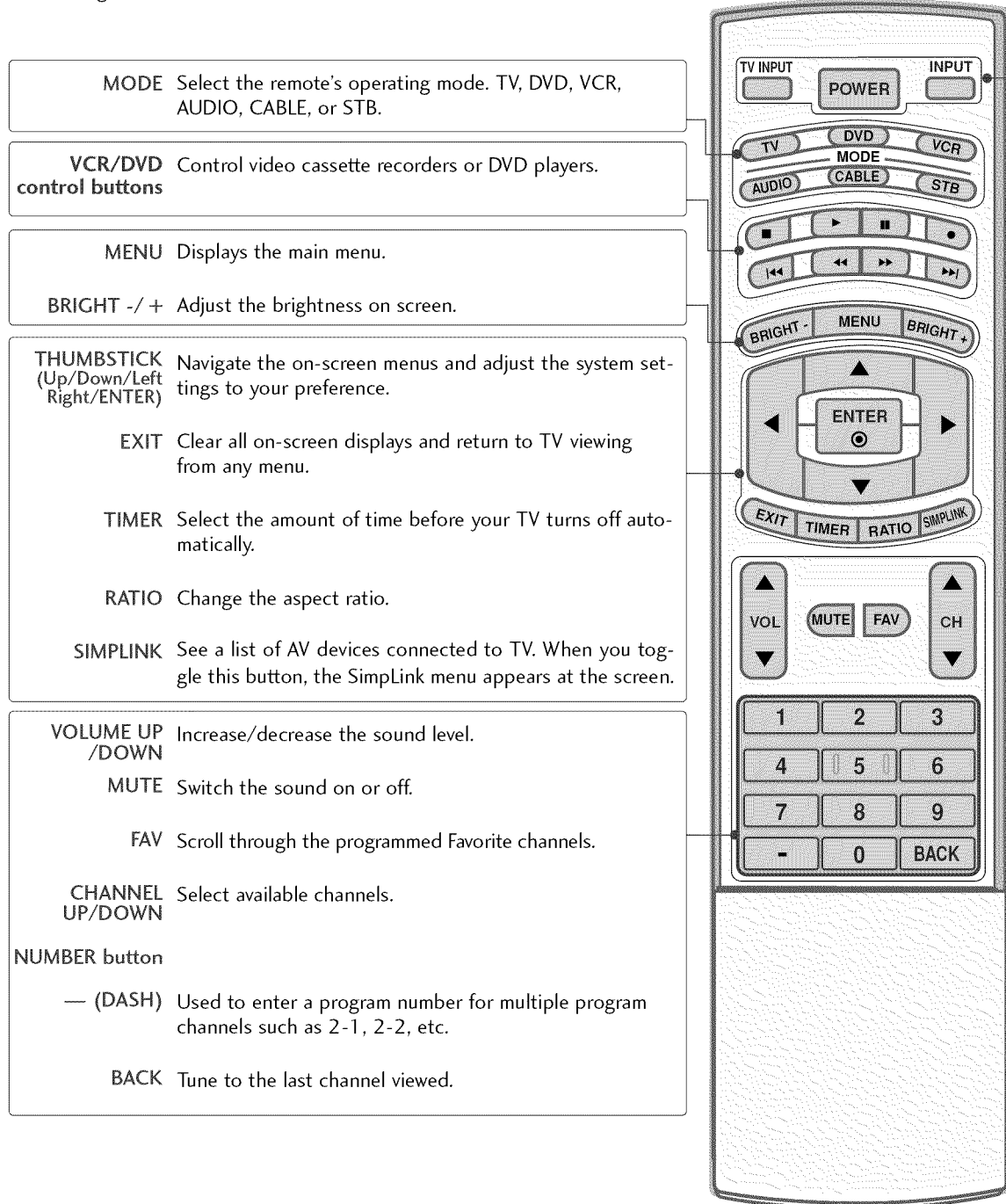

- POWER** Turns your TV or any other programmed equipment on or off, depending on the mode.
- TV INPUT** In AV 1-2, Component 1-2, RGB-PC, HDMI1, and HDMI2 input sources, screen returns to the last TV channel.
- INPUT** External input modes rotate in regular sequence: TV, AV1-2, Component 1-2, RGB-PC, HDMI1 and HDMI2.
(AV 1-2, Component 1-2, RGB-PC, HDMI1, and HDMI2 input sources are linked automatically, only if a device is connected.)

Inside the Sliding Cover

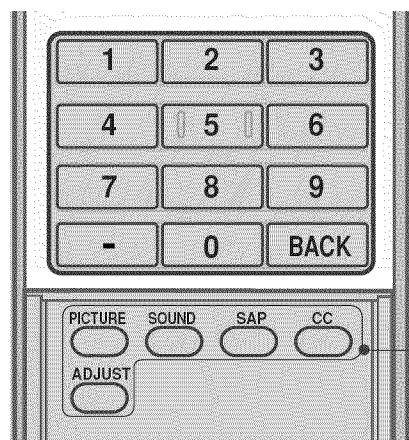

- PICTURE** Selects the factory preset picture depend on the viewing environment.
- SOUND** Selects the factory preset sound for type of program.
- SAP**
 - Analog mode: Selects MTS sound (Mono, Stereo, or a SAP)
 - DTV mode: Changes the audio language.
- CC** Select a closed caption.
- ADJUST** Adjust the screen resolution, position, size and phase.

Installing Batteries

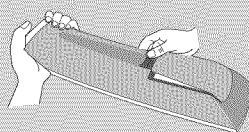

- Open the battery compartment cover on the back side and install the batteries matching correct polarity (+ with +, - with -).
- Install two 1.5V AA batteries. Don't mix old or used batteries with new ones.
- Close cover.

Remote control effective range

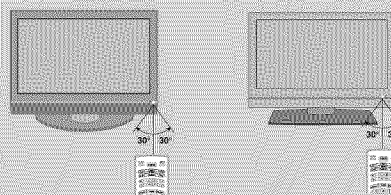

- Use a remote control up to 7 meters distance and 30 degree (left/right) within the receiving unit scope.
- Dispose of used batteries in a recycle bin to preserve environment.

PREPARATION

BACK COVER FOR WIRE ARRANGEMENT

- Here shown may be somewhat different from your TV.

Plasma TV Model

- 1 Hold the **CABLE MANAGEMENT** with both hands and pull it backward as shown.

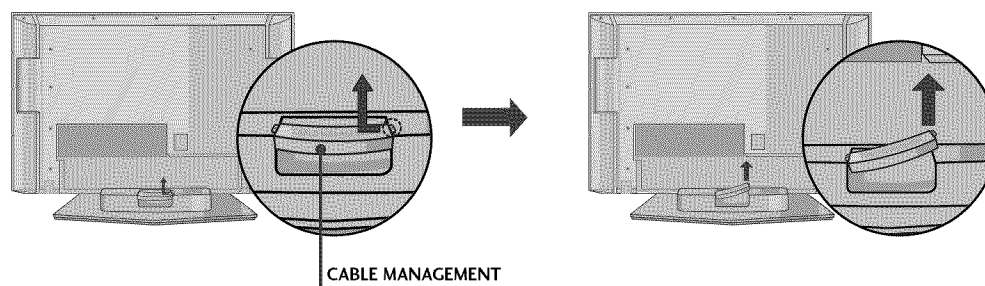

- 2 Connect the cables as necessary.
To connect an additional equipment, see the **EXTERNAL EQUIPMENT SETUP** section.

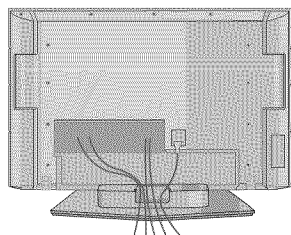

- 3 Install the **CABLE MANAGEMENT** as shown.

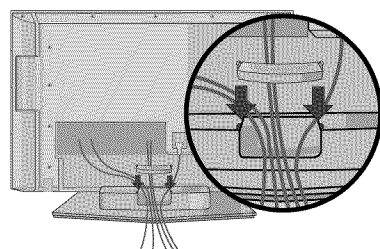

LCD TV Model

- 1 Connect the cables as necessary.
To connect an additional equipment, see the **EXTERNAL EQUIPMENT SETUP** section.

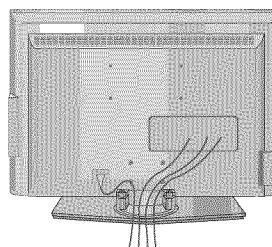

- 2 Install the **CABLE MANAGEMENT** as shown.

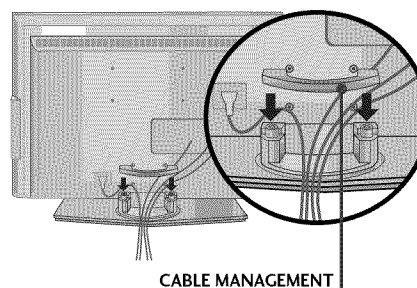

- 3 Bundle the cables using the supplied **TWISTER HOLDER**.
(This feature is not available for all models.)

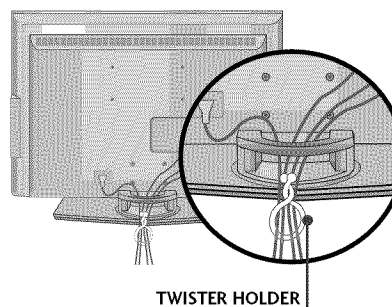

! NOTE

- ▶ Do not hold the **CABLE MANAGEMENT** when moving the product.
- If the product is dropped, you may be injured or the product may be broken.

How to remove the **CABLE MANAGEMENT**

- ▶ Hold the **CABLE MANAGEMENT** with both hands and pull it backward.

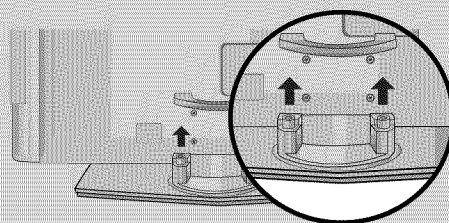

PREPARATION

ATTACHING THE TV TO A WALL

- This feature is not available for all models.
- Here shown may be somewhat different from your TV.

We recommend that you set up the TV close to a wall so it cannot fall over if pushed backwards. Additionally, we recommend that the TV be attached to a wall so it cannot be pulled in a forward direction, potentially causing injury or damaging the product.

Caution: Please make sure that children don't climb on or hang from the TV.

Plasma TV Model

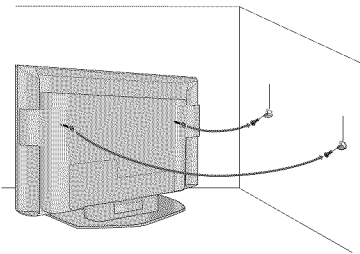

LCD TV Model

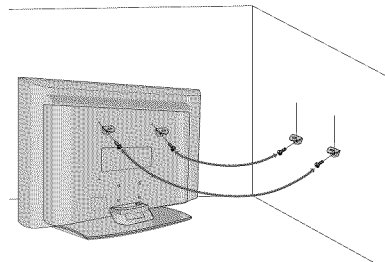

- Insert the eye-bolts (or TV brackets and bolts) to tighten the product to the wall as shown in the picture.
 - * If your product has the bolts in the eye-bolts position before inserting the eye-bolts, loosen the bolts.
- Secure the wall brackets with the bolts (not provided as parts of the product, must purchase separately) to the wall. Match the height of the bracket that is mounted on the wall to the holes in the product. Ensure the eye-bolts or brackets are tightened securely.

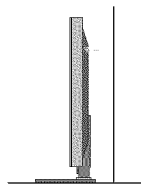

- Use a sturdy rope (not provided as parts of the product, must purchase separately) to tie the product. It is safer to tie the rope so it becomes horizontal between the wall and the product.

DESKTOP PEDESTAL INSTALLATION

For proper ventilation, allow a clearance of 4 inches on all four sides from the wall.

Plasma TV Model

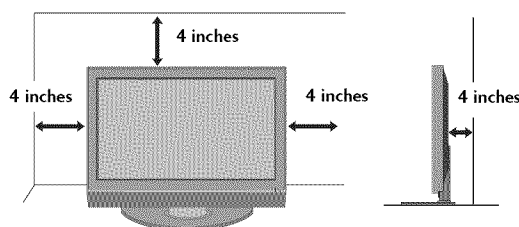

LCD TV Model

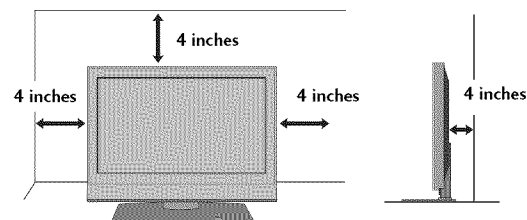

CAUTION ▶ Ensure adequate ventilation by following the clearance recommendations.

STAND INSTALLATION (Only 32LC7D/7DC, 37LC7D, 32LG10)

- 1 Carefully place the product screen side down on a cushioned surface that will protect product and screen from damage.

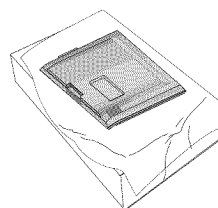

- 2 Assemble the product stand with the product as shown.

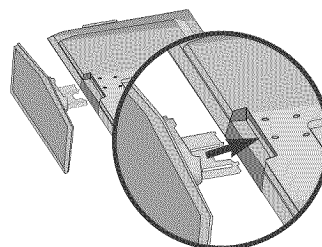

- 3 Securely install the 4 bolts provided.

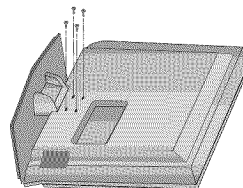

PREPARATION

VESA WALL MOUNTING

This product accepts a VESA-compliant mounting interface pad. (optional)

There 4 threaded holes are available for attaching the bracket.

Plasma TV Model

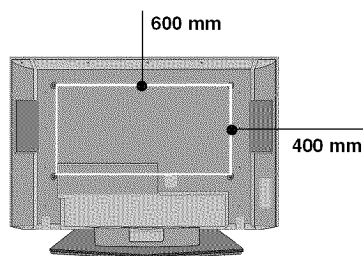

LCD TV Model

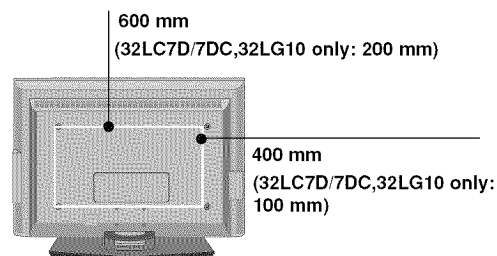

NOTE

- ▶ Screw length needed depends on the wall mount used. For further information, refer to the VESA Wall Mounting Instruction Guide.

PREPARATION

ANTENNA OR CABLE CONNECTION

1. Antenna (Analog or Digital)

Wall Antenna Socket or Outdoor Antenna without a Cable Box Connections.

For optimum picture quality, adjust antenna direction if needed.

PREPARATION

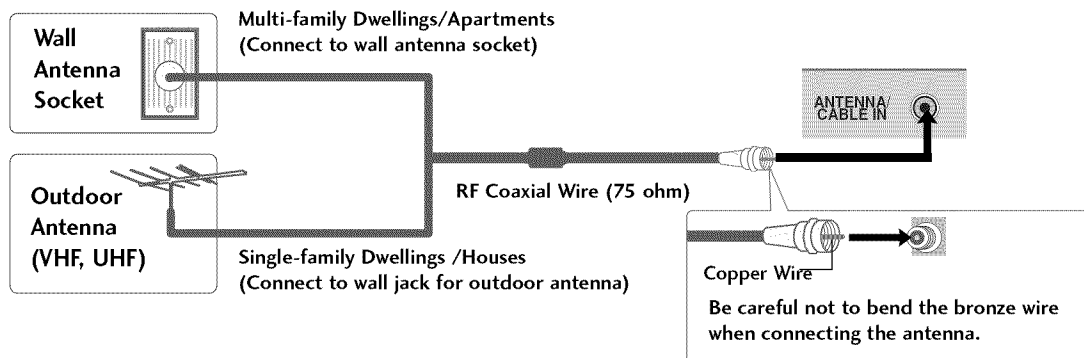

2. Cable

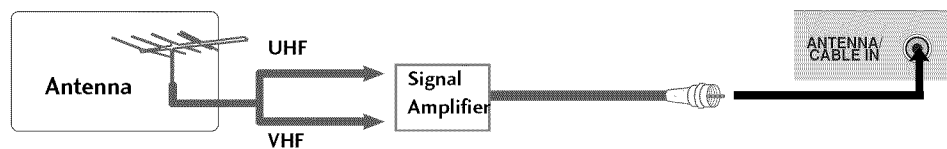
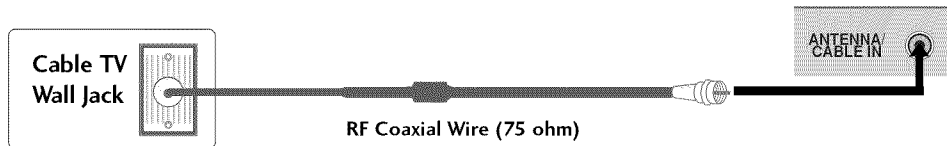

- To improve the picture quality in a poor signal area, please purchase a signal amplifier and install properly.
- If the antenna needs to be split for two TV's, install a 2-Way Signal Splitter.
- If the antenna is not installed properly, contact your dealer for assistance.

NOTE ▶ The TV will let you know when the analog, cable, and digital channel scans are complete.

EXTERNAL EQUIPMENT SETUP

- To prevent the equipment damage, never plug in any power cords until you have finished connecting all equipment.
- This part of EXTERNAL EQUIPMENT SETUP mainly use picture for LCD TV model.

HD RECEIVER SETUP

This TV can receive Digital Over-the-air/Cable signals without an external digital set-top box. However, if you do receive digital signals from a digital set-top box or other digital external device, refer to the figure as shown below.

When connecting Component cable

1. How to connect

- 1 Connect the video outputs (Y, PB, PR) of the digital set top box to the **COMPONENT IN VIDEO 1** jacks on the set. Match the jack colors (Y = green, PB = blue, and PR = red).
- 2 Connect the audio output of the digital set-top box to the **COMPONENT IN AUDIO 1** jacks on the set.

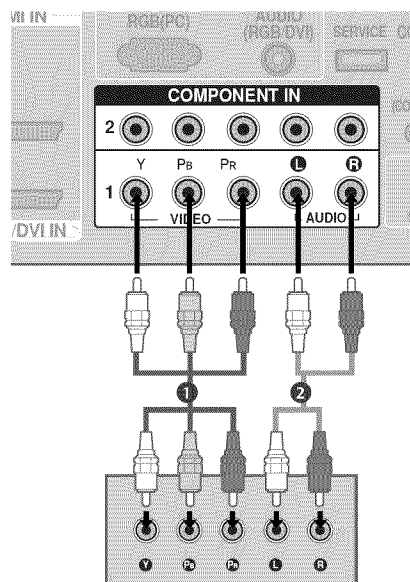

EXTERNAL EQUIPMENT SETUP

2. How to use

- Turn on the digital set-top box.
(Refer to the owner's manual for the digital set-top box operation)
- Select **Component 1** input source by using the **INPUT** button on the remote control.
- If connected to **COMPONENT IN2** input, select **Component 2** input source.

Signal	Component 1/2	HDMI1/DVI, HDMI2
480i	Yes	No
480p	Yes	Yes
720p	Yes	Yes
1080i	Yes	Yes
1080p	Yes	Yes

Y, CB/PB, CR/PR

Resolution	Horizontal Frequency(KHz)	Vertical Frequency(Hz)
720x480i	15.73	59.94
	15.73	60.00
720x480p	31.47	59.94
	31.50	60.00
1280x720p	44.96	59.94
	45.00	60.00
1920x1080i	33.72	59.94
	33.75	60.00
1920x1080p	26.97	23.976
	27.00	24.00
	33.71	29.97
	33.75	30.00
	67.432	59.94
	67.50	60.00

EXTERNAL EQUIPMENT SETUP

DVD SETUP

When connecting Component cable

1. How to connect

- 1 Connect the video outputs (Y, Pb, Pr) of the DVD to the **COMPONENT IN VIDEO1** jacks on the set.
Match the jack colors
(Y = green, Pb = blue, and Pr = red).
- 2 Connect the audio outputs of the DVD to the **COMPONENT IN AUDIO1** jacks on the set.

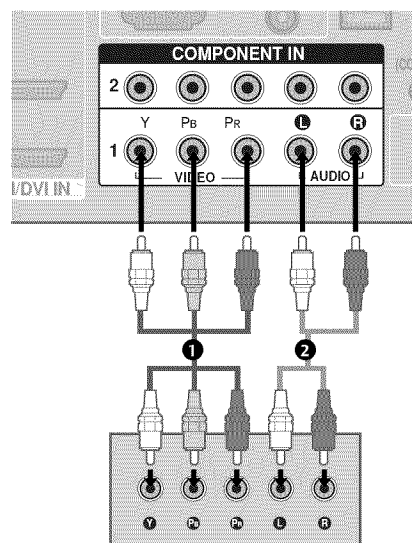

2. How to use

- Turn on the DVD player, insert a DVD.
- Select **Component 1** input source by using the **INPUT** button on the remote control.
- If connected to **COMPONENT IN 2** input, select **Component 2** input source.
- Refer to the DVD player's manual for operating instructions.

When connecting HDMI cable

1. How to connect

- 1 Connect the HDMI output of the DVD to the **HDMI/DVI IN 1** or **HDMI IN 2** jack on the set.
- 2 No separated audio connection is necessary.
HDMI supports both audio and video.

2. How to use

- Select **HDMI1** or **HDMI2** input source by using the **INPUT** button on the remote control.
- Refer to the DVD player's manual for operating instructions.

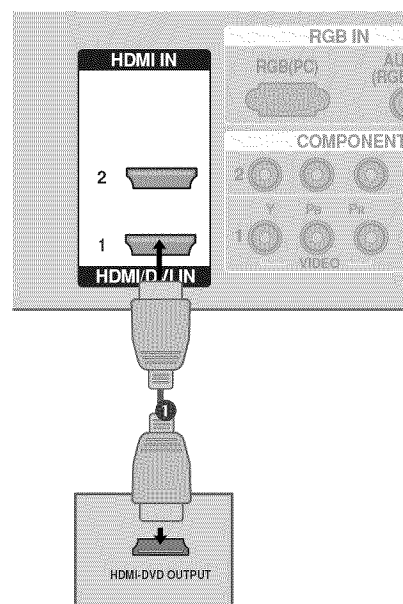



VCR SETUP

When connecting with a RCA cable

1. How to connect

- 1 Connect the **AUDIO/VIDEO** jacks between TV and VCR. Match the jack colors (Video = yellow, Audio Left = white, and Audio Right = red)

2. How to use

- Insert a video tape into the VCR and press **PLAY** on the VCR. (Refer to the VCR owner's manual.)
- Select **AV1** input source by using the **INPUT** button on the remote control.
- If connected to **AV IN2**, select **AV2** input source.

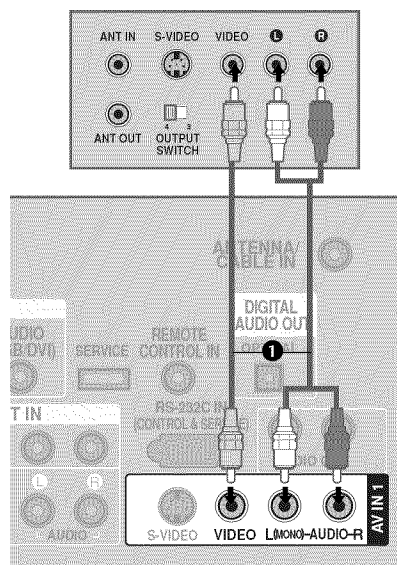

NOTE ▶ If you have a mono VCR, connect the audio cable from the VCR to the **AUDIO L/MONO** jack of the set.

When connecting with an S-Video cable

1. How to connect

- 1 Connect the **S-VIDEO** output of the VCR to the **S-VIDEO** input on the set.
- 2 Connect the audio outputs of the VCR to the **AUDIO** input jacks on the set.

2. How to use

- Insert a video tape into the VCR and press **PLAY** on the VCR. (Refer to the VCR owner's manual.)
- Select **AV1** input source by using the **INPUT** button on the remote control.
- If connected to **AV IN2**, select **AV2** input source.

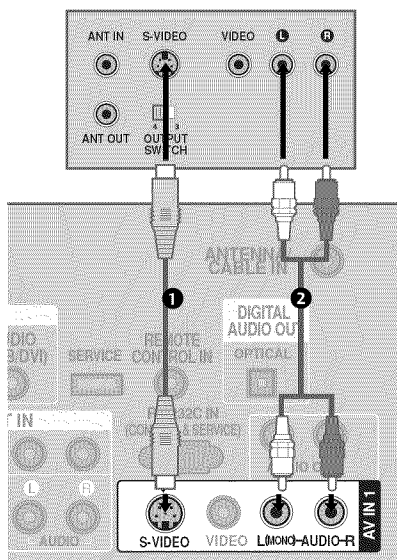

NOTE

- ▶ The picture quality is improved: compared to normal composite (RCA cable) input.

CAUTION

- ▶ Do not connect to both Video and S-Video at the same time. In the event that you connect both Video and the S-Video cables, only the S-Video will work.

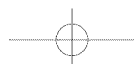

EXTERNAL EQUIPMENT SETUP

PC SETUP

When connecting D-sub 15pin cable

1. How to connect

- 1 Connect the RGB output of the PC to the **RGB (PC)** jack on the set.
- 2 Connect the PC audio output to the **AUDIO (RGB/DVI)** jack on the set.

2. How to use

- Turn on the PC and the TV.
- Select **RGB-PC** input source by using the **INPUT** button on the remote control.

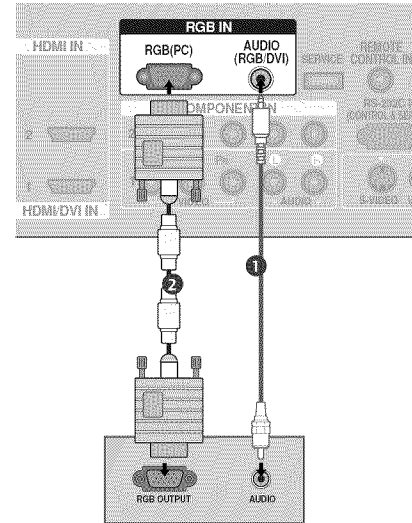

When connecting HDMI to DVI cable

1. How to connect

- 1 Connect the DVI output of the PC to the **HDMI/DVI IN 1** jack on the set.
- 2 Connect the PC audio output to the **AUDIO (RGB/DVI)** jack on the set.

2. How to use

- Turn on the PC and the TV.
- Select **HDMI1** input source by using the **INPUT** button on the remote control.

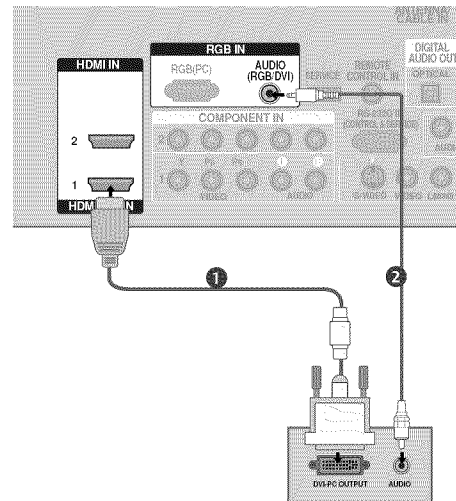

Supported Display Specifications

RGB-PC, HDMI1 /DVI-PC mode

Resolution	Horizontal Frequency(KHz)	Vertical Frequency(Hz)	
640x350	31.469	70.08	●
720x400	31.469	70.08	●
640x480	31.469	59.94	
800x600	37.879	60.31	
1024x768	48.363	60.00	
1280x768	47.776	59.87	
1360x768	47.720	59.799	
1366x768	47.130	59.65	●

* RGB-PC mode only

* LCD TV only

NOTE

- ▶ Depending on graphic card and signal status, there can be some shaking to find best picture in a little time.

WATCHING TV

TURNING ON TV

- 1 First, connect power cord correctly.
At this moment, the TV switches to standby mode.
 - In standby mode to turn TV on, press the ϕ/I , INPUT, CH (\blacktriangle or \blacktriangledown) button on the TV or press the POWER, INPUT, TV INPUT, CH(\blacktriangle or \blacktriangledown), Number (0-9) button on the remote control.
- 2 Select the viewing source by using the TV INPUT, INPUT button on the remote control.
 - This TV is programmed to remember which power state it was last set to, even if the power cord is out.
- 3 When finished using the TV, press the POWER button on the remote control. The TV reverts to standby mode.

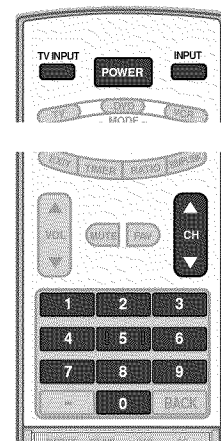

WATCHING TV

NOTE

- ▶ If you intend to be away on vacation, disconnect the power plug from the wall power outlet.

CHANNEL SELECTION

- 1 Press the CH (\blacktriangle or \blacktriangledown) or NUMBER buttons to select a channel number.

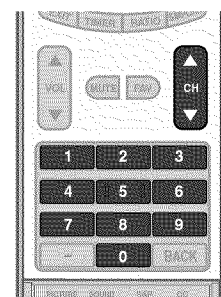

VOLUME ADJUSTMENT

Adjust the volume to suit your personal preference.

- 1 Press the VOL (\blacktriangle or \blacktriangledown) button to adjust the volume.
- 2 If you want to switch the sound off, press the MUTE button.
- 3 You can cancel the Mute function by pressing the MUTE or VOL (\blacktriangle or \blacktriangledown) button.

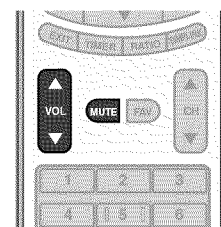

WATCHING TV

CHANNEL SEARCH

Auto Scan (Auto Tuning)

Automatically finds all channels available through antenna or cable inputs, and stores them in memory on the channel list.

Run Auto Tuning again after any Antenna/Cable connection changes.

A password is required to gain access to Auto Tuning menu if the Lock System is turned on.

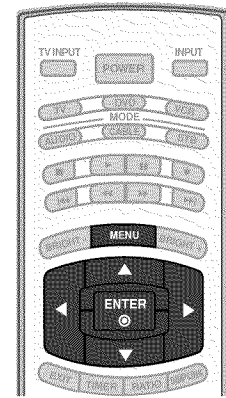

WATCHING TV

1 Press the **MENU** button and then use **▲** or **▼** button to select the **SETUP** menu.

2 Press the **▶** button and then use **▲** or **▼** button to select **Auto Tuning**.

3 Press the **ENTER** button to begin the channel search. Allow **Auto Tuning** to complete the channel search cycle for **ANTENNA** and **CABLE**.

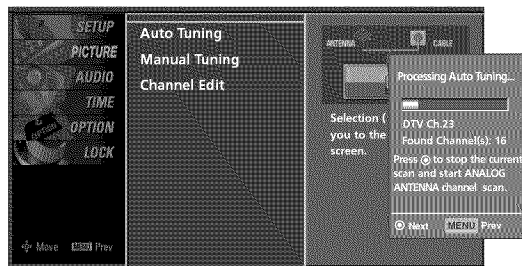
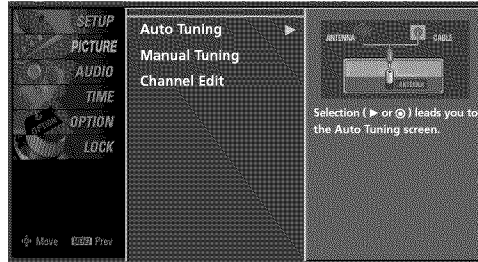
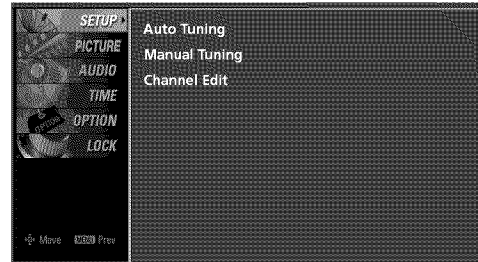

NOTE

Analog TV antenna
 Digital DTV antenna
 Analog CATV cable
 Digital CADTV cable



ON-SCREEN MENU SELECTION

Your TV's OSD (On Screen Display) may differ slightly from what is shown in this manual.

- 1 Press the **MENU** button and then use **▲** or **▼** button to select the each menu.
- 2 Press the **▶** button and then use **▲ ▼ ◀ ▶** button to display the available menus.

SETUP

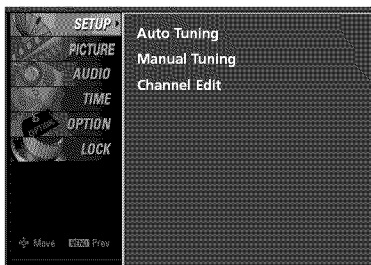

Auto Tuning	■ All available TV channels are searched and stored automatically.
Manual Tuning	■ User can do manual channel selection and add or delete individual channels.
Channel Edit	■ You can add or delete in the channel list.

PICTURE

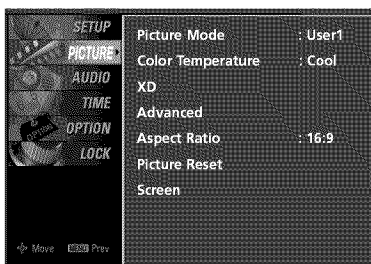

Picture Mode	■ Select the preset value in the Picture Mode menu based on the program category: Dynamic, Standard, Mild, User1, User2.
Color Temperature	■ Choose one of three automatic color adjustments : Cool, Medium, Warm, User
XD	■ It is LG Electronic's unique picture improving technology to display a real HD source through an advanced digital signal processing algorithm. ■ Select Auto or Manual (XD Contrast, XD Color, XD Noise).
Advanced	■ Cinema 3:2 Mode (On, Off) Set up the TV for the best picture appearance for viewing movies. ■ Black Level (Low, High) Adjusting the contrast and the brightness of the screen using the black level of the screen.
Aspect Ratio	■ Select the desired picture format. : Set by program, 4:3, 16:9, Zoom1, Zoom2, Just Scan.
Picture Reset	■ Use to quickly reset all the Picture menu options to their original factory preset values.
Screen	■ Adjust the screen Resolution, Position, Size, Phase, Reset.

WATCHING TV

AUDIO

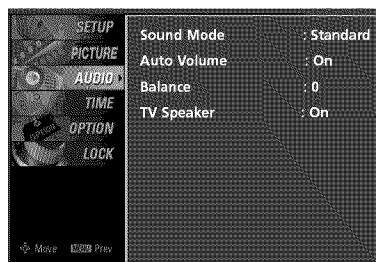

Sound Mode	<ul style="list-style-type: none"> ■ Sound Mode lets you enjoy the best sound without any special adjustment. ■ : Standard, Music, Movie, Sports and User
Auto Volume	<ul style="list-style-type: none"> ■ Scans for changes in sound levels during commercials, then adjusts the sound to match the specified audio level.
Balance	<ul style="list-style-type: none"> ■ Adjust the left/right sound of speaker.
TV Speaker	<ul style="list-style-type: none"> ■ Turn the TV speaker On or off.

TIME

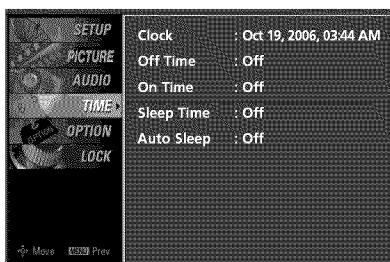

Clock	<ul style="list-style-type: none"> ■ Auto: The time is set automatically from a digital channel signal. ■ Select your viewing area time zone. ■ Select Auto, Off, On depending on whether or not your viewing area observes Daylight Saving time. ■ Manual: Set the clock manually.
Off Time	<ul style="list-style-type: none"> ■ Select On or Off.
On Time	<ul style="list-style-type: none"> ■ Select On or Off.
Sleep Time	<ul style="list-style-type: none"> ■ Select the amount of time before your TV turns off automatically: Off, 10, 20, 30, 60, 90, 120, 180, 240.
Auto Sleep	<ul style="list-style-type: none"> ■ TV will be automatically turned off, in case of no signal for 10 minutes.



OPTION

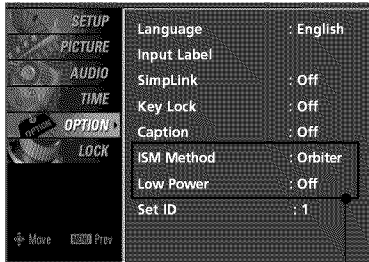

Plasma TV model only

Language	■ Select your desired language for on screen menus : English, Spanish, French.
Input Label	■ Set a label to each input source.
SimpLink	■ Control and play other AV devices connected to the TV through HDMI cable without additional cables and settings.
key Lock	■ This feature can be used to prevent unauthorized viewing by locking out the front panel controls.
Caption	■ Mode: When selecting Off, Submenus for Analog, DTV, and Digital Option become disabled. ■ Analog: CC1 ~ CC4 , Text1 ~ Text4. ■ Digital: Service1 ~ Service6 ■ Digital Option: Customize the DTV/CADTV captions that appear on your screen.
ISM Method	■ Use it to minimize any fixed image on the screen. : Normal, Orbiter, Inversion, White Wash.
Low Power	■ Reduces the plasma display power consumption.
Set ID	■ Choose the desired TV ID number.

WATCHING TV

LOCK

For USA

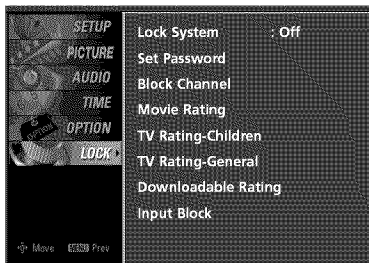

For Canada

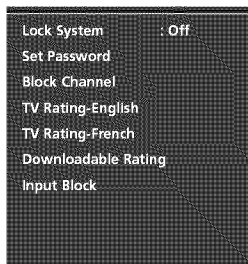

Lock System	■ Select On or Off.
Set Password	■ Change the password.
Block Channel	■ Select a channel number that you wish to block.
Movie Rating	■ Blocks movies according to the movie ratings limits specified.
TV Rating-Children	■ Prevents children from watching certain children's TV programs, according to the ratings limit set.
TV Rating-General	■ Based on the ratings, blocks certain TV programs that you and your family do not want to view.
TV Rating-English	■ Selecting canadian english language rating system.
TV Rating-French	■ Selecting canadian french language rating system.
Downloadable Rating	■ This function may become available in the future and will be available only for digital channel signal.
Input Block	■ Enables you to select a source to block from the external source devices you have hooked up.

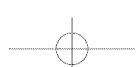

APPENDIX

TROUBLESHOOTING

The operation does not work normally.

The remote control doesn't work

- Check to see if there is any object between the product and the remote control causing obstruction. Ensure you are pointing the remote control directly at the TV.
- Ensure that the batteries are installed with correct polarity (+ to +, - to -).
- Ensure that the correct remote operating mode is set: TV, VCR etc.
- Install new batteries.

Power is suddenly turned off

- Is the sleep timer set?
- Check the power control settings. Power interrupted.
- No broadcast on station tuned with Auto off activated.

The video function does not work.

No picture & No sound

- Check whether the product is turned on.
- Try another channel. The problem may be with the broadcast.
- Is the power cord inserted into wall power outlet?
- Check your antenna direction and/or location.
- Test the wall power outlet, plug another product's power cord into the outlet where the product's power cord was plugged in.

Picture appears slowly after switching on

- This is normal, the image is muted during the product startup process. Please contact your service center, if the picture has not appeared after five minutes.

No or poor color or poor picture

- Adjust Color in menu option.
- Keep a sufficient distance between the product and the VCR.
- Try another channel. The problem may be with the broadcast.
- Are the video cables installed properly?
- Activate any function to restore the brightness of the picture.

Horizontal/vertical bars or picture shaking

- Check for local interference such as an electrical appliance or power tool.

Poor reception on some channels

- Station or cable product experiencing problems, tune to another station.
- Station signal is weak, reorient antenna to receive weaker station.
- Check for sources of possible interference.

Lines or streaks in pictures

- Check antenna (Change the direction of the antenna).

The audio function does not work.

Picture OK & No sound

- Press the VOL or VOLUME button.
- Sound muted? Press MUTE button.
- Try another channel. The problem may be with the broadcast.
- Are the audio cables installed properly?

No output from one of the speakers

- Adjust Balance in menu option.

Unusual sound from inside the product

- A change in ambient humidity or temperature may result in an unusual noise when the product is turned on or off and does not indicate a fault with the product.

APPENDIX

There is a problem in PC mode. (Only PC mode applied)

The signal is out of range

- Adjust resolution, horizontal frequency, or vertical frequency.
- Check the input source.

Vertical bar or stripe on background & Horizontal Noise & Incorrect position

- Work the Auto configure or adjust clock, phase, or H/V position. (Option)

Screen color is unstable or single color

- Check the signal cable.
- Reinstall the PC video card.

APPENDIX

MAINTENANCE

Early malfunctions can be prevented. Careful and regular cleaning can extend the amount of time you can enjoy your new TV.

Caution: Be sure to turn the power off and unplug the power cord before you begin any cleaning.

Cleaning the Screen

- 1 Here's a great way to keep the dust off your screen for a while. Wet a soft cloth in a mixture of lukewarm water and a little fabric softener or dish washing detergent. Wring the cloth until it's almost dry, and then use it to wipe the screen.
- 2 Make sure the excess water is off the screen, and then let it air-dry before you turn on your TV.

Cleaning the Cabinet

- To remove dirt or dust, wipe the cabinet with a soft, dry, lint-free cloth.
- Please be sure not to use a wet cloth.

Extended Absence

▲ CAUTION

- ▶ If you expect to leave your TV dormant for a long time (such as a vacation), it's a good idea to unplug the power cord to protect against possible damage from lightning or power surges.

PRODUCT SPECIFICATIONS

MODELS		42PC5D (42PC5D-UL) 42PC5DC (42PC5DC-UL)	50PC5D (50PC5D-UL) 50PC5DC (50PC5DC-UL)
Dimensions (Width x Height x Depth)	Including stand	41.3 x 30.2 x 12.2 inches 1048.0 x 766.0 x 310.0 mm	48.9 x 34.9 x 14.6 inches 1242.0 x 887.6 x 370.0 mm
	Excluding stand	41.3 x 28.1 x 3.3 inches 1048.0 x 713.0 x 83.5 mm	48.9 x 32.6 x 3.5 inches 1242.0 x 827.2 x 88.0 mm
Weight	including stand	61.7 pounds / 28.0 kg	86.6 pounds / 39.3 kg
	excluding stand	54.2 pounds / 24.6 kg	76.3 pounds / 34.6 kg
Power requirement Television System Program Coverage External Antenna Impedance		AC100-240V ~ 50/60Hz NTSC-M, ATSC, 64 & 256 QAM VHF 2-13, UHF 14-69, CATV 1-135, DTV 2-69, CADTV 1-135 75 ohm	
Environment condition	Operating Temperature Operating Humidity	32 ~ 104°F (0 ~ 40°C) Less than 80%	
	Storage Temperature Storage Humidity	-4 ~ 140°F (-20 ~ 60°C) Less than 85%	

APPENDIX

MODELS		32LC7D (32LC7D-UK) 32LC7DC (32LC7DC-UK) 32LG10 (32LC7D-UK)	37LC7D (37LC7D-UK)	42LC7D (42LC7D-UK)
Dimensions (Width x Height x Depth)	Including stand	31.8 x 23.9x 9.8 inches 806.6 x 606.5 x 249.0mm	36.5 x 27.3 x 11.0 inches 927.0 x 692.8 x 280.5 mm	40.7 x 29.5 x 11.3 inches 1033.4 x 750.0 x 287.6 mm
	Excluding stand	31.8 x 21.7 x 3.1 inches 806.6 x 552.3 x 79.0 mm	36.5 x 24.8 x 3.5 inches 927.0 x 630.0 x 88.0 mm	40.7 x 27.0x 3.5 inches 1033.4 x 686.8 x 88.5 mm
Weight	including stand	30.2 pounds / 13.7 kg	44.1 pounds / 20.0 kg	54.9 pounds / 24.9 kg
	excluding stand	24.7 pounds / 11.2 kg	35.3 pounds / 16.0 kg	45.0 pounds / 20.4 kg
Power requirement Television System Program Coverage External Antenna Impedance		AC100-240V ~ 50/60Hz NTSC-M, ATSC, 64 & 256 QAM VHF 2-13, UHF 14-69, CATV 1-135, DTV 2-69, CADTV 1-135 75 ohm		
Environment condition	Operating Temperature Operating Humidity	32 ~ 104°F (0 ~ 40°C) Less than 80%		
	Storage Temperature Storage Humidity	-4 ~ 140°F (-20 ~ 60°C) Less than 85%		

■ The specifications shown above may be changed without prior notice for quality improvement.

APPENDIX

OPEN SOURCE SOFTWARE NOTICE

The following GPL executables and LGPL/MPL libraries used in this product are subject to the GPL/LGPL/MPL License Agreements:

GPL EXECUTABLES:

- Linux kernel 2.6.12
- busybox

LGPL LIBRARIES:

- uclibc

MPL LIBRARIES:

- Nanox

LG Electronics offers to provide source code to you on CD-ROM for a charge covering the cost of performing such distribution, such as the cost of media, shipping and handling upon e-mail request to LG Electronics at: Opensource@lge.com

This offer is valid for a period of three(3) years from the date of the distribution of this product by LG Electronics.

You can obtain a copy of the GPL, LGPL and MPL licenses on the CD-ROM provided with this product.

- This software is based in part on the work of the Independent JPEG Group.
- This software includes the Zlib compression library, developed by Jean-loup Gailly and Mark Adler. Copyright (C) 1995-2005 Jean-loup Gailly and Mark Adler

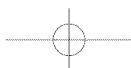
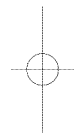
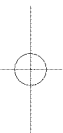



LG Electronics Inc.

