



LCD TV | PLASMA TV OWNER'S MANUAL

LCD TV MODELS

32LC7D
32LC7DC
37LC7D
42LC7D

PLASMA TV MODELS

42PC5D
42PC5DC
50PC5D
50PC5DC

Please read this manual carefully before operating your set.

Retain it for future reference.

Record model number and serial number of the set.

See the label attached on the back cover and quote

this information to your dealer

when you require service.

ENERGY STAR is a set of power-saving guidelines issued by the U.S. Environmental Protection Agency(EPA).



As an ENERGY STAR Partner LGE U. S. A.,Inc. has determined that this product meets the ENERGY STAR guidelines for energy efficiency.



LG's own special digital image generator, consisting of a full digital image processor, six different main picture quality factors.



High-definition television. High-resolution digital television broadcast and playback system composed of roughly a million or more pixels, 16:9 aspect-ratio screens, and AC3 digital audio. A subset of digital television, HDTV formats include 1080i and 720p resolutions.



With HDMI CEC support of LG's audio/video device connected to the HDMI (high-definition multimedia interface), LG TV with this logo works easily with one remote control.



Manufactured under license from Dolby Laboratories. "Dolby" and the double-D symbol are trademarks of Dolby Laboratories.



SRS is a trademark of SRS Labs, Inc. TruSurround XT technology is incorporated under license from SRS Labs, Inc.

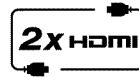

It has 2 HDMI ports that connect audio and video devices with one cable and produces the highest quality digital images and sound.

WARNING / CAUTION



WARNING / CAUTION

**RISK OF ELECTRIC SHOCK
DO NOT OPEN**



**TO REDUCE THE RISK OF ELECTRIC SHOCK
DO NOT REMOVE COVER (OR BACK). NO
USER SERVICEABLE PARTS INSIDE. REFER TO
QUALIFIED SERVICE PERSONNEL.**



The lightning flash with arrowhead symbol, within an equilateral triangle, is intended to alert the user to the presence of uninsulated "dangerous voltage" within the product's enclosure that may be of sufficient magnitude to constitute a risk of electric shock to persons.



The exclamation point within an equilateral triangle is intended to alert the user to the presence of important operating and maintenance (servicing) instructions in the literature accompanying the appliance.

WARNING/CAUTION

TO REDUCE THE RISK OF FIRE AND ELECTRIC SHOCK, DO NOT EXPOSE THIS PRODUCT TO RAIN OR MOISTURE.

NOTE TO CABLE/TV INSTALLER

This reminder is provided to call the CATV system installer's attention to Article 820-40 of the National Electric Code (U.S.A.). The code provides guidelines for proper grounding and, in particular, specifies that the cable ground shall be connected to the grounding system of the building, as close to the point of the cable entry as practical.

WARNING / CAUTION

To prevent fire or shock hazards, do not expose this product to rain or moisture.

FCC NOTICE

Class B digital device

This equipment has been tested and found to comply with the limits for a Class B digital device, pursuant to Part 15 of the FCC Rules. These limits are designed to provide reasonable protection against harmful interference in a residential installation. This equipment generates, uses and can radiate radio frequency energy and, if not installed and used in accordance with the instructions, may cause harmful interference to radio communications. However, there is no guarantee that interference will not occur in a particular installation. If this equipment does cause harmful interference to radio or television reception, which can be determined by turning the equipment off and on, the user is encouraged to try to correct the interference by one or more of the following measures:

- Reorient or relocate the receiving antenna.
- Increase the separation between the equipment and receiver.
- Connect the equipment to an outlet on a circuit different from that to which the receiver is connected.
- Consult the dealer or an experienced radio/TV technician for help.

Any changes or modifications not expressly approved by the party responsible for compliance could void the user's authority to operate the equipment.

CAUTION

Do not attempt to modify this product in any way without written authorization from LG Electronics. Unauthorized modification could void the user's authority to operate this product

SAFETY INSTRUCTIONS

IMPORTANT SAFETY INSTRUCTIONS

Important safety instructions shall be provided with each apparatus. This information shall be given in a separate booklet or sheet, or be located before any operating instructions in an instruction for installation for use and supplied with the apparatus.

This information shall be given in a language acceptable to the country where the apparatus is intended to be used. The important safety instructions shall be entitled "Important Safety Instructions". The following safety instructions shall be included where applicable, and, when used, shall be verbatim as follows. Additional safety information may be included by adding statements after the end of the following safety instruction list. At the manufacturer's option, a picture or drawing that illustrates the intent of a specific safety instruction may be placed immediately adjacent to that safety instruction:

Read these instructions.

Keep these instructions.

Heed all warnings.

Follow all instructions.

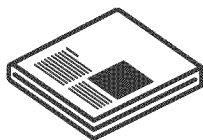

- 1 Do not use this apparatus near water.

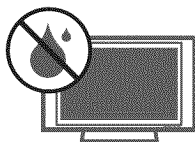

- 2 Clean only with dry cloth.



- 3 Do not block any ventilation openings. Install in accordance with the manufacturer's instructions.

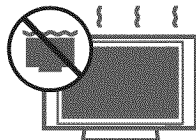

- 4 Do not install near any heat sources such as radiators, heat registers, stoves, or other apparatus (including amplifiers) that produce heat.



- 5 Do not defeat the safety purpose of the polarized or grounding-type plug. A polarized plug has two blades with one wider than the other. A grounding type plug has two blades and a third grounding prong. The wide blade or the third prong are provided for your safety. If the provided plug does not fit into your outlet, consult an electrician for replacement of the obsolete outlet.

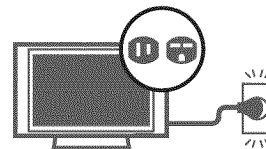

- 6 Protect the power cord from being walked on or pinched particularly at plugs, convenience receptacles, and the point where they exit from the apparatus.

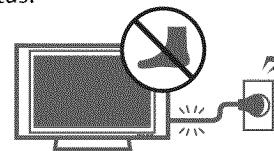

- 7 Only use attachments/accessories specified by the manufacturer.

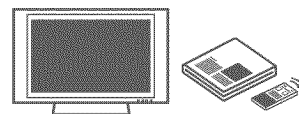

- 8 Unplug this apparatus when unused for long periods of time.

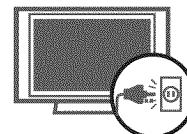

- 9 Use only with the cart, stand, tripod, bracket, or table specified by the manufacturer, or sold with the apparatus. When a cart is used, use caution when moving the cart/apparatus combination to avoid injury from tip-over.

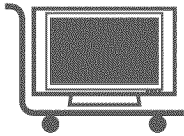

S3125A

- 10 Never touch this apparatus or antenna during a thunder or lightning storm.

- 11 Do not allow a impact shock or any objects to fall into the product, and do not drop onto the screen with something.

- 12 Refer all servicing to qualified service personnel. Servicing is required when the apparatus has been damaged in any way, such as power-supply cord or plug is damaged, liquid has been spilled or objects have fallen into the apparatus, the apparatus has exposed to rain or moisture, does not operate normally, or has been dropped.

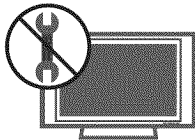

- 13 CAUTION concerning the Power Cord : Most appliances recommend they be placed upon a dedicated circuit; that is, a single outlet circuit which powers only that appliance and has no additional outlets or branch circuits. Check the specification page of this owner's manual to be certain.

Do not overload wall outlets. Overloaded wall outlets, loose or damaged wall outlets, extension cords, frayed power cords, or damaged or cracked wire insulation are dangerous. Any of these conditions could result in electric shock or fire. Periodically examine the cord of your appliance, and if its appearance indicates damage or deterioration, unplug it, discontinue use

of the appliance, and have the cord replaced with an exact replacement part by an authorized servicer. Protect the power cord from physical or mechanical abuse, such as being twisted, kinked, pinched, closed in a door, or walked upon. Pay particular attention to plugs, wall outlets, and the point where the cord exits the appliance.

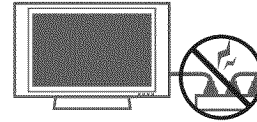

- 14 Outdoor use marking :
WARNING - To reduce the risk of fire or electric shock, do not expose this appliance to rain or moisture.



- 15 Wet Location Marking : Apparatus shall not be exposed to dripping or splashing and no objects filled with liquids, such as vases, shall be placed on or over apparatus.

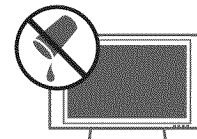

16 GROUNDING

Ensure that you connect the earth ground wire to prevent possible electric shock. If grounding methods are not possible, have a qualified electrician install a separate circuit breaker.

Do not try to ground the unit by connecting it to telephone wires, lightening rods, or gas pipes.

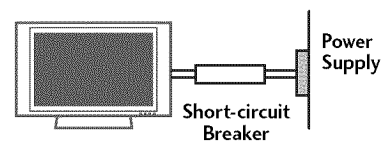

- 17 DISCONNECTING DEVICE FROM MAINS
Mains plug is the disconnecting device. The plug must remain readily operable.

CONTENTS

WARNING / CAUTION	1
SAFETY INSTRUCTIONS	2
INTRODUCTION	6
Feature of this TV	6

PREPARATION

Accessories	7
Front Panel Information	8
Back Panel Information	10
Back Cover for Wire Arrangement	12
Attaching the TV to a Wall	14
Stand Installation	15
VESA Wall Mounting	16
Desktop Pedestal Installation	16
Antenna or Cable Connection	17

EXTERNAL EQUIPMENT SETUP

HD Receiver Setup	18
DVD Setup	21
VCR Setup	23
Other A/V Source Setup	25
PC Setup	26
AV Out Setup & Digital Audio Output	29

WATCHING TV / CHANNEL CONTROL

Remote Control Key Functions	30
Turning On TV	32
Channel Selection	32
Volume Adjustment	32
On-Screen Menus Selection	33
Channel Search	34
- Auto Scan (EZ Scan)	34
- Add / Delete Channel (Manual Scan)	35
- Channel Editing	36
DTV Signal Strength	37
Input Source Selection	38
Input Label	39
SimpLink	40

PICTURE CONTROL

Picture Size (Aspect Ratio) Control	42
Preset Picture Settings	44
- EZ Picture - Preset	44
- Color Tone - Preset	45
Manual Picture Adjustment	46
- EZ Picture - User Mode	46
- Color Tone - User Mode	47
XD - Picture Improvement Technology	48
Advanced - Cinema 3:2 Pulldown Mode	49
Advanced - Black (Darkness) Level	50
Picture Reset	51
Image Sticking Minimization (ISM) Method	52
Low - Power Picture Mode	53

SOUND & LANGUAGE CONTROL

Preset Sound Setting (EZ Sound)	54
Sound Setting Adjustment - User Mode	55
Balance	56
TV Speakers On/Off Setup	57
Stereo/SAP Broadcasts Setup	58
Audio Language	59
On-Screen Menus Language Selection	60
Caption/Text	61
- Analog Broadcasting System Captions	61
- Digital Broadcasting System Captions	62
Caption Option	63

TIME SETTING

Clock Setting	64
- Auto Clock Setup	64
- Manual Clock Setup	65
Auto On/Off Timer Setting	66
Sleep Timer Setting	67
Auto Shut-off Setting.....	68

PARENTAL CONTROL / RATINGS

Set Password & Lock System	69
Channel Blocking	71
External Input Blocking	71
Movie & TV Rating.....	72

APPENDIX

Troubleshooting	75
Maintenance	77
Product Specifications	78
Programming the Remote Control	80
IR Codes	84
External Control Through RS-232C	86

INTRODUCTION

FEATURE OF THIS TV

What is a Plasma TV?

Using plasma is the best way to achieve flat panel displays with excellent image quality and large screen sizes that are easily viewable. The Plasma TV can be thought of as a descendant of the neon lamp and or a series of fluorescent lamps.

How does it work?

Plasma TV is an array of cells, known as pixels, which are comprised of three sub-pixels, corresponding to the colors red, green, and blue. Gas in a plasma state is used to react with phosphors in each sub-pixel to produce colored light (red, green, or blue). These phosphors are the same types used in Cathode Ray Tube (CRT) devices such as televisions and common computer monitors.

Plasma TV offers a rich, dynamic display because each sub-pixel is individually controlled by advanced electronics to produce over 16 million different colors. This means that you get perfect images that are easily viewable in a display that is fewer than five inches thick.

160° - Wide angle range of vision

Your flat panel plasma screen offers an exceptionally broad viewing angle of over 160 degrees. This means that the display is clear and visible to viewers anywhere in the room.

Wide Screen

The wide screen offers a theater-like experience in your own home.

Versatile

The light weight and thin size makes it easy to install your plasma display in a variety of locations where conventional TVs do not fit.

The Plasma TV Manufacturing Process: a few minute colored dots may be present on the Plasma TV screen

The Plasma TV is composed of 0.9 to 2.2 million cells. A few cell defects will normally occur in the Plasma TV manufacturing process. Several tiny, minute colored dots visible on the screen should be acceptable. This also occurs in other Plasma TV manufacturers' products. The tiny dots appearing does not mean

that this Plasma TV is defective. Thus a few cell defects are not sufficient cause for the Plasma TV to be exchanged or returned. Our production technology minimizes these cell defects during the manufacture and operation of this product.

Cooling Fan Noise

-This feature is not available for all models.

In the same way that a fan is used in a PC computer to keep the CPU (Central Processing Unit) cool, the Plasma TV is equipped with cooling fans to cool the Monitor and improve its reliability. Therefore, a certain level of noise could occur while the fans are operating and cooling the Plasma TV.

The fan noise doesn't have any negative effect on the Plasma TV's efficiency or reliability. The noise from these fans is normal during the operation of this product. We hope you understand that a certain level of noise from the cooling fans is acceptable and is not sufficient cause for the Plasma TV to be exchanged or returned.

FOR LCD TV

If the TV feels cold to the touch, there may be a small "flicker" when it is turned on. This is normal, there is nothing wrong with TV.

Some minute dot defects may be visible on the screen, appearing as tiny red, green, or blue spots. However, they have no adverse effect on the monitor's performance.

Avoid touching the LCD screen or holding your finger(s) against it for long periods of time. Doing so may produce some temporary distortion effects on the screen.

On Disposal

- a. The fluorescent lamp used in this product contains a small amount of mercury.
- b. Do not dispose of this product with general household waste.
- c. Disposal of this product must be carried out in accordance to the regulations of your local authority.

PREPARATION

ACCESSORIES

Ensure that the following accessories are included with your product. If an accessory is missing, please contact the dealer where you purchased the product.

User must use shielded signal interface cables (D-sub 15 pin cable) with ferrite cores to maintain standard compliance for the product.

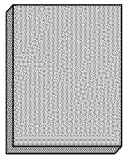

Owner's Manual



CD Manual

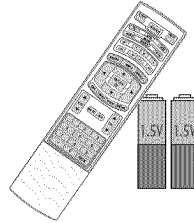

Remote Control,
Batteries

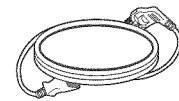

Power Cord



75ohm Round Cable

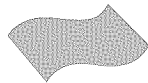

Polishing Cloth

* Slightly wipe stained spot on the exterior only with the polishing cloth for the product exterior if there is stain or fingerprint on surface of the exterior.

* Do not wipe roughly when removing stain. Please be cautious of that excessive pressure may cause scratch or discoloration.

For Plasma TV models

This feature is not available for all models.

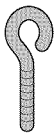

2-Eye-bolts
(Refer to p.14)

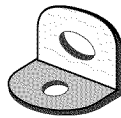

2-Wall brackets
(Refer to p.14)

Option Extras

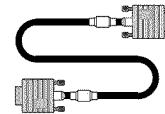

D-sub 15 pin Cable

For LCD TV models

This feature is not available for all models.



Cable
Management



2- TV Bracket Bolts
(Refer to p.14)



2- TV Brackets,
2- Wall Brackets
(Refer to p.14)



Twist Holder
Arrange the wires with
the twist holder.

32/37 inches only



4-Bolts for stand assembly
(Refer to p.15)

PREPARATION

FRONT PANEL INFORMATION

- Here shown may be somewhat different from your TV.
- **NOTE:** If your product has a protection tape attached, remove the tape. And then wipe the product with a cloth (If a polishing cloth is included with your product, use it).

Front Panel Controls

Plasma TV Model

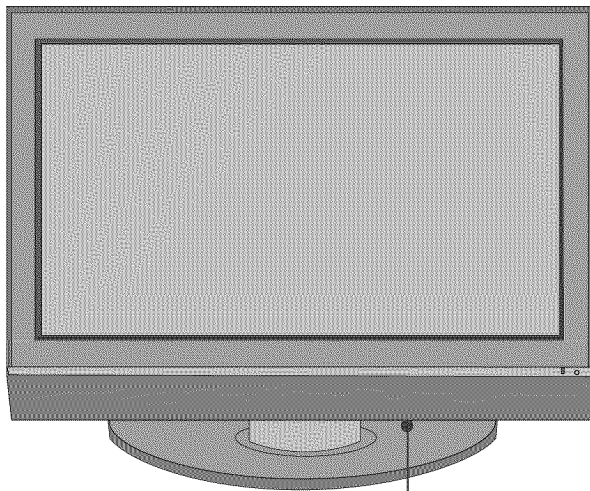

Remote Control Sensor

Power/Standby Indicator

Illuminates red in standby mode. When the TV is turned on, the indicator blinks green and then illuminates green before the picture is displayed.

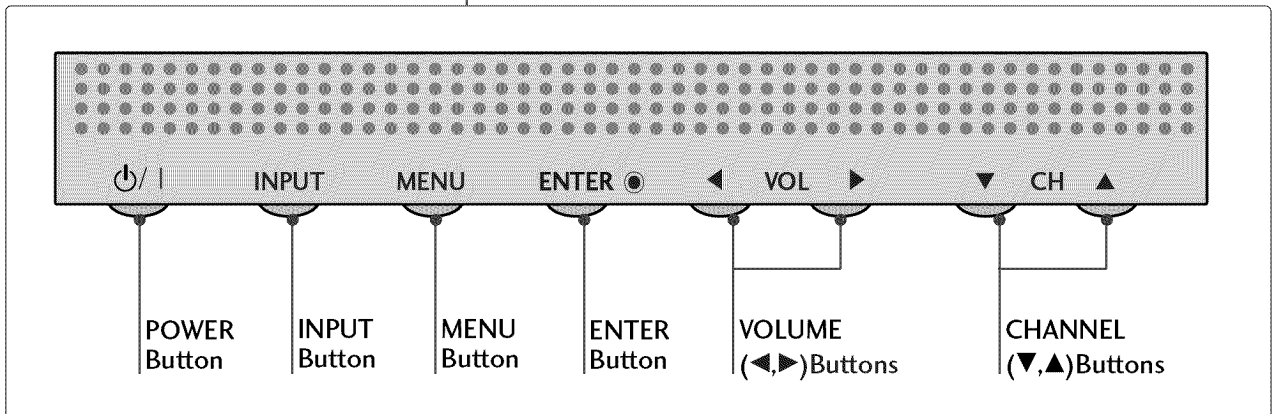

LCD TV Model

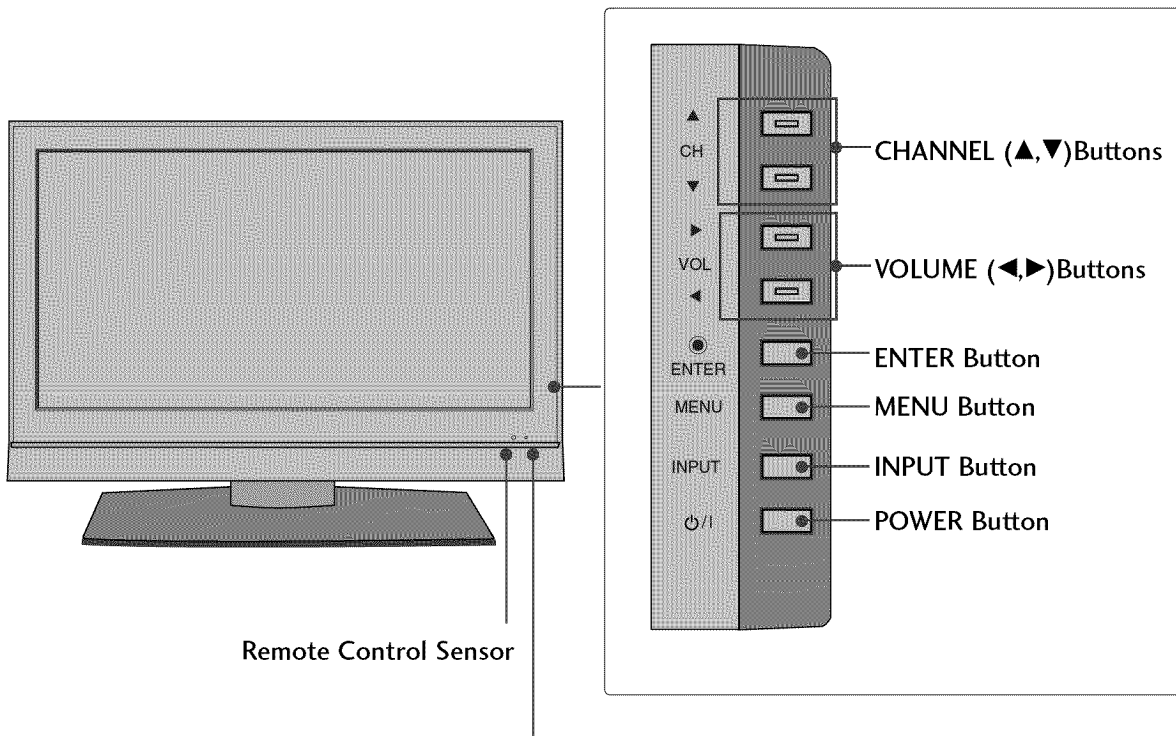

Remote Control Sensor

Power/Standby Indicator

Illuminates red in standby mode.
 When the TV is turned on, the indicator blinks green and then illuminates green before the picture is displayed.

PREPARATION

BACK PANEL INFORMATION

■ Here shown may be somewhat different from your TV.

Back Connection Panel

Plasma TV Model

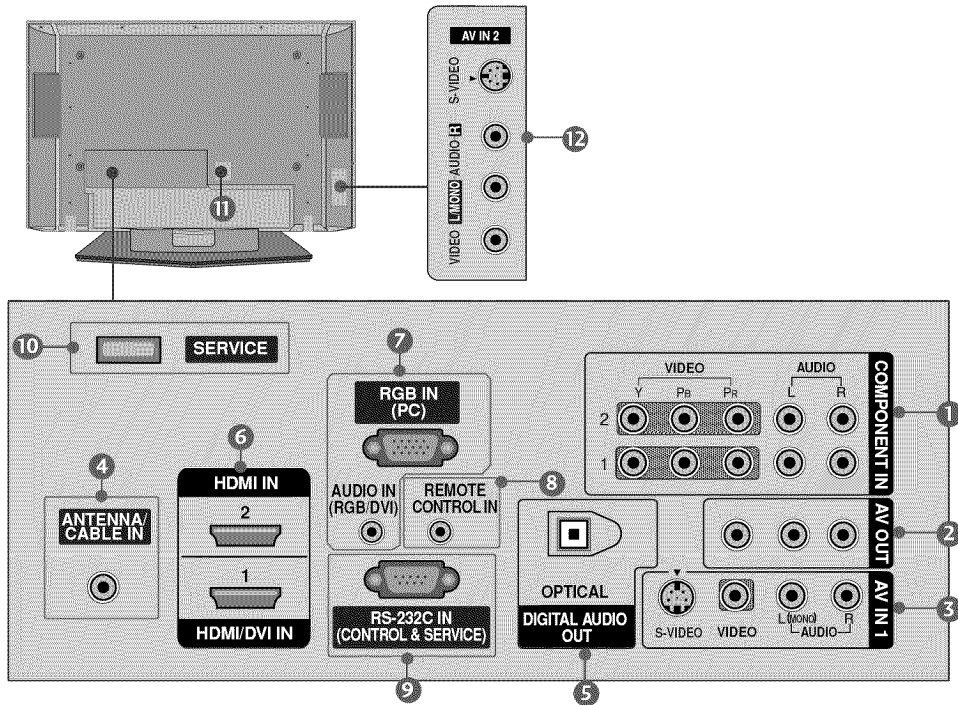

LCD TV Model

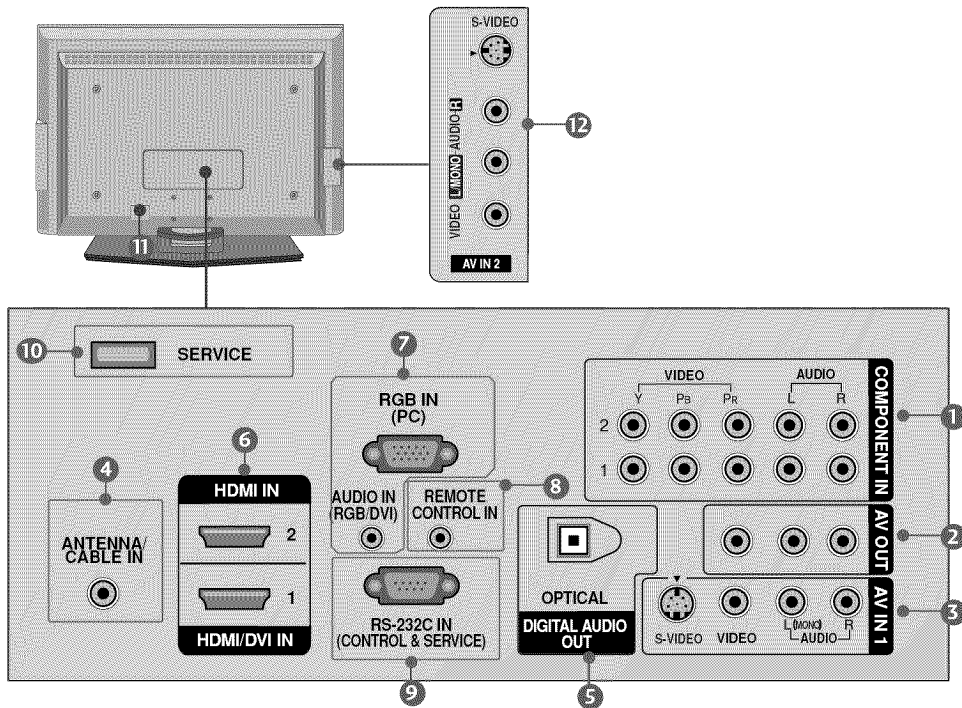

① COMPONENT IN

Connect a component video/audio device to these jacks.

② AV OUT

Connect a second TV or monitor.

③ AV (Audio/Video) IN 1

Connect audio/video output from an external device to these jacks.

S-VIDEO

Connect S-Video out from an S-VIDEO device.

④ ANTENNA/CABLE IN

Connect over-the air signals to this jack.
Connect cable signals to this jack.

⑤ DIGITAL AUDIO OUT

Connect digital audio from various types of equipment.
Note: In standby mode, these ports do not work.

⑥ HDMI/DVI IN 1, HDMI IN 2

Connect a HDMI (DVI) connection to either input.

⑦ RGB IN (PC)

Connect the output from a PC.

AUDIO IN (RGB/DVI)

Connect the audio from a PC or DTV.

⑧ Remote Control Port

Connect a wired remote control.

⑨ RS-232C IN (CONTROL & SERVICE) PORT

For external control devices.

⑩ SERVICE**⑪ Power Cord Socket**

For operation with AC power.

Caution: Never attempt to operate the TV on DC power.

⑫ AV (Audio/Video) IN 2

Connect audio/video output from an external device to these jacks.

S-VIDEO

Connect S-Video out from an S-VIDEO device.

PREPARATION

BACK COVER FOR WIRE ARRANGEMENT

■ Here shown may be somewhat different from your TV.

PREPARATION

Plasma TV Model

- 1 Hold the **CABLE MANAGEMENT** with both hands and pull it backward as shown.

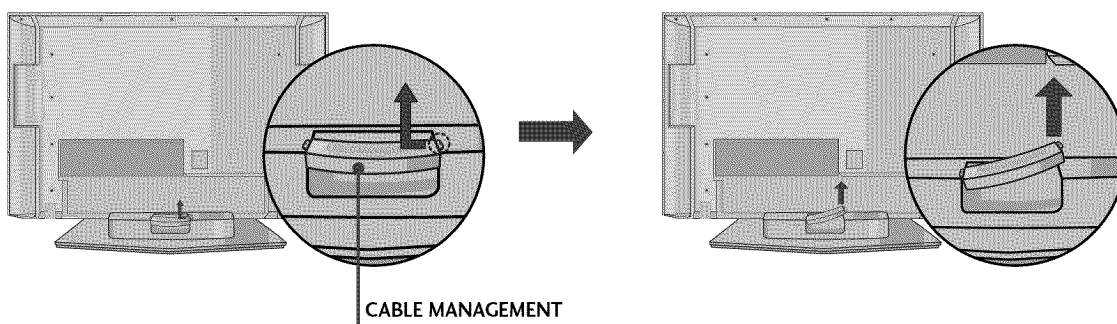

- 2 Connect the cables as necessary.
To connect an additional equipment, see the **EXTERNAL EQUIPMENT SETUP** section.

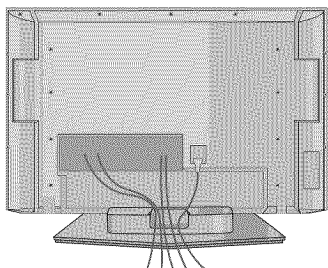

- 3 Install the **CABLE MANAGEMENT** as shown.

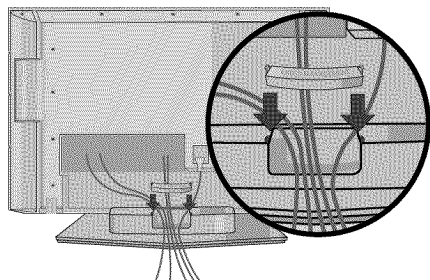

LCD TV Model

- 1 Connect the cables as necessary.
To connect an additional equipment, see the **EXTERNAL EQUIPMENT SETUP** section.

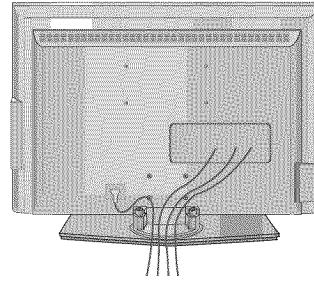

- 2 Install the **CABLE MANAGEMENT** as shown.

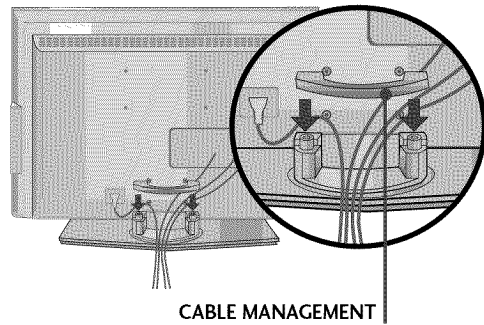

- 3 Bundle the cables using the supplied **TWISTER HOLDER**.
(This feature is not available for all models.)

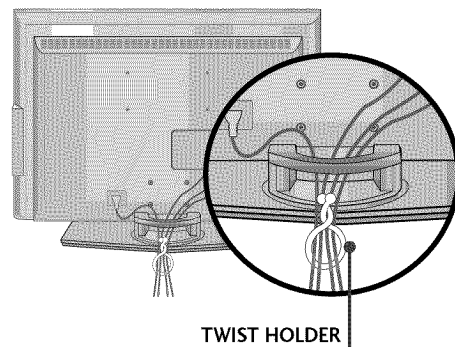

! NOTE

- ▶ Do not hold the **CABLE MANAGEMENT** when moving the product.
- If the product is dropped, you may be injured or the product may be broken.

How to remove the **CABLE MANAGEMENT**

- ▶ Hold the **CABLE MANAGEMENT** with both hands and pull it backward.

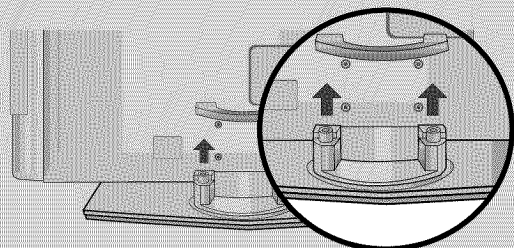

PREPARATION

ATTACHING THE TV TO A WALL

- This feature is not available for all models.
- Here shown may be somewhat different from your TV.

We recommend that you set up the TV close to a wall so it cannot fall over if pushed backwards. Additionally, we recommend that the TV be attached to a wall so it cannot be pulled in a forward direction, potentially causing injury or damaging the product.

Caution: Please make sure that children don't climb on or hang from the TV.

Plasma TV Model

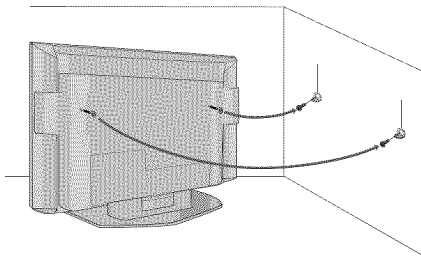

LCD TV Model

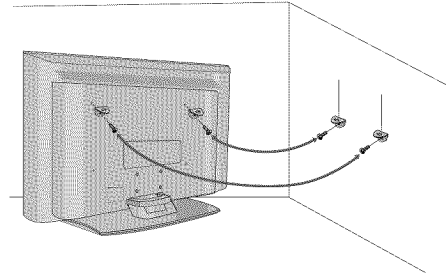

- Insert the eye-bolts (or TV brackets and bolts) to tighten the product to the wall as shown in the picture.
 - * If your product has the bolts in the eye-bolts position before inserting the eye-bolts, loosen the bolts. Secure the wall brackets with the bolts (not provided as parts of the product, must purchase separately) to the wall. Match the height of the bracket that is mounted on the wall to the holes in the product. Ensure the eye-bolts or brackets are tightened securely.

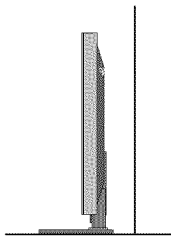

- Use a sturdy rope (not provided as parts of the product, must purchase separately) to tie the product. It is safer to tie the rope so it becomes horizontal between the wall and the product.

STAND INSTALLATION (Only 32/37 inches LCD TV models)

- 1 Carefully place the product screen side down on a cushioned surface that will protect product and screen from damage.

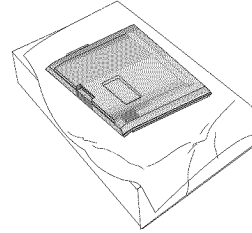

- 2 Assemble the product stand with the product as shown.

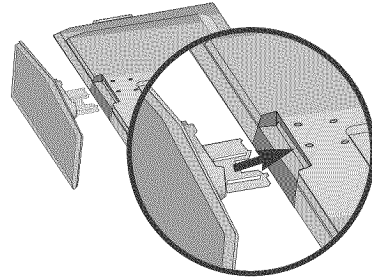

- 3 Securely install the 4 bolts provided.

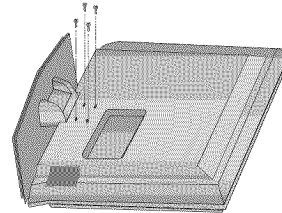

PREPARATION

VESA WALL MOUNTING

This product accepts a VESA-compliant mounting interface pad. (optional)
There 4 threaded holes are available for attaching the bracket.

Plasma TV Model

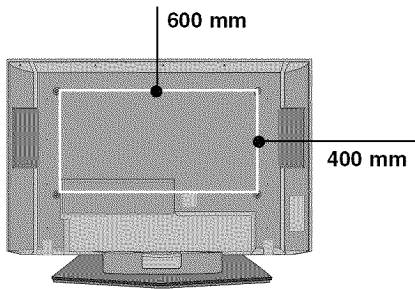

LCD TV Model

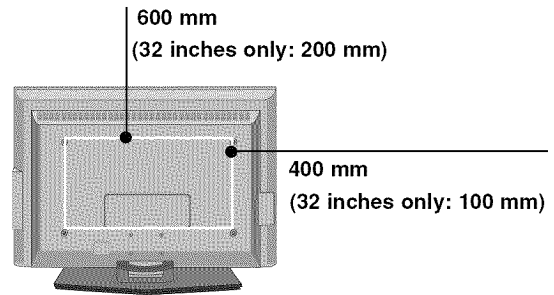

NOTE

► Screw length needed depends on the wall mount used. For further information, refer to the VESA Wall Mounting Instruction Guide.

DESKTOP PEDESTAL INSTALLATION

For proper ventilation, allow a clearance of 4 inches on all four sides from the wall.

Plasma TV Model

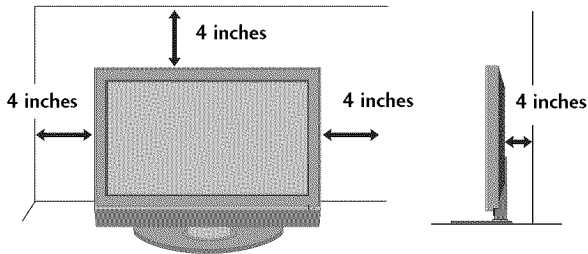

LCD TV Model

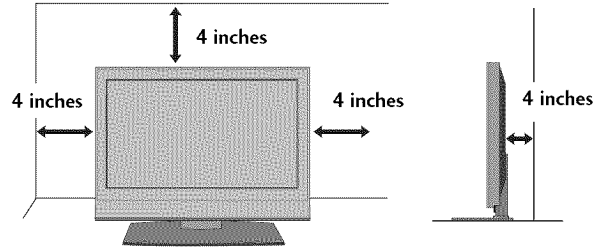

CAUTION ► Ensure adequate ventilation by following the clearance recommendations.

ANTENNA OR CABLE CONNECTION

1. Antenna (Analog or Digital)

Wall Antenna Socket or Outdoor Antenna without a Cable Box Connections.
 For optimum picture quality, adjust antenna direction if needed.

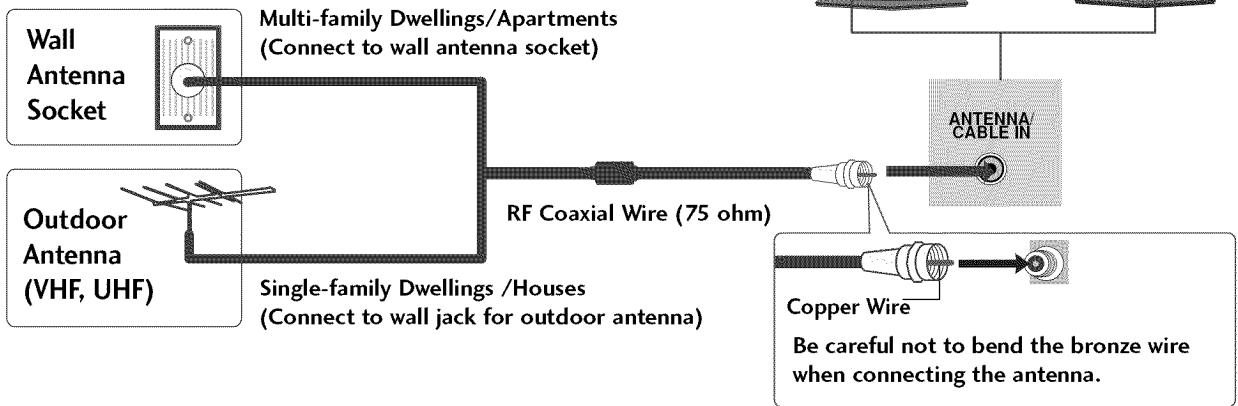

2. Cable

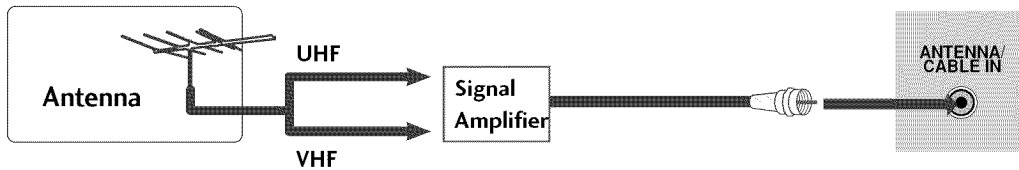

- To improve the picture quality in a poor signal area, please purchase a signal amplifier and install properly.
- If the antenna needs to be split for two TV's, install a 2-Way Signal Splitter.
- If the antenna is not installed properly, contact your dealer for assistance.

NOTE ▶ The TV will let you know when the analog, cable, and digital channel scans are complete.

EXTERNAL EQUIPMENT SETUP

- To prevent the equipment damage, never plug in any power cords until you have finished connecting all equipment.
- This part of EXTERNAL EQUIPMENT SETUP mainly use picture for LCD TV model.

HD RECEIVER SETUP

This TV can receive Digital Over-the-air/Cable signals without an external digital set-top box. However, if you do receive digital signals from a digital set-top box or other digital external device, refer to the figure as shown below.

When connecting Component cable

1. How to connect

- 1 Connect the video outputs (Y, PB, PR) of the digital set top box to the **COMPONENT IN VIDEO 1** jacks on the set. Match the jack colors (Y = green, PB = blue, and PR = red).
- 2 Connect the audio output of the digital set-top box to the **COMPONENT IN AUDIO 1** jacks on the set.

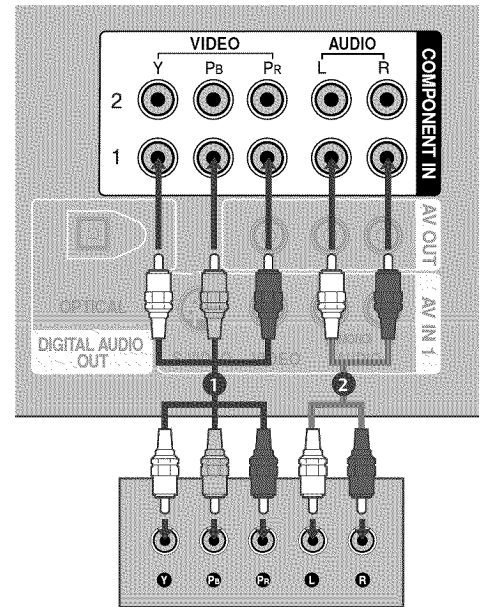

2. How to use

- Turn on the digital set-top box.
(Refer to the owner's manual for the digital set-top box. operation)
- Select **Component 1** input source by using the **INPUT** button on the remote control.
- If connected to **COMPONENT IN2** input, select **Component 2** input source.

Signal	Component 1/2	HDMI1/DVI, HDMI2
480i	Yes	No
480p	Yes	Yes
720p	Yes	Yes
1080i	Yes	Yes
1080p	Yes	Yes

When connecting HDMI cable

1. How to connect

- 1 Connect the digital set-top box to **HDMI/DVI IN 1** or **HDMI IN 2** jack on the set.
- 2 No separated audio connection is necessary. HDMI supports both audio and video.

2. How to use

- Turn on the digital set-top box.
(Refer to the owner's manual for the digital set-top box.)
- Select **HDMI1/DVI** or **HDMI2** input source by using the **INPUT** button on the remote control.

! NOTE

- ▶ When connected, the TV will tell a connected device what resolution it supports and the resolution it prefers. If the device supports this Auto HDMI function, the player output resolution will be automatically set to 720p.
- ▶ If the device does not support Auto HDMI, you need to set the output resolution appropriately.

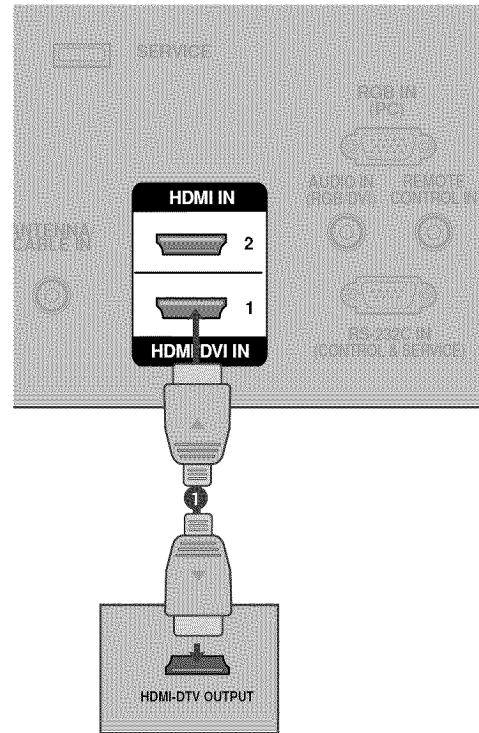

HDMI1/DVI-DTV, HDMI2-DTV mode

Resolution	Horizontal Frequency(KHz)	Vertical Frequency(Hz)
720x480	31.469	59.94
	31.500	60.00
1280x720	44.960	59.94
	45.000	60.00
1920x1080i	33.720	59.94
	33.750	60.00
1920x1080p	27.000	24.00
	33.750	30.00

EXTERNAL EQUIPMENT SETUP

When connecting HDMI to DVI cable

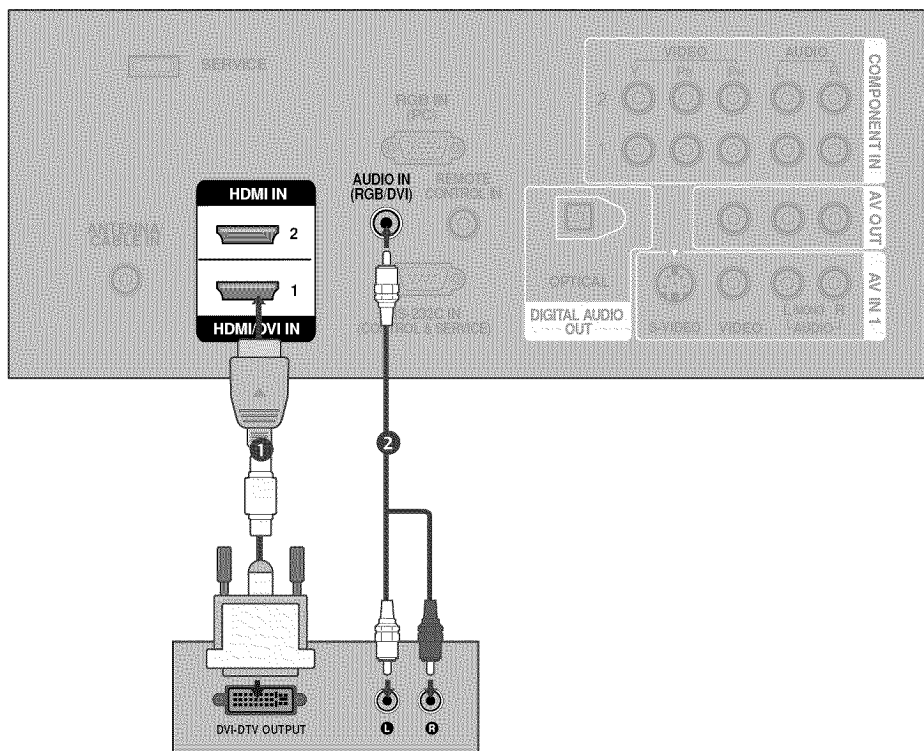

1. How to connect

- 1 Connect the DVI output of the digital set-top box to the **HDMI/DVI IN 1** jack on the set.
- 2 Connect the audio output of the digital set-top box to the **AUDIO IN (RGB/DVI)** jack on the set.

2. How to use

- Turn on the digital set-top box. (Refer to the owner's manual for the digital set-top box.)
- Select **HDMI1/DVI** input source by using the **INPUT** button on the remote control.

DVD SETUP

When connecting Component cable

1. How to connect

- 1 Connect the video outputs (Y, PB, PR) of the DVD to the **COMPONENT IN VIDEO1** jacks on the set.
Match the jack colors
(Y = green, PB = blue, and PR = red).
- 2 Connect the audio outputs of the DVD to the **COMPONENT IN AUDIO1** jacks on the set.

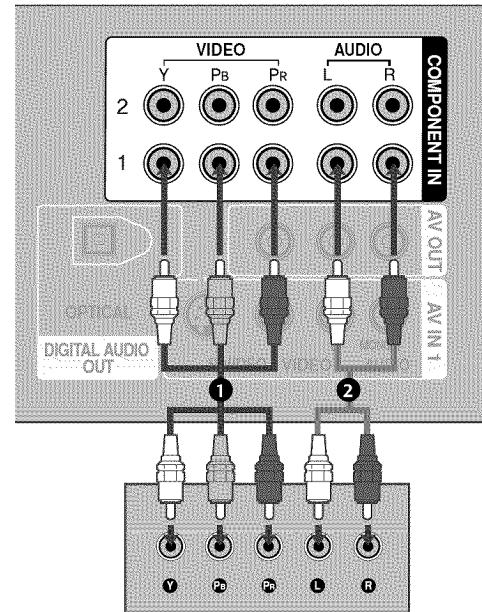

2. How to use

- Turn on the DVD player, insert a DVD.
- Select **Component 1** input source by using the **INPUT** button on the remote control.
- If connected to **COMPONENT IN 2** input, select **Component 2** input source.
- Refer to the DVD player's manual for operating instructions.

Component Input ports

To get better picture quality, connect a DVD player to the component input ports as shown below.

Component ports on the TV	Y	P _B	P _R
Video output ports on DVD player	Y	P _B	P _R
	Y	B-Y	R-Y
	Y	C _b	C _r
	Y	P _b	P _r

EXTERNAL EQUIPMENT SETUP

When connecting with an S-Video cable

1. How to connect

- 1 Connect the S-VIDEO output of the DVD to the S-VIDEO input on the set.
- 2 Connect the audio outputs of the DVD to the AUDIO input jacks on the set.

2. How to use

- Turn on the DVD player, insert a DVD.
- Select AV1 input source by using the INPUT button on the remote control.
- If connected to AV IN2, select AV2 input source.
- Refer to the DVD player's manual for operating instructions.

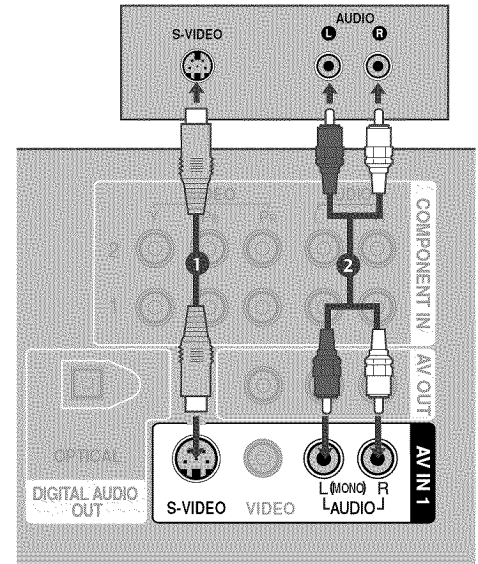

When connecting HDMI cable

1. How to connect

- 1 Connect the HDMI output of the DVD to the HDMI/DVI IN 1 or HDMI IN 2 jack on the set.
- 2 No separated audio connection is necessary. HDMI supports both audio and video.

2. How to use

- Select HDMI1/DVI or HDMI2 input source by using the INPUT button on the remote control.
- Refer to the DVD player's manual for operating instructions.

NOTE

- ▶ When connected, the TV will tell a connected device what resolution it supports and the resolution it prefers. If the device supports this Auto HDMI function, the player output resolution will be automatically set to 720p.
- ▶ If the device does not support Auto HDMI, you need to set the output resolution appropriately. To get the best picture quality, adjust the output resolution of the DVD to 720p.

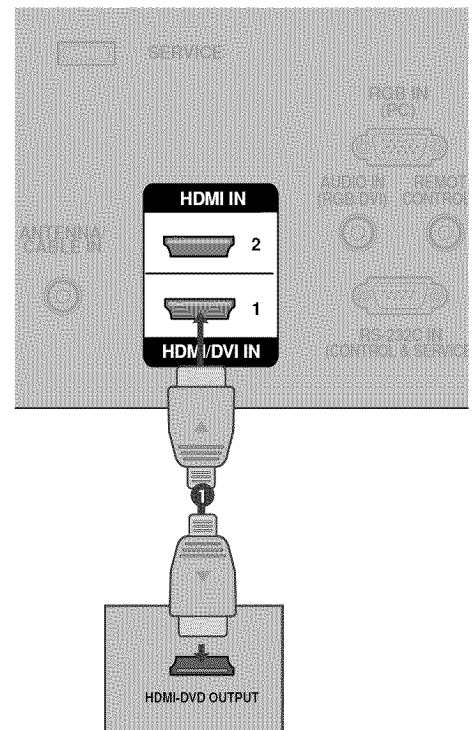

VCR SETUP

- To avoid picture noise (interference), leave an adequate distance between the VCR and TV.
- Use the ISM feature in the Option menu to avoid having a fixed image remain on the screen for a long period of time. If the 4:3 picture format is used; the fixed images on the sides of the screen may remain visible on the screen. This phenomenon is common to all manufactures and in consequence the manufactures warranty does not cover the product bearing this phenomenon.

When connecting with an antenna

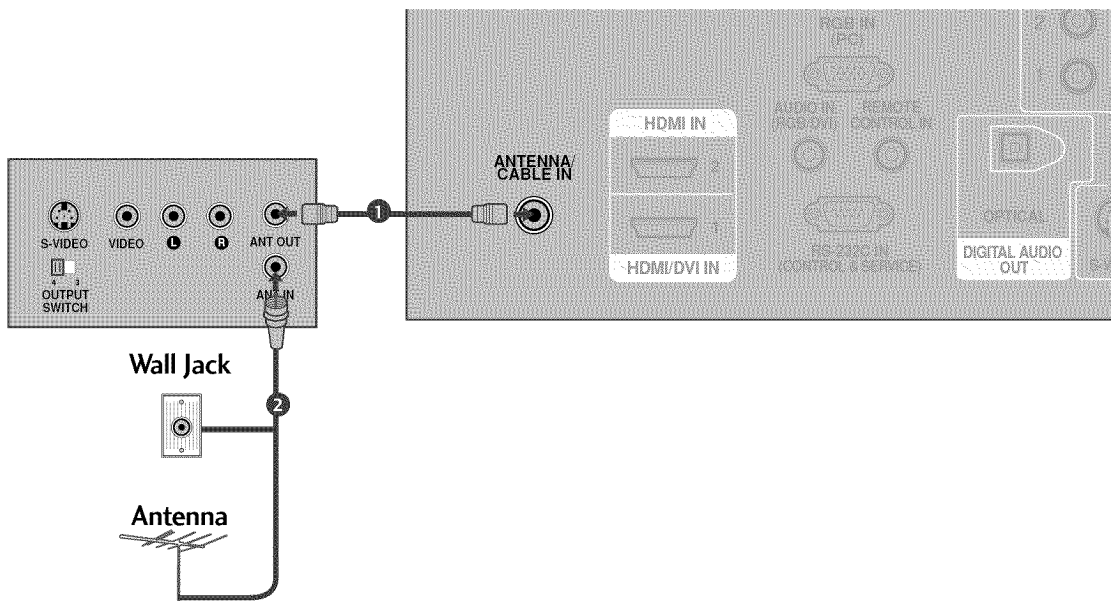

1. How to connect

- 1 Connect the RF antenna out socket of the VCR to the **ANTENNA/CABLE IN** socket on the set.
- 2 Connect the antenna cable to the RF antenna in socket of the VCR.

2. How to use

- Set VCR output switch to 3 or 4 and then tune TV to the same channel number.
- Insert a video tape into the VCR and press PLAY on the VCR. (Refer to the VCR owner's manual.)

EXTERNAL EQUIPMENT SETUP

When connecting with a RCA cable

1. How to connect

- 1 Connect the **AUDIO/VIDEO** jacks between TV and VCR. Match the jack colors (Video = yellow, Audio Left = white, and Audio Right = red)

2. How to use

- Insert a video tape into the VCR and press **PLAY** on the VCR. (Refer to the VCR owner's manual.)
- Select **AV1** input source by using the **INPUT** button on the remote control.
- If connected to **AV IN2**, select **AV2** input source.

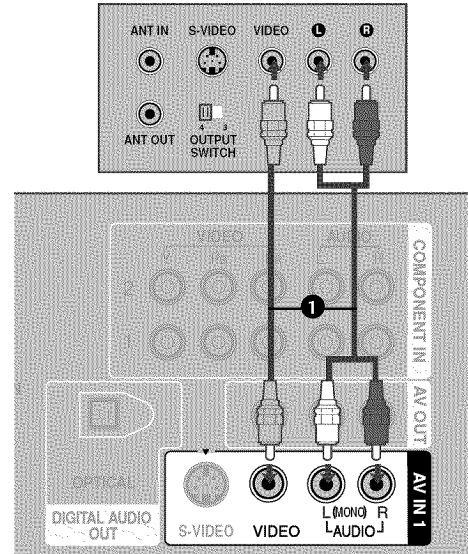

NOTE

- ▶ If you have a mono VCR, connect the audio cable from the VCR to the **AUDIO L/MONO** jack of the set.

When connecting with an S-Video cable

1. How to connect

- 1 Connect the **S-VIDEO** output of the VCR to the **S-VIDEO** input on the set.
- 2 Connect the audio outputs of the VCR to the **AUDIO** input jacks on the set.

2. How to use

- Insert a video tape into the VCR and press **PLAY** on the VCR. (Refer to the VCR owner's manual.)
- Select **AV1** input source by using the **INPUT** button on the remote control.
- If connected to **AV IN2**, select **AV2** input source.

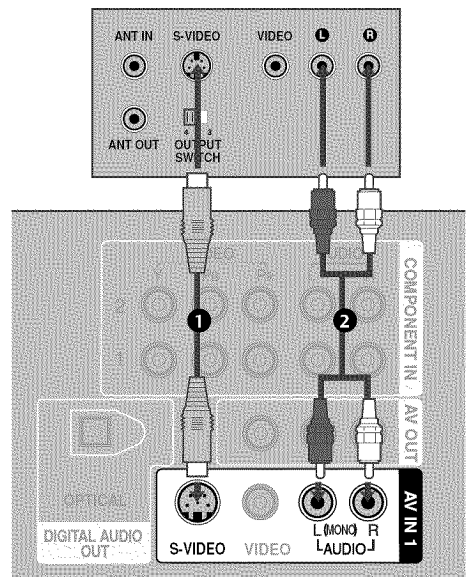

CAUTION

- ▶ Do not connect to both Video and S-Video at the same time. In the event that you connect both Video and the S-Video cables, only the S-Video will work.

NOTE

- ▶ The picture quality is improved: compared to normal composite (RCA cable) input.

OTHER A/V SOURCE SETUP

1. How to connect

- 1 Connect the **AUDIO/VIDEO** jacks between TV and external equipment. Match the jack colors. (Video = yellow, Audio Left = white, and Audio Right = red)

2. How to use

- Select **AV2** input source by using the **INPUT** button on the remote control.
- If connected to **AV IN1** input, select **AV1** input source.
- Operate the corresponding external equipment.

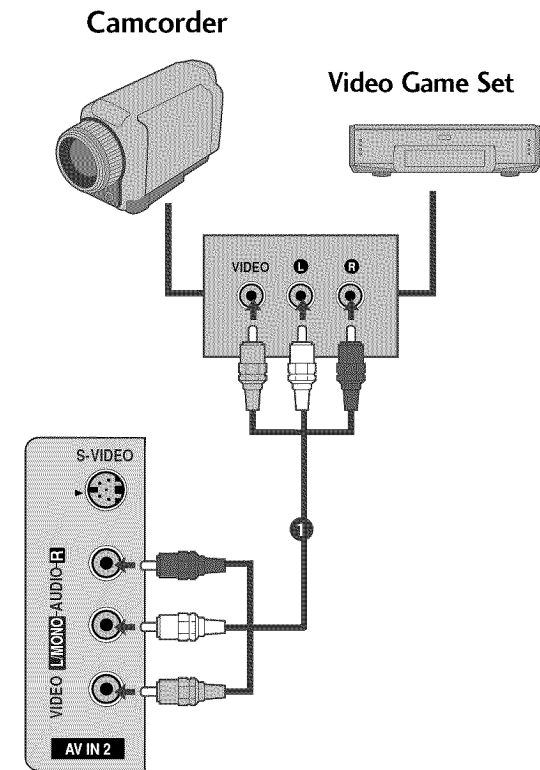

ex) LCD TV Model

EXTERNAL EQUIPMENT SETUP

PC SETUP

This TV provides Plug and Play capability, meaning that the PC adjusts automatically to the TV's settings.

When connecting D-sub 15pin cable

1. How to connect

- 1 Connect the RGB output of the PC to the **RGB IN (PC)** jack on the set.
- 2 Connect the PC audio output to the **AUDIO IN (RGB/DVI)** jack on the set.

2. How to use

- Turn on the PC and the TV.
- Select **RGB-PC** input source by using the **INPUT** button on the remote control.

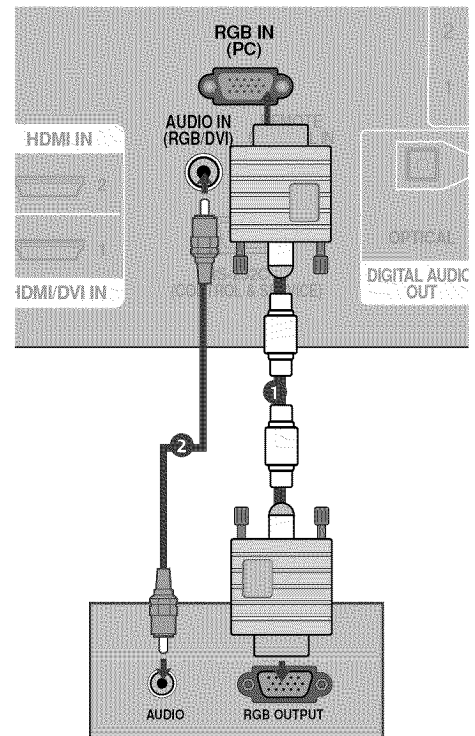

When connecting HDMI to DVI cable

1. How to connect

- 1 Connect the DVI output of the PC to the **HDMI/DVI IN 1** jack on the set.
- 2 Connect the PC audio output to the **AUDIO IN (RGB/DVI)** jack on the set.

2. How to use

- Turn on the PC and the TV.
- Select **HDMI1/DVI** input source by using the **INPUT** button on the remote control.

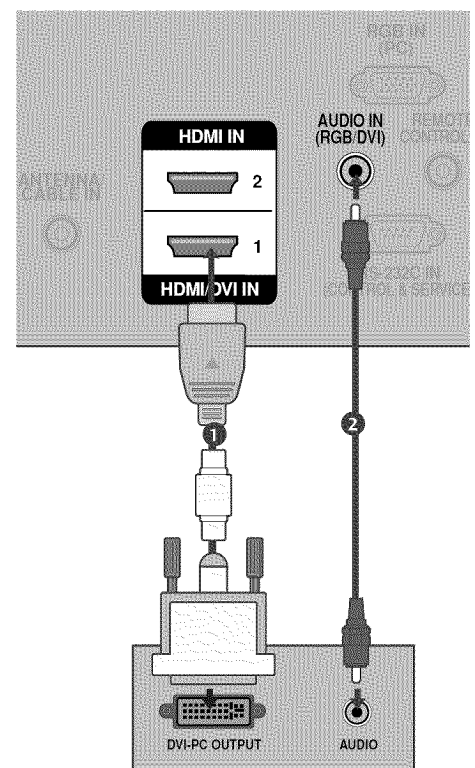

! NOTES

- ▶ To get the the best picture quality, adjust the PC graphics card to 1360x768 (42PC5D/5DC models: 1024x768).
- ▶ Depending on the graphics card, DOS mode may not work if a HDMI to DVI Cable is in use.
- ▶ If the video doesn't fit the screen, try pressing the ADJUST button to adjust the screen position of TV.
- ▶ Check the image on your TV. There may be noise associated with the resolution, vertical pattern, contrast or brightness in PC mode. If noise is present, change the PC output to another resolution, change the refresh rate to another rate or adjust the brightness and contrast on the VIDEO menu until the picture is clear. If the refresh rate of the PC graphic card can not be changed, change the PC graphic card or consult the manufacturer of the PC graphic card.
- ▶ Avoid keeping a fixed image on the screen for a long period of time. The fixed image may become permanently imprinted on the screen.
- ▶ The synchronization input form for Horizontal and Vertical frequencies is separate.

Supported Display Specifications

RGB-PC, HDMI1/DVI-PC mode

Resolution	Horizontal Frequency(KHz)	Vertical Frequency(Hz)
640x350	31.469	70.08
720x400	31.469	70.08
640x480	31.469	59.94
800x600	37.879	60.31
1024x768	48.363	60.00
1280x768	47.776	59.87
1360x768	47.720	59.799
1366x768	47.130	59.65

* RGB-PC mode only: 640x350, 720X400

EXTERNAL EQUIPMENT SETUP

Screen Setup for PC mode

Overview

When the RGB input of the set is connected to a PC output, select the RGB-PC as the main input mode.

When HDMI/DVI connect to PC output and select HDMI/DVI input, this function is used.

After connecting RGB-PC or HDMI/DVI to PC input and checking the screen quality.

When you change the resolution, select the proper resolution in present input to see the best picture appearance.

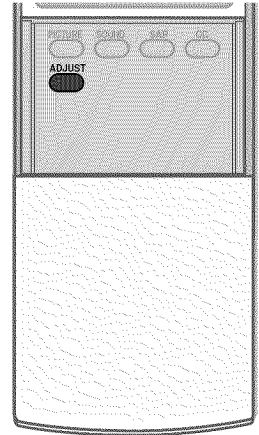

Adjustment for screen Resolution, Position, Size, and Phase

- 1 Press the **ADJUST** button and then use **▲** or **▼** button to select **Resolution**, **Position**, **Size**, or **Phase**.
- 2 Press the **ENTER** button and then use **▲ ▼ ◀ ▶** button to make appropriate adjustments.
 - The **Phase** adjustment range is **-16 ~ +16**.
In HDMI/DVI-PC mode, **Phase** is not available.
 - The **Size** adjustment range is **-30 ~ +30**.
In HDMI/DVI-PC mode, **Size** is not available.

- 3 Press the **ENTER** button.

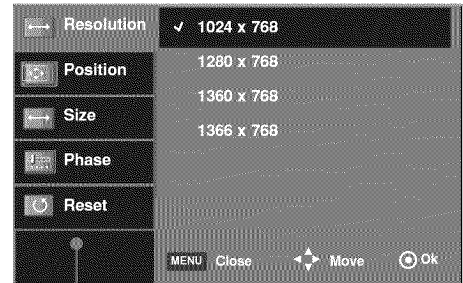

1 2 3

Resolution This function allows you select resolution of XGA/WXGA.

Position This function is to adjust picture to left/right and up/down as you prefer.

Size This function is to minimize any vertical bars or stripes visible on the screen background. And the horizontal screen size will also change.

Phase This function allows you to remove any horizontal noise and clear or sharpen the image of characters.

Initializing (Reset to original factory values)

To initialize the adjusted values

- 1 Press the **ADJUST** button and then use **▲** or **▼** button to select **Reset**.
- 2 Press the **ENTER** button and then use **◀** or **▶** button to select **Yes**.
- 3 Press the **ENTER** button.

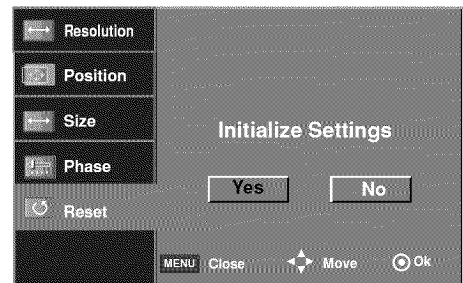

1 2 3

AV OUT SETUP

The TV has a special signal output capability which allows you to hook up the second TV or monitor.

1. How to connect

- 1 Connect the second TV or monitor to the TV's AV OUT jacks.
- 2 See the Operating Manual of the second TV or monitor for further details regarding that device's input settings.

NOTE

- ▶ Component1-2, RGB-PC, HDMI1/DVI, HDMI2, DTV input sources cannot be used for AV out.

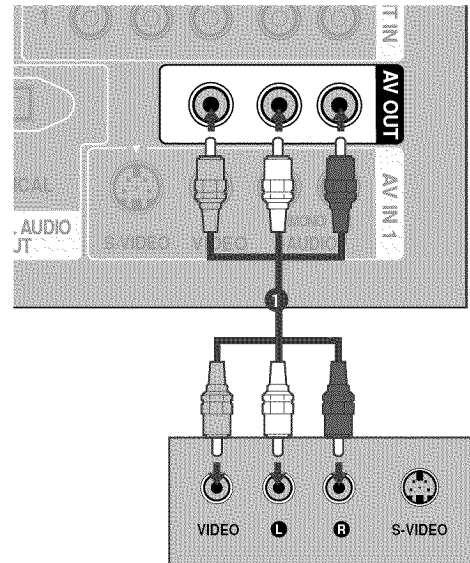

DIGITAL AUDIO OUTPUT

Send the TV's audio to external audio equipment via the Digital Audio Output (Optical) port.

1. How to connect

- 1 Connect one end of an optical cable to the TV Digital Audio (Optical) Output port.
- 2 Connect the other end of the optical cable to the digital audio (optical) input on the audio equipment.
- 3 Set the "TV Speaker option - Off" in the AUDIO menu. (▶ p.57). See the external audio equipment instruction manual for operation.

NOTE

- ▶ When connecting with external audio equipments, such as amplifiers or speakers, please turn the TV speakers off. (▶ p.57)

CAUTION

- ▶ Do not look into the optical output port. Looking at the laser beam may damage your vision.

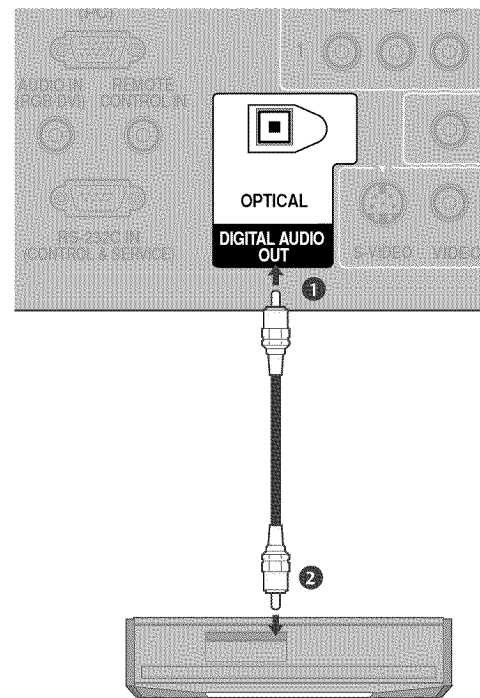

WATCHING TV / CHANNEL CONTROL

REMOTE CONTROL FUNCTIONS

When using the remote control, aim it at the remote control sensor on the TV.

WATCHING TV / CHANNEL CONTROL

- MODE** Select the remote's operating mode. TV, DVD, VCR, AUDIO, CABLE, or STB.
- VCR/DVD control buttons** Control video cassette recorders or DVD players.
- MENU** Displays the main menu.
- BRIGHT -/ +** Adjust the brightness on screen.
- THUMBSTICK (Up/Down/Left Right/ENTER)** Navigate the on-screen menus and adjust the system settings to your preference.
 - EXIT** Clear all on-screen displays and return to TV viewing from any menu.
 - TIMER** Select the amount of time before your TV turns off automatically. ▶ p.67
 - RATIO** Change the aspect ratio. ▶ p.42
 - SIMPLINK** See a list of AV devices connected to TV. When you toggle this button, the SimpLink menu appears at the screen. ▶ p.40
- VOLUME UP /DOWN** Increase/decrease the sound level.
 - MUTE** Switch the sound on or off. ▶ p.32
 - FAV** Scroll through the programmed Favorite channels. ▶ p.36
- CHANNEL UP/DOWN** Select available channels.
- NUMBER button**
 - (DASH)** Used to enter a program number for multiple program channels such as 2-1, 2-2, etc.
 - BACK** Tune to the last channel viewed.

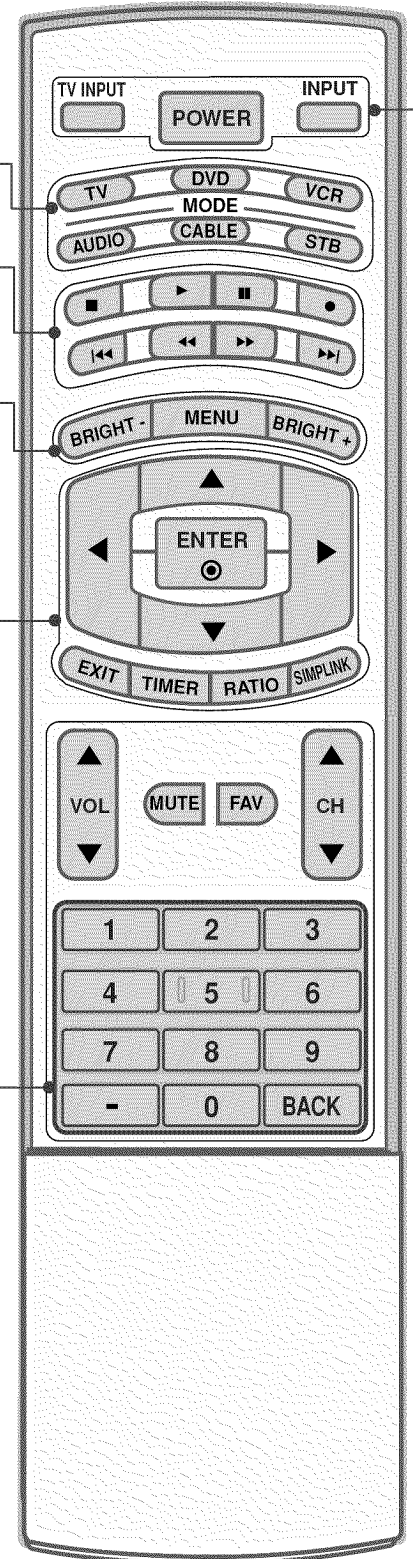

POWER Turns your TV or any other programmed equipment on or off, depending on the mode.

TV INPUT In AV 1-2, Component 1-2, RGB-PC, HDMI1/DVI, and HDMI2 input sources, screen returns to the last TV channel.

INPUT External input modes rotate in regular sequence: TV, AV1-2, Component 1-2, RGB-PC, HDMI1/DVI and HDMI2.

(AV 1-2, Component 1-2, RGB-PC, HDMI1/DVI, and HDMI2 input sources are linked automatically, only if a device is connected.)

Inside the Sliding Cover



PICTURE Selects the factory preset picture depend on the viewing environment. ▶ p.44

SOUND Selects the factory preset sound for type of program. ▶ p.54

SAP ◦Analog mode: Selects MTS sound (Mono, Stereo, or a SAP) ▶ p.58
◦DTV mode: Changes the audio language.

CC Select a closed caption. ▶ p.61
(*In DTV/CADTV mode ▶ p.62)

ADJUST Adjust the screen resolution, position, size and phase. ▶ p.28

Installing Batteries

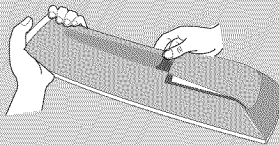

- Open the battery compartment cover on the back side and install the batteries matching correct polarity (+ with +, - with -).
- Install two 1.5V AA batteries. Don't mix old or used batteries with new ones.
- Close cover.

Remote control effective range

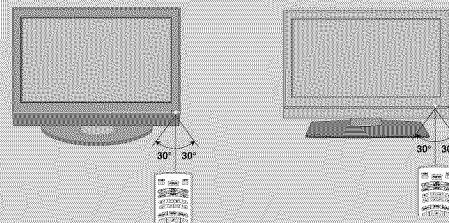

- Use a remote control up to 7 meters distance and 30 degree (left/right) within the receiving unit scope.
- Dispose of used batteries in a recycle bin to preserve environment.

WATCHING TV / CHANNEL CONTROL

TURNING ON TV

- 1 First, connect power cord correctly.
At this moment, the TV switches to standby mode.
 - In standby mode to turn TV on, press the ϕ/I , INPUT, CH (\blacktriangle or \blacktriangledown) button on the TV or press the POWER, INPUT, TV INPUT, CH (\blacktriangle or \blacktriangledown), Number (0~9) button on the remote control.
- 2 Select the viewing source by using the TV INPUT, INPUT button on the remote control.
 - This TV is programmed to remember which power state it was last set to, even if the power cord is out.
- 3 When finished using the TV, press the POWER button on the remote control. The TV reverts to standby mode.

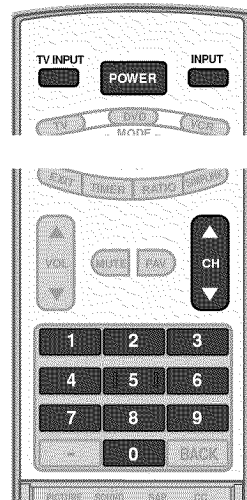

! NOTE

- ▶ If you intend to be away on vacation, disconnect the power plug from the wall power outlet.

CHANNEL SELECTION

- 1 Press the CH (\blacktriangle or \blacktriangledown) or NUMBER buttons to select a channel number.

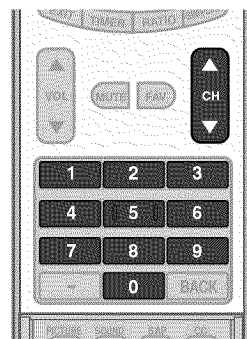

VOLUME ADJUSTMENT

Adjust the volume to suit your personal preference.

- 1 Press the VOL (\blacktriangle or \blacktriangledown) button to adjust the volume.
- 2 If you want to switch the sound off, press the MUTE button.
- 3 You can cancel the Mute function by pressing the MUTE or VOL (\blacktriangle or \blacktriangledown) button.

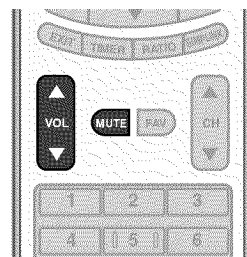

ON-SCREEN MENUS SELECTION

Your TV's OSD (On Screen Display) may differ slightly from what is shown in this manual.

- 1 Press the **MENU** button and then use **▲** or **▼** button to select the each menu.
- 2 Press the **▶** button and then use **▲ ▼ ◀ ▶** button to display the available menus.

SETUP

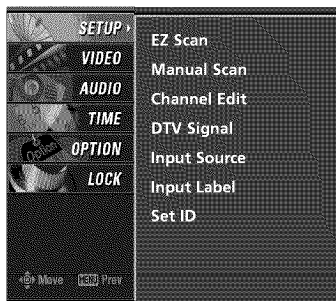

VIDEO



LOCK

For USA

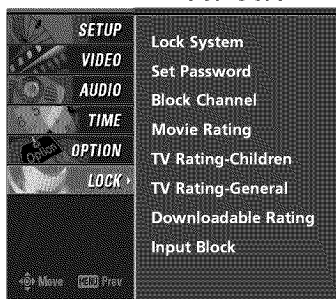

For Canada

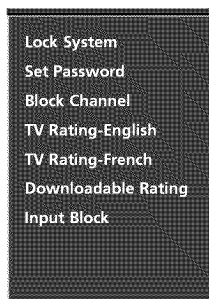

AUDIO



OPTION

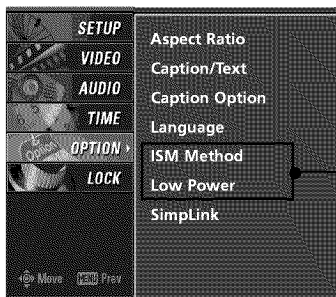

Plasma TV model only



TIME

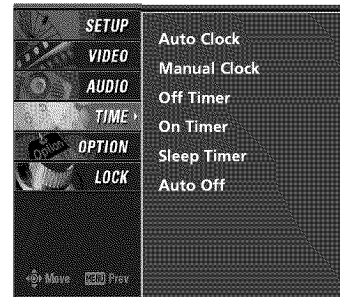

WATCHING TV / CHANNEL CONTROL

CHANNEL SEARCH

Auto Scan (EZ Scan)

Automatically finds all channels available through antenna or cable inputs, and stores them in memory on the channel list.

Run EZ Scan again after any Antenna/Cable connection changes.

A password is required to gain access to EZ Scan menu if the Lock System is turned on.

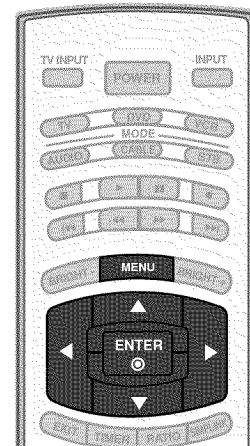

1 Press the **MENU** button and then use **▲** or **▼** button to select the **SETUP** menu.

2 Press the **▶** button and then use **▲** or **▼** button to select **EZ Scan**.

3 Press the **ENTER** button to begin the channel search. Allow **EZ Scan** to complete the channel search cycle for **ANTENNA** and **CABLE**.

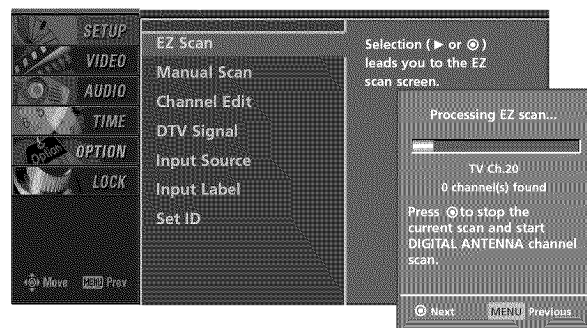
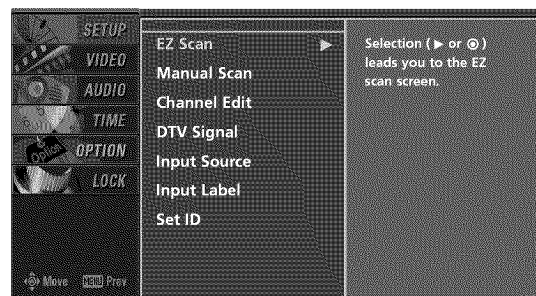
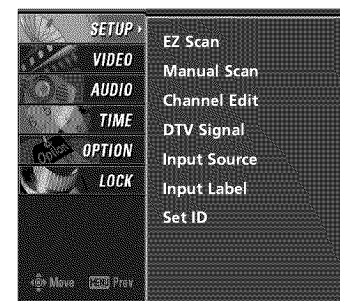

Add/Delete Channel (Manual Scan)

A password is required to gain access to Manual Scan menu if the Lock System is turned on.

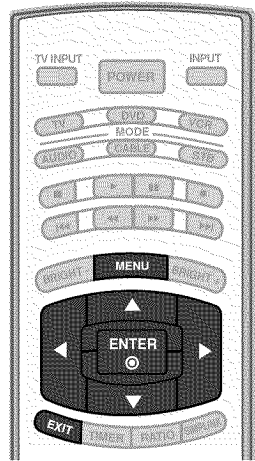

1 Press the **MENU** button and then use ▲ or ▼ button to select the **SETUP** menu.

2 Press the ► button and then use ▲ or ▼ button to select **Manual Scan**.

3 Press the ► button and then use ▲ or ▼ button to select **TV, DTV, CATV, and CADTV**.

4 Press the ► button and then use ▲ or ▼ button to select channel you want to add or delete.

5 Press the **ENTER** button to add or delete the channel.

6 Press the **EXIT** button to return to TV viewing or press **MENU** button to return to the previous menu.

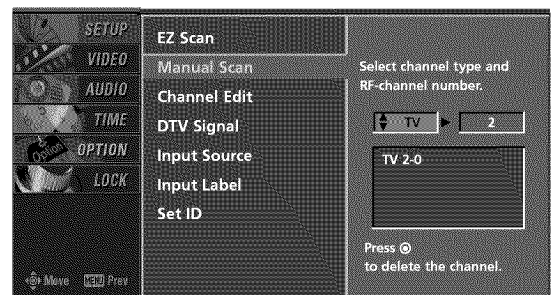
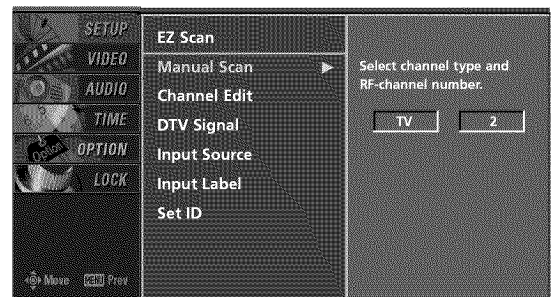
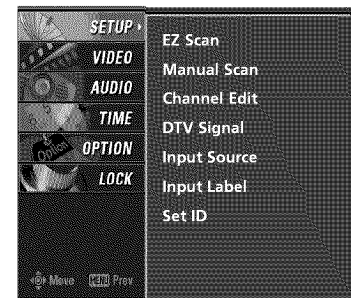

3 4 5

WATCHING TV / CHANNEL CONTROL

Channel Editing

There are two different ways in order to add or delete scanned channels. One is "Custom List" and the other is "Favorite List" in the channel list. Both of them are available after EZ Scan on the SETUP menu.

A Custom List can be created by toggling each channel on or off with ENTER button. The channels in the Custom List are displayed in black, and the channels deleted from the Custom List are displayed in gray. Once a channel is highlighted you can add or delete the channel by referring to the small window at the top-left corner of the screen.

You can create your own Favorite List. Use the FAV button on the remote control when a channel is highlighted and then add or delete the channel to/from your Favorite List.

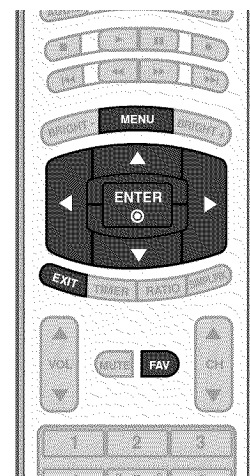

1 Press the **MENU** button and then use **▲** or **▼** button to select the **SETUP** menu.

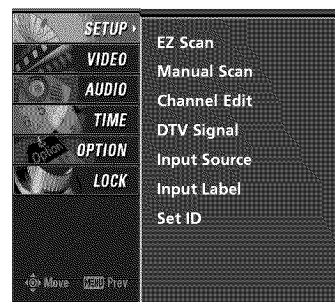

1

2 Press the **▶** button and then use **▲** or **▼** button to select **Channel Edit**.

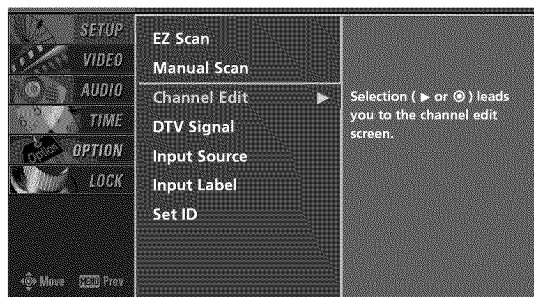

2

3 Press the **▶** button. You will now see a screen filled with channel numbers and a preview picture.

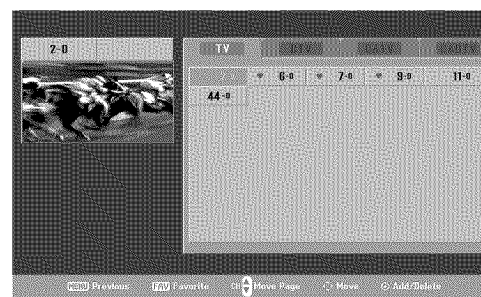

3 4

4 Use **▲ ▼ ◀ ▶** button to select a channel and then use the **ENTER** button to add or delete it. Press **FAV** button to add the channel to the Favorite List. The heart-mark will appear in front of that channel number.

5 Press **EXIT** button to return to TV viewing or press **MENU** button to return to the previous menu.

DTV SIGNAL STRENGTH

This feature displays the DTV signal levels being received and indicates whether you need to adjust your antenna or digital cable input. The higher the signal strength, the less likely you are to experience picture degradation.

DTV Signal: This function is only available when the input signal is DTV or CADTV.

- 1 Press the **MENU** button and then use **▲** or **▼** button to select the **SETUP** menu.
- 2 Press the **▶** button and then use **▲** or **▼** button to select **DTV Signal**.
- 3 View the on-screen signal strength monitor to see the quality of the signal being received.
- 4 Press **EXIT** button to return to TV viewing or press **MENU** button to return to the previous menu.

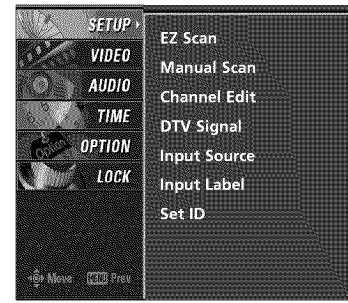
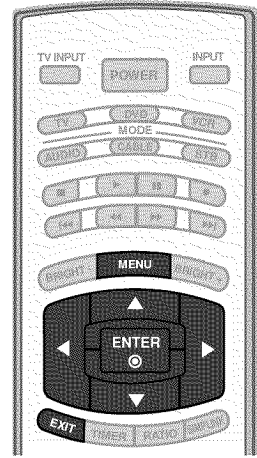

1

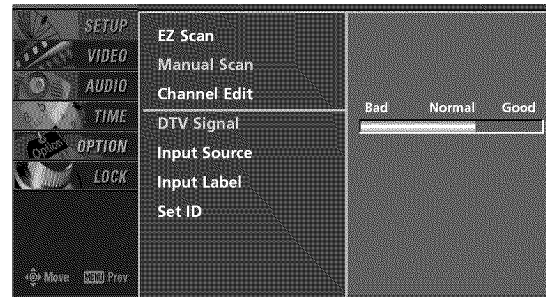

2 3

WATCHING TV / CHANNEL CONTROL

INPUT SOURCE SELECTION

Changes the picture source so you can watch your off-air TV, cable TV, VCR, DVD, or any other devices that are connected to your TV.

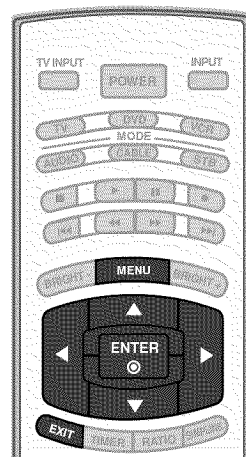

1 Press the **MENU** button and then use ▲ or ▼ button to select the **SETUP** menu.

2 Press the ► button and then use ▲ or ▼ button to select **Input Source**.

3 Press the ► button and then use ▲ or ▼ button to select the source: **TV**, **AV1**, **AV2**, **Component1**, **Component2**, **RGB-PC**, **HDMI1/DVI**, or **HDMI2**.

4 Press **EXIT** button to return to TV viewing or press **MENU** button to return to the previous menu.

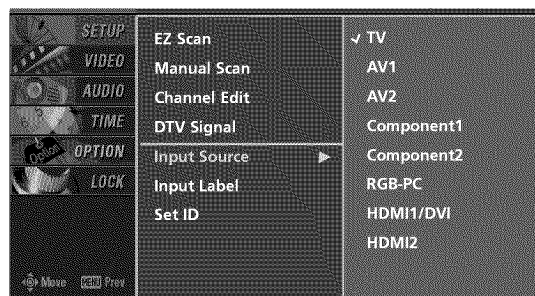

3

INPUT LABEL

Sets a label to each input source which is not in use when you press the INPUT button.

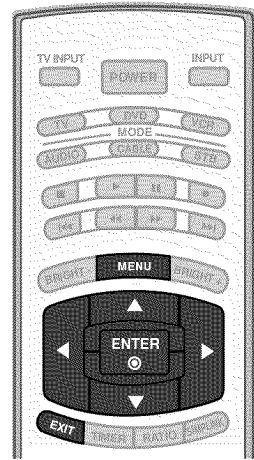

1 Press the **MENU** button and then use ▲ or ▼ button to select the **SETUP** menu.

2 Press the ► button and then use ▲ or ▼ button to select **Input Label**.

3 Press the ► button and then use ▲ or ▼ button to select the source: **AV1**, **AV2**, **Component1**, **Component2**, **RGB-PC**, **HDMI1/DVI** or **HDMI2**.

4 Press the ◀ or ▶ button to select the label.

5 Press **EXIT** button to return to TV viewing or press **MENU** button to return to the previous menu.

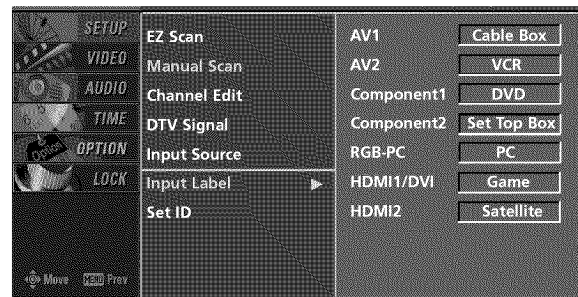
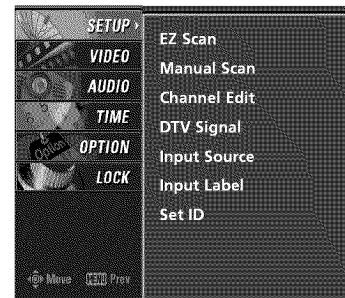

3 4

WATCHING TV / CHANNEL CONTROL



This operates only for the devices with the Simplink logo. Please check the Simplink logo.

This allows you to control and play other AV devices connected to the display through HDMI cable without additional cables and settings.

If you do not want Simplink menu, select **Off**.

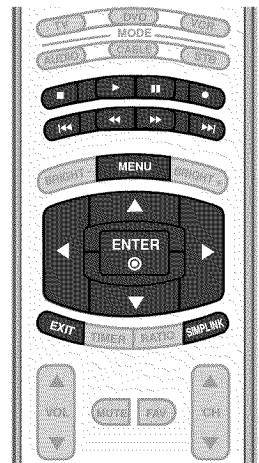

Simplink Preparations

- 1 Connect the HDMI/DVI IN 1 or HDMI IN 2 terminal of the TV to the rear terminal (HDMI output) of the Simplink device with the HDMI cable.
After connecting the HDMI jack for the home theater with simplink function in the above method, connect the DIGITAL AUDIO OUT OPTICAL on the back of the TV to the DIGITAL AUDIO OUT terminal on the back of the simplink device with the Optical cable.

- 2 Press the **MENU** button and then use **▲** or **▼** button to select the **OPTION** menu.

- 3 Press the **▶** button and then use **▲** or **▼** button to select **Simplink**.

- 4 Press the **▶** button and then use **▲** or **▼** button to select **On**.

- 5 Press **EXIT** button to return to TV viewing or press **MENU** button to return to the previous menu.

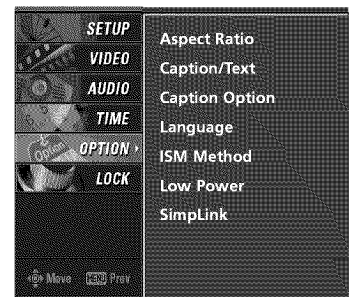

2

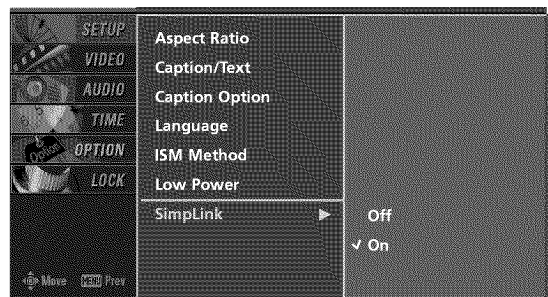











3 4

NOTE

- ▶ When operating the external device with Simplink, press the **TV** button among the **MODE** button on the remote control.
- ▶ When you switch the Input source with the **INPUT** button on the remote control, you can stop the operation of device worked by Simplink.
- ▶ When you select or operate the media device with home theater function, the speaker automatically switches to home theater speaker (HT speaker).

Simplink Functions

- **Direct Play:** After connecting AV devices to TV, you can directly control the devices and play media without additional settings.
- **Select AV device:** Enables you to select one of AV devices connected to TV and play it.
- **Disc playback:** Control connected AV devices by pressing the  ,  ,  ,  ,  ,  ,  ,  ,  ,  buttons and buttons for play, stop, pause, fast reverse, fast forward, chapter skip.
- **Power off all devices:** When you power off TV, all connected devices are turned off. (This option only applied when the devices are stopped.)
- **Switch audio-out:** Offers an easy way to switch audio-out.

(A device, which is connected to TV through HDMI cable but does not support Simplink, does not provide this function)

Note: To operate SIMPLINK, the HDMI cable over 1.2 Version with *CEC function should be used. (*CEC: Consumer Electronics Control).

Simplink Menu



- ① **TV viewing:** Switch to the previous TV channel regardless of the current mode.
- ② **DISC playback:** Select and play discs. When multiple discs are available, the titles of discs are conveniently displayed at the bottom of the screen.
- ③ **VCR playback:** Play and control the connected VCR.
- ④ **HDD Recordings playback:** Play and control recordings stored in HDD.
- ⑤ **Audio Out to HT speaker/Audio Out to TV:** Select HT speaker or TV speaker for Audio Out.

PICTURE CONTROL

PICTURE SIZE (ASPECT RATIO) CONTROL

This feature allows an analog picture with a 4:3 aspect ratio is displayed on your TV. When you receive an analog picture with a 4:3 aspect ratio on your 16:9 TV, you need to specify how the picture is to be displayed.

- RGB-PC/DVI-PC input source use 4:3 or 16:9 aspect ratio.

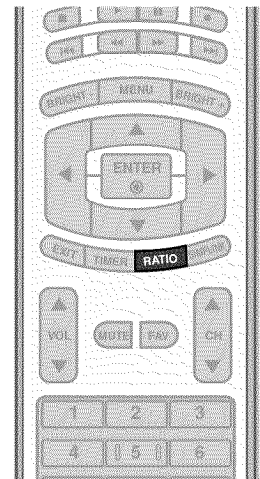

NOTE

- ▶ If a fixed image is displayed on the screen for a long time, the image may become imprinted on the screen and remain visible. This phenomenon is common to all manufactures and in consequence the manufactures warranty does not cover the product bearing this phenomenon.

- 1 Press the **RATIO** button repeatedly to select the desired picture format.

- You can also adjust **Aspect Ratio** in the **OPTION** menu.

Set by program

Selects the proper picture proportion to match the source's image.

(4:3 → 4:3)

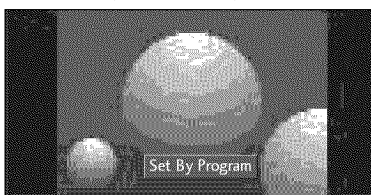

(16:9 → 16:9)

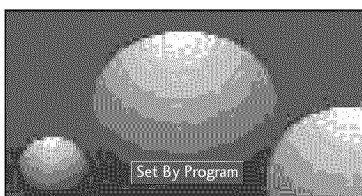

4:3

Choose 4:3 when you want to view a picture with an original 4:3 aspect ratio.

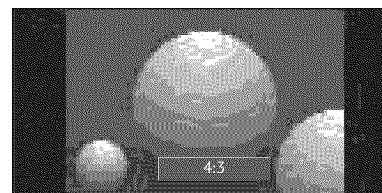

16:9

Adjust the picture horizontally, in a linear proportion to fill the entire screen.

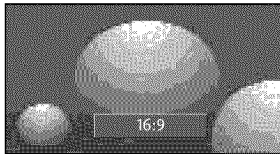

Horizon

The screen size is, more enlarged at both sides, to create a spectacular view.

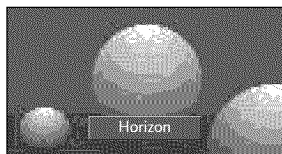

Zoom 1

Choose Zoom 1 when you want to view the picture without any alteration. However, the top and bottom portions of the picture will be cropped.

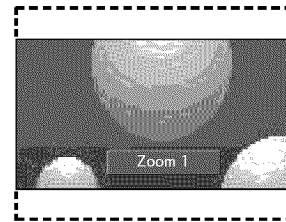

Zoom 2

Choose Zoom 2 when you want the picture to be altered, both vertically extended and cropped. The picture taking a halfway trade off between alteration and screen coverage.

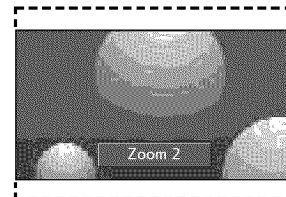

PICTURE CONTROL

PRESET PICTURE SETTINGS

EZ Picture - Preset

EZ Picture adjusts the TV for the best picture appearance. Select the preset value in the EZ Picture menu based on the program category.

Daylight, Normal, Night Time Settings are preset for the optimum picture quality at the factory and are not adjustable.

In the **User1** and **User2** modes only, user can directly adjust the contrast, brightness, color, sharpness, tint.

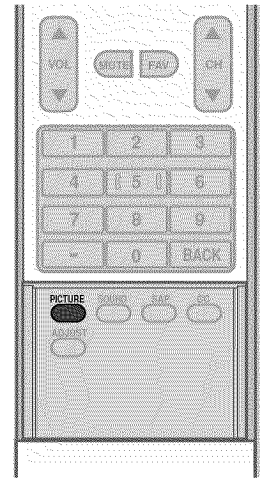

- 1 Press the **PICTURE** button repeatedly to select the picture appearance setup option as below :
Daylight, Normal, Night Time, User1, and User2 (your own settings).

- 2 Press the **EXIT** button to save and return to TV viewing.

■ You can also use the **VIDEO** menu to adjust **EZ Picture**.

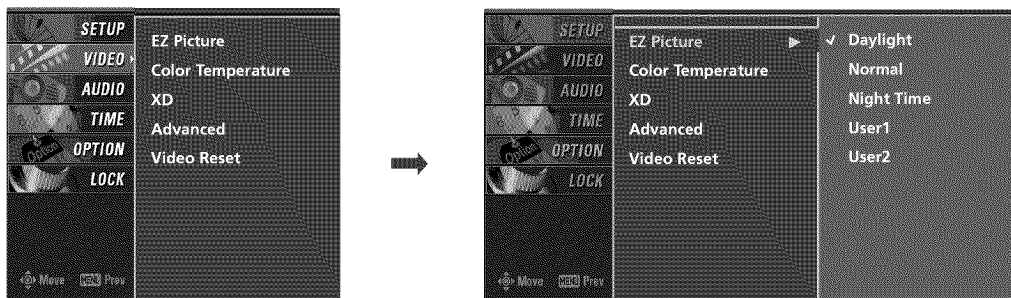

Color Tone - Preset

Choose one of three automatic color adjustments. Set to warm to enhance hotter colors such as red, or set to cool to see less intense colors with more blue.

- 1 Press the **MENU** button and then use ▲ or ▼ button to select the **VIDEO** menu.
- 2 Press the ► button and then use ▲ or ▼ button to select **Color Temperature**.
- 3 Press the ► button and then use ▲ or ▼ button to select either **Cool**, **Medium**, **Warm** or **User**.
- 4 Press **EXIT** button to return to TV viewing or press **MENU** button to return to the previous menu.

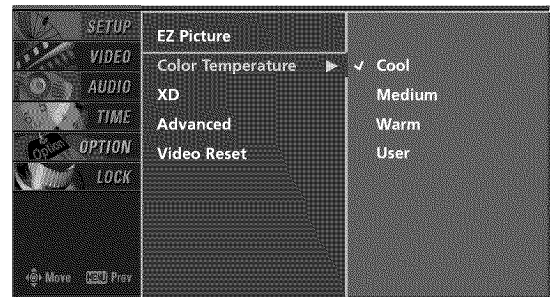
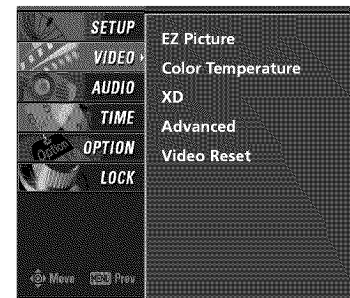
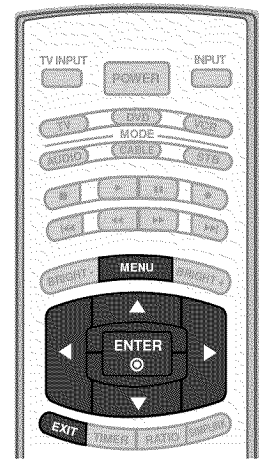

3

PICTURE CONTROL

MANUAL PICTURE ADJUSTMENT

EZ Picture - User Mode

Adjust the picture appearance to suit your preference and viewing situations.

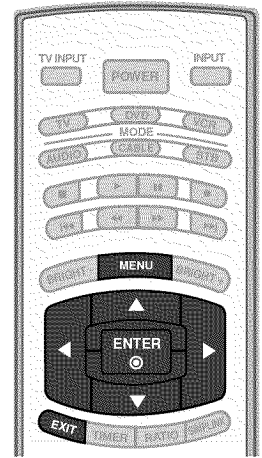

1 Press the **MENU** button and then use **▲** or **▼** button to select the **VIDEO** menu.

2 Press the **▶** button and then use **▲** or **▼** button to select **EZ Picture**.

3 Press the **▶** button and then use **▲** or **▼** button to select **User 1** or **User 2**.

4 Press the **▶** button and then use **▲** or **▼** button to select the desired picture option (**Contrast**, **Brightness**, **Color**, **Sharpness**, **Tint**, or **Back Light**).

■ **Back Light**-This is the function for some LCD TV models. To control the brightness of the screen, adjust the brightness of LCD panel.

5 Press the **▶** button and then use **◀** or **▶** button to make appropriate adjustments.

6 Press **EXIT** button to return to TV viewing or press **MENU** button to return to the previous menu.

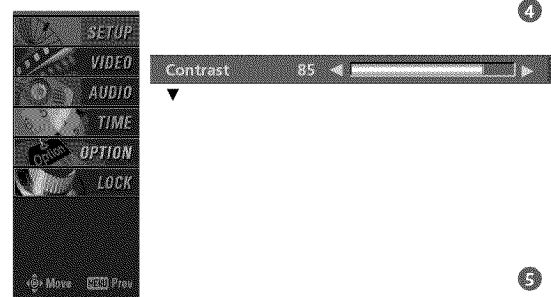
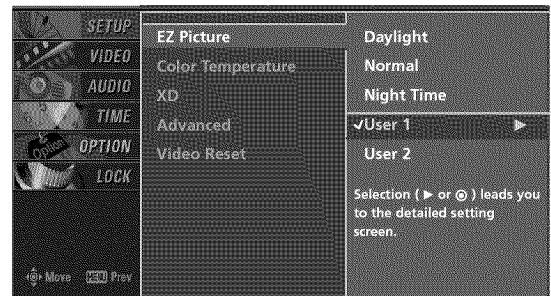
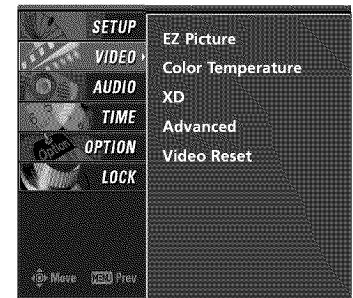

Color Tone - User Mode

You can also adjust the detailed settings (Red, Green, Blue) by selecting the **Color Temperature-User** menu.

1 Press the **MENU** button and then use **▲** or **▼** button to select the **VIDEO** menu.

2 Press the **▶** button and then use **▲** or **▼** button to select **Color Temperature**.

3 Press the **▶** button and then use **▲** or **▼** button to select **User**.

4 Press the **▶** button and then use **▲** or **▼** button to select **Red, Green, or Blue**.

5 Press the **▶** button and then use **◀** or **▶** button to make appropriate adjustments.

- The adjustment range of **Red, Green, or Blue** is -20~ +20.

6 Press **EXIT** button to return to TV viewing or press **MENU** button to return to the previous menu.

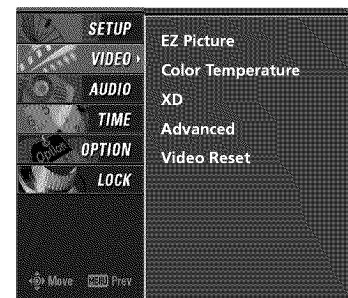
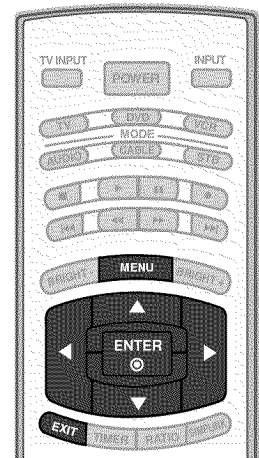

1

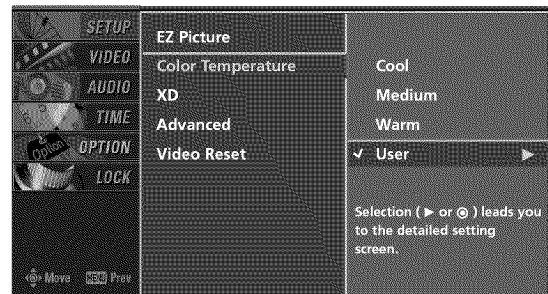

2 3

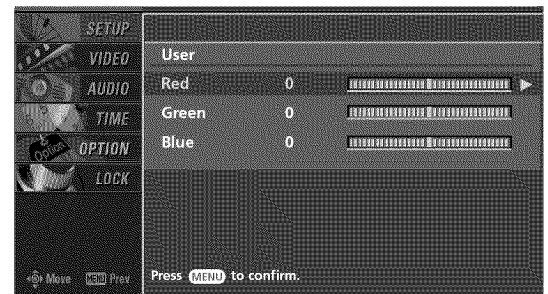

4

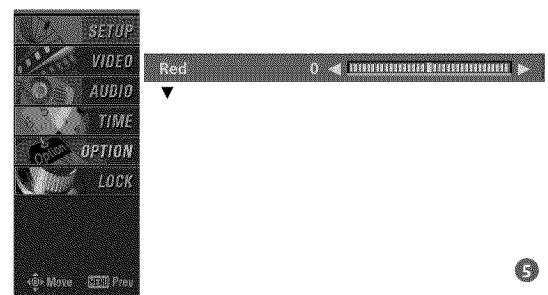

5

PICTURE CONTROL

XD - PICTURE IMPROVEMENT TECHNOLOGY

XD is LG Electronic's unique picture improving technology to display a real HD source through an advanced digital signal processing algorithm.

When selecting EZ Picture options (Daylight, Normal and Night time), XD is automatically changed to Auto.

When selecting EZ Picture options (User 1 and User 2), you can choose the Auto / Manual.

When selecting the Manual, you can adjust the XD Contrast, XD color and XD Noise.

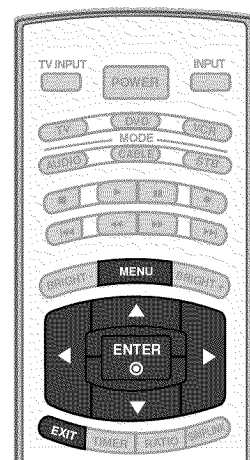

1 Press the **MENU** button and then use **▲** or **▼** button to select the **VIDEO** menu.

2 Press the **▶** button and then use **▲** or **▼** button to select **XD**.

3 Press the **▶** button and then use **▲** or **▼** button to select **Auto** or **Manual**.

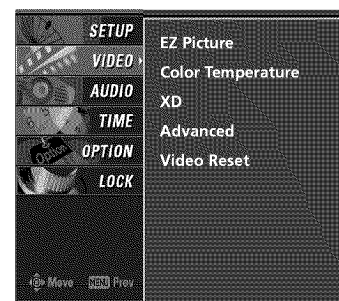

Selecting the Manual

1. Press the **▶** button and then use **◀** or **▶** button to select **XD Contrast**, **XD Color** or **XD Noise**.

- **XD Contrast:** Optimizing the contrast automatically according to the brightness of the reflection.
- **XD Color:** Adjusting the colors of the reflection automatically to reproduce as closely as possible to the natural colors.
- **XD Noise :** Removing the noise up to the point where it does not damage the original picture.

2. Use the **▲** or **▼** button to select **On** or **Off**.

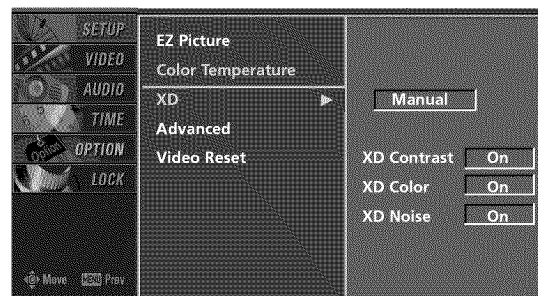

4 Press **EXIT** button to return to TV viewing or press **MENU** button to return to the previous menu.

ADVANCED - CINEMA 3:2 PULL DOWN MODE

Set up the TV for the best picture appearance for viewing movies.

When you operate Cinema 3:2 Mode (3:2 Pull-Down Mode or Cinema Correction Mode), the TV will adjust 24 fps video from movies to 30 fps video for display.

This feature operates only in Analog, AV1, AV2, and Component 480i mode.

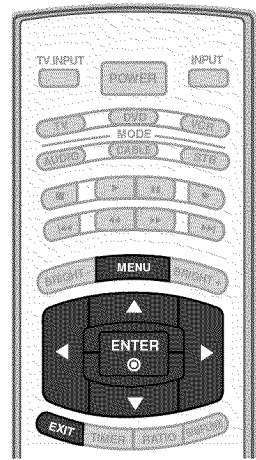

1 Press the **MENU** button and then use **▲** or **▼** button to select the **VIDEO** menu.

2 Press the **▶** button and then use **▲** or **▼** button to select **Advanced**.

3 Press the **▶** button and then use **▲** or **▼** button to select **Cinema 3:2 Mode**.

4 Press the **▶** button and then use **▲** or **▼** button to select **On** or **Off**.

5 Press **EXIT** button to return to TV viewing or press **MENU** button to return to the previous menu.

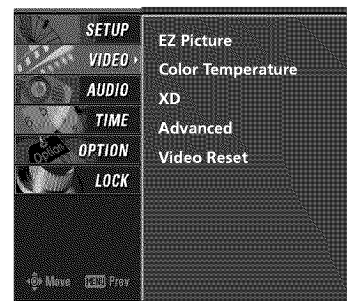

1

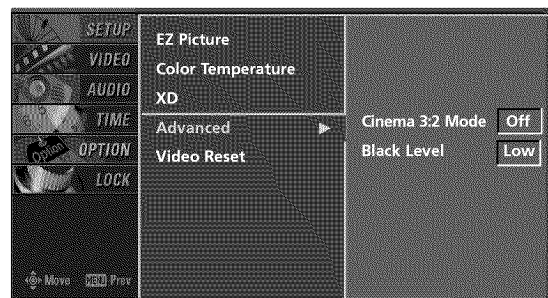

2 3 4

PICTURE CONTROL

ADVANCED - BLACK (DARKNESS) LEVEL

Adjusting the contrast and the brightness of the screen using the black level of the screen.

This feature operates only in AV1, AV2, HDMI1/DVI, or HDMI2 mode.

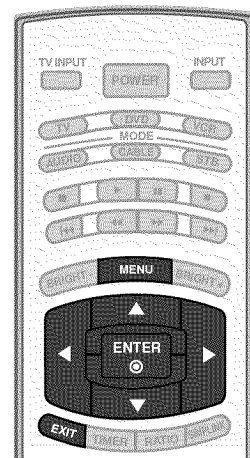

1 Press the **MENU** button and then use ▲ or ▼ button to select the **VIDEO** menu.

2 Press the ► button and then use ▲ or ▼ button to select **Advanced**.

3 Press the ► button and then use ▲ or ▼ button to select **Black level**.

4 Press the ► button and then use ▲ or ▼ button to select **Low** or **High**.

■ **Low**

The screen gets darker.

■ **High**

The screen gets brighter.

5 Press **EXIT** button to return to TV viewing or press **MENU** button to return to the previous menu.



1

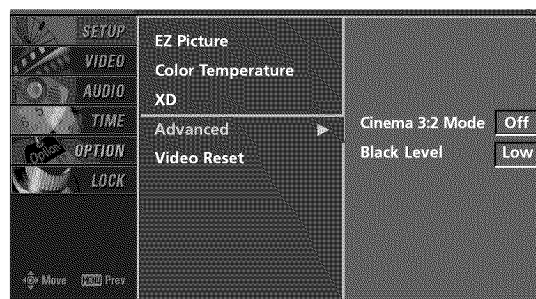

2 3 4

PICTURE RESET

Use to quickly reset all the Video menu options to their original factory preset values.

- 1 Press the **MENU** button and then use **▲** or **▼** button to select the **VIDEO** menu.
- 2 Press the **▶** button and then use **▲** or **▼** button to select **Video Reset**.
- 3 Press the **▶** button to reset the Video menu options to original values.

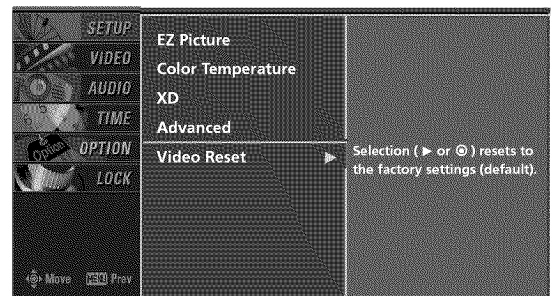
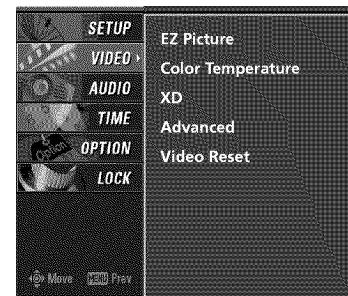
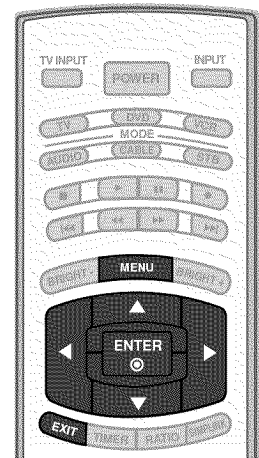

PICTURE CONTROL

IMAGE STICKING MINIMIZATION (ISM) METHOD - Plasma TV only

A frozen still picture from a PC/video game displayed on the screen for prolonged periods will result in a ghost image. Use our unique method to minimize any fixed image on the screen.

- 1 Press the **MENU** button and then use **▲** or **▼** button to select the **OPTION** menu.
- 2 Press the **▶** button and then use **▲** or **▼** button to select **ISM Method**.
- 3 Press the **▶** button and then use **▲** or **▼** button to select either **Normal**, **White Wash**, **Orbiter** or **Inversion**.

■ Normal

If image sticking is never a problem, ISM is not necessary - set to Normal.

■ White Wash

White Wash removes ghost images from the screen.

Use sparingly. Watch the TV normally for a while before using this feature to see if the ghost image disappears on its own.

! NOTE

- ▶ An excessive ghosted image may be impossible to clear entirely with White Wash. To return to normal viewing, press the any button.

■ Orbiter

Orbiter may help prevent ghost images. However, it is best not to allow any fixed image to remain on the screen. To avoid a ghost image on the screen, the image will move once per 2 minutes : Left → Right → Upside → Downside → Right → Left → Downside → Upside.

■ Inversion

Inversion will automatically invert the plasma display panel color every 30 minutes.

- 4 Press **EXIT** button to return to TV viewing or press **MENU** button to return to the previous menu.

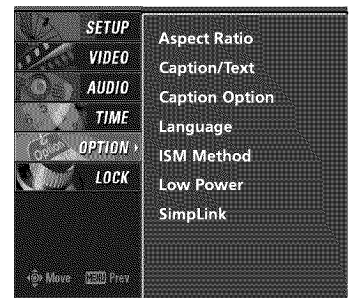
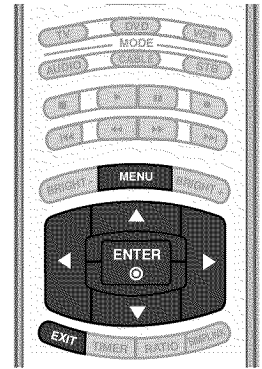

1

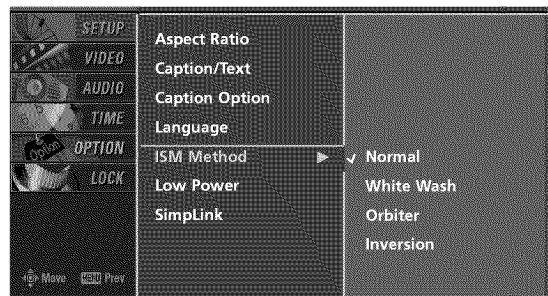

2 3

LOW - POWER PICTURE MODE - Plasma TV only

Low power reduces the plasma display power consumption.

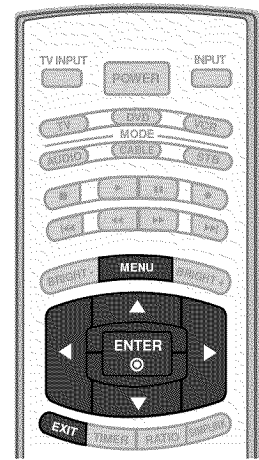

1 Press the **MENU** button and then use ▲ or ▼ button to select the **OPTION** menu.

2 Press the ► button and then use ▲ or ▼ button to select **Low Power**.

3 Press the ► button and then use ▲ or ▼ button to select **On** or **Off**.

■ When you select **On**, the screen darkens.

4 Press **EXIT** button to return to TV viewing or press **MENU** button to return to the previous menu.

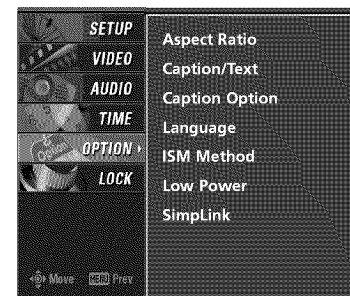

1

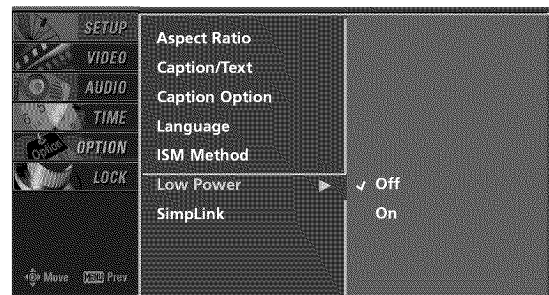

2 3

SOUND & LANGUAGE CONTROL

PRESET SOUND SETTINGS (EZ SOUND)

EZ Sound lets you enjoy the best sound without any special adjustment because the TV sets the appropriate sound options based on the program content.

Normal, Stadium, News, Music and Theater are preset for good sound quality at the factory and are not adjustable.

When you select the Stadium or Theater, the AUDIO menu-Balance option is disabled and the Balance option is set to 0 automatically.

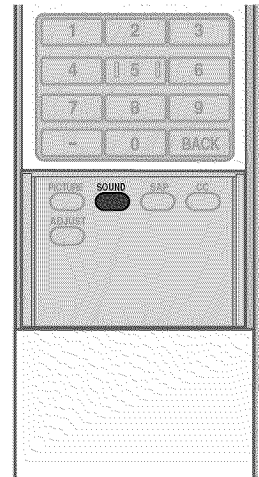

- 1 Press the **SOUND** button repeatedly to select the appropriate sound setup as below :
Normal, Stadium, News, Music, Theater, and User (your own settings).

- 2 Press **EXIT** button to return to TV viewing.

■ You can also adjust **EZ Sound** in the **AUDIO** menu.

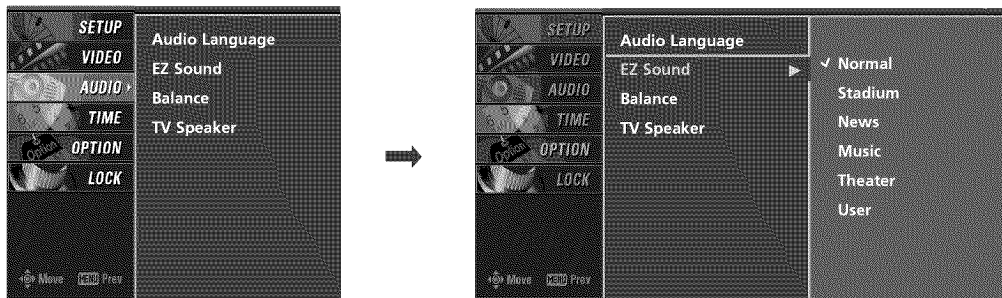

SOUND SETTING ADJUSTMENT - USER MODE

Adjust the sound to suit your taste and room situations.

1 Press the **MENU** button and then use **▲** or **▼** button to select the **AUDIO** menu.

2 Press the **▶** button and then use **▲** or **▼** button to select **EZ Sound**.

3 Press the **▶** button and then use **▲** or **▼** button to select **User**.

4 Press the **▶** button and then use **▲** or **▼** button to select the desired sound option (**Treble**, **Bass**, or **Front Surround**).

5 Press the **▶** button and then use **◀** or **▶** button to make appropriate adjustments.

Selecting the Front surround

Press the **▶** button and then use **◀** or **▶** button to select **Off** or **SRS (Sound Retrieval System) TruSurround XT**.

- When **SRS (Sound Retrieval System) TruSurround XT** is selected, **Balance** is disable and set to 0.
- When **Off** is selected, **Balance** is restored to the original value set the user.

6 Press **EXIT** button to return to TV viewing or press **MENU** button to return to the previous menu.

SRS TruSurround XT

Takes advantage of any multi-channel format without needing to add extra speakers or equipment. Dialog clarity, bass enrichment, and the addition of stereo audio enhancement produces an immersive sound experience from standard stereo material.



1

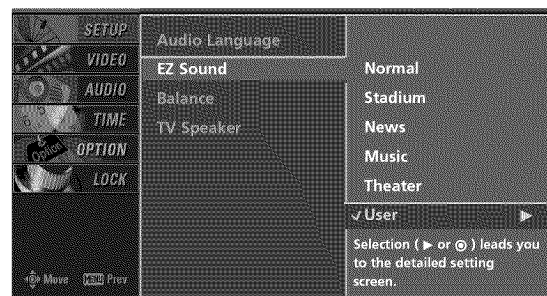

2 3

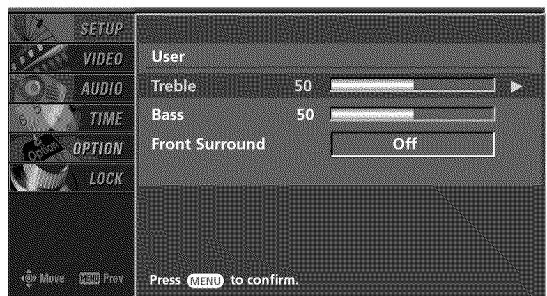

4

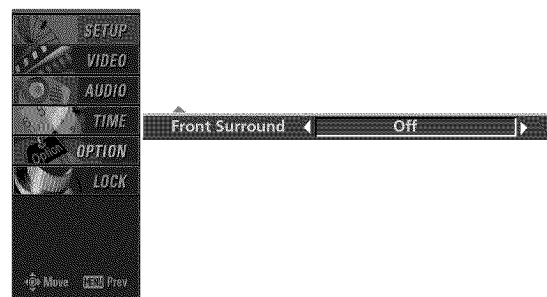

5

SOUND & LANGUAGE CONTROL

BALANCE

Adjust the left/right sound of speaker to suit your taste and room situations.

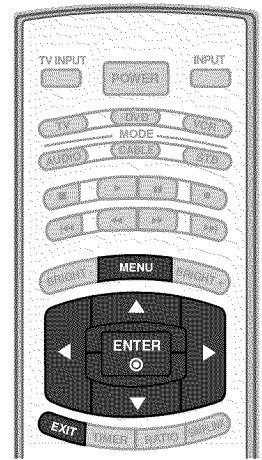

1 Press the **MENU** button and then use ▲ or ▼ button to select the **AUDIO** menu.

2 Press the ► button and then use ▲ or ▼ button to select **Balance**.

3 Press the ► button and then use ◀ or ▶ button to make appropriate adjustments.

4 Press **EXIT** button to return to TV viewing or press **MENU** button to return to the previous menu.



1

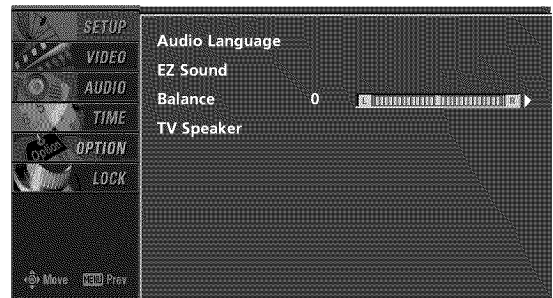

2

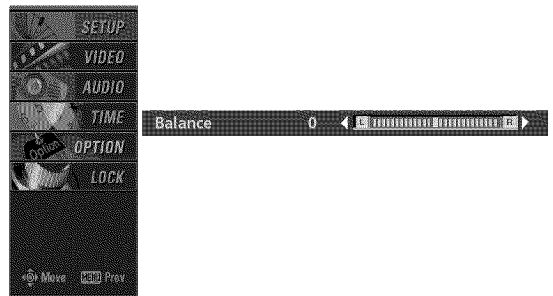

3

TV SPEAKERS ON/OFF SETUP

Turn the TV speakers off if using external audio equipment. Feature turns the TV Speakers option On or Off.

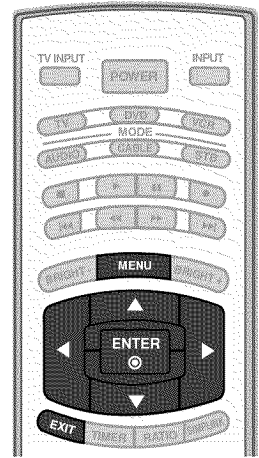

- 1 Press the **MENU** button and then use ▲ or ▼ button to select the **AUDIO** menu.
- 2 Press the ► button and then use ▲ or ▼ button to select **TV Speaker**.
- 3 Press the ► button and then use ▲ or ▼ button to select **On** or **Off**.
- 4 Press **EXIT** button to return to TV viewing or press **MENU** button to return to the previous menu.

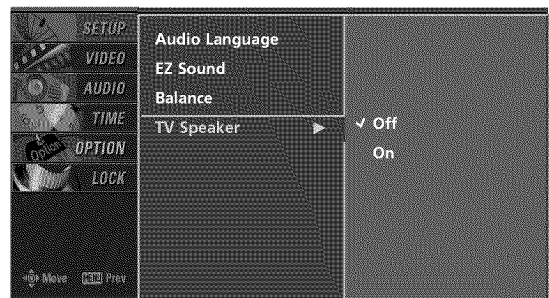
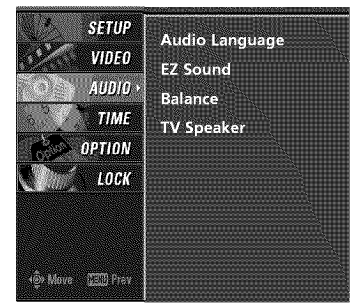

SOUND & LANGUAGE CONTROL

STEREO/SAP BROADCASTS SETUP

This TV can receive MTS stereo programs and any SAP (Secondary Audio Program) that accompanies the stereo program if the station transmits an additional sound signal as well as the original one and when you select Stereo or SAP on the remote control.

Mono sound is automatically received if the broadcast is only in Mono; even though Stereo or SAP has been selected.

Select Mono if you want to listen to the mono sound in remote areas during stereo/SAP broadcasting.

Stereo or SAP can be received in Analog channel.

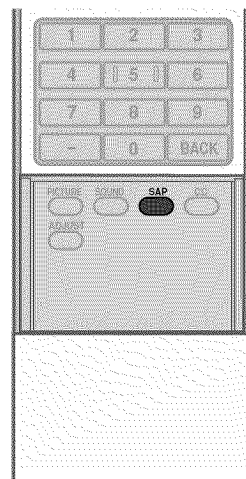

1 Use the **SAP** button to select your desired MTS mode in analog signal. Each time you press the **SAP** button, **Mono**, **Stereo**, or **SAP** appear in turn.

- If other languages available on the digital signal, select them with the **SAP** button.

2 Press **EXIT** button to save and return to TV viewing.

AUDIO LANGUAGE

Other languages may be available if a digital signal is provided by the broadcasting station.

This feature operates only in DTV/CADTV mode.

- 1 Press the **MENU** button and then use **▲** or **▼** button to select the **AUDIO** menu.
- 2 Press the **▶** button and then use **▲** or **▼** button to select **Audio Language**.
- 3 Press the **▶** button and then use **▲** or **▼** button to select : **English, Spanish, or French**.
- 4 Press **EXIT** button to return to TV viewing or press **MENU** button to return to the previous menu.

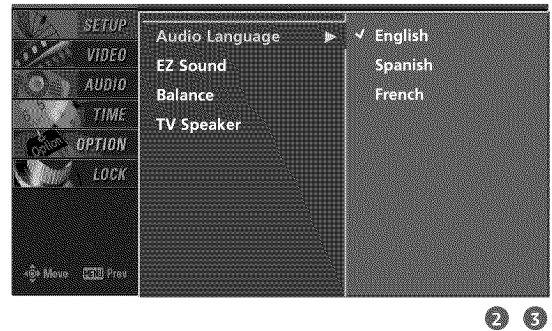
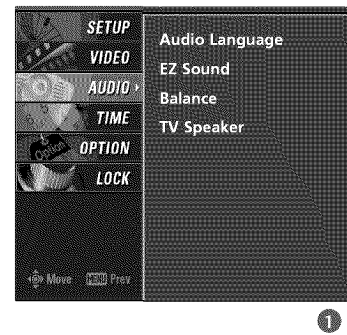
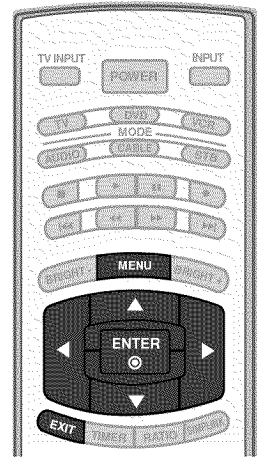

SOUND & LANGUAGE CONTROL

ON-SCREEN MENUS LANGUAGE SELECTION

The menus can be shown on the screen in the selected language. First select your language.

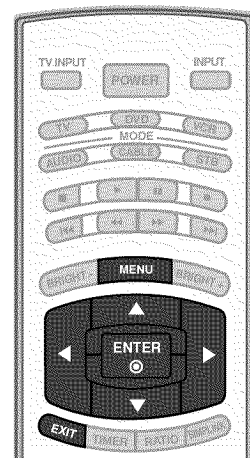

1 Press the **MENU** button and then use ▲ or ▼ button to select the **OPTION** menu.

2 Press the ► button and then use ▲ or ▼ button to select **Language**.

3 Press the ► button and then use ▲ or ▼ button to select your desired language.
From this point on, the on-screen menus will be shown in the selected language.

4 Press the **EXIT** button to return to TV viewing or press **MENU** to return to the previous menu.

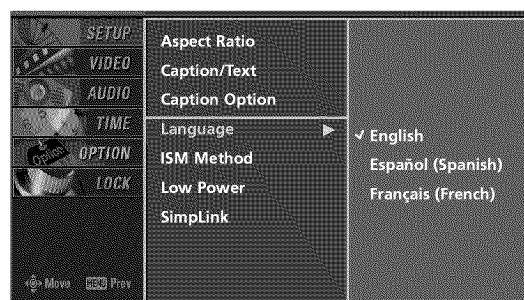
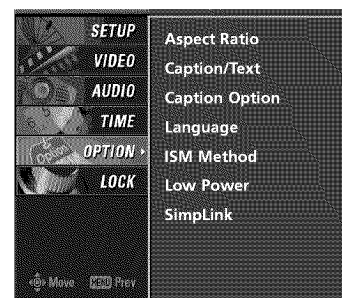

CAPTION / TEXT

Analog Broadcasting System Captions

Select a caption mode for displaying captioning information if provided on a program. Analog caption displays information at any position on the screen and is usually the program's dialog.

Text displays information, usually at the bottom position and is used for a data service, generally not program related.

Caption/Text, if provided by the broadcaster, would be available for both digital and analog channels on the Antenna/Cable.

This TV is programmed to memorize the caption/text mode which was last set when you turn the power off.

When you select the CC1 ~ Text4, Caption option must be disabled.

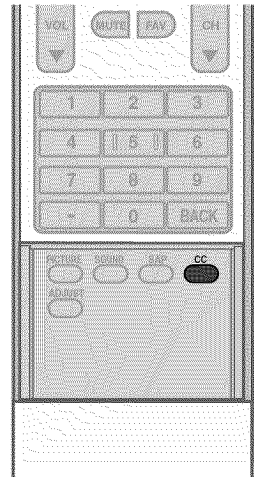

- 1 Use the **CC** button repeatedly to select Caption Off, CC1, CC2, CC3, CC4, Text1, Text2, Text3 or Text4.

■ CAPTION

The term for the words that scroll across the bottom of the TV screen; usually the audio portion of the program provided for the hearing impaired.

■ TEXT

The term for the words that appear in a large black frame and almost cover the entire screen; usually messages provided by the broadcaster.

- 2 Press **EXIT** to save and return to TV viewing.

■ You can also use the **OPTION** menu to select **Caption/Text**.

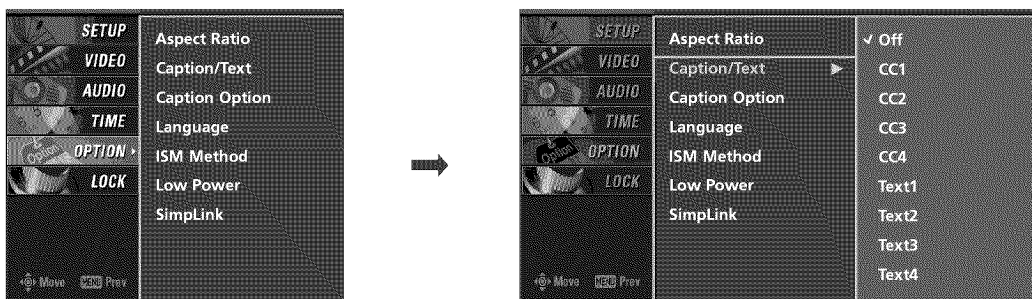

SOUND & LANGUAGE CONTROL

Digital Broadcasting System Captions

Choose the language you want the DTV/CADTV Captions to appear in.

Other Languages can be chosen for digital sources only if they are included on the program.

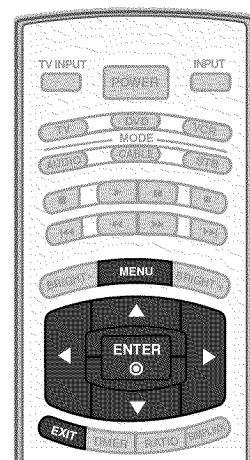

1 Press the **MENU** button and then use ▲ or ▼ button to select the **OPTION** menu.

2 Press the ► button and then use ▲ or ▼ button to select **Caption/Text**.

3 Press the ► button and then use ▲ or ▼ button to select available caption languages : **English, Spanish** or **French**.

4 Press **EXIT** button to return to TV viewing or press **MENU** button to return to the previous menu.

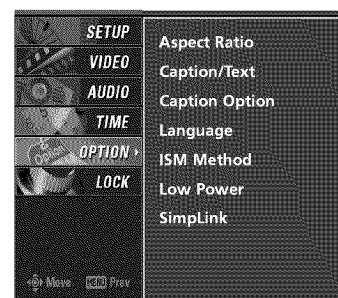

1

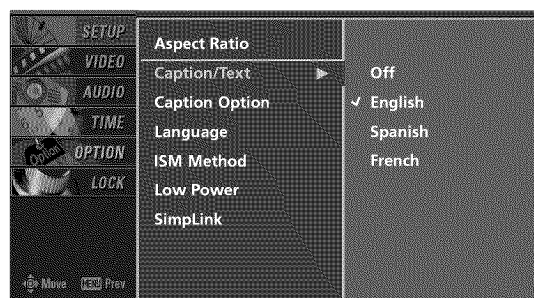

2 3

CAPTION OPTION

Customize the DTV/CADTV captions that appear on your screen.

1 Press the **MENU** button and then use **▲** or **▼** button to select the **OPTION** menu.

2 Press the **▶** button and then use **▲** or **▼** button to select **Caption Option**.

3 Press the **▶** button and then use **◀** or **▶** button to select **Custom**.

4 Use **▲** or **▼** button to customize the **Style, Font, etc.**, to your preference.

A preview icon is provided at the bottom of the screen, use it to see the caption language.

- ▶ **Size** : Set the word size.
- ▶ **Font** : Select a typeface for the text.
- ▶ **Text Color** : Choose a color for the text.
- ▶ **Text Opacity** : Specify the opacity for the text color.
- ▶ **Bg (Background) Color** : Select a background color.
- ▶ **Bg (Background) Opacity** : Select the opacity for the background color.
- ▶ **Edge Type** : Select an edge type.
- ▶ **Edge Color** : Select a color for the edges.

5 Press **EXIT** button to return to TV viewing or press **MENU** button to return to the previous menu.

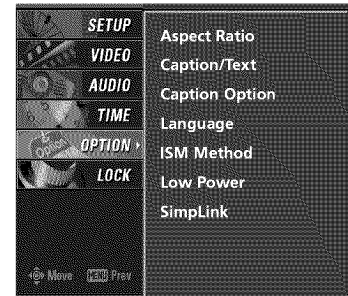
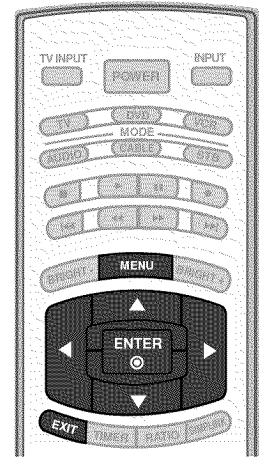

1

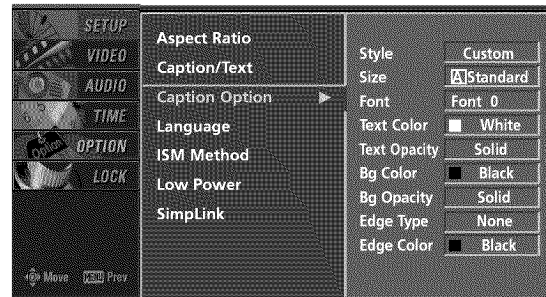

2 3 4

TIME SETTING

CLOCK SETTING

Auto Clock Setup

The time is set automatically from a digital channel signal. The digital channel signal includes information for the current time provided by the broadcasting station.

Set the clock manually if the current time is set incorrectly by the auto clock function.

The factory default value of the Auto Clock is Off, because a clock information sent each broadcasting station is different.

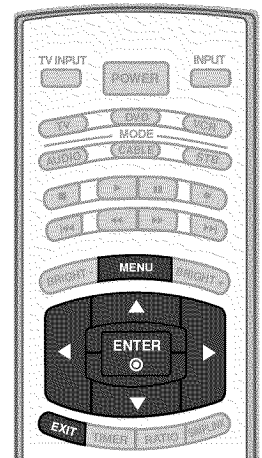

1 Press the **MENU** button and then use ▲ or ▼ button to select the **TIME** menu.

2 Press the ► button and then use ▲ or ▼ button to select **Auto Clock**.

3 Press the ► button and then use ▲ or ▼ button to select **On**.

4 Press the ► button and then use ▲ or ▼ button to select your viewing area time zone:
U.S.A : **Eastern, Central, Mountain, Pacific, Alaska or Hawaii.**
Canada : **Eastern, Central, Mountain, Pacific, New F.land or Atlantic.**

5 Press the ► button and then use ▲ or ▼ button to select **Auto, Off, On**, depending on whether or not your viewing area observes Daylight Saving time.

6 Press **EXIT** button to return to TV viewing or press **MENU** button to return to the previous menu.



Manual Clock Setup

If the current time setting is wrong, reset the clock manually.

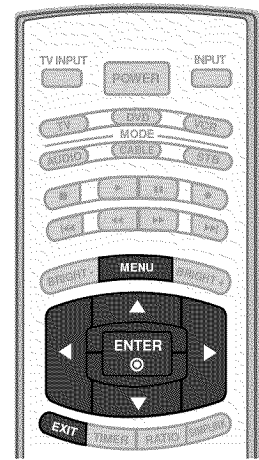

- 1 Press the **MENU** button and then use **▲** or **▼** button to select the **TIME** menu.
- 2 Press the **▶** button and then use **▲** or **▼** button to select **Manual Clock**.
- 3 Press the **▶** button and then use **◀** or **▶** button to select either the year, date, or time option. Once selected, use the **▲** or **▼** button to set the year, date, and time options.
- 4 Press **EXIT** button to return to TV viewing or press **MENU** button to return to the previous menu.



TIME SETTING

AUTO ON/OFF TIMER SETTING

The timer function operates only if the current time has been set.

The Off-Timer function overrides the On-Timer function if they are both set to the same time.

The TV must be in standby mode for the On-Timer to work. If you do not press any button within 2 hours after the TV turns on with the On Timer function, the TV will automatically revert to standby mode.

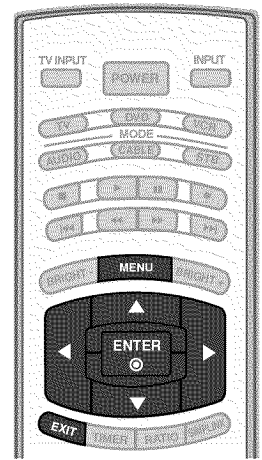

1 Press the **MENU** button and then use **▲** or **▼** button to select the **TIME** menu.

2 Press the **▶** button and then use **▲** or **▼** button to select **Off Timer** or **On Timer**.

3 Press the **▶** button and then use **▲** or **▼** button to select **On**.
■ To cancel the **On/Off timer** function, select **Off**.

4 Press the **▶** button and then use **▲** or **▼** button to set the hour.

5 Press the **▶** button and then use **▲** or **▼** button to set the minutes.

6 **Only On timer**
Press the **▶** button and then use **▲** or **▼** button to select the channel at turn-on.

Press the **▶** button and then use **▲** or **▼** button to set the sound level at turn-on.

7 Press **EXIT** button to return to TV viewing or press **MENU** button to return to the previous menu.



1

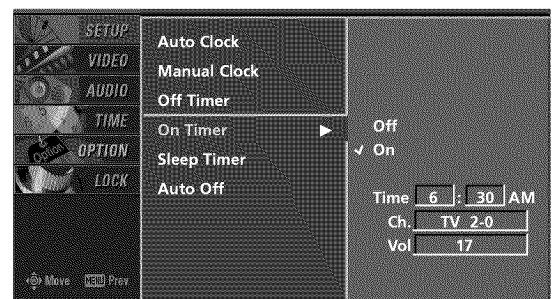

2 3 4 5 6

SLEEP TIMER SETTING

The Sleep Timer turns the TV off at the preset time.
Note that this setting is cleared when the TV is turned off.

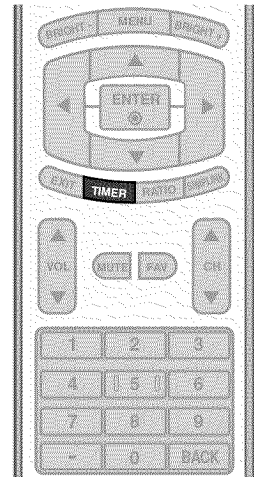

- 1 Press the **TIMER** button repeatedly to select the number of minutes. First the **Off** option appears on the screen, followed by the following sleep timer options : 10, 20, 30, 60, 90, 120, 180, and 240 minutes.
- 2 When the number of minutes you want is displayed on the screen, press the **ENTER** button. The timer begins to count down from the number of minutes selected.
- 3 To check the remaining minutes before the TV turns off, press the **TIMER** button once.
- 4 To cancel the Sleep Timer, press the **TIMER** button repeatedly to select **Off**.

■ You can also set up the **Sleep Timer** in the **TIME** menu.

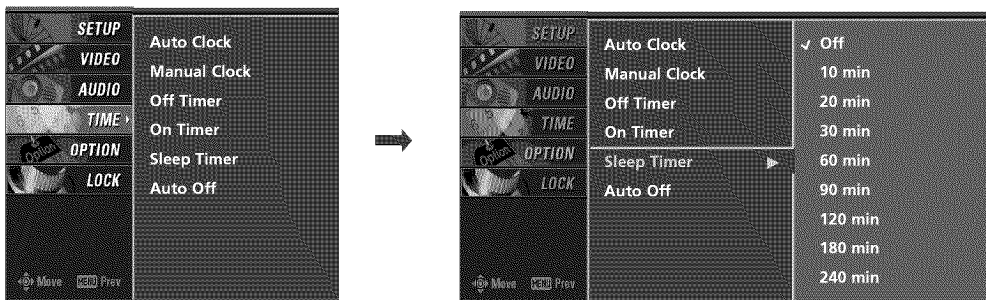

TIME SETTING

AUTO SHUT-OFF SETTING

If set to on and there is no input signal, the TV turns off automatically after 10 minutes.

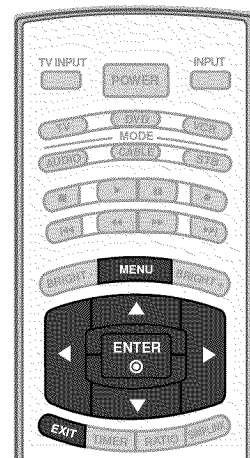

1 Press the **MENU** button and then use ▲ or ▼ button to select the **TIME** menu.

2 Press the ► button and then use ▲ or ▼ button to select **Auto Off**.

3 Press the ► button and then use ▲ or ▼ button to select **On** or **Off**.

4 Press **EXIT** button to return to TV viewing or press **MENU** button to return to the previous menu.



1

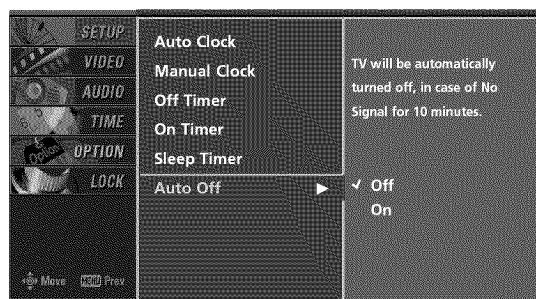

2 3

PARENTAL CONTROL / RATINGS

Parental Control can be used to block specific channels, ratings and other viewing sources.

The Parental Control Function (V-Chip) is used to block program viewing based on the ratings sent by the broadcasting station. The default setting is to allow all programs to be viewed. Viewing can be blocked by choosing the type of the program and the categories. It is also possible to block all program viewing for a time period. To use this function, the following must be done :

1. Set ratings and categories to be blocked.
2. Specify a password
3. Enable the lock

V-Chip rating and categories

Rating guidelines are provided by broadcasting stations. Most television programs and television movies can be blocked by TV Rating and/or Individual Categories. Movies that have been shown at the theaters or direct-to-video movies use the Movie Rating System (MPAA) only.

Ratings for Television programs including made-for-TV movies :

- TV-G (General audience)
- TV-PG (Parental guidance suggested)
- TV-14 (Parents strongly cautioned)
- TV-MA (Mature audience only)
- TV-Y (All children)
- TV-Y7 (Children 7 years older)

SET PASSWORD & LOCK SYSTEM

Setting up Your Password

Set up blocking schemes to block specific channels, ratings, and external viewing sources.

A password is required to gain access to this menu.

1 Press the **MENU** button and then use the **▲** or **▼** button to select the **LOCK** menu. Then, press the **▶** button.

- Enter the password as requested.
- The TV is set up with the initial password "0-0-0-0".

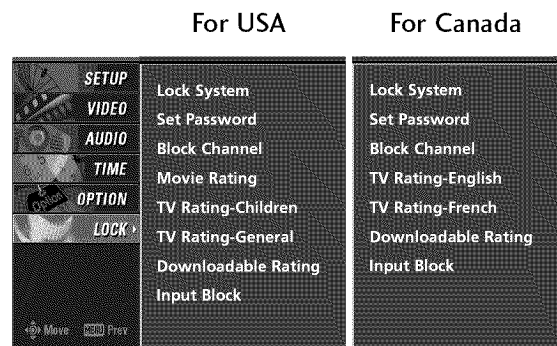

PARENTAL CONTROL /RATINGS

Set Password

Change the password by inputting a new password twice.

- 1 After inputting the password, use the ▲ or ▼ button to choose **Set password**.
- 2 Press the ► button and then choose any 4 digits for your new password.
As soon as the 4 digits are entered, re-enter the same 4 digits on the **Confirm**.
Then your changed password has been memorized.
- 3 Press **EXIT** to return to TV viewing or press **MENU** to return to the previous menu.

NOTE

- ▶ If you ever forget your password, key in '7', '7', '7', '7' on the remote control.

Lock System

Enables or disables the blocking scheme you set up previously.

- 1 After inputting the password, use the ▲ or ▼ button to choose **Lock System**.
- 2 Press the ► button and then use the ▲ or ▼ button to select **On** or **Off**.

■ When you select **On**, the Lock System is enable.
- 3 Press **EXIT** button to return to TV viewing or press **MENU** button to return to the previous menu.

For USA

For Canada

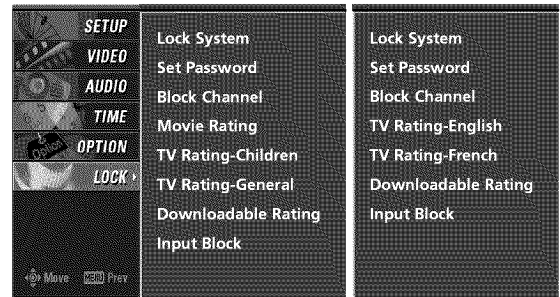

1

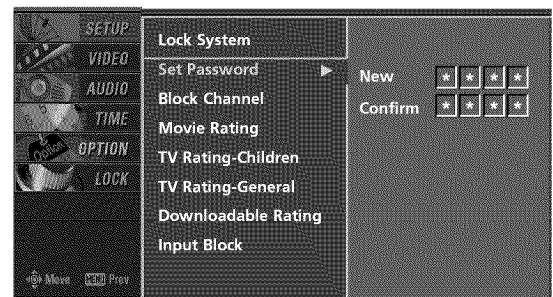

2

For USA

For Canada

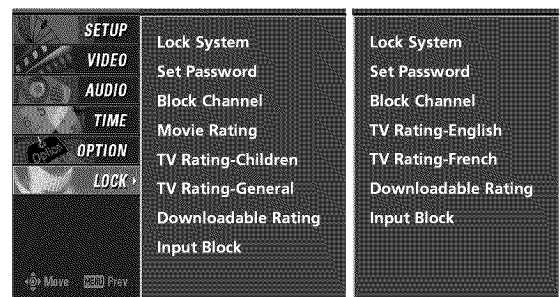

1

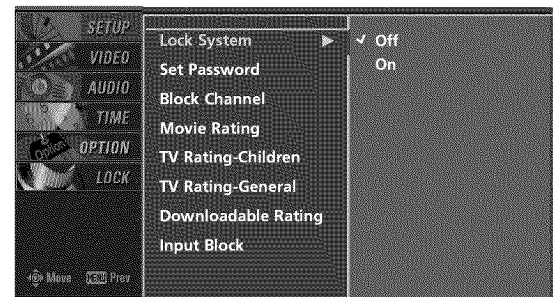

2

CHANNEL BLOCKING

Blocks any channels that you do not want to watch or that you do not want your children to watch.

- 1 After inputting the password, use the ▲ or ▼ button to choose **Block Channel**.
- 2 Press the ► button. You will now see a screen filled with channel numbers and a preview picture.
- 3 Use ▲ ▼ ◀ ▶ button to select a channel and then use the **ENTER** button to block or unblock it.
- 4 Press **EXIT** button to return to TV viewing or press **MENU** button to return to the previous menu.

i.e) USA

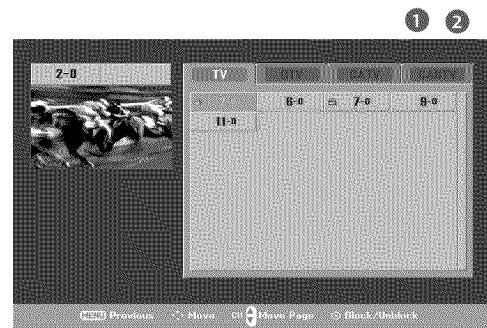
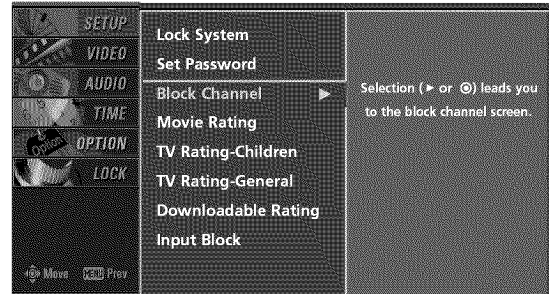

3

EXTERNAL INPUT BLOCKING

Enables you to select a source to block from the external source devices you have hooked up.

- 1 After inputting the password, use the ▲ or ▼ button to choose **Input Block**.
- 2 Press the ► button and then use the ◀ or ▶ button to select a source.
- 3 Press the ► button and then use the ▲ or ▼ button to select **On** or **Off** on the each source.
- 4 Press **EXIT** button to return to TV viewing or press **MENU** button to return to the previous menu.

For USA

For Canada

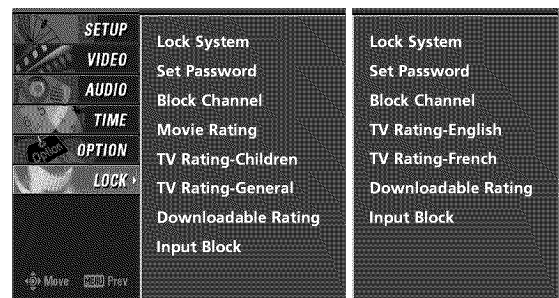

1

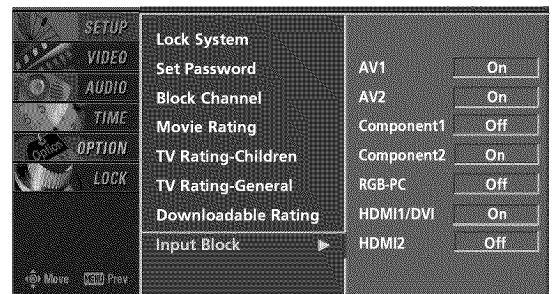

2 3

PARENTAL CONTROL /RATINGS

MOVIE & TV RATING

Movie Rating (MPAA) - for USA only

Blocks movies according to the movie ratings limits specified, so children cannot view certain movies. You can set the ratings limit by blocking out all the movies with the ratings above a specified level. Keep in mind that the movie ratings limit only applies to movies shown on TV, not TV programs, such as soap operas.

1 After inputting the password, use the ▲ or ▼ button to choose **Movie Rating**.

2 Press the ► button and then use the ▲ or ▼ button to select **G, PG, PG-13, R, NC-17** or **X**.

- G (General audience)
- PG (Parental guidance suggested)
- PG-13 (Parents strongly cautioned)
- R (Restricted)
- NC-17 (No one 17 and under admitted)
- X (Adult only)
- Blocking Off (Permits all programs)

► If you set PG-13 : G and PG movies will be available, PG-13, R, NC-17 and X will be blocked.

3 Press **EXIT** button to return to TV viewing or press **MENU** button to return to the previous menu.

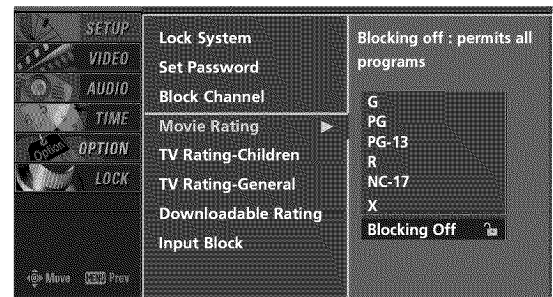
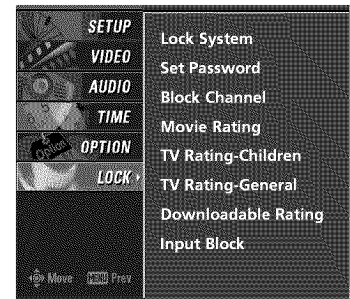

For USA

For Canada

Downloadable Rating

1 After inputting the password, use the ▲ or ▼ button to choose **Downloadable Rating**.

2 Press the ► button and then use the ▲ or ▼ button to select **Dim0, Dim1, Dim2,** or **Dim3**.

3 Press the ► button and then use the ▲ or ▼ button to select **D1L1, D1L2,** or **D1L3**.

4 Press **EXIT** button to return to TV viewing or press **MENU** button to return to the previous menu.

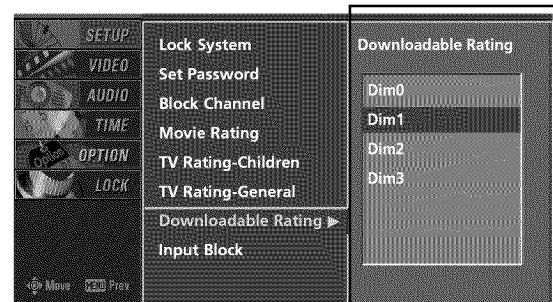
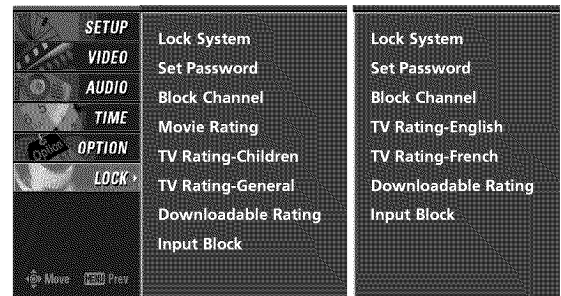

NOTE

- This function may become available in the future and will be available only for digital channel signal.
- This function operates only when TV has received Region5 Rating data.

► Based on rating table, your TV's OSD (On Screen Display) may differ slightly from what is shown in this manual.

TV Rating Children - for USA only

Prevents children from watching certain children's TV programs, according to the ratings limit set. The children rating does not apply to other TV programs. Unless you block certain TV programs intended for mature audiences in the TV Rating - sub menu, your children can view those programs.

1 After inputting the password, use the ▲ or ▼ button to choose **TV Rating-Children**.

2 Press the ► button and then use the ▲ or ▼ button to select **Age**, or **Fantasy Violence**.

Press the ► button and then use the ▲ or ▼ button to select block options.

- Age (applies to TV-Y, TV-Y7)
- Fantasy Violence (applies to TV-Y7)

3 Press **EXIT** button to return to TV viewing or press **MENU** button to return to the previous menu.

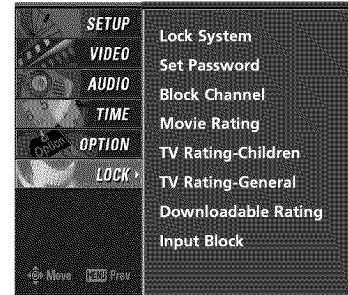

1

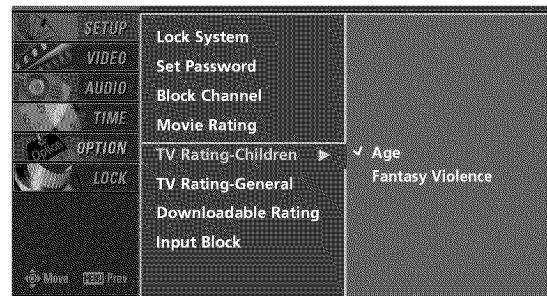

2

TV Rating General - for USA only

Based on the ratings, blocks certain TV programs that you and your family do not want to view.

1 After inputting the password, use the ▲ or ▼ button to choose **TV Rating-General**.

2 Press the ► button and then use the ▲ or ▼ button to select **Age**, **Dialogue**, **Language**, **Sex** or **Violence**.

Press the ► button and then use the ▲ or ▼ button to select block options.

- Age (applies to TV-G, TV-PG, TV-14, TV-MA)
- Dialogue-sexual dialogue (applies to TV-PG, TV-14)
- Language-adult language (applies to TV-PG, TV-14, TV-MA)
- Sex-sexual situations (applies to TV-PG, TV-14, TV-MA)
- Violence (applies to TV-PG, TV-14, TV-MA)

3 Press **EXIT** button to return to TV viewing or press **MENU** button to return to the previous menu.

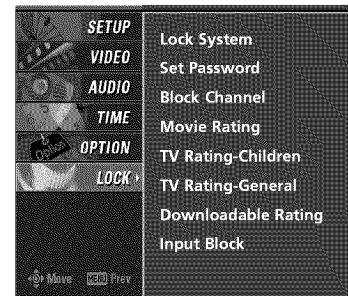

1

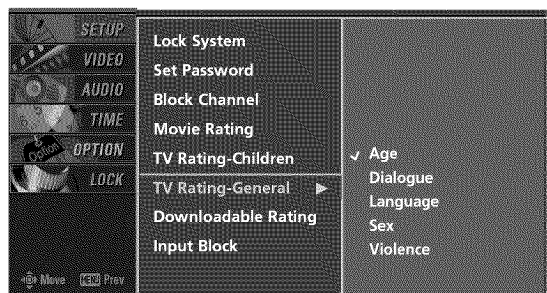

2

PARENTAL CONTROL /RATINGS

TV Rating English - *for CANADA only*

Selecting canadian english language rating system.

- 1 After inputting the password, use the ▲ or ▼ button to choose **TV Rating-English**.
- 2 Press the ► button and then use the ▲ or ▼ button to select **E, C, C8+, G, PG, 14+, 18+, or Blocking Off**.
 - E (Exempt)
 - C (Children)
 - C8+ (Children eight years and older)
 - G (General programming, suitable for all audiences)
 - PG (Parental Guidance)
 - 14+ (Viewers 14 years and older)
 - 18+ (Adult programming)
 - Blocking Off (Permits all programs)

- 3 Press **EXIT** button to return to TV viewing or press **MENU** button to return to the previous menu.

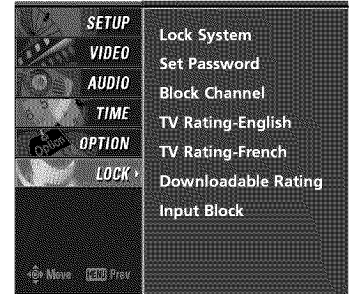

1

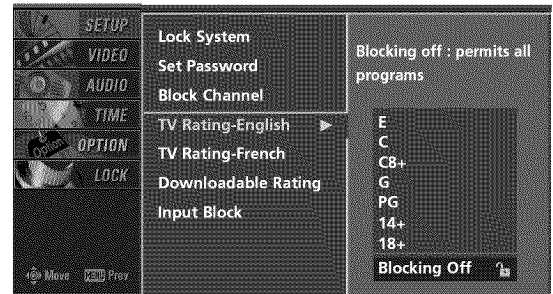

2

TV Rating French - *for CANADA only*

Selecting canadian french language rating system.

- 1 After inputting the password, use the ▲ or ▼ button to choose **TV Rating-French**.
- 2 Press the ► button and then use the ▲ or ▼ button to select **E, G, 8ans+, 13ans+, 16ans+, 18ans+, or Blocking off**.
 - E(Exempt)
 - G(General)
 - 8ans+ (General-Not convenient for little children)
 - 13ans+ (Not convenient for children of 13 years and younger)
 - 16ans+ (Not convenient for children of 16 years and younger)
 - 18ans+ (This programs is only for adults)
 - Blocking off (Permits all programs)

- 3 Press **EXIT** button to return to TV viewing or press **MENU** button to return to the previous menu.

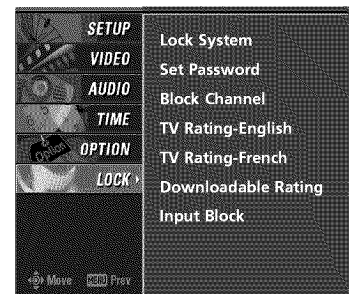

1

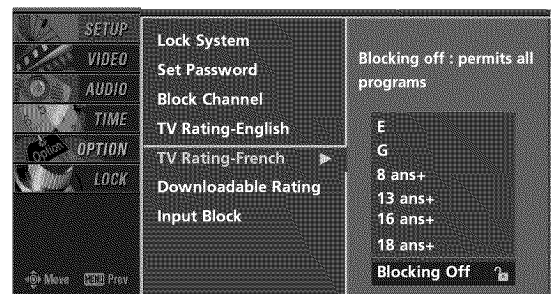

2

APPENDIX

TROUBLESHOOTING

The operation does not work normally.	
The remote control doesn't work	<ul style="list-style-type: none">■ Check to see if there is any object between the product and the remote control causing obstruction. Ensure you are pointing the remote control directly at the TV.■ Ensure that the batteries are installed with correct polarity (+ to +, - to -).■ Ensure that the correct remote operating mode is set: TV, VCR etc.■ Install new batteries.
Power is suddenly turned off	<ul style="list-style-type: none">■ Is the sleep timer set?■ Check the power control settings. Power interrupted.■ No broadcast on station tuned with Auto off activated.

The video function does not work.	
No picture & No sound	<ul style="list-style-type: none">■ Check whether the product is turned on.■ Try another channel. The problem may be with the broadcast.■ Is the power cord inserted into wall power outlet?■ Check your antenna direction and/or location.■ Test the wall power outlet, plug another product's power cord into the outlet where the product's power cord was plugged in.
Picture appears slowly after switching on	<ul style="list-style-type: none">■ This is normal, the image is muted during the product startup process. Please contact your service center, if the picture has not appeared after five minutes.
No or poor color or poor picture	<ul style="list-style-type: none">■ Adjust Color in menu option.■ Keep a sufficient distance between the product and the VCR.■ Try another channel. The problem may be with the broadcast.■ Are the video cables installed properly?■ Activate any function to restore the brightness of the picture.
Horizontal/vertical bars or picture shaking	<ul style="list-style-type: none">■ Check for local interference such as an electrical appliance or power tool.
Poor reception on some channels	<ul style="list-style-type: none">■ Station or cable product experiencing problems, tune to another station.■ Station signal is weak, reorient antenna to receive weaker station.■ Check for sources of possible interference.
Lines or streaks in pictures	<ul style="list-style-type: none">■ Check antenna (Change the direction of the antenna).

The audio function does not work.

Picture OK & No sound	<ul style="list-style-type: none"> ■ Press the VOL or VOLUME button. ■ Sound muted? Press MUTE button. ■ Try another channel. The problem may be with the broadcast. ■ Are the audio cables installed properly?
No output from one of the speakers	<ul style="list-style-type: none"> ■ Adjust Balance in menu option.
Unusual sound from inside the product	<ul style="list-style-type: none"> ■ A change in ambient humidity or temperature may result in an unusual noise when the product is turned on or off and does not indicate a fault with the product.

There is a problem in PC mode. (Only PC mode applied)

The signal is out of range	<ul style="list-style-type: none"> ■ Adjust resolution, horizontal frequency, or vertical frequency. ■ Check the input source.
Vertical bar or stripe on background & Horizontal Noise & Incorrect position	<ul style="list-style-type: none"> ■ Work the Auto configure or adjust clock, phase, or H/V position. (Option)
Screen color is unstable or single color	<ul style="list-style-type: none"> ■ Check the signal cable. ■ Reinstall the PC video card.

MAINTENANCE

Early malfunctions can be prevented. Careful and regular cleaning can extend the amount of time you can enjoy your new TV.

Caution: Be sure to turn the power off and unplug the power cord before you begin any cleaning.

Cleaning the Screen

- 1 Here's a great way to keep the dust off your screen for a while. Wet a soft cloth in a mixture of lukewarm water and a little fabric softener or dish washing detergent. Wring the cloth until it's almost dry, and then use it to wipe the screen.
- 2 Make sure the excess water is off the screen, and then let it air-dry before you turn on your TV.

Cleaning the Cabinet

- To remove dirt or dust, wipe the cabinet with a soft, dry, lint-free cloth.
- Please be sure not to use a wet cloth.

Extended Absence

CAUTION

- ▶ If you expect to leave your TV dormant for a long time (such as a vacation), it's a good idea to unplug the power cord to protect against possible damage from lightning or power surges.

APPENDIX

PRODUCT SPECIFICATIONS

MODELS		42PC5D (42PC5D-UC) 42PC5DC (42PC5DC-UC)	50PC5D (50PC5D-UC) 50PC5DC (50PC5DC-UC)
Dimensions (Width x Height x Depth)	Including stand	41.3 x 30.2 x 12.2 inches 1048.0 x 766.0 x 310.0 mm	48.9 x 34.9 x 14.6 inches 1242.0 x 887.6 x 370.0 mm
	Excluding stand	41.3 x 28.1 x 3.3 inches 1048.0 x 713.0 x 83.5 mm	48.9 x 32.6 x 3.5 inches 1242.0 x 827.2 x 88.0 mm
Weight	including stand	61.7 pounds / 28.0 kg	86.6 pounds / 39.3 kg
	excluding stand	54.2 pounds / 24.6 kg	76.3 pounds / 34.6 kg
Power requirement	Television System	AC100-240V ~ 50/60Hz	
Program Coverage	External Antenna Impedance	NTSC-M, ATSC, 64 & 256 QAM	
		VHF 2-13, UHF 14-69, CATV 1-135, DTV 2-69, CADTV 1-135	
		75 ohm	
Environment condition	Operating Temperature	32 ~ 104°F (0 ~ 40°C)	
	Operating Humidity	Less than 80%	
	Storage Temperature	-4 ~ 140°F (-20 ~ 60°C)	
	Storage Humidity	Less than 85%	

■ The specifications shown above may be changed without prior notice for quality improvement.

MODELS		32LC7D(32LC7D-UB) 32LC7DC(32LC7DC-UB)	37LC7D (37LC7D-UB)	42LC7D (42LC7D-UB)
Dimensions (Width x Height x Depth)	Including stand	31.8 x 23.9x 9.8 inches 806.6 x 606.5 x 249.0mm	36.5 x 27.3 x 11.0 inches 927.0 x 692.8 x 280.5 mm	40.7 x 29.5 x 11.3 inches 1033.4 x 750.0 x 287.6 mm
	Excluding stand	31.8 x 21.7 x 3.1 inches 806.6 x 552.3 x 79.0 mm	36.5 x 24.8 x 3.5 inches 927.0 x 630.0 x 88.0 mm	40.7 x 27.0x 3.5 inches 1033.4 x 686.8 x 88.5 mm
Weight	including stand	30.2 pounds / 13.7 kg	44.1 pounds / 20.0 kg	54.9 pounds / 24.9 kg
	excluding stand	24.7 pounds / 11.2 kg	35.3 pounds / 16.0 kg	45.0 pounds / 20.4 kg
Power requirement	AC100-240V ~ 50/60Hz			
Television System	NTSC-M, ATSC, 64 & 256 QAM			
Program Coverage	VHF 2-13, UHF 14-69, CATV 1-135, DTV 2-69, CADTV 1-135			
External Antenna Impedance	75 ohm			
Environment condition	Operating Temperature	32 ~ 104°F (0 ~ 40°C)		
	Operating Humidity	Less than 80%		
Environment condition	Storage Temperature	-4 ~ 140°F (-20 ~ 60°C)		
	Storage Humidity	Less than 85%		

■ The specifications shown above may be changed without prior notice for quality improvement.

PROGRAMMING THE REMOTE CONTROL

The provided universal remote control can be programmed to operate most remote-controllable devices. Note that the remote may not control all models of other brands.

Programming a code into a remote mode

- 1** To find out whether your remote control can operate each device without programming, turn on the device (such as a VCR) and press the corresponding mode button on the remote. After that, press the **POWER** button. If the device is turned off and it responds properly the remote control need not be programmed. If not, the remote should be programmed to operate the device. The programming procedures are explained below.
- 2** Press the **MENU** and **MUTE** button continuously at the same time for two seconds; the currently selected device button is illuminated. If you don't press any button for 20 seconds, the light on the mode button will be turned off. In that case, you have to repeat from step 2.
- 3** Enter the appropriate code from the code table on the following pages. When pressing the button, the light blinks at a time. If the device turned off, the programming is successful.
- 4** Press the **MENU** button to store the code. After blinking twice, this code is stored.
- 5** Test the remote control functions to see if the device responds properly. If not, steps 2-5.

Remote Control Code

VCR

Brand	Codes	Brand	Codes	Brand	Codes
AIWA	034	MAGNAVOX	031 033 034 041	SAMSUNG	032 040 102 104
AKAI	016 043 046 124		067 068		105 107 109 112
	125 146	MARANTZ	012 031 033 067		113 115 120 122
AMPRO	072		069		125
ANAM	031 033 103	MARTA	101	SANSUI	022 043 048 135
AUDIO DYNAMICS	012 023 039 043	MATSUI	027 030	SANYO	003 007 010 014
BROKSONIC	035 037 129	MEI	031 033		102 134
CANON	028 031 033	MEMOREX	003 010 014 031	SCOTT	017 037 112 129
CAPEHART	108		033 034 053 072		131
CRAIG	003 040 135		101 102 134 139	SEARS	003 008 009 010
CURTIS MATHES	031 033 041	MGA	045 046 059		013 014 017 020
DAEWOO	005 007 010 064	MINOLTA	013 020		031 042 073 081
	065 108 110 111	MITSUBISHI	013 020 045 046		101
	112 116 117 119		049 051 059 061	SHARP	031 054 149
DAYTRON	108		151	SHINTOM	024
DBX	012 023 039 043	MTC	034 040	SONY	003 009 031 052
DYNATECH	034 053	MULTITECH	024 034		056 057 058 076
ELECTROHOME	059	NEC	012 023 039 043		077 078 149
EMERSON	006 017 025 027		048	SOUNDESIGN	034
	029 031 034 035	NORDMENDE	043	STS	013
	036 037 046 101	OPTONICA	053 054	SYLVANIA	031 033 034 059
	129 131 138 153	PANASONIC	066 070 074 083		067
FISHER	003 008 009 010		133 140 145	SYMPHONIC	034
FUNAI	034			TANDY	010 034
GE	031 033 063 072	PENTAX	013 020 031 033	TATUNG	039 043
	107 109 144 147		063	TEAC	034 039 043
GO VIDEO	132 136	PHILCO	031 034 067	TECHNICS	031 033 070
HARMAN KARDON	012 045	PHILIPS	031 033 034 054	TEKNIKA	019 031 033 034
HITACHI	004 018 026 034		067 071 101		101
	043 063 137 150	PILOT	101	THOMAS	034
INSTANTREPLAY	031 033	PIONEER	013 021 048	TMK	006
JCL	031 033	PORTLAND	108	TOSHIBA	008 013 042 047
JCPENNY	012 013 015 033	PULSAR	072		059 082 112 131
	040 066 101	QUARTZ	011 014	TOTEVISION	040 101
JENSEN	043	QUASAR	033 066 075 145	UNITECH	040
JVC	012 031 033 043	RCA	013 020 033 034	VECTOR RESEARCH	012
	048 050 055 060		040 041 062 063	VICTOR	048
	130 150 152		107 109 140 144	VIDEO CONCEPTS	012 034 046
KENWOOD	014 034 039 043		145 147	VIDEOSONIC	040
	047 048	REALISTIC	003 008 010 014	WARDS	003 013 017 024
LG (GOLDSTAR)	001 012 013 020		031 033 034 040		031 033 034 040
	101 106 114 123		053 054 101		053 054 131
LLOYD	034	RICO	058	YAMAHA	012 034 039 043
LXI	003 009 013 014	RUNCO	148	ZENITH	034 048 056
	017 034 101 106	SALORA	014		058 072 080 101
MAGIN	040				

APPENDIX

Cable Box

Brand	Codes	Brand	Codes	Brand	Codes
ABC	003 004 039 042 046 052 053	LG (GOLDSTAR)	074 001 106 101 005	REMBRANT	025
AJIN	112	M-NET	037	SAMSUNG	102 107 030 068
ANTRONIK	014	MACOM	033	SCIENTIFIC ATLANTA	003 011 041 042 043 045 046
ARCHER	005 007 014 024	MAGNAVOX	010 012 064 079	SHERITECH	022
CABLE STAR	026	MEMOREX	100	SIGNAL	030
CENTURION	092	MOVIE TIME	028 032	SIGNATURE	052
CENTURY	007	NSC	015 028 038 071 073	SL MARX	030
CITIZEN	007	OAK	016 031 037 053	SPRUCER	047 078
COLOUR VOICE	065 090	PANASONIC	044 047	STARCOM	002 004 008 009
COMBANO	080 081	PARAGON	100	STARGATE	008 030
COMTRONICS	019 030	PHILIPS	006 012 013 020 065 085 090	TADIRAN	030
DIAMOND	023	PIONEER	034 051 052 063 076	TAEKWANG	110
EAGLE	020 030 040	POST NEWS WEEK	016	TAIHAN	105
EASTERN	057 062 066	PRUCER	059	TANDY	017
ELECTRICORD	032	PTS	011 048 071 072 073 074	TEXSCAN	029
GE	072	PULSAR	100	TOCOM	039 040 056
GEMINI	008 022 025 054	RCA	047	TOSHIBA	100
GI	052 074	REGAL	049 050	UNIKA	007 014 024
GOLDEN CHANNEL	030	REGENCY	057	UNITED CABLE	004 053
HAMLIN	049 050 055			UNIVERSAL	005 007 014 024 026 027 032 035
HITACHI	052 055			VIEWSTAR	012 015 018 086 087 088 089
HOSPITALITY	070 077			ZENITH	100 114 060 093
JERROLD	002 003 004 008 009 010 052 069				

HDSTB

Brand	Codes	Brand	Codes	Brand	Codes
ALPHASTAR DSR	123	HOUSTON TRACKER	033 037 039 051	PROSAT	072
AMPLICA	050		057 104	RCA	066 106
BIRDVIEW	051 126 129	HUGHES	068	REALISTIC	043 074
CHANNEL MASTER	013 014 015 018 036 055	JANIEL	060 147	SAMSUNG	123
CHAPARRAL	008 009 012 077	JERROLD	061	SATELLITE SERVICE CO	028 035 047 057 085
CITOH	054	KATHREIN	108	SCIENTIFIC ATLANTA	032 138
CURTIS MATHES	050 145	LEGEND	057	SONY	103
DRAKE	005 006 007 010 011 052 112 116 141	LG	001	STARCAST	041
DX ANTENNA	024 046 056 076	LUTRON	132	SUPER GUIDE	020 124 125
ECHOSTAR	038 040 057 058 093 094 095 096 097 098 099 100 122	LUXOR	062 144	TEECOM	023 026 075 087 088 090 107 130 137
ELECTRO HOME	089	MACOM	010 059 063 064 065	TOSHIBA	002 127
EUROPLUS	114	MEMOREX	057	UNIDEN	016 025 042 043 044 045 048 049 078 079 080 086 101 135 136
FUJITSU	017 021 022 027 133 134	NEXTWAVE	028 124 125	VIEWSTAR	115
GENERAL INSTRUMENT	003 004 016 029 031 059 101	NORSAT	069 070	WINEGARD	128 146
HITACHI	139 140	PACE SKY SATELLITE	143	ZENITH	081 082 083 084 091 120
		PANASONIC	060 142		
		PANSAT	121		
		PERSONAL CABLE	117		
		PHILIPS	071		
		PICO	105		
		PRESIDENT	019 102		
		PRIMESTAR	030 110 111		

Audio

Brand	Codes	Brand	Codes	Brand	Codes
AIWA	014 028 070 096 125 129 139 229 230		157 158 159 160 189 207 222 224 225 226 227 243 247	RCX	092
AKAI	163			REALISTIC	103 106
ANAM	003 014 017 023 059 106 189 216 217 235 236	LOTTE	014 016 036 098 100 172 173 174 175 176 177 178 179 180 181 183 201 202 208 213 214 219 223 232 238 240	SAMSUNG	124 145 146 182 193 194 195 203 204 244 245 246
BURMECTER	252			SANSUI	011 135 138 144
CARVER	086			SANYO	019 083 234
CLARION	199			SCOTT	106 186
DAEWOO	027 053 060 084 102 148 198 221	LXI	103	SHARP	031 032 051 052 072 082 117 119 156 184 199 200 206 209
DENON	015 075 130 143	MAGNAVOX	111	SHERWOOD	005 006 158
FANTASIA	071	MARANTZ	002 018 020 025 034 041 081 090 097 112	SONY	044 045 109 114 118 126 248 249
FINEARTS	022			TAEKWANG	012 020 073 074 076 077 105 161 162 163 164 165 166 167 168 169 205 231 233 242
FISHER	089 099	MCINTOSH	049		
LG(GOLDSTAR)	001 021 024 029 087 107 108 110 190 191 192 210 211 212 239	MCS	104		
		MEMOREX	107		
HAITAI	034 035 188 222	NAD	046		
HARMAN/KARDON	068	ONKYO	013 040 041 047 048 056 057 132 133 140	TEAC	010 085 106 136 185 187 237
JVC	004 013 141			TECHNICS	101 113 128 134 147 218
KEC	185 186 187	OPTIMUS	158	TOSHIBA	137
KOHEL	030	PANASONIC	007 033 064 113 142 220 241 251	THE	061
NAD	045 046	PENNEY	104	VICTOR	088 131
KENWOOD	038 050 067 089 170 171 197 206 215 222	PHILIPS	026 112 143	WARDS	089
		PIONEER	039 042 043 063 065 091 093 094 115 123 127 250	YAMAHA	054 055 066 092 199
INKEL	037 058 062 069 078 079 095 121 122 149 150 151 152 153 154 155	QUASAR	113		
		RCA	080		

DVD

Brand	Codes	Brand	Codes	Brand	Codes
APEX DIGITAL	022	mitsubishi	002	RCA	005 006
DENON	020 014	NAD	023	SAMSUNG	011 015
GE	005 006	ONKYO	008 017	SONY	007
HARMAN KARDON	027	PANASONIC	003 009	THOMPSON	005 006
JVC	012	PHILIPS	013	TOSHIBA	019 008
LG	001 010 016 025	PIONEER	004 026	YAMAHA	009 018
MAGNAVOX	013	PROCEED	021	ZENITH	010 016 025
MARANTZ	024	PROSCAN	005 006		

IR CODES

1. How to Connect

- Connect your wired remote control to the Remote Control port on the TV.

2. Remote Control IR Codes

Output waveform

Single pulse, modulated with 37.917KHz signal at 455KHz

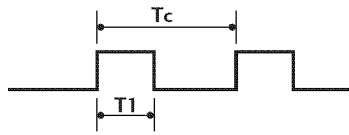

Carrier frequency
 $FCAR = 1/TC = fOSC/12$
 Duty ratio = $T1/TC = 1/3$

Configuration of frame

1st frame

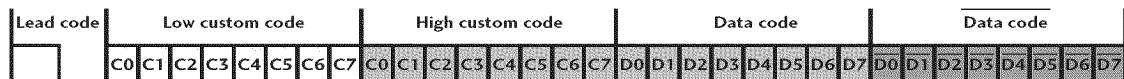

Repeat frame

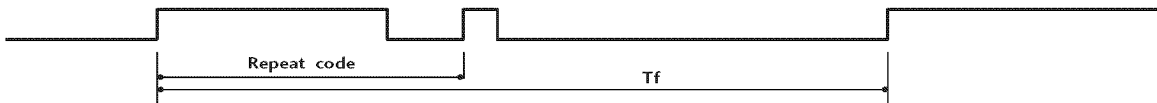

Lead code

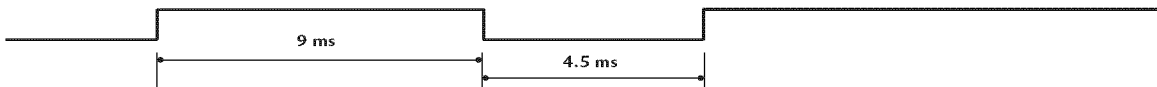

Repeat code

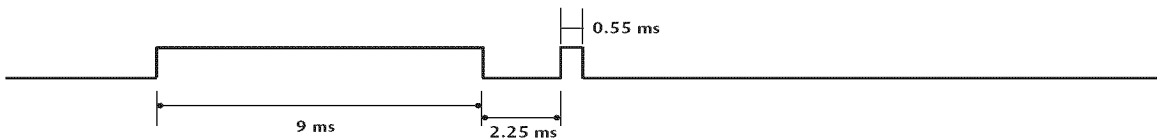

Bit description

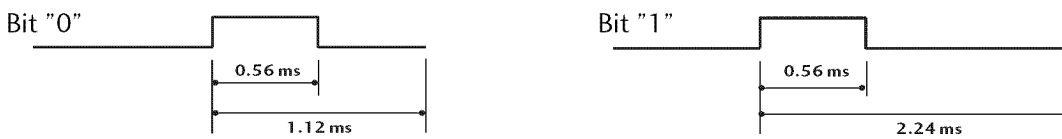

Frame interval: Tf

The waveform is transmitted as long as a key is depressed.

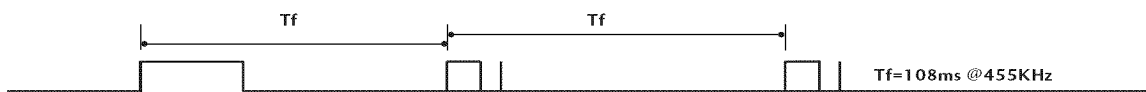

Code (Hexa)	Function	Note	Code (Hexa)	Function	Note
0F	TV INPUT	Remote control Button	BF	COMPONENT1	Discrete IR Code
0B	INPUT	Remote control Button			(Component1 Input Selection)
08	POWER	Remote control Button (Power On/Off)	D4	COMPONENT2	Discrete IR Code
79	RATIO	Remote control Button			(Component2 Input Selection)
0E	TIMER	Remote control Button	D5	RGB-PC	Discrete IR Code
10-19	Number Key 0-9	Remote control Button			(RGB-PC Input Selection)
4C	- (Dash)	Remote control Button	CE	HDMI1/DVI	Discrete IR Code
1A	BACK	Remote control Button			(HDMI1/DVI Input Selection)
09	MUTE	Remote control Button	CC	HDMI2	Discrete IR Code
02	VOL ▲	Remote control Button			(HDMI2 Input Selection)
03	VOL ▼	Remote control Button	76	Ratio 4:3	Discrete IR Code
00	CH ▲	Remote control Button			(Only 4:3 Mode)
01	CH ▼	Remote control Button	77	Ratio 16:9	Discrete IR Code
1E	FAV	Remote control Button			(Only 16:9 Mode)
7E	SIMPLINK	Remote control Button	AF	Ratio Zoom	Discrete IR Code
39	CC	Remote control Button			(Only Zoom1 Mode)
40	▲	Remote control Button			
41	▼	Remote control Button			
07	◀	Remote control Button			
06	▶	Remote control Button			
44	ENTER	Remote control Button			
43	MENU	Remote control Button			
52	SOUND	Remote control Button			
4D	PICTURE	Remote control Button			
5B	EXIT	Remote control Button			
0A	SAP	Remote control Button			
CB	ADJUST	Remote control Button			
E1	BRIGHT -	Remote control Button			
E0	BRIGHT +	Remote control Button			
D6	TV	Discrete IR Code			(TV Input Selection)
C4	POWER ON	Discrete IR Code			(Only Power On)
C5	POWER OFF	Discrete IR Code			(Only Power Off)
5A	AV1	Discrete IR Code			(AV1 Input Selection)
D0	AV2	Discrete IR Code			(AV2 Input Selection)

APPENDIX

EXTERNAL CONTROL THROUGH RS-232C

The RS-232C port allows you connect the RS-232C input jack to an external control device (such as a computer or an A/V control system) to control the TV's functions externally.

- Note: RS-232C on this unit is intended to be used with third party RS-232 control hardware and software. The instructions below are provided to help with programming software or to test functionality using telenet software.

RS-232C Setup

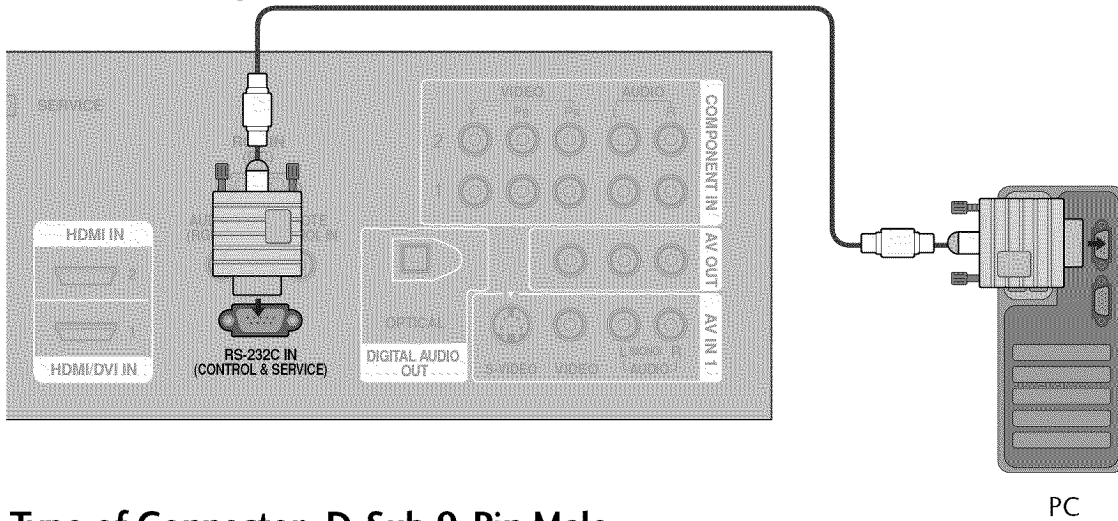

Type of Connector; D-Sub 9-Pin Male

No.	Pin Name
1	No connection
2	RXD (Receive data)
3	TXD (Transmit data)
4	DTR (DTE side ready)
5	GND
6	DSR (DCE side ready)
7	RTS (Ready to send)
8	CTS (Clear to send)
9	No Connection

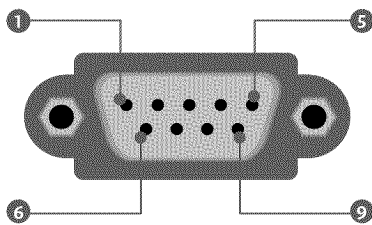

RS-232C Configurations

Either cable below can be used.

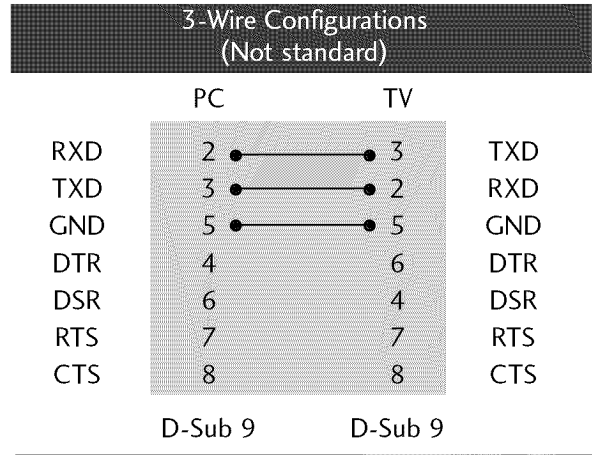
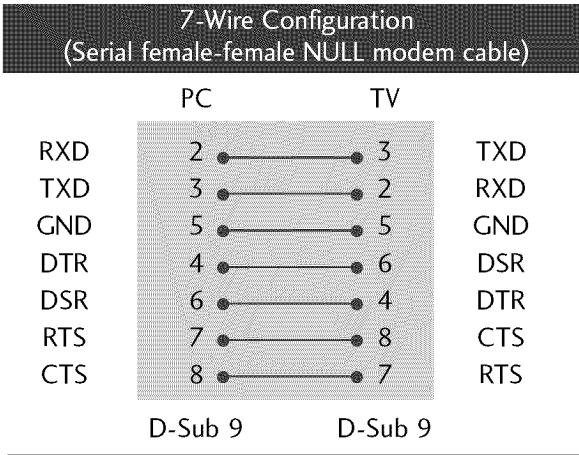

Set ID

Use this function to specify a TV ID number.
Refer to 'Real Data Mapping'. ▶ p.89.

- 1 Press the **MENU** button and then use ▲ or ▼ button to select the **SETUP** menu.
- 2 Press the ► button and then use ▲ or ▼ button to select **Set ID**.
- 3 Press the ► button and then use ▲ or ▼ button to adjust **Set ID** to choose the desired TV ID number. The adjustment range of Set ID is 1~99.
- 4 Press **EXIT** button to return to TV viewing or press **MENU** button to return to the previous menu.

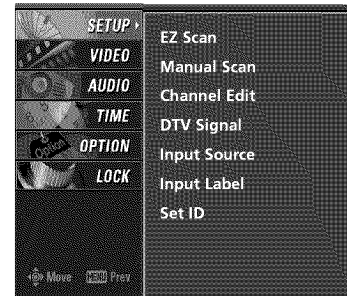
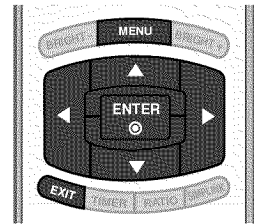

1

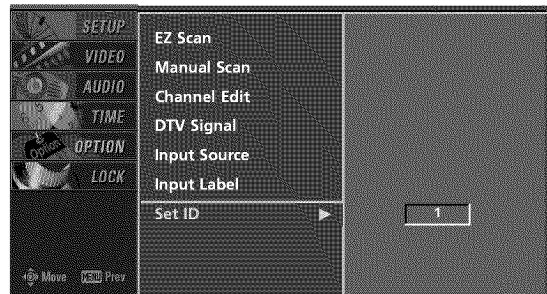

2 3

Communication Parameters

- Baud rate : 9600 bps (UART)
- Data length : 8 bits
- Parity : None
- Stop bit : 1 bit
- Communication code : ASCII code
- Use a crossed (reverse) cable.

NOTE ▶ This product has command echo back in the RS-232C Command.

Command Reference List

	COMMAND1	COMMAND2	DATA (Hexadecimal)		COMMAND1	COMMAND2	DATA (Hexadecimal)
01. Power	k	a	0 ~ 1	11. Sharpness	k	k	0 ~ 64
02. Input Select	k	b	0 ~ 9	12. OSD Select	k	l	0 ~ 1
03. Aspect Ratio	k	c	(▶ p.89)	13. Remote Control Lock Mode	k	m	0 ~ 1
04. Screen Mute	k	d	0 ~ 1	14. Treble	k	r	0 ~ 64
05. Volume Mute	k	e	0 ~ 1	15. Bass	k	s	0 ~ 64
06. Volume Control	k	f	0 ~ 64	16. Balance	k	t	0 ~ 64
07. Contrast	k	g	0 ~ 64	17. Color Temperature	k	u	0 ~ 3
08. Brightness	k	h	0 ~ 64	18. ISM Method	j	p	(▶ p.90)
09. Color	k	i	0 ~ 64	19. Low Power	j	q	0 ~ 1
10. Tint	k	j	0 ~ 64				

Plasma TV Model Only

	COMMAND1	COMMAND2	DATA0 (Hexadecimal)	DATA1 (Hexadecimal)	DATA2 (Hexadecimal)	DATA3 (Hexadecimal)	DATA4 (Hexadecimal)	DATA5 (Hexadecimal)
20. Channel Tuning	m	a	physical program high	major program low	major low	minor high	minor low	attribute
21. Channel Add/Del	m	b	0 ~ 1					
22. Key	m	c	(▶ p.91)					
23. Input Select	x	b	(▶ p.91)					
24. Back Light	m	g	0 ~ 64					

Some LCD TV Model Only

Transmission / Receiving Protocol

Transmission

[Command1][Command2][][Set ID][][Data][Cr]

[Command 1] : First command to control the set.(j, k, m or x)

[Command 2] : Second command to control the set.

[Set ID] : You can adjust the set ID to choose desired TV ID number in Setup menu. Adjustment range is 1~ 99. When selecting Set ID '0', every connected the TV is controlled. Set ID is indicated as decimal (1~ 99) on menu and as Hexa decimal (0x0~ 0x63) on transmission /receiving protocol.

[DATA] : To transmit command data.

Transmit 'FF' data to read status of command.

* In this model, TV will not send the status during the standby mode.

[Cr] : Carriage Return

ASCII code '0x0D'

[] : ASCII code 'space (0x20)'

OK Acknowledgement

[Command2][][Set ID][][OK][Data][x]

The TV transmits ACK (acknowledgement) based on this format when receiving normal data. At this time, if the data is data read mode, it indicates present status data. If the data is data write mode, it returns the data of the PC computer.

* In this model, TV will not send the status during the standby mode.

* Data Format

[Command 2] : Use as command.

[Set ID] : Use the small character, if set ID is 10, it will send the '0', 'a'.

[DATA] : Use the small character, if data is 0 x ab, it will send the 'a', 'b'.

[OK] : Use the large character.

* In this model, TV will send the echo, CR, LF with acknowledgement message.

* When it send the power on acknowledgement message, it will be like below.

ex) ka 01 01 (CR) (LF) a 01 OK 01 x (CR) (LF)

Error Acknowledgement

[Command2][][Set ID][][NG][Data][x]

The TV transmits ACK (acknowledgement) based on this format when receiving abnormal data from non-viable functions or communication errors.

Data1: Illegal Code

Data2: Not supported function

Data3: Wait more time

* In this model, TV will not send the status during the standby mode.

* Data Format

[Command 2] : Use as command.

[Set ID] : Use the small character, if set ID is 10, it will send the '0', 'a'.

[DATA] : Use the small character, if data is 0 x ab, it will send the 'a', 'b'.

[NG] : Use the large character

* In this model, TV will send the echo, CR, LF with acknowledgement message.

* When it send the power on acknowledgement message, it will be like below.

ex) ka 01 01 (CR) (LF) a 01 NG 01 x (CR) (LF)

01. Power (Command: k a)

To control Power On/Off of the TV.

Transmission [k][a][][Set ID][][Data][Cr]

Data 0 : Power Off Data 1 : Power On

Acknowledgement [a][][Set ID][][OK/NG][Data][x]

* In a like manner, if other functions transmit 'FF' data based on this format, Acknowledgement data feedback presents status about each function.

* In this model, TV will send the Acknowledge after power on processing completion.

* There might be a time delay between command and acknowledgement.

02. Input Select (Command: k b)

To select input source for the TV.

Transmission [k][b][][Set ID][][Data][Cr]

Data 0: DTV Data 5: Component 2

Data 1: Analog Data 7: RGB-PC

Data 2: AV1 Data 8: HDMI1/DVI

Data 3: AV2 Data 9: HDMI2

Data 4: Component 1

Acknowledgement [b][][Set ID][][OK/NG][Data][x]

03. Aspect Ratio (Command: k c)

To adjust the screen format.

You can also adjust the screen format using the RATIO button on remote control or in the Option menu.

Transmission [k][c][][Set ID][][Data][Cr]

Data 1: 4:3 5: Zoom 2

2: 16:9 6: Set by program

3: Horizon

4: Zoom 1

Acknowledgement [c][][Set ID][][OK/NG][Data][x]

04. Screen Mute (Command: k d)

To select screen mute on/off.

Transmission [k][d][][Set ID][][Data][Cr]

Data 0 : Screen mute off (Picture on)

Data 1 : Screen mute on (Picture off)

Acknowledgement [d][][Set ID][][OK/NG][Data][x]

05. Volume Mute (Command: k e)

To control volume mute on/off.

You can also adjust mute using the MUTE button on remote control.

Transmission [k][e][][Set ID][][Data][Cr]

Data 0 : Volume mute on (Volume off)

Data 1 : Volume mute off (Volume on)

Acknowledgement [e][][Set ID][][OK/NG][Data][x]

06. Volume Control (Command: k f)

To adjust volume.

You can also adjust volume with the volume buttons on remote control.

Transmission [k][f][][Set ID][][Data][Cr]

Data Min : 0 ~ Max : 64 (*transmit by Hexadecimal code)

Refer to 'Real data mapping' as shown below.

Acknowledgement [f][][Set ID][][OK/NG][Data][x]

07. Contrast (Command: k g)

To adjust screen contrast.

You can also adjust contrast in the Video menu.

Transmission [k][g][][Set ID][][Data][Cr]

Data Min : 0 ~ Max : 64 (*transmit by Hexadecimal code)

Refer to 'Real data mapping' as shown below.

Acknowledgement [g][][Set ID][][OK/NG][Data][x]

08. Brightness (Command: k h)

To adjust screen brightness.

You can also adjust brightness in the Video menu.

Transmission [k][h][][Set ID][][Data][Cr]

Data Min : 0 ~ Max : 64 (*transmit by Hexadecimal code)

Refer to 'Real data mapping' as shown below.

Acknowledgement [h][][Set ID][][OK/NG][Data][x]

09. Color (Command: k i)

To adjust the screen color.

You can also adjust color in the Video menu.

Transmission [k][i][][Set ID][][Data][Cr]

Data Min : 0 ~ Max : 64 (*transmit by Hexadecimal code)

Refer to 'Real data mapping' as shown below.

Acknowledgement [i][][Set ID][][OK/NG][Data][x]

*Real data mapping

0 : Step 0

⋮

A : Step 10 (SET ID 10)

⋮

F : Step 15 (SET ID 15)

10 : Step 16 (SET ID 16)

⋮

63 : Step 99 (SET ID 99)

64 : Step 100

* Tint : R50 ~ G50

* Balance : L50 ~ R50

10. Tint (Command: k j)

To adjust the screen tint.

You can also adjust tint in the Video menu.

Transmission [k][j][][Set ID][][Data][Cr]
Data Red : 0 ~ Green : 64 (*transmit by Hexadecimal code)

*Refer to 'Real data mapping'. ▶ p.89.

Acknowledgement [j][][Set ID][][OK/NG][Data][x]

11. Sharpness (Command: k k)

To adjust the screen sharpness.

You can also adjust sharpness in the Video menu.

Transmission [k][k][][Set ID][][Data][Cr]
Data Min : 0 ~ Max : 64 (*transmit by Hexadecimal code)

*Refer to 'Real data mapping'. ▶ p.89.

Acknowledgement [k][][Set ID][][OK/NG][Data][x]

12. OSD Select (Command: k l)

To select OSD (On Screen Display) on/off.

Transmission [k][l][][Set ID][][Data][Cr]
Data 0: OSD off Data 1: OSD on

Acknowledgement [l][][Set ID][][OK/NG][Data][x]

13. Remote Control Lock Mode (Command: k m)

To lock the remote control and the front panel controls on the set.

Transmission [k][m][][Set ID][][Data][Cr]
Data 0: Lock off Data 1: Lock on

Acknowledgement [m][][Set ID][][OK/NG][Data][x]

If you're not using the remote control and front panel controls on the TV, use this mode. When main power is on/off, remote control lock is released.

14. Treble (Command: k r)

To adjust treble.

You can also adjust treble in the Audio menu.

Transmission [k][r][][Set ID][][Data][Cr]
Data Min : 0 ~ Max : 64 (*transmit by Hexadecimal code)

*Refer to 'Real data mapping'. ▶ p.89.

Acknowledgement [r][][Set ID][][OK/NG][Data][x]

15. Bass (Command: k s)

To adjust bass.

You can also adjust bass in the Audio menu.

Transmission [k][s][][Set ID][][Data][Cr]
Data Min : 0 ~ Max : 64 (*transmit by Hexadecimal code)

*Refer to 'Real data mapping'. ▶ p.89.

Acknowledgement [s][][Set ID][][OK/NG][Data][x]

16. Balance (Command: k t)

To adjust balance.

You can also adjust balance in the Audio menu.

Transmission [k][t][][Set ID][][Data][Cr]
Data Min : 0 ~ Max : 64 (*transmit by Hexadecimal code)

*Refer to 'Real data mapping'. ▶ p.89.

Acknowledgement [t][][Set ID][][OK/NG][Data][x]

17. Color Temperature (Command: k u)

To adjust color temperature.

You can also adjust color temperature in the Video menu.

Transmission [k][u][][Set ID][][Data][Cr]
Data 0: Medium 1: Cool 2: Warm 3: User

Acknowledgement [u][][Set ID][][OK/NG][Data][x]

18. ISM Method (Command: j p)

To avoid having a fixed image remain on screen. (This feature is not available for all models.)

Transmission [j][p][][Set ID][][Data][Cr]
Data 1: Inversion 2: Orbiter

4: White Wash 8: Normal

Acknowledgement [p][][Set ID][][OK/NG][Data][x]

19. Low Power (Command: j q)

To control the low power function on/off.

(This feature is not available for all models.)

Transmission [j][q][][Set ID][][Data][Cr]
Data 0: Low power off 1: Low power on

Acknowledgement [q][][Set ID][][OK/NG][Data][x]

20. Channel Tuning (Command: m a)

To tune channel to following physical/major/minor number.

Transmission [m][a][][Set ID][][Data0][][Data1][][Data2][][Data3][][Data4][][Data5][Cr]

Digital channels have a Physical, Major, and Minor channel number. The Physical number is the actual digital channel number, the Major is the number that the channel should be mapped to, and the Minor is the sub-channel. Since the ATSC tuner automatically maps the channel to the Major number, the Physical number is not required when sending a command.

Data 0: Physical Channel Number

NTSC air: 02~45, NTSC cable: 01, 0E~7D

ATSC air: 01~45, ATSC cable: 01~87

Data1 & 2: Major Channel Number

Data1: High byte Data2: Low byte

Two bytes are available for the Major and Minor, normally only the second byte is used.

Data3 & 4: Minor Channel Number

Not needed for NTSC.

Data5:

7	Main/Sub Picture	6	Two/One Part Channel	5	Using Physical Channel	4	Reserved	3	2	1	0	Step
0	Main	0	Two	0	Use	x		0	0	0	0	NTSC Air
1		1	One	1	No Use	x		0	0	0	1	NTSC Cable
						x		0	0	1	0	ATSC Air
						x		0	0	1	1	ATSC Cable_std
						x		0	1	0	0	ATSC Cable_hrc
						x		0	1	0	1	ATSC Cable_irc
						x		0	1	1	0	ATSC cable_auto
						x		0	1	1	1	Reserved
						x		x	x	x	x	-
						x		1	1	1	1	Reserved

The table above lists the binary code which must be converted to Hexadecimal before sending. For example: The binary code to tune the sub source to an NTSC cable channel is "1000 0001", which translates to "81" in Hex.

- * 7th bit : For which source do you want to change the channel.
- * 6th bit: Use a two part or one part channel. Most cases just use 0 since it's ignored when using NTSC.
- * 5th bit: Use 0 with NTSC since it can only use the physical channel number. Normally use 1 for ATSC since most times it doesn't matter what the physical number is.
- * 4th bit: Set to 0.
- * 3-0 bits: Choose signal type.

* Tune Command Examples:

1. Tune to the analog (NTSC) cable channel 35.
 - Data 0 = Physical of 35 = 23
 - Data 1 & 2 = No Major = 00 00
 - Data 3 & 4 = No Minor = 00 00
 - Data 5 = 0000 0001 in binary = 01
 - Total = ma 00 23 00 00 00 01
2. Tune to the digital (ATSC) local channel 30-3.
 - Data 0 = Don't know Physical = 00
 - Data 1 & 2 = Major is 30 = 00 1E
 - Data 3 & 4 = Minor is 3 = 00 03
 - Data 5 = 0010 0010 in binary = 22
 - Total = ma 00 00 00 1E 00 03 22

```
Acknowledgement[a][ ][Set ID][ ][OK][Data0][Data1][Data2][Data3][Data4][x][a][ ][Set ID][ ][NG][Data0][x]
```

21. Channel Add/Del (Command: m b)

To add and delete the channels

```
Transmission [m][b][ ][Set ID][ ][Data][Cr]
Data 0: Channel Delete Data 1: Channel Add
Acknowledgement [b][ ][Set ID][ ][OK/NG][Data][x]
```

22. Key (Command: m c)

To send IR remote key code.

```
Transmission [m][c][ ][Set ID][ ][Data][Cr]
Data Key code: Refer to page 85.
Acknowledgement [c][ ][Set ID][ ][OK/NG][Data][x]
```

23. Input select (Command: x b)

To select input source for TV.

```
Transmission [x][b][ ][Set ID][ ][Data][Cr]
Data 00 : DTV (Antenna) Data 40 : Component 1
Data 01 : DTV (Cable) Data 41 : Component 2
Data 10 : Analog (Antenna) Data 60 : RGB PC
Data 11 : Analog (Cable) Data 90 : HDMI1/DVI
Data 20 : AV1 Data 91 : HDMI2
Data 21 : AV2
Acknowledgement [b][ ][Set ID][ ][OK/NG][Data][x]
```

24. Back Light (Command: m g)

To adjust screen back light.

(This feature is not available for all models.)

```
Transmission [m][g][ ][Set ID][ ][Data][Cr]
Data Min : 0 ~ Max : 64 (*transmit by Hexadecimal code)
Acknowledgement [g][ ][Set ID][ ][OK/NG][Data][x]
```

LG Electronics Inc.