

website <http://www.lgservice.com>
e-mail <http://www.lgeservice.com/techsup.html>

LG

Window-Type Air Conditioner

OWNER'S MANUAL

LG

ENGLISH

ESPAÑOL

MODELS, MODELOS: LWHD1200HR

IMPORTANT

Please read through this manual. It contains valuable information about your air conditioner. This manual may help save time and money by explaining proper air conditioner maintenance and preventing improper use.

PRECAUTIONS

Pay close attention to precautions in order to prevent potential hazards and damage from misuse or improper installation. LG is not responsible for any damages caused by misuse of the air conditioner.

TABLE OF CONTENTS

Safety Precautions	3
Before Operation	7
Introduction	8
Electrical Safety	9
Installation	11
Operating Instructions	16
Maintenance and Service	20



FOR YOUR RECORDS

Write the model and serial numbers here:

Model # _____

Serial # _____

You can find them on a label on the side of each unit.

Dealer's Name _____

Date Purchased _____

■ Staple your receipt to this page in the event you need it to prove date of purchase or for warranty issues.



READ THIS MANUAL

Inside you will find many helpful hints on how to use and maintain your air conditioner properly. Just a little preventive care on your part can save you a great deal of time and money over the life of your air conditioner.

You'll find many answers to common problems in the chart of troubleshooting tips. If you review our chart of

Troubleshooting Tips first, you may not need to call for service at all.



PRECAUTION

- Contact the authorized service technician for repair or maintenance of this unit.
- Contact the installer for installation of this unit.
- The air conditioner is not intended for use by young children or invalids without supervision.
- Young children should be supervised to ensure that they do not play with the air conditioner.
- When the power cord is to be replaced, replacement work shall be performed by authorized personnel only using only genuine replacement parts.
- Installation work must be performed in accordance with the National Electric Code by qualified and authorized personnel only.

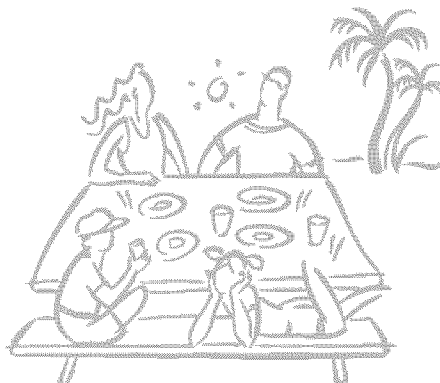

Safety Precautions



To prevent injury to the user or other people and property damage, the following instructions must be followed.

■ Incorrect operation due to ignoring instruction will cause harm or damage. The seriousness is classified by the following indications.

⚠ WARNING This symbol indicates the possibility of death or serious injury.

⚠ CAUTION This symbol indicates the possibility of injury or damage to properties only.

■ Meanings of symbols used in this manual are as shown below.

	Be sure not to do.
	Be sure to follow the instruction.

⚠ WARNING

■ Installation

Don't use a power cord, a plug or a loose socket which is damaged.

- Otherwise, it may cause a fire or electrical shock.

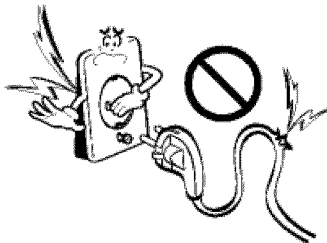

Always plug into a grounded outlet.

- Otherwise, it may cause a fire or electrical shock.

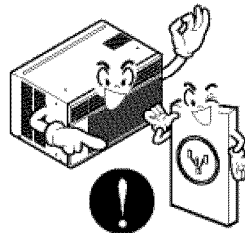

Do not modify or extend the power cord length.

- It will cause electric shock or fire due to heat generation.

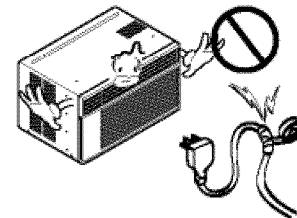

Do not disassemble or modify products.

- It may cause failure and electric shock.

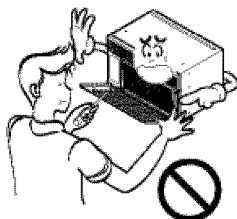

Be caution when unpacking and installing.

- Sharp edges may cause injury.

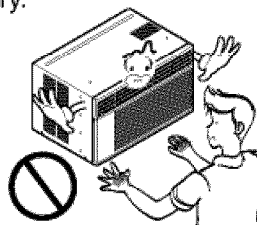

Do not use the power cord near flammable gas or combustibles such as gasoline, benzene, thinner, etc.

- It may cause explosion or fire.

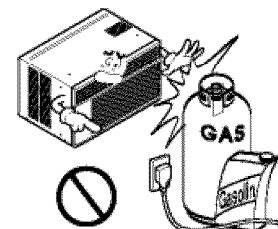

■ Operation

Do not place heavy object on the power cord and take care so that the cord should not be pressed.

- There is danger of fire or electric shock.

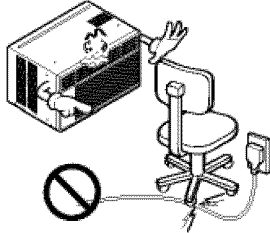

Do not share the outlet with other appliances.

- It will cause electric shock or fire due to heat generation.

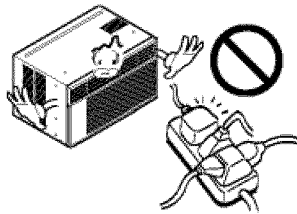

Take the power plug out if necessary, holding the head of the plug and do not touch it with wet hands.

- Otherwise, it may cause a fire or electrical shock.

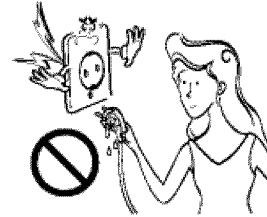

Do not place the power cord near a heater.

- It may cause fire and electric shock.

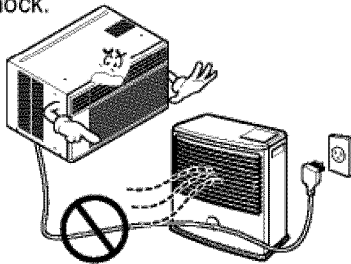

Do not allow water to run into electric parts.

- It will cause failure of machine or electric shock.

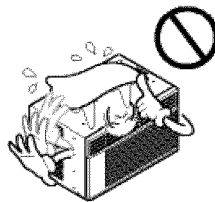

Use a soft cloth to clean. Do not use wax, thinner, or a strong detergent.

- The appearance of the air conditioner may deteriorate, change color, or develop surface flaws.

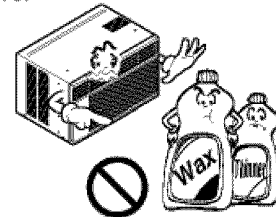

Unplug the unit if strange sounds, odors, or smoke come from it.

- Otherwise it may cause fire and electric shock accident.

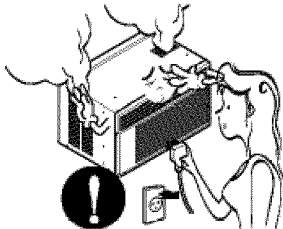

Do not open the suction inlet grill of the product during operation.

- Otherwise, it may electrical shock and failure.

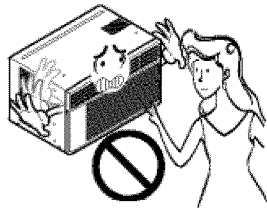

If water enters the product, turn off the the power switch of the main body of appliance. Contact service center after taking the power-plug out from the socket.

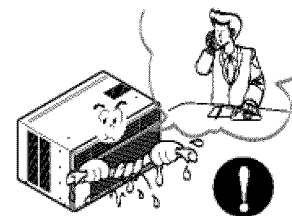

Ventilate the room well when using this appliance together with a stove, etc.

- An oxygen shortage may occur.

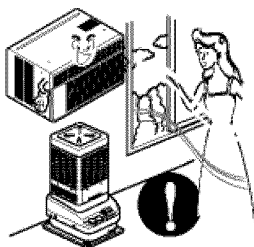

Turn off the power and breaker firstly when cleansing the unit.

- Since the fan rotates at high speed during operation, it may cause injury.

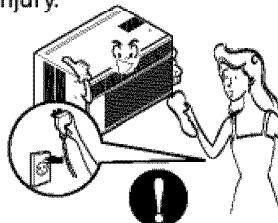

Turn off the main power switch when not using it for a long time.

- Prevent accidental startup and the possibility of injury.

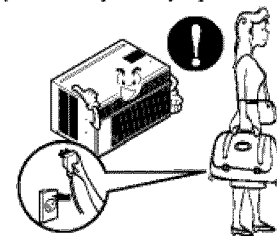

Do not operate or stop the unit by inserting or pulling out the power plug.

- It will cause electric shock or fire due to heat generation.

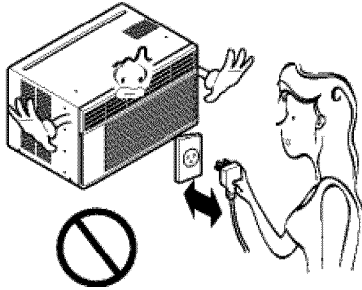

Do not damage or use an unspecified power cord.

- It will cause electric shock or fire.

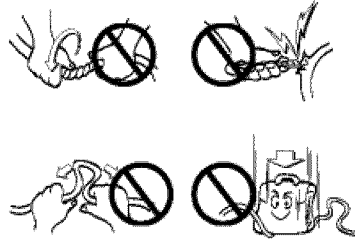

Do not operate with wet hands or in damp environment.

- It will cause electric shock.

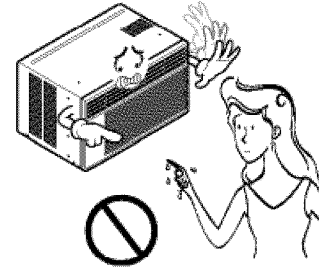

Hold the plug by the head when taking it out.

- It may cause electric shock and damage.

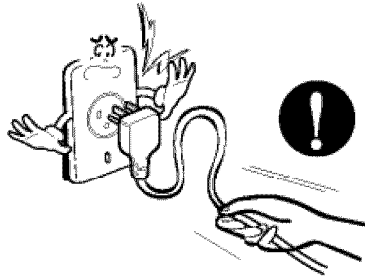

When gas leaks, open the window for ventilation before operating the unit.

- Otherwise, it may cause explosion, and a fire.

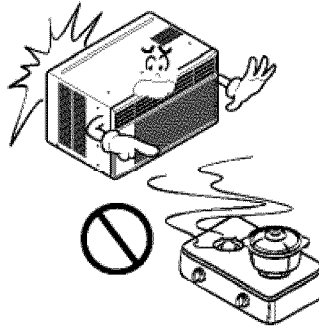

Never touch the metal parts of the unit when removing the filter.

- They are sharp and may cause injury.

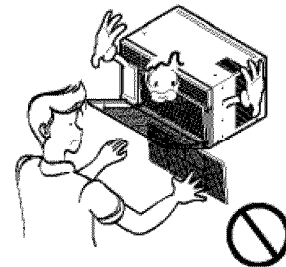

CAUTION

Installation

Install the product so that the noise or hot wind from the outdoor unit may not cause any damage to the neighbors.

- Otherwise, it may cause dispute with the neighbors.

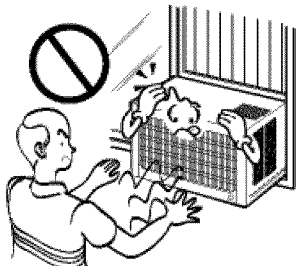

Keep level parallel in installing the product.

- Otherwise, it may cause vibration or water leakage.

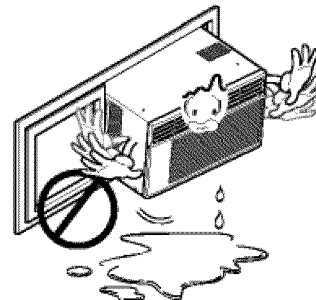

■ Operation

Do not put a pet or house plant where it will be exposed to direct air flow.

- It may cause injury.

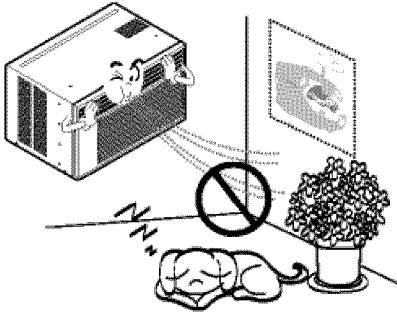

Do not block the inlet or outlet of air flow.

- It may cause product failure.

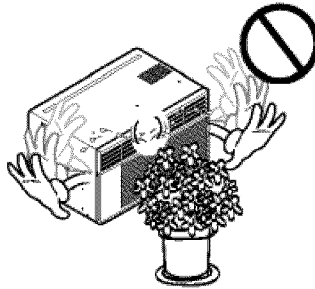

Use a soft cloth to clean. Do not use wax, thinner, or a strong detergent.

- The appearance of the air conditioner may deteriorate, change color, or develop surface flaws.

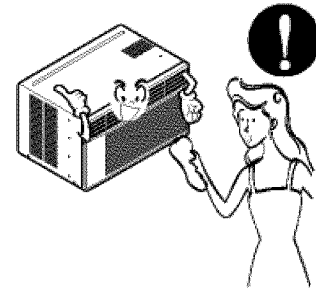

Do not step on the indoor/outdoor unit and do not put anything on it.

- It may cause an injury through dropping of the unit or falling down.

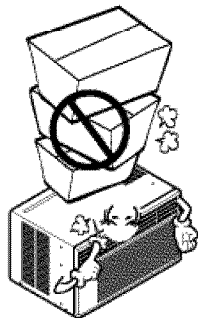

Always insert the filter securely. Clean it every two weeks.

- Operation without filters will cause failure.

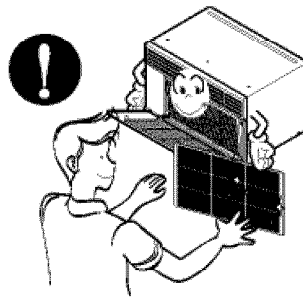

Do not drink water drained from air conditioner.

- It contains contaminants and will make you sick.

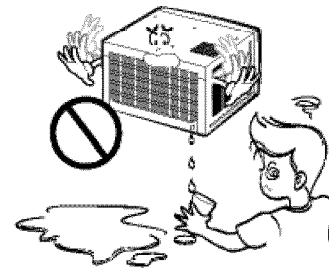

Be cautious not to touch the sharp edges when installing.

- It may cause injury.

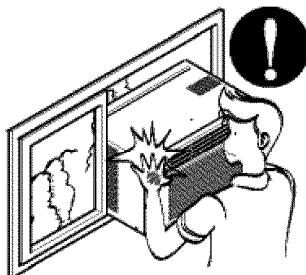

Avoid excessive cooling and perform ventilation sometimes.

- Otherwise, it may do harm to your health.

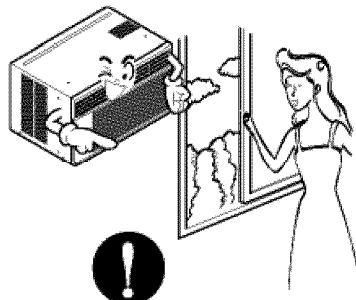

Do not insert the hands or bars through the air inlet or outlet during operation.

- Otherwise, it may cause personal injury.

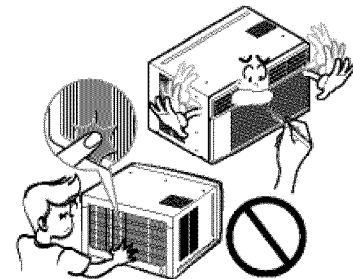

Before Operation

Preparing for Operation

1. Contact an installation specialist for installation.
2. Plug in the power plug properly.
3. Use a dedicated circuit.
4. Do not use an extension cord.
5. Do not start/stop operation by plugging/unplugging the power cord.
6. If the cord/plug is damaged, replace it with only an authorized replacement part.

Usage

1. Being exposed to direct airflow for an extended period of time could be hazardous to your health. Do not expose occupants, pets, or plants to direct airflow for extended periods of time.
2. Due to the possibility of oxygen deficiency, ventilate the room when used together with stoves or other heating devices.
3. Do not use this air conditioner for non-specified special purposes (e.g. preserving precision devices, food, pets, plants, and art objects). Such usage could damage the items.

Cleaning and Maintenance

1. Do not touch the metal parts of the unit when removing the filter. Injuries can occur when handling sharp metal edges.
2. Do not use water to clean inside the air conditioner. Exposure to water can destroy the insulation, leading to possible electric shock.
3. When cleaning the unit, first make sure that the power and breaker are turned off. The fan rotates at a very high speed during operation. There is a possibility of injury if the unit's power is accidentally triggered on while cleaning inner parts of the unit.

Service

For repair and maintenance, contact your authorized service dealer.

Introduction

Symbols Used in this Manual



This symbol alerts you to the risk of electric shock.



This symbol alerts you to hazards that could cause harm to the air conditioner.

NOTICE

This symbol indicates special notes.

Features (Appearance may vary)

▲ WARNING

This appliance should be installed in accordance with the National Electric Code.

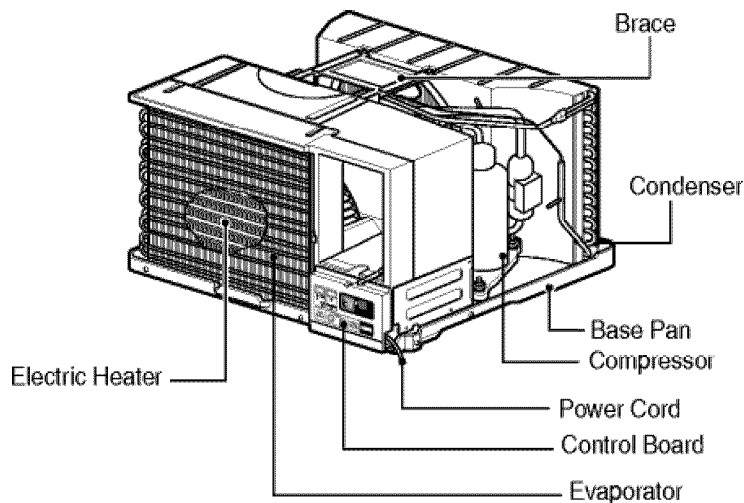
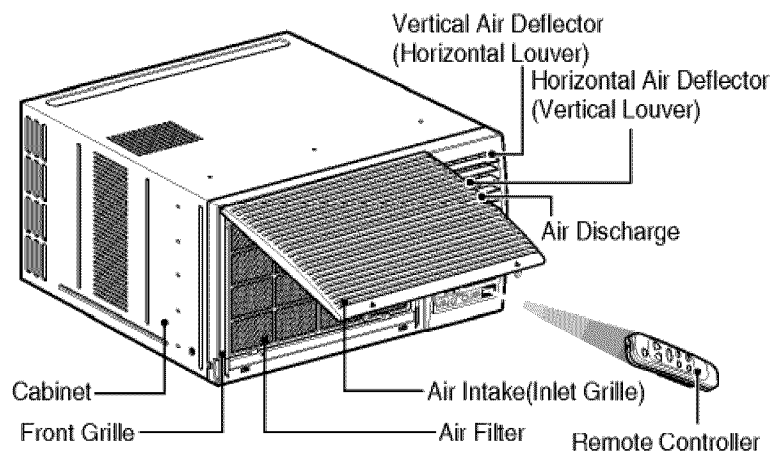

Electrical Safety

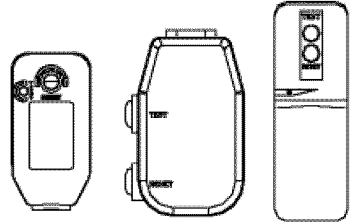
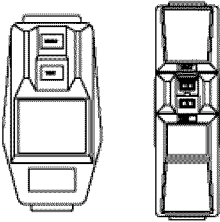

Electrical Data

ENGLISH

115V~	230V~	
		<p>Power cord may include a current interrupter device. A test and reset button is provided on the plug case. The device should be tested on a periodic basis by first pressing the TEST button and then the RESET button. If the TEST button does not trip or if the RESET button will not stay engaged, discontinue use of the air conditioner and contact a qualified service technician.</p>

NOTICE

The shape may be different according to its model.

Use Wall Receptacle	Power Supply
 <p>Standard 125V, 3-wire grounding receptacle rated 15A, 125V AC</p>	<p>Use 15 AMP. time delay fuse or 15 AMP. circuit breaker.</p>
 <p>Standard 250V, 3-wire grounding receptacle rated 15A, 250V AC</p>	
 <p>Standard 250V, 3-wire grounding receptacle rated 20A, 250V AC</p>	<p>Use 20 AMP. time delay fuse or 20 AMP. circuit breaker.</p>

NOTICE

DO NOT USE AN EXTENSION CORD on 230, 208, and 230/208 Volt units.
 All wiring should be made in accordance with local electrical codes and regulations.
 Aluminum house wiring may pose special problems. Consult a qualified electrician.

⚠ WARNING

Never push the test button during operation
Otherwise this plug can damaged.
 This device contains chemical, including lead, known to the State of California to cause cancer, and birth defects or other reproductive harm.
 Wash hands after handling.
 Do not remove, modify or immerse this plug. If this device trips, the cause it to be corrected before further use.

⚠ CAUTION

The conductors inside this cord are surrounded by shields, which monitor leakage current. These shields are not grounded.
 <Made in Tower>
 Periodically examine the cord for any damage. Do not use this product in the event the shields become exposed. Avoid shock hazard, this unit can not be user serviced opening the tamper resistant. Sealed portion of the unit voids all warranties and performance claims. This unit not intended for use as an on-off switch.

Electrical Safety

IMPORTANT (PLEASE READ CAREFULLY)

FOR THE USER'S PERSONAL SAFETY, THIS APPLIANCE MUST BE PROPERLY GROUNDED

The power cord of this appliance is equipped with a three-prong (grounding) plug. Use this with a standard three-slot (grounding) wall power outlet to minimize the hazard of electric shock. The customer should have the wall receptacle and circuit checked by a qualified electrician to make sure the receptacle is properly grounded.

DO NOT CUT OR REMOVE THE THIRD (GROUND) PRONG FROM THE POWER PLUG.

A. SITUATIONS WHEN THE APPLIANCE WILL BE DISCONNECTED OCCASIONALLY:

Because of potential safety hazards, we strongly discourage the use of an adapter plug. However, if you wish to use an adapter, a TEMPORARY CONNECTION may be made. Use UL-listed adapter, available from most local hardware stores.

The large slot in the adapter must be aligned with the large slot in the receptacle to assure a proper polarity connection.

▲ CAUTION

: Attaching the adapter ground terminal to the wall receptacle cover screw does not ground the appliance unless the cover screw is metal, and not insulated, and the wall receptacle is grounded through the house wiring. The customer should have the circuit checked by a qualified electrician to make sure the receptacle is properly grounded.

Disconnect the power cord from the adapter, using one hand on each. Otherwise, the adapter ground terminal might break. DO NOT USE the appliance with a broken adapter plug.

B. SITUATIONS WHEN THE APPLIANCE WILL BE DISCONNECTED OFTEN.

Do not use an adapter plug in these situations. Unplugging the power cord frequently can lead to an eventual breakage of the ground terminal. The wall power outlet should be replaced by a three-slot (grounding) outlet instead.

USE OF EXTENSION CORDS

Because of potential safety hazards, we strongly discourage the use of an extension cord. However, if you wish to use an extension cord, use a CSA certified/UL-listed 3-wire (grounding) extension cord, rated at 15A, 125V.

Installation

How to Install the Unit

1. To prevent vibration and noise, make sure the unit is installed securely and firmly.
2. Install the unit where the sunlight does not shine directly on the unit.
3. The outside of the cabinet must extend outward for at least 12" and there should be no obstacles, such as a fence or wall, within 20" from the back of the cabinet because it will prevent heat radiation of the condenser. Restriction of outside air will greatly reduce the cooling efficiency of the air conditioner.

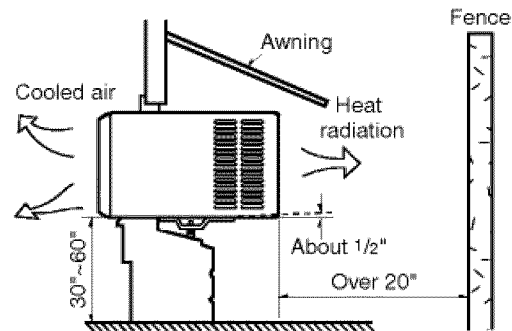

CAUTION

All side louvers of the cabinet must remain exposed to the outside of the structure.

4. Install the unit a little slanted so the back is slightly lower than the front (about $\frac{1}{2}$ "). This will force condensed water to flow to the outside.
5. Install the unit with the bottom about 30"–60" above the floor level.

Window Requirements

NOTICE

All supporting parts should be secured to firm wood, masonry, or metal.

This unit is designed for installation in standard double hung windows with actual opening widths from 27" to 39".

The top and bottom window sash must open sufficiently to allow a clear vertical opening of 16" from the bottom of the upper sash to the window stool.

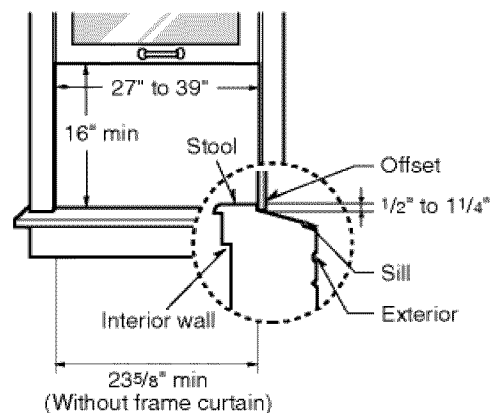

Installation Kits Contents

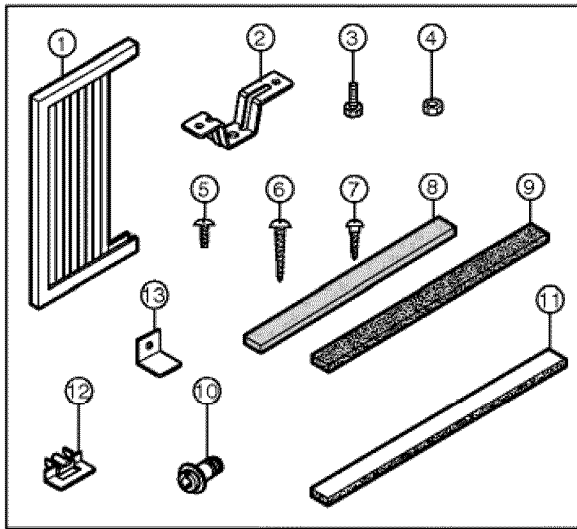

NO.	NAME OF PARTS	Q'TY
1	FRAME CURTAIN	2
2	SILL SUPPORT	2
3	BOLT	2
4	NUT	2
5	SCREW(TYPE A)	16
6	SCREW(TYPE B)	3
7	SCREW(TYPE C)	5
8	FOAM-STRIP	1
9	FOAM-PE	1
10	DRAIN PIPE	1
11	FOAM-PE	1
12	FRAME GUIDE	2
13	WINDOW LOCKING BRACKET	1

Suggested Tool Requirements

SCREWDRIVER(+, -), RULER, KNIFE, HAMMER, PENCIL, LEVEL

PREPARATION OF CHASSIS

1. Remove the screws which fasten the cabinet at both sides and at the back.
2. Slide the unit from the cabinet by gripping the base pan handle and pulling forward while bracing the cabinet.
3. Remove EPS Material.
4. Cut the window sash seal to the proper length. Peel off the backing and attach the foam-pe ⑨ to the underside of the window sash.
5. Remove the backing from the top upper guide Foam PE ⑪ and attach it to the bottom of the upper guide.
6. Attach the upper guide onto the top of the cabinet with 3 type A screws.
7. Insert the frame guides ⑫ into the bottom of the cabinet.
8. Insert the Frame Curtain ① into the upper guide and frame guides ⑫.
9. Fasten the curtains to the unit with 4 Type A screws.

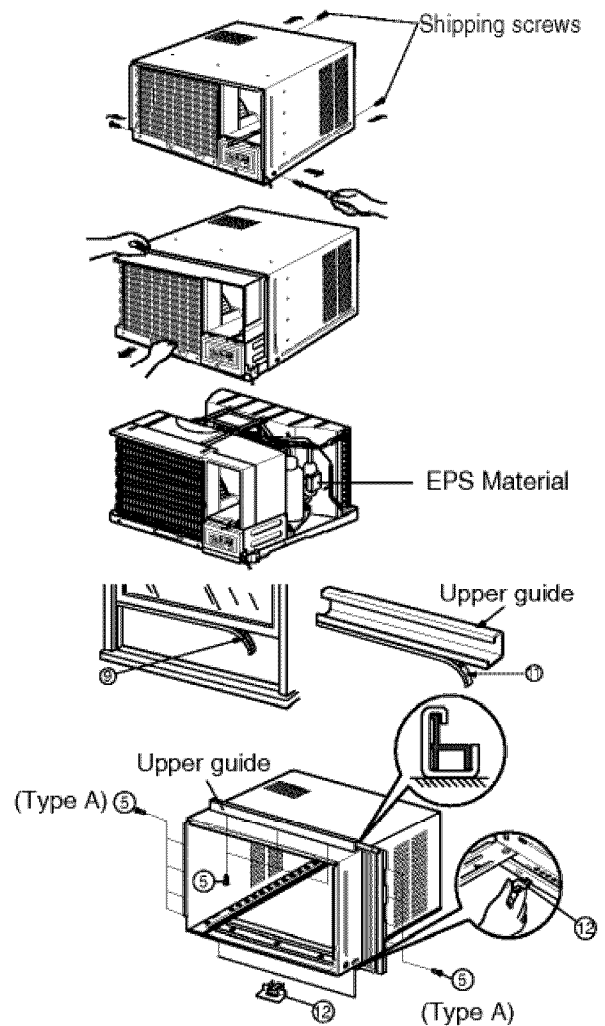

Cabinet Installation

1. Open the window. Mark a line on center of the window stool(or desired air conditioner location).
Carefully place the cabinet on the window stool and align the center mark on the bottom front with the center line marked in the window stool.

2. Pull the bottom window sash down behind the upper guide until it meets.

NOTICE

Do not pull the window sash down so tightly that the movement of Frame Curtain is restricted.

3. Loosely assemble the sill support using the parts in Fig. 3.
4. Select the position that will place the sill support near the outer most point on sill (See Fig. 4)

NOTICE

Be careful when you install the cabinet (frame guides ⑫ are broken so easily).

5. Attach the sill support to the cabinet track hole in relation to the selected position using 2 Type A screws in each support(See Fig. 4).
6. The cabinet should be installed with a very slight tilt(about $\frac{1}{2}$ ") downward toward the outside (See Fig. 5).
Adjust the bolt and the nut of sill support for balancing the cabinet.
7. Attach the cabinet to the window stool by driving the screws ⑥ (Type B: Length sixteen millimeters and below.) through the front angle into window stool.
8. Pull each Frame curtain fully to each window sash track, and repeat step 2.

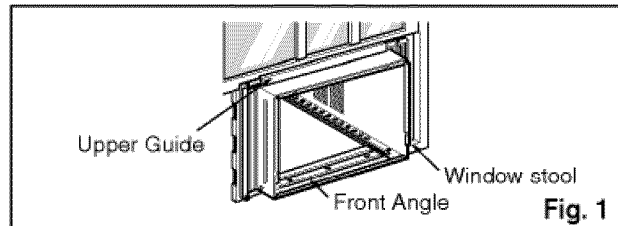

Fig. 1

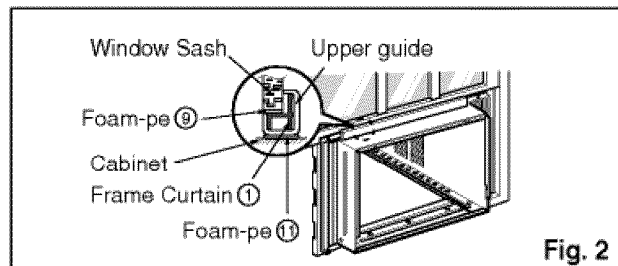

Fig. 2

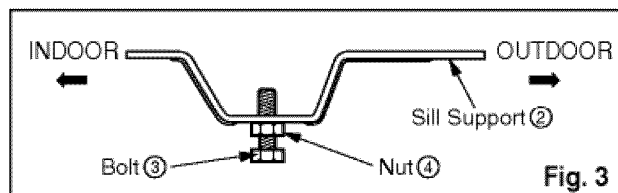

Fig. 3

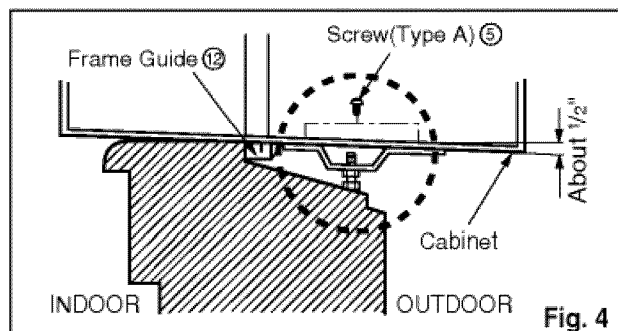

Fig. 4

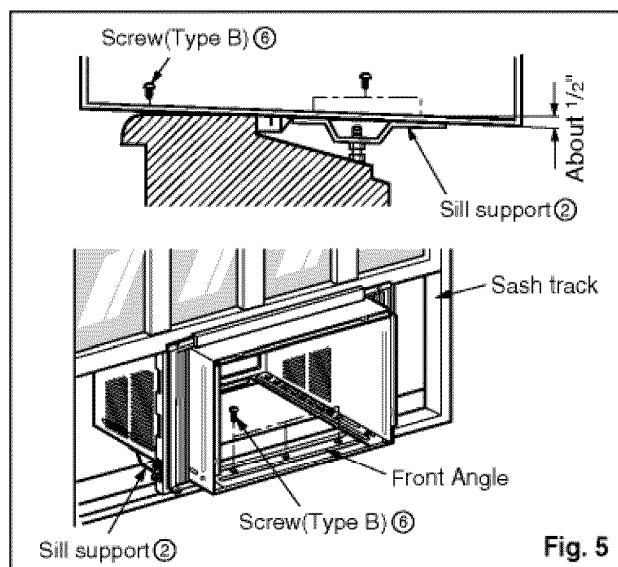

Fig. 5

9. Attach each Frame curtain the window sash using screws ⑦(Type C).(See Fig. 6)

▲ CAUTION

Do not drill a hole in the bottom pan.
The unit is designed to operate with approximately 1/2" of water in bottom pan.

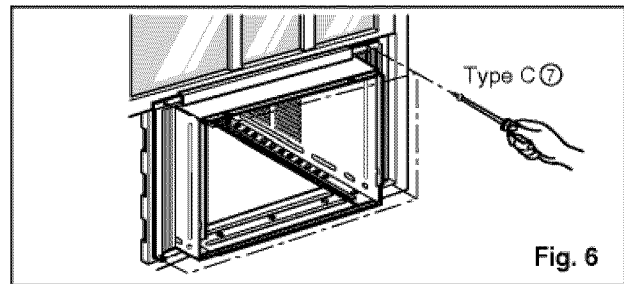

Fig. 6

10. Slide the unit into the cabinet.(See Fig. 7)

▲ CAUTION

For security purpose, reinstall screws(Type A) at cabinet's sides.

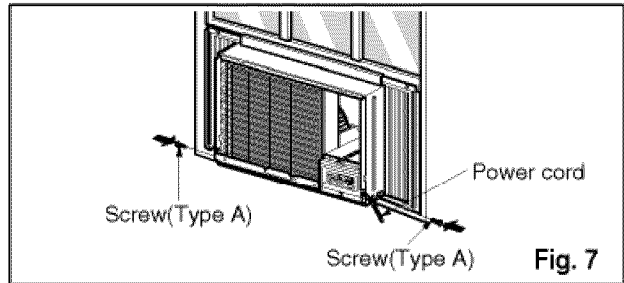

Fig. 7

11. Cut the foam-strip ⑧ to the proper length and insert between the upper window sash and the lower window sash. (See Fig. 8)

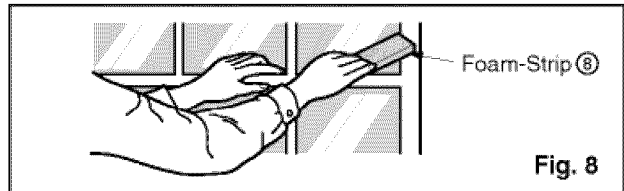

Fig. 8

12. Attach the window locking bracket ⑬ with a type C screw. (See Fig. 9)

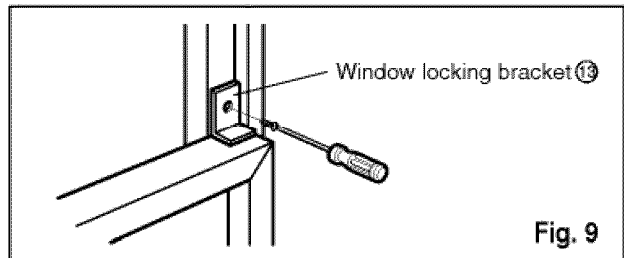

Fig. 9

13. Attach the front grille to the cabinet by inserting the tabs on the grille into the tabs on the front of the cabinet. Push the grille in until it snaps into place. (See Fig.10)

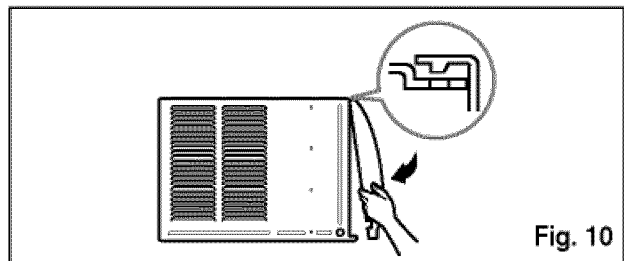

Fig. 10

14. Lift the inlet grille and secure it with a type A screw through the front grille. (See Fig. 11)

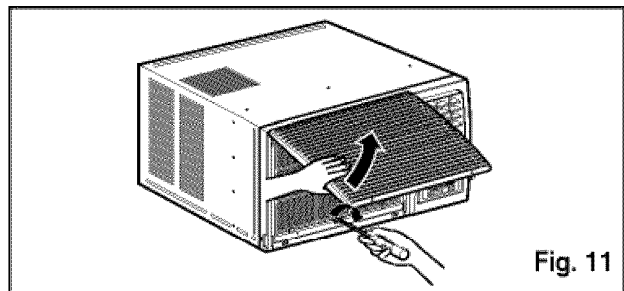

Fig. 11

15. *Window installation of room air conditioner is now completed. See ELECTRICAL DATA for attaching power cord to electrical outlet.*

How to Use the Reversible Inlet Grille

1. If you want to pull out the filter upward, open the inlet grille slightly. Turn inside out the front grille.

Disassemble the inlet grille from the front grille with separating the hinged part by inserting a "—" type screw-driver tip.

Rotate the inlet grille 180 degrees and insert the hooks into the lower holes of front grille.

Then, insert the filter. (See Fig.12, 13)

2. Attach the front grille to the cabinet by inserting the tabs on the grille into the tabs on the front of the cabinet. Push the grille in until it snaps into place. (See Fig.14)

3. Lift the inlet grille and secure it with a type A screw through the front grille. (See Fig. 15)

4. If you want to pull out the filter downward, use the reversible inlet grille without change. (The grille is already assembled for that way.)

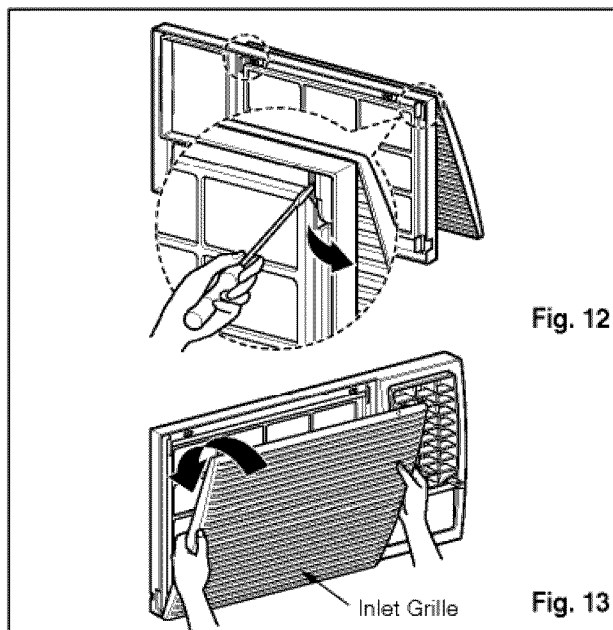

Fig. 12

Fig. 13

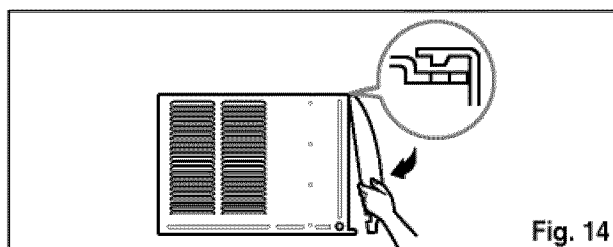

Fig. 14

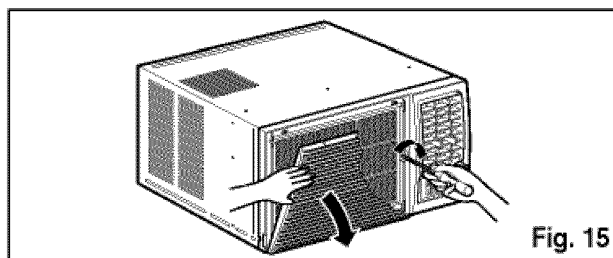
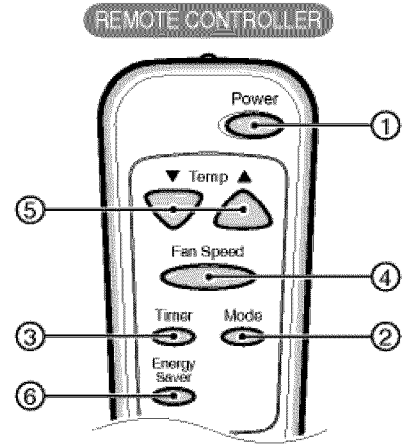
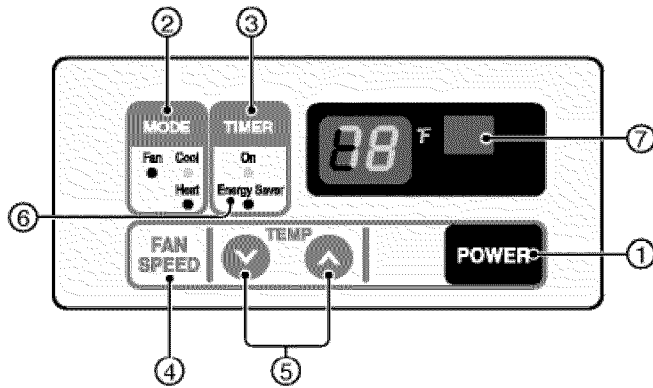

Fig. 15

Operating Instructions

Remote control

The remote control and control panel will look like one of the following pictures.



1. POWER BUTTON

To turn the air conditioner ON, push the button. To turn the air conditioner OFF, push the button again. This button takes priority over any other buttons.

2. OPERATION MODE SELECTION BUTTON

Everytime you push this button, it will toggle COOL, FAN and HEAT.

3. ON/OFF TIMER BUTTON

Everytime you push this button, timer is set as follows. (1Hour → 2Hours → 3Hours → 4Hours → 5Hours → 6Hours → 7Hours → 8Hours → 9Hours → 10Hours → 11Hours → 12Hours → Cancel)

4. FAN SPEED SELECTOR

Everytime you push this button, it is set as follows. (Hi[F2] → Low[F1] → Hi[F2],...)

5. ROOM TEMPERATURE SETTING BUTTON

This button can automatically control the temperature of the room. The temperature can be set within a range of 60°F to 86°F by 1°F.

6. ENERGY SAVER

The fan stops when the compressor stops cooling.

Approximately every 3 minutes the fan will turn on and check the room air to determine if cooling is needed.

7. REMOCON SIGNAL RECEIVER

A slight heat odor may come from the unit when first switching to HEAT after the cooling season is over. This odor, caused by fine dust particles on the heater, will disappear quickly.

AUTO RESTART

When power is restored after an electrical power failure, the unit will begin to run at its last setting.

⚠ CAUTION

When the air conditioner has been performed its cooling operation and is turned off or set to the fan position, wait at least 3 minutes before resetting to the cooling operation again.

How to insert Batteries

1. Remove the cover from the back of the remote controller.
2. Insert two batteries.
 - Be sure that the (+) and (-) directions are correct.
 - Be sure that both batteries are new.
3. Re-attach the cover.

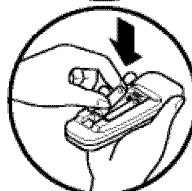
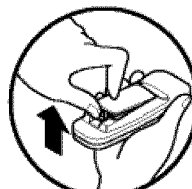

- Do not use rechargeable batteries. Such batteries differ from standard dry cells in shape, dimensions, and performance.
- Remove the batteries from the remote controller if the air conditioner is not going to be used for an extended length of time.

Ventilation

The ventilation lever must be in the CLOSE position in order to maintain the best cooling conditions. When fresh air is necessary in the room, set the ventilation lever to the OPEN position. The damper is opened and room air is drawn out.

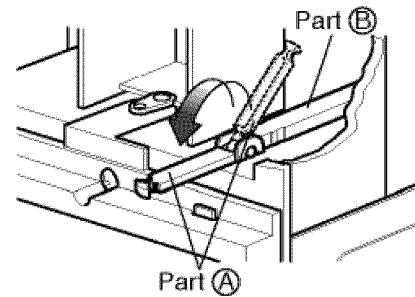
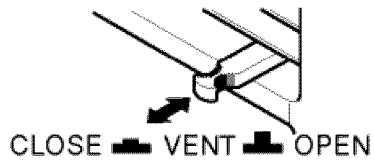

NOTICE

Before using the ventilation feature, position the lever, as shown. First, pull down part **A** to horizontal line with part **B**.

Air Direction

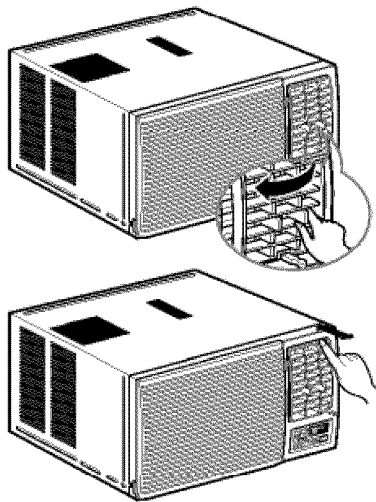

The direction of air can be controlled wherever you want to cool by adjusting the horizontal louver and the vertical louver.

- **HORIZONTAL AIR-DIRECTION CONTROL**

The horizontal air direction is adjusted by rotating the vertical louver right or left.

- **VERTICAL AIR-DIRECTION CONTROL**

The vertical air direction is adjusted by rotating the horizontal louver forward or backward.

How to Attach Drain Pan(Optional)

The air conditioner employs a proper drain method whereby the condensed water (moisture removed from the air) is drained to the outside.

In very humid weather, (and for reverse cycle models in the reverse mode) excessive condensate water removed from the air may cause some water to collect. To remove this excess water you can install the drain pan as detailed below.

1. Take the drain pan which is located in the air discharge.
2. Remove the hole rubber from the base-pan (for some models).
3. Install the drain pan to the right corner of the cabinet with 4 (or 2) screws.
4. Connect the drain hose of 3/5" inside diameter to the outlet located at the bottom of the drain pan. You can purchase the drain hose or tubing locally to satisfy your particular needs. (Drain hose is not supplied).

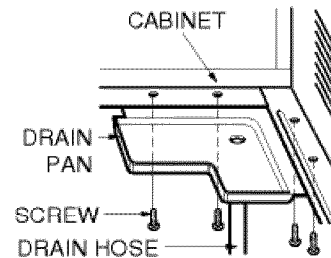

ENGLISH

How to Connect a Drain Hose

A drain hole is provided at the rear of the air conditioner unit.

Select a drain method according to the following.

1. Remove the hole rubber from the base-pan. (for some models)
2. Connect a drain hose of 9/16" inside diameter to the drain pipe as shown in Fig. 1.
3. Or connect a pipe elbow of 9/16" inside diameter to the drain pipe, then connect a drain hose of 9/16" inside diameter to the pipe elbow as shown in Fig. 2.

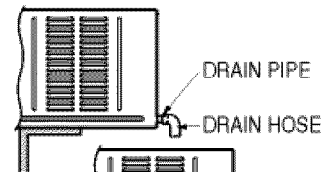

Fig. 1

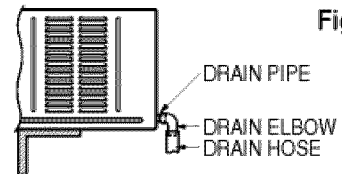

Fig. 2

Maintenance and Service

TURN THE AIR CONDITIONER OFF AND REMOVE THE PLUG FROM THE POWER OUTLET.

Air Filter Cleaning

The air filter should be checked at least twice a month to see if cleaning is necessary. Trapped particles in the filter will build up and block the airflow. This reduces the cooling capacity and also causes an accumulation of frost on the cooling coils.

1. Open the inlet grille upward by pulling out the bottom of the inlet grille.(a)
In another case, you can open the inlet grille downward by pulling out the top of the inlet grille.(b)
2. Remove the air filter from the front grille assembly by pulling the air filter up or down slightly.
3. Wash the filter using lukewarm water below 40°C (104°F).(c)
4. Gently shake the excess water from the filter completely. Replace the filter.

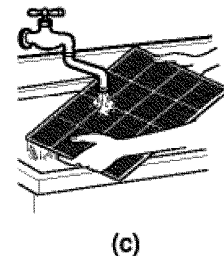
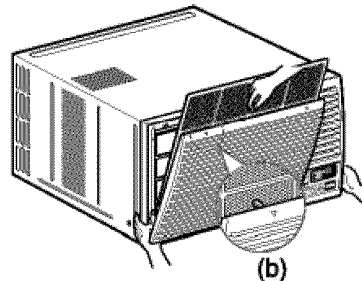
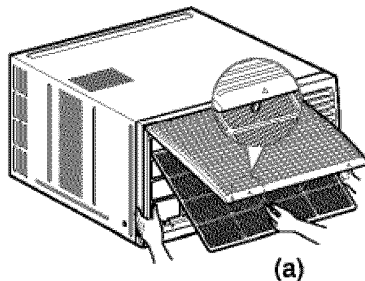

NOTICE

Mark Δ of inlet grille means opening direction.

How to Attach Front Grille to Cabinet

1. Pull down front grille from the cabinet top.
2. Push front grille's tips toward the cabinet in order to insert front grille's tabs into the cabinet.
3. Open the inlet grille.
4. Tighten the screw through the front grille into the plate of the evaporator or base pan.
5. Close inlet grille.

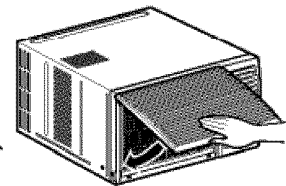
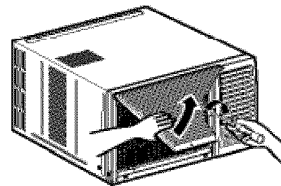
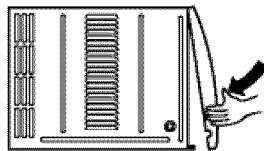
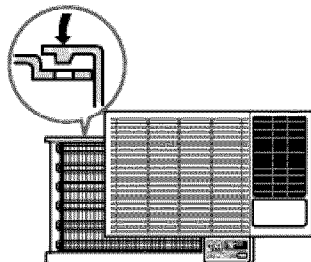

Common Problems and Solutions

Before calling for service, please review the following list of common problems and solutions.

The air conditioner is operating normally when:

- You hear a pinging noise. This is caused by water being picked up by the condenser on rainy days or in highly humid conditions. This feature is designed to help remove moisture in the air and improve cooling efficiency.
- You hear the thermostat click. This is caused by the compressor cycle starting and stopping.
- You see water dripping from the rear of the unit. Water may be collected in the base pan in highly humid conditions or on rainy days. This water overflows and drips from the rear of the unit.
- You hear the fan running while the compressor is silent. This is a normal operational feature.

The air conditioner may be operating abnormally when:

Problem	Possible Causes	What To Do
The air conditioner does not operate at all	■ The air conditioner is unplugged or not plugged in completely	• Make sure the plug is completely plugged into the outlet
	■ The fuse is blown/circuit breaker is triggered	• Check the fuse/circuit breaker box and replace the fuse or reset the breaker
	■ Power failure.	• In the event of a power failure, set the power control to OFF. When the power is restored, wait 3 minutes to restart the air conditioner to prevent the compressor from overloading
	■ The current interrupter device is tripped.	• Press the RESET button located on the power cord plug. If the RESET button will not stay engaged, discontinue use of the air conditioner and contact a qualified service technician.
Air conditioner does not cool	■ Air flow is restricted	• Make sure there are no curtains, blinds, furniture or other obstacles in front of the air conditioner
	■ TEMP Control set too higher number.	• Set the TEMP control to a lower number.
	■ The air filter is dirty.	• Clean the filter at least every 2 weeks. Refer to the "Maintenance and Service" section of the manual.
	■ The air conditioner was just turned on.	• After the air conditioner is turned on, you need to give the air conditioner some time to cool the room.
	■ The room may have been hot.	• When the air conditioner is first turned on you need to allow time for the room to cool down.
	■ Cold air is escaping.	• Check for open furnace floor registers and cold air returns. • CLOSE the air conditioner vent
Ice appears on the air conditioner.	■ Cooling coils are iced up	• See Ice appears on the air conditioner below
	■ The cooling coils are iced over.	• Ice may block the air flow and obstruct the air conditioner from properly cooling the room. • Set the mode control at HIGH fan or high cool with the high temperature.