

MAKE THE MOST
OF YOUR

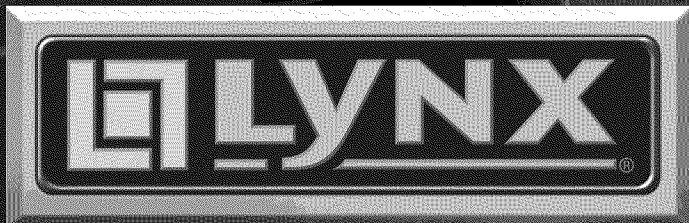

PROFESSIONAL GRILL



CARE & USE/INSTALLATION

A MESSAGE TO OUR CUSTOMERS...

You've just joined the world of Lynx cooks ... a discriminating collection of amateur and professional chefs that take outdoor cooking to a new level.

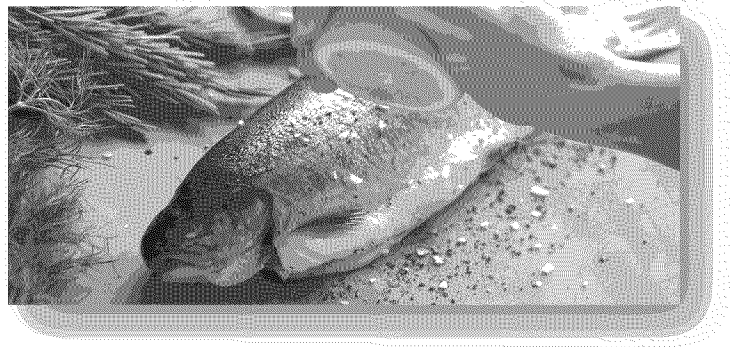

Your grill has been designed and built with meticulous attention to detail and it offers some unique and powerful features. You can achieve maximum performance and enjoyment of these features only by carefully reading the Use & Care manual ... before your first cook-out.

It includes important safety tips, great hints for better grilling and some delectable recipes for you to try. You'll want to keep it handy for easy reference.

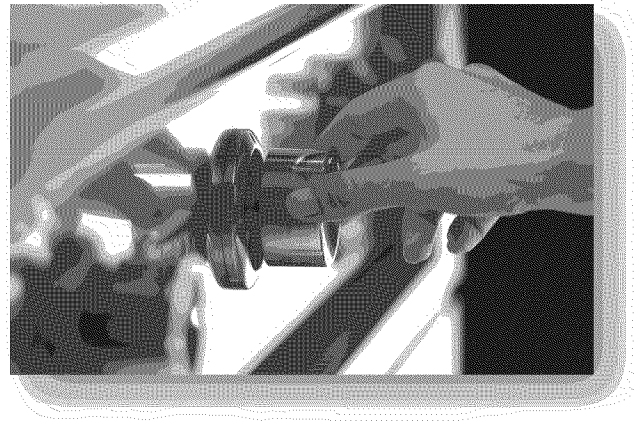

Also, we enjoy hearing from our customers. We like to hear about your successes but also about any difficulties you are having. Please feel free to contact us with any questions or problems, or just to share a new recipe. You never know, your recipe could end up in our next printing of this manual! Please include the model number of your grill in your correspondence.

With the proper use and care this product will provide years of trouble-free service.

Should your Lynx grill change ownership, please make sure that the new owner receives this manual.

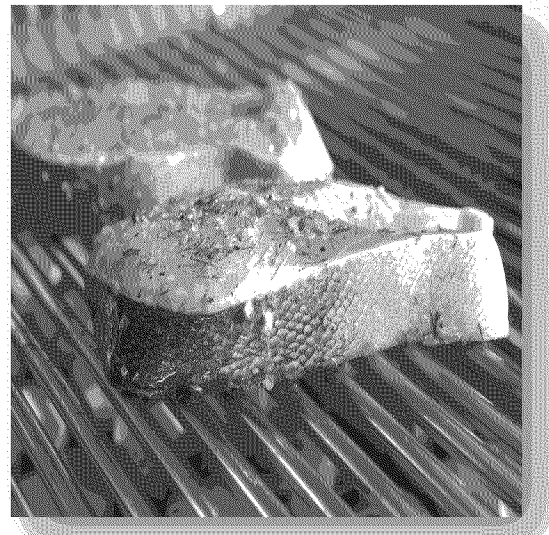

Thanks again for your purchase. Enjoy!

WARNING 

READ THIS MANUAL CAREFULLY and completely before using your grill to reduce the risk of:

- 1) Fire
- 2) Burn hazard, personal injury or property damage
- 3) Ruined steaks or other unpleasant cooking experiences
- 4) Unapproved installation or servicing.

THIS PRODUCT IS DESIGNED FOR OUTDOOR USE ONLY. Improper installation, adjustment, alteration, service or maintenance can cause property damage, injury or death.

Read this manual thoroughly before installation, use, or servicing of this product.

DANGER 

IF YOU SMELL GAS:

- 1) Shut off all gas supply lines to the grill.
- 2) Extinguish any open flames.
- 3) Carefully open lid. Remember, it may be extremely hot!
- 4) If odor continues, keep everyone away from the grill and immediately call your gas supplier or your fire department.

DANGER 

S'IL Y A UNE ODEUR DE GAZ:

- 1) Coupez l'admission de gaz de l'appareil.
- 2) Éteindre toute flamme nue.
- 3) Ouvrir le couvercle.
- 4) Si l'odeur persiste, éloignez-vous de l'appareil et appelez immédiatement le fournisseur de gaz ou le service d'incendie.

WARNING 

- 1) DO NOT store or use gasoline or other flammable vapors and liquids in the vicinity of this or any other appliance.
- 2) An LP cylinder not connected for use shall not be stored in the vicinity of this or any other appliance.

WARNING 

- 1) Ne pas entreposer ni utiliser de l'essence ni d'autres vapeurs ou liquides inflammables dans le voisinage de l'appareil, ni de tout autre appaAn LP cylinder not connected for use shall not be stored in the vicinity of this or any other appliance.
- 2) Une bouteille de propane qui n'est pas raccordée en vue de son utilisation, ne doit pas être entreposée dans le voisinage de cet appareil ou de tout autre appareil.

WARNING! CALIFORNIA PROPOSITION 65 

- 1) The burning of gas cooking fuel generates some by-products which are on the list of substances which are known by the State of California to cause cancer or reproductive harm.
- 2) California law requires businesses to warn customers of potential exposure to such substances. To minimize exposure to the substances, always operate this unit according to the use and care instructions found in this manual. Be certain to provide adequate ventilation when cooking.
- 3) California Proposition 65 lists "Silica, crystalline" which is used in one of the components of the IR burner, as an agent known to the state of California to cause cancer.

WARNING



- 1) Never use dented, rusty or damaged propane cylinders. NEVER store additional or empty propane cylinders in the grill cabinet or in the vicinity of this or any other appliance. Do not store propane cylinders indoors or on their sides.
- 2) Children should NEVER BE LEFT ALONE or unattended in an area where a grill is located. Place your grill well away from areas where children play. Do not store items that may interest children in or around the grill, in the cart, or in the masonry enclosure.
- 3) NEVER move the grill when hot. When in use, portions of the grill are hot enough to cause severe burns.
- 4) Always maintain the required clearances from combustibles as detailed. The grill is designed for outdoor use only. NEVER use in a garage, building, shed, breezeway, or other enclosed area. Do not use this grill under any overhead combustible construction.
- 5) Gas grills are not designed or certified for and are not to be installed in or on recreational vehicles, portable trailers, boats or any other moving installation.
- 6) ALWAYS have an ABC Fire Extinguisher accessible — never attempt to extinguish a grease fire with water or other liquids.
- 7) **STORING YOUR GRILL:** Store your grill in a well-ventilated area. If stored indoors, detach and leave L.P. cylinder outdoors in a well-ventilated area away from heat and away from where children may tamper with it.
- 8) Keep any electrical supply cord and the fuel supply hose away from any heated surfaces. Electrical cords should be placed away from walkways to avoid tripping hazard.
- 9) Do not repair or replace any part of the grill unless specifically recommended in this manual. Other service should be performed by a qualified technician.
- 10) If the grill is installed by a professional installer or technician, be sure that he/she shows you where your gas supply shut-off is located. All gas lines must have a shut-off that is readily and easily accessible. If you smell gas, check for gas leaks immediately. Check only with a soap and water solution. (See INDEX: "Leak Testing" for further details.) Never check for gas leaks with an open flame.
- 11) Inspect the LP gas supply hose prior to each use of the grill. If there is evidence of excessive abrasion or wear, or the hose is cut, it must be replaced before using the grill
- 12) Never remove the grounding prong from the plug or use this product with an ungrounded, 2-prong adapter.
- 13) This manual must remain with the product owner for future reference.

This product complies with ANSI standard Z21.58-2007/CSA 1.6-2007 and has been tested and approved by Intertek.



To obtain replacement parts or service contact:

Lynx Professional Grills
5895 Rickenbacker
Commerce, CA 90040
888-879-2322

TABLE OF CONTENTS

A Message to our Customers.....	2
USE & CARE GUIDELINES	6
<i>Lynx Grill Models</i>	6
Important Safety Precautions.....	7
<i>Grilling in Windy Conditions</i>	8
Using Your Lynx Grill.....	9
<i>Pre-Grill Checklist</i>	9
<i>Lighting Your Grill</i>	10
<i>Basic grilling</i>	12
<i>Using The ProSear™ Burner</i>	13
<i>Using The Rotisserie Burner</i>	14
<i>Using The Smoker Box</i>	15
Cleaning Your Lynx Grill.....	16
Troubleshooting Your Lynx Grill.....	19
<i>Potential Problems</i>	19
<i>How To Obtain Service From Lynx</i>	22
<i>The Lynx Story</i>	22
Warranty.....	23
 INSTALLATION GUIDELINES	 25
Before You Start.....	27
<i>If shipment arrives damaged</i>	27
Unpacking and Assembly.....	30
Electrical Connections.....	31
Gas Connections.....	32
Final Checks.....	34
Side Burner/LPSGE Hookup.....	36
Wiring Schematics.....	37
L27 Non-Rotisserie Grill.....	37
L27 & L30 rotisserie Grill.....	38
L36 & L42 rotisserie Grill.....	39
L54 rotisserie Grill.....	40
2010 Lynx Professional Grills Exploded Parts View.....	41
2010 Lynx Professional Grills Parts list.....	42



USE & CARE GUIDELINES

This use & care manual covers the Lynx grill models listed below.
Some features and options will vary based upon the model that you purchased.

LYNX GRILL MODELS

BUILT-IN	FREESTANDING
L27-2	L27F-2
L27R-2	L27FR-2
L27PSR-2	L27PSFR-2
L30R-1	L30FR-1
L30PSR-1	L30PSFR-1
L36R-1	L36PSFR-1
L36PSR-1	
L42R-1	L42PSFR-1
L42PSR-1	
L54PSR-1	L54PSFR-1

IMPORTANT SAFETY PRECAUTIONS

PLEASE REVIEW THESE IMPORTANT SAFETY PRECAUTIONS BEFORE YOU USE YOUR GRILL.

- 1) **NEVER LEAVE THE GRILL UNATTENDED WHILE COOKING.**
- 2) Ensure all tie-down wires have been removed from the burners.
- 3) Always use caution when operating the grill in a windy area. (See INDEX: "Grilling in Windy Conditions" for further details.)
- 4) Avoid wearing loose-fitting garments or long sleeves while grilling. They could ignite.
- 5) Never touch the grill racks, hood or immediate surrounding metal surfaces with your bare hands while grilling.
- 6) Use an insulated glove or mitt when opening and operating the grill. Always open the grill lid slowly to allow heat and smoke to escape before fully opening.
- 7) The grill hood must be fully opened while lighting the grill. Releasing fuel into a closed grill before lighting will not make it light sooner or more efficiently. It will only risk explosion and personal injury or death. Never lean over hot grill surface or look directly into the grill when attempting to light.
- 8) Do not heat unopened food containers as pressure build-up will cause the container to explode.
- 9) Do not use aluminum foil to line grill racks or drip pans. This will alter the airflow or trap excessive heat in the control area and can melt knobs and ignition modules. Such damage is specifically excluded from your warranty.
- 10) Never use charcoal or any other solid fuel in the grill.
- 11) Cooking excessively fatty meats and oils will cause flare ups. Internal fires or damage caused by them or by the grill being left unattended while cooking are not covered under the terms and conditions of our warranty.
- 12) Never grill without the drip pan in place. Always ensure the drip pan is pushed all the way to the back of the grill. Hot grease can leak downward and produce a fire or explosion.
- 13) Grease is extremely flammable. Let hot grease cool down before attempting to handle or dispose of it. The drip tray should be cleaned of grease on a regular basis.
- 14) Do not use the grill unless a leak check has been performed on all gas connections. (See INDEX: "Leak Test Procedure" for further details.)
- 15) Never operate the grill while under the influence of alcohol or drugs.
- 16) Do not lean on side shelves and never place a load weighing more than 25 pounds on a side shelf.
- 17) If any burner does not light or goes out during operation, turn off all gas control knobs, open the hood and wait five (5) minutes before attempting to re-light.

- 18) Portable LP cylinders: Always shut off the main valve on the LP cylinder after each use.
- 19) Spiders and insects like to nest in the burners, venturis, valves and orifices of a grill, disrupting the gas flow. This very dangerous condition can cause a fire behind the control panel, damaging the grill and risking personal injury. If your grill has been unused for a long time, inspect and clean the burners, venturis, valves and orifices. (See INDEX: "Cleaning the Brass Burner" for further details.)

IMPORTANT!

GRILLING IN WINDY CONDITIONS

Outdoor grills create more heat than interior kitchen ranges. That's how they sear and grill steaks and other foods.

These high-performance burners require a constant, steady supply of fresh air to mix with the fuel. Your Lynx grill pulls air in through the front and vents hot gases out through the rear.

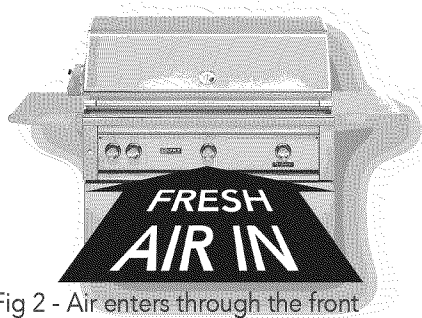

Fig 2 - Air enters through the front

Using your grill in windy conditions may disrupt the front-to-back air flow. If, while grilling with all burners on high and the hood closed,

you notice that the temperature gauge fails to rise ... **be careful**. If wind has kept hot gases from exiting the rear of the grill the control panel and knobs may have become extremely hot.



Fig 3 - Wind hitting the back of the grill can disrupt proper exhaust.

Your Lynx grill features an exclusive, patent-pending Heat Stabilizer that will deflect wind and, in most cases, prevent this situation.

But there are a few things you can do to further **prevent the possibility of improper heat buildup**:

- ▶ On breezy days, be careful not to leave the front hood down for more than 15 minutes when the burners are on high. (Never leave the grill unattended when in operation)
- ▶ If you suspect the grill is overheating, using an oven mitt, open the front hood. Then adjust the burner control knob to a lower setting.
- ▶ Install your grill with a wind break behind it.
- ▶ Orient the grill so prevailing winds are not blowing into the rear of the grill.

Please Note: Any damage caused from use in windy conditions, such as melted knobs or igniter wires, or control panel discoloration from heat buildup, is excluded from warranty coverage.

USING YOUR GRILL

Grilling requires high heat for searing and low, controlled heat for slow cooking.

Thinner cuts of food are often cooked at a "HI" heat setting with the lid open.

On the other hand, large, thick pieces of meat or poultry are often first seared at the *high* setting and then grilled at a *lower setting* ...

sometimes with the lid closed ... achieving the best results in the middle of the food without burning the outside.

Some foods are cooked using direct heat and some using indirect heat.

Your Lynx grill features a variety of professional-level burners and tools for meeting the wide variety of cooking

challenges. We will reveal how these features work for you. So please read and enjoy!

Depending on the model you chose, your Lynx grill may be equipped with up to three different burner types. The operation of each type varies, so it is important to understand all three.

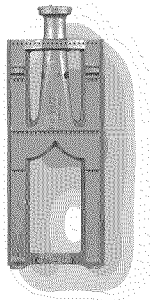

Main Brass Burner

This heavy-duty, durable brass burner is the standard main burner found under the briquette trays.

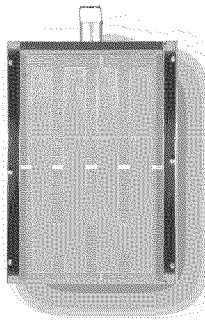

ProSear™ Burner

This advanced infrared burner provides high-intensity infrared heat for searing foods and sealing in flavor.



Rotisserie Burner

This adjustable infrared burner spans the back of the cooking area and provides consistent heat for slow rotisserie cooking.



PRE-GRILL CHECKLIST



BEFORE YOUR *FIRST* USE

There are a few must-check safety precautions to consider before you use your grill. Please be sure that:

- All packing materials and tie-down wires have been removed from the burners.



All internal packaging removed?

- You have fuel connected. (See INDEX: "Gas Requirements" for further details.)

- You have electric connected. (See INDEX: "Electric Requirements" for further details.)

- A qualified plumber has performed a leak test on all the fittings that supply fuel to your grill.

- ▶ **IF YOUR GRILL DOES NOT LIGHT IN 4 TO 5 SECONDS** you may need to purge the line. (See INDEX: "Purging the Gas Line" for further details.)

AT EACH NEW SEASON

At the start of each new grilling season you should remove the grilling racks and briquette trays and check the burners, venturis, orifices and valves for obstructions.

Spiders and insects often nest in these areas of the grill and can disrupt air flow, causing damage to the grill and personal injury.

Also, check all hoses and fittings for damage, abrasion, wear and tear.

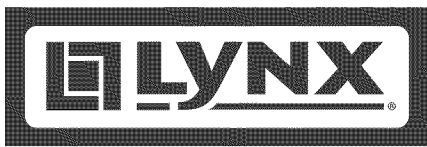

PROFESSIONAL GRILLS

BEFORE EACH USE

Before any use, always make sure that:

- ... you do not smell gas before you light the grill. If you do smell gas, shut everything off and have a qualified plumber check for leaks.
- ... YOU NEVER LEAVE THE GRILL UNATTENDED WHILE COOKING.
- ... the cooking area is free and clear of any combustibles, besides your food, that might ignite.
- ... the control knobs turn freely.
- ... if you are using a portable propane cylinder, it is securely connected and leak tested. (See INDEX: "Cylinder Retention Instructions" for details.)
- ... you know where the main gas supply shut-off is located
- ... the burners are seated properly in the grill with mounting legs in the slots.

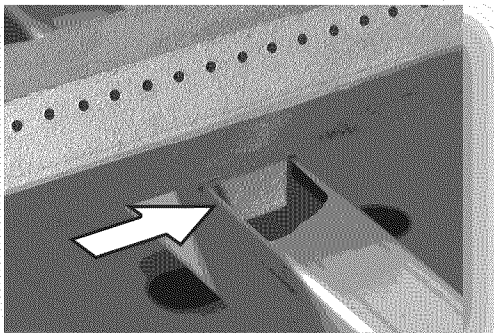

The main burners must sit level and firmly on the frame with their mounting legs inserted into the frame slots.

- ... wind is not blowing too strongly or blowing on the back of grill.

LIGHTING YOUR GRILL

WARNING



- 1) Never attempt to light a burner if you smell gas.
- 2) Always keep the lid open (side-burner lids must be completely removed) when lighting your grill.
- 3) Releasing fuel into a closed grill before lighting will increase the risk of explosion, property damage, personal injury or death.
- 4) Keep your face and body as far from the grill as possible when lighting. Any time a burner doesn't light within 5 seconds, turn off the control, wait 5 minutes for gas to dissipate, and repeat the lighting procedure.

ELECTRIC IGNITION

Before proceeding, make sure you have completed the "Before Each Use" checklist.

Follow these steps to light any of the burners on your grill:

First, make sure all burner control knobs are set to OFF.

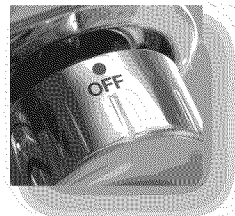

FOR THE MAIN BRASS BURNER or ProSear™ BURNER:

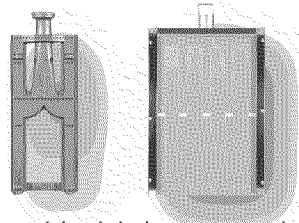

Push and hold the control knob in for 2 seconds, allowing the igniter to heat up. Then rotate the knob to "LITE". After ignition, set the knob to the desired heat setting.

FOR THE ROTISSERIE BURNER:



The rotisserie burner features a thermocouple sensor with a safety valve that automatically shuts off the flow of gas if the burner goes out. (See INDEX: "Windy Conditions" for tips on how to prevent burner blow out)

To light the rotisserie burner, push and hold the control knob in for 2 seconds and then turn the knob to the "LITE" position.

After ignition CONTINUE HOLDING THE CONTROL KNOB IN for 30 to 60 seconds. During this time the thermocouple will heat up and the safety valve will remain open.

If you release the control knob before the thermocouple has heated up, the safety valve will shut off the flow of gas to the rotisserie burner and you will have to re-light the burner.

**COLD WEATHER
WARNING: PROPANE**



Extremely cold temperatures may cause your ProSear™ burner to light *inside* the burner instead of *outside*. Once lit, if you hear a 'whooshing' sound, immediately turn the burner knob off to extinguish the flame and then immediately re-light the burner.

MANUAL LIGHTING

If a burner doesn't light after several attempts, it can be match lit using the lighting rod stored in the drip tray.

Match-lighting your grill is done in one of three ways, depending upon which burners are being lit.

First, make sure you've returned all of the control knobs to the OFF position and have allowed 5 minutes for any accumulated gas to dissipate before attempting to match light a burner.

MANUAL LIGHTING TUBE

Your grill features individual manual lighting tubes for all main burners except for the right-most main burners.

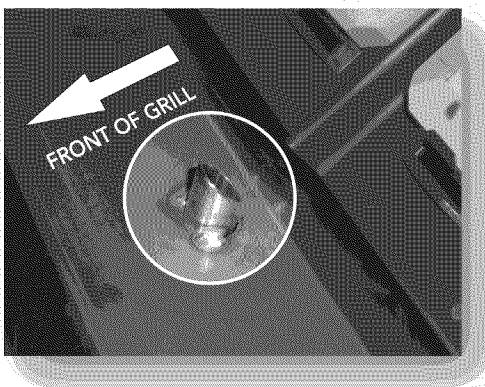

Using the lighting rod, place a lit match in front of the manual lighting tube for the burner you wish to light. (See photo)

Push and turn the corresponding burner control knob to "LITE". If the burner doesn't light within 5 seconds turn the knob off and wait 5 minutes before attempting to light it again. Once lit, gas will stop flowing through the manual lighting tube.

RIGHT-MOST MAIN BURNER

The right-most main burner, does not feature a manual lighting tube.

To match-light this burner, use the lighting rod to insert a lit match through the cooking grate into the front slot of the briquette tray for that burner.

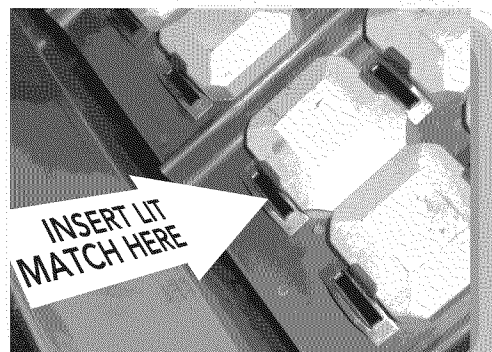

Push and turn the corresponding burner control knob to "LITE". If the burner doesn't light within 5 seconds turn the knob off and wait 5 minutes before attempting to light it again.

ProSear™ BURNER

The ProSear™ burner, does not feature a manual lighting tube.

To match-light this burner, use the lighting rod to insert a lit match through the cooking grate and through the protective screen.

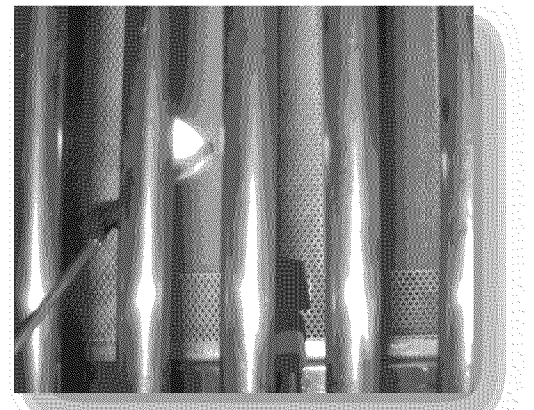

Push and turn the corresponding burner control knob to "LITE". If the burner doesn't light within 5 seconds turn the knob off and wait 5 minutes before attempting to light it again.

BASIC GRILLING

PRE-HEATING

Pre-heating your grill every time you use it is extremely important. Pre-heating allows the briquettes to properly heat up, providing more even and more consistent cooking results.

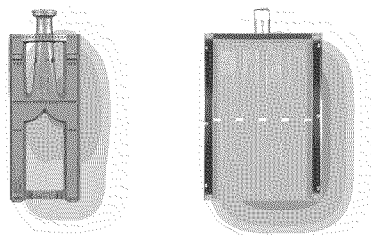

Pre-heat your grill by igniting all main burners, including the ProSear™ burner, and setting them to "HI".

Then close the hood and allow the grill to heat for 10 to 15 minutes. Once you've reached your desired pre-heat temperature, turn off the burners that you won't be using to cook your food.

WARNING!



- ▶ DO NOT LEAVE THE GRILL UNATTENDED DURING THE PREHEAT CYCLE OR AT ANY TIME WHILE THE GRILL IS IN USE.
- ▶ PREHEATING FOR MORE THAN 15 MINUTES MAY OVERHEAT THE GRILL, CAUSING DAMAGE TO THE GRILL.

TYPES OF COOKING

The main brass burners and the ProSear™ burner in your Lynx grill are capable of creating a range of heat intensities. By varying the heat output, the number of burners used and the position of the hood, you can create either direct or indirect heat or a combination of both and develop a wide variety of succulent recipes. There are two basic types of grilling in an outdoor grill... *Direct Heat* and *Indirect Heat*

DIRECT HEAT

Direct heat cooking occurs when foods are placed directly over the heat source. This form of heat is known as "radiant" heat because the heat radiates directly from the source to the food.

Direct heat is a must when you want to sear the outside of your food to seal in flavor. Lynx main brass burners provide the heat necessary to sear foods and seal in flavor.

INDIRECT HEAT

Indirect heat cooking occurs when the food is not close to the heat source. Heat reaches the food via air movement within the cooking area. This form of heat is known as "convection" heat.

Indirect, or "convection" cooking is achieved by placing the food on one side of the grill and igniting burners on the other side. You leave the burner below the food "OFF".

You should keep the hood closed as much as possible during this type of cooking to maintain even heat around the food. You regulate the heat by adjusting the burner, using the hood thermometer to monitor the temperature.

USING THE PROSEAR™ BURNER



Professional restaurant chefs have always relied on a different type of heat ... infrared heat ... to create a higher searing temperature than what standard burners can achieve. So Lynx provides the ProSear™ infrared burner.

Infrared burners work by focusing the gas flame through a ceramic element filled with tiny holes.

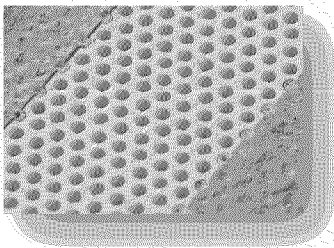

These holes focus the flame on the surface of the

element, creating an intense heat much higher than that of a standard brass burner. It allows you to sear your food more quickly while leaving the inside rare, if desired.

The ProSear™ burner, with its advanced components, requires particular attention to lighting, usage and cleaning guidelines. Refer to INDEX: "Pro-Sear™" for further details..

PREHEATING THE ProSear™ BURNER

Always preheat the entire grill before cooking to achieve consistent, successful results. (See INDEX: "Preheating" for further details.)

If the grill is already hot from

cooking you should still pre-heat the ProSear™ burner for 2-3 minutes, or until it glows red.

Never place food over a ProSear™ burner before it is fully pre-heated because food particles and grease dripping onto a cold ProSear™ burner can clog the tiny ports and damage the burner.

For the same reason you should minimize water spills on the ProSear™ burner and should not use water to control flare-ups. Take special care to minimize dropping any liquids on the ProSear™ burner while cleaning the cooking grids.

HOW TO SEAR

Searing locks in flavor and juices while allowing the food's outer surface to absorb smoke and food-borne aromas produced when drippings are vaporized by the burner.

The result is a restaurant-style finish ... crisp, flavorful outside with a tender, juicy inside.

While the brass burners in your grill are capable of producing searing heat, the ProSear™ infrared burner is specifically designed for this purpose.

SAFETY PRECAUTIONS

Lynx grill cooking grids are heavy duty. Dropping them on the ProSear™ burner will damage the burner. Such damage is not covered by the product warranty and will cause a fire, burns or other personal injury.

ProSear™ CLEANING

It's easy to keep your ProSear™ burner operating at peak performance. Just run it on "HI" with the hood open for 5 minutes after each use to burn away any food particles or drippings.

Any ash accumulation on the burner surface can be removed with a light brush (like a paint brush) or vacuum ... BUT WAIT UNTIL THE BURNER IS COOL!

Be sure to put the protective screen back in place after cleaning. It will prevent damage to the ceramic element that could occur from falling food or other items.

USING THE ROTISSERIE BURNER

Rotisserie cooking provides an even delivery of heat to your foods. It has no equal. The constant rotation not only cooks

foods evenly, it also self bastes. As juices rise to the surface of the food, they naturally flow around it as it rotates. And, by moving the burner out from beneath the food, you avoid scorching flare-ups.

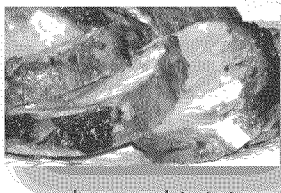

Your foods will be more evenly cooked, more tender and juicier when slow-roasted on a Lynx's rotisserie.

The Lynx rotisserie system consists of four main parts, the motor, the skewer, the forks and the infrared burner.

The Motor



Install the motor by sliding it into one of the slots shown here. Use the top slot for small foods or fast cooking and the lower slot for large foods and slower cooking.

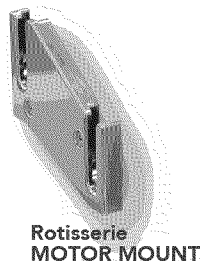

Plug the motor power cord into the motor and into the

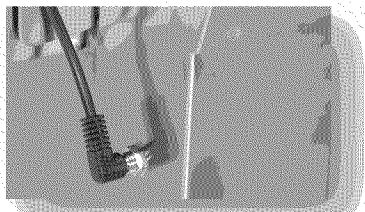

built-in power outlet on the front left grill panel. Your grill must be plugged into an AC power supply for the rotisserie to work.

Place a basting pan in the grill to prevent food accumulations on the briquettes and burners. But **BE SURE YOU REMOVE IT** before using any of the other burners.

The location of the rotisserie burner makes it more susceptible to strong wind conditions (more so than the main grill burners).

For this reason it features a safety valve that automatically closes any time the rotisserie burner is not properly lit ... like if it were to extinguish in windy conditions. During windy conditions, it's best to keep the lid closed and to periodically check the burner.

The Skewer & Forks



The rotisserie can handle large food items. You should prepare any item and first mount it on the skewer.

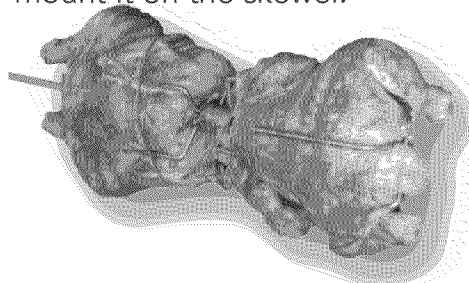

Swing the warming rack up and out of the way. It will rest in place.

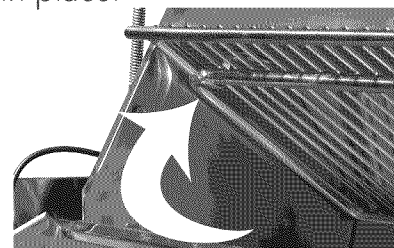

Then mount the skewer on the grill before lighting the rotisserie infrared burner. Lighting the burner first could result in burning your hands while trying to mount the skewer on the grill.

It's okay to remove the grill racks and even the briquette trays to make room for large foods on the skewer.

To load the skewer, slide one of the forks onto the skewer. Push the skewer through the center of the food, then slide the second fork onto the skewer. Center the food to be cooked on the skewer then push the forks firmly together. Tighten the thumb screws (use pliers if necessary). You should wrap any loose, dangling pieces of food (like wings) with butcher's string (never use nylon or plastic string).

With the food secured to the skewer slowly roll the skewer in the palms of your hands to check for balance. It should rotate smoothly. If you find it has a heavy side, adjust where the skewer pierces the meat. An unbalanced skewer will cause uneven rotation and uneven cooking. It's normal for the skewer to flex with large foods.

Slide the pointed end of the skewer into the motor and rest the other end on the rollers on the other side of the grill.

The notched portion of the skewer must rest on the rollers for proper operation.

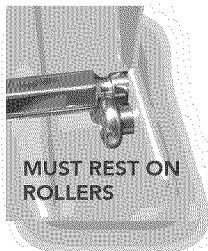

The Rotisserie Burner



To light the rotisserie infrared burner, first mount the skewered food item on the grill then follow the rotisserie lighting procedure. (See INDEX: "Rotisserie Burner, Lighting" for further details.)

Once lit, the rotisserie burner should reach cooking temperatures in about 1 minute. It will glow evenly across its surface in about 5 minutes.

NOTE: The grill thermometer should not be used for rotisserie cooking. It is not designed to read direct infrared heat.

If the burner will not stay lit when you release the control knob, re-light it and hold the control knob in for at least 60 seconds to allow the thermocouple to heat up.

If, after holding the control knob in for at least 60 seconds, the burner still will not stay lit when releasing the control knob, call for service.

(See INDEX: "Obtaining service from Lynx" for further details.)

USING THE SMOKER BOX

Professional chef's far and wide set their restaurant cuisine apart by cooking over wood fires. Imparting a delicate hint of wood smoke enhances food, raising your culinary skills to the next level.

Now you can impart that same culinary touch using the Lynx smoker/steamer accessory.

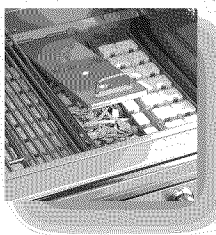

The smoker box will rest directly on the grill frame, beneath the main racks.

double as a steamer box, filling it with water instead of wood. Whether smoking or steaming though, keep the hood closed as much as possible to maximize the effect.

A high quality meat thermometer is a good thing to have when smoking your foods because cooking times can vary greatly from one food to the next and from one day to the next.

Wood Chips

There are many wood chips available and selection is based on personal taste. The most common woods used are mesquite or hickory.

Soak the chips in water for at least 30 minutes before putting them on the slotted rack in the box. That will slow their burning and provide more smoke.

Extended cooking times, such as with large roasts, may require adding wood chips and water to the box several times. Try to limit the number of times you open the hood, as each opening can add as much as 15 minutes to the cooking time.

Use high heat to start the chips smoking, then reduce the heat to prevent them from drying out and flaming up.

The smoker box can also

CAUTION:

Handle the smoker box with care. The cover becomes extremely hot when in use. Use sturdy, properly insulated gloves or dry pot holders.

CLEANING YOUR GRILL

STAINLESS STEEL

Lynx products are known for their attractive appearance. We achieve this by selecting only the finest grades of stainless steel and applying exacting workmanship.

In order to maintain this attractive appearance over the life of the grill it is important to take the following steps:

- ▶ After each use wipe down the exterior of the grill to remove grease and splatters.
- ▶ Be sure to follow the cleaning instructions for keeping the grates and burners clean and ready for use.
- ▶ Use a commercially available Stainless Steel cleaner to clean and polish the exterior surfaces.

Doing these things on a regular basis minimizes the amount of effort required.

Part of the appeal of your Lynx Grill is the fine grain finish. When removing stubborn stains:

- ▶ Do not use metallic abrasives and always rub in the direction of the grain.

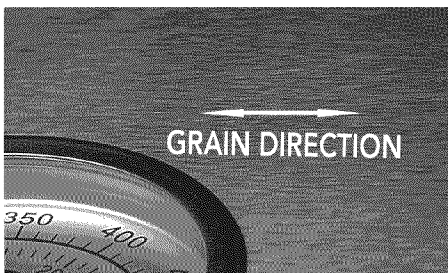

- ▶ Some household cleaning products are not suitable for stainless steel; be sure to read the label before using on your Lynx Grill.

- ▶ Always use the mildest cleaning solution first, scrubbing in the direction of the grain. Specks of grease may gather in the grain of the stainless steel and bake on to the surface, giving the appearance of rust.

To remove these baked-on foods use a fine to medium grit non-metallic abrasive pad (Scotch Brite is good) in conjunction with a stainless steel cleaner.

- ▶ **Solutions used for cleaning concrete and masonry can be very corrosive and will 'attack' stainless steel. Ensure your Lynx products are well protected before you allow the use of such chemicals near your grill.**

SPECIAL NOTE FOR LOCATIONS NEAR POOLS AND COASTAL AREAS

The 304 stainless steel material used in the construction of a Lynx Grill is highly rust resistant, however, chlorine in the air from swimming pools or the salt from sea air may cause surface rust to appear and even create some pitting if left on the product.

Here are a few tips to avoid this:

- ▶ Regularly wipe down the exterior surfaces with a damp cloth. (Micro fiber cloths such

as Ecloth perform very well).

- ▶ Allow the surfaces to dry before installing the cover. –do not cover a damp grill.

- ▶ In extreme environments apply a rust inhibitor which leaves a microscopic protective layer on the grill. Products that provide a layer of vapor corrosion inhibitors (VpCI™) protect the surface very well.

- ▶ For seasonal storage use the product referred to above, ensure the grill is dry and then cover and secure the cover to minimize the amount of damp air getting to the surfaces.

THE Lynx LIMITED LIFE TIME WARRANTY PROVIDES PROTECTION AGAINST RUST-THROUGH OF PARTS THAT RENDER THE PRODUCT INOPERATIVE. IT DOES NOT COVER OCCASIONAL SURFACE RUST OR STAINING DUE TO ENVIRONMENTAL CONDITIONS.

After your first use certain areas of the grill may discolor from the intense heat given off by the burners - this is normal and cannot be cleaned off.

For light and heavy food stains there are many different stainless steel cleaners available.

DRIP TRAY

The drip tray should be cleaned after each use. After the grill is completely cool, remove the drip tray by pulling it out until it stops, then lifting the front edge until the drip tray comes free.

Clean it with hot soapy water or an oven-style cleaning product and re-install.

Also, check the tray after rain. If you've left the grill uncovered, you may need to remove the drip tray drain plug to drain the water from the tray. The drain plug can be removed with a flat-head screwdriver.

WARNING 

DO NOT ALLOW EXCESS GREASE OR LIQUIDS TO ACCUMULATE IN THE DRIP TRAY AS THIS MAY CREATE A FIRE HAZARD.

NEVER USE GRILL WITHOUT DRIP TRAY PROPERLY INSTALLED

GRILLING RACKS

The easiest way to clean the grill racks is to do so immediately after turning off the burners, while they are still hot. Wearing a long BBQ mitt to protect your hand from steam, dip a brass bristle brush in hot water and scrub the grill rack. Dip the brush frequently because the steam helps remove baked-on foods.

CERAMIC BRIQUETTES

The ceramic briquettes normally burn off any accumulated food drippings. But you may occasionally experience larger spills that don't burn off under normal use.

When this happens, let the grill cool completely.

Remove the racks and then the briquette trays by lifting the front edge and pulling them toward you.

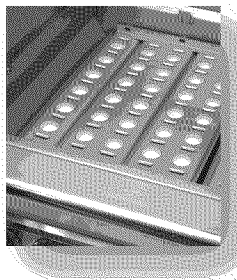

Flip the trays over and put them back in place over the burner. Light the burners and set them to "HI" for 5 - 10 minutes

to burn the briquettes clean. Any remaining food items can be brushed off using a soft brush.

Be sure the trays have completely cooled before reinstalling them.

Replacement briquette trays can be ordered from Lynx or from your dealer.

MAIN BRASS BURNERS

Make sure the grill is completely cool before proceeding.

Ensure that the gas supply is off and all control knobs are in the "OFF" position.

To Remove Brass Burners:

- 1) Remove the grill racks and briquette trays.
- 2) Lift the burner up until the legs exit the frame.

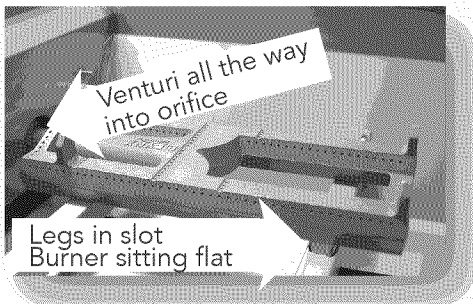

- 3) Then pull to the rear of the grill so the burner head comes off the brass orifice at

the front.

- 4) Angle the burner sideways and lift it out.

Be careful not to change the air shutter position.

To Clean the Brass Burner:

To maximize grill performance, clean the exterior of the burner with a wire brush. Remove stubborn scale with a metal scraper.

Clear any clogged ports with a straightened paper clip. Never use a wooden toothpick as it may break off and clog the port.

Shake out any debris through the air shutter.

Use a flashlight to inspect the burner inlet to ensure it is not blocked. If obstructions can be seen, clean it with a paper clip or a pipe cleaner.

WARNING 

PROPER PLACEMENT OF EACH BURNER IS CRITICAL. AFTER CLEANING THEY MUST BE CENTERED ON THE BRASS ORIFICE, RESTING LEVEL WITHOUT ANY ROCKING.

FAILURE TO MEET THESE CONDITIONS MAY CAUSE A VERY DANGEROUS CONDITION THAT CAN CAUSE PERSONAL INJURY AND PROPERTY DAMAGE.

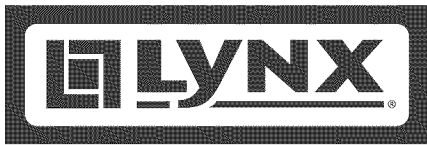

PROFESSIONAL GRILLS

PROSEAR™ BURNER

It's easy to keep your ProSear™ burner operating at peak performance. Just run it on "HI" with the hood open for 5 minutes after each use to burn away any food particles or drippings.

Any ash accumulation on the burner surface can be removed with a light brush or vacuum ... BUT WAIT UNTIL THE BURNER IS COOL!

Every 3 to 6 months, remove the burner (it's held in place by a set-screw) and inspect the venturi (inlet) and orifice to ensure that they're free of obstructions.

Food debris on the inside of the burner can be gently shaken out. Do not touch the ceramic surface.

Clean any obstructions with a straight piece of metal coat hanger, pipe cleaner or paper clip.

When re-installing the ProSear™ burner, be sure to correctly position the burner and the protective screen.

TROUBLESHOOTING YOUR GRILL

BEFORE YOU CALL:

Please check a few things before you call for service:

- ▶ Is there fuel supplied to the grill?
- ▶ Is the main shut-off valve open?
- ▶ Are you using correct type of fuel? (LP or Natural Gas) (See INDEX: "Gas Requirements" for further details.)
- ▶ Is your propane cylinder empty? Have you recently refilled the propane cylinder? If so, is the connection tight?
- ▶ Have you opened the valve on the propane cylinder?
- ▶ Is the grill plugged in to a live electric circuit?

If you've checked the above items, review the trouble-shooting list below before calling for Lynx for service.

POTENTIAL PROBLEMS

GRILL WON'T LIGHT

Your Lynx grill uses an electric ignition system that does not spark. The igniters should glow constantly when a control knob is pushed in. First, confirm that the grill is getting electricity by turning on the lights.

- ▶ CHECK THE IGNITERS
 - Ensure that all burner controls are set to OFF.
 - Remove the racks and briquette trays.
 - Watch an igniter as you push in and hold the corresponding control knob. You will need either a small mirror or shiny metal object to see the igniter under its cover.

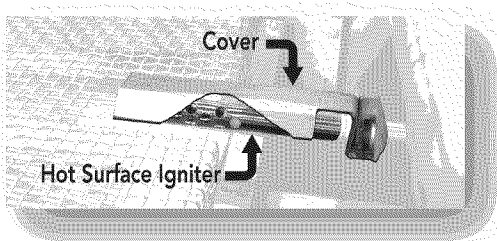

(Be sure you push in the correct control knob and keep the knob in the "OFF" position)

- Check the remaining igniters. If igniters don't glow, proceed with troubleshooting or match-light the burner.

▶ CHECK THE BURNERS

If the igniters are working check to see if gas is reaching the burners by attempting to match light a burner.

BE CAREFUL! IF THE BURNER FAILS TO IGNITE, WAIT 5 MINUTES BEFORE ATTEMPTING TO IGNITE OTHER BURNERS! (See INDEX: "Match Lighting" for further details.)

If match lighting doesn't work, re-check fuel connections for leaks and ensure the supply is of the correct type and is of adequate

pressure. (See INDEX: "Leak Test" for further details.)

If the burner will light with a match, then the igniter may not be functioning correctly. Call for service.

If the burner will not match light, and you know you are getting gas, wait for any gas to dissipate and remove the burner and check it for blockages. (See INDEX: "Clean the Brass Burner" for further details.)

YELLOW FLAME OR GAS SMELL WHILE COOKING

IF YOU SMELL GAS WHILE THE GRILL IS OPERATING, IMMEDIATELY TURN OFF ALL BURNERS AND SHUT OFF THE MAIN FUEL SUPPLY.

- ▶ PERFORM A LEAK TEST (See INDEX: "Leak Test" for further details.)
- ▶ CHECK FOR BLOCKAGES (See INDEX: "Clean the Brass Burner" for further details.)

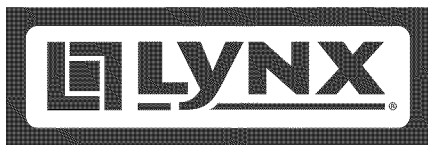

PROFESSIONAL GRILLS

A yellow flame on the main burners indicates a lack of air. But, if the air around the grill is dusty or if heavy grease is present, some orange tips on the burner flame are normal.

▶ ADJUST THE AIR SHUTTER

To adjust for insufficient air, adjust the air shutter. (See INDEX: "Air Shutter Adjustment" for further details.)

LOW OR INSUFFICIENT HEAT

NO PART OF THE GRILL SHOULD EVER BE LINED WITH ALUMINUM FOIL. Doing so will interfere with airflow and can cause a low heat condition.

Ensure that you've preheated the main burners for at least 10 to 15 minutes with the hood closed and the ProSear™ burner for 3 minutes.

Proper leveling during installation is critical. A grill that is out of level will cause erratic burner combustion and inefficient, uneven heating. A carpenter's spirit level should be used to level the grill both front-to-back and side-to-side.

If the low heat problem persists:

- ▶ CHECK THE GAS SUPPLY LINE SIZING REQUIREMENTS.)
- ▶ CHECK THE GAS SUPPLY LINE FOR KINKS OR DAMAGE.

REPLACE any damaged supply lines.

▶ CHECK THE REGULATOR

Make sure that the regulator & hose assembly is the one designed for and supplied with your Lynx grill and that

it is correctly set up for the type of fuel you are using. (See INDEX: "Regulator Conversion" for further details.)

The hose and regulator provided by Lynx must be used if your grill is set-up for an LP Gas Cylinder.

Check that there is no physical pressure being applied to the regulator attached to the back of the grill. The regulator contains a flexible diaphragm and should not be allowed to touch the grill body or its surroundings.

▶ CHECK FOR OBSTRUCTIONS

Ensure that the burners and drip tray are clean and free from obstructions.

LP (Propane) units:

▶ IS THE CYLINDER ALMOST EMPTY?

Almost-empty cylinders may not have sufficient pressure to run the burners at high heat.

▶ HAVE THE LINE PRESSURE CHECKED BY A QUALIFIED TECHNICIAN (See INDEX: "Gas Requirements" for further details.)

▶ FLOW LIMITING DEVICE

Improper lighting procedures may have activated the LP cylinder's flow control device, reducing the heat output.

To reset the flow control:

- Shut off all burner controls and close the LP cylinder valve.
- Wait 30 seconds and, very slowly, reopen the cylinder valve.

- Wait a few seconds and relite a burner.

▶ Bulk LP Cylinder Users

Bulk LP cylinder lines must be properly regulated.

Ensure that you are using a 4/11 appliance regulator supplied by Lynx and converted to LP gas. Also ensure that you do not have more than one regulator in line.

Natural Gas units:

▶ SUPPLY LINE

Ensure that the supply line is at least 3/4" inside diameter or 1" outside diameter.

▶ CHECK LINE PRESSURE

Natural gas pressure should be at least 7" W.C. and 4" W.C. pressure under full load (with all burners on.)

▶ CHECK BURNERS FOR BLOCKAGES

▶ CHECK FLAME CHARACTERISTICS. (See INDEX: "Flame, Correct Size")

▶ CLEAN OR ADJUST AIR SHUTTER (See INDEX: "Air Shutter Adjustment.")

WIND HITTING GRILL

Wind hitting the grill while in use, especially winds blowing into or across the hood gap from behind, can cause poor performance and in some cases can cause the control panel to get dangerously hot.

Steady or gusty winds can prevent the normal exhaust of hot gases.

Locate your grill **away** from prevailing winds and avoid grilling in windy conditions.

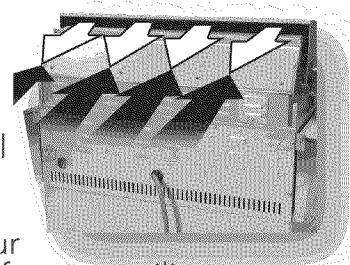

BURNER EXTINGUISHES

► LOCATION

First determine if the problem is being caused by location. If the grill is subject to high winds, reposition it to provide some protection.

► CHECK THE FLAME

Check the gas supply and flame characteristics. (See INDEX: "Flame, Correct Size")

► BURNERS SEATED

Check to ensure that the burners are correctly positioned in the grill. (See INDEX: "Burner Placement" for further details.)

Correctly-installed burners should be seated firmly and level with no side-to-side movement.

BURNER EXTINGUISHES ONLY WHEN SET TO "LOW"

The valves on the grill feature an adjustable low setting.

Fluctuations in gas pressure, gas conversion and even in the quality of the gas itself may affect burner performance at the "LOW" setting. It could be either too high or too low. (See INDEX: "Burner Adjustment" for further details.)

ROTISSERIE WON'T LIGHT

Follow the same procedure as described for the grill burners to diagnose problems with the rotisserie burner.

BE CAREFUL! The rotisserie burner flame may be hard to see in bright sunny conditions.

ROTISSERIE LIGHTS BUT GOES OUT AS SOON AS CONTROL IS RELEASED

► CHECK THERMOCOUPLE

The control knob must be held in for 30 to 60 seconds after ignition for the rotisserie burner to stay lit. (See INDEX: "Lighting the rotisserie" for further details.)

If the burner will not stay lit when you release the control knob, re-light it and hold the control knob in for at least 60 seconds to allow the thermocouple to heat up.

If, after holding the control knob in for at least 60 seconds, the burner still will not stay lit when releasing the control knob, call for service.

(See INDEX: "Obtaining service from Lynx" for further details.)

LIGHTS WON'T LIGHT

► CHECK POWER

Ensure that the grill is connected to a live AC power source and check for rotisserie motor operation.

► RESET TRANSFORMER

Disconnect power from the grill and wait 5 minutes for the transformer to cool down and reset. Then reconnect power. If, after resetting the transformer and replacing bulbs, you still do not have power, call for service.

► REPLACE THE BULB

Replacement bulbs are halogen, 12 volt, 10W max, T3 type with a G4 bi-pin base.



The glass cover is held in place by two spring tension tabs. You may have to loosen the screw to remove the lens.

Avoid touching the glass of a new bulb. Halogen bulbs are very sensitive to the oils found in human skin. Touching the bulbs may shorten their life.

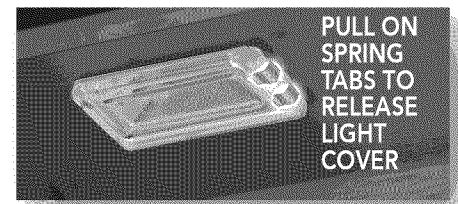

Pull the bulb straight out from the socket without twisting.

The 27" and 30" grills each have one halogen light fixture; all other grills have two light fixtures.

Hold the bulb using a paper towel or other cloth and gently press it straight into the socket. The glass cover should be gently snapped back into place.

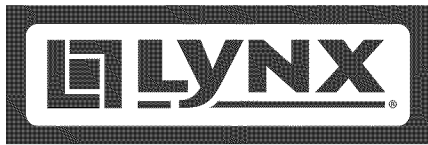

PROFESSIONAL GRILLS

HOW TO OBTAIN SERVICE FROM LYNX

Before calling for service, please make sure you have the following information:

- Model number
- Date of purchase
- Proof of purchase by the original owner
- Serial number.

The serial number can be located on the rating plate which is located either on the underside of the drip tray, on the heat shield behind the front panel, or on the inside left cabinet wall (for most free-standing grills).

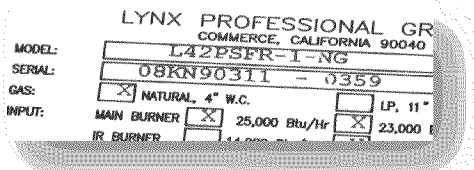

For warranty service, contact the Lynx Customer Service Department for an authorized service agent near you at:

- ▶ (888) Buy-Lynx
- ▶ (888-289-5969).
- ▶ www.LynxGrills.com

Your satisfaction is of the utmost importance to us. If a problem cannot be resolved to your satisfaction, please write, fax or email us:

Lynx Professional Grills

5895 Rickenbacker
Commerce, CA 90040

Service: (888) Buy-Lynx (888-289-5969)

Tel: (323) 838-1770

Fax: (323) 838-1778

www.lynxgrills.com

Contact Lynx for replacement parts. Parts are shipped F.O.B. Commerce, CA.

THE LYNX STORY

LYNX BEGAN WITH A VISION.

A small group of manufacturing engineers with over a century of collective experience had a dream. They dared to take their extensive commercial manufacturing know-how and create a line of outdoor cooking products that offer commercial elegance and performance to the consumer market.

Lynx has taken the quality, workmanship, service and innovation of the commercial market



and incorporated it into the Lynx Professional Grills line of consumer and commercial products. The combination of creative design, superior materials and exceptional craftsmanship elevates Lynx products to a class of their own.

Lynx original commercial products are used every day in restaurants, hotels and theme parks across the USA:

LYNX SATISFIED CUSTOMERS

- TGI Fridays • Applebee's
- Houston's • Red Lobster •
- Hard Rock Café • Wolfgang Puck's • Cheesecake Factory
- Red Robin • Planet Hollywood • Hilton • Hyatt
- Four Seasons Marriott Le Meridian • Sheraton • Conrad International Bellagio • New York New York • MGM Grand
- Treasure Island • Mirage • Paris • Venetian • Excalibur
- Mandalay Bay • Riviera • Desert Inn • Hard Rock Hotel
- Disney World

WARRANTY

I. Limited Lifetime Warranty.

The stainless steel body housings, the solid brass grill burners and the ProSear™ burners are warranted to be free from defects in material and workmanship when subjected to normal domestic use and service for the lifetime of the original purchaser. This warranty excludes surface corrosion, scratches, and discoloration which may occur during regular use. This warranty is limited to the replacement of the defective parts, with the owner paying all other cost including labor.

*Does not include the rotisserie infra-red burner.

II. Limited Five-Year Warranty.

The structural integrity of the interior grill parts, exterior, and drip pans are warranted to be free from defects in material and workmanship, when subjected to normal domestic use and service, for a period of five years from the date of purchase. This warranty is limited to the replacement of the defective parts, with the owner paying all other cost including labor.

III. Limited One-Year Warranty.

All other grill components are warranted to be free from defects in material and workmanship for a period of one year from the original date of purchase. Lynx will replace or repair parts found to be defective at no cost to the original purchaser.

IV. Limitations & Exclusions

- 1) Warranty applies only to the original purchaser and may not be transferred.
- 2) Warranty is in lieu of all other warranties, expressed or implied and all other obligations or liabilities related to the sale or use of its grill products.
- 3) Warranty shall not apply and Lynx is not responsible for damage resulting from misuse, abuse, alteration of or tampering with the appliance, accident, hostile environment, flare-up fires, improper installation, or installation not in accordance with the instructions contained in this manual, or the local codes.
- 4) Lynx shall not be liable for incidental, consequential, special or contingent damages resulting from its breach of this written warranty or any implied warranty.
- 5) Some states do not allow limitations on how long an implied warranty lasts, or the exclusions of or limitations on consequential damages. This warranty gives you specific legal rights and you may have other rights which vary from state to state.
- 6) No one has the authority to add to or vary Lynx's warranty, or to create for Lynx any other obligation or liability in connection with the sale or use of its products.
- 7) Limited to the replacement of defective parts with the owner paying all other costs including labor.

V. What is not covered.

Lynx shall not be responsible for and shall not pay for the following:

- 1) Installation or start-up, damages or problems caused by improper installation or use;
- 2) Service by an unauthorized service provider;
- 3) Damage or repair due to service by an unauthorized service provider or use of unauthorized parts;
- 4) Units installed in common areas or non-residential applications such as day-care centers, bed and breakfast centers, churches, nursing homes, restaurants, hotels, schools, etc.;
- 5) To correct normal adjustments or settings, due to improper installation, commissioning or local gas supply properties;
- 6) Shipping and handling costs, export duties, installation, removal, or re-installation cost;
- 7) Display models are generally sold "as is." If you have purchased a display model, please be advised that it is sold "as is" and that it is subject to the following warranty exclusions: any exterior or cosmetic damage is non-warrantable; any missing components will be replaced at consumer's expense; major handling damage to manifold, valve and ignition system will be serviced at consumer's expense; all other warranty's (standard warranty) will remain in effect.
- 8) The cost of a service call to diagnose trouble. (See INDEX: "Obtaining Service from Lynx" for further details.)



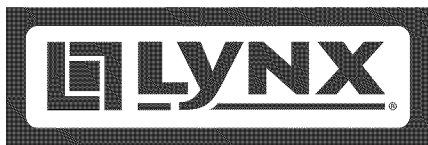

PROFESSIONAL GRILLS

INSTALLATION GUIDELINES

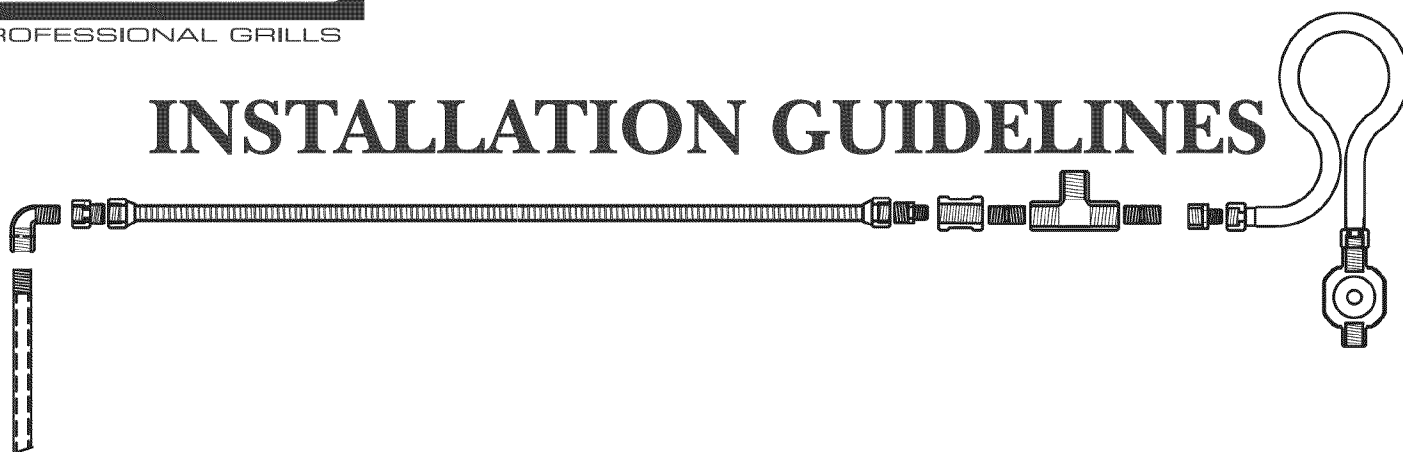

INSTALLATION GUIDELINES	25
Before You Start.....	27
<i>If shipment arrives damaged</i>	<i>27</i>
Unpacking and Assembly	30
Electrical Connections.....	31
Gas Connections.....	32
Final Checks	34
Side Burner/LPSGE Hookup	36
Wiring Schematics	37
L27 Non-Rotisserie Grill.....	37
L27 & L30 rotisserie Grill.....	38
L36 & L42 rotisserie Grill.....	39
L54 rotisserie Grill	40
2010 Lynx Professional Grills Exploded Parts View.....	41
2010 Lynx Professional Grills Parts list	42

WARNING 

- 1) Always maintain the required clearances from combustible construction as detailed. The grill is designed for outdoor use only. NEVER use in a garage, building, shed, breezeway or other enclosed area. This grill shall not be used under any overhead combustible construction.
- 2) Gas grills are not design certified for and are not to be installed in or on recreational vehicles, portable trailers, boats or any other moving installation.
- 3) Keep any electrical supply cord and the fuel supply hose away from any heated surfaces. Electrical cords should be placed away from walkways to avoid tripping hazard.
- 4) Do not repair or replace any part of the grill unless specifically recommended in this manual. Other service should be performed by a qualified technician.
- 5) All gas lines must have a shut-off that is readily and easily accessible. Be sure the owner knows where the shut-off is located. If you smell gas, check for gas leaks immediately. Check only with a soap and water solution. Never check for gas leaks with an open flame. (See INDEX: "Leak Testing" for further details.)

WARNING 

- 1) The outdoor cooking gas appliance and its individual shutoff valve must be disconnected from the gas supply piping system during any pressure testing of that system at test pressures in excess of 0.5 psi (3.5 kPa).
- 2) The outdoor cooking gas appliance must be isolated from the gas supply piping system by closing its individual manual shutoff valve during any pressure testing of the gas supply piping system at test pressures equal to or less than 1/2 psi (3.5 kPa).

STATE OF MASSACHUSETTS 

- 1) Massachusetts requires all gas be installed using a plumber or gas fitter carrying the appropriate Massachusetts license.
- 2) All permanently-installed natural gas or propane installations require a "T" handle type manual gas valve be installed in the gas supply line to this appliance.
- 3) This does not apply to portable propane installations using a 20 pound cylinder.

BEFORE YOU START

IF SHIPMENT ARRIVES DAMAGED

VISIBLE LOSS OR DAMAGE:

Be certain any visible damage to the carton is noted on freight bill or express receipt and signed by the person making delivery.

FILE CLAIM FOR DAMAGES IMMEDIATELY, regardless of extent of damage.

CONCEALED LOSS OR DAMAGE:

If damage is unnoticed until the grill is unpacked, notify the transportation company or carrier immediately and file a "concealed damage" claim with them. This should be done within (15) days of the date delivery is made to you. Be sure to hold on to the container for inspection. We cannot assume responsibility for damage or loss incurred in transit. (See INDEX: "Obtaining Service from Lynx" for further details.)

WARNING



- ▶ Never install this product into a combustible enclosure without an insulated jacket. Doing so could result in fire, property damage and personal injury.
- ▶ Never locate the grill under a roof or overhang, in a building, garage, shed or other such enclosed area.
- ▶ Never locate the grill under combustible construction.
- ▶ Installation must conform with local codes or, in the absence of local codes, with either the National Fuel Gas Code, ANSI Z223.1/NFPA 54, Natural Gas and propane Installation Code, CSA B149.1, or Propane Storage and Handling Code, B149.2,

IMPORTANT NOTES:

Where's the Wind?

When selecting a suitable location, consider important factors such as exposure to the wind and foot-traffic patterns.

If you have a freestanding grill, position it so the prevailing wind blows into the front control panel (at your back when grilling), supporting the proper front-to-rear airflow.

Built-in grills located in areas with prevailing winds should be protected by a wind barrier.

Winds hitting the *back* of the grill directly may cause problems, as well as wind blowing along the *hood gap*.

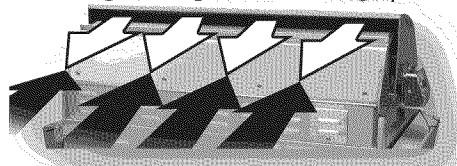

Be sure wind doesn't blow into the hood gap.

How long is your run?

Keep all gas supply lines as short as possible because gas lines lose pressure over distance and with each elbow and tee that is added. This drop in pressure affects grill performance. (See INDEX: "Gas Supply Line Runs" for further details.)

Are you "on-the-level"?

Proper leveling during installation is critical. A grill that is out of level will cause erratic burner combustion and inefficient, uneven heating. A carpenter's spirit level should be used to level the grill both front-to-back and side-to-side.

If the floor is uneven or has a decided slope, re-leveling may be required each time you move a freestanding unit.

BUILT-IN INSTALLATIONS:

The Lynx Built-In Grill is designed for easy installation into masonry enclosures.



NOTE:

Lynx built-in grills are intended either for installation in a built-in enclosure constructed of non-combustible materials or for an installation in a built in enclosure constructed of combustible material when installed with a Lynx insulating jacket (LIJ).

For non-combustible applications, the grill drops into the opening shown in the cutout detail drawing (See INDEX: "Gas Requirements") and hangs from its counter-top trim. A deck is not required to support it from the bottom.

When using the insulated jacket in a combustible enclosure, the jacket must be supported from the bottom by a ledge on each side or a full deck beneath the jacket.

(See INDEX: "Gas Requirements") Pay special attention to the provisions shown for gas line hook-up.

The enclosure should have ventilation holes to prevent gas build-up in the event of a leak. The deck ledges and counter should be flat and level. (refer to ANSI Z21.58 Enclosures For Self Contained LP-Gas Supply Systems or local codes for additional information)

This grill requires that a 120 volt, 60 hertz, 15 amp GFI certified outlet be installed by a qualified electrician.

CLEARANCE TO COMBUSTIBLE MATERIALS:

Minimum clearance from the sides and back of the grill to adjacent combustible construction below the top of unit are 12" from the sides and back.

Dégagement minimal entre les parois latérales et l'arrière de l'appareil et la construction combustible au-dessous du panneau supérieur de l'appareil (30 cm à partir des parois latérales et 30 cm à partir de l'arrière).

Minimum clearance from sides and back of unit to adjacent combustible construction extending above the unit is 18" from the sides and back.

Dégagement horizontal minimal entre les parois

latérales et l'arrière de l'appareil et la construction verticale combustible au-dessus de l'appareil (45.7 cm à partir des parois latérales et 45.7 cm à partir de l'arrière).

Do not use this appliance under overhead combustible surfaces.

Ne pas utiliser cet appareil sous une surface combustible.

A minimum of 6" of clearance is needed on the left side of the grill above the counter top for the motor and skewer.

If the grill is to be placed into a combustible enclosure, an approved insulated jacket is necessary and is available only from your Lynx dealer. Lynx insulated jackets have been designed and tested specifically for your Grill.

REAR HOOD CLEARANCE:

A 3 inch clearance is required behind the grill to allow the front hood to open.

The grill exhausts combustion products and cooking greases to the back. Never locate the grill where this exhaust will be difficult to clean.

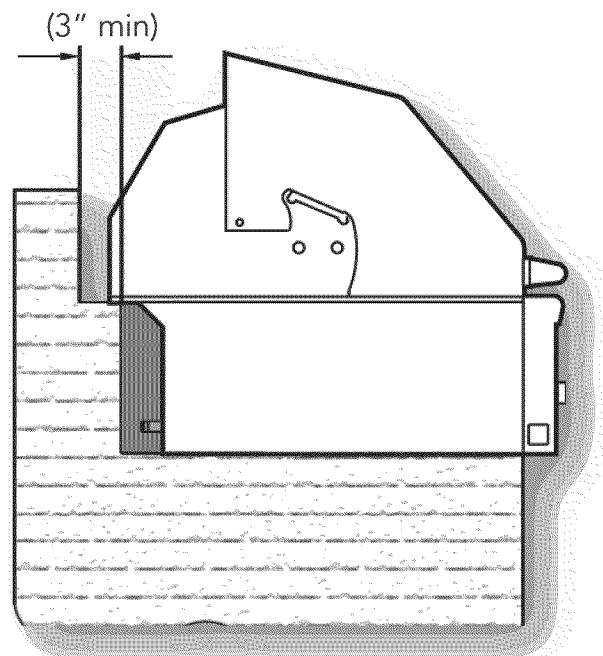

CUT-OUT DIMENSIONS FOR BUILT-IN GRILLS

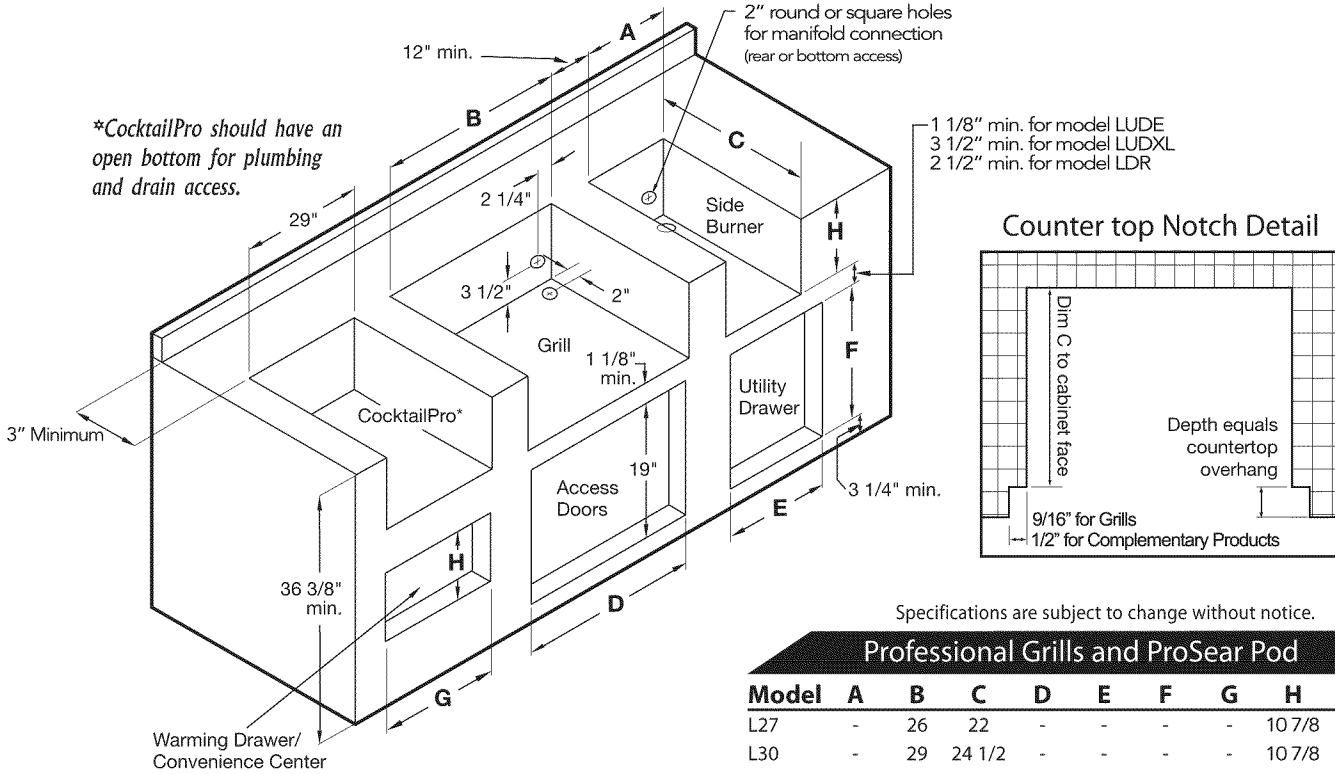

Specifications are subject to change without notice.

Professional Grills and ProSear Pod

Model	A	B	C	D	E	F	G	H
L27	-	26	22	-	-	-	-	10 7/8
L30	-	29	24 1/2	-	-	-	-	10 7/8
L36	-	35	22	-	-	-	-	10 1/8
L42	-	41	24 1/2	-	-	-	-	10 7/8
L54	-	53	24 1/2	-	-	-	-	10 7/8

Note: Insulated jacket required for all grills installed into a combustible enclosure. See detail below.

With Insulated Jacket Installed

Model	a	b	c	d	e	f
LJ27	33	5	24	4 1/2	3	11 5/8
LJ30	36	5	26 1/2	4 1/2	3	11 5/8
LJ36	42	5	24	4 1/2	3	11 5/8
LJ42	48	5	26 1/2	4 1/2	3	11 5/8
LJ54	60	5	26 1/2	4 1/2	3	11 5/8

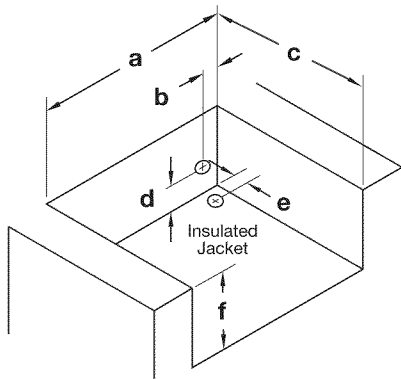

Complementary Products

Model	A	B	C	D	E	F	G	H
Access Doors								
LDR21-1	-	-	-	19 1/4	-	-	-	-
LDR27-1	-	-	-	25 1/4	-	-	-	-
LDR30-1	-	-	-	28 1/4	-	-	-	-
LDR36-2	-	-	-	34 1/4	-	-	-	-
LDR42-1	-	-	-	40 1/4	-	-	-	-
Side Burners and ProSear Grill Extender								
LSB1	12 1/8	-	24 1/2	-	-	-	-	10 5/8
LSB2	12 1/8	-	24 1/2	-	-	-	-	10 5/8
LSB2PC	24 1/4	-	24 1/2	-	-	-	-	10 5/8
LPSGE	12 1/8	-	24 1/2	-	-	-	-	10 5/8
LPB	19	-	22	-	-	-	-	10 5/8
Utility Drawers								
LUDE	-	-	24	-	12 1/8	19 1/4	-	-
LUDXL	-	-	24 1/4	-	17 1/4	18 9/16	-	-
Warming Drawers								
L30WD	-	-	20 1/2	-	-	-	28 1/2	10
L42CC	-	-	24 1/2	-	-	-	40 1/4	19 3/8
CocktailPro								
CS30	-	-	22 3/4	-	-	-	-	10 5/8

UNPACKING AND ASSEMBLY

The grill arrives nearly ready to use and requires only minor assembly.

By carefully following the uncrating and unpacking steps, you will improve the customer's first Lynx experience.

Shipping weight on smaller units is app. 300 pounds and larger units may weigh over 500 pounds.

WARNING **EXCESSIVE WEIGHT HAZARD!**

Use two or more people to move or install this unit. Failure to follow this instruction can result in back or other injuries.

CRATE & CARTON:

- ▶ **IMPORTANT!** Do not remove staples around the top of the carton. These staples hold a wooden pallet in place inside the carton that protects the unit from damage. Removing these staples may cause the pallet to fall on the top of grill.

How to Remove the Carton

- ▶ Cut the main strap holding the grill to the pallet.
- ▶ Remove the staples at the **bottom** of the carton.
- ▶ Lift off the carton.
- ▶ With assistance, remove grill from pallet and place into desired location.

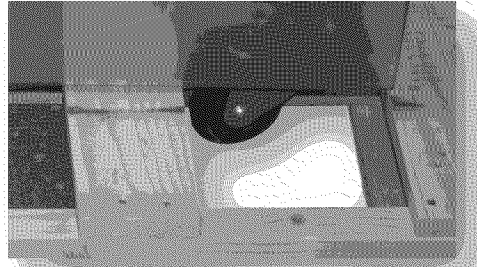

Grill will not slide directly off pallet.

The wheels sit down in the gaps of the shipping crate so that the grill can sit safely and solidly on the crate during shipping. The grill cannot be slid directly off of the pallet.

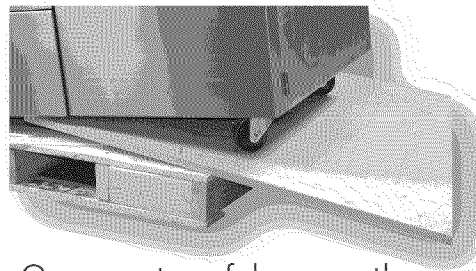

One way to safely move the grill off of the pallet is by lifting one end of the grill high enough to place a ramp under the wheel and then lift the other end while rolling the grill off of the pallet.

INTERIOR PACKING

Lynx uses sturdy tie-down cables and straps to ensure your grill arrives at your home in the same condition that it left our factory. **BE SURE YOU HAVE REMOVED ALL TIE DOWNS BEFORE USING YOUR GRILL.**

- ▶ Remove the white accessory box and wood packing, the grill racks, and remove any loose items from the firebox.

- ▶ Carefully cut the cable ties securing the warming rack and rotisserie spit (if equipped).

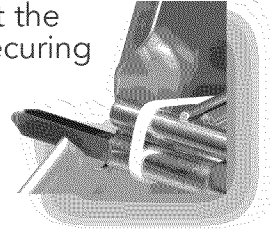

- ▶ Cut the strapping that secures the briquette trays and carefully lift them out, front first.

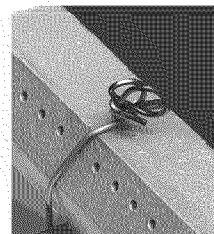
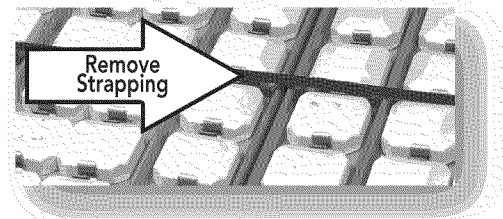

Make sure you remember to remove the wire tie-downs on the burners.

- ▶ On ProSear™ models, cut and remove ties from the burner partition on the left side of the ProSear™ burner.

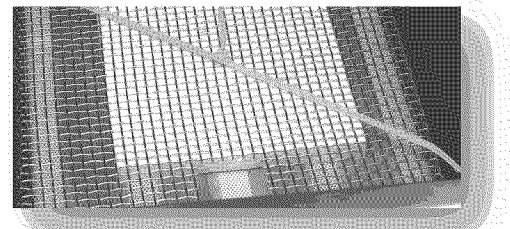

(Be sure to remove the Styrofoam packing from *under* the burner cover.)

- ▶ Ensure that all burners are properly seated on the burner valve orifice and sitting level with the legs in the frame slots and no side-to-side movement.

ELECTRICAL CONNECTIONS

WARNING - ELECTRICAL GROUNDING



- ▶ Product installation must meet local electric codes or, in the absence of local codes, the latest edition of the National Electrical Code ANSI/NFPA No. 70 or the Canadian Electrical Code CGA 1.6b2005.
- ▶ Use only a Ground Fault Interrupter (GFI) protected circuit with this outdoor cooking gas appliance.
- ▶ **IMPORTANT:** When connecting your rotisserie motor, first connect the motor to the grill and then plug the grill into the outlet.
- ▶ This grill is equipped with a three prong (grounding) electric plug for your protection against shock hazard and must be plugged directly into a properly grounded three prong outlet. NEVER cut or remove the grounding prong from this plug.
- ▶ Use only extension cords with a 3 prong grounding plug, rated for the power of the equipment, and approved for outdoor use with a "W-A" marking.
- ▶ To protect against electric shock, do not immerse any part of the power cord, an extension cord or any plugs in water or other liquid.
- ▶ Unplug the product from the outlet when not in use and before cleaning. Allow it to cool before putting on or taking off parts.
- ▶ Do not let the cord hang over the edge of a table or touch hot surfaces.
- ▶ Do not use an outdoor cooking gas appliance for purposes other than intended.
- ▶ Do not operate any outdoor cooking gas appliance with a damaged cord, plug, or after the appliance malfunctions or has been damaged in any manner. Contact the manufacturer for repair.

CONNECTION TO AC

Installation requires an outdoor 120VAC 15A GFI (Ground Fault Interrupter) electrical outlet adjacent to the grill.

The GFI outlet features an internal breaker that reduces shock hazard. This type of

outlet should be installed by a qualified electrician either inside the island enclosure for built-in units, or near the location where a free-standing unit will be used.

For built-in grills, the supplied 12V transformer is connected

to the grill during installation.

If the electrical system fails to operate, a connection may have come loose in shipping or the GFI may have tripped, requiring a reset. See the Troubleshooting section for more details.

GAS CONNECTIONS

WARNING

NEVER CONNECT A GAS LINE DIRECTLY TO THE GRILL. A PRESSURE REGULATOR MUST BE INSTALLED ON ALL GAS EQUIPMENT. ALL LOCAL CODES REQUIRE IT AND LYNX SUPPLIES THE CORRECT REGULATOR WITH YOUR GRILL. REMOVING OR FAILING TO INSTALL THE PRESSURE REGULATOR CAN RESULT IN FIRE AND SERIOUS PERSONAL INJURY AND WILL VOID THE WARRANTY.

The grill is factory set to use either propane (LP) or natural gas (NAT). It is critical that the gas you use matches that which the grill was set up for. You can verify that by checking the *rating plate*.

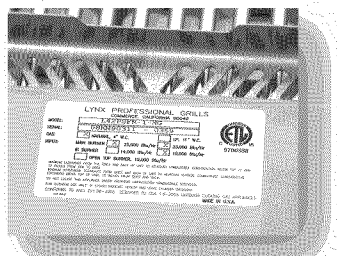

The Rating plate lists serial numbers, model numbers and gas type. This one is underneath the drip tray.

The rating plate is located in one or more of the following places:

- ▶ Attached to the underside of the drip tray
- ▶ On the heat shield behind the front panel
- ▶ On the inside left cabinet wall

Ensure that the gas supplied meets with the minimum pressure requirements. Do not operate the grill on any gas other than that for which the grill has been set.

Fuel	WC Max Inlet	WC Min Under Full Load
Nat Gas	7 in	4 in
LP	14 in	11 in

Water Column Requirements

Both the regulator and the manifold orifices have been tuned for the type of gas specified on the rating plate.

Converting to a different type of gas requires a conversion kit, available from Lynx or from your dealer and must be installed by a qualified technician.

All installation and all installation parts must conform to local codes with the National Electrical Code, ANSI/NFPA 70-1990 and the National Fuel Gas Code, ANSI Z223.1/NFPA 54 in the U.S and CGA-B149.1/.2 in Canada.

Canadian installations must conform to CGA-B149.1/.2 natural gas/propane installation code. (Canada)

NATURAL GAS

Lynx recommends that only qualified professionals perform the required plumbing on this product.

To ensure satisfactory performance, the gas supply line must be sized to accommodate the total BTU requirements of all the gas-fired equipment that will be connected to that line.

In no case should pipe less than 3/4" inside diameter or 1" outside diameter ever be used to connect this product.

- ▶ Calculate the total BTU output of all equipment and refer to "INDEX: Gas Supply Line Runs" for allowable run distances for 3/4 inch pipe. Failure to meet these minimum requirements may reduce performance of the grill and any other appliances running on that supply line.
- ▶ Always keep supply line runs as short as possible. (See INDEX: "BTU Output" for specific model outputs)
- ▶ A gas shut-off valve must be installed in an easily accessible location by a qualified plumber.

- ▶ Keep any threading compound off of the first two pipe threads to avoid having any small pieces of compound break loose and clog a burner valve or orifice. Do not put sealant on any male end of flare fittings.

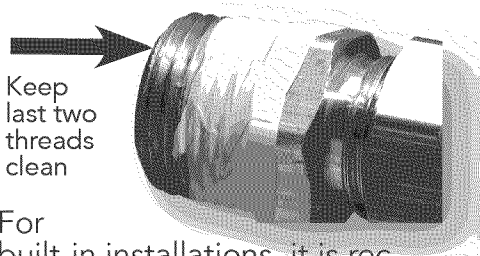

For built-in installations, it is recommended that any flexible pipe used be kept as short as possible. (See INDEX: "Gas Connections" for typical permanent hook up.)

For *freestanding* units using natural gas, Lynx strongly recommends using a quick disconnect kit.

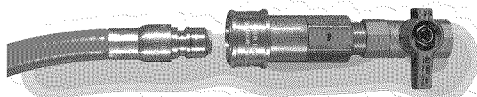

This Quick Disconnect kit, part #LQD, is available from your dealer.

LP GAS

Grills set up for LP gas come equipped with an LP hose/regulator assembly for connection to a standard 20 lb. LP cylinder. (Type 1). All fittings necessary to attach the assembly to the grill are included.

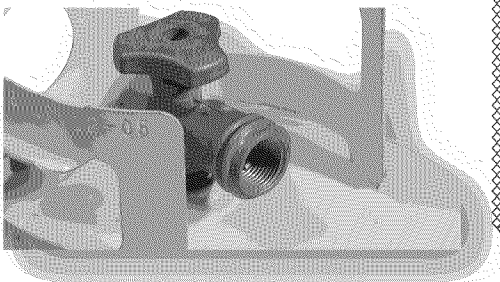

LP cylinder with type 1 valve connection

Permanently plumbed LP connections, such as those in line with a bulk cylinder, require a 4/11 regulator. (Lynx P/N 30781)

If you are using a 4/11 Maxitrol regulator, ensure that it is set for the correct fuel by adding or removing the cap gasket as shown below.

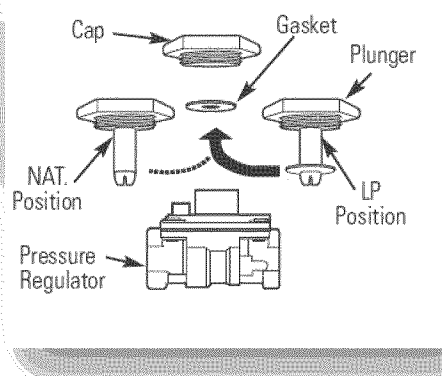

Never connect an unregulated gas line to the grill.

WARNING



Do not change the regulator/hose assembly or use any other assembly than the one supplied with your Lynx grill.

Do not attempt to use a 5LP-A equipped regulator/hose assembly with a standard 510 POL cylinder/valve assembly.

Do not store a spare LP-gas cylinder under or near this appliance

Never fill the cylinder beyond 80 percent full

If the information above is not followed exactly, a fire causing death or serious injury may occur.

LP Cylinder Requirements

The LP cylinder must be constructed and marked in accordance with the specifications for LP gas cylinders of the U.S. Department of Transportation (DOT) and designed for use with a Type 1 system only.

Cylinders must be secured using the provided cylinder retention system to avoid accidental movement.

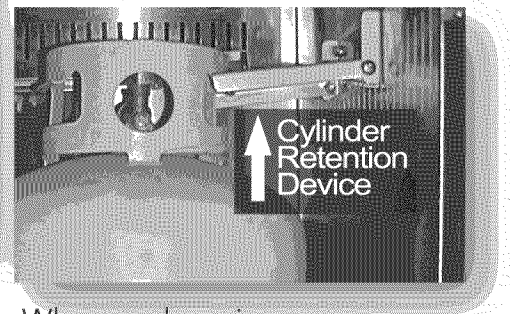

When exchanging your cylinder for a refill, exchange only for a Type 1 20lb cylinder with an over-fill protection device.

Never use a cylinder with a damaged valve.

A dented or rusty LP cylinder may be hazardous and should be avoided. If in doubt, have it checked by your LP supplier.

Always check for leaks after every LP cylinder change. (See INDEX: "Leak Test" for further details.)

Always shut off the LP-gas supply at the cylinder when the grill is not in use.

Cylinders must be stored outdoors in a well-ventilated area out of the reach of children. If your grill is stored indoors, the LP cylinder must be stored outside.

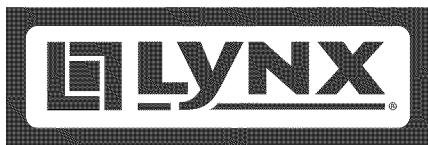

PROFESSIONAL GRILLS

LP Connections

Make sure the LP cylinder valve is fully closed. It is possible for the valve to be open without releasing gas but, as soon as you start connecting the regulator, gas will leak from the connection.

Insert the regulator inlet into the cylinder valve and turn the black coupler clockwise until the coupler is hand tight. Do not over-tighten this connection.

To disconnect the coupler, first make sure the main cylinder valve is turned off. Grasp the coupler and turn counter clockwise. The inlet will then disengage.

Always leak-test the connection after refilling or exchanging LP cylinders. (See INDEX: "Leak Test" for further details.)

GAS LINE PURGING

You should purge the gas line of air before attempting to light the grill.

- ▶ Make sure all grill controls are in the "OFF" position.
- ▶ Slowly turn on the main gas supply.
- ▶ Push in the rotisserie knob and confirm that the igniter is glowing. It is furthest from the fuel source and will completely purge the lines. It will take several seconds for the burner to light.
- ▶ Hold the knob ON for about 20 seconds to allow the air in the system to purge and the burner to light
- ▶ Wait at least 5 minutes after shutting off the control before attempting to light the burners.

FINAL CHECKS

LEAK TESTING

DANGER!



To prevent fire or explosion hazard, DO NOT smoke or allow any potential source of ignition (sparks, electrical arcing, etc) in the area while performing a leak test. Leak tests should be conducted outdoors only. Never conduct a leak test using fire or flame.

Leak Test Procedure:

- ▶ Create a soapy solution of 1 part soap and 3 parts water.
- ▶ Confirm that all control knobs are in the off position.
- ▶ Turn on the fuel supply. For natural gas, turn the valve handle 1/4 turn to align with the gas flow.
- ▶ For L.P., turn the cylinder valve knob counter clockwise one full rotation.
- ▶ Apply the soap solution generously by paint brush or squirt bottle on all connections and fittings.
- ▶ If bubbles appear to "grow" on any of the connections, you have a gas leak. IMMEDIATELY turn off the gas supply.

Fixing a Gas Leak

- ▶ Shut off the gas supply
- ▶ Turn all grill controls to the "ON" position to purge the grill of any gas build-up, then turn the controls back "OFF".

- ▶ Wash off the soapy solution with cold water and dry.
- ▶ Tighten the loose joint, or replace the faulty part with manufacturer-recommended replacement parts.
- ▶ DO NOT attempt to repair the L.P. cylinder valve if it is damaged. The only way to safely resolve a damaged cylinder is to REPLACE IT.
- ▶ Repeat the leak test to ensure that no leaks are present.

LOW HEAT BURNER ADJUSTMENT

FOR MAIN BRASS BURNERS, PROSEAR™ AND SIDE BURNERS!

DO NOT ADJUST THE ROTISSERIE BURNER.

The main brass burners and side burners on your Lynx grill feature an adjustable low setting.

Fluctuations in gas pressure, gas conversion and even in the quality of the gas itself may affect burner performance at the "LOW" setting. It could be either too high or too low.

To adjust the burner low setting:

- ▶ Make sure the grill is cool.
- ▶ Remove racks and briquette trays so that you can see the flames while adjusting the burners.
- ▶ Light the burner and set it to "LOW". (all the way counter-clockwise).

- ▶ Pull off the control knob.
- ▶ While holding the valve shaft with pliers, insert a thin flat-blade screwdriver into the shaft and, while watching the flame, adjust it to a minimum stable setting.

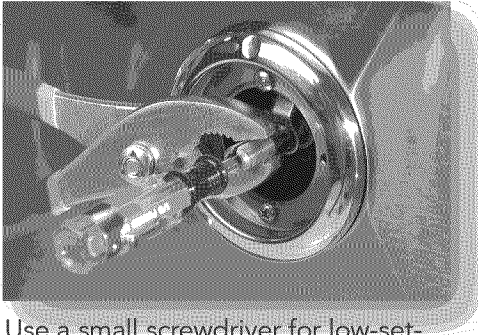

Use a small screwdriver for low-setting burner adjustment.

BRASS BURNER FLAME/ AIR FLOW ADJUSTMENT

The amount of air that enters a burner is controlled by the *air shutter*.

Each grill burner is tested and adjusted at the factory prior to shipment. However, fluctuations in gas pressure, gas conversion and even in the quality of the gas itself may make it necessary to adjust the burner.

The flames of the main brass burners should be visually checked.

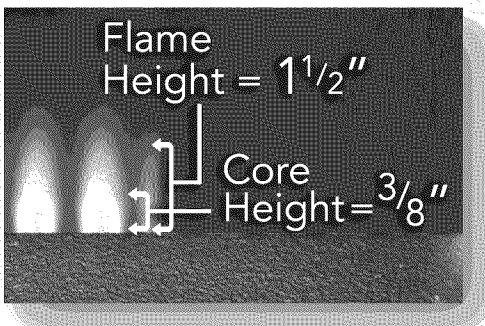

Flames should be blue and stable with slight yellow tips. The bright-blue core should

be about 3/8 inch high with a total flame height of about 1 1/2 inches.

The flames should burn quietly. (no "torch" sounds) and they should not "lift" up from the burner.

If your flames do not match those indicated in the photo, ensure that the air shutter and burner ports are free and clear of dirt, debris, or spider webs. If clear, then adjust the air shutter.

It is locked in place by a screw which must be loosened before adjusting. Once adjusted retighten the screw.

To Adjust:

DANGER! 

BE EXTREMELY CAREFUL AROUND HOT BURNERS AND OTHER GRILL PARTS.

- ▶ Remove the racks and briquette trays.
- ▶ Lift out the burner, loosen the set screw and then put the burner back in place and light it.

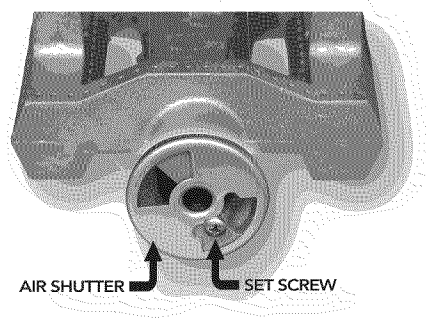

- ▶ If the flame is excessively yellow, indicating insufficient air, CAREFULLY turn the air shutter counter-clockwise to allow more air to the burner.

- ▶ If the flame is noisy (sounds like a torch) and tends to lift away from the burner, indicating too much air, turn the air shutter clockwise.
- ▶ After the burner cools down, remove it, tighten the air shutter set screw and reinstall the burner, briquette trays and grill racks.

ONE LAST THING:

Finally, before leaving, check all the burners for proper operation. Make sure the control knobs turn freely and completely through their full range.

IMPORTANT:

Make sure the owner knows where the main gas supply shut off valve is located.

Finally, for safety and for proper use & care, you must leave this manual with the owner. Make sure you advise them to keep it for future reference.

For technical assistance call:
Lynx Technical Support
888-289-5969

SIDE BURNER/LPSGE HOOKUP

BUILT-IN INSTALLATION

- ▶ Shut off the gas supply at the main valve.
- ▶ Disconnect all plumbing (if already attached) from the grill and the gas supply valve.
- ▶ Remove all the fittings from the grill manifold.
- ▶ Install the side burner into the counter top cutout.
- ▶ Connect the gas supply to the grill and side burner as shown in the two diagrams on this page.
- ▶ Turn the gas supply on and leak test all connections. (See INDEX: "Leak Test" for further details.)

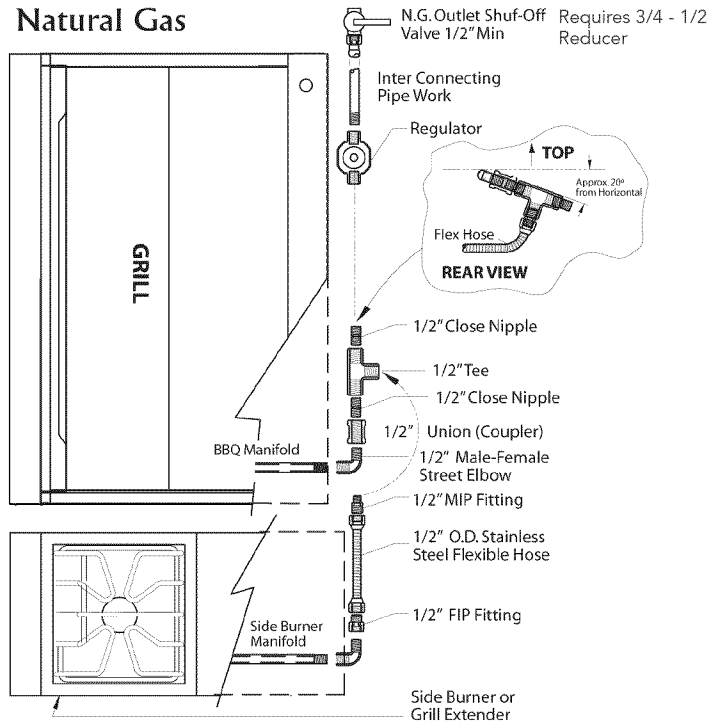

CART INSTALLATION

- ▶ Shut off the gas supply at the main valve.
- ▶ Disconnect all plumbing (if already attached) from the grill and the gas supply valve.
- ▶ Remove all the fittings from the grill manifold.
- ▶ Install the side burner onto the cart according to the directions supplied with the cart mounting kit.
- ▶ Connect the gas supply to the grill and the side burner as shown in the diagrams on this page for your gas type.
- ▶ Turn the gas supply on and leak test all connections. (See INDEX: "Leak Test" for further details.)

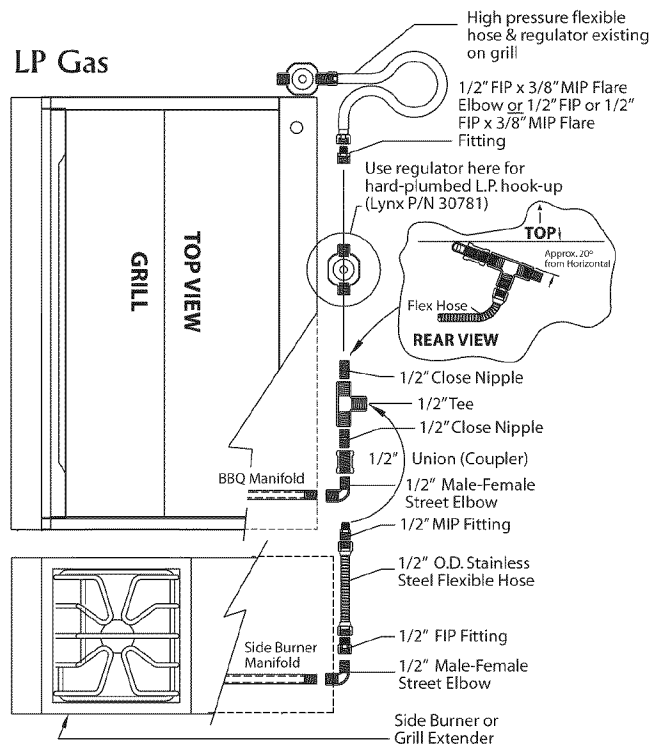

WIRING SCHEMATICS

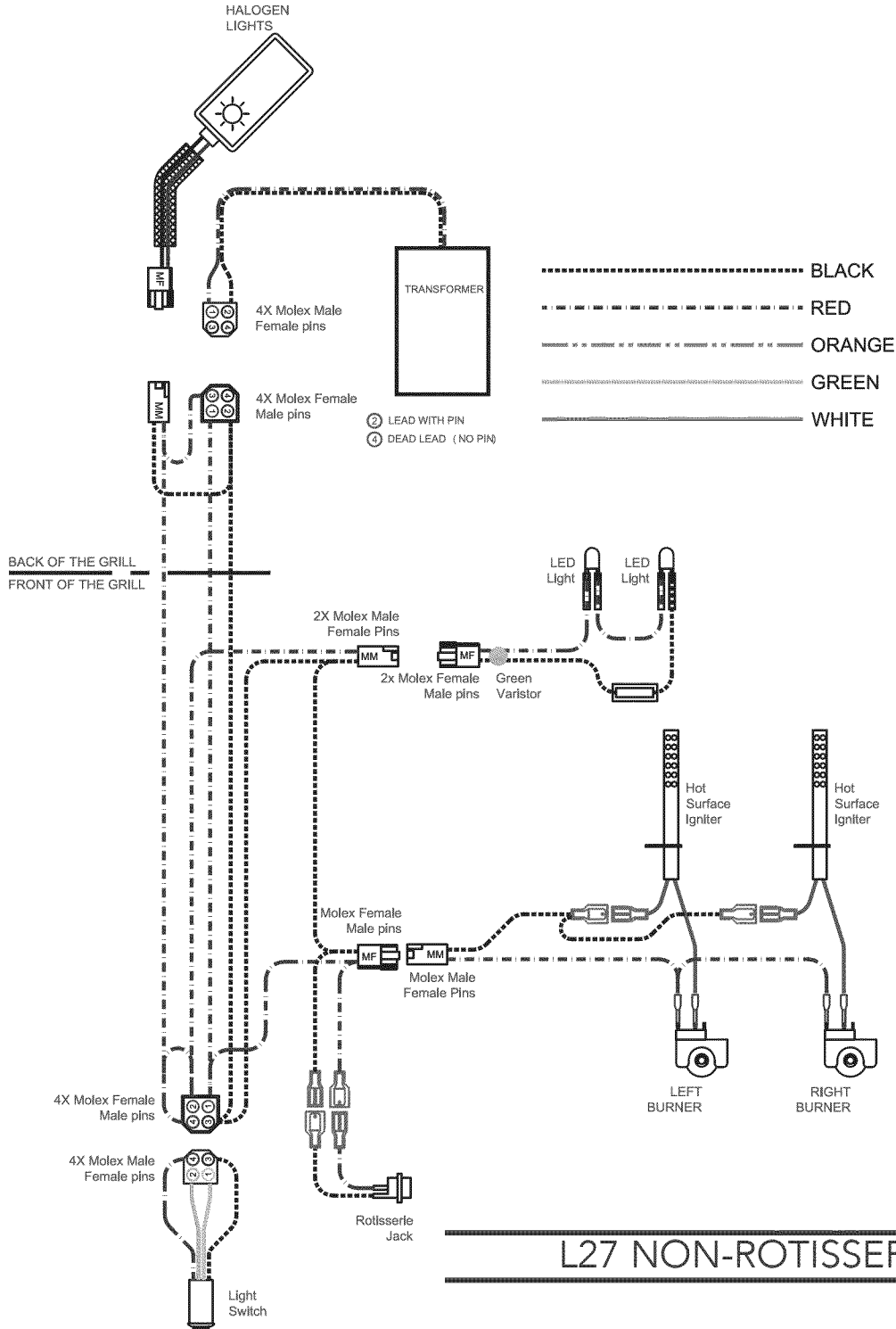

L27 NON-ROTISSERIE GRILL

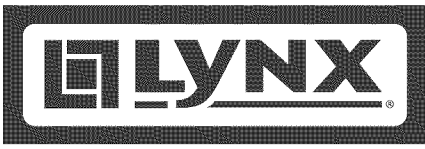

PROFESSIONAL GRILLS

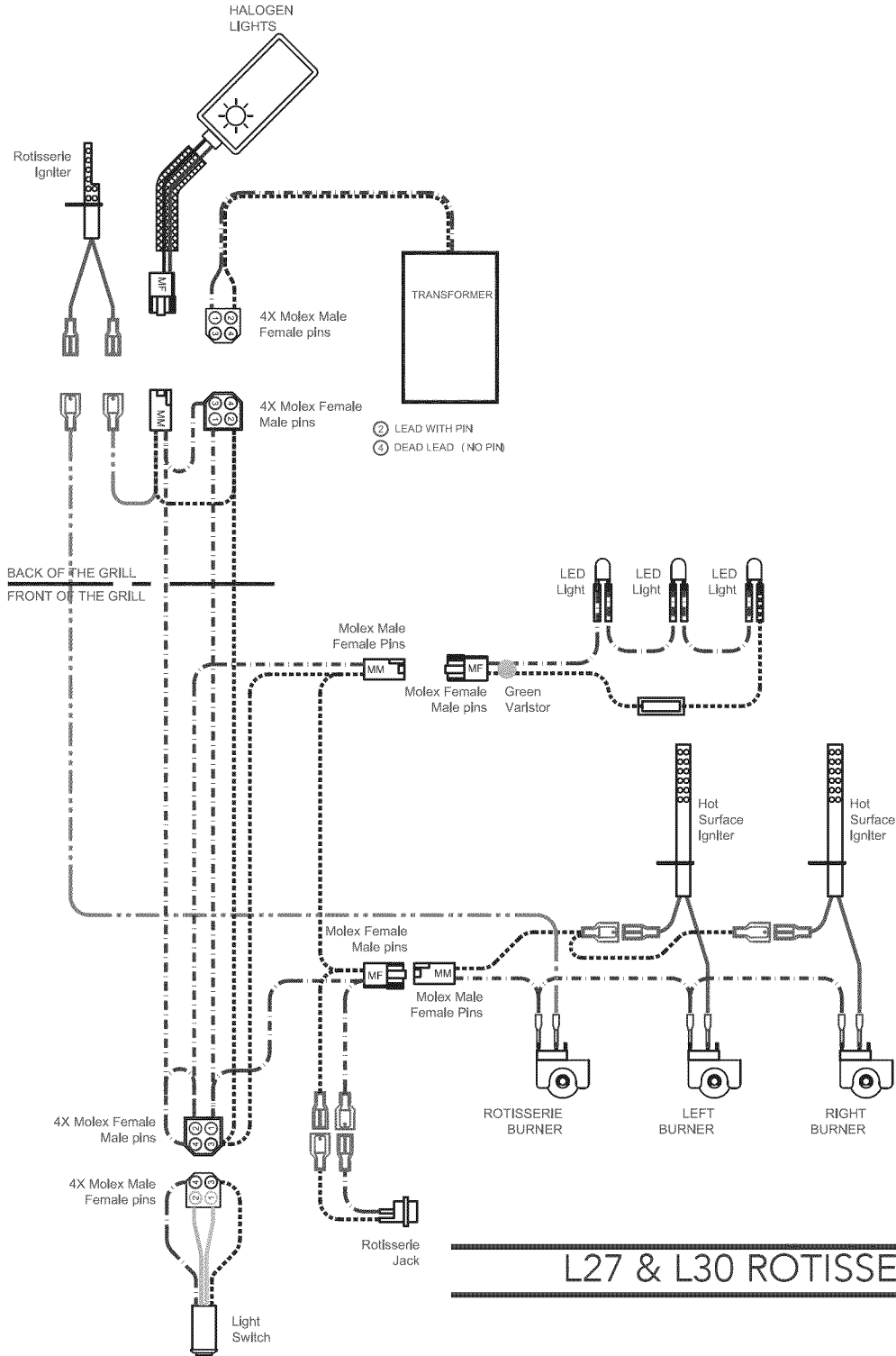

L27 & L30 ROTISSERIE GRILL

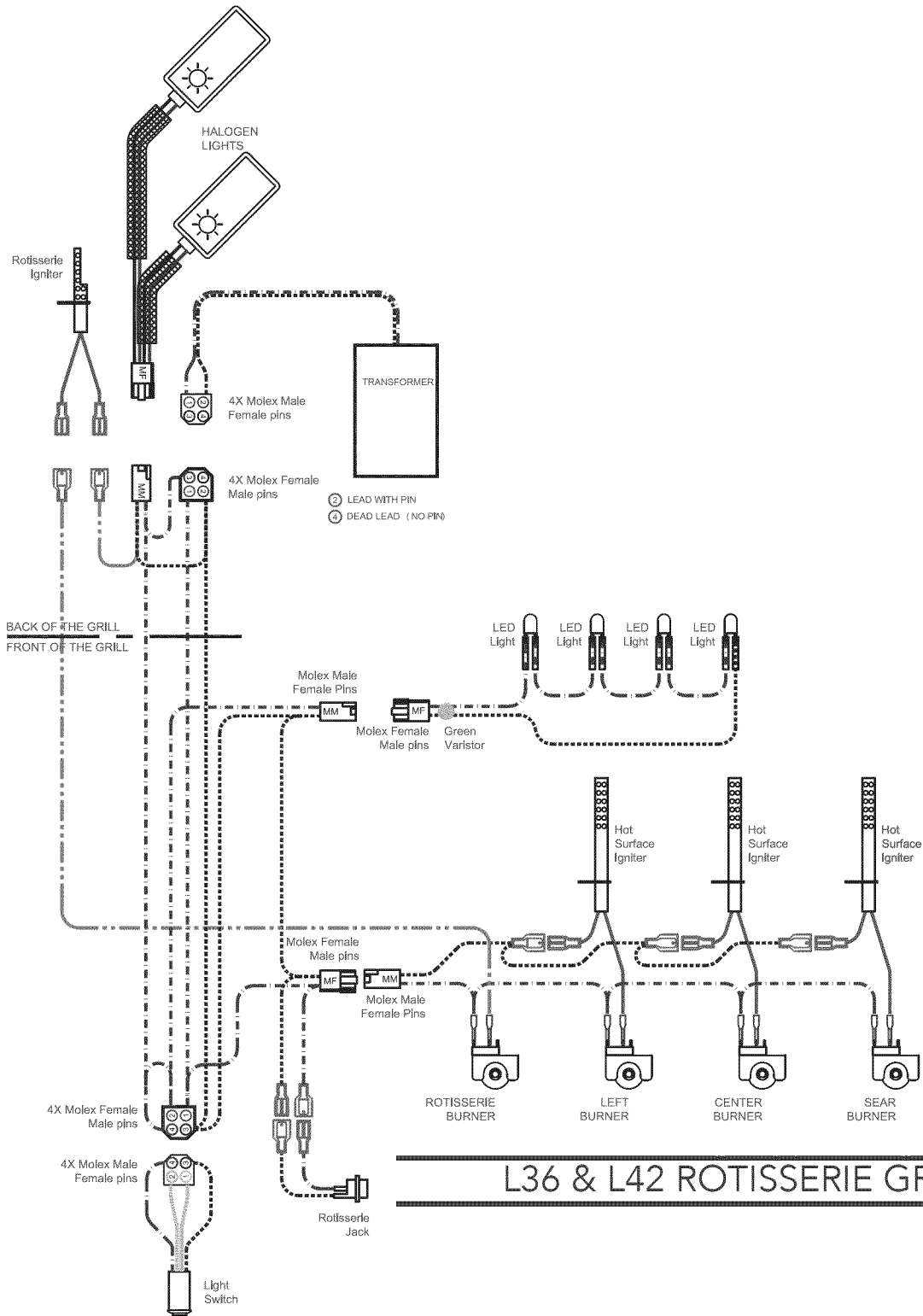

L36 & L42 ROTISSERIE GRILL

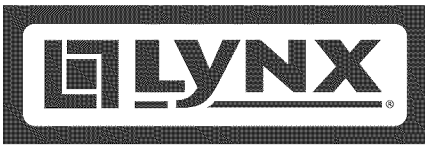

PROFESSIONAL GRILLS

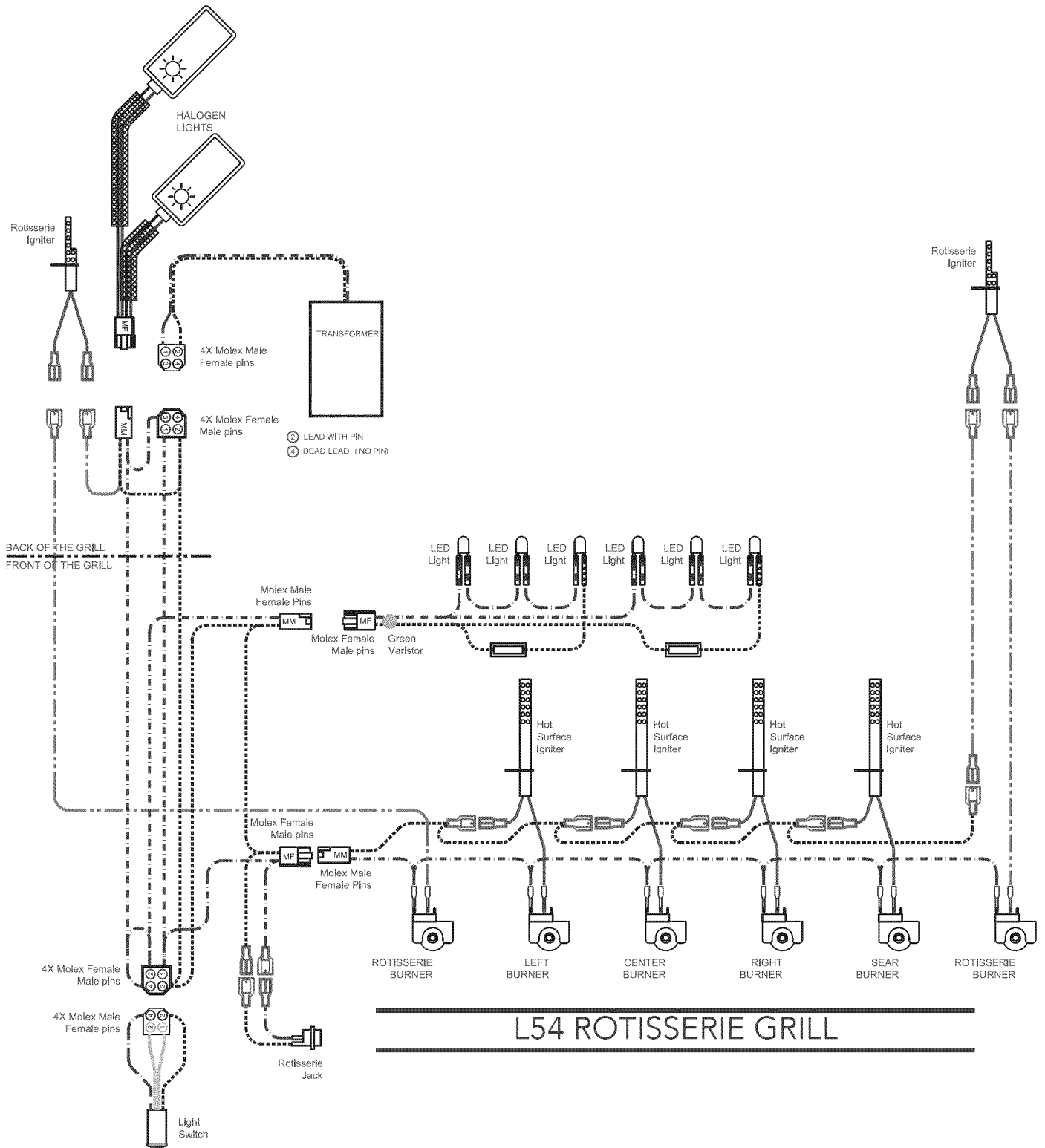

L54 ROTISSERIE GRILL

2010 LYNX PROFESSIONAL GRILLS EXPLODED PARTS VIEW

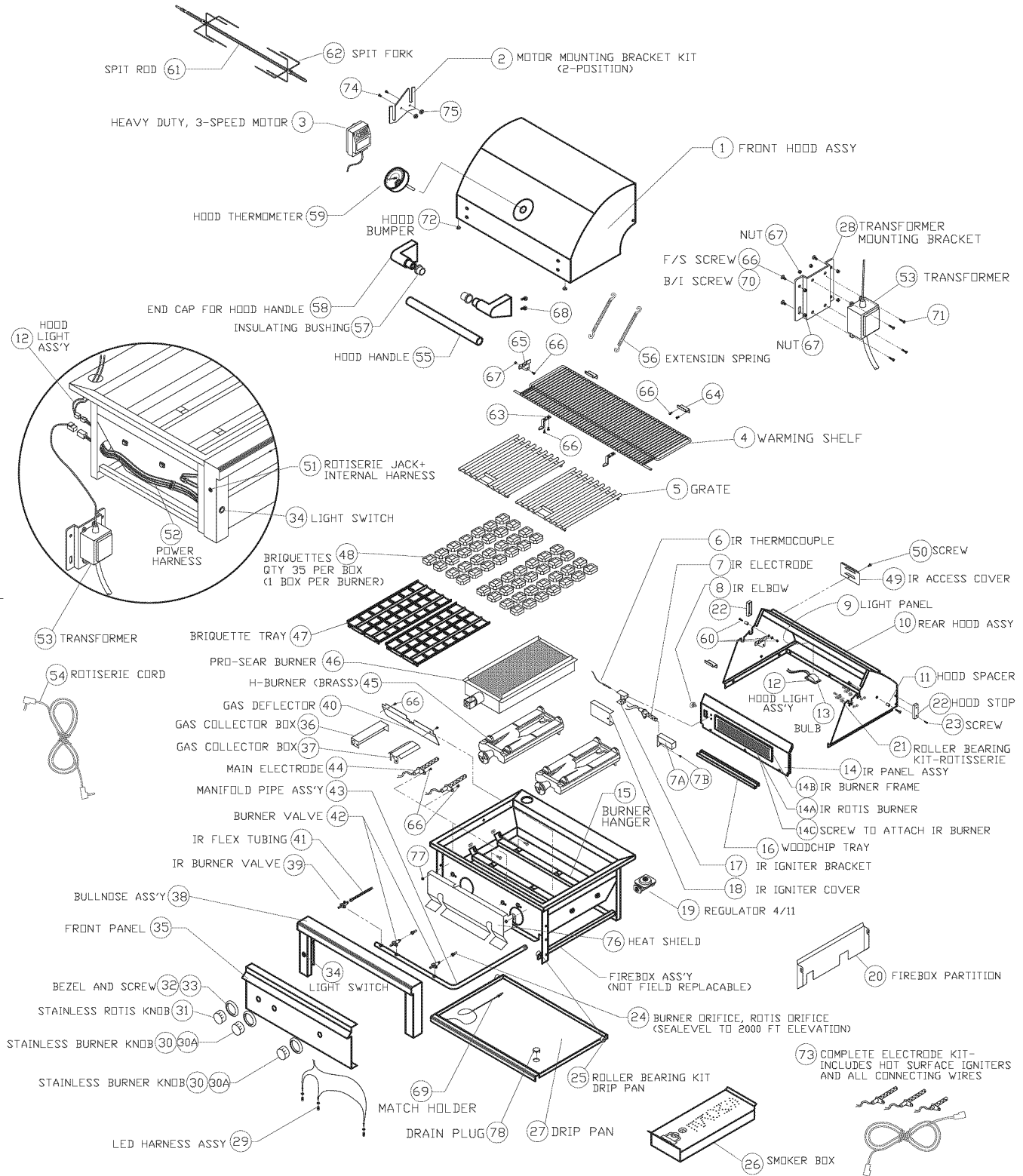

ITEM	GRILL SIZE	PART NO.	DESCRIPTION	ITEM	GRILL SIZE	PART NO.	DESCRIPTION
1	L27	80322	FRONT HOOD ASSY, 27"	35	L27	32546	FRONT PANEL, PRO 27" 2008
	L30	80309	FRONT HOOD ASSY, 30"		L27	32547	FRONT PANEL, NON-IR, PRO 27" 2008
	L36	80310	FRONT HOOD ASSY, 36"		L30	31670	FRONT PANEL, 30"
	L42	80311	FRONT HOOD ASSY, 42"		L36	31682	FRONT PANEL, 36"
	L54	80312	FRONT HOOD ASSY, 54"		L42	31687	FRONT PANEL, 42"
2	ALL	90132	MOTOR MOUNTING BRACKET KIT, ALL PRO		L54	31691	FRONT PANEL, 54"
3	ALL	80277	MOTOR ASSY, HEAVY DUTY 3 SPEED	36	ALL	33058	GAS COLLECTOR BOX, H-BURNER
4	L27	32555	WARMING SHELF, PRO 27"	37	PS MODELS	33092	GAS COLLECTOR BOX, PROSEAR BURNER
	L30	32109	WARMING SHELF, PRO 30"	38	L27	80317	BULLNOSE ASSY, PRO 27" 2008
	L36	32110	WARMING SHELF, PRO 36"		L30	80261	BULLNOSE ASSY, 30", 2007
	L42	32111	WARMING SHELF, PRO 42"		L36	80263	BULLNOSE ASSY, 36", 2007
	L54	32112	WARMING SHELF, PRO 54"		L42	80265	BULLNOSE ASSY, 42", 2007
5	L27	17012	(2) GRATES- 12" x 18"		L54	80268	BULLNOSE ASSY, 54", 2007
	L30	30018	(2) GRATES- 13 1/2" X 21"	39	ALL	31772	IR BURNER VALVE W/ MICROSWITCH
	L36	17020	(2) GRATES- 16 1/2" X 18 1/2"	40	L27 P/S	33131	GAS DEFLECTOR, 27"/30" PROSEAR, 2010
	L42	30018	(2) GRATES- 13 1/2" X 21"		L30 P/S	33131	GAS DEFLECTOR, 27"/30" PROSEAR, 2010
	L42	30019	(1) GRATE- 12" X 21" (CENTER)		L36 P/S	33132	GAS DEFLECTOR, 36" PROSEAR, 2010
	L54	30018	(2) GRATES- 13 1/2" X 21"		L42 P/S	33133	GAS DEFLECTOR, 42" PROSEAR, 2010
	L54	30019	(2) GRATES- 12" X 21"		L54	33134	GAS DEFLECTOR, PRO 54" 2010 (PROSEAR)
6	ALL	20018	IR THERMOCOUPLE	41	ALL	31794	FLEX HOSE, 9 MM X 38" W/ 7/16 FITTINGS
7	ALL	33052	IR ELECTRODE, HOT SURFACE (SEE ALSO #73)	42	ALL	32846	MAIN BURNER VALVE W/ MICROSWITCH
7A	ALL	33093	GAS COLLECTOR BOX, IR ROTIS.	43	L27	80251	MANIFOLD ASSY W/VALVES, 27" LP
	L54	33102	GAS COLLECTOR BOX, IR ROTIS, R/H 54"		L27	80252	MANIFOLD ASSY W/VALVES, 27" LP NON IR
7B	ALL	14018	SCREW, #6-32 X 1/4 PH. PAN HD		L27	80253	MANIFOLD ASSY W/VALVES, 27" NG
8	ALL	31795	IR BRASS ELBOW, 7/16-20 MALE THREAD		L27	80254	MANIFOLD ASSY W/VALVES, 27" NG NON IR
9	L27	32551	LIGHT PANEL/REAR HOOD LINER, 27" 2008		L27	80429	MANIFOLD ASSY W/VALVES, 27" LP PROSEAR
	L30	32156	LIGHT PANEL/REAR HOOD LINER, 30" 2007		L27	80428	MANIFOLD ASSY W/VALVES, 27" NG PROSEAR
	L36	32441	LIGHT PANEL FOR DUAL LIGHTS, 36" 2008		L30	80211	MANIFOLD ASSY W/VALVES, 30" LP PROSEAR
	L42	32442	LIGHT PANEL FOR DUAL LIGHTS, 42" 2008		L30	80212	MANIFOLD ASSY W/VALVES, 30" LP
	L54	32159	LIGHT PANEL FOR DUAL LIGHTS, 54" 2007		L30	80213	MANIFOLD ASSY W/VALVES, 30" NG PROSEAR
10	L27	80320	REAR HOOD ASSY, PRO 27" 2008		L30	80214	MANIFOLD ASSY W/VALVES, 30" NG
	L27	80321	REAR HOOD ASSY, PRO 27" NON-IR 2008		L36	80227	MANIFOLD ASSY W/VALVES, 36" LP PROSEAR
	L30	80269	REAR HOOD ASSY, PRO 30" 2007/2008		L36	80228	MANIFOLD ASSY W/VALVES, 36" LP
	L36	80270	REAR HOOD ASSY, PRO 36" 2007/2008		L36	80229	MANIFOLD ASSY W/VALVES, 36" NG PROSEAR
	L42	80271	REAR HOOD ASSY, PRO 42" 2007/2008		L36	80230	MANIFOLD ASSY W/VALVES, 36" NG
	L54	80272	REAR HOOD ASSY, PRO 54" 2007/2008		L42	80201	MANIFOLD ASSY W/VALVES, 42" LP PROSEAR
11	ALL	20054	HOOD SPACER, ALL PRO SERIES		L42	80202	MANIFOLD ASSY W/VALVES, 42" LP
12	27,30	80446	HOOD LIGHT ASSY, SINGLE W/10W BULB, 2010		L42	80203	MANIFOLD ASSY W/VALVES, 42" NG PROSEAR
	36,42,54	80447	HOOD LIGHT ASSY, DUAL W/10W BULB, 2010		L42	80204	MANIFOLD ASSY W/VALVES, 42" NG
13	ALL	31979	BULB, REPLACEMENT, 10W HALOGEN		L54	80220	MANIFOLD ASSY W/VALVES, 54" LP PROSEAR
14	L27	80318	IR PANEL ASSY, PRO 27" 2010 (INCLUDES BURNER)		L54	80221	MANIFOLD ASSY W/VALVES, 54" NG PROSEAR
	27 NON-IR	80319	REAR FINISHING PANEL, NON-IR, PRO 27" 2008	44	ALL	33051	ELECTRODE, MAIN BURNER, HOT SURFACE (SEE #73)
	L30	80273	IR PANEL ASSY, 30" 2010 (INCLUDES BURNER)	45	30,42,54	30485	H-BURNER (BRASS)
	L36	80274	IR PANEL ASSY, 36" 2010 (INCLUDES BURNER)		27,36	11012	H-BURNER (BRASS)
	L42	80275	IR PANEL ASSY, 42" 2010 (INCLUDES BURNER)	46	PS MODELS	33000	PROSEAR BURNER, 30", 42", 54", 2009
	L54	80276	IR PANEL ASSY, 54" 2010 (INCLUDES BURNER)		PS MODELS	32915	PROSEAR BURNER, SHORT, 27"/36" 2010
14A	L27	32988	IR ROTIS. BURNER ONLY (SMALL-16 IN.)	47	30,42,54	80015	BRIGUETTE TRAY, 30", 42", 54"
	30,36,54	32989	IR ROTIS. BURNER ONLY (MEDIUM-21 IN.)		30,42,54	90071	COMPLETE TRAY W/ BRIGUETTES & CLIPS
	L42	32990	IR ROTIS. BURNER ONLY (LARGE-28 IN.)		42,54	80033	BRIGUETTE TRAY, NARROW, 42", 54"
14B	L27	32991	IR BURNER FRAME ONLY (SMALL-16 IN.)		42,54	90072	COMPLETE TRAY W/ BRIGUETTES & CLIPS
	30,36,54	32992	IR BURNER FRAME ONLY (MEDIUM-21 IN.)		27,36	80232	BRIGUETTE TRAY, 27", 36"
	L42	32993	IR BURNER FRAME ONLY (LARGE-28 IN.)		27,36	90070	COMPLETE TRAY W/ BRIGUETTES & CLIPS
14C	ALL	32644	SCREW, #8-32 X 5/16 PH. FLAT HD	48	ALL	90053	BRIGUETTES, 35 PER BOX
15	L27	10067	BURNER HANGER, PRO 27" 2010	49	ALL	30417	IR ACCESS COVER
	L30	32484	BURNER HANGER, PRO 30" 2010	50	ALL	14012	SCREW, 1/4-20 X 3/8 PH TRUSS HD, S/S
	L36	32245	BURNER HANGER, PRO 36" 2010	51	ALL	80440	ROTISERIE JACK + INTERNAL HARNESS, 2010
	L42	32485	BURNER HANGER, PRO 42" 2010	52	ALL	80438	MAIN POWER HARNESS, 2010 (27IR, 30, 36, 42, 54)
	L54	32486	BURNER HANGER, PRO 54" 2010		L27 NON-IR	80439	MAIN POWER HARNESS, 27" NON-IR, 2010
16	27,30,54	10159	WOODCHIP TRAY (27", 30", 54")	53	ALL	33100	TRANSFORMER, 5 AMP, PRO 2010
	36,42	10158	WOODCHIP TRAY (36", 42")	54	ALL	31170	ROTISERIE EXTERNAL CORD
17	ALL	33059	IR IGNITER BRACKET, PRO 2010	55	L27	32557	HOOD HANDLE, 27", 2008
	L54	33060	IR IGNITER BRACKET, RIGHT, 54" 2010		L30	32522	HOOD HANDLE, 30", 2008
18	L30	33135	IR IGNITER COVER, PRO 30" 2010		L36	32523	HOOD HANDLE, 36", 2008
	27,36,42,54	33136	IR IGNITER COVER 2010 (27", 36", 42", 54")		L42	32524	HOOD HANDLE, 42", 2008
19	ALL	30781	REGULATOR 4/11 N/G ONLY		L54	32525	HOOD HANDLE, 54", 2008
	ALL	13053	REGULATOR W/30" HOSE DOUBLE STAGE-LP	56	30,42,54	31874	EXTENSION SPRING, 30", 42", 54"
20	30,42,54	32743	FIREBOX PARTITION, 30", 42", 54"-2008		27,36	31780	EXTENSION SPRING, 27", 36"
	L36	33056	FIREBOX PARTITION, PRO 36"-2010	57	ALL	31738	INSULATING BUSHING, HOOD HANDLE
21	ALL	90128	ROLLER BEARING KIT-ROTISERIE (2 PARTS EA)	58	ALL	31736	END CAP FOR HOOD HANDLE
22	ALL	32468	HOOD STOP, PRO 2008	59	ALL	31200	HOOD THERMOMETER
23	ALL	32469	SCREW/HOOD STOP-#8-32 X 1" PH TRUSS HD	60	ALL	14013	PIVOT SCREW, 1/4-20 X 1" HEX DRIVE
24	L27,L36	PRENGK	COMPLETE DRIFICE FIELD KIT-LP TO NG		ALL	14009	PIVOT SCREW NUT, HEX, 1/4-20 S/S
	L27,L36	PRELPK	COMPLETE DRIFICE FIELD KIT-NG TO LP		ALL	14026	PIVOT WASHER, SPLIT LOCK, 1/4 S/S
	30,42,54	PRONGK	COMPLETE DRIFICE FIELD KIT-LP TO NG	61	L27	32556	SPIT ROD, PRO 27" 2008
	30,42,54	PRDLPK	COMPLETE DRIFICE FIELD KIT-NG TO LP		L30	32128	SPIT ROD, 30" 2007
	L27,L36	13013	DRIFICE,BURNER, NG (#41 SHORT)		L36	32129	SPIT ROD, 36" 2007
	L27,L36	13019	DRIFICE,BURNER, LP (#53 SHORT)		L42	32130	SPIT ROD, 42" 2007
	30,42,54	30329	DRIFICE,BURNER, NG (#41 LONG)		L54	32131	SPIT ROD, 54" 2007
	30,42,54	30328	DRIFICE,BURNER, LP (#53 LONG)	62	ALL	31563	SPIT FORK, HEAVY DUTY, ALL SIZES
	PROSEAR	13015	DRIFICE,BURNER, NG (#44 SHORT)	63	ALL	33033	FRONT RETAINING BKT, WARMING RACK 2010
	PROSEAR	13020	DRIFICE,BURNER, LP (#54 SHORT)	64	ALL	32133	REAR RETAINING BRACKET, WARMING RACK
	30,36,54	13016	DRIFICE, IR ROTIS., NG (#50 SHORT)	65	ALL	32194	LEFT RETAINING BRACKET, WARMING RACK
	30,36,54	13021	DRIFICE, IR ROTIS., LP (#57 SHORT)	66	ALL	14014	SCREW #8-32 X 3/8 PH TRUSS HEAD S/S
	L27"	13016	DRIFICE, IR ROTIS., NG (#50 SHORT)	67	ALL	14024	LOCK NUT, #8-32, S/S
	L27"	13021	DRIFICE, IR ROTIS., LP (#57 SHORT)	68	ALL	14030	BOLT, HEX HEAD, 1/4-20 X 1/2", S/S
	L42"	30470	DRIFICE, IR ROTIS., NG (#48 SHORT)	69	ALL	31031	ALTERNATE LIGHTING DEVICE, MATCH HOLDER
	L42"	31342	DRIFICE, IR ROTIS., LP (#56 SHORT)	70	ALL	31013	SCREW, #8 X 1/2 PH TRUSS HD TYPE 'A'
25	ALL	90129	ROLLER BEARING KIT-DRIP PAN (2 PARTS EA)	71	ALL	31649	SCREW, #8-32 X 5/8 PH. PAN HD, S/S
26	30,42,54	90073	SMOKER BOX ASSY 30", 42", 54"	72	ALL	32477	HOOD BUMPER, .500 DIA
	27,36	90074	SMOKER BOX ASSY, 27", 36"	73	L27 NON-IR	90146	COMPLETE ELECTRODE KIT, 27" NON-IR,2010
27	L27	32548	DRIP PAN, PRO 27" 2008		27,30	90147	COMPLETE ELECTRODE KIT, 27"IR/30", 2010
	L30	18050	DRIP PAN, 30"		36,42	90148	COMPLETE ELECTRODE KIT, 36"/42", 2010
	L36	31494	DRIP PAN, 36"		L54	90149	COMPLETE ELECTRODE KIT, 54" 2010
	L42	18051	DRIP PAN, 42"	74	ALL	32190	SCREW, #10-32 X 1-1/4 PH FLAT HD S/S
	L54	31324	DRIP PAN, 54"	75	ALL	32939	ROTIS. SPACER
28	ALL	33130	TRANSFORMER MOUNTING BRKT B/1 & F/S	76	L27	32596	HEAT SHIELD, PRO 27"
29	27 NON-IR	80434	LED HARNESS ASSY, 27" NON-IR, 2010		L27	33061	HEAT SHIELD, PROSEAR 27"
	27,30	80435	LED HARNESS ASSY, 27"IR/30", 2010		L30	31669	HEAT SHIELD, PRO 30"
	36,42	80436	LED HARNESS ASSY, 36"/42", 2010		L30	31813	HEAT SHIELD, PROSEAR 30"
	L54	80437	LED HARNESS ASSY, 54", 2010		L36	31815	HEAT SHIELD, PRO 36"
30	ALL	90137	KNOB, BURNER, STAINLESS		L36	31816	HEAT SHIELD, PROSEAR 36"
30A	ALL	90139	KNOB KIT, STAINLESS (3 BURNER+1 ROTIS)		L42	31698	HEAT SHIELD, PRO 42"
31	ALL	90136	KNOB, ROTIS., STAINLESS		L42	31817	HEAT SHIELD, PROSEAR 42"
32	ALL	10001	BEZEL		L54	32275	HEAT SHIELD, PROSEAR 54"
33	ALL	31929	BEZEL SCREW, #6-32 X 1/8 PH PAN	77	ALL	14023	NUT, COMBINATION (FOR HEAT SHIELD)
34	ALL	33148	LIGHT SWITCH + HARNESS, BLUE LIGHTED 2010	78	ALL	90151	DRAIN PLUG AND SEAL KIT, DRIP PAN

MODEL-SPECIFIC BTU OUTPUTS				
MODEL	H BURNER	ROTISSERIE	PROSEAR	TOTAL INPUT
L27(F)-2	2 @ 25,000 Btu			50,000 Btu/Hr
L27(F)R-2	2 @ 25,000 Btu	1 @ 14,000		64,000 Btu/Hr
L27PS(F)R-2	1 @ 25,000 Btu	1 @ 14,000	1 @ 23,000	62,000 Btu/Hr
L30R(F)-1	2 @ 25,000	1 @ 14,000		64,000 Btu/Hr
L30PS(F)R-1	1 @ 25,000	1 @ 14,000	1 @ 23,000	62,000 Btu/Hr
L36R-1	3 @ 25,000	1 @ 14,000		89,000 Btu/Hr
L36PS(F)R-1	2 @ 25,000	1 @ 14,000	1 @ 23,000	87,000 Btu/Hr
L42R-1	3 @ 25,000	1 @ 16,000		91,000 Btu/Hr
L42PS(F)R-1	2 @ 25,000	1 @ 16,000	1 @ 23,000	89,000 Btu/Hr
L54PS(F)R-1	3 @ 25,000	2 @ 14,000	1 @ 23,000	126,000 Btu/Hr

MAXIMUM RUNS FOR ALL APPLIANCES ON SUPPLY LINE	
Run Length 3/4" Pipe (in feet)	Max BTU for all Appliances on line
10	360,000
20	245,000
30	198,000
40	169,000
50	150,000
60	135,000
70	123,000
80	115,000

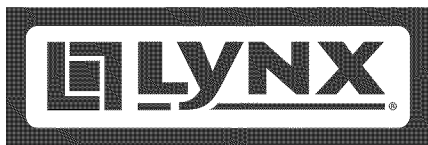

PROFESSIONAL GRILLS

INDEX

A		G		P	
Air Flame/Flow Adjustment.....	34	Gas Connections	31	Parts List	41
Adjustment	34	Gas Line Purging	33	Parts View, Exploded.....	40
Air Shutter Adjustment.....	34	Gas Requirements	31	Pre-Heating ProSear Burner	13
		Gas Supply Line Runs	32	Pre-Heating the Grill.....	12
		Grilling in Windy Conditions	8	Purging the Gas Line	33
B		L		R	
BTU Outputs, Model Specific...	42	Leak Test Procedure	33	Regulator Conversion.....	31
Burner Adjustment, Low.....	33	Lighting, Manual.....	11		
Burner Adjustment, Main	34	Lighting Your Grill.....	10	S	
Burner Placement	17	Liting the Rotisserie Burner	10	Schematic, L27 & L30.....	37
		Low Heat burner adjustment....	33	Schematic, L27 Non-Rotisserie.	36
C		M		Schematic, L36 & L42.....	38
Clean the Brass Burner.....	17	Manual Lighting.....	11	Schematic, L54	39
Contacting LYNX	22	Match Lighting	11	Schematics.....	36
Cut-out Dim., Built-in Grills	28	Maximum Runs for all appliances on supply line	42	Service, contacting Lynx.....	22
		Maxitrol Regulator	31		
E		O		T	
Exploded Parts View.....	40	Obtaining Service From LYNX..	22	Technical Support.....	22
				W	
F				Windy Conditions, Grilling in	8
Flame, Correct Size	34				

NOTES



NOTES

Lynx Professional Grills
6023 Bandini Blvd.
Commerce CA 90040
Service: (888) Buy-Lynx (888-289-5969)
Fax: (323) 838-1778
www.lynxgrills.com



PROFESSIONAL GRILLS