

Operator's Manual

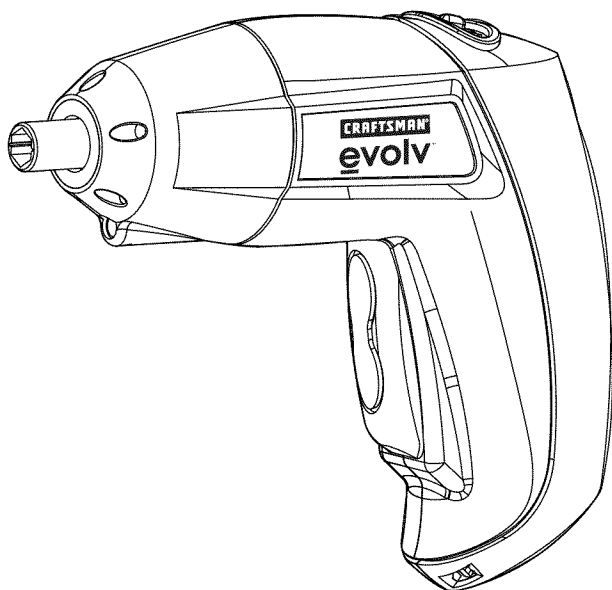

3.6 Volt SCREWDRIVER

Model No. 320.17088



CHARGE BATTERY
BEFORE FIRST USE

▲ WARNING: To reduce the risk of injury, the user must read and understand the **Operator's Manual** before using this product.

- WARRANTY
- SAFETY
- ASSEMBLY
- OPERATION
- MAINTENANCE

Sears Brands Management Corporation

www.craftsman.com

TABLE OF CONTENTS

Warranty	page 2
Safety Symbols	page 3
Safety Instructions	page 4-9
Description	page 9-10
Assembly	page 10-11
Operation	page 12-14
Maintenance	page 15
Troubleshooting	page 15
Exploded View and Part List	page 16-17
Sears Repair Parts Phone Number	Back Cover

CRAFTSMAN® EVOLV FULL WARRANTY

If this Craftsman® Evolv tool fails to give complete satisfaction within one year from the date of purchase, return it to any Sears store or other Craftsman® Evolv outlet in the United States for free replacement.

This warranty is void if this product is ever used for commercial or rental purposes.

This warranty gives you specific legal rights, and you may also have other rights, which vary from state to state.

Sears, Roebuck and Co., Hoffman Estates, IL 60179

⚠ WARNING: Some dust created by using power tools contains chemicals known to the state of California to cause cancer and birth defects or other reproductive harm.

SAVE THESE INSTRUCCIONES!

READ ALL INSTRUCTIONS!

SAFETY SYMBOLS

The purpose of safety symbols is to attract your attention to possible dangers. The safety symbols and the explanations with them deserve your careful attention and understanding. The symbol warnings do not, by themselves, eliminate any danger. The instructions and warnings they give are no substitutes for proper accident prevention measures.

⚠ WARNING: Be sure to read and understand all safety instructions in this manual, including all safety alert symbols, such as “**DANGER**,” “**WARNING**,” and “**CAUTION**,” before using this screwdriver. Failure to following all instructions listed below may result in electric shock, fire and/or serious personal injury.

SYMBOL MEANNING

⚠ SAFETY ALERT SYMBOL: Indicates **DANGER, WARNING, OR CAUTION.** May be used in conjunction with other symbols or pictographs.

⚠ DANGER: Failure to obey this safety warning will result in death or serious injury to yourself or to others. Always follow the safety precautions to reduce the risk of fire, electric shock, and personal injury.

⚠ WARNING: Failure to obey this safety warning can result in death or serious injury to yourself or to others. Always follow the safety precautions to reduce the risk of fire, electric shock, and personal injury.

⚠ CAUTION: Failure to obey this safety warning may result in death or serious injury to yourself or to others. Always follow the safety precautions to reduce the risk of fire, electric, shock and personal injury.

DAMAGE PREVENTION AND INFORMATION MESSAGES

These inform user of important information and/or instructions that could lead to equipment or other property damage if not followed. Each message is preceded by the word “**NOTE**” as in the example below.

NOTE: Equipment and/or property damage may result if these instructions are not followed.



The operation of any power tool can result in foreign objects being thrown into your eyes, which can result in severe eye damage. Before beginning power tool operation, always wear safety goggles or safety glasses with side shields and a full-face shield when needed. We recommend a Wide Vision Safety Mask for use over eyeglasses or standard safety glasses with side shields, available at Sears Stores or other Craftsman outlets. Always use eye protection that is marked to comply with ANSI Z87.1

SAFETY INSTRUCTIONS

⚠ WARNING: Read all safety warnings and instructions. Failure to follow the warnings and instructions may result in electric shock, fire and / or serious injury.

⚠ WARNING: Do not attempt to operate this tool until you have thoroughly read all instructions, safety rules, and warnings. Failure to comply with them can result in fire, electric shock, or serious personal injury. Save the manual and refer to it frequently.

Save all warnings and instructions for future reference.

The term power tool in the warnings refers to your mains-operated (corded) power tool or battery-operated (cordless) power tool.

GENERAL SAFETY PRECAUTIONS

WORK AREA SAFETY

- **Keep work area clean and well lit.** Cluttered or dark areas invite accidents.
- **Do not operate power tools in explosive atmospheres, such as in the presence of flammable liquids, gases or dust.** Power tools create sparks which may ignite the dust or fumes.
- **Keep children and bystanders away while operating a power tool.** Distractions cause you to lose control.

ELECTRICAL SAFETY

• **Power tool plugs must match the outlet. Never modify the plug in any way. Do not use any adapter plugs with earthed (grounded) power tools.** Unmodified plugs and matching outlets will reduce risk of electric shock.

• **Avoid body contact with earthed or grounded surfaces such as pipes, radiators, ranges and refrigerators.** There is an increased risk of electric shock if your body is earthed or grounded.

• **Do not expose power tools to rain or wet conditions.** Water entering a power tool will increase the risk of electric shock.

• **Do not abuse the cord. Never use the cord for carrying, pulling or unplugging the power tool. Keep cord away from heat, oil, sharp edges or moving parts.** Damaged or entangled cords increase the risk of electric shock.

• **When operating a power tool outdoors, use an extension cord suitable for outdoor use.** Use of a cord suitable for outdoor use reduces the risk of electric shock.

• **If operating a power tool in a damp location is unavoidable, use a residual current device (RCD) protected supply.** Use of an RCD reduces the risk of electric shock.

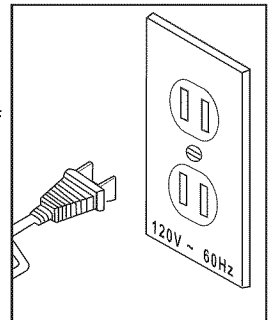

PERSONAL SAFETY

- **Stay alert, watch what you are doing and use common sense when operating a power tool. Do not use tool while tired or under the influence of drugs, alcohol, or medication.** A moment of inattention while operating power tools may result in serious personal injury.
- **Dress properly. Do not wear loose clothing or jewelry. Contain long hair. Keep your hair, clothing, and gloves away from moving parts.** Loose clothes, jewelry, or long hair can be caught in moving parts.
- **Prevent unintentional starting. Ensure the switch is in the off-position before connecting to power source and / or battery pack, picking up or carrying the tool.** Carrying tools with your finger on the switch or inserting the battery pack into a tool with the switch on invites accidents.
- **Remove any adjusting key or wrenches before turning the tool on.** A wrench or a key that is left attached to a rotating part of the tool may result in personal injury.
- **Do not overreach. Keep proper footing and balance at all times.** Proper footing and balance enables better control of the tool in unexpected situations.
- **Use personal protective equipment. Always wear eye protection.** Protective equipment such as dust mask, non-skid safety shoes, hard hat, or hearing protection used for appropriate conditions will reduce personal injuries.
- **If devices are provided for the connection of dust extraction and collection facilities, ensure these are connected and properly used.** Use of these devices can reduce dust-related hazards.

POWER TOOL USE AND CARE

- **Do not force tool. Use the correct tool for your application.** The correct tool will do the job better and safer at the rate for which is designed.
- **Do not use tool if switch does not turn it on or off.** Any tool that cannot be controlled with the switch is dangerous and must be repaired.
- **Disconnect the plug from the power source and/or the battery pack from the power tool before marking any adjustments, changing accessories, or storing power tools.** Such preventive safety measures reduce the risk of starting the power tool accidentally.
- **Store idle tools out of reach of children and other untrained persons.** Tools are dangerous in the hands of untrained users.
- **Maintain tools with care. Check for misalignment or binding of moving parts, breakage of parts, and any other condition that may affect the tools operation. If damaged, have the tool serviced before using.** Many accidents are caused by poorly maintained tools.

- **Keep cutting tools sharp and clean.** Properly maintained cutting tools with sharp cutting edges are less likely to bind and are easier to control.
- **Use the power tool, accessories and tool bits etc., in accordance with these instructions , taking into account the working conditions and the work to be performed.** Use of the power tool for operations different from those intended could result in a hazardous situation.

BATTERY TOOL USE AND CARE



- **Recharge only with the charger specified by the manufacturer.** A charger that is suitable for one type of battery pack may create a risk of fire when used with another battery pack.
- **Use power tools only with specifically designated battery packs.** Use of any other battery packs may create a risk of injury and fire.
- **When battery pack is not in use, keep it away from other metal objects, like paper clips, coins, keys, nails, screws or other small metal objects, that can make a connection from one terminal to another.** Shorting the battery terminals together may cause burns or a fire.
- **Under abusive conditions, liquid may be ejected from the battery; avoid contact. If contact accidentally occurs, flush with water. If liquid contacts eyes, additionally seek medical help.** Liquid ejected from the battery may cause irritation or burns.



SERVICE

- **Have your power tool serviced by a qualified repair person using only identical replacement parts.** This will ensure that the safety of the power tool is maintained.

SAFETY SYMBOLS FOR YOUR TOOL

The label on your tool may include the following symbols.

- V..... Volts
- A..... Amps
- Hz..... Hertz
- W..... Watts
- min..... Minutes
- ..... Alternating Current
- ..... Direct Current

- n_o No-load Speed
- ..... Class II construction
- .../min..... Revolutions or Strokes per minute
- ..... Indicates danger, warning caution.
It means attention! Your safety is involved.

SPECIFIC SAFETY RULES FOR SCREWDRIVER

⚠ WARNING: To avoid injury, hold the tool by the insulated gripping surfaces only. If the tool contacts hidden wiring or its own cord, exposed metal parts of the tool could shock the operator and cause serious injury. Make sure that hidden electrical wiring, water pipes, or other hazards are not in the cutting path.

⚠ WARNING: To reduce the risk of injury, user must read instruction manual.

- **Do not use dull or damaged bits and accessories.**
- **Only connect the power unit to a 120V AC supply.**
- Before screwing into a wall, check with a metal/voltage detector to be sure you are not driving into an electricity, gas, or water supply line.
- **Avoid frequent stalling when operating**, as this could damage the tool.
- **If the tool stalls, release the trigger immediately**, reverse the direction of rotation and slowly squeeze trigger to back out the bit.
- **Do not expose the tool and power unit to rain**; also protect them from moisture.
- **To protect the batteries from damage**, you should never expose them to temperature above 50 degrees centigrade. (122° F)
- **Do not charge the tool in a damp or wet location.** Following this rule will reduce the risk of electric shock.
- **Do not operate power unit with a damaged cord or plug.** If damaged, it should be replaced immediately. Contact or visit the nearest Sears service center for more information.
- **Do not operate power unit if it has received a sharp blow, been dropped**, or otherwise damaged in any way; take it to a qualified serviceman or contact or visit the nearest Sears service center for more information.
- **Disconnect power unit from power supply when not in use.** Following this rule will reduce the risk of electric shock, fire, or serious personal injury.
- **This power unit is intended to be correctly orientated in a vertical or floor mount position.**

SAFETY RULES FOR POWER UNIT

⚠ WARNING: Read and understand all instructions. Failure to follow all instructions listed below may result in electric shock, fire and/or serious personal injury.

Before using Power Unit, read all instructions and cautionary markings in this manual, on the power unit,, and the product using battery to prevent misuse of the products and possible injury or damage.

⚠ CAUTION: To reduce the risk of electric shock or damage to the power unit and rool, charge only this Ni-cad rechargeable tool .Other types of batteries may

burst, causing personal injury or damage.

Do not use Power unit outdoors or expose to wet or damp conditions.

Water entering charger will increase the risk of electric shock.

- **Use of an attachment not recommended or sold by the manufacturer may result in a risk of fire, electric shock or injury to persons.** Following this rule will reduce the risk of electric shock, fire or serious personal injury.
- **Do not abuse cord or power unit.** Never use the cord to carry the power unit. Do not pull the cord rather than the plug when disconnecting from receptacle. Damage to the cord or power unit could occur and create an electric shock hazard. Replace damaged cords immediately.
- **Make sure cord is located so that it will not be stepped on, tripped over, come in contact with sharp edges or moving parts or otherwise subjected to damage or stress.** This will reduce the risk of accidental falls, which could cause injury and damage to the cord, which could result in electric shock.
- **Keep cord and power unit from heat to prevent damage to housing or internal parts.**
- **Do not let gasoline, oils, petroleum-based products, etc. come in contact with plastic parts.** They contain chemicals that can damage, weaken or destroy plastic.
- **An extension cord should not be used unless absolutely necessary. Use of improper extension cord could result in a risk of fire and electric shock. If an extension cord must be used, make sure:**
 1. That pins on plug of extension cord are the same number, size and shape as hose of plug on charger.
 2. That extension cord is properly wired and in good electrical condition; and
 3. That wire size is large enough for AC ampere rating of charger as specified below:

Cord Length (Feet) 25' 50' 100'

Cord Size (AWG) 16 16 16

NOTE: AWG = American Wire Gauge

- **Do not operate the power unit with a damaged cord or plug,** which could cause shorting and electric shock. If damaged, have the power unit repaired or replaced by an authorized service technician at Sears Service Center.
- **Do not operate power unit if it has received a sharp blow, been dropped or otherwise damaged in any way.** Take it to an authorized service technician at Sears Service Center for an electrical check to determine if the power unit is in good working order.
- **Do not disassemble power unit.** Take it to an authorized service technician

at Sears Service Center when service or repair is required. Incorrect reassembly may result in a risk of electric shock or fire.

- **Disconnect power unit from the power supply when not in use.** This will help prevent damage to the power unit during a power surge.
- **Risk of electric shock.** Do not touch uninsulated portion of output connector or uninsulated battery terminal.
- **Save these instructions.** Refer to them frequently and use them to instruct others who may use this tool. If you loan someone this tool, loan them these instructions also to prevent misuse of the product and possible injury.

IMPORTANT SAFETY INSTRUCTIONS

- **Save these instructions.**
- **Before using power unit,** read all instructions and cautionary markings on battery power unit, and product using battery.

 **CAUTION:** To reduce the risk of injury, charge only this tool. Other types of batteries may burst, causing personal injury or damage.

 **WARNING:** When using electric appliances, basic precautions should always be followed, including the following.

- a) To reduce the risk of injury, close supervision is necessary when an appliance is used near children.
- b) Only use attachments recommended or sold by manufacturer.
- c) Do not use outdoors.
- d) For a portable appliance – To reduce the risk of electrical shock, do not put the screwdriver and Battery Pack in water or other liquid. Do not place or store appliance where or can fall or be pulled into a tub or sink.

 **WARNING:** Contains nickel-cadmium battery. Battery must be recycled or disposed of properly.

 **WARNING:** Do not dispose of this product in fire, batteries inside this product may explode or leak.

UNPACKING

⚠ WARNING: Your screwdriver should never be attached to the power unit when you are assembling parts, making adjustments, installing or removing bits, cleaning, or when it is not in use. When unpacking the box, do not discard any packing materials until all of the contents are accounted for:

1. Carefully lift the screwdriver out of the carton and place it on a stable, flat surface.
2. Open the box to locate the following:
 - Screwdriver
 - Power unit
 - Operator's manual
3. Inspect the items carefully to make sure that no breakage or damage has occurred during shipping. If any of the items mentioned is missing, (refer to "PARTS LIST" illustration), return the screwdriver to your nearest Sears store or Craftsman outlet to have the screwdriver replaced. Carefully remove the tool and any accessories from the box. Make sure that all items listed in the packing list are included.

⚠ WARNING: If any part is broken or missing, do not attempt to assemble the screwdriver, attach the power unit, or operate the screwdriver until the broken or missing part has been replaced. Failure to do so could result in possible serious injury.

CARTON CONTENTS/LOOSE PARTS (Fig. 1)

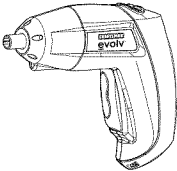
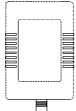
	Screwdriver	1
	Power unit	1

DESCRIPTION

KNOW YOUR SCREWDRIVER (Fig. 1)

Before attempting to use this screwdriver, familiarize yourself with all its operating features and safety requirements.

The screwdriver is a light-duty tool for tightening and loosening screws. It is lightweight and easy to use, featuring both a forward / reverse indicator and a

work light. To secure your new rechargeable screwdriver from possible failure, the battery is in a low-charge condition when initially shipped. Therefore, you should charge it at for least 10 hours prior to use. Charging your tool for at least 10 hours during the first cycle of use will insure optimum battery performance.

⚠ WARNING: Do not allow familiarity with your screwdriver to make you careless. Remember that a careless fraction of a second is sufficient enough to inflict severe injury.

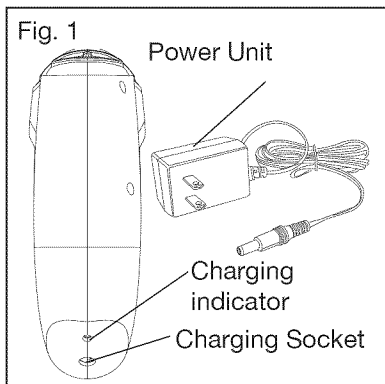

PRODUCT SPECIFICATIONS	
Power unit	Input: 120V~60HZ
	Output: 6V, DC 300mA
Rechargeable battery	3x1.2=3.6V DC Ni-Cd
Normal charging time	3-5 hours
Forward/Reverse rotation	YES
LED Worklight	YES
Collet size	1/4" hex Collet

⚠ WARNING: The safe use of this product requires an understanding of the information on the tool and in this operator's manual as well as knowledge of the project you are attempting. Before use of this product, familiarize yourself with all operating features and safety rules.

ON/OFF TRIGGER SWITCH

To turn the tool on, press the trigger switch. To turn the tool off, release the trigger switch.

FORWARD/REVERSE SWITCH

The forward/reverse switch should only be operated when the motor is NOT running.

SCREWDRIVER BIT COLLET

To hold 1" bits, bit holder, and socket adaptor.

WORK LIGHT

For low light situations.

POWER UNIT

After the initial charging cycle, the tool should be charged for 3-5 hours for optimum performance.

OPERATION

TO CHARGE (FIG. 2)

Make sure your screwdriver has completely stopped before attempting to charge it.

Insert the power unit plug into charging socket, making sure they are properly connected.

Power unit can be used with normal house voltage of 120 volts, 60 Hz, AC only.

Connect the power unit to the power supply.

Once the screwdriver is initially charged for at least 10 hours, optimum performance can be reached by recharging the screwdriver for 3-5 hours after use. It is not recommended to recharge the screwdriver for less than 3 hours or more than 15 hours after each use.

Do not place the power unit in an area of extreme heat or cold. It works best at normal room temperature.

The base of tool or power unit may become warm during charging.

INSTALLING SCREWDRIVER BITS (Fig.3)

Place a 1/4" bit directly into the screwdriver collet, or, insert it into the magnetic bit holder and then insert the bit holder into the screwdriver collet.

Note: Your screwdriver is intended for light-duty use.

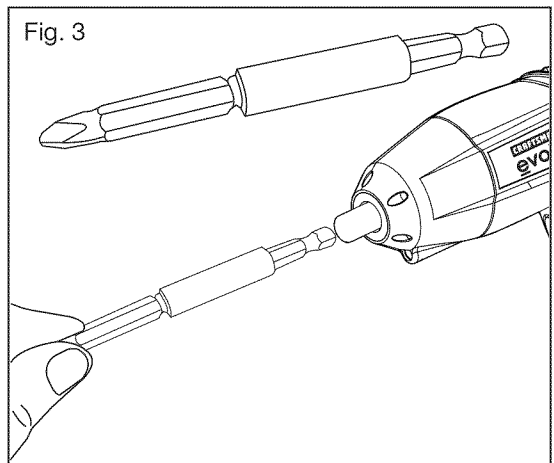
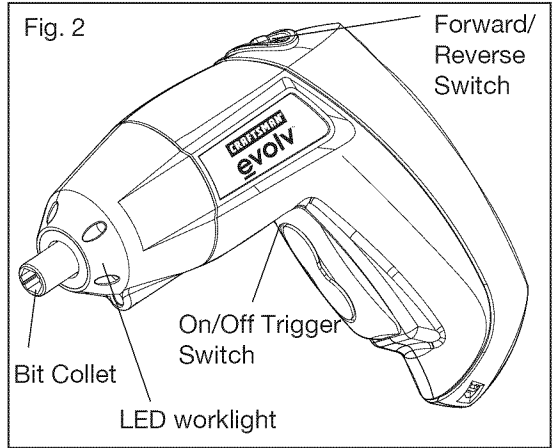

For best results, 1/4" screwdriver bits are recommended.

Never engage the trigger switch when changing screwdriver bits.

Always lock the trigger switch when changing drill bits. (See forward/reverse switch instructions)

FORWARD /REVERSE SWITCH (Fig.4)

The forward/reverse switch determines the running direction of the tool and also serves as a trigger switch lock.

To select "forward" motion, release the trigger switch and push the forward/reverse lever to the right side of the tool.

To select "reverse" motion, push the forward/reverse lever to the left side of the tool.

The center position of the switch locks the tool in the "OFF" position.

When changing the position of the switch, be sure the trigger is released.

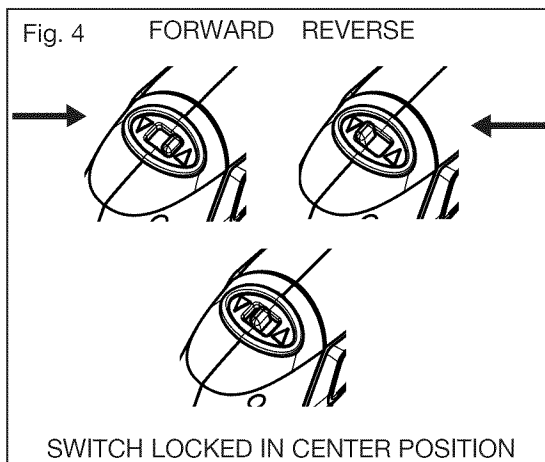

⚠ WARNING: Charging time must not exceed 15 hours; the battery may be damaged with excessive charging. Avoid charging your screwdriver in freezing conditions. The power unit provided must only be used with this screwdriver and not with any other products. Do not insert metal objects into the power unit. Never change the forward/reverse switch while the screwdriver is rotating as this will damage the screwdriver.

MAINTENANCE

⚠ WARNING: To ensure safety and reliability, all repairs should be performed by a qualified service technician at a Sears Service Center.

⚠ WARNING: For your safety, always turn off the switch and remove the battery pack from the tool before performing any maintenance or cleaning.

Periodic maintenance of your screwdriver allows for long life and trouble-free operation. A cleaning, and maintenance schedule should be maintained.

As a common-sense and preventive maintenance practice, follow these recommended steps:

- Inspect the bit; check the rim for wear or damage.
- Use a soft clean and damp cloth to wipe the tool housing. A mild detergent

can be used but nothing like alcohol, gasoline, or other such leaning agents. Never use caustic agents to clean plastic parts.

⚠ WARNING: Always wear safety goggles or safety glasses with side shields during power tool operations or when blowing dust. If operation is dusty, also wear a dust mask.

⚠ WARNING: Keep the tool air vents unclogged and clean at all times.

⚠ WARNING: Avoid using solvents when cleaning plastic parts. Most plastics are susceptible to damage from various types of commercial solvents and may be damaged by their use. Use a clean cloth to remove dirt, dust, oil, grease, etc.

⚠ WARNING: Do not at any time let brake fluids, gasoline, petroleum-based products, penetrating oils, etc. to come in contact with plastic parts. Chemicals can damage, weaken or destroy plastic which may result in serious personal injury.

⚠ WARNING: Water must never come into the tool.

TROUBLE SHOOTING

PROBLEM	CAUSE	SOLUTION
The screwdriver does not work	Battery pack is exhausted	Recharge the battery pack

PARTS LIST

Screwdriver MODEL NUMBER 320.17088

Always mention the Model Number when ordering parts for this tool

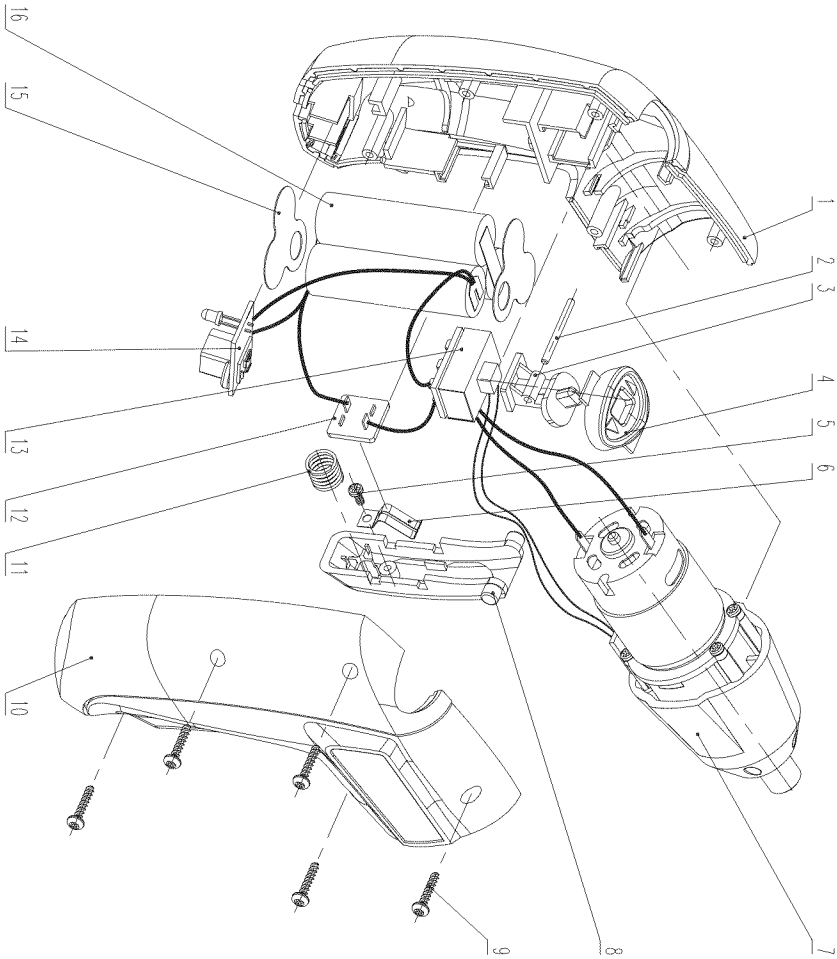

PARTS LIST

No	Part No	Part Name	QTY
1	43789	Left Housing	1
2	43773	Round Pin	1
3	43791	Reversing Levers	1
4	43792	Ornament Cover	1
5	70286	Tapping Screw	1
6	01109	Reed	1
7	TH0709-7	Gear Box	1
8	43790	Switch Button	1
9	70362	Tapping Screw	5
10	43789	Right Housing	1
11	43774	Spring	1
12	34700	Current-conducting Plate	1
13	43771	Reversing Levers Circuit Board	1
14	43772	Charging Circuit Board	1
15	92119	Paper Washer	2
16	90169	Battery Pack	1

NOTE

NOTE

Get it fixed, at your home or ours!

Your Home

For expert troubleshooting and home solutions advice:

manage my home

www.managemyhome.com

For repair – **in your home** – of **all** major brand appliances, lawn and garden equipment, or heating and cooling systems, **no matter who made it, no matter who sold it!**

For the replacement parts, accessories and owner's manuals that you need to do-it-yourself.

For Sears professional installation of home appliances and items like garage door openers and water heaters.

1-800-4-MY-HOME®

(1-800-469-4663)

www.sears.com

Call anytime, day or night

(U.S.A. and Canada)

www.sears.ca

Our Home

For repair of carry-in items like vacuums, lawn equipment, and electronics, call anytime for the location of the nearest **Sears Parts & Repair Service Center**

1-800-488-1222 (U.S.A.)

www.sears.com

1-800-469-4663 (Canada)

www.sears.ca

To purchase a protection agreement on a product serviced by Sears:

1-800-827-6655 (U.S.A.)

1-800-361-6665 (Canada)

Para pedir servicio de reparación a domicilio, y para ordenar piezas:

1-888-SU-HOGAR®

(1-888-784-6427)

Au Canada pour service en français:

1-800-LE-FOYER^{MC}

(1-800-533-6937)

www.sears.ca

Sears

© Sears Brands, LLC

® Registered Trademark / TM Trademark / SM Service Mark of Sears Brands, LLC

® Marca Registrada / TM Marca de Fábrica / SM Marca de Servicio de Sears Brands, LLC

^{MC} Marque de commerce / ^{MD} Marque déposée de Sears Brands, LLC