

# KitchenAid®

---

## MICROWAVE HOOD COMBINATION

### Use & Care Guide

For questions about features, operation, performance, parts, accessories or service, call: **1-800-422-1230** or visit our website at...  
[www.kitchenaid.com](http://www.kitchenaid.com)

---

Table of Contents..... 2



**Model KHMS147KSS**

4619-652-60611/8183932

---

# TABLE OF CONTENTS

<b>MICROWAVE OVEN SAFETY .....</b>	<b>3</b>
Electrical Requirements .....	5
<b>PARTS AND FEATURES .....</b>	<b>5</b>
Turntable .....	6
Cooking Rack .....	6
Crisper Pan.....	6
<b>MICROWAVE OVEN CONTROL PANEL .....</b>	<b>7</b>
MICRO-DIAL™ Control.....	7
Display .....	8
Clock .....	8
Tones.....	8
Minute Timer .....	9
Child Lock .....	9
Exhaust Fan.....	9
Cooktop/Countertop Light.....	9
Learning Mode .....	9
Demo Mode.....	9
Bookmark .....	10
<b>BEFORE USING .....</b>	<b>10</b>
Food Characteristics .....	10
Cooking Guidelines .....	11
Cookware and Dinnerware .....	11
Aluminum Foil and Metal .....	12
Cooking Power.....	12
<b>MICROWAVE OVEN USE .....</b>	<b>13</b>
Cooking .....	13
Popcorn.....	13
Cooking in Stages.....	13
Reheating .....	13
2-4 Plates .....	13
Defrosting .....	13
Easy Simmer .....	14
Pan Brown Feature .....	14
<b>MICROWAVE OVEN CARE.....</b>	<b>15</b>
General Cleaning.....	15
Hints .....	15
Replacing Filters.....	16
Replacing Cooktop Light .....	16
Replacing Microwave Oven Light .....	17
<b>TROUBLESHOOTING .....</b>	<b>18</b>
<b>ASSISTANCE OR SERVICE.....</b>	<b>19</b>
In the U.S.A. ....	19
<b>WARRANTY .....</b>	<b>20</b>

# MICROWAVE OVEN SAFETY

## Your safety and the safety of others are very important.

We have provided many important safety messages in this manual and on your appliance. Always read and obey all safety messages.



This is the safety alert symbol.

This symbol alerts you to potential hazards that can kill or hurt you and others.

All safety messages will follow the safety alert symbol and either the word "DANGER" or "WARNING." These words mean:

**! DANGER**

You can be killed or seriously injured if you don't immediately follow instructions.

**! WARNING**

You can be killed or seriously injured if you don't follow instructions.

All safety messages will tell you what the potential hazard is, tell you how to reduce the chance of injury, and tell you what can happen if the instructions are not followed.

## IMPORTANT SAFETY INSTRUCTIONS

When using electrical appliances basic safety precautions should be followed, including the following:

**WARNING:** To reduce the risk of burns, electric shock, fire, injury to persons, or exposure to excessive microwave energy:

- Read all instructions before using the microwave oven.
- Read and follow the specific "PRECAUTIONS TO AVOID POSSIBLE EXPOSURE TO EXCESSIVE MICROWAVE ENERGY" found in this section.
- The microwave oven must be grounded. Connect only to properly grounded outlet. See "GROUNDING INSTRUCTIONS" found in this section and in the provided Installation Instructions.
- Install or locate the microwave oven only in accordance with the provided Installation Instructions.
- Some products such as whole eggs in the shell and sealed containers – for example, closed glass jars – may explode and should not be heated in the microwave oven.
- Use the microwave oven only for its intended use as described in this manual. Do not use corrosive chemicals or vapors in the microwave oven. This type of oven is specifically designed to heat, cook, or dry food. It is not designed for industrial or laboratory use.
- As with any appliance, close supervision is necessary when used by children.
- Do not operate the microwave oven if it has a damaged cord or plug, if it is not working properly, or if it has been damaged or dropped.
- The microwave oven should be serviced only by qualified service personnel. Call an authorized service company for examination, repair, or adjustment.
- See door surface cleaning instructions in the "Microwave Oven Care" section.
- To reduce the risk of fire in the oven cavity:
  - Do not overcook food. Carefully attend the microwave oven if paper, plastic, or other combustible materials are placed inside the oven to facilitate cooking.
  - Remove wire twist-ties from paper or plastic bags before placing bags in oven.
  - If materials inside the oven should ignite, keep oven door closed, turn oven off, and disconnect the power cord, or shut off power at the fuse or circuit breaker panel.
  - Do not use the cavity for storage purposes. Do not leave paper products, cooking utensils, or food in the cavity when not in use.

**SAVE THESE INSTRUCTIONS**

## IMPORTANT SAFETY INSTRUCTIONS

- Suitable for use above both gas and electric cooking equipment.
- Intended to be used above ranges with maximum width of 36 inches.
- Clean Venting Hoods Frequently - Grease should not be allowed to accumulate on hood or filter.
- Oversized foods or oversized metal utensils should not be inserted in the microwave oven as they may create a fire or risk of electric shock.
- Do not clean with metal scouring pads. Pieces can burn off the pad and touch electrical parts involving a risk of electric shock.
- Do not use paper products when appliance is operated in the "PAN BROWN" mode.
- Do not store any materials, other than manufacturer's recommended accessories, in this oven when not in use.
- Do not store anything directly on top of the microwave oven when the microwave oven is in operation.
- When flaming foods under the hood, turn the fan on.
- Use care when cleaning the vent-hood filter. Corrosive cleaning agents, such as lye-based oven cleaners, may damage the filter.
- Do not cover or block any openings on the microwave oven.
- Do not store this microwave oven outdoors. Do not use the microwave oven near water - for example, near a kitchen sink, in a wet basement, or near a swimming pool, and the like.
- Do not immerse cord or plug in water.
- Keep cord away from heated surfaces.
- Do not let cord hang over edge of table or counter.
- Do not mount over a sink.
- Do not cover racks or any other part of the oven with metal foil. This will cause overheating of the oven.

## SAVE THESE INSTRUCTIONS

## PRECAUTIONS TO AVOID POSSIBLE EXPOSURE TO EXCESSIVE MICROWAVE ENERGY...

- (a) Do not attempt to operate this oven with the door open since open-door operation can result in harmful exposure to microwave energy. It is important not to defeat or tamper with the safety interlocks.
- (b) Do not place any object between the oven front face and the door or allow soil or cleaner residue to accumulate on sealing surfaces.
- (c) Do not operate the oven if it is damaged. It is particularly important that the oven door close properly and that there is no damage to the:
  - (1) Door (bent),
  - (2) Hinges and latches (broken or loosened),
  - (3) Door seals and sealing surfaces.
- (d) The oven should not be adjusted or repaired by anyone except properly qualified service personnel.

## Electrical Requirements

### **⚠ WARNING**



#### **Electrical Shock Hazard**

**Plug into a grounded 3 prong outlet.**

**Do not remove ground prong.**

**Do not use an adapter.**

**Do not use an extension cord.**

**Failure to follow these instructions can result in death, fire, or electrical shock.**

Observe all governing codes and ordinances. A 120 Volt, 60 Hz, AC only, 15- or 20-amp fused electrical supply is required. (A time-delay fuse or circuit breaker is recommended.) It is recommended that a separate circuit serving only this appliance be provided.

## **GROUNDING INSTRUCTIONS**

### ■ **For all cord connected appliances:**

The microwave oven must be grounded. In the event of an electrical short circuit, grounding reduces the risk of electric shock by providing an escape wire for the electric current. The microwave oven is equipped with a cord having a grounding wire with a grounding plug. The plug must be plugged into an outlet that is properly installed and grounded.

**WARNING:** Improper use of the grounding plug can result in a risk of electric shock. Consult a qualified electrician or serviceman if the grounding instructions are not completely understood, or if doubt exists as to whether the microwave oven is properly grounded.

Do not use an extension cord. If the power supply cord is too short, have a qualified electrician or serviceman install an outlet near the microwave oven.

### ■ **For a permanently connected appliance:**

This appliance must be connected to a grounded, metallic, permanent wiring system, or an equipment grounding conductor should be run with the circuit conductors and connected to the equipment grounding terminal or lead on the appliance.

**SAVE THESE INSTRUCTIONS**

# PARTS AND FEATURES

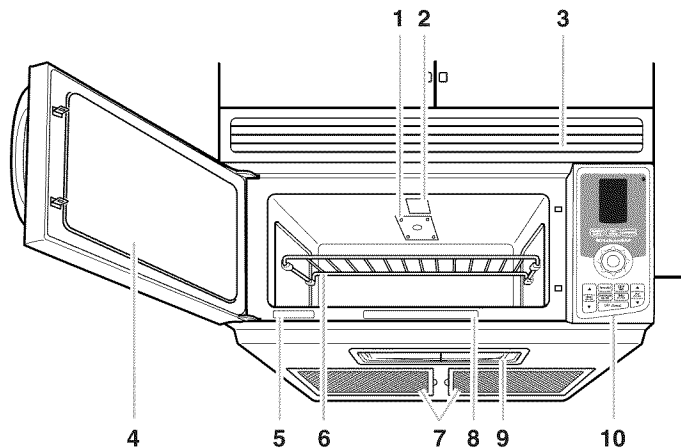

- |   |                                     |
|---|-------------------------------------|
| 1. Microwave Inlet Cover                                | 8. Cooking Guide Label              |
| 2. Microwave Light                                      | 9. Cooktop Light                    |
| 3. Vent Grille  | 10. Control Panel                   |
| 4. Metal Shielded Window                                |                                     |
| 5. Model and Serial Number Plate                        | <b>Parts and Features not shown</b> |
| 6. Cooking Rack   | Turntable                           |
| 7. Charcoal and Grease Filters (shipped in oven cavity) | Crisper Pan                         |

## Turntable

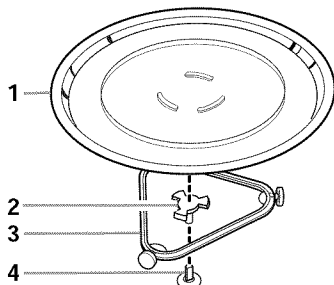

1. Turntable
2. Hub
3. Support
4. Shaft

The turntable rotates in both directions to help cook food more evenly. Do not operate the microwave oven without the turntable in place. See "Assistance or Service" to reorder any of the parts.

### To Install:

1. Remove tape from the hub.
2. Place the support on the oven cavity bottom.
3. Place the turntable on the support.

Fit the raised, curved lines in the center of the turntable bottom between the three spokes of the hub. The rollers on the support should fit inside the turntable bottom ridge.

### To Turn Off:

The turntable can be turned off (except during an auto function) by touching the TURNTABLE ON/OFF pad. ("TURNTABLE OFF" will appear in the display.) This is helpful when cooking with plates that are larger than the turntable or when cooking with two 10 in. (25 cm) plates that are side-by-side.

## Cooking Rack

The cooking rack is ideal for two-level cooking. It provides extra cavity space for cooking two or more containers at the same time. Insert the rack securely into the rack supports on the side walls of the oven. To reorder rack, see "Replacement Parts" section for part number, and the back cover of this guide for ordering instructions.

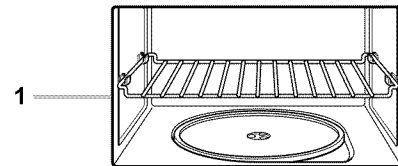

### 1. Proper Use

- Rack will become hot. Always use oven mitts or pot holders when handling.
- Do not allow the rack to touch the inside cavity walls, ceiling or floor.
- Do not use metal cookware, utensils, or a browning dish with the rack.
- Do not let food container on rack touch the top or sides of the oven.
- Do not use Crisper Pan on rack.
- Do not place popcorn bags on rack.
- The rack is designed specifically for this oven. Do not use it in any other oven.
- Do not cook food directly on the rack. Always use a microwave-safe container.
- Only use the rack when cooking on two levels. Do not store it in the oven. Damage to the oven could result if someone accidentally turns on the oven.

## Crisper Pan

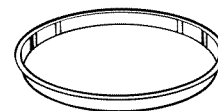

The Crisper Pan, with a detachable handle, has been specially designed for microwave use, and is ideal for pan-frying foods in the microwave oven. See "Assistance or Service" section for replacement ordering instructions.

# MICROWAVE OVEN CONTROL PANEL

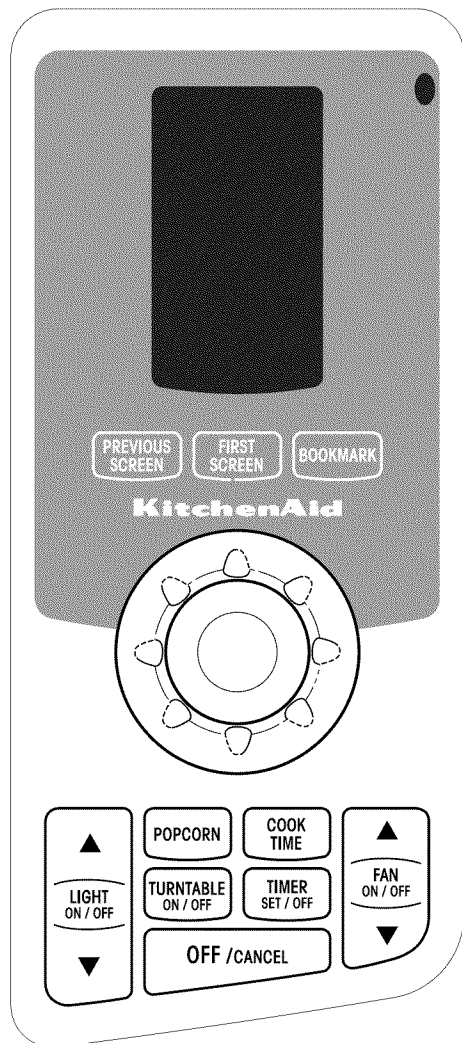

## MICRO-DIAL™ Control

The MICRO-DIAL control is used to select microwave oven functions, such as food quantities, cooking times, and cooking powers.

Turn the MICRO-DIAL control to select a function, set cook time and power, set Clock and Minute Timer, set fan speed, or set cooktop and Nite Lite.

Press the MICRO-DIAL control to enter a selection, see next page, or to start cooking.

### Function Selections

Navigate through the menus to select functions and settings.

FUNCTION	CHOICES
COOK	Cereals, Eggs, Fish, Frozen Fast Food, Grains Rice and Pasta, Meat, Poultry, Vegetable, and Manual
REHEAT	One Plate, 2-4 Plates, Beverage, Casserole, Roll, Muffin, Pizza, Sauce, Soup, and Manual
DEFROST	Meat, Poultry, Fish, Manual
PAN BROWN	Coconut, Eggs, Fried Omelet, French Toast, Ham Steak, Hamburger, Hash Brown, Meatballs, Nuts-Toasted, Pizza, Poultry-Breast, Sausage, Sesame Seeds, and Manual
EASY SIMMER	Rice, Pasta, and Boil & Simmer
2-4 PLATES	(Select REHEAT for 2, 3, or 4 plates.)
HINTS	Cleaning, Power, Food, Techniques, and Utensils (Function offers helpful advice.)
CUSTOM	Child Lock, Set Clock, Nite Lite, Signals, Demo Mode, Display Contrast, and Learning Mode

The buttons under the display screen aid in navigating through the MICRO-DIAL menus.

- PREVIOUS SCREEN pad - turns display back one page.
- FIRST SCREEN pad - resets display to first page.
- BOOKMARK pad - stores, recalls, and selects favorite programs.

## Display

The display screen shows the time of day and Home screen when the microwave oven is not in use. During programming, it displays function menus, servings and weights, preparation instructions, and cooking time/power settings. During a cooking cycle, it counts down the remaining time, and gives prompts to stir or turn food.

The following illustrates how the MICRO-DIAL™ control and display screens help the navigation through menus. This example shows the display screens and selections when cooking regular quick oatmeal.

1. Touch FIRST SCREEN pad. Press dial to select Cook.
2. Turn dial to Cereals. Press dial to select.

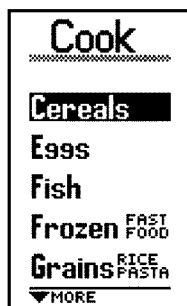
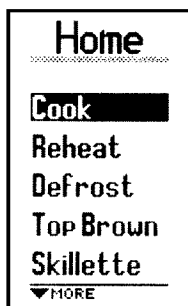

3. Turn dial to Regular Quick Oatmeal. Press dial to select.
4. Turn dial to 3 servings. Press dial to select.

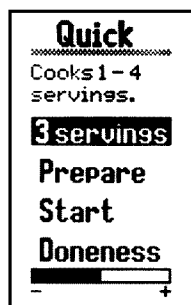
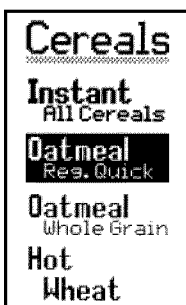

5. Turn dial to Start. Press dial to select. (For preparation instructions, select Prepare and follow the instructions.)
6. Wait for tones that signal end of cooking time.

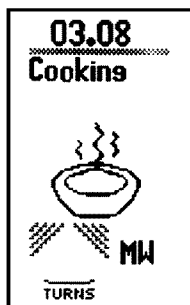
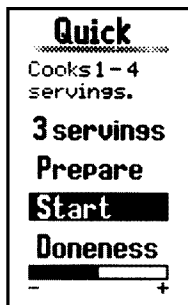

See "Learning Mode" section to see how to practice navigating through the menus without turning on the magnetron.

The display contrast may be adjusted to a desired contrast level.

**To Set Display Contrast:** Touch FIRST SCREEN pad. Turn dial to Custom. Press. Turn dial to Display Contrast. Press. Follow directions to set desired contrast.

## Clock

This is a 12 hour clock, showing a.m. and p.m. When power is first supplied to the microwave oven, or after a power failure, the "Welcome" screen will appear.

### To Set Clock:

1. Touch FIRST SCREEN pad.
2. Turn dial to Custom. Press.
3. Turn dial to Set Clock. Press.
4. Turn dial to set hours. Press.
5. Turn dial to set minutes. Press.
6. Turn dial to AM or PM. Press.
7. Press dial again to complete the Clock settings.

The Clock display may be turned off. While off, the Clock continues to keep the correct time.

**To Turn Clock On/Off:** Touch FIRST SCREEN pad. Select Custom. Select Set Clock. Touch OFF/CANCEL. To restore Clock display, touch FIRST SCREEN pad. Select Custom. Select Set Clock. Press dial.

## Tones

Tones are audible signals, indicating the following:

### One tone

- MICRO-DIAL control programming tone
- End of Timer countdown (long tone)

### Two tones

- Reminder, repeat each minute for 15 minutes after the end-of-cycle tones

### Three Tones

- Invalid entry

### Four tones

- End-of-cycle

### All Tones

All of the preceding tones, as well as end-of-stage and turn or stir tones are preset on, but can be turned off.

### To Turn Off Tones:

1. Touch FIRST SCREEN pad.
2. Turn dial to Custom. Press.
3. Turn dial to Signals. Press.
4. Turn dial to desired tone.
5. Press dial to turn off.

Repeat above steps to turn tones back on.



---

## Timer

The Timer can be set in minutes and seconds, up to 90 minutes, and counts down the set time. The Minute Timer does not start or stop the microwave oven.

When the Timer is in use, the microwave oven can still operate. To see the time countdown while the microwave oven is in use, touch TIMER SET/OFF.

**To Set:** Touch TIMER SET/OFF. Turn dial to set length of time. Press. Turn dial to Start. Press.

**To Cancel:** Touch TIMER SET/OFF.

---

## Child Lock

The Child Lock shuts down the control panel pads to prevent unintended use of the microwave oven.

When the control is locked, only the FAN ON/OFF and LIGHT ON/OFF pads will function.

The Child Lock is preset unlocked, but can be locked. Before locking, make sure the microwave oven and Timer are off.

### To Activate Child Lock:

1. Touch FIRST SCREEN pad.
2. Turn dial to Custom. Press.
3. Turn dial to Child Lock. Press.
4. Turn dial left to Closed. Press.

"Locked" will appear in the display screen if any attempt is made to start the microwave oven. As long as the Child Lock is activated, a lock icon will appear and remain in the upper, right-hand corner of the FIRST SCREEN.

### To Deactivate Child Lock:

1. Repeat steps 1-3 above.
  2. Turn dial right to Open. Press.
- 

## Exhaust Fan

The exhaust fan has a range of speeds of 0-100%.

To protect the microwave oven, if the temperature from the range or cooktop below the microwave oven gets too hot, the exhaust fan will automatically turn on at the 100% speed. It may stay on for up to one hour. When this occurs, the FAN ON/OFF pad will not function.

- Two seconds after the last time the FAN ON/OFF pad is touched, the screen returns to the previous display.
- The first time the exhaust fan is turned on after power is connected to the microwave oven, the fan will start at minimum speed. The next time the exhaust fan is turned on, it will start at the last speed used.

**To Turn Exhaust Fan On/Off:** Touch the FAN ON/OFF pad to turn fan on, then touch (▲) or (▼) arrows to increase or decrease speed. Touch the FAN ON/OFF pad to turn the fan off.

---

## Cooktop/Countertop Light

The cooktop/countertop light has brightness settings ranging from 0-100%. The light can be turned on manually, or the Nite Lite can be programmed to come on automatically, when the sensor detects low light level.

**To Manually Turn Light On/Off:** Touch LIGHT ON/OFF pad to turn light on. Touch the (▲) or (▼) arrows to set desired brightness level. Touch LIGHT ON/OFF pad to turn light off.

### To Set the Sensor for Nite Light:

1. Touch FIRST SCREEN pad.
  2. Turn dial to Custom. Press.
  3. Turn dial to Set Level. Press.
  4. Turn dial to the desired activation level, from 0-100%. Press. The display will show the current room light level as well as the activation level setting. The current room light level will fluctuate based upon current light conditions.
- 

## Learning Mode

The Learning Mode is ideal for learning how to use the microwave oven. When set, functions can be entered, with real displays and tones, without actually turning on the magnetron. While functions are operating in the Learning Mode, the microwave oven light will come on, the fan will run, and the turntable will rotate (if set ON).

Before activating, make sure the microwave oven and Minute Timer are off.

### To Activate Learning Mode:

1. Touch FIRST SCREEN pad.
2. Turn dial to Custom. Press.
3. Turn dial to Learning Mode. Press.
4. Turn dial to On. Press.
5. Turn dial to desired function. Press.

The book icon will appear at times to indicate that the oven is operating without microwave power.

### To Deactivate Learning Mode:

1. Repeat steps 1-3 above.
  2. Turn dial to Off. Press.
- 

## Demo Mode

The Demo Mode demonstrates the features and capabilities of the microwave oven, featuring the MICRO-DIAL™ System.

### To Activate Demo Mode:

1. Touch FIRST SCREEN pad.
2. Turn dial to Demo Mode. Press.
3. Press dial to activate Demo Mode. A video demonstration is played on the display screen.

---

## Bookmark

The Bookmark program allows the storage and use of up to 10 favorite functions without having to go through the normal selection process.

All functions can be placed in Bookmark except Welcome, First Screen, Bookmark, Set Clock, Popcorn, Fan, Light, Turntable, Minute Timer, Manual and preparations screens.

Bookmarks are stored and displayed in chronological order, with the last addition at the top of the list. If 10 Bookmarks are already stored, the addition of another will cause the oldest Bookmark to be deleted. If a function already stored as a Bookmark is stored again, that function will move to the top of the list. All other Bookmarks remain the same.

### To Save a Bookmark:

1. Touch FIRST SCREEN pad.
2. Turn dial to desired function. Press.
3. Turn dial to desired food. Press.
4. Touch BOOKMARK pad.
5. Press dial to add selected function to Bookmark.

### To Use a Saved Function:

1. Touch FIRST SCREEN pad.
2. Touch BOOKMARK pad.
3. Turn dial to desired Bookmark function. Press.
4. Follow instructions for selected function.

### To Delete a Stored Function:

1. Touch FIRST SCREEN pad.
2. Touch BOOKMARK pad.  
The list of Bookmarks is displayed.
3. Turn dial to function to be deleted.
4. Touch BOOKMARK button.  
Screen displays deletion confirmation.
5. Press dial to delete selected Bookmark function.

---

## BEFORE USING

A magnetron in the oven produces microwaves which reflect off the metal floor, walls and ceiling and pass through the turntable and appropriate cookware to the food. Microwaves are attracted to and absorbed by fat, sugar and water molecules in the food, causing them to move, producing friction and heat which cooks the food.

- Never lean on or allow children to swing on the oven door.
- Do not operate microwave oven when it is empty.
- Heated liquids can splash out during and after heating. Use of a wooden stir stick placed in the cup or bowl during heating may help to avoid this.
- The turntable must be in place and correct side up when oven is in use. Do not use if turntable is chipped or broken. See "Turntable" section.
- Baby bottles and baby food jars should not be heated in the oven.
- Clothes, flowers, fruit, herbs, wood, gourds, paper, including brown paper bags and newspaper should not be dried in the oven.
- Do not use the microwave oven for canning, sterilizing or deep frying. The oven cannot maintain appropriate temperatures.
- Paraffin wax will not melt in the oven because it does not absorb microwaves.
- Use oven mitts or pot holders when removing containers from oven.
- Do not overcook potatoes. At the end of the recommended cook time, potatoes should be slightly firm. Let potatoes stand for five minutes. They will finish cooking while standing.

---

## Food Characteristics

When microwave cooking, the amount, size and shape, starting temperature, composition and density of the food affect cooking results.

### Amount of Food

The more food heated at once the longer the cook time. Check for doneness and add small increments of time if necessary.

### Size and Shape

Smaller pieces of food will cook more quickly than larger pieces and uniformly shaped foods cook more evenly than irregularly shaped food.

### Starting Temperature

Room temperature foods will heat faster than refrigerated foods and refrigerated foods will heat faster than frozen foods.

### Composition and Density

Foods high in fat and sugar will reach a higher temperature and heat faster than other foods. Heavy, dense foods, such as meat and potatoes, require a longer cook time than the same size of a light, porous food, such as cake.

---

## Cooking Guidelines

### Covering

Covering food helps retain moisture, shorten cook time and reduce spattering. Use the lid supplied with cookware. If lid is not available, wax paper, paper towels or plastic wrap approved for microwaves may be used. Plastic wrap should be turned back at one corner to provide an opening to vent steam.

### Stirring and Turning

Stirring and turning redistributes heat evenly to avoid overcooking the outer edges of food. Stir from outside to center. If possible, turn food over from bottom to top.

### Arranging

If heating irregularly shaped or different sized foods, the thinner parts and smaller sizes should be arranged toward the center. If cooking several items of the same size and shape, place them in a ring pattern, leaving the center of the ring empty.

### Piercing

Before heating, use a fork or small knife to pierce or prick foods that have a skin or membrane, such as potatoes, egg yolks, chicken livers and sausage. Prick in several places to allow steam to vent.

### Shielding

Use small, flat pieces of aluminum foil to shield the thin pieces of irregularly shaped foods, bones and foods such as chicken wings, leg tips and fish tail. See "Aluminum Foil and Metal" first.

### Standing Time

Food will continue to cook by the natural conduction of heat even after the microwave cycle ends. The length of standing time depends on the volume and density of the food.

---

## Cookware and Dinnerware

Cookware and dinnerware must fit on the turntable. Always use oven mitts or pot holders when handling because any dish may become hot from heat transferred from the food. Do not use cookware and dinnerware with gold or silver trim. Use the following chart as a guide, then test before using.

MATERIAL	RECOMMENDATIONS
Aluminum Foil, Metal	See "Aluminum Foil and Metal" section.
Browning Dish	Bottom must be at least $\frac{3}{16}$ in. (5 mm) above the turntable. Follow manufacturer's recommendations.
Ceramic Glass, Glass	Acceptable for use.
China, Earthenware	Follow manufacturer's recommendations.
Melamine	Follow manufacturer's recommendations.
Paper Towels, Dinnerware, Napkins	Use non-recycled and those approved by the manufacturer for microwave oven use.
Plastic Wraps, Bags, Covers, Dinnerware, Containers	Use those approved by the manufacturer for microwave oven use.
Pottery and Clay	Follow manufacturer's recommendations.
Styrofoam	Do not use in oven.
Straw, Wicker, Wooden Containers	Do not use in oven.
Wax Paper	Acceptable for use.

### To Test Cookware or Dinnerware for Microwave Use:

1. Put cookware or dinnerware in oven with 1 cup (250 mL) of water beside it.
  2. Cook at 100% cooking power for 1 minute.
- Do not use cookware or dinnerware if it becomes hot and the water stays cool.

---

## Aluminum Foil and Metal

Always use oven mitts or pot holders when removing dishes from the microwave oven.

Aluminum foil and some metal can be used in the oven. If not used properly, arcing (a blue flash of light) can occur and cause damage to the oven.

---

### OK for Use

---

Racks and bakeware supplied with the oven, aluminum foil for shielding, and approved meat thermometers may be used with the following guidelines:

- Never allow aluminum foil or metal to touch the inside cavity walls, ceiling or floor.
- Always use the turntable.
- Never allow contact with another metal object during cooking.

---

### Do Not Use

---

Metal cookware and bakeware, gold, silver, pewter, non-approved meat thermometers, skewers, twist ties, foil liners such as sandwich wrappers, staples and objects with gold or silver trim or a metallic glaze should not be used in the oven.

---

## Cooking Power

Many recipes for microwave cooking specify which cooking power to use by percent, name or number. For example, 70%=7=Medium-High.

Use the following chart as a general guide for the suggested cooking power of specific foods.

---

PERCENT/NAME	USE
100%, High (default setting)	Quick heating convenience foods and foods with high water content, such as soups, beverages and most vegetables.
90%	Cooking small tender pieces of meat, ground meat, poultry pieces and fish fillets. Heating cream soups.
80%	Heating rice, pasta or casseroles. Cooking and heating foods that need a cook power lower than high. For example, whole fish and meat loaf.
70%, Medium-High	Reheating a single serving of food.
60%	Cooking sensitive foods such as cheese and egg dishes, pudding and custards. Cooking non-stirtable casseroles, such as lasagna.
50%, Medium	Cooking ham, whole poultry and pot roasts. Simmering stews.
40%	Melting chocolate. Heating bread, rolls and pastries.
30%, Medium-Low, Defrost	Defrosting bread, fish, meats, poultry and precooked foods.
20%	Softening butter, cheese, and ice cream.
10%, Low	Taking chill out of fruit.

---

### To Set a Cooking Power other than 100%:

1. Touch COOK TIME.
2. Turn dial to Time. Press.
3. Turn dial to desired cook time. Press.
4. Turn dial to Power. Press
5. Turn dial to desired power level. Press.

The display will count down the cook time.

When the cycle ends, the end-of-cycle tones will sound, then reminder tones will sound every minute for 15 minutes.

Touch OFF/CANCEL or open the door to stop reminder tones.

---

# MICROWAVE OVEN USE

---

## Cooking

### To Use the Auto Cooking Functions:

When using preset cooking powers and cook times for selected food types (Cereals, Eggs, Fish, Frozen Fast Food, Grains - Rice and Pasta, Meat, Poultry, and Vegetable), follow the MICRO-DIAL™ menus to select amounts and begin the auto function. See "Display" section for sample programming.

### To Cook Manually:

1. Touch COOK TIME.
2. Turn dial to Time. Press.
3. Turn dial to adjust cook time. Press.
4. Turn dial to Power. Press.
5. Turn dial to adjust cook power. Press.
6. Turn dial to Start. Press.

When the cooking cycle ends, the end-of-cycle tones will sound, then reminder tones will sound every minute for fifteen minutes.

Touch OFF/CANCEL or open the door to stop reminder tones.

---

## Popcorn

- Do not use regular paper bags or glass utensils.
- Pop only one package of popcorn at a time.
- Follow manufacturer's instructions when using a microwave popcorn popper.
- Listen for popping to slow to 1 pop every 1 or 2 seconds. Do not repop unpopped kernels.
- Use fresh bags of popcorn for optimal results.
- Cooking results may vary by brand and fat content.

Popping time has been preset based on commercially packaged microwave popcorn.

**To Use POPCORN:** Touch POPCORN. Popping starts automatically.

---

## Cooking in Stages

The microwave oven can be set to cook at different cooking powers for various lengths of time, up to four stages. Cook settings can be used in any order, except defrosting, which must be the first stage.

### To Cook in Stages:

1. Touch COOK TIME.
2. Turn dial to Time. Press.
3. Turn dial to desired length of cycle time. Press.
4. Turn dial to Power. Press.
5. Turn dial to desired power level. Press.
6. Turn dial to Add Stage. Press.  
First stage is set.
7. Repeat steps 2-6 for each additional stage.
8. Turn dial to Start. Press.  
Cooking begins.

The cook time of the cycling stage may be changed without interrupting cooking by turning the dial.

---

## Reheating

Times and cooking power have been preset for reheating 9 specific foods, plus manual. One Plate, Casserole and Pizza are refrigerated.

### To Use:

1. Touch FIRST SCREEN pad.
2. Turn dial to Reheat. Press.
3. Turn dial to desired reheat category or Manual. Press.
4. Turn dial to set or reset "doneness." Press. (Use "doneness" function to adjust cooking time, when necessary.)
5. Turn dial to Start. Press.

Reheat program is activated.

When reheat cycle is over, the end-of-cycle tones will sound, then reminder tones will sound every minute for fifteen minutes.

Touch OFF/CANCEL or open the door to stop reminder tones.

---

## 2-4 Plates

Two 10<sup>3</sup>/<sub>4</sub> inch (26 cm) refrigerated plates may be heated side-by-side or one dish larger than the turntable, plus 2 plates on the cooking rack. For best results, halfway through cooking, turn the plates (or larger dish) halfway around, and switch plates between top and bottom (if cooking more than 2 plates).

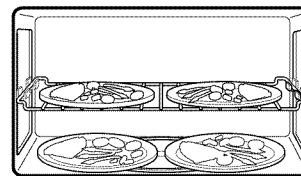

The turntable should be turned off while heating 2 bottom plates or one larger dish. See "Turntable" section.

### To Use 2-4 Plates:

1. Touch FIRST SCREEN pad.
2. Turn Dial to 2-4 Plates. Press.
3. Turn dial to correct number or plates. Press.

---

## Defrosting

Meats, poultry, or fish can be defrosted by entering its weight. If the weight is not known, the defrost setting can be determined by entering the estimated amount of food to defrost. The microwave oven can also be manually set to defrost.

The microwave oven will pause during defrosting unknown weights as a reminder to check and/or turn the food. Press dial to resume defrosting.

- Food should be 0°F (-18°C) or colder at defrosting for optimal results. How foods are stored can affect results.
- Unwrap foods and remove lids (from fruit juice) before defrosting.
- Shallow packages will defrost more quickly than deep blocks.
- Separate food pieces as soon as possible during, or at the end of the cycle for more even defrosting.
- Use small pieces of aluminum foil to shield parts of food such as chicken wings, leg tips and fish tails. See "Aluminum Foil and Metal" section first.

### To Defrost by Weight:

1. Touch FIRST SCREEN pad.
2. Turn dial to Defrost. Press.
3. Turn dial to desired food. Press.
4. Select Yes to "Do You Know the Weight." Press.
5. Turn dial to correct weight. Press.
6. Turn dial to Start. Press.

### To Defrost Unknown Weight:

1. Touch FIRST SCREEN pad.
2. Turn dial to Defrost. Press.
3. Turn dial to desired food. Press.
4. Select No to "Do You Know the Weight." Press.
5. Select type and press.
6. Turn dial to approximate amount and press.
7. Turn dial to Start. Press.

When defrost cycle is over, the end-of-cycle tones will sound, then reminder tones will sound every minute for fifteen minutes.

Touch OFF/CANCEL or open the door to stop reminder tones.

---

## Easy Simmer

Easy Simmer prepares food such as rice, pasta, soups, and vegetables by bringing the food to a boil, and then simmering it for the specified length of time.

Make sure microwave oven has been plugged in for at least 2½ minutes before using Easy Simmer, as the sensor required for the function needs 2½ minutes to warm up.

When cooking vegetables, use a minimum of ½ cup (120 mL) of water.

For best results, cover dish with its own lid, or with a dinner plate.

### To Use:

1. Touch FIRST SCREEN pad.
2. Turn dial to Easy Simmer. Press.
3. Turn dial to correct food or to Broil & Simmer. Press.
4. Follow instructions. Press dial to start.

When Easy Simmer cycle is over, the end-of-cycle tones will sound, then reminder tones will sound every minute for fifteen minutes.

Touch OFF/CANCEL or open the door to stop reminder tones.

---

## Pan Brown Feature

The Pan Brown feature uses the Crisper Pan to brown, crisp, and pan-fry foods in the microwave oven. Microwaves heat the Crisper pan through the active layer at the bottom of the pan. The active layer is designed to stop absorbing microwaves at 410°F (210°C). The Crisper Pan reaches that temperature in approximately 3 minutes. Use the pan as quickly as possible after it is heated for optimum temperature.

While microwaves heat food from above, they also heat the Crisper Pan very quickly from below to brown and crisp the food.

- Use the handle to grasp and remove the Crisper Pan from the oven.
- Do not use plastic utensils on the pan, as it becomes very hot quickly and could melt the utensils.
- Do not use metal utensils, as they can scratch the pan.
- Do not use the pan in any other microwave oven or in a thermal oven.
- Always use the turntable as a support for the pan. Do not place the pan on the cooking rack.
- For best results, coat Crisper Pan lightly with cooking oil to make removing food and cleaning easier.

### To Use:

1. Touch FIRST SCREEN pad.
2. Turn dial to Pan Brown. Press.
3. Turn dial to select category. Press.
4. Follow directions on display.

When Pan Brown cycle is over, the end-of-cycle tones will sound, then reminder tones will sound every minute for fifteen minutes.

Touch OFF/CANCEL or open the door to stop reminder tones.

---

# MICROWAVE OVEN CARE

---

## General Cleaning

**IMPORTANT:** Before cleaning, make sure all controls are off and the oven is cool. Always follow label instructions on cleaning products.

Soap, water and a soft cloth or sponge are suggested first unless otherwise noted.

---

### GREASE FILTERS

---

Do not operate the microwave oven without the grease filters in place.

Soak grease filters in hot water and mild detergent. Scrub and swish to remove embedded dirt. Rinse well and shake dry.

- Do not use ammonia or oven cleaner.
- Do not place in dishwasher.

---

### CRISPER PAN

---

Do not use abrasive cleansers or scrubbers.

- Dishwasher:  
The Skillette Pan is dishwasher safe.

---

### OVEN CAVITY

---

Do not use soap-filled scouring pads, abrasive cleaners, steel-wool pads, gritty wash cloths or some paper towels. Damage may occur.

On stainless steel models, rub in direction of grain to avoid damaging.

The area where the oven door and frame touch when closed should be kept clean.

#### Average soil

- Mild, non-abrasive soaps and detergents:  
Rinse with clean water and dry with soft, lint-free cloth.

#### Heavy soil

- Mild, non-abrasive soaps and detergents:  
Heat 1 cup (250 mL) of water for 2 to 5 minutes in oven. Steam will soften soil. Rinse with clean water and dry with soft, lint-free cloth.

#### Odors

- Lemon juice or vinegar:  
Heat 1 cup (250 mL) of water with 1 tablespoon (15 mL) of either lemon juice or vinegar for 2 to 5 minutes in oven.

---

### OVEN DOOR AND EXTERIOR

---

- Glass cleaner and paper towels or non-abrasive plastic scrubbing pad:  
Apply glass cleaner to soft cloth or sponge, not directly on surface.

---

### TURNTABLE

---

Do not operate the microwave without the turntable in place.

- Mild cleanser and scouring pad
- Dishwasher

---

## Hints

The Hints function offers helpful information and suggestions about use and care of the microwave oven. Among the selections in this menu are Cleaning, Power, Food, Techniques, and Utensils.

#### To Use:

1. Touch FIRST SCREEN pad.
2. Turn MICRO-DIAL™ control to Hints. Press.
3. Turn dial to desired setting. Press.
4. Repeat step 3 until desired instructions appear on screen.

## Replacing Filters

The grease filters should be removed and cleaned at least once a month. The charcoal filters cannot be washed and should be replaced every six to twelve months. Do not operate the microwave oven without the filters in place. See "Assistance or Service" to reorder filters. See "General Cleaning" for cleaning instructions.

### ⚠ WARNING



#### Electrical Shock Hazard

Disconnect power before removing filters.

Replace all panels before operating.

Failure to do so can result in death or electrical shock.

#### To Remove:

1. Unplug microwave oven or disconnect power.
2. Remove the grease filters by pushing up and sliding to the side. Pull tab down until the filter drops out.

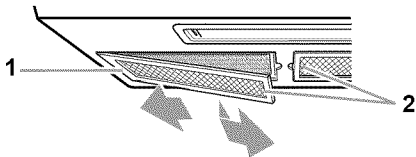

1. Push up
2. Tabs

3. Remove charcoal filters by pushing the back of each filter away from you until the front of the filter slides off the front lower lip. Swing the front of the filter down and slide out.

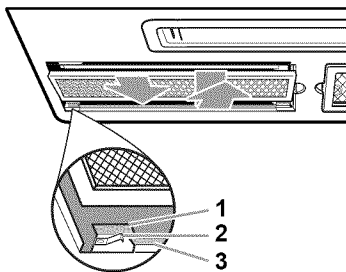

1. Upper lip
2. Spring
3. Lower lip

#### To Replace:

1. Replace charcoal filters by positioning the filter at the back of the opening and resting it on the springs. While pushing the filter into the springs, position the front of filter between the front upper and lower lips.
2. Replace grease filters by inserting one end into the frame. Swing other side up and slide into position.
3. Plug in microwave oven or reconnect power.

## Replacing Cooktop Light

The cooktop light is a 10W low-voltage halogen capsule bulb. See "Assistance or Service" for replacement ordering instructions.

#### To Replace:

1. Unplug microwave oven or disconnect power.
2. Remove the bulb cover mounting screw, and carefully remove cover.

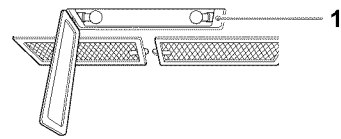

1. Mounting screw

3. Remove the old bulb.
4. Replace bulb, using a tissue to handle the bulb, or wearing cotton gloves. **Do not touch bulb with bare fingers.**
5. Replace bulb cover and mounting screw.
6. Plug in microwave oven or reconnect power.



## Replacing Microwave Oven Light

The microwave oven light is a 10W low-voltage halogen capsule bulb. It will automatically come on when the door is opened and when the microwave oven is operating. See "Assistance or Service" section for replacement ordering instructions.

### To Replace:

1. Unplug microwave or disconnect power.
2. Remove the two outer vent grille mounting screws located above the cover.

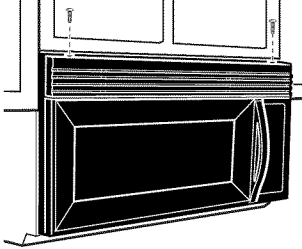

3. Tip the grille forward, then lift out to remove.

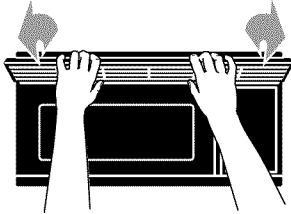

4. Lift up the bulb cover.

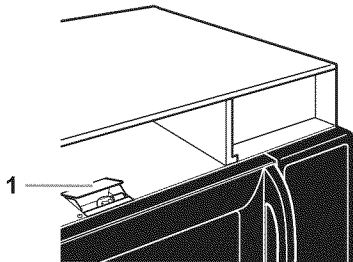

1. Bulb cover

5. Remove the old bulb by squeezing the wire clip together, pulling to the right and lifting.

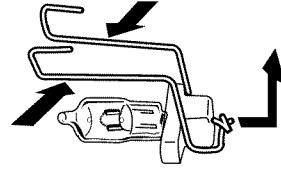

6. Replace bulb, using tissue to handle bulb, or wearing cotton gloves. **Do not touch bulb with bare fingers.**
7. Close bulb cover.
8. Slide the top of the vent grille into place. Push the bottom until it snaps into place. Replace the mounting screws.

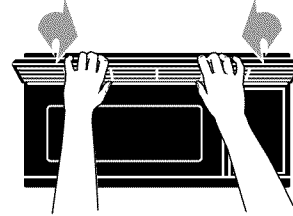

9. Plug in microwave oven or reconnect power.

---

# TROUBLESHOOTING

---

Try the solutions suggested here first in order to avoid the cost of an unnecessary service call.

---

## Nothing will operate

---

- **Has a household fuse been blown or has the circuit breaker been tripped?**  
Replace the fuse or reset the circuit.
  - **Is the appliance wired properly?**  
See Installation Instructions provided with your microwave oven.
- 

## Oven will not operate

---

- **Is the door completely closed?**  
Firmly close door.
  - **Is the electronic oven control set correctly?**  
See "Microwave Oven Control" section.
  - **Is the Child Lock set?**  
See "Child Lock" section.
  - **Is the magnetron working properly?**  
Heat 1 cup (250 mL) of cold water for 2 minutes at 100% cooking power. If water does not heat, call for service. See "Assistance or Service" section.
- 

## Oven makes humming noise

---

- This is normal and occurs when the transformer in the magnetron cycles on.
- 

## Oven door looks wavy

---

- This is normal and will not affect performance.
- 

## Turntable will not operate

---

- **Is the turntable properly in place?**  
Make sure turntable is correct-side up and is sitting securely on the turntable support.
  - **Is the turntable support operating properly?**  
Remove turntable. Remove and replace turntable support. Replace turntable. Put in 1 cup (250 mL) of water, then restart oven. If still not working, call for service. See "Assistance or Service" section. Do not operate the oven without turntable and turntable support working properly.
- 

---

## Turntable rotates both directions

---

- This is normal and depends on motor rotation at beginning of cycle.
- 

## Display shows messages

---

- **Is the display showing an "Oven Status" screen, with a letter/number code and instruction to inform KitchenAid?**  
The oven has detected an internal problem. It has run a self-checking program and displayed the error. Call for service. See "Assistance or Service" section.
- 

## Display shows time countdown, but oven is not operating

---

- **Is the Timer in use?**  
See "Timer" section.
  - **Is the Learning Mode or Demo Learning Mode in use?**  
See "Learning Mode" or "Demo Learning Mode" section.
- 

## Tones are not sounding

---

- **Are tones turned off?**  
See "Tones" section.
- 

## Steam is coming from the vent grille

---

- Some steam is normal.
- 

## Fan running slower than usual

---

- **Has the oven been stored in a cold area?**  
The fan will run slower until the oven warms up to normal room temperature.
- 

## Cooking times seem too long

---

- **Is the cooking power set properly?**  
See "Cooking Power" section.
  - **Are large amounts of food being heated?**  
Larger amounts of food need longer cooking times.
  - **Is the incoming voltage less than specified in "Microwave Oven Safety"?**  
Have a qualified electrician check the electrical system in the home.
- 

## Radio or TV Interference

---

- **Is the microwave oven plugged into the same outlet?**  
Try a different outlet.
  - **Is the radio or TV receiver near the microwave oven?**  
Move the receiver away from the microwave oven, or adjust the radio or TV antenna.
  - **Are the microwave oven door and sealing surfaces clean?**  
Make sure these areas are clean.
- 

## Display Contrast

---

- **Is the display hard to read?**  
The Display Contrast is not set correctly. See "Display" section.
-

---

# ASSISTANCE OR SERVICE

Before calling for assistance or service, please check "Troubleshooting." It may save you the cost of a service call. If you still need help, follow the instructions below.

When calling, please know the purchase date and the complete model and serial number of your appliance. This information will help us to better respond to your request.

## If you need replacement parts

If you need to order replacement parts, we recommend that you only use factory specified replacement parts. Factory specified replacement parts will fit right and work right because they are made with the same precision used to build every new KITCHENAID® appliance.

To locate factory specified replacement parts in your area, call our Customer Interaction Center telephone number or your nearest designated service center.

---

## In the U.S.A.

Call the KitchenAid Customer Interaction Center toll free: **1-800-422-1230**.

### Our consultants provide assistance with:

- Features and specifications on our full line of appliances.
- Installation information.
- Use and maintenance procedures.
- Accessory and repair parts sales.
- Specialized customer assistance (Spanish speaking, hearing impaired, limited vision, etc.).
- Referrals to local dealers, repair parts distributors, and service companies. KitchenAid designated service technicians are trained to fulfill the product warranty and provide after-warranty service, anywhere in the United States.

To locate the KitchenAid designated service company in your area, you can also look in your telephone directory Yellow Pages.

## For further assistance

If you need further assistance, you can write to KitchenAid with any questions or concerns at:

KitchenAid Brand Home Appliances  
Customer Interaction Center  
553 Benson Road  
Benton Harbor, MI 49022-2692

Please include a daytime phone number in your correspondence.

---

Replacement Part	Part No.
Glass Turntable	4393751
Turntable Support	4393752
Turntable Rollers	4393753
Turntable Hub	4393754
Crisper Pan	4393536
Grease Filters	4393691
Charcoal Filter	4393690
Cooking Rack	4393826
Cooktop and Microwave Halogen Capsule Bulb	8169418

---

---

# KITCHENAID<sup>®</sup> MICROWAVE HOOD COMBINATION WARRANTY

---

## ONE-YEAR FULL WARRANTY

For one year from the date of purchase, when this appliance is operated and maintained according to instructions attached to or furnished with the product, KitchenAid will pay for factory specified parts and repair labor costs to correct defects in materials or workmanship. Service must be provided by a KitchenAid designated service company.

---

## SECOND THROUGH FIFTH YEAR LIMITED WARRANTY

In the second through fifth years from the date of purchase, KitchenAid will pay for factory specified parts for the microwave magnetron tube, any electric oven element and the solid state touch control system to correct defects in materials or workmanship.

---

## SECOND THROUGH TENTH YEAR LIMITED WARRANTY

In the second through tenth years from date of purchase, KitchenAid will pay for factory specified parts for the stainless steel oven cavity/inner door if the part rusts through due to defects in materials or workmanship.

---

### KitchenAid will not pay for:

1. Service calls to correct the installation of your appliance, to instruct you how to use your appliance, to replace house fuses or correct house wiring, or to replace owner-accessible light bulbs.
2. Repairs when your appliance is used in other than normal, single-family household use.
3. Pickup and delivery. Your appliance is designed to be repaired in the home.
4. Damage resulting from accident, alteration, misuse, abuse, fire, flood, improper installation, acts of God or use of products not approved by KitchenAid.
5. Repairs to parts or systems resulting from unauthorized modifications made to the appliance.
6. Replacement parts or repair labor costs for units operated outside the United States.
7. Any labor costs during the limited warranty period.

---

### KITCHENAID SHALL NOT BE LIABLE FOR INCIDENTAL OR CONSEQUENTIAL DAMAGES.

Some states do not allow the exclusion or limitation of incidental or consequential damages, so this exclusion or limitation may not apply to you. This warranty gives you specific legal rights, and you may also have other rights which vary from state to state.

**Outside the 50 United States, this warranty does not apply. Contact your authorized KitchenAid dealer to determine if another warranty applies.**

If you need service, first see the "Troubleshooting" section of this book. After checking "Troubleshooting," additional help can be found by checking the "Assistance or Service" section or by calling the KitchenAid Customer Interaction Center, **1-800-422-1230** (toll-free), from anywhere in the U.S.A.

5/00

---

**Keep this book and your sales slip together for future reference. You must provide proof of purchase or installation date for in-warranty service.**

Write down the following information about your appliance to better help you obtain assistance or service if you ever need it. You will need to know your complete model number and serial number. You can find this information on the model and serial number label/plate, located on your appliance as shown in the "Parts and Features" section.

Dealer name \_\_\_\_\_

Address \_\_\_\_\_

Phone number \_\_\_\_\_

Model number \_\_\_\_\_

Serial number \_\_\_\_\_

Purchase date \_\_\_\_\_