



# Use and Care & Cooking Guide

## Spacemaker® Microwave Oven



### Safety instructions .....3-5

Precautions to Avoid Possible Exposure to Excessive Microwave Energy .....2



### Operating Instructions, Tips

Add 30 Seconds .....	13
Aluminum Foil .....	4, 21,24,26
Auto Defrost .....	20
Auto Defrost Guide .....	2 1
Automatic Fan Feature .....	5, 7
Auto Roast .....	22, 23
Auto Simmer .....	23
Auto Start/Reminder .....	13
Beeper Feature .....	13
Beverage Feature .....	16
Clock.....	8
Control Panel .....	8, 9
Cook Feature .....	17
Cooking by Temperature .....	19
Cooking by Time.....	12, 13
Cooking Complete Reminder .....	10
Cooking Guide .....	27
Defrosting by Time.....	18
Defrosting Guide .....	26
Delayed Cooking .....	11
Exhaust Fan.....	5, 9,31,32
Express Cook Feature .....	13
Features .....	10
Glossary of Microwave Terms .....	24
Heating or Reheating Guide .....	25
Hold Time .....	11
Kitchen Timer.....	11
Microwaving Tips .....	6
Minute Pad.....	8
Oven Shelf .....	4, 5, 10, 14,28,29
Popcorn.....	14
Power Levels .....	2,7,8, 11, 12,14, 17-20,22,25-27
Reheat Feature .....	16
Snacks Feature .....	14, 16
Temperature Probe .....	4,8-11, 19,22,23,29



### Problem Solver .....33

More questions ?...call  
GE Answer Center® 800.626.2000



### Care and Cleaning .....29-32

Exhaust Fan .....	31, 32
Grease Filter .....	3 1
Light Bulb Replacement .....	30
Oven Shelf .....	29
Temperature Probe .....	29



### Installation .....32

Adapter Plugs .....	32
Extension Cords .....	32
Grounding instructions .....	32



### Consumer Services .....35

Appliance Registration .....	2
Important Phone Numbers .....	35
Model and Serial Number Location .....	2
Warranty .....	Back Cover

Models: JVM24OBL  
JVM24OWL  
JVM241BL

Microwave power output  
of this oven is 850 watts.

(IEC-705 Test Procedure)



## HELP US HELP YOU...

### Before using your oven, read this book carefully.

It is intended to help you operate and maintain your new microwave oven properly.

Keep it handy for answers to your questions.

If you don't understand something or need more help, write (include your phone number):

Consumer Affairs  
GE Appliances  
Appliance Park  
Louisville, KY 40225

### Write down the model and serial numbers.

You'll find them on a label inside the oven.

These numbers are also on the Consumer Product Ownership Registration Card that came with your microwave oven. Before sending in this card, please write these numbers here:

---

Model Number

---

Serial Number

Use these numbers in any correspondence or service calls concerning your microwave oven.

### Be sure your microwave oven is registered.

It is important that we know the location of your microwave oven should a need occur for adjustments.

Your supplier is responsible for registering you as the owner.

Please check with your supplier to be sure he has done so; also send in your Consumer Product Ownership Registration Card. If you move, or if you are not the original purchaser, please write to us, stating model and serial numbers.

**This appliance must be registered. Please be certain that it is.**

Write to:

GE Appliances  
Range Product Service  
Appliance Park  
Louisville, KY 40225

### If you received a damaged oven...

Immediately contact the dealer (or builder) that sold you the oven.

### Save time and money. Before you request service...

Check the Problem Solver in the back of this book. It lists causes of minor operating problems that you can correct yourself.

### All these things are normal with your microwave oven.

- Steam or vapor escaping from around the door.
- Light reflection around door or outer case.
- Dimming oven light and change in blower sound may occur while operating at power levels other than high.
- Dull thumping sound while oven is operating.
- Some TV-Radio interference might be noticed while using your microwave oven. It's similar to the interference caused by other small appliances and does not indicate a problem with your oven.

## PRECAUTIONS TO AVOID POSSIBLE EXPOSURE TO EXCESSIVE MICROWAVE ENERGY

- (a) **Do Not Attempt** to operate **this** oven with **the** door open **since** open-door operation can result in harmful exposure to microwave energy. It is important not to defeat or tamper with the safety interlocks.
- (b) **Do Not Place any** object between the oven front face and the door or **allow soil** or cleaner residue to accumulate on sealing surfaces.
- (c) **Do Not @crate** the oven if it is damaged. It is particularly important that **the** oven door close **properly and** that **there is** no damage to the:
- (1) door (**bent**)
  - (2) hinges and latches (**broken or loosened**)
  - (3) door seals and sealing surfaces.
- (d) **The Oven Should Not be** adjusted or repaired by **anyone** except properly **qualified** service personnel.

# IMPORTANT SAFETY INSTRUCTIONS

## Read All Instructions Before Using Your Appliance.



When using electrical appliances, basic safety precautions should be followed, including the following:

**⚠ WARNING**—To reduce the risk of burns, electric shock, fire, injury to persons or exposure to excessive microwave energy:

- **Read and follow the specific “Precautions to Avoid Possible Exposure to Excessive Microwave Energy” on the previous page.**
  - **This appliance must be grounded.** Connect only to properly grounded outlet. See **Grounding Instructions** section in the back of this book.
  - **Use this appliance only for its intended use as described in this manual.** Do not use corrosive chemicals or vapors in this appliance. This microwave oven is specifically designed to heat or cook food, and is not intended for laboratory or industrial use.
  - **This over-the-range oven was designed for use over ranges no wider than 42 inches.** It may be installed over both gas and electric cooking equipment.
  - **For best operation, plug this appliance into its own electrical outlet, to prevent ticketing of fuses, blowing of fuse or tripping of circuit breaker.**
- 
- **Do not mount this appliance over a sink.** Install or locate this appliance only in accordance with the provided **Installation Instructions**.
  - **Do not cover or block any openings on the appliance.**
  - **Do not store this appliance outdoors.** Do not use this product near water—for example, in a wet basement, near a swimming pool or near a sink.
  - **This microwave oven is not approved or tested for marine use.**
  - **Do not store anything directly on top of the microwave oven-ace when the oven is in operation.**
  - \* **Do not immerse power cord or plug in water.**
  - **Keep power cord away from heated surfaces.**
- 
- **Do not let power cord hang over edge of table or counter.**
  - **Do not operate this appliance if it has a damaged power cord or plug, if it is not working properly, or if it has been damaged or dropped.**
  - **See door surface cleaning instructions in the Care and Cleaning section(s) of your book.**
  - **This appliance should be serviced only by qualified service personnel.** Contact nearest authorized service facility for examination, repair or adjustment.
  - **As with any appliance, close supervision is necessary when used by children.**
- 
- **To reduce the risk of fire in the oven cavity:**
    - **Do not overcook food.** Carefully attend appliance if paper, plastic or other combustible materials are placed inside the oven to facilitate cooking.
    - **Remove wire twist-ties and metal handles from paper or plastic containers before placing them in the oven.**
    - **Do not use your microwave oven to dry newspapers.**
    - **Do not use recycled paper products.** Recycled paper towels, napkins and waxed paper can contain metal flecks which may cause arcing or ignite. Paper products containing nylon or nylon filaments should be avoided, as they may also ignite.
    - **Do not pop popcorn in your microwave oven unless in a special microwave popcorn accessory or unless you use popcorn labeled for use in microwave ovens.**
    - **Do not overcook potatoes.** They could dehydrate and catch fire, causing damage to your oven.
    - **Do not operate the oven while empty to avoid damage to the oven and the danger of fire.** If by accident the oven should run empty a minute or 2, no harm is done. However, try to avoid operating the oven empty at all times-it saves energy and prolongs the life of the oven.

(continued next page)



## IMPORTANT SAFETY INSTRUCTIONS

(continued)

—**Do not use the oven for storage purposes.**

Do not leave paper products, cooking utensils or food in the oven when not in use.

—**If materials inside oven should ignite**, keep oven door closed, turn oven off, and disconnect power cord, or shut off power at the fuse or circuit breaker panel.

---

• **Some products** such as whole eggs and sealed containers—for example, closed jars—will explode and should not be heated in this microwave oven. Such use of the microwave oven could result in injury,

• Avoid heating baby food in glass jars, even without their lids; especially meat and egg mixtures.

• **Don't defrost frozen beverages** in narrow necked bottles (especially carbonated beverages). Even if the container is opened, pressure can build up. This can cause the container to burst, possibly resulting in injury,

• **Use foil only as directed in this book**, TV dinners may be microwaved in foil trays less than 3/4" high; remove the top foil cover and return the tray to the box. When using foil in the microwave oven, keep the foil (other than metal shelf) at least 1 inch away from the sides of the oven.



• **Cookware may become hot** because of heat transferred from the heated food. Pot holders may be needed to handle the cookware,

• Foods cooked in liquids (such as pasta) may tend to boil over more rapidly than foods containing less moisture. Should this occur, refer to the Care and Cleaning section(s) for instructions on how to clean the inside of the oven.

---

• **Thermometer-Do not** use a thermometer in food you are microwaving unless the thermometer is designed or recommended for use in the microwave oven.

• **Remove the temperature probe from the oven when not using it to cook with.** If you leave the probe inside the oven without inserting it in food or liquid, and turn on microwave energy, it can create electrical arcing in the oven and damage oven walls.

• **Plastic cookware**—Plastic cookware designed for microwave cooking is very useful, but should be used carefully. Even microwave-safe plastic may not be as tolerant of overcooking conditions as are glass or ceramic materials and may soften or char if subjected to short periods of overcooking. In longer exposures to overcooking, the food and cookware could ignite. For these reasons: 1) Use microwave-safe plastics only and use them in strict compliance with the cookware manufacturer's recommendations. 2) Do not subject empty cookware to microwaving. 3) Do not permit children to use plastic cookware without complete supervision.

---

• When cooking pork, follow the directions exactly and always cook the meat to an internal temperature of at least 170°F. This assures that, in the remote possibility that trichina maybe present in the meat, it will be killed and meat will be safe to eat.

• **Do not boil eggs in a microwave oven.** Pressure will build up inside egg yolk and will cause it to burst, possibly resulting in injury.



• **Foods with unbroken outer "skin"** such as potatoes, sausages, tomatoes, apples, chicken livers and other giblets, and egg yolks (see previous caution) should be pierced to allow steam to escape during cooking.

---

• **Not all plastic wrap is suitable for use in microwave ovens.** Check the package for proper use.

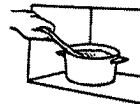

• **Spontaneous boiling**—Under certain special circumstances, liquids may start to boil during or shortly after removal from the microwave oven. To prevent burns from splashing liquid, stir the liquid briefly before removing the container from the microwave oven.



• **“Boilable” cooking pouches and tightly closed plastic bags** should be slit, pierced or vented as directed by package. If they are not, plastic could burst during or immediately after cooking, possibly resulting in injury. Also, plastic storage containers should be at least partially uncovered because they form a tight seal. **When** cooking with containers tightly covered with plastic wrap, remove covering carefully and direct steam away from hands and face.



• **Hot foods and steam can cause burns.** Be careful when opening any containers of hot food, including popcorn bags, cooking pouches and boxes. To prevent possible injury, direct steam away from hands and face.

#### • Use of the shelf accessory.

- Remove the **shelf** from oven when not in use.
- Do not store or cook with shelf on floor of oven. Product damage may result.
- Use pot holders when **handling** the shelf and cookware. They may be hot.
- Do not use microwave browning dish on shelf. The shelf could overheat.
- Use **the** shelf only when cooking on 2 levels.
- Be sure that **the** shelf is positioned properly inside the oven to prevent product damage. Do NOT use the **metal** shelf with the Popcorn program (see the Popcorn section).

#### The Exhaust Hood

• **Have it installed and properly grounded by a qualified installer. See the special installation booklet packed with the microwave oven.**

• **The exhaust fan in the oven \*operate automatically under certain conditions (see Automatic Fan Feature). While the fan is operating, caution is required to prevent the starting and spreading of accidental cooking fires while the exhaust fan is in use. For this reason:**

—**Never leave surface units unattended at high heat settings.** Boilover causes smoking and greasy spillovers that may ignite and spread if exhaust fan is operating. To minimize automatic fan operation, use adequate sized cookware and use high heat only when necessary.



—**In the event of a grease fire,** smother flaming pan on surface unit by covering pan completely with well-fitting lid, cookie sheet or flat tray.

- Clean the vent hood often.** Do not allow grease to buildup on the hood or the filter.
- Use care when cleaning the vent hood filter.** Corrosive cleaning agents, such as lye-based oven cleaners, may damage the filter.
- When flaming foods are under the hood, turn the fan off.** The fan, if operating, may spread the flame.

## SAVE THESE INSTRUCTIONS

#### Optional Accessories

Available at extra cost from your **GE** supplier.

**JX40WH Filler Panel Kit** (for model JVM240WL).

**JX41 Filler Panel Kit** (for models JVM240BL and JVM241BL).

**JX50 Glass Canopy Kit**

**JX81A Charcoal Filter Kit** for non-vented installation.

This microwave oven is **UL** listed for instigation over electric and gas ranges.



## IF YOU NEED SERVICE...

To obtain service, see the Consumer Services page in the back of this book.

We're proud of our service and want you to be pleased. If for some reason you are not happy with the service you receive, here are 3 steps to follow for further help.

FIRST, contact the people who serviced your appliance. Explain why you are not pleased. In most cases, this will solve the problem.

NEXT, if you are still not pleased, write all the details—including your phone number—to:

Manager, Consumer Relations  
GE Appliances  
Appliance Park  
Louisville, KY 40225

FINALLY, if your problem is still not resolved, write:

Major Appliance Consumer  
Action Panel  
20 North Wacker Drive  
Chicago, IL 60606



## MICROWAVING TIPS

• **Make sure all cookware used in your microwave oven is suitable for microwaving.** Most glass casseroles, cooking dishes, measuring cups, custard cups, pottery or china dinnerware which does not have metallic trim or glaze with a metallic sheen can be used. Some cookware is labeled "suitable for microwaving."

• **If you are not sure if a dish is microwave-safe, use this test:** Place in the oven both the dish you are testing and a glass measuring cup filled with 1 cup of water—set the measuring cup either in or next to the dish. Microwave 1 minute at high. If the dish heats, it should not be used for microwaving. If the dish remains cool and only the water in the cup heats, then the dish is microwave-safe.

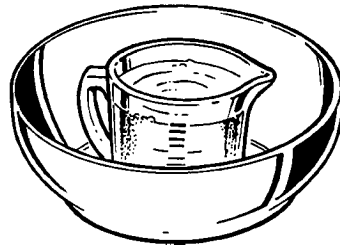

- **Paper towels, waxed paper and plastic wrap** can be used to cover dishes in order to retain moisture and prevent spattering. Be sure to vent plastic wrap so steam can escape.
- **Some microwaved foods require stirring, rotating or rearranging.** Check the Cooking Guide.
- **Steam builds up pressure in foods which are tightly covered by a skin or membrane.** Pierce potatoes, egg yolks and chicken livers to prevent bursting.

If you use a meat thermometer while cooking, make sure it is safe for use in microwave ovens.

## VARIABLE POWER LEVELS (1-10)



Variable power levels add flexibility to your microwave cooking. The power levels on your microwave oven can be compared to the surface units on a range. HIGH (Power Level 10) or full power is the fastest way to cook **and** gives you 100% power. Each power level gives you microwave energy a certain percent of the time. Power Level 7 is microwave energy 70% of the time. Power Level 3 is energy 30% of the time.

A high setting (10) will cook faster but may need additional attention such as frequent stirring, rotating or turning over. Most of your cooking will be done on HIGH (Power Level 10). A lower setting will cook more evenly and with less attention given to stirring or rotating the food. Some foods may have better flavor, texture or appearance if one of the lower settings is used. You may wish to use a lower power level when cooking foods that have a tendency to boil over, such as scalloped potatoes.

Rest periods (when the microwave energy cycles off) give time for the food to “equalize” or transfer heat to the inside of the food. An example of this is shown with Power Level 3—the defrost cycle. If microwave energy did not cycle off, the outside of the food would cook before the inside was defrosted.

Here are some examples of uses for various power levels:

POWER LEVEL	BEST USES
High 10	Fish, bacon, vegetables, boiling liquids.
Medium 7	Gentle cooking of meat and poultry; baking casseroles and reheating.
Medium 5	Slow cooking and tenderizing such as stews and less tender cuts of meat.
Low 3	Defrosting without cooking; simmering; delicate sauces.
warm 1	Keeping food warm without overcooking; softening butter,

## AUTOMATIC FAN FEATURE

This microwave oven has an automatic fan feature to protect it from too much heat rising from the cooktop or range beneath it. It automatically turns on at a low speed if it senses too much heat.

If you have turned the fan on you may find that you cannot turn it off. This is because the automatic fan has come onto protect the internal parts of the microwave.

The fan will automatically turn off when the internal parts are cool. It may stay on for 30 minutes or more after the range and microwave controls have been turned off.



## YOUR TOUCH CONTROL PANEL

The Touch Control Panel allows you to set the oven controls with the touch of a finger. It's designed to be easy to use and understand.

- 1. DISPLAY.** Displays time of day, time or temperature during cooking functions, power level being used, cooking mode and instructions.
- 2. AUTO DEFROST.** Touch this pad and food weight, then START. The oven automatically sets power levels and defrosting time.
- 3. TIME COOK I & II.** Microwave for a selected amount of time using automatic Power Level 10 (High).
- 4. TIME DEFROST.** Gentle thawing at automatic Power Level 3 (Low).
- 5. BEVERAGE.** Touch this pad to reheat a beverage. No need to touch START, the oven will start immediately.
- 6. POPCORN.** Touch this pad to cook prepackaged microwave popcorn weighing 3.0 to 3.5 ounces. No need to touch START, the oven will start immediately.
- 7. EXPRESS COOK.** Touch number pads 1 through 5 for 1 to 5 minutes of cooking. No need to touch START, the oven will start immediately.
- 8. POWER LEVEL.** Touch this pad before entering another power level number if you want to change from automatic Power Level 10 (High) for cooking or Power Level 3 (Low) for defrosting.
- 9. CLOCK.** Touch this pad to enter time of day or check time of day while microwaving. To set clock, first touch CLOCK pad and then enter time of day. For example, if time is 1:30, touch number pads 1, 3 and O and "1:30" will appear in display. Then touch START or CLOCK pad. To reset or change time, simply repeat above process.
- 10. NUMBER PADS.** Touch these pads to enter cooking time, defrosting time, time of day, temperature, power level, or food weights for Auto Defrost.
- 11. KITCHEN TIMER.** This feature uses no microwave energy. It functions as either a kitchen timer, as a holding period after defrost or as a delay timer before time or temperature cooking.
- 12. AUTO START.** Allows you to program your oven to begin cooking at a preset time of day—up to a 12-hour delay. The Reminder feature can be used like an alarm clock.
- 13. VENT FAN.** Press HI, LO or OFF for the different fan speeds.
- 14. TEMP COOK.** Use the temperature probe to cook by using a preset temperature. Once food reaches preset temperature, oven switches to HOLD setting and maintains that temperature until you touch the CLEAR/OFF pad.
- 15. AUTO ROAST.** Insert probe. Touch this pad, the desired number pad for the code, then START. The oven slow-cooks meat with the automatic preset program.
- 16. REHEAT.** Use Reheat for quick reheating of a variety of foods using different times and power levels.
- 17. COOK.** Touch this pad, a code number and weight of food for quick cooking of a variety of foods using different times and power levels.
- 18. SNACKS.** Touch this pad, a code number and weight or quantity of food to warm a variety of snack foods.
- 19. ADD 30 SEC.** Press this pad for 30 seconds of cook time, to add 30 seconds to the cook time as it's counting down or for an "instant on" for 30 seconds.
- 20. CLOCK DISPLAY ON/OFF.** Touch the O number pad to turn the clock display on or off. The Clock Display On/Off feature cannot be used while a cooking feature is in use.
- 21. MIN.** Use this with number pads to enter whole minutes. For example, for 4 minutes touch 4 and MIN.
- 22. CLEAR/OFF.** When touched, it shuts off the oven and erases all settings (except time of day).
- 23. START.** After all selections are made, touch this pad to start the oven.
- 24. SURFACE LIGHT.** Touch ON to turn on the surface light. Touch NIGHT to turn on the night light.
- 25. SOUND LEVEL.** Touch the SOUND LEVEL pad. Touch number pad O, 1, 2 or 3, then touch START pad to change the sound level of the oven beeper.



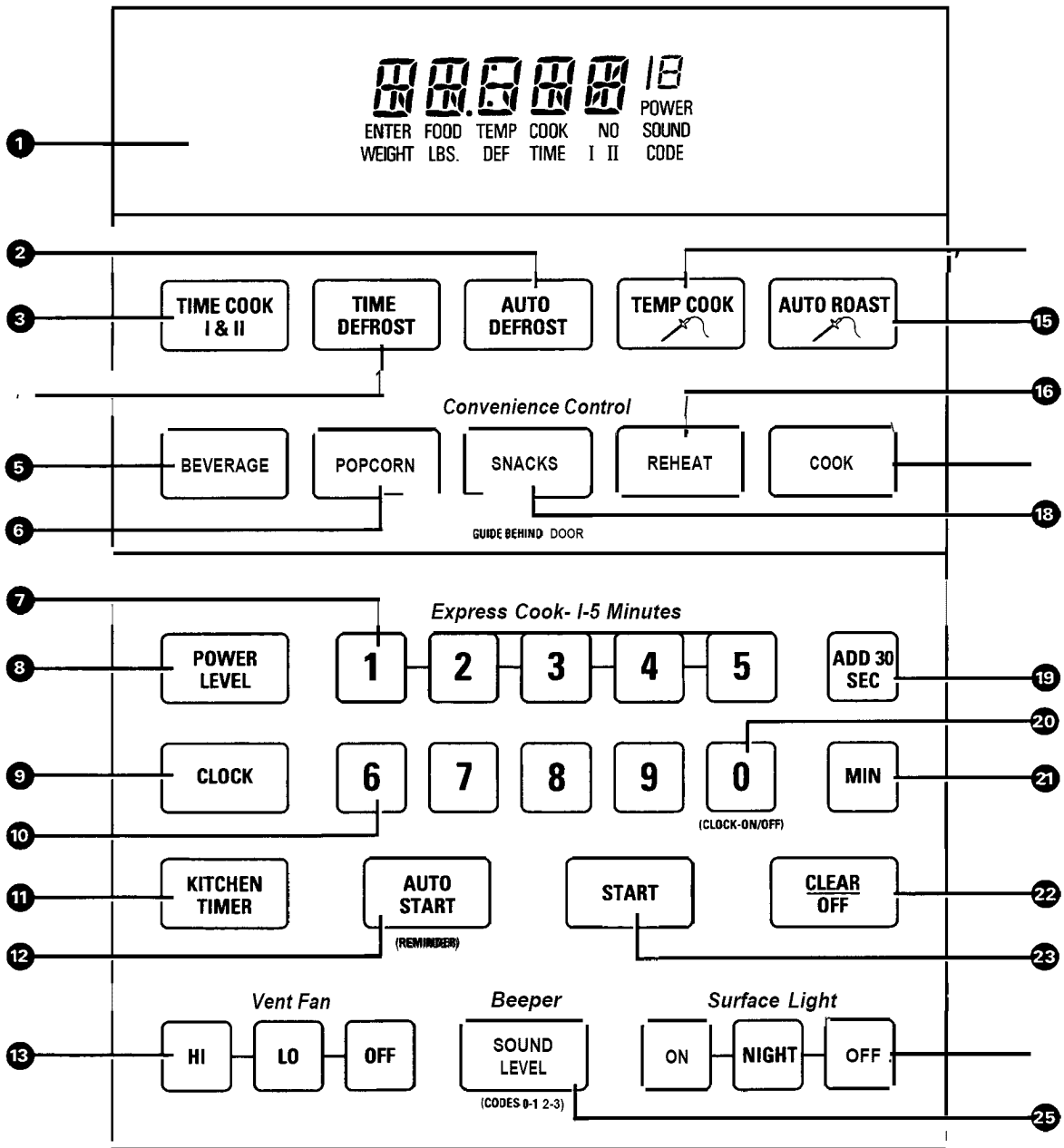

### When You Plug in the Oven

The display panel displays “88888”, “18 POWER” and all of the oven functions. After 15 seconds, all lights disappear and “RESET” appears in the upper portion. Touch the **CLEAR/OFF** pad, set the Clock and oven is ready for use.

If power is disrupted at any time, the above sequence recurs, and you must reset Clock after touching the **CLEAR/OFF** pad.

### “PROBE” Appears on the Display:

- Probe has been forgotten when Auto Roast or Temp Cook function is being used.
- Probe is not securely seated in oven wall receptacle.



# FEATURES OF YOUR OVEN

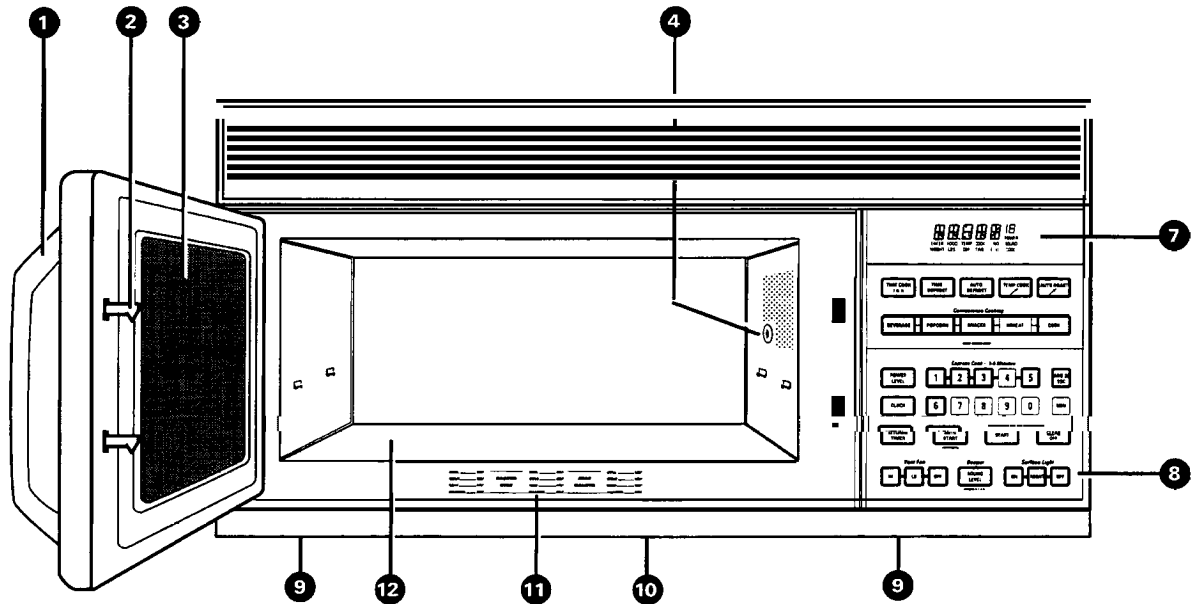
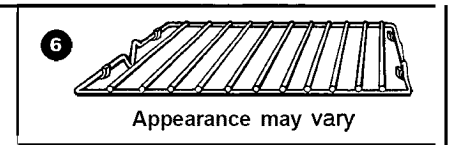
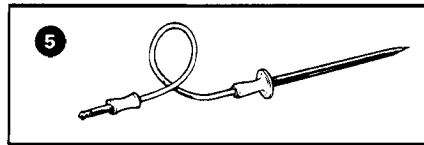

- 1. **Door Handle.** Pull to open door. Door must be securely latched for oven to operate.
- 2. **Door Latches.**
- 3. **Window with Metal Shield.** Screen allows cooking to be viewed while keeping microwaves confined in oven.
- 4. **Receptacle for Temperature Probe.** Probe must be securely inserted into receptacle before oven will start any temperature or Auto Roast cooking.
- 5. **Temperature Probe.** Use with **Temp Cook** and **Auto Roast** functions only.
- 6. **Shelf.** Lets you microwave several foods at once. Food microwaves best when placed directly on the oven floor. Use this shelf only when cooking foods on two levels. (See Safety Instructions and Oven Shelf section for special instructions.)

- 7. **Touch Control Panel and Digital Display.** For detailed information on each feature, see Your Touch Control Panel section.
- 8. **Hood Controls.**  
Vent Fan. Press HI, LO or OFF.  
Surface Light. Press ON, NIGHT or OFF.
- 9. **Grease Filters.**
- 10. **Cooktop Light.**
- 11. **Automatic Cooking Guide.**
- 12. **Oven Floor.**

**NOTE:** Rating plate, oven vent(s) and oven light are located on the inside walls of the microwave oven.

## Cooking Complete Reminder (For all cooking features except **Temp Cook** and **Auto Roast** code 4)

To remind you that you have food in the oven, the oven will display "End" and beep once a minute until you either open the oven door or touch the **CLEAR/OFF** pad.

This is to certify that this unit has been tested in conformance with **AMCA** Bulletin No. 210.

**C.F.M.**  
at 0.10 WG  
300 Vert.  
300 Her.

**SONES**  
7.2 Vert.  
6.8 Her.

# HOW TO USE THE KITCHEN TIMER



## The Kitchen Timer

The Kitchen Timer has 3 timing functions:

- It operates as a minute timer.
- It can be set to delay cooking.
- It can be used as a hold setting after defrosting.

The Kitchen Timer operates without microwave energy.

## Using a Holding Time

The Kitchen Timer can also be used to program a “holding time” between microwave cooking functions. The time can range from 1 second to 99 minutes and 99 seconds. A holding or standing time maybe found in some of your own recipes or in a cookbook.

## How to Time a 3-Minute Phone Call

**Step 1:** Touch KITCHEN TIMER pad.

**Step 2:** Touch number pad 3 and MIN pad (for 3 minutes and no seconds).

**Step 3:** Touch START. Display shows time counting down. The timer signals when time is up.

## Programming Delayed Cooking

To delay cooking up to 99 minutes and 99 seconds, touch either TIME COOK I & II, TEMP COOK or AUTO ROAST and enter cook time, temperature or code. Touch KITCHEN TIMER and enter number of minutes to delay cooking. When delaying Temp Cook or Auto Roast cooking, be sure probe is in food. Touch START. Timer will count down to zero and cooking will begin.

## How to Defrost, Hold and Time Cook

Let's say you want to defrost a frozen casserole for 15 minutes, hold for 10 minutes and then Time Cook for 25 minutes. Here's how to do it:

**Step 1:** Take casserole from freezer and place in oven.



**Step 2:** Touch TIME DEFROST pad.



**Step 3:** Touch pads 1,5 and MIN for 15 minutes defrosting time. (Defrosting is automatically set on power level 3 but can be changed by touching the POWER LEVEL pad and the desired power level.)



**Step 4:** Set standing or hold time by touching KITCHEN TIMER pad.

**Step 5:** Touch 1,0 and MIN to hold for 10 minutes.



**Step 6:** Touch TIME COOK I & II pad.

**Step 7:** Touch 2,5 and MIN for 25 minutes of cooking time.



**Step 8:** Touch START. As each function is automatically performed, oven display shows instructions entered and the function. When time is up, the oven signals and flashes “End.”



## COOKING BY TIME

### Time Cook I

**Time Cook** allows you to microwave for a preset amount of time.

Power Level 10 (High) is recommended for most cooking, but you may **change** this for more flexibility. See the Cooking Guide.

To become better acquainted with time cooking, make a cup of coffee by following the steps below.

**Step 1:** Fill a cup 2/3 full of water, add 1 teaspoon of instant coffee and stir to dissolve. Use a cup that has no metal decoration and is microwave-safe (refer to the Microwaving Tips section). Place cup in oven and close door.

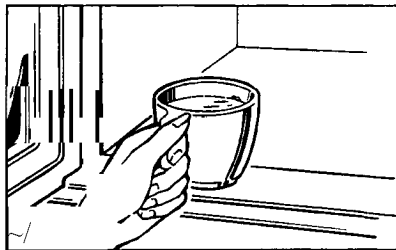

**Step 2:** Touch TIME COOK I & II pad.

**TIME COOK I & II**

**MIN**

**Step 3:** Select your time. Touch pad 1 and MIN pad for 1 minute.

Because automatic Power Level 10 is recommended for this cup of coffee, there is no need to change the power level. (If Power Level 10 is not appropriate, see "How to Change Power Level" below.)

**Step 4:** Touch the START pad.

**START**

**Step 5:** When time is up, the oven signals and flashes "End." The oven, light and fan shut off.

**Step 6:** Open the door.

If you interrupt Time Cook to check the food, simply close the door and press START to resume cooking. If there is not time remaining on the timer you must reset the timer to resume cooking.

#### How to Change Power Level

1. Press TIME COOK I & II.
2. Select cooking time.
3. Press POWER LEVEL.
4. Select power.
5. Press START.

### Using the Time Cook II Feature

The Time Cook II feature lets you set 2 time cooking functions within 1 program. This is ideal if you want to change power levels during your cooking operations. Here's how to do it.

**Step 1:** Place food in oven in microwave-safe container and close the door.

**Step 2:** Touch TIME COOK I & II.

**TIME COOK I & II**

**Step 3:** Select your first cook time. For example, touch 2, 1 and 5 for 2 minutes and 15 seconds.

**Step 4:** Touch TIME COOK I & II.

**Step 5:** Set your second cook time.

**Step 6:** Change the power level.

#### How to Change Power Level

1. Press TIME COOK I & II.
2. Select cooking time.
3. Press POWER LEVEL.
4. Select power.
5. Press START.

**Step 7:** At the end of "COOK TIME I," the second power level is displayed and "COOK TIME II" is shown counting down.

**Step 8:** When time is up, the oven signals and flashes "End." The oven, light and fan shut off.

**Step 9:** Open the door.

If you interrupt Time Cook to check the food, simply close the door and press START to resume cooking. If there is not time remaining on the timer you must reset the timer to resume cooking.



## The Express Cook Feature

The Express Cook feature is a short-cut method to set time for 1-5 minutes.

To Express Cook your food or beverage:

Express Cook - 1-5 Minutes

Touch a number pad (from 1 to 5) for 1 to 5 minutes of cooking at Power Level 10. For example, touch the 2 for 2 minutes of cooking time. No need to touch --START, the oven will start immediately.

The oven will signal and turn off automatically when finished.

## How to Use Auto Start

The Auto Start feature allows you to program your oven to begin cooking at a preset time of day—up to a 12-hour delay.



(REMINDER)

Step 1: Touch AUTO START pad.

Step 2: Enter the time you want the oven to start. (Be sure your microwave oven clock shows the correct time of day.)

Step 3: Enter your desired cooking program.

Step 4: Touch START pad. The oven will automatically start at the desired time.

## How to Use Reminder

The Reminder feature can be used like an alarm clock, without starting the oven.

Example: It is 7 a.m. and you must remember to leave for a dentist appointment at 10 a.m.



(REMINDER)

Step 1: Touch AUTO START pad.

Step 2: Enter the time you want the oven to remind you. (Be sure your microwave oven clock shows the correct time of day. The reminder time can be setup to 12 hours later).

Step 3: Touch START pad. The reminder is now set at the time you programmed, and will signal you at that time with a beeping sound until you open the door or touch the CLEAR/OFF pad. The display will show "REM" until the oven door is opened or CLEAR/OFF is touched. The REMinder time may be displayed by touching the AUTO START pad. The time-of-day may be displayed by touching the CLOCK pad.

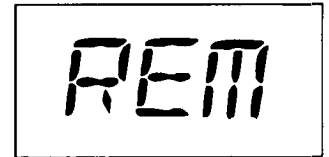

## Add 30 Seconds



The Add 30 Seconds feature provides a convenient way to extend cooking time by 30 seconds while the oven timer is counting down. It will add 30 seconds to the time shown each time the pad is touched.

This pad may also be used as an express cook for 30 seconds of cooking. No need to touch START, the oven will start immediately.

## The Beeper Feature

The Beeper Feature lets you change the sound level of the oven beeper. To set the beeper sound level:



(CODES: 0-1-2-3)

Step 1: Touch the SOUND LEVEL pad.

Step 2: Touch 0 for No Sound, 1 for Soft, 2 for Normal or 3 for Loud. When you touch each number pad the oven will beep at the volume that you have selected.

Step 3: When you have selected your desired sound level, touch the START pad.



## POPCORN

**NOTE:** Do NOT use the **metal** shelf with the Popcorn program.

The Popcorn feature is designed to be used only with prepackaged microwave popcorn weighing 3.0 to 3.5 ounces.

**Step 1:** Remove the outer wrapper from the microwave popcorn.

**Step 2:** Open oven door and place package of popcorn in the center of the oven floor as directed by the package instructions. Close oven door.



**Step 3:** Touch POPCORN pad. **No** need to touch START, the oven will start immediately.

### How to Adjust the Popcorn Program to Provide a Shorter or Longer Cook Time

If your favorite popcorn is not completely popped, there is a simple adjustment you can make.

Touch the POPCORN pad and then immediately touch number pad 9.

A plus sign will appear on the display beside the word "POP". The plus sign indicates 20 seconds more cooking time is being provided.

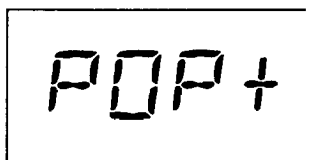

No need to touch START, the oven will start immediately. If the oven beeps before you were able to touch 9, touch the CLEAR/OFF pad and begin again.

If your favorite popcorn is overcooked, there is another adjustment you can make.

Touch the POPCORN pad and then immediately touch number pad 1.

A minus sign will appear on the display beside the word "POP". The minus sign indicates 20 seconds less cooking time is being provided.

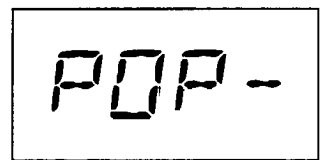

No need to touch START, the oven will start immediately. If the oven beeps before you were able to touch 1, touch the CLEAR/OFF pad and begin again.

## SNACKS

**With the Snacks feature, the oven automatically sets the microwaving times and power levels for you.**

Use the Snacks Code Guide. Touch the SNACKS pad. For codes 1 to 4 enter the quantity of food. For codes 5 and 6 enter the food weight in ounces. Then touch the START pad.

The oven calculates time and changes power levels during microwaving to give even results.

### How to Use the Snacks Feature (Snacks Codes 1 to 4)

**NOTE:** See the next page on how to use Snacks Codes 5 and 6.

**Step 1:** Remove the food from the package, place in the oven on microwave-safe dish and close door.



**Step 2:** Touch the SNACKS pad.

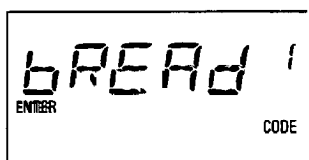

**Step 3:** Touch number pad of desired food code. For example, touch number pad 1 for bread, rolls and muffins. The code number and food type you selected will appear on the display. "ENTER" will flash.

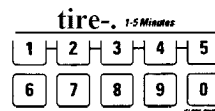

**Step 4:** Touch number pad to enter the quantity of food. For example, touch 2. After 5 seconds "START" flashes on the display.



**Step 5:** Touch the START pad. Oven will begin microwaving. Touching the SNACKS pad during microwaving will display the remaining time. When done, oven displays "End".



## How to Use the Snacks Feature (Snacks Codes 5 and 6)

**NOTE:** See the previous page on how to use Snacks Codes 1 to 4.

**Step 1:** Remove the food from the package, place in the oven on microwave-safe dish or container. Close the oven door.



Step 2: Touch the SNACKS pad.

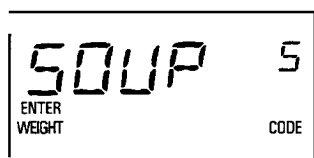

**Step 3:** Touch number pad of desired food code. For example, touch number pad 5 for soup. The code number and food type you selected will appear on the display. "ENTER WEIGHT" will flash.

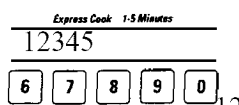

**Step 4:** Touch number pad to enter food weight. For example, touch 1 and 2 for ounces. After 5 seconds "START" flashes on the display.

**Step 5:** Touch the START pad. Oven will begin microwaving. Touching the SNACKS pad during microwaving will display the remaining time. When done, oven displays "End".

## SNACKS CODE GUIDE

### Codes 1 to 4

For warming foods with Snacks Codes 1 to 4 use the following guide:

Food	Code	Display	Quantity Limit (QTY)	Comments
<b>Bread, rolls, muffins</b>	1	BREAD	1 to 4	Use paper towel or microwave-safe plate.
Sandwiches	2	SANDw	1 to 2	Use paper towel or microwave-safe plate.
<b>Pizza</b> (leftover slices)	3	PIZ	1 to 4	Use microwave-safe plate.
Dessert Toppings	4	TOP	1 to 4	Use microwave-safe dish.

### Codes 5 and 6

For warming foods with Snacks Codes 5 and 6 use the following guide:

Food	Code	Display	Weight Limit (OZ)	Comments
soup	5	SOUP	8 to 40 oz.	Use microwave-safe dish.
<b>Cheese Dip</b>	6	CHEEZ	4 to 16 oz.	If container is microwaveable, follow instructions on container; or use microwave-safe dish.



## REHEAT

The Reheat feature is a short-term program to automatically reheat a previously cooked food. The oven turns off automatically after a preset amount of time.

Touch just 3 pads to use Reheat codes 1 to 6 to reheat many popular foods. See the Reheat Guide below.

### Reheat

The Reheat program makes it a snap to reheat many popular foods. Choose a code number from 1 to 6 (see Reheat Guide below).



**Step 1:** Touch REHEAT pad.

**Step 2:** Touch a number pad from 1 to 6 to select a food group.

**Step 3:** Touch START pad. Oven will signal and turn off automatically when finished.

### To Reheat More Than One Serving

Reheat codes 1 through 5 let you heat up to three servings. To add more than one serving, just touch number pad 2 or 3 right before touching START.

The word "SERV" and a number will be displayed to show how many servings have been selected.

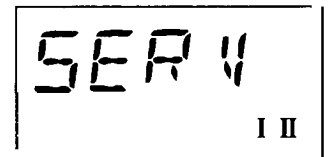

The serving size may even be changed or added after touching START. Just touch number pad 2 or 3. "SERV" and a number will be displayed briefly to show that serving size has been changed.

### Reheat Guide

Code	Display	Serving Size	Time per Serving	Foods Recommended
1	PASTA	1-3	2 min. 10 sec.	Pasta
2	MEATS	1-3	1 min. 30 sec.	Meats, casseroles, pizza
3	VEGS	1-3	1 min. 15 sec.	Fruits and vegetables
4	BEV	1-3	1 min. 30 sec.	Beverages
5	SAUCE	1-3	1 min. 15 sec.	Sauces and gravies
6	PLATE	—	3 min. 45 sec.	2 to 3 foods, 4 oz. each

## BEVERAGE

The Beverage program makes it simple to reheat a cup of hot chocolate or other beverage. Use a cup that has no metal decoration and is microwave-safe (refer to the Microwaving Tips section).



Touch BEVERAGE pad. No need to touch START, the oven will start immediately.

The serving size is automatically set at 1, but can be changed by touching number pad 2 or 3 right after touching the BEVERAGE pad. The oven will signal and turn off automatically when finished.



# COOK



**With the Cook feature, the oven automatically sets the cooking times and power levels for you.**

Use the Cook Code Guide. Touch the COOK pad. Touch a number pad from 1 to 9 to select the desired food group. Enter the food weight in ounces, then touch the START pad.

The oven calculates cooking time and changes power levels during cooking to give even cooking results.

## How to Use the Cook Feature

**Step 1:** Remove the food from the package, place in the oven on microwave-safe dish and close door.



Step 2: Touch the COOK pad.

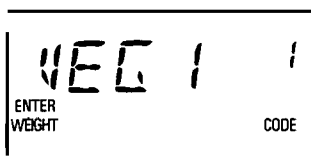

**Step 3:** Touch number pad of desired food code. For example, touch number pad 1 for canned vegetables. The code number and food type you selected will appear on the display. "ENTER WEIGHT" will flash.



**Step 4:** Enter weight. For example, touch 1 and 8 for 18 ounces. After 5 seconds "START" flashes on the display.

**Step 5:** Touch the START pad. Oven will begin cooking. Touching the COOK pad during cooking will display the remaining Cook time. Oven displays "End" when cooking is done.

## Cook Code Guide

Food	Cook Code	Weight Limit (OZ)	Comments
Canned Vegetables	1	4 to 18 OZ.	Use microwave-safe casserole or bowl. Cover with lid or plastic wrap.
Frozen Vegetables	2	4 to 16 OZ.	Use microwave-safe casserole or bowl. Follow package instructions for adding water. Cover with lid or plastic wrap.
Fresh Vegetables	3	4 to 16 OZ.	Use microwave-safe casserole or bowl. Add 2 tablespoons water for each serving. Cover with lid or plastic wrap.
Potatoes	4	8 to 40 OZ.	Pierce skin with fork. Place side by side on oven floor.
Fish	5	4 to 16 OZ.	Use oblong, square or round dish. Cover with plastic wrap.
Chicken Pieces	6	4 to 40 oz.	Use oblong, square or round dish. Cover with wax paper.
Ground Meat (Beef, Pork, Turkey)	7	8 to 48 OZ.	Use round casserole dish. Crumble meat into dish. Cover with wax paper.
Bacon	8	2 to 10 oz.	Layer strips on a plate, 4 to a layer. Cover each layer with a paper towel.
Pizza (frozen microwaveable)	9	4 to 16 OZ.	Follow package instructions to prepare pizza for microwaving.



## DEFROSTING BY TIME

**Time Defrost is designed for speedy thawing of frozen food and is one of the great advantages of a microwave oven.**

Use the Time Defrost setting to quickly thaw foods such as bread, rolls, vegetables, fruits and frozen dinners. The Auto Defrost setting is preferred for meat and poultry because the oven sets the defrosting time and power levels for you.

- Power level 3 is automatically set when you press TIME DEFROST pad, but you may change this for more flexibility.
- See the Defrosting Guide for defrosting help.

### How to Change Power Level

1. Press TIME DEFROST.
2. Select defrosting time.
3. Press POWER LEVEL.
4. Select power.
5. Press START.

To become better acquainted with the defrost function, defrost a 10 oz. package of frozen strawberries by following the steps below.

**Step 1:** Place package of frozen strawberries in the oven and close door. Be sure package contains no metal.

**Step 2:** Touch TIME DEFROST.

**TIME  
DEFROST**

**Step 3:** Select one half of the total defrosting time recommended in the Defrosting Guide. For example, touch 4 and MIN pad for 4 minutes.

**START**

**Step 4:** Touch START. When the cycle is completed, the oven signals and flashes "End," then automatically shuts off.

**Step 5:** Turn the package over, close the door and repeat Steps 2 and 3 to set remaining half of defrosting time and touch START.

**Step 6:** When the oven signals and flashes "End," open the door, remove the package and separate strawberries to finish defrosting.

## Defrosting Tips

- Foods frozen in paper or plastic can be defrosted in the package. Tightly closed packages should be slit, pierced or vented, **AFTER** food has partially defrosted, as directed by package. Plastic storage containers should be at least partially uncovered.
- Family-size, pre-packaged frozen dinners can be defrosted and microwaved. If the food is in a foil container, transfer it to a microwave-safe dish.



- For even defrosting, some foods need to be broken up or separated part of the way through the defrosting time.

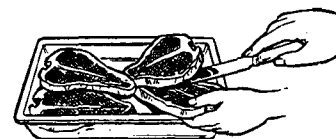

- Check the Defrosting Guide for other defrosting tips.
- Foods that spoil easily, such as milk, eggs, fish, stuffings, poultry and pork should not be allowed to sit out for more than one hour after defrosting. Room temperature promotes the growth of harmful bacteria.

## Questions and Answers

**Q. When I press START, I hear a dull, thumping noise. What is it?**

**A.** This sound is normal. It is letting you know the oven is using a power level lower than 10 (High).

**Q. Can I defrost small items in a hurry?**

**A. Yes,** but they will need more frequent attention than usual. Raise the power level after entering the time by touching the desired power level pad. Power Level 7 cuts the total defrosting time in about 1/2; Power Level 10 cuts the total defrosting time to approximately 1/3. **During** either, rotate or stir food frequently.

# COOKING BY TEMPERATURE



**Internal temperature is the best test of doneness for many foods.**

Use **Temp Cook** to cook a variety of foods to the desired finished food temperature. The Time Cook I & II setting is recommended for batters, doughs, frozen foods and foods which are difficult to cook precisely with the probe.

Temp Cook takes the guesswork out of cooking, because the oven automatically switches to “Hold” setting after reaching the preset food temperature and maintains that temperature until you touch the **CLEAR/OFF** pad.

NOTE: Oven automatically switches to “Hold” when preset food temperature is reached.

## The Temperature Probe

The temperature probe is a food thermometer that gauges the internal temperature of your food. (Its appearance may vary from picture shown.) The probe must be used when using Temp Cook or Auto Roast. To use the probe properly, follow directions in the Automatic Roasting section.

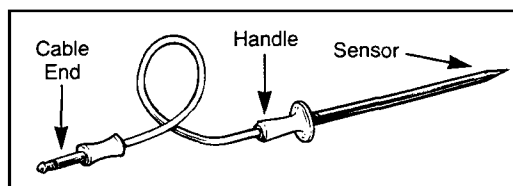

## How to Temp Cook a Rolled Beef Rib Roast to Medium

**Step 1:** Insert temperature probe and attach probe securely in oven wall. Close the door.



Step 2: Touch **TEMP COOK** pad.

**Step 3:** Touch 1,6 and 0 for 160°F.



Step 4: Touch **POWER LEVEL** pad. Touch 5 for medium power.



Step 5: Touch the **START** pad. If internal temperature of the roast is less than 90°F., display will show “COOL”; if temperature is 90°F. or above, display shows temperature counting up.

Step 6: When 160°F. is reached, the oven will sound and display “Hold.” The oven will then hold the temperature.



Step 7: Touch the **CLEAR/OFF** pad to stop the cycle.

Step 8: Remove probe and food from the oven.

## Cooking Tips

- Use a lower power level; foods will heat more evenly though requiring more time.
- Be sure frozen food has been completely defrosted before inserting probe. Probe may break off if used in frozen foods.

- Cover foods loosely for moisture control and quick, even heating.
- Insert the probe horizontally into the center meaty area not touching bone or fat. Make sure the handle does not touch the food or top or sides of the oven.

## Questions and Answers

**Q.** Why did “**PRObE**” flash on the display after I touched the **START** pad?

**A.** “**PRObE**” will flash if you don’t seat the cable end of the probe securely into the receptacle in the oven wall or if you touch the **TEMP COOK** pad and forget to use the probe.

**Q.** Can I leave my probe in the oven if it’s not inserted in food?

**A.** No, if it touches the oven wall, it may damage the oven.



# AUTO DEFROST

## Auto Defrost

With the Auto Defrost feature, the oven automatically sets the defrosting times and power levels for you.

Use the Auto Defrost Guide. Enter the food weight in pounds and tenths of a pound (see Conversion Guide). Then touch the START pad.

The oven calculates defrosting time and changes power levels during defrosting to give even defrosting results.

## How to Set Auto Defrost

Before you begin, check the guide located at front of oven when you open the door. It shows minimum and maximum food weights for a variety of foods. You will need to know your food weight before setting Auto Defrost.

**Step 1:** Remove food from package, place in oven on microwave-safe dish and close door.



Step 2: Touch the AUTO DEFROST pad.



Step 3: Enter weight. For example, touch number pads 1 and 2 for weight of .12 pounds (1 pound 3 ounces. See Conversion Guide below.)



Step 4: Touch START pad. Display shows defrost time counting down.

Twice during defrosting, the oven beeps 4 times and "TURN" flashes.

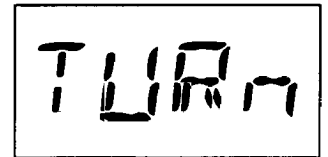

Follow the directions in the Auto Defrost Guide for what to do at the first and second signal. Then close the door and touch START. (Defrosting continues during "TURN" display.)

When defrosting time is completed, "End" flashes and oven beeps 4 times. "End" remains on display and oven beeps every minute until door is opened or CLEAR/OFF pad is touched.

## Stand Time

After Auto Defrosting, meat needs to stand in order to let the inside defrost. You may take the food out of the oven if you wish. Stand time recommendations are given in the Auto Defrost Guide.

## Conversion Guide

If the weight of food is stated in pounds and ounces, the ounces must be converted to tenths (.1) of a pound.

Ounces	Pounds
1-2	.1
3	.2
4-5	.3
6-7	.4
8	.5
9-10	.6
11	.7
12-13	.8
14-15	.9

# AUTO DEFROST GUIDE



1. Unwrap item being defrosted.
2. Place roasts and whole poultry on trivet in microwave-safe dish. Check the food for warm spots halfway through defrosting, and shield these areas with small pieces of foil.

RECOMMENDED FOODS	MIN.-MAX. WEIGHT	INSTRUCTIONS	STAND TIME
<b>Meat</b>			
Chops	0.1 - 6.0 lbs.	Separate, turn over and shield where necessary.	5 minutes
Frankfurters, Sausage	0.1 -6.0 lbs.	Separate and remove defrosted pieces.	2 minutes
Ground Meat	0.1 -6.0 lbs.	Turn over, remove defrosted areas and break apart.	5 minutes
Beef Patties	0.1 -6.0 lbs.	Turn over and separate patties. Remove defrosted pieces.	5 minutes
Roast	0.1- 6.0 lbs.	Turnover and shield.	30-90 minutes
Ribs	0.1 -6.0 lbs.	Separate, turn over and remove defrosted pieces. Shield if necessary.	5 minutes
Steak	0.1 -6.0 lbs.	Turn over and shield.	5 minutes
Stew	0.1 - 6.0 lbs.	Separate and remove defrosted pieces.	5 minutes
<b>Poultry</b>			
Whole Chicken	0.1 -6.0 lbs.	Turn over and shield.	10 minutes; run cold water in cavity.
Turkey Breast (breast side up)	0.1 -6.0 lbs.	Turn over and shield.	20 minutes in refrigerator; run cold water in cavity.
Chicken Pieces	0.1 -6.0 lbs.	Separate and remove defrosted pieces.	5 minutes
Cornish hens (whole)	0.1 -6.0 lbs.	Turn over and shield where necessary.	10 minutes; run cold water in cavity.
Cornish hens (split)	0.1 - 6.0 lbs.	Turnover and shield.	5 minutes
<b>Seafood</b>			
Fish fillets	0.1 -6.0 lbs.	Separate and remove defrosted pieces.	5 minutes
Shrimp, scallops	0.1 - 6.0 lbs.	Separate and remove defrosted pieces.	5 minutes
Whole fish	0.1 -6.0 lbs.	Turn over and shield tail and head.	5 minutes; hold under cold running water.

Edges or thin areas of meat will defrost more rapidly than other areas. After first or second signal, shield warm areas with small pieces of foil.



# AUTOMATIC ROASTING

**Auto Roast** uses the temperature probe to cook to the desired serving temperature. Unlike **Temp Cook**, which uses a single power level, **Auto Roast** uses up to 3 power settings which automatically switch during roasting, thus providing even, tender cooking **results** without overcooking.

Just as in regular roasting, only tender roasts should be roasted until specified internal temperatures are reached. Less tender roasts should be microwaved by time.

## Preparing Roasts for Auto Roasting

Place tender beef roast in cooking bag on trivet in microwave-safe dish. (Refer to package instructions for proper use of cooking bag.) Insert probe through cooking bag horizontally into the center meaty area not touching bone or fat. Make sure the handle does not touch the food or top or sides of the oven.

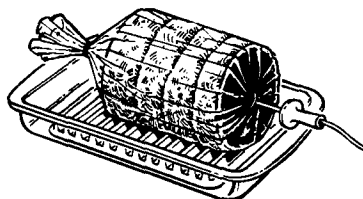

Place pork roast in cooking bag and place in microwave-safe dish.

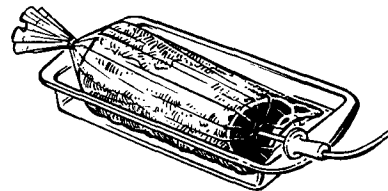

Place meat in oven with probe to the right. Insert cable end of probe firmly into receptacle on oven wall.



## How to Roast Beef to Medium

**Step 1:** Touch **AUTO ROAST** pad. Touch number pad 1. Touch **START**. (See the Auto Roast Guide for complete list of recommended codes.)



**NOTE:** By touching the **AUTO ROAST** pad during cooking, the meat's internal temperature will be displayed. ("COOL" will be displayed until meat reaches 90°F.) When pad is released, doneness code reappears on the display.

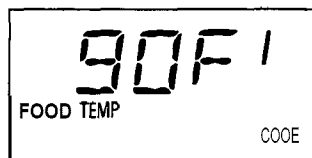

**Step 2:** When you select Auto Roast codes 1 or 2, the oven signals with 4 beeps and "TURN" flashes on the display when it's time to turn the roast over. After you turn the roast, close the door and touch **START**. (NOTE: Oven continues to cook after the signal whether or not roast is turned over.)

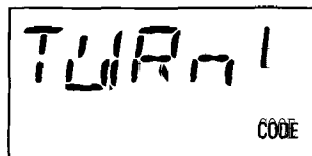

food temperature is reached, oven beeps 4 times and "HOLD" appears on the display.

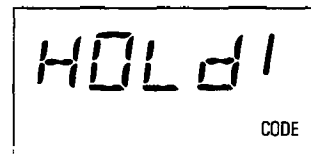

**Step 4:** Food will be held at this temperature for 60 minutes. The oven then beeps 4 times and "End" appears.

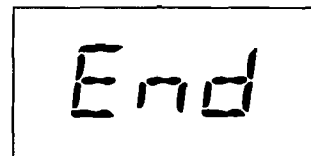



## Auto Roast Guide

• Place meats in a cooking bag in microwave-safe dish. (Refer to package instructions for proper use of cooking bag.)

• Insert probe as described in the Automatic Roasting section.

Food	Code	Minimum End Temp.	Approx. Time (minutes per pound)	Hold* Minutes	Doneness Display
Beef (5 lb. max.) Tender Roast	1	160°F.	15-23	0	MEd
	2	170°F.	23-30	5-10	WELL
Pork (5 lb. max.) Loin Roast	2	170°F.	23-30	10	WELL
<b>Poultry (6 lb. max.)</b> Turkey Breast (Insert probe horizontally into meatiest area.)	3	185°F.	16-19	10-15	WELL

\*Recommended standing time before serving.

## Automatic Simmer (Auto Roast Code 4)

Total time includes time to bring food to 180°F., and hold at that temperature until done.

Set Auto Simmer like Auto Roast as explained in the Automatic Roasting section. Display shows "SIM" and "CODE 4."

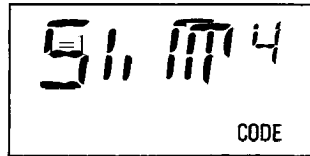

Oven switches to Hold at 180°F., and continues holding at 180°F. until you remove food and touch CLEAR/OFF pad. If stirring is recommended, you can restart oven by touching the START pad again. Touch CLEAR/OFF pad to turn oven off.

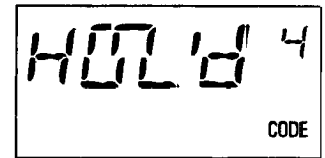

## Automatic Simmer Guide (Auto Roast Code 4)

Food	Final Temp.	Approx. Time/Hours	Doneness Display	Comments
<b>Beef</b> Pot Roast	180°F.	5-7	SIM	Add enough liquid to just cover meat. If adding vegetables, make sure they are completely covered by liquid. Precook meat. Place probe 1 inch from top surface. Stir after 3 hours, if possible.
Chili	180°F.	5-8	SIM	
Chicken Stewing	180°F.	4-6	SIM	Add 4 cups liquid. Insert probe into meatiest area of inner thigh from below end and parallel to leg. Turn over after 1/2 of time. Same procedure as above.
Broiler/Fryer	180°F.	3-4	SIM	
<b>Ham/Pork</b> Roast	180°F.	4-6	SIM	Add 4 cups liquid.
soup Stock/Vegetable	180°F.	7-10	SIM	Make sure that vegetables and meat are covered by liquid. Stir every 3 hours. Add enough liquid to cover peas at least 2 inches. Stir after 3 hours.
Split Pea	180°F.	5-7	SIM	



## GLOSSARY OF MICROWAVE TERMS

**When adapting recipes for the microwave, it is best to start with a familiar recipe. Knowing how the food should look and taste will help when adapting recipes for microwaving. Foods that require browning or crisp, dry surfaces will cook better in regular ovens.**

- Moist foods, such as vegetables, fruits, poultry and seafood, microwave well.
- Rich foods, such as bar cookies, moist cakes and candies, are suitable for microwaving because of their high fat and sugar content.
- Reduce regular oven cooking times by 1/2 to 1/3. Check food after minimum time to avoid overcooking.
- Small amounts of butter or oil can be used for flavoring, but are not needed to prevent sticking.
- Seasonings may need to be reduced. Salt meats and vegetables after cooking.

**Covering.** In both **regular baking** and microwave cooking, covers hold in moisture, allow for more even heating and reduce cooking time. In regular ovens, partial covering allows excess steam to escape. Venting plastic wrap or covering with wax paper serves the same purpose when microwaving.

**Venting.** After covering a dish with plastic wrap, you vent **the** plastic wrap by turning back 1 corner so excess steam can escape.

**Arranging Food in Oven.** When baking in regular ovens, you position foods, such as cake layers or potatoes, so hot air can flow around them. When microwaving, you arrange foods in a ring, so that all sides are exposed to microwave energy.

**Stirring.** In range-top cooking, you stir foods up from the bottom to heat them evenly. When microwaving, you stir cooked portions from the outside to the center. Foods that require constant stirring will need only occasional stirring when microwaving.

**Turning Over.** In range-top cooking, you turn over foods, such as hamburgers, so both sides can directly contact the hot pan. When microwaving, turning is often needed **during** defrosting or when cooking certain foods, such as frozen hamburgers.

**Standing Time.** When you cook with regular ovens, foods such as roasts or cakes are allowed to stand to finish cooking or to set. Standing time is especially important in microwave cooking. Note that a microwaved cake is not placed on a cooling rack.

**Shielding.** In a regular oven, you shield chicken breasts or baked foods to prevent over-browning. When microwaving, you use small strips of foil to shield thin parts, such as **the** tips of wings and legs on poultry, which would cook before larger parts.

**Arcing.** Sparks caused by too much metal in the microwave oven or metal touching the side of the oven or foil that is not molded to food.

**Prick Foods to Release Pressure.** Steam builds up pressure in foods that are tightly covered by a skin or membrane. Prick foods, such as potatoes (as you do before regular oven cooking), egg yolks and chicken livers, to prevent bursting.

**Rotating.** Occasionally, repositioning a dish in the oven helps food cook more evenly. To rotate 1/2 turn, turn **the** dish until the side that was to **the** back of the oven is to the front. To rotate 1/4 turn, turn **the** dish until the side that was to the back of the oven is to the side.

---

### Basic Microwave Guidelines

**Density of Food.** In both regular **baking** and microwave cooking, dense foods, such as potatoes, **take longer** to cook than light, porous foods, such as rolls, bread or pieces of cake.

**Round Shapes.** Since microwaves penetrate foods to about 1 inch from top, bottom **and** sides, round shapes and rings cook more evenly. Corners receive more energy and may overcook. This may **also** happen when cooking in a regular oven.

**Delicacy.** Foods with a delicate texture, such as custards, are best cooked at lower power settings to avoid toughening.

**Natural Moisture** of food affects how it cooks. Very moist foods cook evenly because microwave energy is attracted to water molecules. Food that is uneven in moisture should be covered or allowed to stand so it heats evenly.

**Piece Size.** Small pieces cook faster than **large** ones. Pieces that are similar in size and shape cook more evenly. With large pieces of food, reduce the power setting for even cooking.

**Shape of Food.** In both types of cooking, thin areas cook faster than thick areas. This can be controlled in microwaving by placing thick pieces near the outside edge **and** thin pieces in the center.

**Starting Temperature.** Foods taken from the freezer or refrigerator take longer to cook **than** foods at room temperature. Timings in our recipes are based on the temperatures at which you normally store the foods.

**Quantity of Food.** In both types of cooking, small amounts usually **take** less time than large amounts. This is most apparent in microwave cooking, where time is directly related to the number of servings.

**Shelf** (on models so equipped). Use the shelf to heat more than 1 dish at a time. Take the shelf out when you are not using it.



# HEATING OR REHEATING GUIDE

NOTE: Use Power Level High (10) unless otherwise noted.

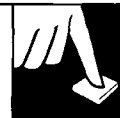

- Directions below are for heating or reheating already-cooked foods stored in refrigerator or at room temperature. Use microwave-safe cookware.
- Cover most foods for fastest heating. Exceptions are some sandwiches, griddle foods and baked items.
- Bubbling around edges of dish is **normal**, since the **center** is the last to heat. Foods heated to 160°F. to 165°F. will provide safe,

palatable results. Adjust temperatures to suit your personal taste. Let foods stand a few minutes before serving.

- Be sure foods are heated throughout before serving. Steaming or bubbling around edges of dish does not necessarily mean food is heated throughout.

If you use a meat thermometer while cooking, make sure it is safe for use in microwave ovens.

Item	Amount	Power Level	Time
<b>Bakery Foods</b>			
Cake, coffee cake, doughnuts, sweet rolls, nut or fruit bread	1 piece 9 inch cake or 12 rolls or doughnuts	Low (3) Low (3)	1/4 to 1/2 min. 2 to 4 min.
Dinner rolls, muffins	1 6 to 8	Medium (5) Medium (5)	1/4 to 1/2 min. 1 to 2 min.
Pie: fruit, nut or custard; 1 slice= 1/8 of 9 inch pie (use minimum time for custard)	1 slice 9 inch pie	Meal-High (7)	1/2 to 1 min. 3 to 5 min.
<b>Beverages</b>			
Cocoa, other milk based drinks (6 oz. per cup)	1 to 2 cups	Meal-High (7)	2 to 4 min.
Coffee, other water-based drinks (6 oz. per cup)	1 to 2 cups		2 to 3 min.
<b>Meats and Main Dishes</b>			
Chicken pieces	1 to 2 pieces		1 to 2 min.
Hamburgers or meatloaf (4 oz. per serving)	1 to 2 servings		1 to 2 min.
Hot dogs and sausages	1 to 2		1 to 1½ min.
Rice and pasta (2/3-3/4 cup per serving)	1 to 2 servings		1 to 2 min.
Saucy, main dishes: chop suey, spaghetti, creamed chicken, chili, stew, macaroni and cheese, etc. (3/4-1 cup per serving)	1 to 2 servings		2 to 4 min.
Steaks, chops, ribs, meat pieces	1 to 2 servings	Meal-High (7)	1 ½ to 2 ½ min
Thinly-sliced meat (3 to 4 oz. per serving)	1 to 2 servings	Meal-High (7)	1 to 2 min.
Topped or mixed with sauce (2/3-3/4 cup per serving)	1 to 2 servings		2 to 4 min.
<b>Tip:</b> Cover saucy main dishes with plastic wrap. Cover other main dishes and meats with wax paper. When heating or reheating 3 to 4 servings of meat slices or pieces, rotate dish 1/2 turn after half of cooking time.			
<b>Plate of Leftovers</b>			
Meat plus 2 vegetables	1 plate		3 to 4 min.
<b>Tip:</b> Cover plate of food with wax paper or plastic wrap.			
<b>Sandwiches</b>			
Meat-cheese filling: with 2 slices of bread	1 to 2 servings	Meal-High (7)	1 to 2 min.
Moist filling: Sloppy Joes, barbecue, ham salad, etc. in bun (1/3 cup per serving)	1 to 2 servings	Meal-High (7)	1 to 2 min.
<b>Tip:</b> Use paper towel or napkin to cover sandwiches.			
<b>soups</b>			
Milk-based (6 oz. per serving)	1 to 2 servings	Meal-High (7)	1 ½ to 4 min.
Water-based (6 oz. per serving)	1 to 2 servings		1 ½ to 3 min.
<b>Tip:</b> Cover soups with wax paper or plastic wrap.			
<b>Vegetables</b>			
Large pieces or whole: asparagus spears, corn on the cob, etc.	1 to 2 servings		1 to 3 min.
Mashed (1/2 cup per serving)	1 to 2 servings		2 to 4 min.
Small pieces: peas, beans, corn, etc. (1/2 cup per serving)	1 to 2 servings		1 ½ to 3 min.
<b>Tip:</b> Cover vegetables for most even heating.			



## DEFROSTING GUIDE

1. Food packaged in paper or plastic maybe defrosted without unwrapping. If food is foil wrapped, remove foil and place food in cooking dish for defrosting. Most food defrosts well using Defrost (3). For more even defrosting of **larger** foods, such as beef, lamb and veal roasts, use Warm (1).
2. After first **half** of defrosting time, unwrap package and check food. Turn food over, if **necessary**; break apart or separate food if possible. Shield any warm areas with small pieces of foil.
3. Be sure large meats are completely defrosted before cooking.
4. When defrosted, food should be **cool** but softened in all areas. If still slightly icy, return to microwave oven very briefly, or let stand a few minutes.

Food	Time	Comments
<b>Breads, Cakes</b> [Power Level: Defrost (3)]		
Bread, buns or rolls (1 piece)	1 min.	
<b>Sweet rolls</b> (approx. 12 oz.)	3 to 5 min.	Rearrange after half of time.
<b>Fish and Seafood</b> [Power Level: Defrost (3)]		
<b>Fillets</b> , frozen (1 lb.)	7 to 9 min.	
<b>Shellfish</b> , small pieces (1 lb.)	5 to 7 min.	Place <b>block</b> in casserole. Turn over and break up after <b>first</b> half of time.
<b>Fruit</b> [Power Level: Defrost (3)]		
Plastic pouch—1 to 2 (10-oz. package)	3 to 6 min.	
<b>Meat</b> [Power Level: Defrost (3)]		
<b>Bacon</b> (1 lb.)	3 to 5 min. per lb.	Place <b>unopened package</b> in oven. Let stand 5 minutes after defrosting
<b>Franks</b> (1 lb.)	3 to 5 min.	Place unopened package in oven. Microwave just <b>until</b> franks can be separated. Let stand 5 minutes, if <b>necessary</b> , to complete defrosting.
<b>Ground meat</b> (1 lb.)	5 to 7 min.	Turn meat over after first half of time.
<b>Roast</b> : beef, lamb, <b>veal</b> , pork	12 to 16 min. per lb.	Use Power Level Warm (1).
<b>Steaks</b> , chops and cutlets	6 to 8 min. per lb.	Place unwrapped meat in cooking dish. Turn over after first half of time and shield warm areas with foil. After second half of time, separate pieces with table knife. Let stand to complete defrosting.
<b>Poultry</b> [Power Level: Defrost (3)]		
<b>Chicken</b> , broiler-fryer, cut up (2½ to 3 lbs.)	16 to 20	Place wrapped chicken in dish. Unwrap and turn over after <b>first</b> half of time. After second half of time, separate pieces and place in cooking dish. Microwave 2 to 4 minutes more, if necessary. Let stand a few minutes to finish defrosting.
<b>Chicken</b> , whole (2½ to 3 lbs.)	18 to 22	Place wrapped chicken in dish. After first half of time, unwrap and turn chicken over. <b>Shield</b> warm areas with foil. To complete defrosting, run cool water in cavity until giblets can be removed.
<b>Cornish hen</b>	8 to 14 min. per lb.	Place unwrapped hen in oven breast-side-up. Turn over after first half of time. Run cool water in cavity until giblets can be removed.
<b>Turkey breast</b> (4 to 6 lbs.)	6 to 10 min. per lb.	Place unwrapped breast in microwave-safe dish breast-side-down. After first half of time, turn breast-side-up and shield warm areas with foil. Defrost for second half of time. Let stand 1 to 2 hours in refrigerator to complete defrosting.

# COOKING GUIDE

**NOTE:** Use Power Level High (10) unless otherwise noted.



## Vegetables

Vegetable	Amount	Time	Comments
<b>Asparagus</b> (frozenspears)	1 lb.	7 to 9 min., Meal-High (7)	In 1 1/2-qt. oblong glass baking dish. place 1/4 cup water. Rotate dish after half of time.
(frozenspears)	10-OZ. package	5 to 7 min.	In 1-qt. casserole.
<b>Beans</b> (fresh green)	1 lb. cut in half	10 to 12 min.	In 1 1/2-qt. casserole, place 1/2 cup water.
(frozen green)	10-OZ. package	6 to 8 min.	In 1-qt. casserole, place 2 tablespoons water.
(frozenlima)	10-oz. package	6 to 8 min.	In 1-qt. casserole, place 1/4 cup water.
<b>Beets</b> (fresh, whole)	1 bunch	18 to 22 min.	In 2-qt. casserole, place 1/2 cup water.
<b>Broccoli</b> (fresh cut)	1 bunch (1 1/4 to 1 1/2 lbs.)	8 to 10 min.	In 2-qt. casserole, place 1/2 cup water.
(freshspears)	1 bunch (1 1/4 to 1 1/2 lbs.)	10 to 13 min.	In 2-qt. oblong glass baking dish, place 1/4 cup water. Rotate dish after half of time.
(frozen, chopped)	10-OZ. package	5 to 7 min.	In 1-qt. casserole.
(frozenspears)	10-OZ. package	5 to 7 min.	In 1-qt. casserole, place 3 tablespoons water.
<b>Cabbage</b> (fresh)	1 medium head (about 2 lbs.)	9 to 11 min.	In 1X-or 2-qt. casserole, place 1/4 cup water.
(wedges)		8 to 10 min.	In 2- or 3-qt. casserole, place 1/4 cup water.
<b>Carrots</b> (fresh, sliced)	1 lb.	7 to 9 min.	In 1 1/2-qt. casserole, place 1/4 cup water.
(frozen)	10-OZ. package	5 to 7 min.	In 1-qt. casserole, place 2 tablespoons water.
<b>Cauliflower</b> (flowerets)	1 medium head	10 to 14 min.	In 2-qt. casserole, place 1/2 cup water.
(fresh, whole)	1 medium head	10 to 17 min.	In 2-qt. casserole, place 1/2 cup water.
(frozen)	10-OZ. package	5 to 7 min.	In 1-qt. casserole, place 2 tablespoons water.
<b>Corn</b> (frozen kernel)	10-OZ. package	5 to 7 min.	In 1-qt. casserole, place 2 tablespoons water.
<b>Corn on the cob</b> (fresh)	1 to 5 ears	3 to 4 min. per ear	In 2-qt. oblong glass baking dish, place corn. If com is in husk, use no water; if com has been husked, add 1/4 cup water. Rearrange after half of time.
(frozen)	1 ear	5 to 6 min.	Place in 2-qt. oblong glass baking dish.
	2 to 6 ears	3 to 4 min. per ear	Cover with vented plastic wrap. Rearrange after half of time.
<b>Mixed, vegetables</b> (frozen)	10-OZ. package	5 to 7 min.	In 1qt. casserole, place 3 tablespoons water.
<b>Peas</b> (fresh, shelled)	2 lbs. unshelled	10 to 12 min.	In 1-qt. casserole, place 1/4 cup water.
(frozen)	10-OZ. package	5 to 7 min.	In 1-qt. casserole, place 2 tablespoons water.
<b>Potatoes</b> (fresh, cubed, white)	4 potatoes (6 to 8 oz. each)	10 to 12 min.	Peel and cut into 1 inch cubes. Place in 2-qt. casserole with 1/2 cup water. Stir after half of time.
(fresh, whole, sweet or white)	1 (6 to 8 oz. each)	3 to 4 min.	Pierce with cooking fork. Place on paper towel on turntable, 1 inch apart in circular arrangement. Let stand 5 minutes.
(fresh)	10 to 16 oz.	5 to 7 min.	In 2-qt. casserole, place washed spinach.
(frozen, chopped and leaf)	10-oz. package	5 to 7 min.	In 1-qt. casserole, place 3 tablespoons water.
<b>Squash</b> (fresh, summer and yellow)	1 lb. sliced	5 to 7 min.	In 1 1/2-qt. casserole, place 1/4 cup water.
(winter, acorn or butternut)	1 to 2 squash (about 1 lb. each)	8 to 11 min.	Cut in half and remove fibrous membranes. In 2-qt. oblong glass baking dish, place squash cut-side-down. Turn cut-side-up after 4 minutes.



## GUIDE TO USE OF THE OVEN SHELF

- Use the shelf only when cooking food on 2 levels. Food microwaves best when placed directly on the oven floor.
- Do not store or cook with metal shelf on floor of oven. Product damage may result.
- Use pot holders when handling metal shelf and cookware. They may be hot.
- Do not store microwave browning dish on metal shelf.
- Do NOT use the shelf with the Popcorn program.

The wire shelf is specifically designed for added capacity heating and reheating in your microwave oven. Now more than one food may be heated or reheated and ready to serve at the same time.

Batters and dough foods and also uncooked foods which need to be prepared from scratch should be cooked without the oven shelf.

### Positioning the Shelf

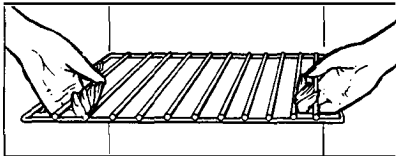

To position the shelf, tip the back slightly and fit the shelf support guides onto the support guides located at each side of the oven in the rear.

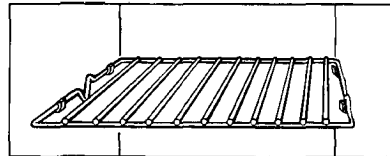

Next, lower the front until the shelf support guides fit onto the support guides located at each side of the oven in the front.

When properly positioned, the shelf should fit snugly in place, be level **and** not touch the back or side **wall** of the oven.

**If arcing occurs when using the shelf to cook more than one food at the same time, turn the oven off. Make sure the shelf is not touching oven walls. To prevent arcing, remove the shelf when you are not using it.**

### How to Reheat Several Different Types of Foods Together

When heating several different types of food together, foods which should be served hot must be placed on the oven floor, while foods which need only to be warmed should be placed on the shelf. This is because microwave **energy** enters the oven from the bottom only. Also, it is important to remember that foods absorb microwave **energy** at different rates. Rates can be affected by the size of the food, and its starting temperature.

Because of the varying rates, you may need to start reheating a **large** or dense food a few minutes ahead of time, then add other smaller or less dense foods. Alternately, if one of the foods you **are** heating seems undercooked but the others are heated satisfactorily, let the **underheated** food continue cooking.

Heat or reheat different types of food at High ( 10). To determine heating times, add times for all foods together. After half of time, stir or rearrange foods (do not reverse positions). Check foods (especially those on the oven floor) after 3/4 of total time **and** remove **any** which are done. Continue cooking others.

Place on the floor larger or more **dense** foods, which need the most heating, such as leftover fried chicken, casseroles of

canned or leftover vegetables, rice or pasta. Place on the oven shelf those foods which need only be warmed, such as bakery pies, rolls, muffins or breads.

Pop popcorn on the microwave oven floor only. Use prepackaged popcorn labeled for use in microwave ovens.

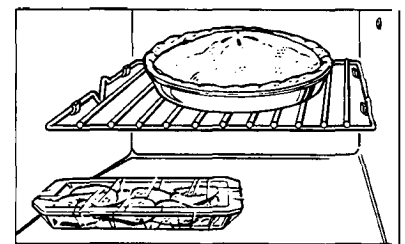

# CARE AND CLEANING



**Keep your oven clean and sweet-smelling.** Opening the oven door a few minutes after cooking helps air out the inside. An occasional thorough **wiping** with a solution of **baking soda** and water keeps the inside fresh.

**Don't use sharp-edged utensils** on your oven. The inside and outside oven walls can be scratched. The control panel can be damaged.

**BE CERTAIN POWER IS OFF BEFORE CLEANING ANY PART OF THIS OVEN.**

## How to Clean the Inside

**Walls and floor.** Some spatters can be removed with a paper towel, others may require a damp cloth. Remove greasy spatters with a sudsy cloth, then rinse with a damp cloth. Do not use abrasive cleaners on oven walls. **NEVER USE A COMMERCIAL OVEN CLEANER ON ANY PART OF YOUR MICROWAVE OVEN.**

**Door (inside).** Window: Wipe up spatters daily and wash when soiled with a damp cloth. Rinse thoroughly and dry.

Metal and plastic parts on door: Wipe frequently with a damp cloth to remove all soil. **DO NOT USE ABRASIVES, SUCH AS CLEANING POWDERS OR STEEL AND PLASTIC PADS. THEY WILL DAMAGE THE SURFACE.**

**Special note when using Brown 'N Sear Dish:** If grease is present, high heat generated on bottom of a Brown 'N Sear dish may cause the grease to burn onto the oven tray. This may be removed with a cleanser such as Bon Ami® brand cleanser.

After using Bon Ami® brand cleanser, rinse and dry **thoroughly**, following instructions on can. Do not use Bon Ami® brand cleanser on the painted surfaces such as the walls. It may scratch the paint.

**Automatic Temperature Probe.** Probe is sturdy, but care should be taken in handling. Do not twist or bend; avoid dropping temperature probe.

Clean as soon after using as possible. To clean, wipe with sudsy cloth, then rub lightly with plastic scouring ball if necessary. Rinse and dry or wash in dishwasher.

**Shelf.** Your shelf accessory is designed for use in a microwave oven only; do not use in a regular oven. Do not use a browning dish with the shelf. Arcing could occur.

Clean shelf with mild soap and water or in the dishwasher. **Do not clean in a self-cleaning oven.**

## How to Clean the Outside

**Case.** Clean the outside of your oven with soap and damp cloth, rinse with a damp cloth and then dry. Wipe the window clean with a damp cloth. Chrome trim is best wiped with a damp cloth and then with a dry towel.

**Control Panel.** Wipe with a damp cloth. Dry thoroughly. Do not use cleaning sprays, large amounts of soap and water, abrasives or sharp objects on the panel—they can damage it.

**Door Surface.** When cleaning surfaces of door and oven that come together on closing the door, use only mild, non-abrasive soaps or detergents applied with a sponge or soft cloth.

**Power Cord.** If the cord becomes soiled, unplug and wash with a damp cloth. For stubborn spots, sudsy water may be used, but be certain to rinse with a damp cloth and dry thoroughly before plugging cord into outlet.

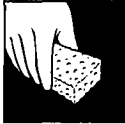

# LIGHT BULB REPLACEMENT

## Cooktop Light/Night Light

To replace combination cooktop/night light, first disconnect power at main fuse or circuit breaker panel or pull plug.

Remove screw on right side of light compartment cover and lower cover until it stops.

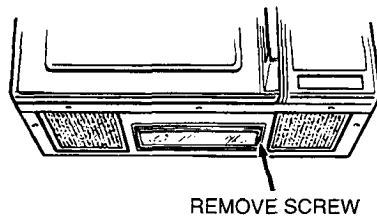

Be sure bulbs to be replaced are cool before removing. Break the adhesive seal by gently unscrewing the bulbs. Replace with 40-watt incandescent bulbs (WB02X4253) available from your GE supplier. High intensity 40-watt bulbs (40S 11 N/I), which are available in supermarkets and hardware stores, may also be used for replacements. Raise light compartment cover and replace screw. Connect electrical power to microwave oven.

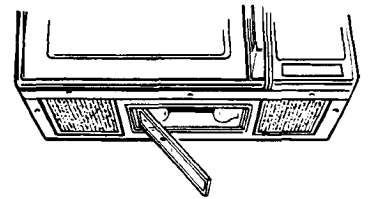

## Oven Light

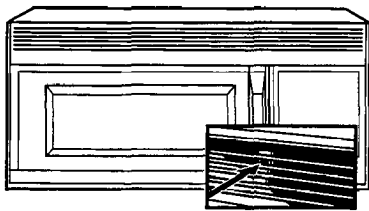

To replace your oven light, first disconnect power at main fuse or circuit breaker panel or pull plug. Remove the top grill by taking out the 2 screws that hold it in place.

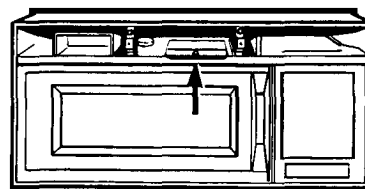

Next, remove the single screw located above door near center of oven that secures light housing. Replace burned-out bulb with a 30-watt incandescent bulb (WB02X4235), available from your GE supplier.

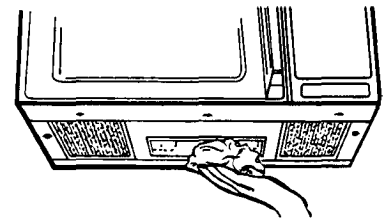

**Clean off** the grease and dust on hood surfaces often. Use a solution of warm water and detergent. About 1 tablespoon of ammonia may be added to the water. Take care not to touch the filters and enamel surfaces with this solution; ammonia will darken metal.

# THE EXHAUST FEATURE

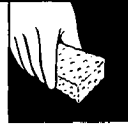

The **exhaust hood** feature on your microwave oven is equipped with 2 metal filters which collect grease. When the fan is operated, air is drawn up through the filters. Depending on your model, it is either discharged through the provided venting to the outside or drawn through a charcoal filter and recirculated.

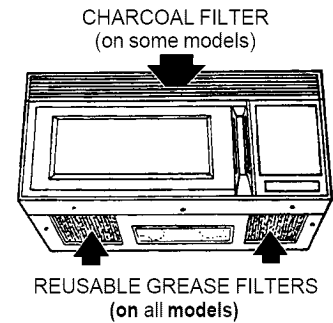

## Reusable Grease Filters (on all models)

The **grease filters should be cleaned at least once a month**. Never operate the microwave without the filters in place. In situations where flaming might occur on surfaces below hood, filters will stop the entry of flames into the unit.

### To Remove Grease Filter

To remove grease filter, grasp the "finger hold" on the filter and slide to the rear. Then pull filter downward and to the front. The filter will drop out.

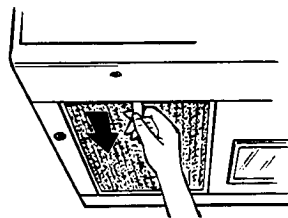

### To Clean and Replace Grease Filter

**To clean grease filter, soak it** and then agitate filter in solution of hot water and detergent. Don't use ammonia or ammonia products because they will darken the metal. Light brushing can be used to remove embedded dirt.

Rinse, shake and remove moisture before replacing.

**To replace grease filter, slide the filter in the frame slot on the back of the opening.**

Pull filter upward and to the front to lock into place.

## Charcoal Filter (on some models)

Some models are not vented to the outdoors; they recirculate the air instead. These models are equipped with a disposable charcoal filter that helps remove smoke and odors caused by cooking on your range.

**The disposable charcoal filter should be replaced when it is noticeably dirty or discolored** (usually after 6 to 12 months, depending on hood usage). Order Part No. **WB02X9883** from your GE supplier. **DO NOT CLEAN THIS FILTER. DO NOT OPERATE YOUR HOOD WITHOUT ALL 3 FILTERS IN PLACE.**

*(continued next page)*



## THE EXHAUST FEATURE

(continued)

### To Remove Charcoal Filter

To remove the charcoal filter, disconnect power at main fuse or circuit breaker panel or pull plug. Remove the top grille by

taking off 2 screws which hold it in place. Grasp filter and slide toward front of oven. It will slide right out.

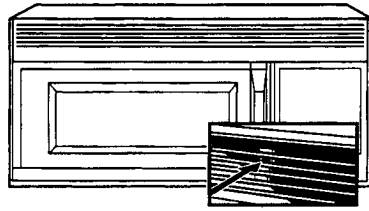

### To Install Charcoal Filter

To install a new filter, remove plastic and other outer wrapping from the new filter. Insert filter into top opening of oven as shown.

It will rest at an angle on 2 side support tabs and in front of right rear tab. Replace grill and secure with 2 screws.

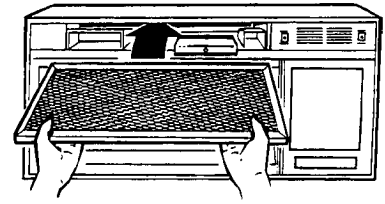

## GROUNDING INSTRUCTIONS

This appliance must be grounded. In the event of an electrical short circuit, grounding reduces the risk of electric shock by providing an escape wire for the electric current. This appliance is equipped with a power cord having a grounding wire with a grounding plug. The plug must be plugged into an outlet that is properly installed and grounded. (Fig. 1)

**WARNING**—Improper use of the grounding plug can result in a risk of electric shock.

Consult a qualified electrician or service technician if the grounding instructions are not completely understood, or

if doubt exists as to whether the appliance is properly grounded.

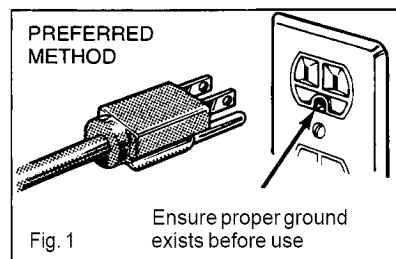

Where a standard 2-prong wall receptacle is encountered, it is your personal responsibility and obligation to have it replaced with a properly grounded 3-prong wall receptacle.

**Do not under any circumstance cut or remove the third (ground) prong from the power cord.**

**Do not use an adapter plug with this appliance.**

Do not use an extension cord with this appliance.



# QUESTIONS? USE THIS PROBLEM SOLVER

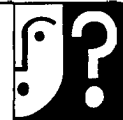

PROBLEM	POSSIBLE CAUSE
OVEN <b>WILL NOT COME ON</b>	<ul style="list-style-type: none"> <li>• A fuse in your home may be blown or the circuit breaker tripped. Replace fuse or reset circuit breaker.</li> <li>• Unplug your microwave oven, then plug it back in.</li> <li>• Make sure 3-prong plug on oven is fully inserted into <b>wall</b> receptacle.</li> </ul>
CONTROL PANEL LIGHTED, YET OVEN <b>WILL NOT START</b>	<ul style="list-style-type: none"> <li>• Door <b>not</b> securely closed.</li> <li>• START pad must be touched <b>after</b> entering cooking selection.</li> <li>• Another selection entered <b>already</b> in oven and <b>CLEAR/OFF</b> pad <b>not</b> touched to cancel it.</li> <li>• Make sure you have entered cooking time after touching TIME COOK I &amp; II pad.</li> <li>• <b>CLEAR/OFF</b> pad was touched accidentally. Reset cooking program and touch START pad.</li> <li>• Make sure you have entered a temperature after touching <b>TEMP COOK</b> pad.</li> <li>• Make sure You have entered a code number after touching <b>AUTO ROAST</b> pad.</li> </ul>
<b>“PRObE”</b> APPEARS ON DISPLAY	<ul style="list-style-type: none"> <li>• Probe has been forgotten or <b>not</b> seated properly in oven <b>wall</b> when using Temp Cook or Auto Roast function.</li> </ul>
FLOOR OF THE OVEN IS WARM, EVEN <b>WHEN THE OVEN HAS NOT BEEN USED</b>	<ul style="list-style-type: none"> <li>• The <b>cooktop</b> lamp is located <b>directly</b> below the oven floor. When the lamp is on, the heat it produces makes the oven floor get warm. This is normal.</li> </ul>

**All these things are normal with your microwave oven:**

- Steam or vapor escaping from around the door.
- Light reflection around door or outer case.
- Dimming oven light and change in blower sound may occur while operating at power levels other than high.
- Dull thumping sound while oven is operating.
- Some TV-Radio interference might be noticed while using your microwave oven. It's similar to the interference caused by other small appliances and does not indicate a problem with your oven.

---

**If you need more help...call, toll free: GE Answer Center<sup>®</sup>/ 800.626.2000/ consumer information service**

---

---

# NOTES

# We'll Be There

With the purchase of your new GE appliance, receive the assurance that if you ever need information or assistance from GE, we'll be there. All you have to do is call—toll-free!

## ***In-Home Repair Service*** **800-GE-CARES (800-432-2737)**

AGE consumer service professional will provide expert repair service, scheduled at a time that's convenient for you. Many GE Consumer Service company-operated locations offer you service today or tomorrow, or at your convenience (7:00 a.m. to 7:00 p.m. weekdays, 9:00 a.m. to 2:00 p.m. Saturdays). Our factory-trained technicians **know your** appliance inside and out—so most repairs can be handled in just one visit.

## ***GE Answer Center***<sup>®</sup> **8086262000**

Whatever your question about any GE major appliance, GE Answer Center<sup>®</sup> information service is available to help. Your call—and your question—will be answered promptly and courteously. And you can **call** any time. GE Answer Center<sup>®</sup> service is open 24 hours a day, 7 days a week.

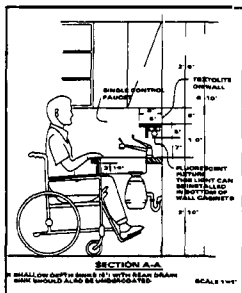

## ***For Customers With Special Needs...*** **800.626.2000**

Upon request, GE will provide Braille controls for a variety of GE appliances, and a brochure to assist in planning a barrier-free kitchen for persons with limited mobility. To obtain these items, free of charge, call 800.626.2000.

Consumers with impaired hearing or speech who have access to a TDD or a conventional teletypewriter may call 800-TDD-GEAC (800-8334322) to request information or service.

## ***Service Contracts*** **800-626-2224**

You can have the secure feeling that GE Consumer Service will still be there after your warranty expires. Purchase a GE contract while your warranty is still in effect and you'll receive a substantial discount. With a multiple-year contract, you're assured of future service at today's prices.

## ***Parts and Accessories*** **800-626-2002**

**Individuals qualified** to service their own appliances can have needed parts or accessories sent directly to their home. The GE parts system provides access to over 47,000 parts... and all GE Genuine Renewal Parts are fully warranted. VISA, MasterCard and Discover cards are accepted.

User maintenance instructions contained in this booklet cover procedures intended to be performed by any user. **Other servicing generally should be referred to qualified service personnel.** Caution must be exercised, since **improper servicing may cause unsafe operation.**

# YOUR GE MICROWAVE OVEN WARRANTY

**Staple sales slip or cancelled check here. Proof of original purchase date is needed to obtain service under warranty.**

## WHAT IS COVERED

### FULL ONE-YEAR WARRANTY

For one year from date of original purchase, we will provide, free of charge, **parts** and service labor in your home to repair or replace **any part of the microwave oven** that fails because of a manufacturing defect.

### LIMITED ADDITIONAL NINE-YEAR WARRANTY

For the second through tenth year from date of original purchase, we will provide, free of charge, a replacement **magnetron tube** if the magnetron tube fails because of a manufacturing defect. You pay for the **service trip** to your home and service labor charges.

This warranty is extended to the original purchaser and any succeeding owner for products purchased for ordinary home use in the 48 mainland states, Hawaii and Washington, D.C. In Alaska the warranty is the same except that it is LIMITED because you must pay to ship the product to the service shop or for the service technician's travel costs to your home.

All warranty service will be provided by our Factory Service Centers or by our authorized Customer Care<sup>®</sup> servicers during normal working hours.

Should your appliance need service, during warranty period or beyond, call 800-GE-CARES (800-432-2737).

## WHAT IS NOT COVERED

- Service trips to your home to teach you how to use the product.

### Read your Use and Care material.

If you then have any questions about operating the product, please contact your dealer or our Consumer Affairs office at the address below, or call, toll free:

GE Answer Center<sup>®</sup>  
800.626.2000  
consumer information service

- Improper installation.

If you have an installation problem, contact your dealer or installer. You are responsible for providing adequate electrical, gas, exhausting and other connecting facilities.

- Replacement of house fuses or resetting of circuit breakers.
- Failure of the product if it is used for other than its intended purpose or used commercially.
- Damage to product caused by accident, fire, floods or acts of God.

**WARRANTOR IS NOT RESPONSIBLE FOR CONSEQUENTIAL DAMAGES.**

Some states do not allow the exclusion or limitation of incidental or consequential damages, so the above limitation or exclusion may not apply to you. This warranty gives you specific legal rights, and you may also have other rights which vary from state to state. To know what your legal rights are in your state, consult your local or state consumer affairs office or your state's Attorney General.

**Warrantor: General Electric Company**

**If further help is needed concerning this warranty, write:  
Manager—Consumer Affairs, GE Appliances, Louisville, KY 40225**

Part No. 164 D2588P191

Pub. No. 49-8391