

PROSCAN®



# LCD TV



## *USER'S MANUAL*

Model: 19LB30Q  
UM No.: RN03185H0900

---

	<b>CAUTION</b> RISK OF ELECTRIC SHOCK DO NOT OPEN	
<b>CAUTION:</b> To reduce the risk of electric shock, do not remove cover or back. No user- serviceable parts inside. Refer Servicing to qualified service personnel.		

  
The lightning flash with arrowhead symbol, within an equilateral triangle is intended to alert the user to the presence of uninsulated dangerous voltage within the product enclosure that may be of sufficient magnitude to constitute a risk of electric shock.

**CAUTION:** Changes or modifications not expressly approved by the party responsible for compliance with the FCC Rules could avoid the users' authority to operate this equipment.

  
The exclamation point within an equilateral triangle is intended to alert the user to the presence of important operating and maintenance (servicing) instructions in the literature accompanying the TV.

**CAUTION:** The TV shall not be exposed to dripping or splashing. No objects filled with liquids, such as vases, shall be placed on the TV.

  
**WARNING: TO PREVENT FIRE OR SHOCK HAZARD, DO NOT EXPOSE THIS APPLIANCE TO RAIN OR MOISTURE.**

**CAUTION:** Do Not Place This TV on an unstable cart, stand, or table. The TV may fall, causing serious injury to a child or adult, and serious damage to the TV. Use only with a cart or stand recommended by the manufacturer, or sold with the TV.

**CAUTION:** Installation on concrete wall has passed UL safety test.

---

**WARNING: TO REDUCE THE RISK OF FIRE OR ELECTRIC SHOCK, DO NOT EXPOSE THIS APPLIANCE TO RAIN OR MOISTURE. DANGEROUS HIGH VOLTAGES ARE PRESENT INSIDE THE ENCLOSURE. DO NOT OPEN THE CABINET. REFER SERVICING TO QUALIFIED PERSONNEL ONLY.**

**WARNING: THE APPARATUS SHALL NOT BE EXPOSED TO DRIPPING OR SPLASHING AND THAT NO OBJECTS FILLED WITH LIQUIDS, SUCH AS VASES SHALL BE PLACED ON THE APPARATUS.**

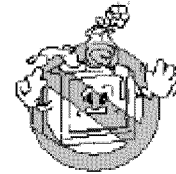

**CAUTION: TO PREVENT ELECTRIC SHOCK, MATCH WIDE BLADE OF PLUG TO WIDE SLOT.**

**CAUTION: THESE SERVICING INSTRUCTIONS ARE FOR USE BY QUALIFIED SERVICE PERSONNEL ONLY.**

**TO REDUCE THE RISK OF ELECTRIC SHOCK, DO NOT PERFORM ANY SERVICING ACTIVITIES, BUT CALL QUALIFIED ELECTRICIAN PERSONNEL.**

**CAUTION: DANGER OF EXPLOSION IF BATTERY IS INCORRECTLY REPLACED, REPLACE ONLY WITH THE SAME OF EQUIVALENT TYPE.**

# IMPORTANT SAFETY INSTRUCTIONS

1. **READ THESE INSTRUCTIONS.**

2. **KEEP THESE INSTRUCTIONS.**

3. **HEED ALL WARNINGS.**

4. **FOLLOW ALL INSTRUCTIONS.**

5. **DO NOT USE THIS APPARATUS NEAR WATER.**

Do not use this TV near water. For example, do not use near a bathtub, washbowl, kitchen sink or laundry tub, in a wet basement, or near a swimming pool, and the like. The TV set shall not be exposed to dripping or splashing. No objects filled with liquids, such as vases, shall be placed on the TV set.

6. **CLEAN ONLY WITH DRY CLOTH.**

Unplug the TV from the wall outlet before cleaning. Do not use liquid cleaners or aerosol cleaners. Use a damp cloth for cleaning.

7. **DO NOT BLOCK ANY VENTILATION OPENINGS.**

**INSTALL IN ACCORDANCE WITH THE MANUFACTURER'S INSTRUCTIONS.**

Slots and openings in the cabinet back or bottom are provided for ventilation, to ensure reliable operation of the TV and to protect it from overheating. These openings must not be blocked or covered. The openings should never be blocked by placing the TV on a bed, sofa, rug, or other similar surface. This TV should never be placed near or over a radiator or heat resource. This TV should not be placed in a built-in installation such as a bookcase or rack unless proper ventilation is provided or the manufacturer's instructions have been adhered to.

8. **DO NOT INSTALL NEAR ANY HEAT SOURCES SUCH AS RADIATORS, HEAT REGISTERS, STOVES, OR OTHER APPARATUS (INCLUDE AMPLIFIERS) THAT PRODUCE HEAT.**

9. **DO NOT DEFEAT THE PURPOSE OF THE POLARIZED OR GROUNDING-TYPE PLUG. A POLARIZED PLUG HAS TWO BLADES WITH ONE WIDER THAN THE OTHER. A GROUNDING TYPE PLUG HAS TWO BLADES AND A THIRD GROUNDING PRONG. THE WIDE BLADE OR THE THIRD PRONG IS PROVIDED FOR YOUR SAFETY. IF THE PROVIDED PLUG DOES NOT FIT INTO YOUR OUTLET, CONSULT AN ELECTRICIAN FOR**

**REPLACEMENT OF THE OBSOLETE OUTLET.**

10. **PROTECT THE POWER CORD FROM BEING WALKED ON OR PINCHED PARTICULARLY AT PLUGS, CONVENIENCE RECEPTACLES, AND THE POINT WHERE THEY EXIT FROM THE APPARATUS.**

11. **ONLY USE ATTACHMENTS/ACCESSORIES SPECIFIED BY THE MANUFACTURER.**

12. **USE ONLY WITH CART, STAND, TRIPOD, BRACKET, OR TABLE SPECIFIED BY THE MANUFACTURER, OR SOLD WITH THE APPARATUS. WHEN A CART IS USED, USE CAUTION WHEN MOVING THE CART/ APPARATUS COMBINATION TO AVOID INJURY FROM TIP-OVER.**



Do not place this TV on an unstable cart, stand, tripod, bracket, or table. The TV may fall, causing serious injury to someone, and serious damage to the appliance. A TV and cart combination should be moved with care. Quick stops, excessive force, and uneven surfaces may cause the TV and cart combination to overturn.

13. **UNPLUG THIS APPARATUS DURING LIGHTNING STORMS OR WHEN UNUSED FOR LONG PERIODS OF TIME.**

For added Protection for this TV receiver during a lightning storm, or when it is left unattended and unused for long period of time, unplug it from the wall outlet and disconnect the antenna or cable system. This will prevent damage to the TV due to Lightning and power line surges.

14. **REFER ALL SERVICING TO QUALIFIED SERVICE PERSONNEL. SERVICING IS REQUIRED WHEN THE APPARATUS HAS BEEN DAMAGED IN ANY WAY, SUCH AS POWER-SUPPLY CORD OR PLUG IS DAMAGED, LIQUID HAS BEEN SPILLED OR OBJECTS HAVE FALLEN INTO THE APPARATUS, THE APPARATUS HAS BEEN EXPOSED TO RAIN OR MOISTURE, DOES NOT OPERATE NORMALLY, OR HAS BEEN DROPPED.**

Note: All figures in the manual are for reference only, please refer to the actual units to determine their appearance.

---

## CLEANING AND MAINTENANCE

**The front of the display panel has been specially treated. Wipe the panel surface gently using only a cleaning cloth or a soft, lint-free cloth.**

If the surface is particularly dirty, soak a soft, lint-free cloth in a weak detergent solution and then remove excess liquid. Use this cloth to wipe the surface of the display panel, and then wipe it with a dry cloth,

of the same type, until the surface is dry.

Do not scratch or hit the surface of the panel with fingernails or other hard objects. Furthermore, avoid contact with volatile substances such as insect sprays, solvents and thinner; otherwise, the quality of the surface may be adversely affected.

## DEAR PROSCAN CUSTOMER

Welcome to the bright and vivid world of Proscan TV set. We hope that you will have many years of enjoyment from your new select.

To obtain maximum benefit from your set. Please read this manual before making any adjustments and retain them together with purchase receipt for future reference.

### Product Registration

Please fill out the product registration card and return it immediately. Returning the card allows us to contact you if needed. Keep your sales receipt to obtain warranty parts and service and for proof of purchase. Attach it here and record the serial and model numbers in case you need them. The numbers are located on the back of the television.

**Model No.** \_\_\_\_\_

**Serial No.** \_\_\_\_\_

**Purchase Date:** \_\_\_\_\_

**Dealer/Address/Phone:** \_\_\_\_\_

Please read all the safety and operating instructions carefully before begin.

# Table of contents

## TABLE OF CONTENTS

CAUTION AND WARNING.....	1
IMPORTANT SAFETY INSTRUCTIONS.....	3
CLEANING AND MAINTENANCE.....	4
DEAR PROSCAN CUSTOMER.....	4
SAFETY PRECAUTIONS.....	6
INSTALLATION.....	7
Preparation for using your new TV .....	8
FRONT PANEL.....	8
REAR PANEL.....	9
CONNECTIONS AND EXTERNAL INPUT SETTINGS.....	10
Using the Remote control.....	11
LEARNING ABOUT REMOTE CONTROL.....	11
REMOTE CONTROL INSTRUCTIONS.....	12
Basic operation.....	13
TURNING ON AND OFF THE TV.....	13
CHOOSING TV CHANNEL.....	13
SELECTING INPUT SOURCE.....	14
VOLUME ADJUSTMENT.....	14
Setup menu operation.....	15
ADJUST THE OSD SCREEN.....	15
SELECT ON SCREEN LANGUAGE.....	16
PICTURE MENU OPTIONS .....	16
AUDIO MENU OPTIONS.....	17
SETUP MENU OPTIONS.....	18
FEATURE MENU OPTIONS.....	20
VGA MENU OPTIONS.....	25
YPBPR MENU OPTIONS.....	26
HDMI MENU OPTIONS.....	27
APPENDIX .....	28
Troubleshooting.....	28
Removing TV Stand.....	31
Wall Mounting Unit Specification.....	32
Safety Warnings.....	33
Universal Remote Control Code List .....	33
TV Specification.....	34

# Safety Precautions

---

## SAFETY PRECAUTIONS

### **WARNING**

**KEEP UNNEEDED SMALL PARTS AND OTHER OBJECTS OUT OF THE REACH OF SMALL CHILDREN. THESE OBJECTS CAN BE ACCIDENTALLY SWALLOWED. ALSO, BE CAREFUL ABOUT PACKAGING MATERIALS AND PLASTIC SHEETS.**

### Set up

Do not place the TV set on sloped or unstable surfaces.

Do not place any objects on top of the TV set. If water spills onto the TV set or foreign objects get inside it, short-circuiting may occur which could result in fire or electric shock. If any foreign objects get inside the TV set, please consult an Authorized Service Center.

Do not cover the ventilation holes. Doing so may cause the TV set overheated and can cause fire or damage to the TV set.

Avoid installing this product near electronic equipment that is readily affected by electromagnetic waves. It may cause interference in image, sound, etc. In particular, keep video equipment away from this product.

### AC Power Supply Cord

Securely insert the power cord plug as far as it will go. If the plug is not fully inserted, heat may be generated which could cause fire. If the plug is damaged or the wall socket plate is loose, they should not be used.

Do not handle the power cord plug with wet hands. Doing so may cause electric shocks.

Do not do anything that might damage the power cable. When disconnecting the power cable, hold the plug, not the cable.

Do not make any modifications to, place heavy objects on, place near hot objects, heat, bend, twist or forcefully pull the power cable. Doing so may cause damage to the power cable which can cause fire or electric shock. If damage to the cable is suspected, have it repaired at an Authorized Service Center.

If the TV set will not be used for a long period of time, unplug the power cord from the wall outlet.

### If Problems Occur During Use

If a problem occurs (such as no picture or no sound), or if smoke or an abnormal odor is detected from the TV set, unplug the power cord immediately. Continued use of the TV under these conditions might cause fire or permanent damage to the unit. Have the TV evaluated at an Authorized Service Center. Service to the TV by any unauthorized personnel is strongly discouraged due to its high voltage dangerous nature. If water or foreign objects get inside the TV set, if the TV set is dropped, or if the cabinet becomes damaged, disconnect the power cord plug immediately. Contact an Authorized Service Center for any repairs that need to be made.

# Safety Precautions

---

## When using the TV set

Do not bring your hands, face or objects close to the ventilation holes of the TV set. Top of the TV set is usually very hot due to the high temperature of exhaust air being released through the Ventilation holes. Burns or personal injuries can happen if any body parts are brought too close. Placing any object near the top of the TV could also result in heat damage to the object as well as to the TV if its ventilation holes are blocked.

Be sure to disconnect all cables before moving the TV set. Moving the TV with its cables attached might damage the cables which, in turn, can cause fire or electric shock.

Disconnect the power plug from the wall outlet as a safety precaution before carrying out any cleaning.

Electric shocks can result if this is not done.

Clean the power cable regularly to prevent it from becoming dusty. Built-up dust on the power cord plug can increase humidity which might damage the insulation and cause fire. Unplug the cord from the wall outlet and clean it with a dry cloth.

This TV set radiates infrared rays. Therefore, it may affect other infrared communication equipment. Install your infrared sensor in a place away from direct or reflected light from your TV set.

## INSTALLATION

### Selecting a location for the TV

1. Place the TV on the floor or on a sturdy platform in a location where light does not directly hit the screen.
2. Place the TV far enough from the walls to allow proper ventilation. Inadequate ventilation may cause overheating, which may damage the TV.

Note: Please contact local dealer for wall mounting.

### Optional External Equipment

For best performance, video cables should utilize 75 ohm coaxial shielded wire. Cables are available from your dealer or electronic supply store.

Before you purchase any cables, be sure you know what type of output and input connectors your various components require. Also determine the length of cable you will need.



# Preparation for using your new TV – Front Panel

## FRONT PANEL

### Familiarizing Yourself with the Main Hardware

(The picture of the product may vary depending on the model)

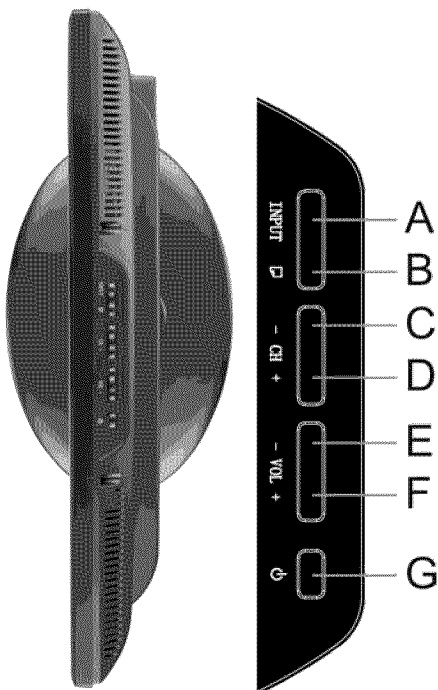

#### TV buttons:

- A. Select signal input.  
(It changes to "ENTER" function when main menu displays)
- B. Main Menu display and menu selection
- C. Channel down
- D. Channel up
- E. Volume down
- F. Volume up
- G. ON/OFF button

# Preparation for using your new TV – Rear Panel

## REAR PANEL

Rear panel

(The picture of the product may vary depending on the model)

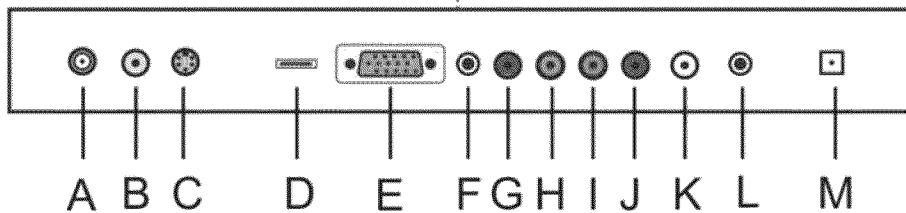
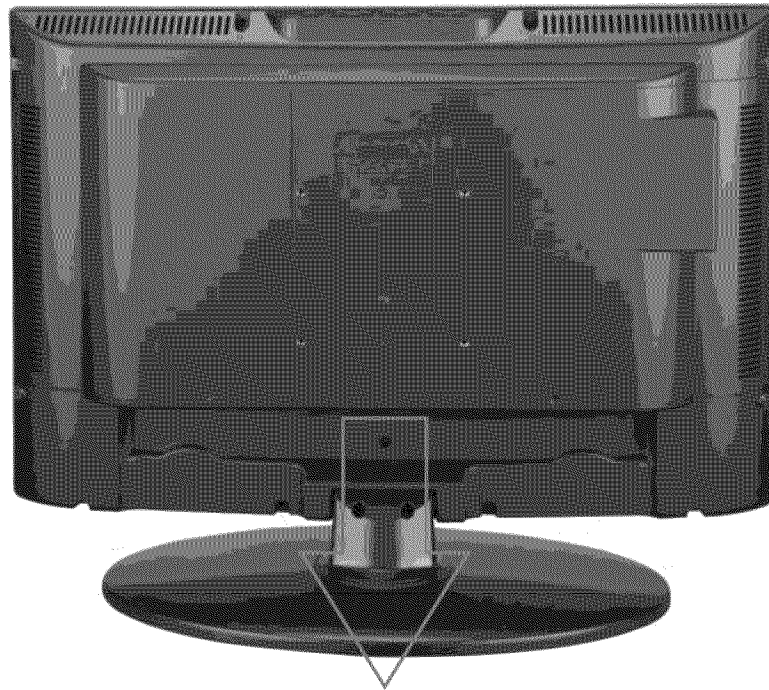

### HDMI Input

- Input : D

### Component Input 1

- Video : I, H, G
- Audio : K, J

### Composite Input

- Video : B
- Audio : K, J

### S-Video Input

- Video : C
- Audio : K, J

### VGA input

- Video : E
- Audio : F (3.5mm plug)

### Others

- Power Input: M
- Headphone out: L
- External Antenna: A

# Preparation for using your new TV – Connections

## CONNECTIONS AND EXTERNAL INPUT SETTINGS

### 1. Checking Items before Connecting

Please check the list below before connecting the product to other devices.

< Check items before connecting >

Check the instruction manual when connecting external devices. External products sometimes have different buttons and locations.

- A. Do not connect the power unless every connection is well connected. The product may be damaged if turned on while still in the process of being connected.
- B. Connect the left (white) and right (red) cables correctly to the sound cable.
- C. Check the terminals to connect the product to on the rear panel.

### 2. Connecting an Antenna

There are internal and external types of antenna.

< Connecting an Antenna >

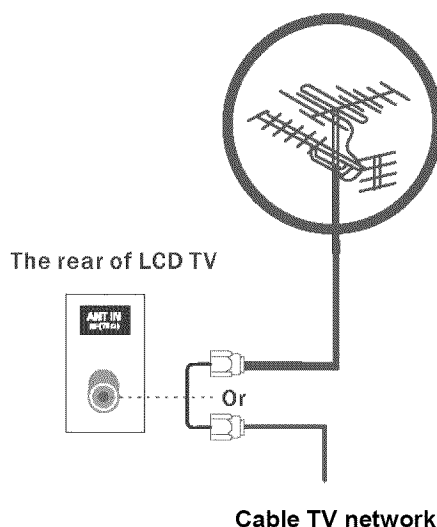

- A. Use a coaxial cable to connect the rear panel of the TV's [AIR] or [CABLE] terminals and the wall mount or external antenna.
- B. When an Air signal is required, connect to the [AIR] terminal. If a Cable signal is required, connect to the [CABLE] terminal. If both Air and Cable are available, and then connect both [AIR] and [CABLE] terminals.
- C. Connect the TV power cord when connecting everything else.

### CAUTION

Avoid bending the copper tip at the center of the coaxial cable.

# Using the remote control – Learning about remote control

## LEARNING ABOUT REMOTE CONTROL

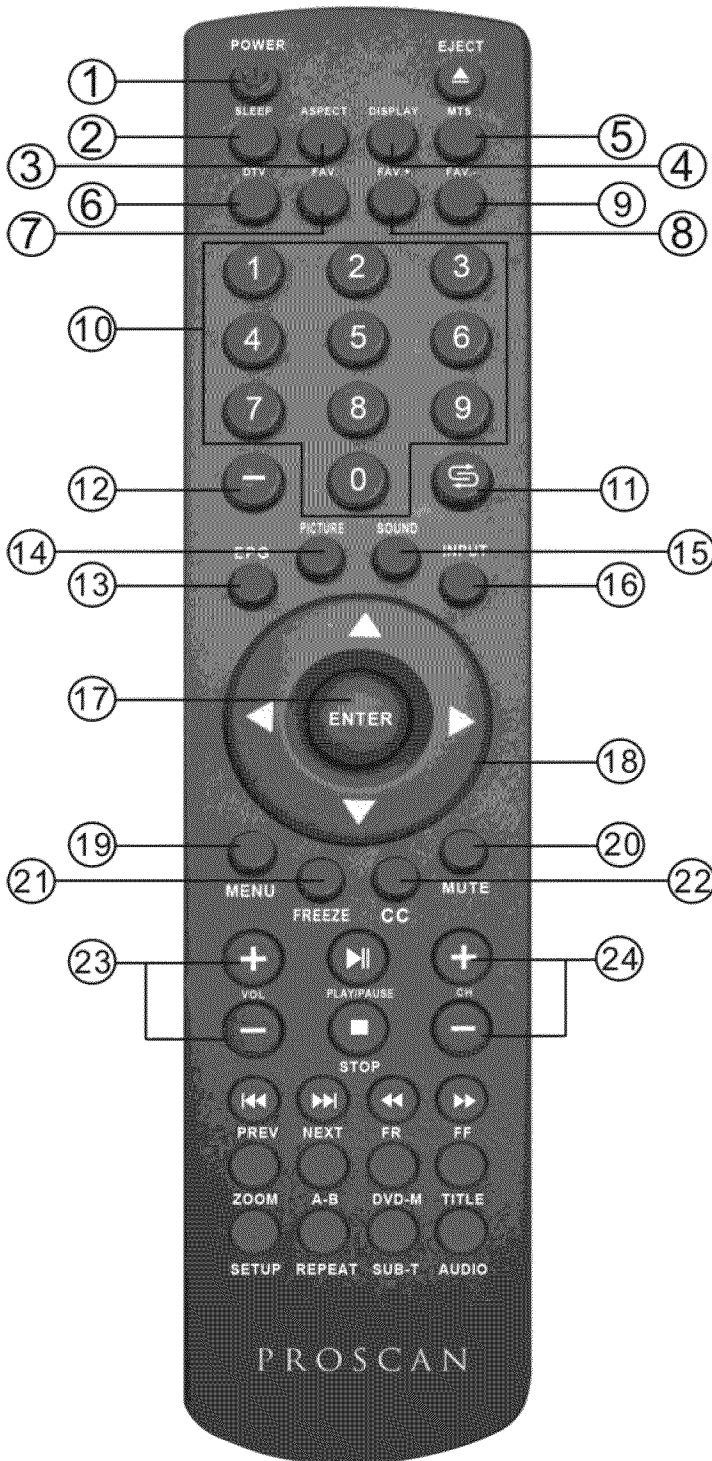

1. POWER: Power on/off.
2. SLEEP: Press to select a preset time interval to automatically shut the TV.
3. ASPECT: Press to adjust the screen size.
4. DISPLAY: Press to Check your current mode.
5. MTS: Press to select your favorite language in digital broadcasting.
6. DTV: Press to change between Analog TV and Digital TV.
7. FAV: Add/delete the current channel to your favorite channel.
8. FAV+: Press to view the next favorite channel.
9. FAV-: Press to view the previous favorite channel.
10. Numeric Buttons: Press to change the channel directly using the numeric buttons.
11. RECALL: Press to switch between the current channel and the last channel.
12. -: When selecting a digital broadcast channel, press the number, followed by “-” button, followed by sub channel number.
13. EPG: One of signal channel EPG or Multi channel EPG.
14. PICTURE: Press to change to a preset picture mode.
15. SOUND: Press to change to a preset sound mode.
16. INPUT: Press to Display a menu of all available input sources, Also used to confirm your choice in the on-screen menu.
17. ENTER: Enter and confirm button.
18. UP/DOWN LEFT/RIGHT : The direction keys.
19. MENU: Press to display main menu.
20. MUTE: Press to temporarily switch the sound off.
21. FREEZE: Press to freeze the current picture.
22. CC: Press to select Closed Caption.
23. VOL+/-: Volume control buttons.
24. CH+/-: Channel control buttons.

## REMOTE CONTROL INSTRUCTIONS

### Inserting the batteries into the remote control

1. Push the back of the remote control
2. pull forward slightly.
3. Insert two AAA 1.5V batteries
4. ensuring the correct polarity (+/-).
5. Close the lid.

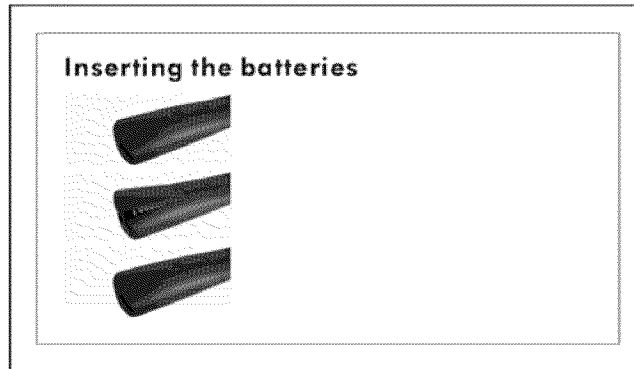

- If the remote control is not working, see the checkpoints below.
- Are the polarities of the batteries (+, -) correct?
- Are the batteries worn out?
- Is there an AC power failure?
- Is the power cable plugged in?
- Is any special fluorescent or neon sign board turned on?

### Remote Control Reception Angle

Use the Remote control within a range of 7~10m and at an angle of 30° to either side of the receiver.

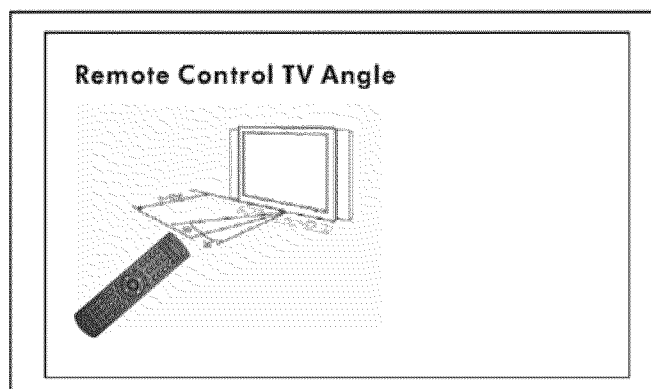

### CAUTION

- Used batteries should be recycled
- Kept out of children's reach.
- Do NOT use new and old batteries together.
- Change both batteries at the same time.
- When not using the remote control over a long time, remove the batteries from the unit.

# Basic operation - Choosing TV channel

## TURNING ON AND OFF THE TV

### TURN ON LCD TV

1. Connect the AC input cable to power the LCD TV. At this time the TV will enter standby mode and indicator shows red.
2. User **POWER** button or  button on the remote control.
3. Wait 5 second after switch off LCD TV then you can turn on LCD TV again.

## CHOOSING TV CHANNEL

### 1. Using the CH + / CH - on the top panel or on the remote control.

- Press **CH +** to increase channel number.
- Press **CH -** to decrease channel number.

### 2. Using 0-9 digital buttons and – button

You can select the channel number by pressing 0 to 9.

### 3. For example:

#### IN ANALOG SIGNAL:

To select channel (e.g. Channel 22): Press 2 -> 2 ->ENTER, It will jump to 22-0 directly.

#### IN DIGITAL SIGNAL:

To select digit channel (e.g. Channel 22-1): Press 2 -> 2 -> - > 1 ->ENTER, the program will appear immediately.

**NOTE: Sub channel number of analog channel is always zero. But when you in the digital signal, if you enter physical channel number and not end with “ENTER”, channel selection will be made if there is no operation within a few seconds.**

## Basic operation – Selecting input source

---

### SELECTING INPUT SOURCE

You can select the input source by pressing the **INPUT** on the remote control or on the top panel.

#### INPUT Menu

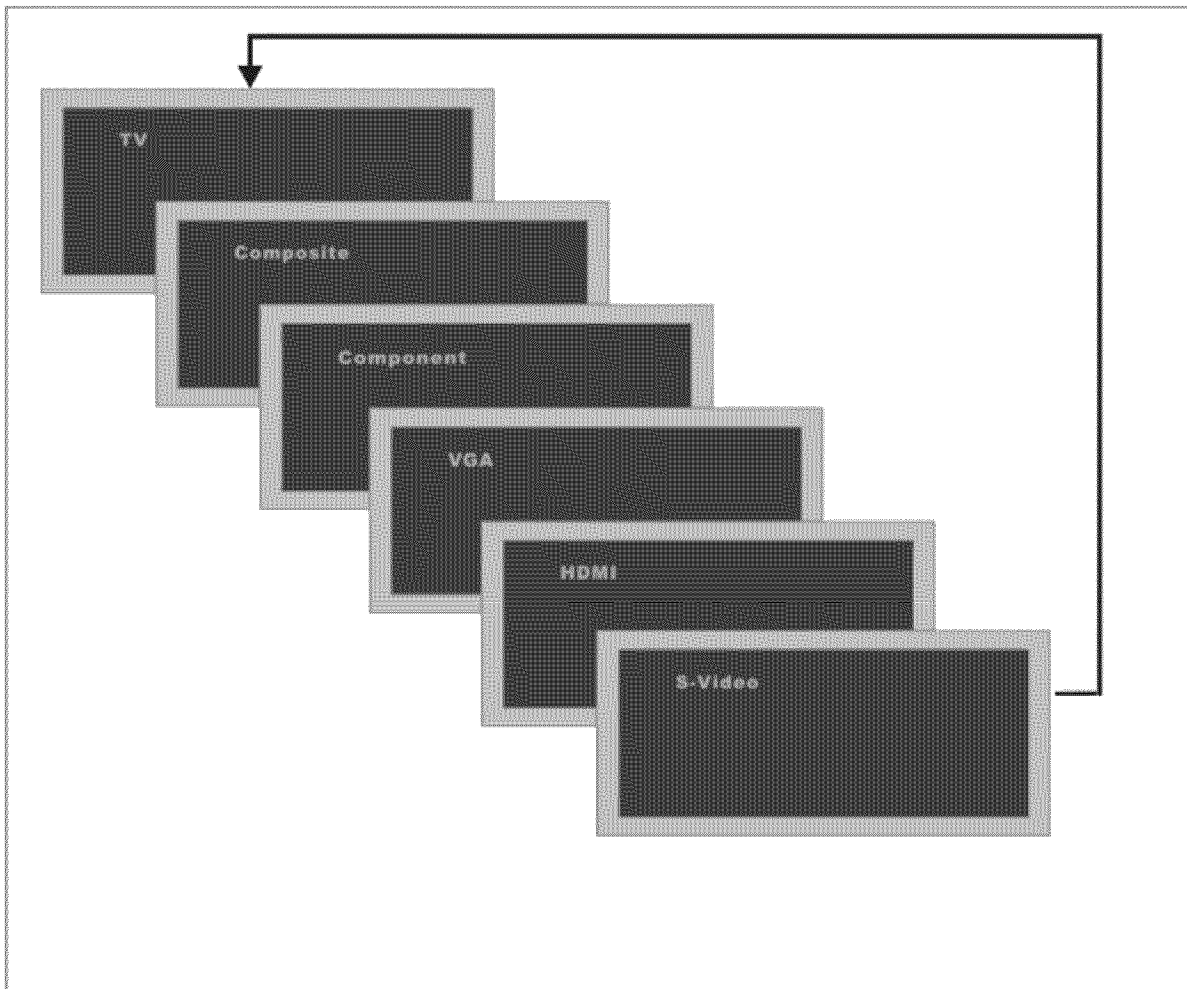

### VOLUME ADJUSTMENT

1. Press **VOL+/-** to adjust the volume.
2. If you want to switch the sound **OFF**, press the **MUTE**.
3. You can cancel this function by pressing **MUTE** or **VOL+/-**.

# Setup menu operation – Adjust the OSD screen

## ADJUST THE OSD SCREEN

Press the **MENU** button to display the main menu.

Use ◀ / ▶ / ▲ / ▼ buttons to select and adjust the available menus.

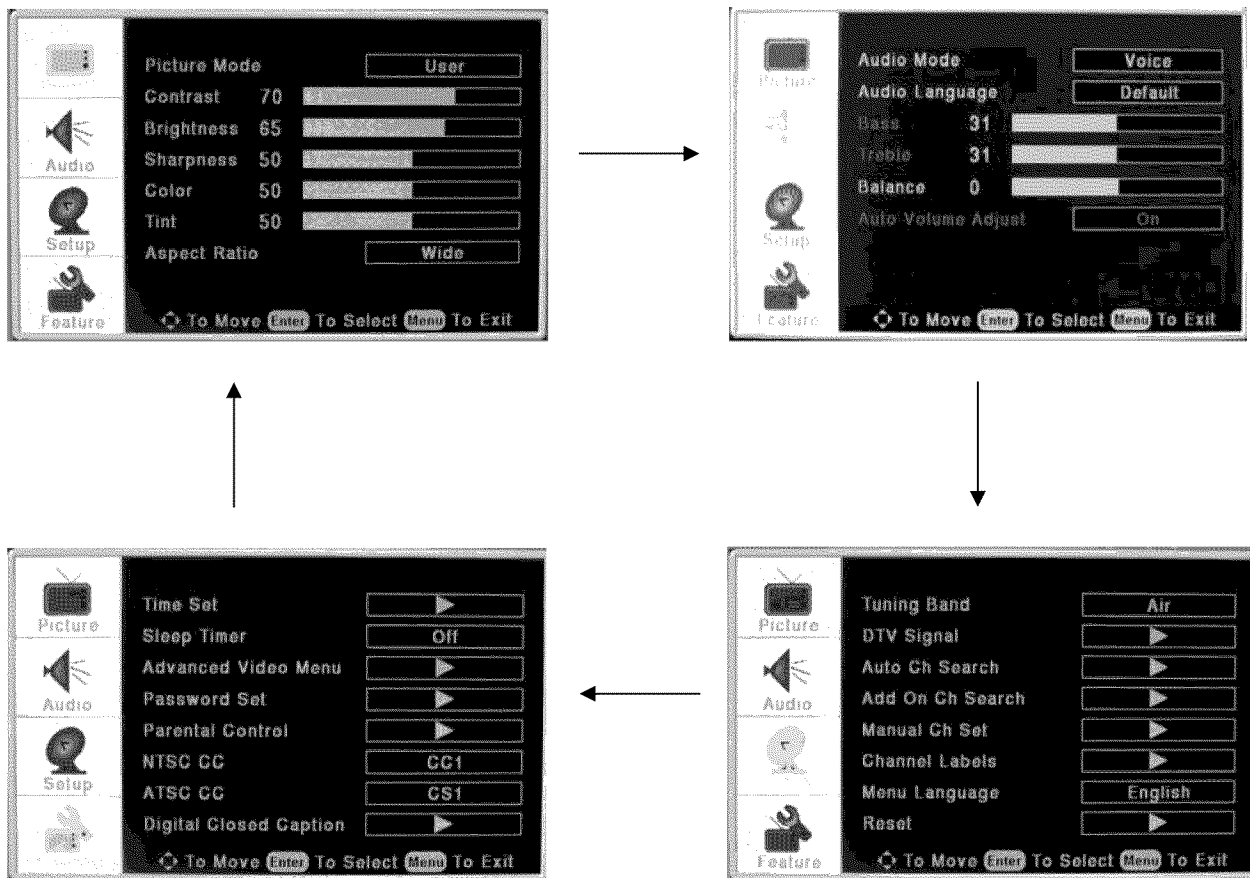

**NOTE:** The OSD (On Screen Display) function enables you to adjust the screen status conveniently since it provides graphical presentation.

When the cursor stays on a main menu function (Picture, Audio, Setup or Feature), you need to use **ENTER** or **▶** button to activate it. After activating, the cursor will go forward into the submenu, which you can use to choose the concrete functions with **▲** / **▼** button.

The images in this document may vary from your TV's menu depending on the model. We provide the instruction manual for better understanding and operation to the TV set. Therefore, all the pictures here are for reference only.



## Setup menu operation – Screen language & Picture menu option

### SELECT ON SCREEN LANGUAGE

**NOTE:** If you use your LCD TV for the first time, you should select the language which will be used for displaying menus and indications.

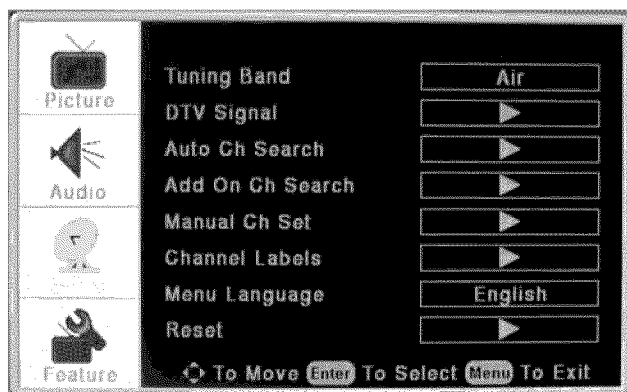

1. Press **MENU** to display the main menu.
2. Press **▲ / ▼** repeatedly to select the **SETUP MENU**.
3. Use **▲ / ▼** and **ENTER** to select **MENU LANGUAGE**.
4. Press **ENTER** button to select your desired language.

### PICTURE MENU OPTIONS

**NOTE:** In this manual, the OSD (On Screen Display) may be different from your TV's in colors.

Press the **MENU** on the top panel or on the remote control and then use **▲ / ▼** to select the **PICTURE** menu.

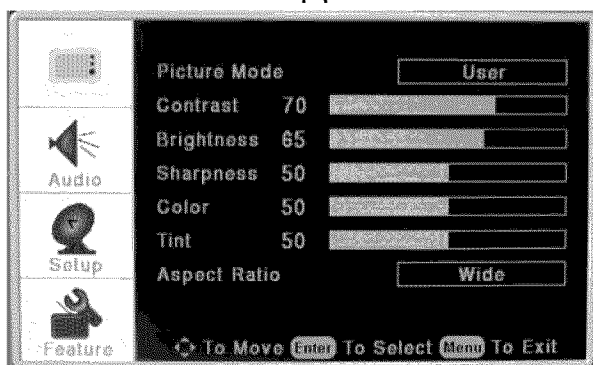

1. Use **▲ / ▼** to select what you want to adjust in the **PICTURE MODE**.
2. Press **ENTER** button to adjust.
3. When you are satisfied with your adjustment. Press **MENU** to exit the main menu.

#### Picture Mode

Select the type of picture which best corresponds to your viewing requirements by selecting Picture Mode in **PICTURE** menu. When you press **◀ / ▶** buttons on the remote control, may select the picture modes (**User / Vivid / Bright / Standard**).

# Setup menu operation – Audio menu option

---

## Contrast

Press **ENTER** button to select it and then use ◀ / ▶ to adjust the contrast of picture.

## Brightness

Press **ENTER** button to select it and then use ◀ / ▶ to adjust the brightness of picture.

## Sharpness

Press **ENTER** button to select it and then use ◀ / ▶ to adjust the sharpness level of picture.

## Color

Press **ENTER** button to select it and then use ◀ / ▶ to adjust the color saturation

## Tint ( NTSC Input only)

Press **ENTER** button to select it and then use ◀ / ▶ to adjust the tint of picture

## Aspect Ratio

Press **ENTER** button to select the ratio of picture display such as Normal/Zoom/Wide and Cinema.

## AUDIO MENU OPTIONS

Press **MENU** on the top panel or on the remote control and then use ▲ / ▼ to select the **AUDIO** menu.

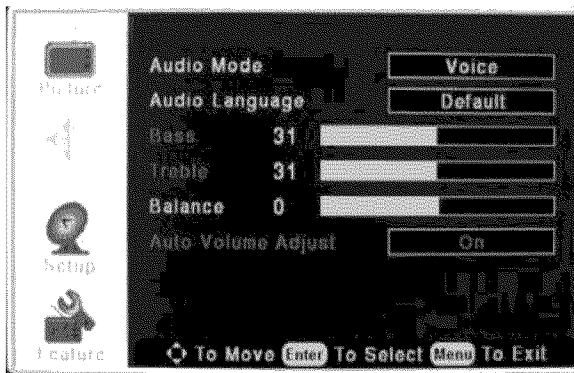

1. Use ▲ / ▼ to select what you want to adjust in the **AUDIO** menu.
2. Press **ENTER** button to select it and then use ◀ / ▶ to adjust
3. When you are satisfied with your adjustment, press **MENU** to exit the main menu.

## Audio Mode

You can select the type of sound which best corresponds to your listening requirements by selecting sound in **SOUND** menu.

You may select the sound mode directly by pressing the **SOUND** button on the remote control.

# Setup menu operation – Setup menu option

## Audio Language

Press **ENTER** to one of the audio language such as English/ French and Spain, but the condition is that the program system has included the language code.

## Bass

Press **ENTER** button to select it and then use ◀ / ▶ to increase or decrease the level of the lower-pitched sounds.

## Treble

Press **ENTER** button to select it and then use ◀ / ▶ to increase or decrease the level of the higher-pitched sounds.

## Balance

Press **ENTER** button to select it and then use ◀ / ▶ to adjust the audio output between left and right speakers.

## Auto Volume Adjust

Press **ENTER** button to adjust the volume automatically (TV and HDMI input only).

## SETUP MENU OPTIONS

Press **MENU** on the top panel or on the remote control and then use ▲ / ▼ to select the **SETUP** menu.

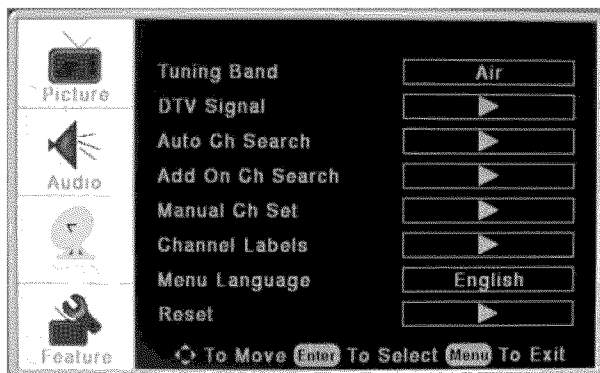

1. Use ▲ / ▼ to select what you want to adjust in the **SETUP** menu.
2. Press **ENTER** button to select it and then use ◀ / ▶ to adjust
3. When you are satisfied with your adjustment, press **MENU** to exit the main menu.

## Tuning Band

Press **ENTER** button to select Air, Cable STD, Cable HRC, Cable IRC or Cable Auto.

## DTV Signal

DTV Signal menu will show the intensity of DTV signal.

User can adjust the direction and orientation of external antenna by checking DTV Signal.

# Setup menu operation – Setup menu option

## Auto Ch Search

Press **▲ / ▼** to move the cursor to the item to be selected (item selected highlighted in yellow). Press **ENTER** key to enter your selection and scan. After the scan is finished, the following menu will display. The channels found the automatically saved as below:

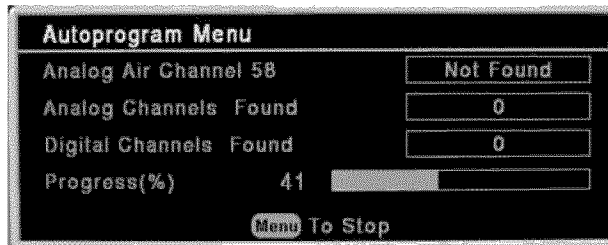

**Note:** If you want you exit the Auto Ch Search during the Auto search process, press MENU twice to exit.

## Add On Ch Search

When the channels are found, use **ENTER** to add it to the channel list

## Manual Ch Set

Press **ENTER** button to display a channel list that you can select channel as below:

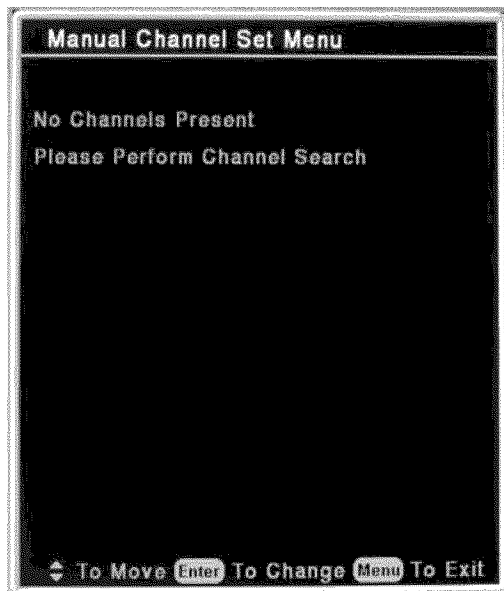

**Note:** this image comes from a engineering sample. Please operate according to actual channel list in your TV.

## Channel Labels

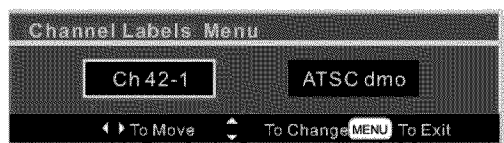

Allows you to name the channel that is selected. Use **▲ / ▼** to move and use **◀ / ▶** to change.

## Menu Language

To select language of the OSD such as English/ French and Spain.

# Setup menu operation – Feature menu option

## Reset

Press **ENTER** to return to the factory setting.

## FEATURE MENU OPTIONS

Press **MENU** on the top panel or on the remote control and then use **▲ / ▼** to select the **FEATURE** menu

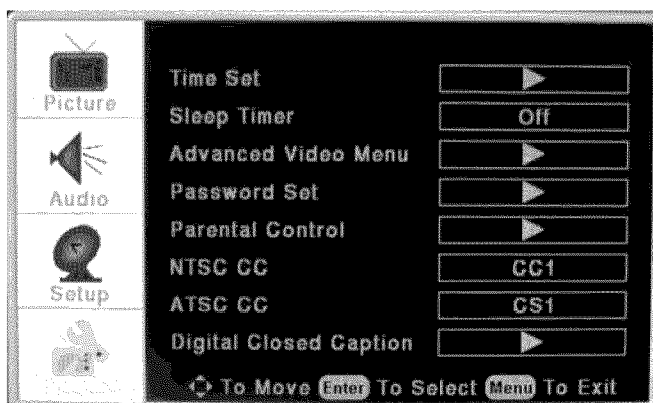

1. Use **▲ / ▼** to select what you want to adjust in the **FEATURE** menu.
2. Press **ENTER** button to select it and then use **◀ . / ▶** to adjust
3. When you are satisfied with your adjustment, press **MENU** to exit the main menu.

## Time Set

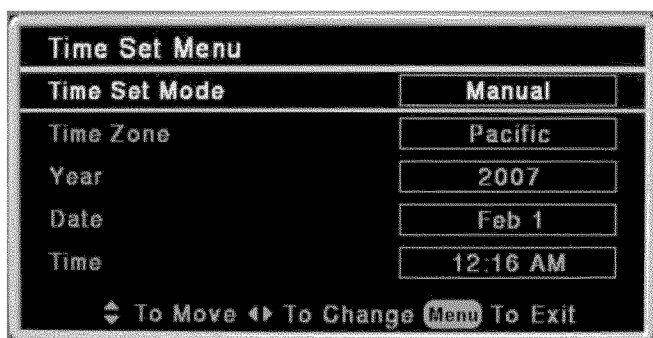

### Time Set Mode

You can select one of auto and manual to set the time. When selected auto, the item of year/date and time will be disabled and can not to adjust. When select the manual mode, you can press **▲ / ▼ / ▶ / ◀** to set the corresponding functions.

### Time Zone

Press **ENTER** button to select it and then use **◀ . / ▶** to select the time zone such as Pacific/ Alaska/ Hawaii/ Eastern/ Central/ Mountain

# Setup menu operation – Feature menu option

---

## Sleep Timer

Press **ENTER** button to select it and then use ◀ / ▶ to select the amount of time before your TV turn off automatically and press the ENTER that can select the 15min/30min/45min/60min/90min/120min/180min/240min and OFF.

## Advance Video Menu

Press **ENTER** to enter the advance video menu as below.

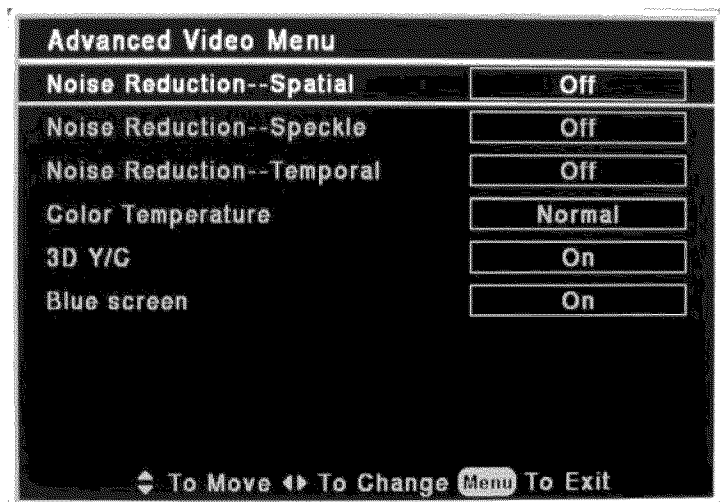

- Noise Reduction- Spatial: press ◀ / ▶ to select on or off.
- Noise Reduction- Speckie: press ◀ / ▶ to select on or off.
- Noise Reduction-Temporal: press ◀ / ▶ to select on or off.
- Color Temperature: press ◀ / ▶ to select one of Normal/ Cool and Warm.
- 3D Y/C: press ◀ / ▶ to select on or off.
- Blue screen: Select to turn on blue screen display when there is no signal.

## Password Set

Press the **ENTER** to enter old password menu, and then input the number of 0-9 as below, and you can change the password when you input the new on twice. And the original password is 0000.

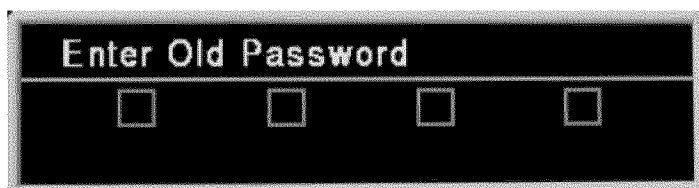

Note: In case of password oblivion or missing, we provide the all-purpose password 1470.

## Parental Control

Press **ENTER** to enter the sub-menu and then uses the 0-9 to enter the correct password and the Parental Control Menu will display.

# Setup menu operation – Feature menu option

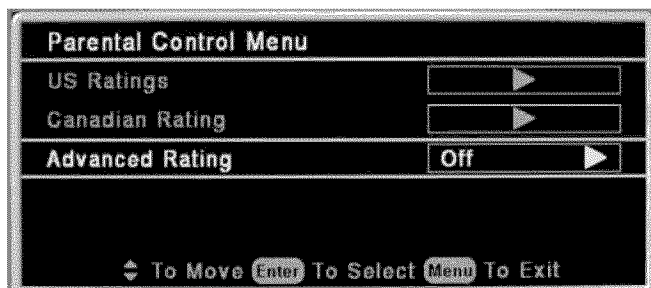

Note: Advanced Rating is only available in digital channel.

## US Ratings

Press **ENTER** to enter the Parental Control Menu as below.

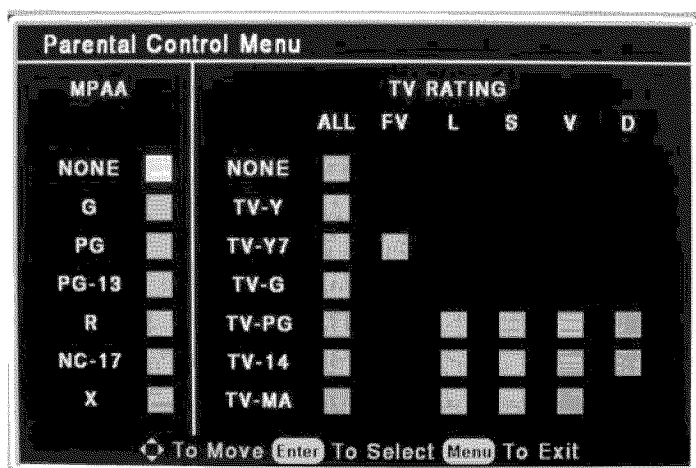

## MPAA

Press **ENTER** to lock or unlock one of NONE/ G/ PG/ PG-13/ R/ NC-17 and X.

- NONE: No restrictions.
- G: General Audience. This contains little or no violence, no strong language, and little or no sexual dialog or situations.
- PG: Children under 13 should be accompanied by an adult.
- PG-13: Parental guidance suggested. Children under 13 should be accompanied by an adult.
- R: Restricted. Viewers should be 17 or older.
- NC-17: Not classified. Viewers should be 17 or older.
- X: Hardcore. Viewers should be 17 or older.

## TV Rating

Press **ENTER** to lock or unlock one of TV-MA/ TV-14/ TV-PG/TV-G/TV-Y7/TV-Y and NONE.

- TV-MA: Mature audiences only. This program may contain mature themes, profane language, graphic violence and explicit and explicit sexual content.
- TV-14: Parents strongly cautioned. This program may contain sophisticated themes, sexual content, strong language and more intense violence.
- TV-PG: Parents guidance suggested. The program may contain infrequent coarse language, limited violence, some suggestive sexual dialog and situations.
- TV-G: General audience. This contains little or no violence, no strong language, and little or no sexual dialog or situations.

# Setup menu operation – Feature menu option

- TV-Y7: Directed for older children. Themes and elements in this program may include mild physical or comedic violence, or may frighten children under the age of seven.
- TV-Y: All children. The themes and elements in this program are specifically designed for a very young audience, including children from ages two six.
- NONE: No restrictions.

## Canadian Ratings

Press **ENTER** to enter the Canadian Ratings as below.

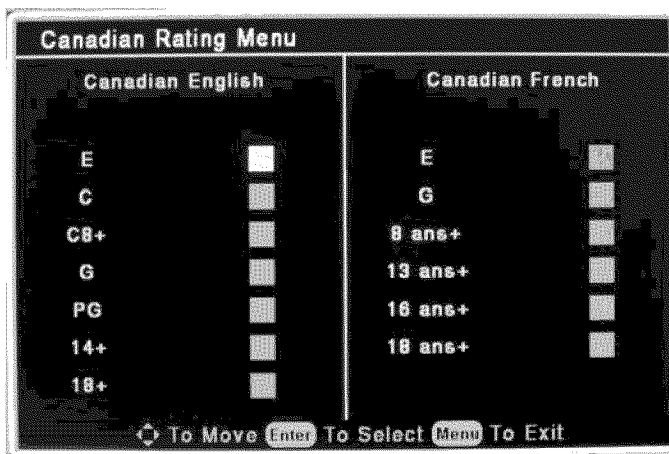

## Canadian English

Press **ENTER** to lock or unlock one of E/ C/ C8+/ G/ PG/ 14+/ 18+.

- E: Expect No restriction.
- C: Children.
- C8+: Viewers should be 8 or older.
- G: General Audience.
- PG: Parental guidance suggested.
- 14+: Restricted. Viewers should be 14 or older.
- 18+: Restricted. Viewers should be 18 or older.

## Canadian French

Press **ENTER** to lock or unlock one of E/ G/ 8 ans+/ 13 ans+/ 16 ans+ and 18 ans+.

- E: Expect No restriction.
- G: For all.
- 8 ans+: Restricted. Viewers should be 8 or older.
- 13 ans+: Restricted. Viewers should be 13 or older.
- 16 ans+: Restricted. Viewers should be 16 or older.
- 18 ans+: Restricted. Viewers should be 18 or older.



# Setup menu operation – Feature menu option

---

## Advanced Parental Lock

When select the ON for Advance Rating, the Advanced Parental Lock will display.

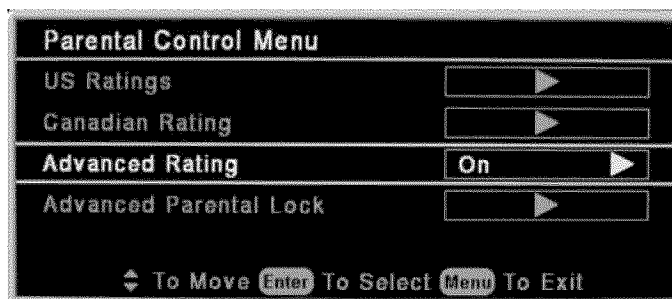

## NTSC CC

To adjust NTSC closed caption.

## ATSC CC

To adjust ATSC closed caption.

## Digital Closed Captions

This menu allows you to set the closed caption, and press **ENTER** to enter Closed Caption Options menu as below.

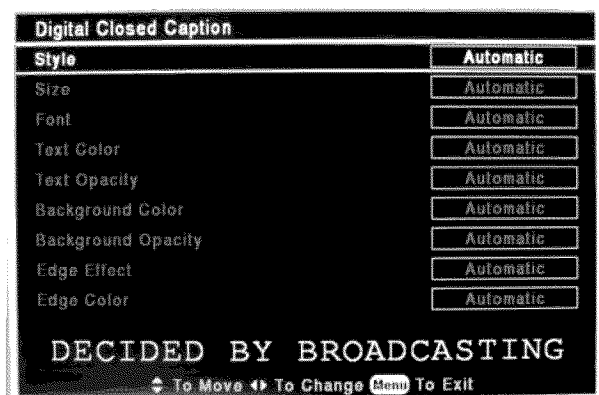

- Style: press ◀ / ▶ to select one of Automatic and Custom, when you select automatic, the other are disable and can not be adjusted.
- Size: press ◀ / ▶ to select one of Normal/ Large and Small.
- Font: press ◀ / ▶ to select one of Default and from Front 1 to Font 7.
- Text Color: press ◀ / ▶ to select one of Red/ Green/ Blue/ Yellow/ Magenta/ Cyan/ Black and White.
- Text Opacity: press ◀ / ▶ to select one of the Solid/ Flashing/ Transparent/ Translucent.
- Background Color: press ◀ / ▶ to select one of Red/ Green/ Blue/ Yellow/ Magenta/ Cyan/ Black and White.
- Background Opacity: press ◀ / ▶ to select one of the Solid/ Flashing/ Transparent/ Translucent.
- Edge Effect: press ◀ / ▶ to select one of the None/ Raised/ Depressed/ Uniform/ Left Shadow/ Right Shadow.
- Edge Color: press ◀ / ▶ to select one of Red/ Green/ Blue/ Yellow/ Magenta/ Cyan/ Black and White.

# Setup menu operation – VGA menu option

## VGA MENU OPTIONS

Continuously Press **INPUT** button on the remote control until coming “VGA” on the top-right screen.

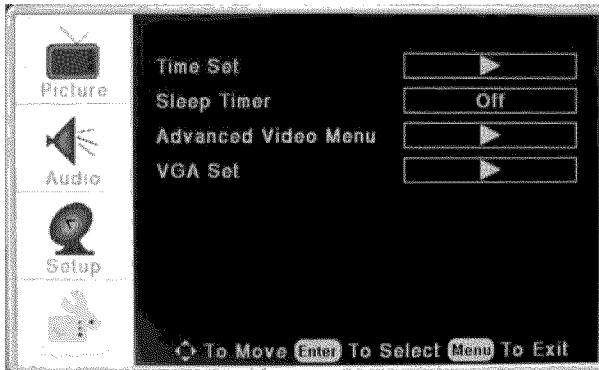

1. Use **▲ / ▼** to select what you want to adjust in the **FEATURE** menu.
2. Press **ENTER** button to select it and then use **◀ / ▶** to adjust
3. When you are satisfied with your adjustment, press **MENU** to exit the main menu.

### VGA Set

Press **▲ / ▼** button and then press **ENTER** to enter the VGA set menu as below

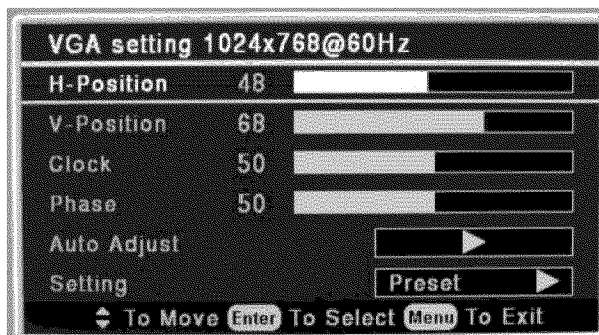

- **H-Position**  
Press **ENTER** button to select it and then use **◀ / ▶** to adjust the horizontal position of the picture.
- **V-Position**  
Press **ENTER** button to select it and then use **◀ / ▶** to adjust the vertical position of the picture.
- **Phase**  
Press **ENTER** button to select it and then use **◀ / ▶** to adjust the phase of the picture.
- **Clock**  
Press **ENTER** button to select it and then use **◀ / ▶** to adjust the clock of the picture.

*Note:*

*Phase- This function allows you to remove any horizontal noise and clear or sharpen the image of characters.*

# Setup menu operation – YPBPR menu option

*Clock- This function is to minimize any vertical bars or stripes visible on the screen background. And the horizontal screen size also will change.*

*Position- This function is to adjust the picture to Left/ Right and Up/ Down as you prefer.*

- **Auto Adjust**

Press **ENTER** button to select it and then use ◀ / ▶ to do auto adjust that automatically adjusts the available options for the best viewing configuration.

- **Setting**

Press **ENTER** to do preset that can return to the factory setting.

## YPBPR MENU OPTIONS

Continuously Press **INPUT** button on the remote control until coming “Component” on the top-right screen.

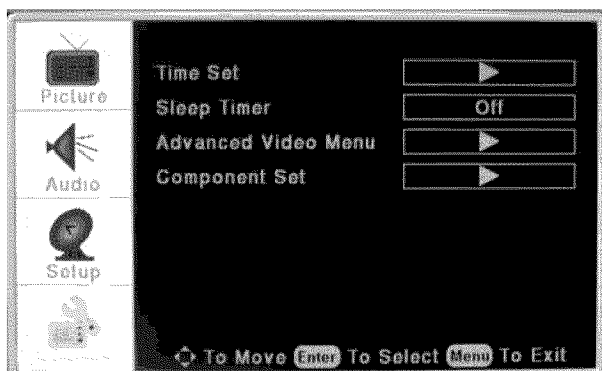

1. Use ▲ / ▼ to select what you want to adjust in the **FEATURE** menu.
2. Press **ENTER** button to select and then use ◀ / ▶ to adjust.
3. When you are satisfied with your adjustment, press **MENU** to exit the main menu.

### Component Set

Press ▲ / ▼ button and then use **ENTER** to enter the Component Set menu as below.

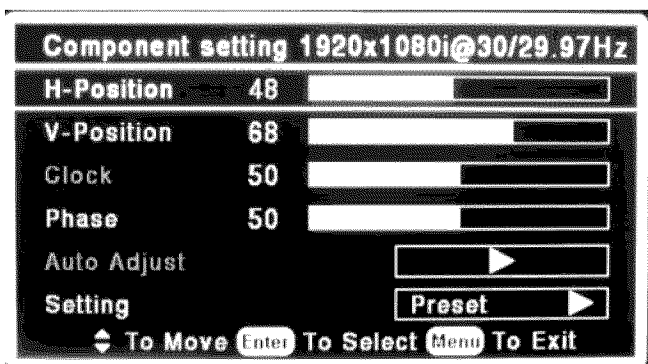

## Setup menu operation – HDMI menu option

### HDMI MENU OPTIONS

Continuously Press INPUT button on the remote control until coming "HDMI" on the top-right screen.

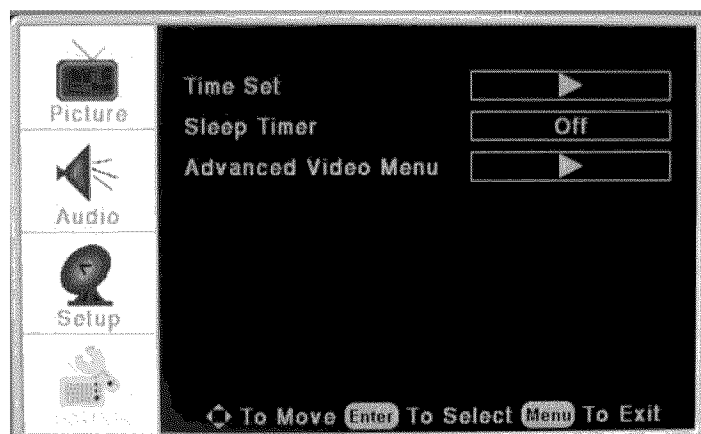

#### Time Set

Press ▲ / ▼ button and then use **ENTER** the time set menu that allows you to set the time the TV will display.

#### Sleep timer

Press **ENTER** button to select it and then use ◀ / ▶ to adjust the amount of time before your TV turn off automatically and press the **ENTER** that can select the 15min/30min/ 45min/60min/ 90min/120min/180min/240min and OFF.

#### Advance Video Menu

Press **ENTER** to enter the advance video menu.

## TROUBLESHOOTING

### Identifying Problems

If there are any problems using the product, please first consult the list below. If the list below does not solve the problem, call our Customer Service Center immediately.

#### Setup and Connection

The TV won't turn on. Check your power cable connection.

- I can't view the Basic channels. Check the connection of the antenna cable.
- I want to view cable channels. Register with your local cable company then connect their receiver to your TV.
- I want to view satellite channels. Setup your Satellite parabola antenna then connect your satellite receiver to the TV.
- Digital broadcasting is not functioning. Check your antenna cable connection. Check if the digital channel selection is correctly connected to your antenna cable.

#### Menu and Remote Control

- The Remote Control isn't functioning well.

Change the batteries.

Check the polarity of the batteries.

Check the angle of the remote control from the product or if there are any obstacles between the remote control and the product.

Check if you have pressed the correct key for the correct option.

Try to a bright light position near TV's which transmit a strong light source on TV <remote receiver> window.

- I cannot change channels with the remote control.

Press [TV/AV] and select <TV>.

Try to use the remote control for the cable or satellite receiver to change the channel.

- External input channels cannot be selected.

Check your external input connection cable.

- A Menu cannot be selected.

Check if the menu is grayed out, and if it is, that menu cannot be selected.

#### Screen

- Poor picture

Is the power cord unplugged? Make sure the power cable is plugged in correctly, and then press the power of the remote control.

- Black picture

Check if external input mode is selected

Press [external input selection] and select TV

- Lined and flickering picture.

Try to finely adjust the channel.

# Appendix - Troubleshooting

---

Are there any TV waves flowing or cordless radio transmitting stations? Avoid using cordless phones, hairdryers or electrical drills.

- Disfunctioning channels.  
Check if the channel has been selected correctly.  
Try changing the position of the antenna.
- Picture with white and black dots.  
Check if your antenna is damaged or any connections are broken.  
Replace your antenna.
- Only certain channels are in black and white  
Check if the program is being broadcast in black and white.  
Try to check the hue or contrast.
- The Sub-Screen is black.  
Check the power of the external device connected to the TV.  
If the power cord is disconnected, the screen will be black.
- Automatic turn-on is inactive.  
When turning off your TV, you need to use the remote control or press the power button on the TV. (If you pull the plug on the TV, the settings will be deleted.)

## Sound

- Poor quality sound  
Check if the program is in stereo. Stereo may not work well in areas with bad reception. Try using Mono for these areas.
- Sound is malfunctioning while using a cable.  
Check your sound connecting cable.  
Check if other channels also have no sound
- I can see images, but there is no sound.  
Press the volume buttons to increase the sound.  
Try watching a video (if the video has sound, check your cable company). If there is no problem with the cable receiver, then call our customer service.  
Check if press MUTE on the remote control..
- There is a malfunction after the volume is increased  
Try to adjust the external devices connected to the TV (Digital channel receiver, DTV, DVD, Cable channel receiver, video)  
If you can adjust your sound, try to balance the volume of the TV and the external device.

## Channel

- The channels are not functioning.  
Connect the antenna connectors again.  
Set to memorize channels in the automatic channel setting again.  
Query the particular broadcasting station.
- A limited number of channels are not functioning.  
Change the location or direction of the antenna.  
Try to select a few channels using numbers and memorize them using the add/delete button.  
Query the broadcasting station.
- Only UHF (14~69) Channels are unavailable.  
Check if the antenna is able to receive UHF.

# Appendix - Troubleshooting

---

## Monitor

- The PC Screen continually appears and disappears.  
Check the connection between the TV and the computer and see if the connector is locked.
- A "There is no signal" message appears.  
This happens if the signal from the video card is exceeded for the maximum resolution or frequency of the TV. Try to set the maximum resolution or frequency for the TV.  
See if power save mode of the PC functions properly. (This is deactivated when any key is pressed or the mouse is moved)
- The screen looks like there is water flowing on it.  
Check the connector connected to the TV.
- The screen is unclear and blurry.  
Change the frequency and phase adjustment. Change the Resolution and frequency to the standard limit.
- Unstable and flickering screen.  
The resolution and frequency of the PC's Graphics Card should be set within the TV's range. Check the TV menu's current mode and standard mode and set it up again.
- Some modes in standard mode are not working.  
Check the compatibility of the video card.  
If it is not working for compatible hardware, try to upgrade the driver of the graphics card.

## Appendix – Removing TV Stand

### Removing TV Stand

If you decide to install the wall mount your LCD TV, always use a VESA standard wall mount appropriate for the size and weight of the LCD TV.

#### CAUTION

- Be sure to follow the instructions. Incorrect installation of the stand/wall mount may result in the TV falling over.
- Before attaching (or detaching) the stand, unplug the AC cord from the AC input terminal.
- Unplug and remove any cables and/or other component connectors from the rear of the TV.

#### NOTES

Before proceeding, make sure the appropriate bracket(s) are attached to the wall and the back of the TV as described in the instructions provided with the wall bracket. Extreme care should always be used when removing the stand/wall mount to avoid damage to the LCD panel.

As shown below:

(The picture may vary depending on the model.)

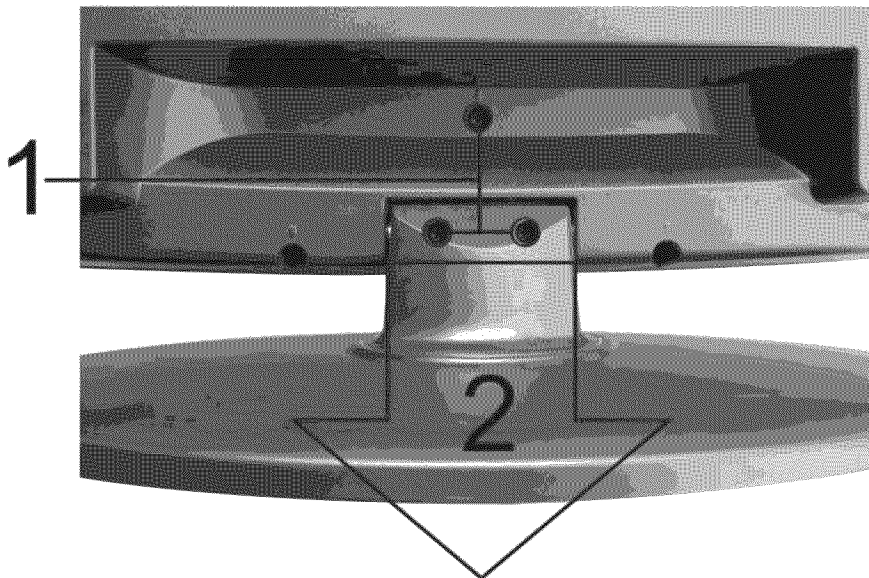

#### PROCEDURE

1. Place the TV set on a surface that is totally stable, flat and smooth (such as a table). The front panel of TV should face the surface. Remove 3 screws signed in red circles.
2. Draw out the stand gently.



## Appendix – Wall Mounting Unit Specification

### Wall Mounting Unit Specification

Wall mounting(unit: mm)	Screw Diameter(unit: mm)	Screw Length(unit: mm)
100X100	M4	12

Remark: The specification of screw is just used on the back unit.

**NOTE:** Wall mount bracket is not included with TV and mounting of wall mount bracket to wall may vary depending on brand and size of bracket. Customer should consult bracket mounting instructions that came with wall mount for specific information on how to mount bracket to wall.

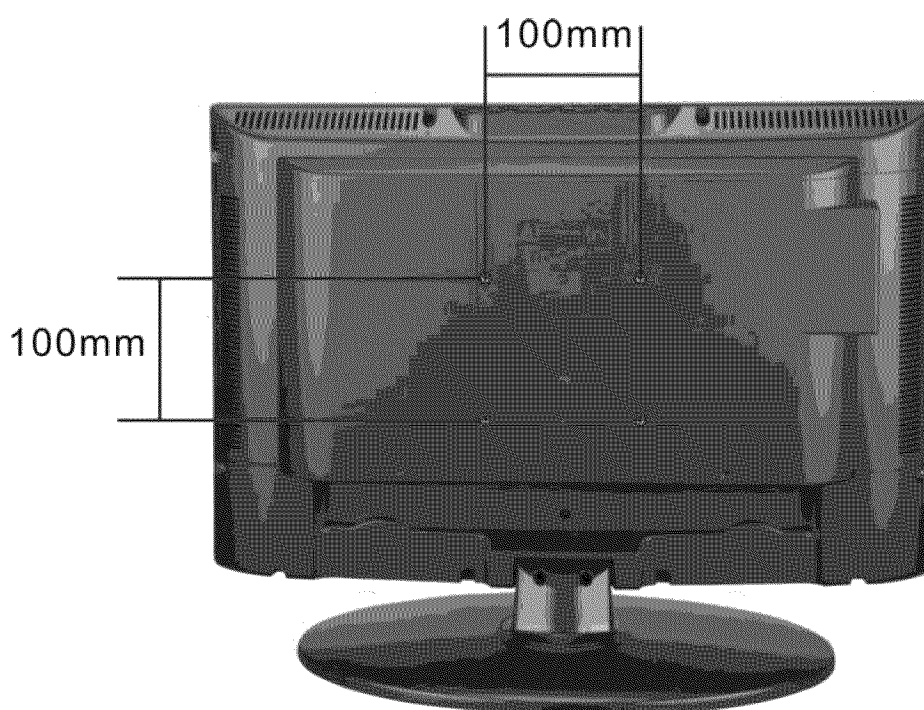

Before reading the installing instruction, please notice:

- A. The wall mount is not contained in the accessories sold with television. We only provide the installing specifications but not the wall mount itself. If you need the mount, please consult with the local dealer for the assorted fitting parts.
- B. We strongly suggest to set the wall mount with equipments of specification we ordered. If not, unappropriate installing may cause damage to both the device and yourself.

## Appendix – Safety Warnings

### **SAFETY WARNINGS**

1. Do not set up the wall mount by yourself. Please contact qualified professionals for installation.
2. The TV should not be mounted on walls or surfaces which have an angle more than 10 degrees with vertical direction. Otherwise the TV set may fall.
3. The walls for mounting must have enough strength to hold the whole weight of TV set. For example, concrete wall and brickwork are eligible. Do not place the mount on soft walls such as earth walls and plasterboard.
4. If spare parts of different specifications (such as screws) are used during mounting, consult with qualified professionals to make sure these parts are safe and effective.
5. Before attaching the base to wall, ensure the holes for anchors are in keeping with the installing rules. Otherwise there may exist some potential problems.
6. Do not place any heating source under your television. Or else, it can cause fire.
7. Do not place the TV near anything dripping. Transducers and high voltage wires should be kept far away from the apparatus too. Or else, it may cause creepage, electric shock or bad resonance.
8. Do not place TV in a location where collision or vibration is liable to happen.
9. In order to avoid unexpected falling of the TV set, do not put any strong force on TV or wall mount after installing.
10. Be sure to unplug the TV before installing. Keep anything hard or sharp away from the screen panel to prevent the scuffing.
11. After installing, if there is any need to move the cabinet, please contact the qualified professionals.

### **UNIVERSAL REMOTE CONTROL CODE LIST**

For Universal Remote Control brands listed below, please use accompanying Proscan codes and refer to your Universal Remote Control User Manual for basic instruction for changing TV code to operate Proscan model.

- Proscan codes for Sony TV = 8003, 8012, 8058
- Proscan codes for Philips TV = 1005, 1006, 1007, 1035, 1064, 1216
- Proscan codes for other universal remotes = 272, 132, 134, 116, 040, 016, 024, 056, 019, 262

## Appendix – TV Specification

### TV SPECIFICATION

Model	19LB30Q		
Diagonal display size	18.5 inches		
Television system	American TV standard ATSC /NTSC system		
Audio multiplex	BTSC system		
Channel coverage	VHF: 2~13    UHF: 14~69    CATV: 1~125 Digital Terrestrial Broadcast (8VSB): 2 ~69 Digital cable (64/256 QAM): 1~135		
PC mode	640×480/60Hz, 800×600/60Hz, 1024×768/60Hz		
YPbPr/YCbCr mode	480i/60Hz, 480p/60Hz, 720p/60Hz, 1080i/60Hz		
HDMI Mode	480i/60Hz, 480p/60Hz, 720p/60Hz, 1080i/60Hz		
Resolution	1366 x 768		
Power source	AC 100 - 240 V, 50 - 60 Hz		
Power consumption	Less than 50W		
Audio power	3W + 3W		
Connection Interface	RF input:       Cable/ Antenna ×1 VIDEO input:   VIDEO ×1 S-VIDEO ×1 COMPONENT ×1 HDMI ×1 GRAPHIC input: Analog RGB 15pin ×1 AUDIO Input:   AV Audio ×1 Component Audio ×1 PC Audio Input ×1 AUDIO output: Headphone output ×1		
TV Dimensions	Height: 15.5 inches	Width: 18.9 inches	Depth: 9.1 inches
Package Dimensions	Height: 17.3 inches	Width: 20.7 inches	Depth: 9.8 inches
NET Weight	9.1 lbs		
Package Weight	13.9 lbs		
Supplied accessories	User Manual, Warranty Card, Remote control, AC Adapter, Batteries, Warranty Register Card		

Design and specifications are subjects to change without notice.

**CUSTOMER NOTICE:** Use carefully when operating to prevent damage to the screen.