

8/2006

5019 611 02001

PL CZ SK HU RU BG RO GB



Whirlpool is a registered trademark of Whirlpool, USA

Instructions for use

INSTRUCTIONS FOR USE

BEFORE USING THE APPLIANCE	PAGE 194
SAFEGUARDING THE ENVIRONMENT	PAGE 194
PRECAUTIONS AND GENERAL RECOMMENDATIONS	PAGE 195
CONTROL PANEL DESCRIPTION.....	PAGE 196
USE OF ICE MAKER AND WATER DISPENSER.....	PAGE 199
WATER FILTER (SELECT MODELS)	PAGE 200
GUIDE TO INTERNAL COMPONENTS	PAGE 201
GUIDE TO STORAGE AND THAWING OF FOOD	PAGE 206
MAINTENANCE AND CLEANING	PAGE 208
TROUBLESHOOTING GUIDE/AFTER-SALES SERVICE	PAGE 209
AFTER-SALES SERVICE	PAGE 210
INSTALLATION.....	PAGE 211
WATER CONNECTION	PAGE 218
ELECTRICAL CONNECTION	PAGE 219

BEFORE USING THE APPLIANCE

- Your new appliance is designed exclusively for domestic use

To get the most out of your new appliance, read the user handbook thoroughly. The handbook contains a description of the appliance and useful tips for storing food.

Keep this handbook for future consultation.

1. After unpacking, make sure that the appliance is undamaged and that the door closes properly. Any damage must be reported to your dealer within 24 hours after delivery of the appliance.
2. Wait at least two hours before switching the appliance on in order to ensure the refrigerant circuit is fully efficient.
3. Installation of the appliance and electrical connections must be carried out by a qualified engineer, in accordance with the manufacturer's instructions and local safety regulations.
4. Clean the inside of the appliance before using it.

SAFEGUARDING THE ENVIRONMENT

1. Packing

The packaging material is entirely recyclable, and marked with the recycling symbol. Follow local regulations for scrapping. Keep the packaging materials (plastic bags, polystyrene parts, etc.) out of reach of children, as they are potentially dangerous.

2. Scrapping

The appliance is manufactured using recyclable material.

This appliance is marked according to the European directive 2002/96/EC on Waste Electrical and Electronic Equipment (WEEE). By ensuring this product is disposed of correctly, you will help prevent potential negative consequences for the environment and human health, which could otherwise be caused by inappropriate waste handling of this product.

The symbol  on the product, or on the documents accompanying the product, indicates that this appliance may not be treated as household waste. Instead it shall be handed over to the applicable collection point for the recycling of electrical and electronic equipment. Before scrapping, make the appliance unusable by cutting off the power cable and removing the doors and shelves so that children cannot easily climb inside the appliance.

Disposal must be carried out in accordance with local environmental regulations for waste disposal. Deliver the appliance immediately to an authorized dump; do not leave it unattended even for a few days, since it is potentially dangerous for children. For more detailed information about treatment, recovery and recycling of this product, please contact your local city office, your household waste disposal service or the shop where you purchased the product.

Information:

This appliance does not contain CFCs (replaced with R134a).

Appliances with Isobutane (R600a): isobutane is a naturally occurring, low environmental impact gas. Caution is required, however, because isobutane is flammable. Therefore, it is essential to ensure that refrigerant pipelines are not damaged.

Declaration of conformity

- This appliance is designed to store food and is manufactured in conformity with European Directive 90/128/EEC, 02/72/EEC and Regulation (EC) No. 1935/2004



- This appliance is designed, manufactured, and retailed in compliance with:
 - the safety objectives of the Low Voltage Directive 73/23/EEC;
 - the protection requirements of the "EMC" Directive 89/336/EEC amended by Directive 93/68/EEC.
- The electrical safety of the appliance can only be guaranteed if the product is connected to an approved earth connection.

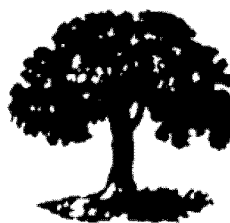

PRECAUTIONS AND GENERAL RECOMMENDATIONS

- Use the refrigerator compartment only for storing fresh food and beverages and use the freezer compartment only for storing frozen food, freezing fresh food and making ice cubes.
- After installation, make sure that the appliance is not standing on the power supply cable.
- Do not store glass containers with liquids in the freezer since they may burst.
- Do not eat ice cubes or ice lollies immediately after taking them out of the freezer since they may cause cold burns.
- Before carrying out any maintenance or cleaning, always unplug the appliance or disconnect the power supply.
- Make sure that your appliance is not near a heat source.
- Do not store or use gasoline or other flammable vapours and liquids in the vicinity of this or any other appliance. The fumes can create a fire hazard or explosion.
- To ensure proper ventilation, leave a gap on both sides and above the appliance.
- Ensure that the vent outlets on the appliance casing or housing unit are unobstructed in order to allow correct air circulation.
- All appliances equipped with an ice maker or water dispenser must be connected to a mains water supply that delivers potable water only (with water pressure between 2.4 and 8.3 bar (35 and 120 PSI)). Ice makers and/or water dispensers not directly connected to a mains water supply must be filled with potable water only.
- Install and level the appliance on a floor strong enough to take its weight and in an area suitable for its size and use.
- Install the appliance in a dry and well-ventilated place. The appliance is set for operation at specific ambient temperature ranges, according to the climatic class indicated on the data plate: The appliance may not work properly if it is left for a long period at a temperature above or below the indicated range.

Climatic class	Amb. T. (°C)	Amb. T. (°F)
SN	From 10 to 32	From 50 to 90
N	From 16 to 32	From 61 to 90
ST	From 18 to 38	From 64 to 100
T	From 18 to 43	From 64 to 110

- Be careful not to damage the floors when you move the appliance (e.g. parquet flooring).
- Do not use mechanical devices or any means other than those recommended by the manufacturer to speed up the defrosting process.
- Do not damage the refrigerant circuit.
- Do not use electrical appliances inside the freezer compartments, unless such appliances are specifically recommended by the manufacturer.
- This appliance is not designed for use by young children or the infirm.
- To avoid the risk of children being trapped and therefore suffocating, do not allow them to play or hide inside the appliance.
- The power cable may only be replaced by an authorized person.
- Do not use extension leads or adapters.
- It must be possible to disconnect the appliance from the mains by unplugging it or by means of a two-pole switch fitted upline of the socket.
- Ensure that the voltage indicated on the appliance data plate corresponds to the domestic supply voltage.
- Do not ingest the contents (non-toxic) of the ice packs (if provided).
- Do not place fingers or hands on the automatic ice making mechanism while the refrigeration is plugged in. This will help protect you from possible injury. It will also prevent interference with moving parts of the ejector mechanism and the heating element that releases the cubes.
- To prevent accidental child entrapment or suffocation risk, do not remove the divider in the top freezer basket.
- Do not turn the ice maker on until it is connected to the water supply.

CONTROL PANEL DESCRIPTION

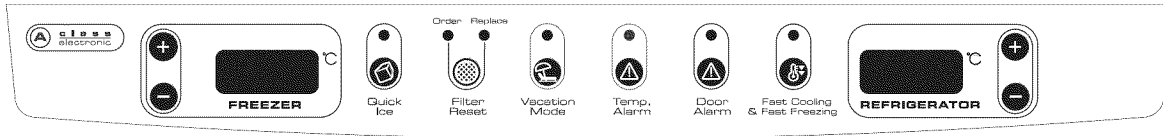

The control Panel is located at the top front of the refrigerator compartment.

Temperature Controls

For your convenience, your temperature controls are preset at the factory. When you first install your refrigerator, make sure the controls are still set to the recommended set points as shown.

Recommended Settings

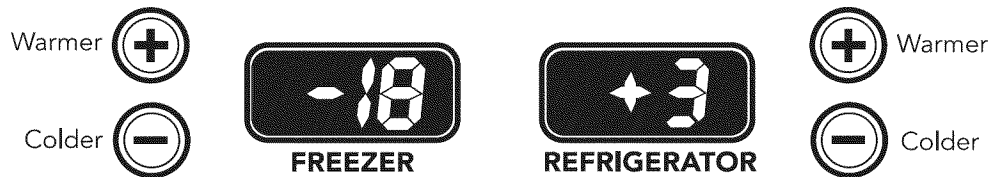

IMPORTANT:

- Wait 24 hours for your refrigerator to cool completely before adding food. If you add food before the refrigerator has cooled completely, your food may spoil.
- If the temperature is too warm or too cold in the refrigerator or freezer, first check the air vents to be sure they are not blocked before adjusting the controls. See “Ensuring Proper Air Circulation”.

To Turn Your appliance Off/On:

- Press the freezer (+) touch pad repeatedly until “OFF” appears in the freezer display. Allow a few seconds for the refrigerator to shut off. Neither compartment will cool.
- Press either the refrigerator or freezer (-) touch pad to turn on the appliance.

Adjusting Controls

The REFRIGERATOR control adjusts the refrigerator compartment temperature. The FREEZER control adjusts the freezer compartment temperature. If you need to adjust the temperature in either the refrigerator or freezer compartment, use the settings listed in the chart as a guide.

To Adjust Set Point Temperatures:

- Press the (+) or (-) touch pads until the desired temperature set point is displayed.

NOTE: Except when first turning on the refrigerator, do not adjust either temperature control more than one setting at a time. Wait 24 hours for the temperature to stabilize between adjustments.

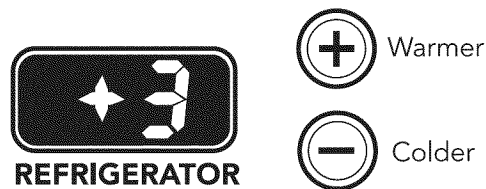

Fast Cooling & Fast Freezing

The Fast Cooling & Fast Freezing feature assists with periods of high refrigerator use, full grocery loads, or temporarily warm room temperatures.

- Press the Fast Cooling & Fast Freezing touch pad to set the freezer and refrigerator to the lowest temperature settings. Press the Fast Cooling & Fast Freezing touch pad again to return to the normal refrigerator set point.

NOTE: The Fast Cooling & Fast Freezing feature will automatically shut off in approximately 12 hours.



Fast Cooling & Fast Freezing

Quick Ice

The Quick Ice Feature assists with temporary periods of heavy ice use by increasing ice production.

- Press the Quick Ice Feature touch pad to set the freezer to the lowest temperature setting. Press the Quick Ice Feature touch pad again to return to the normal freezer set point.

NOTE: The Quick Ice Feature will automatically shut off in approximately 24 hours.

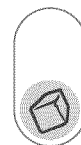

Quick Ice

Vacation Mode

In Vacation Mode, the freezer will not automatically defrost as often to conserve energy.

- Press the Vacation Mode touch pad until the indicator light is lit to turn on this feature. Press the Vacation Mode touch pad again or open the refrigerator door to turn off this feature.

NOTE: The refrigerator door may be opened within 1 hour of setting Vacation Mode without turning off the feature.

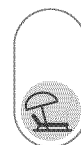

Vacation Mode

Temp Alarm

The Temperature Alarm combines power outage and warm alarm features.

Power Outage

During a power outage, if the temperatures in the refrigerator and freezer compartments exceed normal operating temperatures, the highest temperature reached will be displayed.

- Press the Temp Alarm touch pad until the indicator light is lit, to turn on this feature. Press and hold Temp Alarm for 3 seconds until the indicator light goes off to turn off this feature.

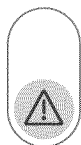

Temp. Alarm

Warm Alarm

An alarm will sound repeatedly if the freezer or refrigerator compartment temperatures exceed normal operating temperatures for an hour or more. The temperature displays will alternately show the current temperatures and the highest temperatures the compartments reached when the power was out. Press the Temp Alarm touch pad once to stop the audible alarm and alternating temperature displays. The Temp Alarm light will continue to flash until the refrigerator temperature stabilizes.

Door Alarm

The Door Alarm feature sounds a chime every few seconds when the refrigerator door has been left open for 5 continuous minutes.

The chime will sound until the door is closed or Door Alarm is turned off.

Press the Door Alarm touch pad to turn this feature on or off. The indicator light will be lit when the Door Alarm feature is on.

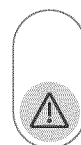

Door Alarm

Water Filter Status Lights and Filter Reset (select models)

The water filter status light will help you know when to change the water filter. When the yellow (Order) light is on, it is almost time to change the water filter. When the red (Replace) light is on, a new water filter should be installed. See “Water Filtration System.”

After replacing the water filter, press and hold FILTER RESET for 3 seconds until the Order or Replace light turns off.

Order Replace

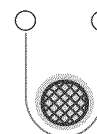

Filter Reset

Water Dispenser

(select models)

If you did not flush the water system when the refrigerator was first installed, dispense water into a container until you draw and discard 8 to 12 L (2 to 3 gal.) or for approximately 6 to 7 minutes after the water begins dispensing. The water you draw and discard rinses the pipes. Allow several hours for the refrigerator to cool down and chill water.

Dispensing Water

1. Hold a container under the dispenser while pressing the button.
2. Release the button to stop dispensing.

NOTE: Dispense enough water every week to maintain a fresh supply.

User Preferences

The control center allows you to set user preferences, if desired.

Temperature Display (C_F)

This preference allows you to change the temperature display.

C - Temperature in degrees Celsius

F - Temperature in degrees Fahrenheit

Alarm (AL)

This preference allows you to turn off the sound of all alarms.

ON - You will hear the alarm sound.

OFF - You will not hear the alarm sound.

Sabbath Mode (SAB)

IMPORTANT: This preference does not disable interior lights.

ON - All control panel lights will be disabled.

OFF - All control panel lights will be enabled.

NOTE: Press any touch pad on the control panel to restore the control panel lights.

To Access the User Preferences Menu:

1. Press and hold the Door Alarm touch pad for 3 seconds. The preference name will appear in the Freezer display and the preference status (C or F) or (ON or OFF) will appear in the Refrigerator display.
2. Use the Freezer (+) or (-) touch pads to scroll through the preference names. When the desired preference name is displayed, press the Refrigerator (+) or (-) touch pads to change the preference status.
3. Set your preferences by pressing and holding the Door Alarm touch pad for 3 seconds, or by shutting the refrigerator compartment door.

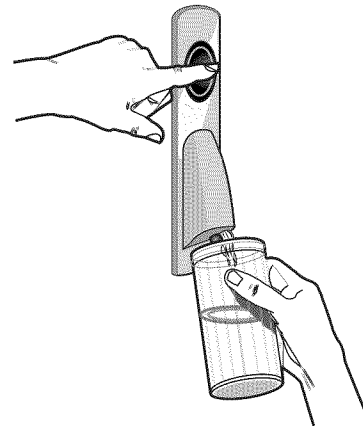

USE OF ICE MAKER AND WATER DISPENSER

Automatic Ice Maker

Connect the ice maker to the water supply as instructed. **Proper water flow and a level refrigerator are essential for optimal ice maker performance.**

Ice Maker Operation

- To turn ice maker On push arm down from locked position.
- Lift arm up and lock into position to turn ice maker Off.

Operating Instructions

- Confirm ice bin is in place and ice maker arm is down.
- After freezer section reaches between -17° to -18° C (2° to 0° F), ice maker fills with water and begins operating. You will have a complete harvest of ice approximately every three hours.
- Allow approximately 24 hours after installation to receive first harvest of ice.
- Discard ice created within first 12 hours of operation to assure system is flushed of impurities.
- Stop ice production by raising ice maker arm until click is heard.
- Ice maker will remain in the off position until arm is pushed down.
- The first one or two batches will probably contain undersized and irregular cubes because of air in the supply line.
- When the ice cubes are ejected it is normal for several cubes to be joined together at the ends. They can easily be broken apart.
The ice maker will continue to make ice until the supply of ice cubes raises the ice maker arm, shutting the ice maker off.
- Certain sounds may accompany the various cycles of the ice maker. The motor may have a slight hum, the cubes will rattle as they fall into an empty storage pan and the water valve may click or “buzz” occasionally.
- If the ice is not used frequently, the ice cubes will become cloudy, shrink, stick together and taste stale. Empty the ice storage bin periodically and wash it in lukewarm water. Be sure to dry the bin thoroughly before replacing it.
- Beverages and foods should not be placed in the ice storage bin for quick chilling. These items can block the ice maker arm, causing the ice maker to malfunction.
- Turn off (arm up) the ice maker when the water supply is to be shut off for several hours.

To Remove the Ice Bin:

- Pull it forward, away from the ice maker. To avoid the ice maker dumping ice while the bin is removed, turn the ice maker off by raising the ice maker arm.

To Install the Ice Bin:

- Reverse the above procedure. Turn the ice maker on by lowering the ice maker arm.

Water Dispenser (select models)

- The Water Dispenser is located on the left side wall of the fresh food section. This design is for cold water dispensing only.

To Dispense Water:

- Hold container under spout and press dispenser pad.

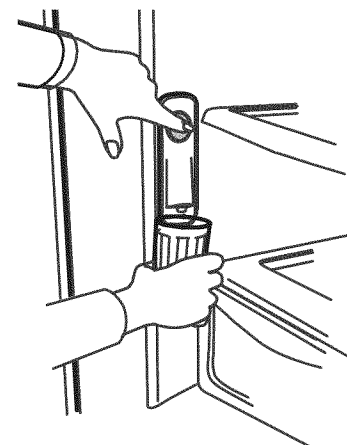
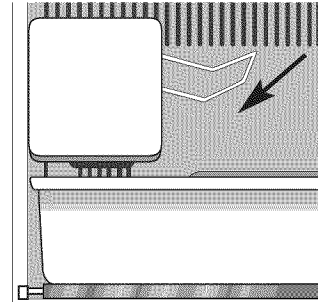

WATER FILTER (SELECT MODELS)

Water Filter Removal and Installation

If your appliance must be connected to the mains water supply to operate the water dispenser and/or ice maker, it must be a water supply which delivers potable water only. Ice makers not connected to a mains water supply must be filled with potable water only.

Initial Installation

The water filter is located in the upper right-hand corner of the fresh food compartment.

1. Remove blue bypass cap and retain for later use.
 2. Remove sealing label from end of filter and insert into filter head.
 3. Rotate gently clockwise until filter stops. Snap filter cover closed.
 4. Reduce water spurts by flushing air from system. Run water continuously for two minutes through dispenser until water runs steady. During initial use, allow about a one- to two-minute delay in water dispersal to allow internal water tank to fill.
- Additional flushing may be required in some households where water is of poor quality.

Replacing Water Filter

IMPORTANT: Air trapped in system may cause water and cartridge to eject. Always dispense water for at least 2 minutes before removing the filter for any reason. Use caution when removing.

1. Turn filter counterclockwise until it releases from filter head.
2. Drain water from filter into sink, and dispose in normal household trash.
3. Wipe up excess water in filter cover and continue with Initial Installation, steps 2 through 4.

IMPORTANT: Condition of water and amount used determines life span of water filter cartridge. If water use is high, or if water is of poor quality, replacement may need to take place more often.

To purchase a replacement water filter cartridge, contact your dealer.

The dispenser feature may be used without a water filter cartridge. If you choose this option, replace filter with blue bypass cap.

NOTES:

1. The bypass cap does not filter water. Be sure to have replacement cartridge available when filter change is required.
2. If water filtration system has been allowed to freeze, replace filter cartridge.
3. If system has not been used for several months, or water has an unpleasant taste or odor, flush system by dispensing water for two to three minutes. If unpleasant taste or odor persists, change filter cartridge.

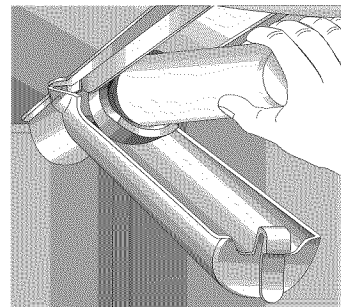
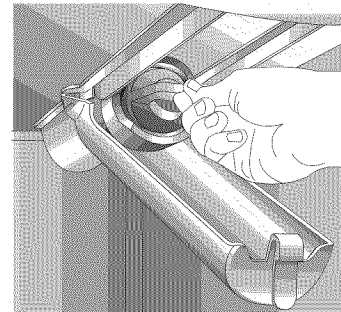

GUIDE TO INTERNAL COMPONENTS

Shelves

- Never attempt to adjust a shelf that is loaded with food (except in the case of the lift shelf).
- Confirm shelf is secure before placing items on shelf.

Your refrigerator has either **spill guard glass shelf** or **non-sealed Shelves**. The spill guard glass shelf shelves have a spill retainer edge which allows for easier clean up and some are equipped with the **Easy Glide** slide out feature. To slide out (select models), grasp the front of the shelf and pull forward. Push in the shelf to return to the original position.

To Remove a Shelf:

- Slightly tilt up the front and lift up the rear of the shelf, then pull the shelf straight out.

To Lock the Shelf Into Another Position:

- Tilt up the front edge of the shelf.
- Insert the hooks into the desired frame openings and let the shelf settle into place.
- Be sure the shelf is securely locked at the rear.

Lift Shelf (select models)

The fresh food compartment is equipped with an **lift shelf**. This shelf can be adjusted up or down without having to be unloaded of its contents. To adjust an lift shelf, pull out the knob on the crank handle. Rotate the crank clockwise to raise the height of the shelf, and counterclockwise to lower the height of the shelf.

Note

- Do not raise the shelf to the very top of the vertical rails, as the shelf may become jammed.

To Remove:

Completely unload the shelf and pull the shelf forward. When the shelf stops, press up on the tabs located underneath its outside edges, then continue pulling forward, clear of the frame.

To Install:

Align the shelf to the frame and push it all the way back. (There is no need to depress the tabs for reinstallation).

In ordinary use, the lift shelf frame assembly **does not** require removal. Though unlikely, and not recommended, the correct removal procedure is as follows:

To Remove:

- Unload the shelf completely.
- Remove glass shelf by pulling forward. When shelf stops lift up and continue pulling forward.
- Manually move the two rear latches toward the shelf center.
- While supporting the entire shelf and frame from underneath, lift slightly and rotate the assembly approximately 30° to allow the rear mechanism to clear the vertical rear side rails.
- The entire assembly can then be moved forward and clear of the refrigerator compartment.

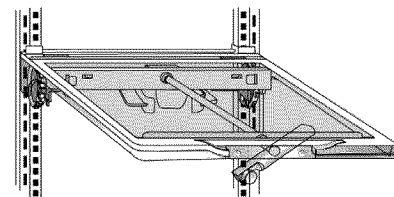
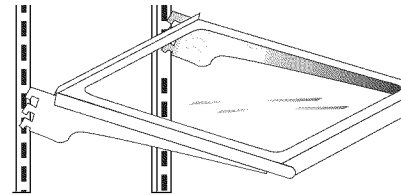

To Install:

- Reverse the removal procedure. Be sure the shelf is in a level position.
- When the sliding shelf is pushed to the rear, it will reposition the rear latches to their correct operating position.

The **Crisper Top** serves as the lower fresh food shelf.

To Remove the Crisper Top:

- Remove crisper drawers as indicated on page 11.
- Place hand under the frame to push up the glass. Lift glass out.
- Lift frame from refrigerator liner rails.

To Install:

- Repeat above instructions in reverse order.

Door Storage

Dairy Compartment

The **Dairy Compartment** provides convenient door storage for spreadable items such as butter and margarine. This compartment can be moved to different locations to accommodate storage needs. To use the dairy compartment, raise the cover.

To Remove:

- Raise the cover, pull upward and tilt out.

To Install:

- Reverse above procedure.

Door Buckets

Door Buckets can be moved to meet storage needs.

To Remove:

- Slide bucket up and pull straight out.

To Install:

- Slide bucket in and down until firmly seated in the door liner.

Full-width Door Shelf

Full-width Door Shelf removes for easy cleaning.

To Remove:

- Slide shelf up and pull straight out.

To Install:

- Reverse above procedure

Storage Drawers

Snack Drawer (select models)

The **Snack Drawer** can be used for storage of miscellaneous items or extra produce.

To Remove:

- Pull drawer out to full extension. Tilt up front of drawer and pull straight out.

To Install:

- Insert drawer into frame rails and push back into place.

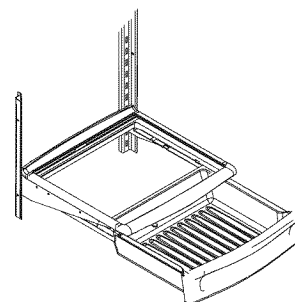
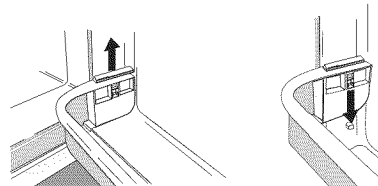
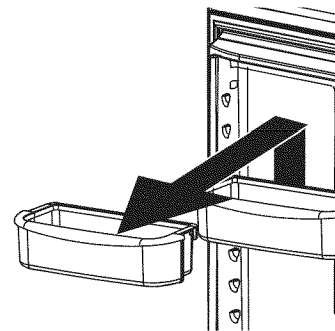
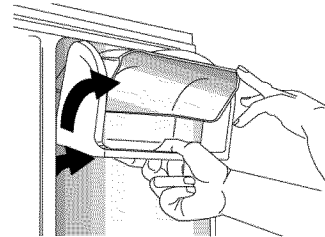

Party chiller (select models)

The **party chiller** keeps beverages and other items cooler than the rest of the fresh food section. A cold air inlet allows air from the freezer section to pass into the beverage chiller.

The party chiller control is located on the left wall of the fresh food compartment. The control adjusts the amount of cold air allowed in to the beverage chiller. For a cooler temperature in the party chiller slide the control down.

To Remove:

- First remove the pick off shelf to the left of the party chiller.
- Firmly hold each side of beverage chiller, lift up and away from door liner.

To Install:

- Reverse above procedure.

Crisper Drawers

The **Crisper Drawers** provide a higher humidity environment for fresh fruit and vegetable storage.

Controls

The **Crisper Controls** regulate the amount of humidity in the crisper drawer. Slide the control toward the **FRUIT** setting for produce with outer skins. Slide the control toward the **VEGETABLES** setting for leafy produce.

VEGETABLES FRUIT
HUMIDITY CONTROLLED

To Remove:

- Pull drawer out to full extension. Tilt up front of drawer and pull straight out.

To Install:

- Insert drawer into frame rails and push back into place.



Note

For best results, keep the crisper drawers tightly closed.

Temperature-Controlled Drawer

The **Temperature controlled** drawer is a full-width drawer with adjustable temperature control. This drawer can be used for large party trays, deli items, beverages or miscellaneous items and features a divider to organize the drawer into sections if desired.

There is a temperature control which adjusts the amount of cold air allowed into the drawer. The control is located on the right side of the drawer, under the lid.

Set the control to the **higher setting**  to provide a normal refrigerator temperature. Set the drawer on the **lower setting**  when a temperature colder than the main refrigerator compartment is desired. Use the coldest setting when storing meats.

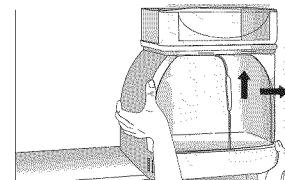
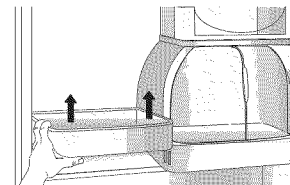
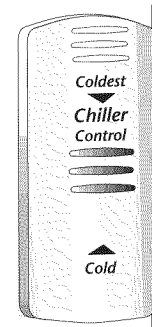
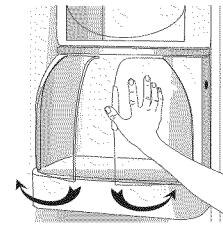

Notes

- Cold air directed to the drawer can decrease refrigerator temperature. Refrigerator control may need to be adjusted.
- Do not place leafy vegetables in the drawer. Colder temperatures could damage leafy produce.

To Remove Drawer:

- Lift lid. Pull drawer out to full extension. Tilt up front of drawer and pull straight out.

To Install Drawer:

- Push metal glide rails to the back of the refrigerator. Place drawer onto rails and slide drawer back until it falls into place.

To Remove Divider:

- Pull drawer completely out and raise the front of the divider to unhook it from the rear wall of the drawer and lift it out.

To Install Divider:

- Hook back of divider over rear wall of drawer and lower into place Upper Wire Basket.

Accessories (select models)

Wine Trivet/Can Rack

The **Wine Trivet/Can Rack** accessory fits in the deli drawer or on a shelf.

Bottles or cans can be laid crosswise, or a single bottle may be laid in the center depression.

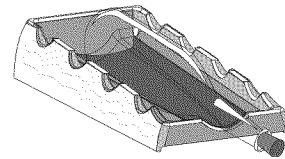

Egg Cradle

The **Egg Cradle** (style may vary/select models) holds a “dozen-plus” eggs. It can be removed to carry to work area or to be washed.

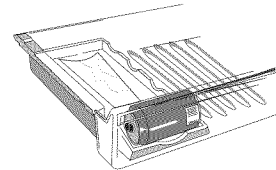

Shelves and Baskets

Models with swing freezer door:

Freezer Shelf (select models)

Select models have a shelf divider.

To Remove:

- Pull shelf out to full extension. Tilt up front of shelf and pull straight out.

To Install:

- Insert shelf into freezer liner rails and push to back of compartment.

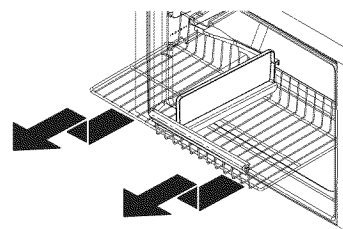
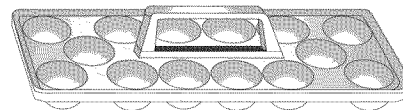

Wire Basket (select models)

To Remove:

- Pull basket out to full extension. Tilt up front of basket and pull straight out.

To Install:

- Insert basket into freezer liner rails and push back into place.

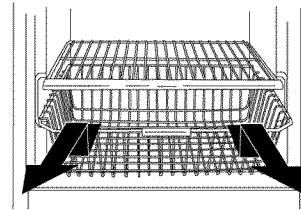

Freezer Door Shelf (select models)

The **Freezer Door Shelf** provides convenient storage for frozen food items in freezer door.

To Remove:

- Lift shelf from side liner tabs and pull out.

To Install:

- Fit ends of shelf on liner tabs and slide down.

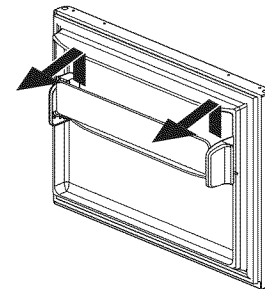

Models with pullout freezer drawer:

Upper Wire Basket

To Remove:

- Pull upper basket out to full extension and lift out to remove.

To Install:

- Slide upper basket into freezer. Make sure that rear of basket hooks behind rail catch.

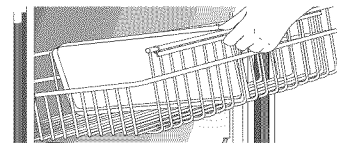

Accessories (select models)

Ice Cube Tray

The **Ice Cube Tray** provides an area to freeze cubes for manual dispensing of ice.

To release ice cubes from tray, hold tray upside down over a storage container and twist both ends of tray until cubes release.

The **Ice Service Rack** (select models) holds the ice cube tray.

To Install:

- Slide L-shaped groove of shelf down over back wall screw. Push rack back until screw is stopped in L-shaped groove (1). Slide front portion of shelf over front wall screw (2).

To Remove:

- Perform above steps in reverse order.

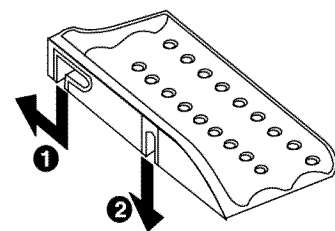
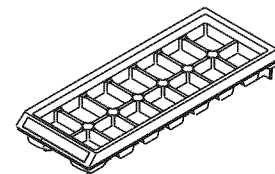

GUIDE TO STORAGE AND THAWING OF FOOD

The freezer compartment, marked with the symbol , is used for storing frozen food and freezing fresh or cooked food.

The maximum quantity of food which can be frozen in a 24 hour period, at an ambient temperature of 25°C, is stated on the rating plate, inside the refrigerator compartment.

For more efficient freezing, activate fast cooling & fast freezing function.

PREPARING FRESH FOOD FOR FREEZING

It is important to wrap food so that no water, moisture, or vapour may penetrate; this avoids the transfer of odours and flavours throughout the refrigerator and allows better storage of frozen food. Use plastic containers with tight fitting lids, aluminium trays, aluminium foil, cling film and waterproof plastic wrappings.

SEALING

When sealing the food in bags, squeeze out the air (liquids need head space to allow for expansion). Seal the top of the bag with a fastener. Place labels on the inside of clear freezer bags; use self-adhesive labels on the outside of opaque ones.

DEFROSTING

Here are some helpful tips.

Raw vegetables: do not thaw, put straight into boiling water and cook as usual.

Meat (large cuts): thaw in the refrigerator compartment without unwrapping. Before cooking, leave at room temperature for a couple of hours.

Meat (small cuts): thaw at room temperature or cook from frozen.

Fish: thaw in the refrigerator compartment without unwrapping or cook before fully thawed.

In the event of a power failure, the freezer compartment maintains the appropriate storage temperature for approximately 12 hours; during this time, we suggest you leave the door of the compartment closed. Do not refreeze partially thawed food.

Previously cooked food: reheat in the oven without removing it from its aluminium container.

Fruit: thaw in the refrigerator compartment

NOTE: never place warm food in the freezer.

Allow hot foods to cool to room temperature for 30 minutes, then wrap and freeze. Cooling hot foods before freezing saves energy and prolongs the life of the appliance.

FOOD STORAGE CHART

Storage time will vary according to the quality of the food, the type of packaging or wrap used (moisture and vapour proof), and the storage temperature (which should be -18°C).

FOODSTUFF AND STORAGE TIME

Fruit	
Concentrated fruit juice	12 months
Fruit (in general)	8 to 12 months
Citrus fruit and fresh fruit juice	4 to 6 months
Vegetables	
Commercially frozen	8 months
Home frozen	8 to 12 months
Meat	
Sausages	4 weeks or less
Hamburgers	1 month
Beef, veal, lamb	2 to 3 months
Roasts	
Beef	6 to 12 months
Lamb and veal	6 to 12 months
Pork	4 to 8 months
Fresh sausages	1 to 2 months
Steaks and chops	
Beef	8 to 12 months
Lamb, veal, pork	2 to 4 months
Fish	
Cod, flounder, sole	6 months
Salmon	2 to 3 months
Mackerel, perch	2 to 3 months
Dressed fish (purchased)	3 months
Clams, oysters	3 to 4 months
Boiled fish, crabs	3 to 4 months
Raw prawns	12 months
Poultry	
Chicken or turkey (whole or parts)	12 months
Duck and goose	6 months
Offal	2 to 3 months
Poultry cooked in a sauce	6 months
Sliced meat (no sauce)	1 month
Stews	
Meat, poultry, and fish	2 to 3 months

DAIRY PRODUCTS

Butter	6 to 9 months
Margarine	12 months
Cheese	
Camembert, mozzarella, spreading cheese	3 months
Cream cheeses	do not freeze
Brie, Emmenthal, Swiss cheese, etc. (freezing may affect cheese texture)	6 to 8 months

Ice cream, fruit juices, milk	12 months
-------------------------------	-----------

Eggs (Add sugar or salt to yolks or whole beaten eggs)	
Whole (beaten), whites, yolks	12 months

PASTRY AND BREAD

Leavened bread and rolls	3 months
Unbaked bread	1 month
Croissants	3 months
Cakes (not iced)	2 to 4 months
Cakes (iced) and biscuits	6 to 12 months
Fruit pies	12 months
Biscuit pastry	3 months
Pie pastry	4 to 6 months

MAINTENANCE AND CLEANING

Before any cleaning or maintenance operation, unplug the appliance from the mains or disconnect the electrical power supply.

Periodically clean the refrigerator and freezer compartments with a cloth and a solution of lukewarm water and neutral detergent specifically for refrigerator interiors.

Never use detergents or abrasives. Never clean refrigerator parts with flammable fluids. The fumes can create a fire hazard or explosion.

Clean the outside of the appliance and the door seal with a damp cloth and dry with a soft cloth.

Important: the buttons and control panel display must not be cleaned with alcohol or alcohol-derived substances, but with a dry cloth.

NOTE: The refrigeration system pipes are located near the defrost pan and can become hot. Periodically clean them with a vacuum cleaner.

Always disconnect the refrigerator from the power supply before replacing any light bulbs.

Replacing Light Bulbs

Fresh Food Section (style of light shield varies)

1. Slide clear light shield toward back of compartment to release from light assembly.
2. Remove light bulbs.
3. Replace with appliance bulbs **no greater than 40 watts**.
4. Replace light shield by aligning edge of shield with control housing. Slide shield toward front of refrigerator until it locks into place on 'T' shape locking tab. Do not force shield beyond locking point. Doing so may damage light shield.

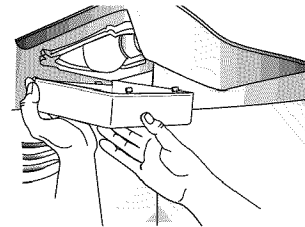

Freezer (style of light shield varies)

1. Reach behind the light cover.
2. With firm pressure, press forward on the notches at the back of the cover and pull down. The cover will open from the back.
3. Remove the cover.
4. Remove light bulb.
5. Replace bulb with appliance bulb **no greater than 40 watts**.
6. Insert front tabs of light cover into slots in freezer liner and snap rear portion over light assembly until rear tab engages.

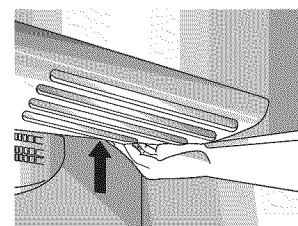
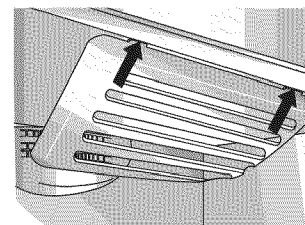
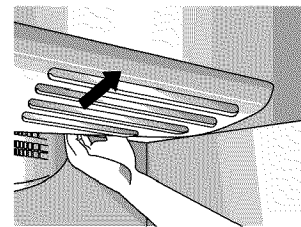

TROUBLESHOOTING GUIDE/AFTER-SALES SERVICE

When you hear these noises

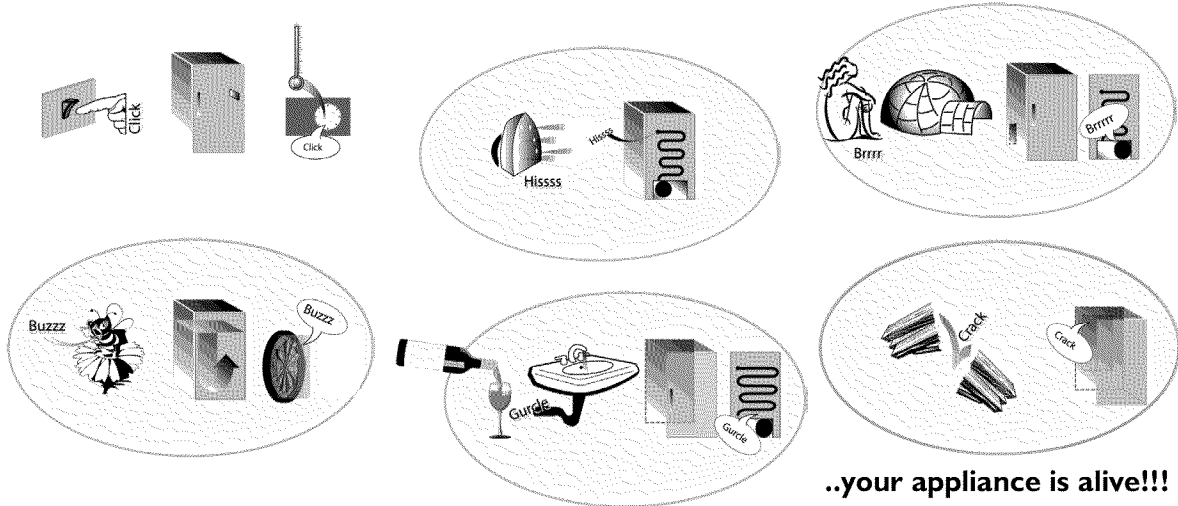

..your appliance is alive!!!

Before contacting After-sales Service....

Performance problems often result from simple things you can find and solve yourself without tools of any kind.

The appliance is not working

- Is the power plug plugged into a live socket with the proper voltage?
- Have you checked your home's fuses?

Ice maker noises

Since your appliance has an ice maker, you may hear buzzing (from the water valve), trickling water and the clatter of the ice falling into the bucket.

If your ice maker does not work:

- Has the freezer had enough time to become cold? With a new refrigerator this may take overnight.
- Is the ice maker ON/OFF?
- Is the water turned on? Is water getting to the ice maker?
- Is there a water filter installed on the refrigerator? This filter may be clogged or installed incorrectly. First, check the filter installation instructions to ensure that the filter was installed correctly and is not clogged. If installation or clogging is not a problem, call a qualified technician.

If the edges of the refrigerator cabinet, which come in contact with the door seal, are warm to the touch:

- This is normal in hot weather and when the compressor is running.

If the light does not work:

- Have you checked your home's fuses?
- Is the power plug plugged into a live socket with the proper voltage?
- Has the light bulb burnt out?

In the case of burnt-out bulbs:

1. Always unplug the appliance from the mains.
2. See chapter "Maintenance and Cleaning".

If the motor seems to run too much:

- Are the doors properly closed?
- Are the door seals properly fitted?
- On hot days or if the room is warm, the motor naturally runs longer.

If the appliance door has been left open for a while or if large amounts of food have been stored, the motor will run longer in order to cool down the interior of the appliance.

Remember

Motor running time depends on different things: number of door openings, amount of food stored, temperature of the room, setting of the temperature controls.

If, after performing the above checks, your appliance still does not work properly, contact the After-sales Service, explain the problem, specifying the model and appliance service number (stated on the data plate).

If the refrigerator temperature is too high

- Are the refrigerator controls correctly set?
- Has a large amount of food been added to the refrigerator or freezer?
- Check that the doors are not opened too often.
- Check that the doors close properly.
- Make sure that air flow vents inside the compartment are not blocked, as this prevents the circulation of cold air.

If there is moisture build-up

- Make sure that air flow vents inside the compartment are not blocked, as this prevents the circulation of air.
- Make sure that the food is properly packaged. Dry any dampness on food containers before placing them in the refrigerator.
- Check that the doors are not opened too often. When the door is opened, humidity from the room air enters the refrigerator. The more often the door is opened, the faster humidity builds up, especially when the room itself is very humid.
- If the room is very humid, it is normal for moisture to build up inside the refrigerator.

If the doors do not open and close properly

- Check that food packages are not blocking the door.
- Check that the pans, shelves, drawers or the ice maker are not out of position.
- Check that the door seals are not dirty or sticky.
- Ensure the appliance is level.

AFTER-SALES SERVICE

Before contacting After-Sales Service:

1. See if you can solve the problem yourself with the help of the “Troubleshooting guide/After-sales service”).
2. Switch the appliance on again to see if the problem has been solved. If it has not, disconnect the appliance from the power supply and wait for about an hour before switching on again.
3. If the problem persists after this course of action, contact After-sales Service.

Specify:

- the nature of the problem,
- the model,
- the Service number (the number after the word SERVICE on the rating plate on the inside of the appliance),
- your full address,
- your telephone number and area code.

SERVICE 0000 000 00000



Note:

The direction of door opening can be changed. If this operation is performed by After-sales Service it is not covered by the warranty.

INSTALLATION

Your new appliance is a FULL NO FROST model exclusively for domestic use, i.e. both refrigerator and freezer compartments are provided with an automatic defrosting function.

This manual contains indications and warnings for correct and safe installation of the appliance - read it carefully before starting installation operations.

Keep this manual for future consultation. If you sell the appliance give it to the new buyer.

Because of the weight of the appliance, at least 2 persons are required to safely move/install it.

Installation of the appliance must be carried out by a qualified engineer.

Your refrigerator was packed carefully for shipment.

Remove and discard shelf packaging and tape. Do not remove the serial plate.

Measuring the Opening

When installing your refrigerator, measure carefully.

One-half inch (1.5 cm) of air space should be provided for the top and back of the refrigerator.

Note: 60 cm deep models

Trim corners of countertop to a 45° angle if countertop has 25 mm overhang. Provide 5 mm clearance on both sides of refrigerator, and allow 7 mm on top for ease of installation and leveling. No minimum clearance is required at the rear of the cabinet.

Subflooring or floor coverings (i.e. carpet, tile, wood floors, rugs) may make your opening smaller than anticipated.

Some clearance may be gained by using the leveling procedure under Leveling.

IMPORTANT: If refrigerator is to be installed into a recess where the top of the refrigerator is completely covered, use dimensions from floor to top of hinge cap to verify proper clearance.

Transporting Your Refrigerator

- **NEVER** transport refrigerator on its side. If an upright position is not possible, lay refrigerator on its back. Allow refrigerator to sit upright for approximately 2 hours before plugging it in to assure oil returns to the compressor. Plugging the refrigerator in immediately may cause damage to internal parts.
- Use an appliance dolly when moving refrigerator.
ALWAYS truck refrigerator from its side or back **NEVER** from its front.
- Protect outside finish of refrigerator during transport by wrapping cabinet in blankets or inserting padding between the refrigerator and dolly.
- Secure refrigerator to dolly firmly with straps or bungee cords. Thread straps through handles when possible. Do not overtighten. Overtightening restraints may dent or damage outside finish.

DOOR AND DRAWER REMOVAL

Some installations require door/drawer removal to transport the refrigerator to its final location.

Disconnect power to refrigerator before removing doors or drawer. Connect power only after replacing doors or drawer.

Door removal

To Remove:

1. Unplug power cord from power source.
2. Remove toe grille and bottom hinge cover (see page 214).
3. Remove top hinge cover from refrigerator door by removing Phillips screw and retain screw and cover for later use.
4. Unscrew 5/16" hex head screws from top hinge to remove hinge and retain all screws for later use.
5. Lift right side refrigerator door from center hinge pin. Remove door closure from center hinge pin on the right side and retain for later use.
6. Disconnect wire harness on top of left side refrigerator door top hinge.
Release two-pin connector by pressing junction point with a flat blade screwdriver or fingernail.
Green ground wire remains attached to the hinge.
7. Unscrew 5/16" hex head screws from top hinge to remove hinge and retain for later use.
Lift left side refrigerator door, along with top hinge, from center hinge pin.
Remove center hinge pin with a 5/16" hex head driver and retain hinge pin for later use.
8. Remove Phillips screws to remove right and left hinges and retain all screws for later use.
9. Remove both stabilizing brackets with 3/8" hex head driver and retain screws for later use.

Door Reinstallation

1. Install hinge assemblies:
 - Install top hinge loosely with 5/16" hex headscrews.
 - Install center hinge with Phillips screws.
2. Place hinge side of refrigerator door on center hinge pin.
3. While holding refrigerator door upright, tighten down top hinge with 5/16" hex head driver.
4. Reconnect two-pin connector.
5. Replace top hinge covers.

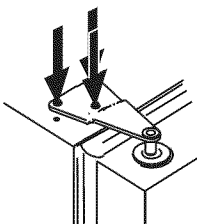
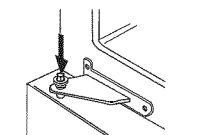
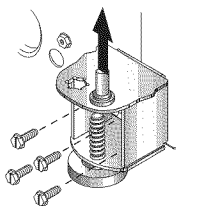
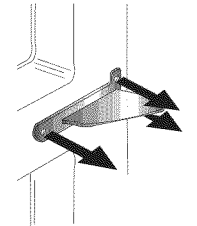
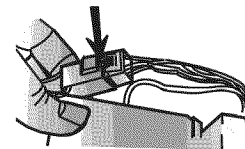
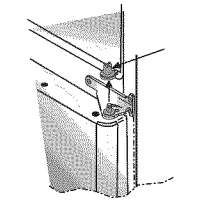
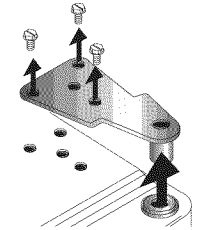
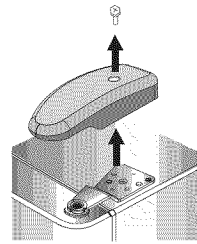

Drawer Removal

To avoid possible injury, product, or property damage, you will need two people to perform the following instructions.

To Remove:

1. Pull drawer open to full extension.
2. Pull upper basket out to full extension and lift out to remove.
3. Lift lower basket straight up and out to remove.
4. On each side rail is a basket cradle with two snap attachments. To release each cradle, unlatch the snaps by pushing them inward, away from the side rail system. Lift the cradles off of the rails.
5. Lift top of drawer front to unhook supports from rail system. Lift door front out to remove.

To Install:

1. Pull both rails out to full extension.
2. While supporting door front, hook supports into tabs located on inside of rail.
3. Lower door front into final position.
4. Place the basket cradles back onto the side rails. Align snaps with the slots on the side rails and press each snap towards the rail until it clicks.
5. With rails pulled out to full extension, set the basket straight down into the basket cradles.
6. Slide upper basket into freezer. Make sure that rear of basket hooks behind rail catch.

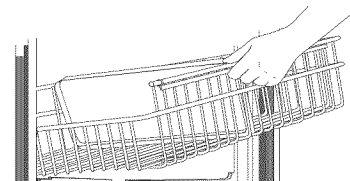
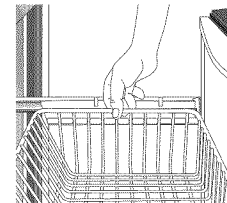
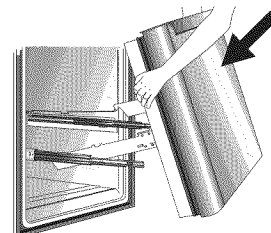
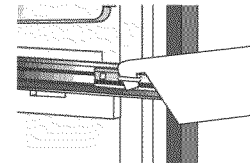
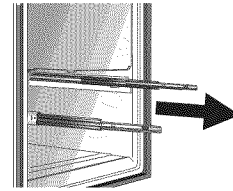
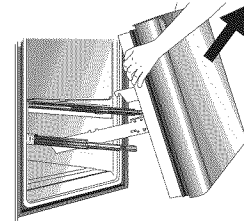
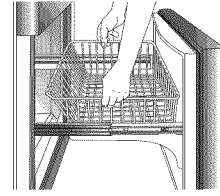

Leveling

- Do not use power tools when performing leveling procedure.
- To enhance the appearance and maintain performance, the refrigerator should be level. (side to side)

Note

Complete any required door reversal, panel installation and/or a water supply connection, before leveling.

Materials Needed

- 3/8" hex head driver
- Carpenter's level

1. Remove toe grille.
 - Grasp firmly and pull outward to unclip.
2. Remove bottom bracket cover(s).
 - Place the eraser end of a pencil or similar blunt tool in the cover notch.
 - Use slight pressure to pry the cover loose.
 - Continue to maintain downward pressure to the notched side of the cover while swinging it off.
3. Using hex head driver, turn the front adjustment screws (A) on each side to raise or lower the front of the refrigerator.

Note

- Some models only have adjustment screws "A".
4. Select models also have rear adjustment screws (B). Using the hex head driver, turn each of these adjustment screws (B) to raise or lower the rear of the refrigerator.
 5. Using the carpenter's level, make sure front of refrigerator is 6 mm or half bubble higher than back of refrigerator and that the refrigerator is level from side to side.
 6. Turn stabilizing legs (C) clockwise until firmly against floor.
 7. **Freezer drawer models only:** Turn adjustment screws (A) counterclockwise to allow the full weight of the refrigerator to rest on the stabilizing legs.

8. Replace bracket cover(s).
 - Position cover into the outer edge of the hinge.
 - Swing the cover toward the cabinet and snap it into place.
9. Replace the toe grille.

Note

- For proper reinstallation, ensure the "top" marking on the interior of the toe grille is oriented correctly.
- Align the toe grille mounting clips with the lower cabinet slots.
- **Snap bottom portion into place first.** Press down on top of grille until top portion snaps into place.

For pullout drawer only:

1. Turn both stabilizing legs clockwise until firmly against floor. Turn roller adjustment screws 2 to 3 times counterclockwise so that the full weight of refrigerator rests on stabilizing legs.
2. Replace toe grille and bracket cover(s). See markings on inside of toe grille to insure proper placement.

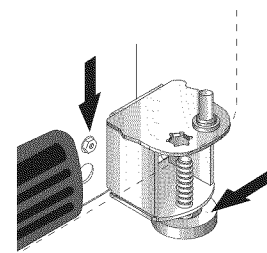
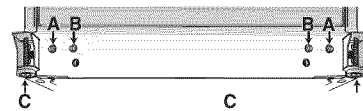
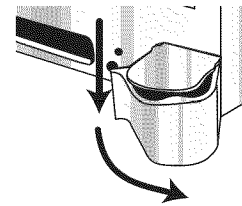
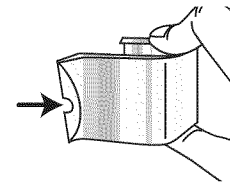
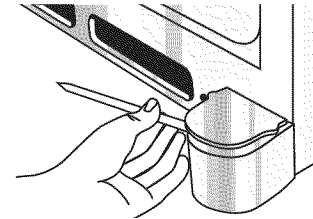
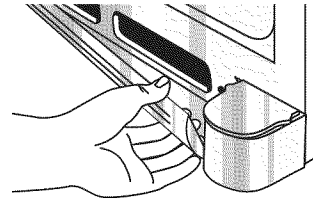

Handles

If not installed, the handle is located in the interior of the fresh food section or attached to the back of your refrigerator.

Remove and discard handle packaging and tape.

Handle design varies from refrigerator to refrigerator.

Please reference the appropriate instructions for your model below.

Fresh Food Handles

Front Mount Handle - Style 1

Materials Needed

- Phillips screwdriver
- 5/16" hex head driver

To Install:

1. Remove 0.6 cm hex head screws from door face with hex head driver, and Phillips screw from top of door.
 - If reversing door, remove door plugs from opposite side of door and insert in screw holes.
2. Align handle holes with screw holes on door face and secure with two door face screws from step 1.
3. Locate handle trim in literature pack and install over top and bottom of handle, as illustrated.
 - Secure top handle trim with remaining screw removed in step 1.
 - Snap bottom trim over bottom portion of handle.

To Remove:

1. Remove top handle trim by removing top handle screw.
 - Retain trim and screw for later replacement.
2. Pry bottom handle trim from handle with screwdriver flat blade wrapped in masking tape.
 - Retain trim for later replacement.
3. Remove two hex head screws.
 - Retain screws for later replacement.

Side Mount Handle

Materials Needed

- Phillips screwdriver

To Install:

1. Remove screws from the side of the door.
2. Align the side mount handle with the predrilled holes in the door panel.
3. Insert the screws in the sequence as shown.
4. Ensure the door handle is snug to the door panel.

To Remove:

Reverse installation procedure.

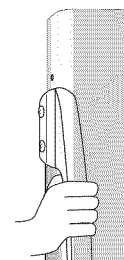
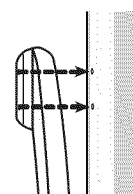
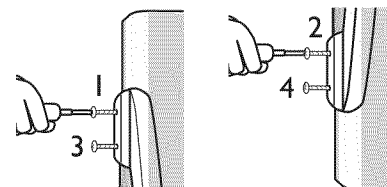
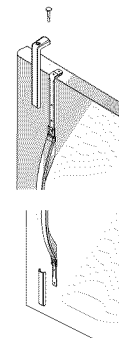
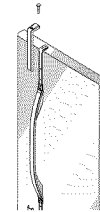
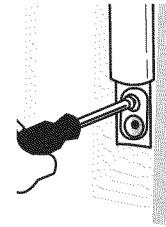
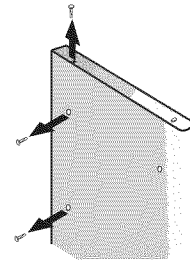

Freezer Handles

Partial-Width Handle

Materials Needed

- Phillips screwdriver

To Install:

1. Install handle by fastening with screws removed from edge of door.
- If reversing freezer door, remove door plugs from top edge of door and insert into screw holes.

To Remove:

Remove handle screws with Phillips screwdriver and retain screws for later use.

Front Mount Handle - style 2

Materials Needed

- Gloves to protect hands
- Phillips screwdriver
- Plastic door removal card (or 0.1 cm thick plastic card), retain the card

Attach Extensions to Handle: (select models)

1. Align handle and extension as shown.
2. Place extension in handle opening.
3. Apply slight pressure to both sides of the extension piece.
4. Slide extension until it stops on inside edge of handle.

To Install:

1. The handles are to be oriented as shown.
2. Align front mount door handle clip with the door tabs.
3. Ensure the handle clips are positioned slightly above the door tabs.
4. Rotate the handle so that the handle is flat against the door.
5. Push the handle down against the upper door tab just enough to allow it to hang unsupported.
6. Align bottom of handle with lower door tab. Press upper handle end to door surface and firmly grasp lower end of handle. Gently slide handle upward until bottom of handle settles on door surface, then reverse direction, sliding downward to almost engaging tab with clip.
7. Grasp the handle firmly and slide down until it clicks. The audible click indicates fastening clips are securely interlocked.

To Remove:

1. Flex the handle away from the door panel. Simultaneously place door handle removal card underneath the base of the lower handle. Insert the card to the line or until it stops.
2. Grasp the lower part of the handle firmly and lift to remove.

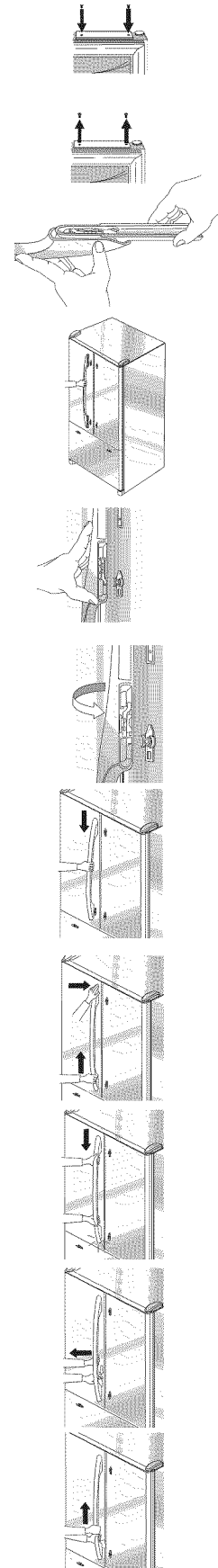

Front Mount Freezer Handle

Materials Needed

- Gloves to protect hands.
- Phillips screwdriver.
- Plastic handle removal card (or 0.1 cm thick plastic card). Retain the card.

Notes

- There is a slight curve to this style of freezer handle.

For proper installation, be sure handle is oriented as shown.

To Install:

1. Align door handle clips slightly to the left of the tabs attached to the freezer door.
2. Rotate the handle so the left base is flat against the door.
3. Push the left handle base against the left door tab and slightly to the right, just enough to allow it to hang unsupported.
4. While firmly supporting the left handle base against the door, align the right base of the handle with the right tabs that are attached to the door.
5. Now, while firmly holding the handle at the left and right bases, gently slide the handle towards the right until the right base settles in. The handle should now be flat against the face of the freezer door at both the left and right bases.
6. With hands still firmly keeping the handle flat against the freezer door, you may have to reverse directions momentarily to assure clip/tab engagement. Then firmly slide the handle to the right until it clicks. The audible “click” indicates that the fastening clips are securely interlocked.

To Remove:

1. At the right end, flex the handle base away from the surface of the freezer drawer. Simultaneously slide the door handle removal card that came with your refrigerator under the right side base of the handle. Slide the card to the line indication or until it stops.
2. With both hands, firmly grasp the handle towards the right base.
3. Slide towards the left, lift and remove from the surface.

Handle Removal

Euro Handles

This handle style is installed at the factory

Materials Needed:

- 3/32” allen wrench

To Remove:

- Remove set screw from handle mounting post using 3/32” allen wrench.
- Repeat the procedure on all posts to remove the handle.

To Replace:

- Align handle with the mounting posts.
- Fully tighten all set screws to secure handle in place.

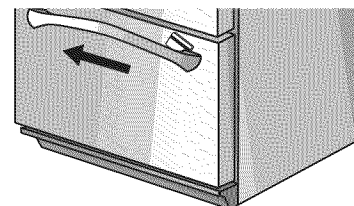
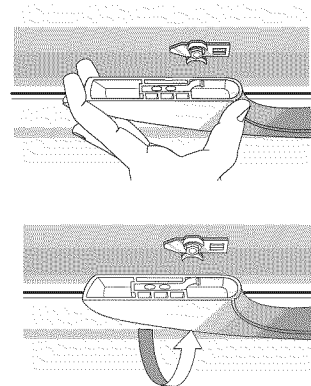
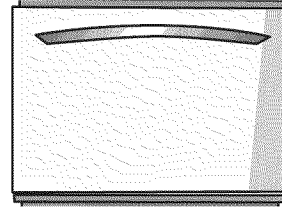

Opening and Closing Your Fresh Food Doors (select models)

Your new refrigerator is uniquely designed with two fresh food doors. Either door can be opened or closed independently of one another.

There is a vertically-hinged section on the left fresh food door. When the left door is closed, the hinged section automatically forms a seal between the two doors when both doors are closed.

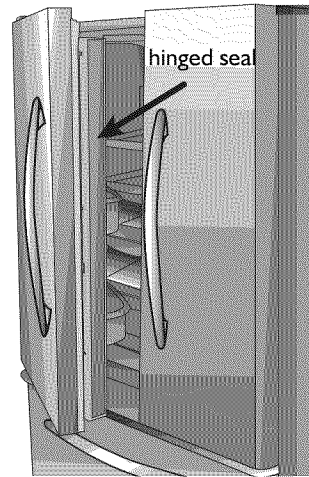

WATER CONNECTION

Disconnect the appliance from the mains power supply before starting operations.

- The ice maker and water circuit must be connected to a water supply of potable and/or chemically purified water.
- The water connection must be carried out in compliance with local regulations.
- The appliance is supplied with a water tube and with a transition connector for connecting to the water tube and supply. (some models)
- Remove the protective cap from the end of the gray water tubing.
- Connect the water tube (1) to the transition connector (2). Finger tightening and then 1 to 2 additional turns should be adequate (for some models connector is placed directly on water tube).
- Connect the transition connector (2) to the household water supply (3).
- (4) Remove Plastic cap from water valve inlet port.
- (5) Place end of Plastic tubing into water valve inlet port.
- (6) Slide brass nut over sleeve and screw nut into inlet port. Tighten nut with wrench. Do not overtighten. Connect tubing to frame with water tubing clamp (C).
- Make sure that the water tube is not twisted.
- The appliance is pre-set for operation at pressures between 2.4 and 8.3 bar (35 and 120 PSI).
- Open the water tap. Check for and eliminate any leaks.
- The appliance does not require any adjustment or water drain.

