



Electric Range

Slide-in models

Use & Care Guide

Estufa eléctrica

Modelos deslizables

Manual de uso y cuidado

Models, Modelos

790.4676*, 790.4678*

* = Color number, número de color

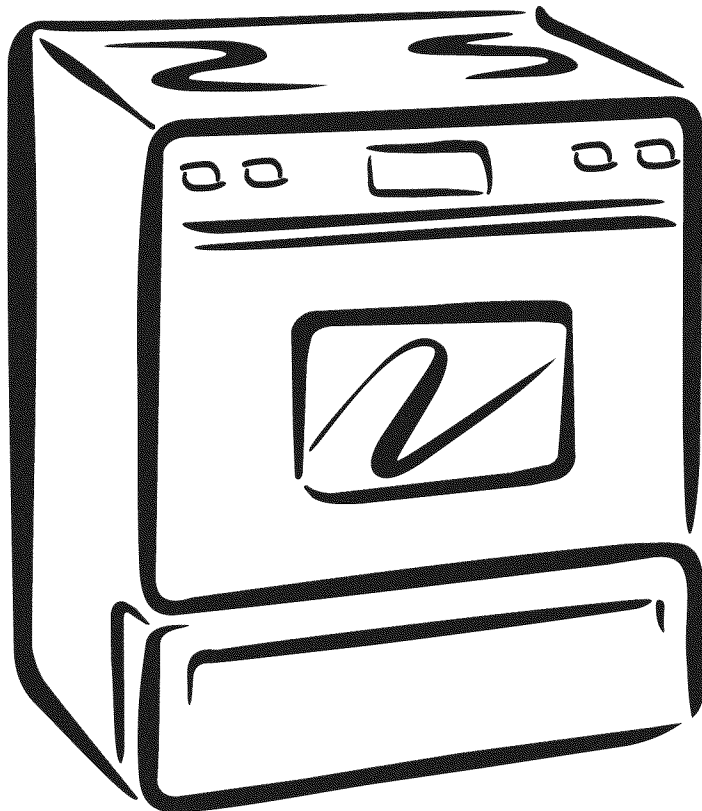

ENGLISH

ESPAÑOL

Table of Contents

Slide-in Range Warranty	2	Control Pad Functions	11
Product Record.....	2	Setting Oven Controls.....	12-17
IMPORTANT SAFETY INSTRUCTIONS	3-5	Adjusting the Oven Temperature	17
Range Features.....	6	Self Cleaning.....	18-19
Setting Surface Controls	7-9	General Care & Cleaning	20-24
Selecting Surface Cooking Cookware.....	9	Before you call.....	25-26
Before Setting the Oven Controls.....	10	Protection Agreements	27
Arranging Oven Racks.....	10	Sears Service.....	28
Air Circulation in the Oven	10		

Kenmore Limited Warranty

When installed, operated and maintained according to all instructions supplied with the product, if this appliance fails due to a defect in material and workmanship within one year from the date of purchase, call 1-800-4-MY-HOME® to arrange for free repair.

This warranty applies for only 90 days from the date of purchase if this appliance is ever used for other than private family purposes.

This warranty covers only defects in material and workmanship. Sears will NOT pay for:

1. Cracks in a ceramic glass cooktop that are not a result of thermal shock.
2. Stains and scratches on a ceramic glass cooktop resulting from accident or improper operation or maintenance.
3. Expendable items that can wear out from normal use, including but not limited to filters, belts, light bulbs, and bags.
4. A service technician to instruct the user in correct product installation, operation or maintenance.
5. A service technician to clean or maintain this product.
6. Damage to or failure of this product if it is not installed, operated or maintained according to the all instructions supplied with the product.
7. Damage to or failure of this product resulting from accident, abuse, misuse or use for other than its intended purpose.
8. Damage to or failure of this product caused by the use of detergents, cleaners, chemicals or utensils other than those recommended in all instructions supplied with the product.
9. Damage to or failure of parts or systems resulting from unauthorized modifications made to this product.

Disclaimer of implied warranties; limitation of remedies

Customer's sole and exclusive remedy under this limited warranty shall be product repair as provided herein. Implied warranties, including warranties of merchantability or fitness for a particular purpose, are limited to one year or the shortest period allowed by law. Sears shall not be liable for incidental or consequential damages. Some states and provinces do not allow the exclusion or limitation of incidental or consequential damages, or limitation on the duration of implied warranties of merchantability or fitness, so these exclusions or limitations may not apply to you.

This warranty applies only while this appliance is used in the United States or Canada.

This warranty gives you specific legal rights, and you may also have other rights which vary from state to state.

Sears, Roebuck and Co., Hoffman Estates, IL 60179
Sears Canada Inc., Toronto, Ontario, Canada M5B 2B8

Product Record

In this space below, record the date of purchase, model and serial number of your product. You will find the model and serial number printed on the serial plate.

Model No. **790.** _____

Serial No. _____

Date of purchase _____

Save these instructions and your sales receipt for future reference.

Please carefully read and save these instructions

This Use & Care Manual contains general operating instructions for your appliance and feature information for several models. Your product **may not** have all the described features. The graphics shown are representative. The graphics on your appliance may not look exactly like those shown. Common sense and caution must be practiced when installing, operating and maintaining any appliance.

Serial Plate Location

You will find the model and serial number printed on the serial plate. The serial plate is located as shown below.

Remember to record the serial number for future reference.

Serial
Plate
Location

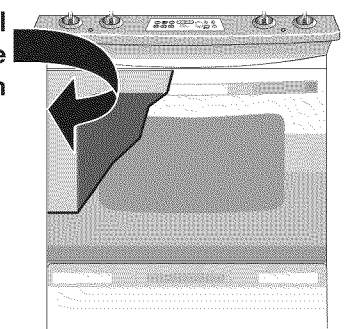

Important Safety Instructions

Read all instructions before using this appliance.

Save these instructions for future reference.

This manual contains many important safety messages. Always read and obey all safety messages.

The safety symbol  calls your attention to safety messages that inform you of hazards that can kill or hurt you or others, or cause damage to the product.

⚠ WARNING Indicates an imminently hazardous situation which, if not avoided may result in death or serious injury.

⚠ CAUTION Indicates an imminently hazardous situation which, if not avoided may result in minor or moderate injury, or product damage.

All safety messages will identify the hazard, tell you how to reduce the chance of injury, and tell you what can happen if the instructions are not followed.

- **Remove all tape and packaging before using the range.** Destroy the carton and plastic bags after unpacking the range. Never allow children to play with packaging material.
- **Proper Installation—Be sure your appliance is properly installed and grounded by a qualified technician in accordance with the National Electrical Code ANSI/NFPA No. 70 latest edition, and local code requirements.** Install only per installation instructions provided in the literature package for this range.

Sears Parts & Repair is the recommended repair service for this appliance. Know how to disconnect the electrical power to the appliance at the circuit breaker or fuse box in case of an emergency.

- **User servicing—Do not repair or replace any part of the appliance unless specifically recommended in the manuals.** All other servicing should be done only by a qualified technician. This may reduce the risk of personal injury and damage to the range.
- **Never modify or alter the construction of a range by removing leveling legs, panels, wire covers, anti-tip brackets/screws, or any other part of the product.**

⚠ WARNING Stepping, leaning or sitting on the door or drawer of this range can result in serious injuries and also cause damage to the range. Do not allow children to climb or play around the range. The weight of a child on an open door may cause the range to tip, resulting in serious burns or other injury. An open drawer, when hot, may cause burns.



⚠ WARNING

- All ranges can tip.
- Injury to persons could result.
- Install anti-tip device packed with range.
- See Installation Instructions.



To reduce the risk of tipping, the range oven must be secured by properly installed anti-tip bracket(s) provided with the range. To check if the bracket(s) is installed properly, remove the lower panel or storage drawer and verify that the anti-tip bracket(s) is engaged. Refer to the Installation Instructions for proper anti-tip bracket(s) installation.

⚠ WARNING Do not use the oven or warmer drawer (if equipped) for storage.

⚠ CAUTION Do not store items of interest to children in the cabinets above a range. Children climbing on the range to reach items could be seriously injured.

⚠ WARNING Never use your appliance for warming up or heating up the room.

- **Storage in or on appliance—Flammable materials should not be stored in an oven, near surface units or in the drawer (if equipped).** This includes paper, plastic and cloth items, such as cookbooks, plasticware and towels, as well as flammable liquids. Do not store explosives, such as aerosol cans, on or near the appliance. Flammable materials may explode and result in fire or property damage.
- **Do not leave children alone—Children should not be left alone or unattended in the area where appliance is in use.** They should never be allowed to sit or stand on any part of the appliance.
- **DO NOT TOUCH SURFACE UNITS, AREAS NEAR THESE UNITS, OVEN HEATING ELEMENTS OR INTERIOR SURFACES OF THE OVEN OR WARMER DRAWER (if equipped).** Both surface and oven heating elements may be hot even though they are dark in color. Areas near surface units may become hot enough to cause burns. During and after use, do not touch, or let clothing or other flammable materials touch these areas until they have had sufficient time to cool. Among these areas are the cooktop, surfaces facing the cooktop, the oven vent openings and surfaces near these openings, oven door and window.
- **Wear proper apparel—Loose-fitting or hanging garments should never be worn while using the appliance.** Do not let clothing or other flammable materials contact hot surfaces.
- **Do not use water or flour on grease fires—Smother the fire with a pan lid, or use baking soda, a dry chemical or foam-type extinguisher.**

Important Safety Instructions

- **When heating fat or grease, watch it closely.** Fat or grease may catch fire if allowed to become too hot.
- **Use only dry potholders—Moist or damp potholders on hot surfaces may result in burns from steam.** Do not let potholders touch hot heating elements. Do not use a towel or other bulky cloth instead of a potholder.
- **Do not heat unopened food containers—Buildup of pressure may cause container to burst and result in injury.**
- **Remove the oven door from any unused range if it is to be stored or discarded.**
- **Glazed cooking utensils—**Only certain types of glass, glass/ceramic, ceramic, earthenware, or other glazed utensils are suitable for rangetop service without breaking due to the sudden change in temperature. Check the manufacturer's recommendations for cooktop use.
- **Do not use decorative surface element covers.** If an element is accidentally turned on, the decorative cover will become hot and possibly melt. Burns will occur if the hot covers are touched. Damage may also be done to the cooktop.

IMPORTANT—Do not attempt to operate the oven during a power failure. If the power fails, always turn the oven off. If the oven is not turned off and the power resumes, the oven may begin to operate again. (Food left unattended could catch fire or spoil.)

IMPORTANT INSTRUCTIONS FOR USING YOUR COOKTOP

- **Know which knob controls each surface heating unit.**
- **Use proper pan size.** This appliance is equipped with one or more surface units of different sizes. Select utensils having flat bottoms large enough to cover the surface unit. The use of undersized utensils will expose a portion of the surface heating unit to direct contact and may result in ignition of clothing. Proper relationship of utensil to the surface unit will also improve efficiency.
- **Utensil handles should be turned inward and not extend over adjacent surface units.** To reduce the risk of burns, ignition of flammable materials, and spillage due to unintentional contact with the utensil.
- **Never leave surface burners unattended at high heat settings—**Boilovers cause smoking and greasy accumulations that may ignite, or a pan that has boiled dry may melt.
- **Protective liners—**Do not use aluminum foil to line oven bottom or any other part of the appliance. Only use aluminum foil as recommended for baking if used as a cover placed on the food. Any other use of protective liners or aluminum foil may result in a risk of electric shock or fire or short circuit.

FOR COOKTOPS WITH COIL ELEMENTS ONLY

- **Do Not Immerse or Soak Removable Surface Heating Elements.** Surface heating elements should never be immersed in water. Heating elements clean themselves during normal operation.
- **Make Sure Drip Pans or Drip Bowls Are in Place.** Absence of these pans or bowls during cooking may subject wiring or components underneath to damage.

FOR GLASS COOKTOPS ONLY

- **Do not clean or operate a broken cooktop—**If cooktop should break, cleaning solutions and spillovers may penetrate the broken cooktop and create a risk of electric shock. Contact a qualified technician immediately.
- **Clean cooktop glass with caution—**If a wet sponge or cloth is used to wipe spills on a hot cooking area, be careful to avoid a steam burn. Some cleaners can produce harmful fumes if applied to a hot surface.
- **Avoid scratching the cooktop glass with sharp objects.**

IMPORTANT INSTRUCTIONS FOR USING YOUR OVEN

- **Use care when opening oven door or warmer drawer (if equipped)—**Stand to the side of the range when opening the door of a hot oven. Let hot air or steam escape before you remove or replace food in the oven / warmer drawer.
- **Keep oven vent ducts unobstructed.** The oven is vented through the right rear coil element or at right side of the front panel and visible when the oven door is open. Touching the surfaces in this area when the oven is operating may cause severe burns. Also, do not place plastic or heat-sensitive items on or near the oven vent. These items could melt or ignite.

Important Safety Instructions

- **Placement of oven/warmer drawer (if equipped)**
Racks. Always place oven racks in desired location while oven/warmer drawer (if equipped) is cool. If rack must be moved while oven is hot use extreme caution. Use potholders and grasp the rack with both hands to reposition. Do not let potholders contact the hot heating elements in the oven/warmer drawer (if equipped). Remove all utensils from the rack before moving.
- **Do not use your broiler pan without its insert.** The broiler pan and its insert allow dripping fat to drain and be kept away from the high heat of the broiler.
- **Do not cover the broiler insert with aluminum foil.** Exposed fat and grease could ignite.
- **Do not touch a hot light bulb with a damp cloth.** Doing so could cause the bulb to break. Disconnect the appliance or turn off the power to the appliance before removing and replacing light bulb.

IMPORTANT INSTRUCTIONS FOR CLEANING YOUR RANGE

- **Clean the range regularly to keep all parts free of grease that could catch fire.** Exhaust fan ventilation hoods and grease filters should be kept clean. Do not allow grease to accumulate on hood or filter. Greasy deposits in the fan could catch fire. When you are flaming food under the hood, turn the fan on. Refer to the hood manufacturer's instructions for cleaning.

SELF-CLEANING OVENS

- **In the self-cleaning cycle, only clean the parts listed in this Use and Care Guide.** Before self-cleaning the oven, remove all utensils or foods from the oven.
- **Do not use oven cleaners**—No commercial oven cleaner or oven liner protective coating of any kind should be used in or around any part of the oven.
- **Do not clean door gasket**—The door gasket is essential for a good seal. Care should be taken not to rub, damage or move the gasket.
- **Remove oven racks.** Oven racks color will change if left in the oven during a self-cleaning cycle.

⚠ CAUTION The health of some birds is extremely sensitive to the fumes given off during the self-cleaning cycle of any range. Move birds to another well ventilated room.

IMPORTANT SAFETY NOTICE

The California Safe Drinking Water and Toxic Enforcement Act requires the Governor of California to publish a list of substances known to the state to cause cancer, birth defects or other reproductive harm, and requires businesses to warn customers of potential exposure to such substances.

SAVE THESE SAFETY INSTRUCTIONS

Range features

Your Electric Range Features At a glance

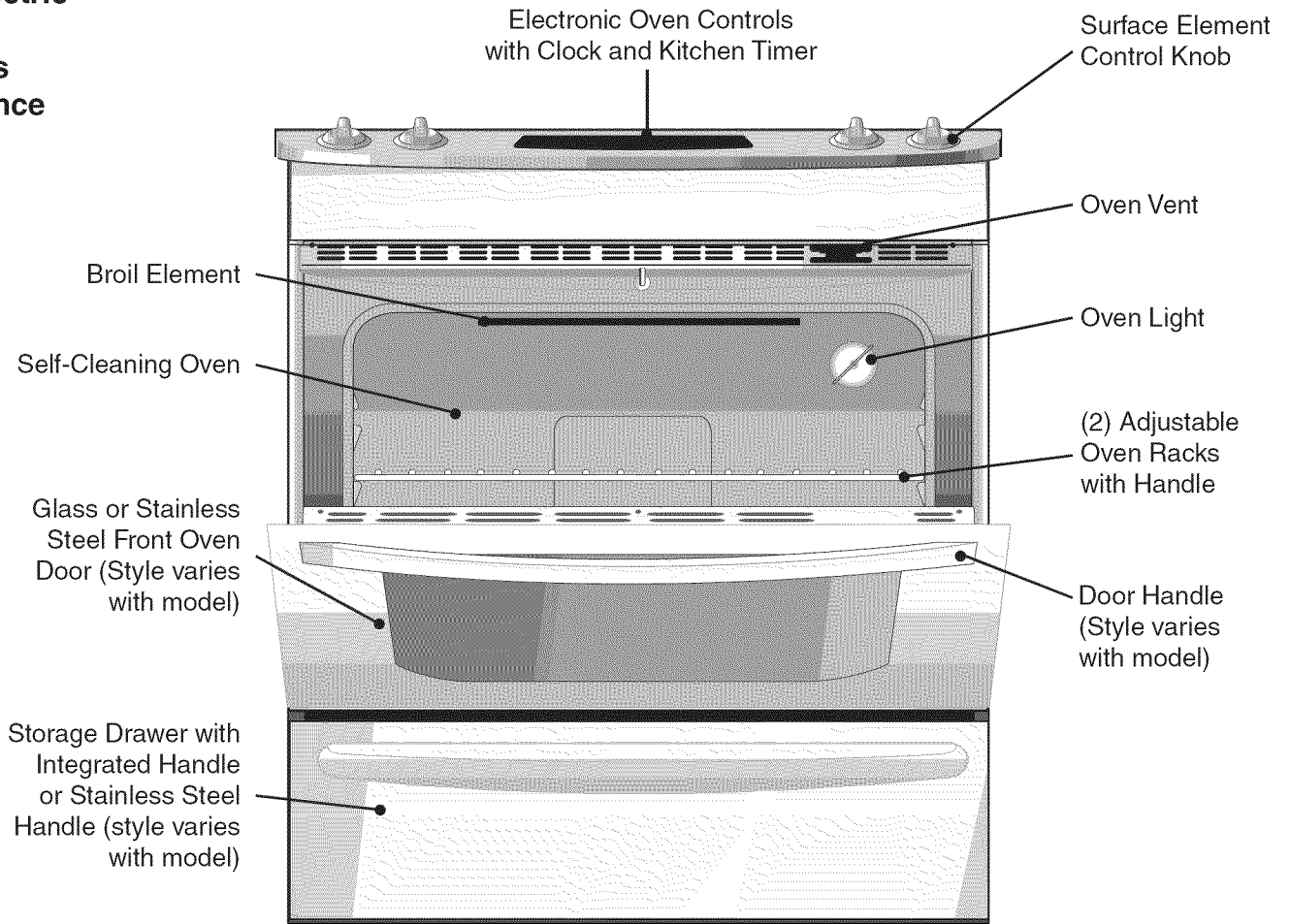

Models with Coil Surface Elements

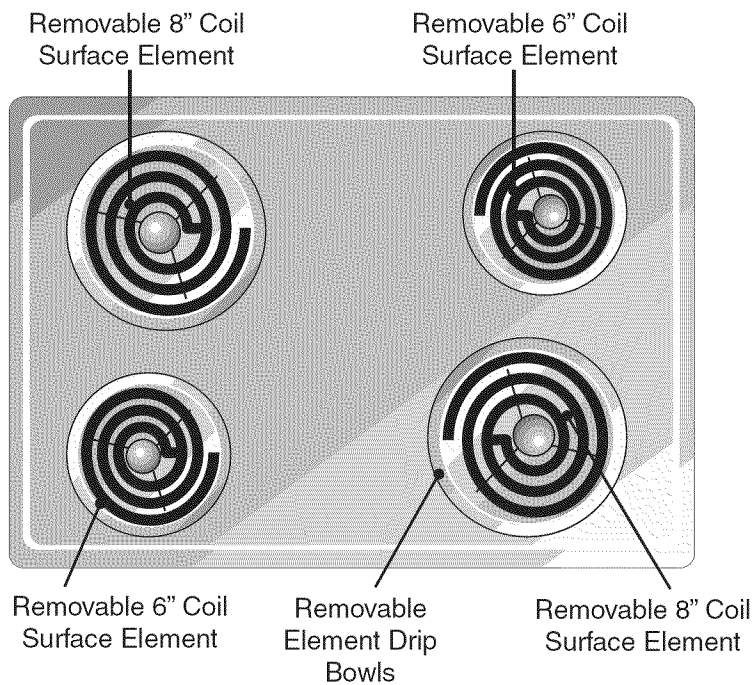

Models with Ceramic Glass Cooktop

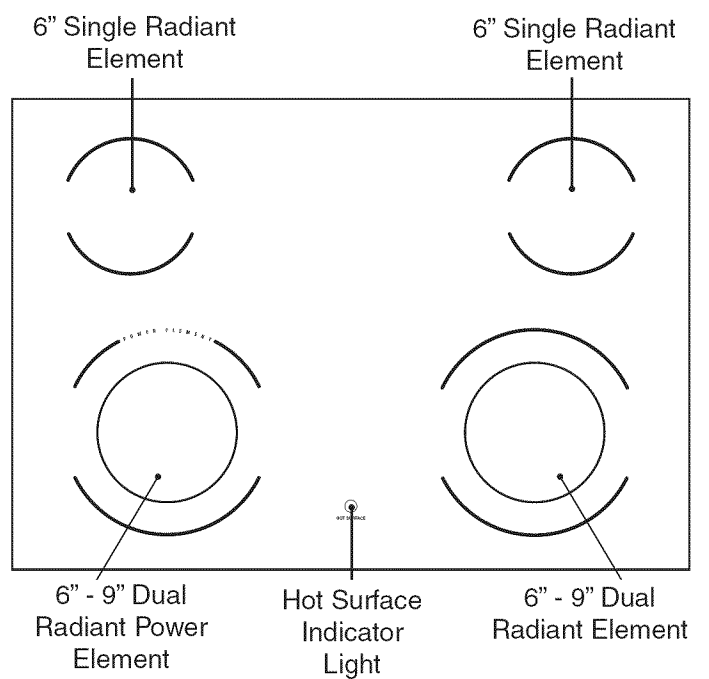

Note: The features of your range will vary according to model.

Setting Surface Controls

Models with Coil Surface Elements

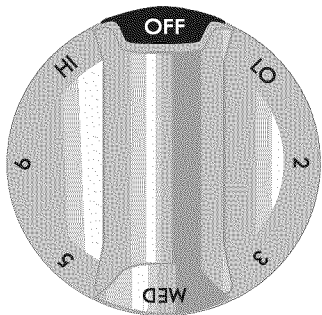

Note: The size and type of utensil used, and the amount and type of food being cooked will influence the setting needed for best cooking results.

Setting Surface Controls

1. Place the pan on the surface element.
2. Push in and turn the surface element control knob to desired setting.
3. The surface signal light will glow when one or more elements are turned on. Always turn the element off before removing the pan.

Setting*

HI
MED
MED-LO
LO

Type of Cooking

Start most foods, bring water to a boil, pan broiling.
Maintain a slow boil, thicken sauces and gravies, steam vegetables.
Keep food cooking, poach, stew.
Keep warm, melt, simmer.

*The suggested settings are based on cooking in medium thickness aluminum pans with lids. Settings may vary when using other types of pans.

CAUTION Do not place items such as salt and pepper shakers, spoon holders or plastic wrappings on top of the cooktop when it is in use. These items could melt or ignite. Potholders, towels or wood could catch fire if placed too close to the element.

Models with Ceramic Glass Cooktop

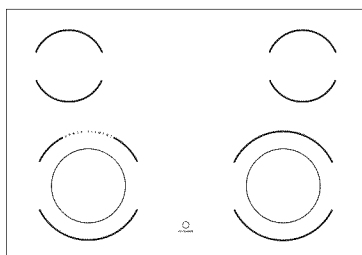

Figure 1

About the Ceramic Glass Cooktop

The ceramic cooktop has radiant surface elements located below the surface of the glass. The design of the ceramic cooktop outlines the area of the surface element underneath. **Make sure** the diameter of the pan matches the diameter of the element outline on the cooktop (See Figure 1).

Heat is transferred up through the surface of the cooktop to the cookware. Only flat-bottom cookware should be used. The type and size of cookware, the number of surface elements in use and their settings, are all factors that will affect the amount of heat that will spread to areas beyond the surface elements. The areas surrounding the elements may become **hot enough to cause burns**.

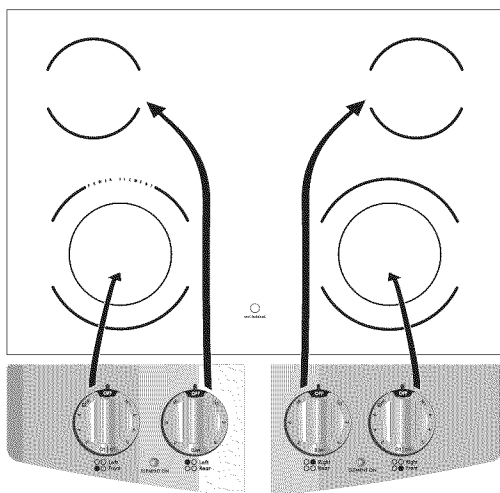

Figure 2

About the Radiant Surface Elements

The element temperature rises gradually and evenly. As the temperature rises, the element will glow red. To maintain the selected setting, the element will cycle on and off. The heating element retains enough heat to provide a uniform and consistent heat during the off cycle. For efficient cooking, turn off the element several minutes before cooking is complete. This will allow residual heat to complete the cooking process.

Locations of the Radiant Surface Elements and Controls

Your range is equipped with radiant surface burners with different wattage ratings. The ability to heat food quicker and in larger volumes increases as the element wattage increases.

The radiant surface elements are located on the cooktop as follows:

- 2 smaller **6 inch** radiant elements located at the right and left rear position;
- 2 **dual 6 or 9 inch** radiant element located at the right and left front position

NOTE: (White glass cooktops only) Due to the high intensity of heat generated by the surface elements, the glass surface will turn light green when the element is first turned off. This phenomenon is normal and the glass will come back to its original white color after it has completely cooled down.

NOTE: Please read detailed instructions for ceramic glass cooktop cleaning in the **General Care & Cleaning** section and **Before You Call** checklist section of this Use and Care Guide.

NOTE: Radiant elements have a limiter that allows the element to cycle on and off, even at the HI setting. This helps to prevent damage to the ceramic glass cooktop. Cycling at the HI setting is normal and can also occur if the cookware is too small for the radiant element or if the cookware bottom is not flat (Refer to the section Selecting Surface Cooking Cookware for using correct cookware instructions with the cooktop).

Setting Surface Controls (cont'd)

Models with Ceramic Glass Cooktop (cont'd)

Surface Cooking Settings

Use the chart (Figure 1) to determine the correct setting for the kind of food you are preparing. The Simmer settings are used to simmer and keep larger quantities of foods warm such as stews and soups. The lower Simmer settings are ideal for delicate foods and melting chocolate or butter.

Note: The size and type of cookware used will influence the setting needed for best cooking results.

Recommended Settings for Single and Dual Surface Elements	
Setting*	Type of Cooking
HIGH	Start most foods, bring water to a boil, pan broiling
MEDIUM HIGH	Continue a rapid boil, fry, deep fat fry
MEDIUM	Maintain a slow boil, thicken sauces and gravies, steam vegetables
MEDIUM LOW	Keep foods cooking, poach, stew
LOW	Keep warm, melt, simmer

Figure 1

*The suggested settings are based on cooking in medium thickness aluminum pans with lids. Settings may vary when using other types of pans.

Operating Single Radiant Surface Elements

The cooktop has single radiant surface elements at 2 locations; the right rear and the left rear (Figure 2) element positions.

To Operate the Single Surface Elements:

1. Place correctly sized cookware on the radiant surface element.
2. Push in and turn the surface control knob in either direction to the desired setting (Figure 3). Turn the knob to adjust the setting if desired. Start most cooking operations on a higher setting and then turn to a lower setting to finish cooking. Each surface element provides a constant amount of heat at each setting. A glowing red surface heating area extending beyond the bottom edge of the cookware indicates the cookware is **too small** for the surface heating area.
3. When cooking has completed, turn the surface control knob to OFF before removing the cookware. **Note:** The Hot Surface Indicator light will come on when the control knob is turned on and will continue to glow until the glass cooktop has cooled down to a moderate level. The light may remain on even though the controls are turned OFF.

Note: See above, Figure 1 for recommended control settings.

CAUTION Radiant surface elements may appear to have cooled after they have been turned off. A hot surface indicator light will come on and will continue to glow until the glass cooktop has cooled down to a moderate level. **The glass surface may still be hot** and burns may occur if the glass surface is touched before the indicator light has turned off.

CAUTION Do not place plastic items such as salt and pepper shakers, spoon holders or plastic wrappings on top of the range when it is in use. These items could melt or ignite. Potholders, towels or wooden spoons could catch fire if placed too close to the surface elements.

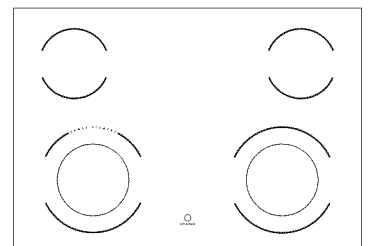

Figure 2
Right Rear and Left Rear Elements

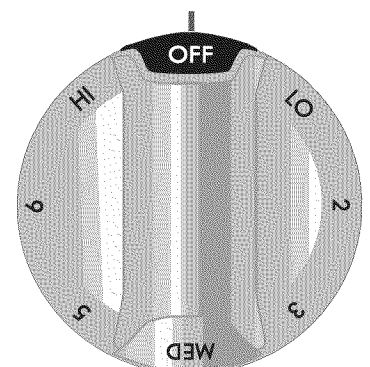

Figure 3

Setting Surface Controls (cont'd) Models with Ceramic Glass Cooktop (cont'd)

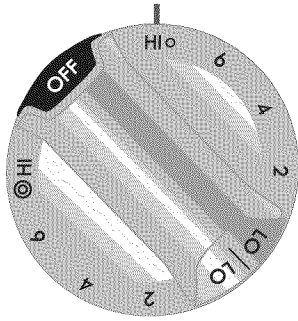

Figure 1

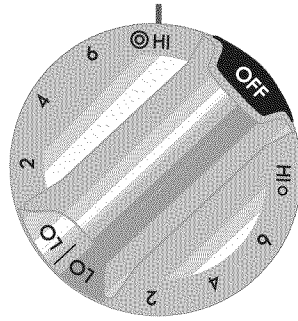

Figure 3

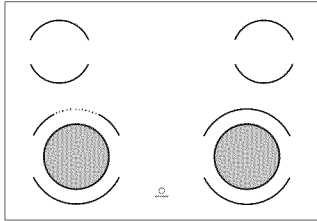

Figure 2

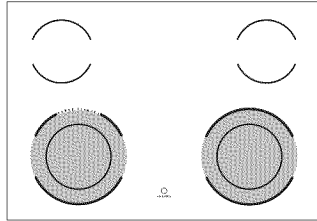

Figure 4

Operating the Dual Surface Radiant Element

The cooktop is equipped with two dual radiant surface elements located at the right and left front (See Figure 2 & 4) position. “**Single** and **Multi** on the control knob are used to indicate which coil of the dual radiant element will heat. “**Single**” indicates that only the inner coil will heat (Figures 1 & 2). “**Multi**” indicates that both inner and outer coils will heat (Figures 3 & 4). You may switch from either coil setting at any time during cooking.

To Operate the Dual Surface Element:

1. Place correctly sized cookware on the dual surface element.
2. Push in and turn the control knob counterclockwise (See Figure 1) for smaller cookware or clockwise (See Figure 3) for larger cookware.
3. Turn the knob to adjust the setting if needed. Start most cooking operations on a higher setting and then turn to a lower setting to finish cooking. Each surface element provides a constant amount of heat at each setting. A glowing red surface heating area extending beyond the bottom edge of the cookware indicates the cookware is **too small** for the surface heating area.

4. When cooking has completed, turn the surface control knob to OFF before removing the cookware. **Note:** The Surface Indicator light will come on when the control knob is turned on and will continue to glow until the glass cooktop has cooled down to a moderate level. The light may remain on even though the controls are turned OFF. **Note:** See “Recommended Settings for Single and Dual Surface Elements” for recommended control settings.

Selecting Surface Cooking Cookware

Cookware should have flat bottoms that make good contact with the entire surface heating element. Check for flatness by rotating a ruler across the bottom of the cookware (See Figure 5). Be sure to follow the recommendations for using cookware as shown in Figure 6.

Note: The size and type of cookware used will influence the setting needed for best cooking results.

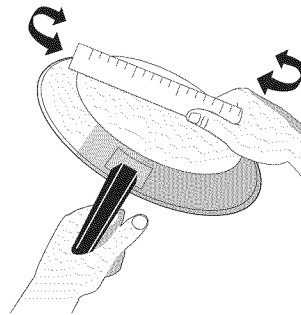
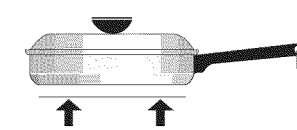

Figure 5

Correct



- Flat bottom and straight sides.
- Tight fitting lids.
- Weight of handle does not tilt pan. Pan is well balanced.
- Pan sizes match the amount of food to be prepared and the size of the surface element.
- Made of a material that conducts heat well.
- Easy to clean.
- Always match pot diameter to element surface diameter.

Incorrect

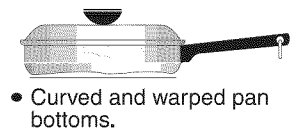

- Curved and warped pan bottoms.

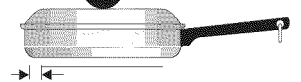

- Pan overhangs element by more than one-half inch.

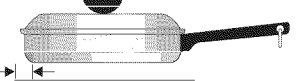

- Pan is smaller than element.



- Heavy handle tilts pan.

Figure 6

Cookware Material types

The cookware material determines how evenly and quickly heat is transferred from the surface element to the pan bottom. The most popular materials available are:

ALUMINUM - Excellent heat conductor. Some types of food will cause it to darken (Anodized aluminum cookware resists staining & pitting). If aluminum pans slide across the ceramic glass cooktop, they may leave metal marks which will resemble scratches. Remove these marks immediately. See **Cleaning Recommendations for the Ceramic Glass Cooktop** section.

COPPER - Excellent heat conductor but discolors easily. May leave metal marks on ceramic glass (see Aluminum above).

STAINLESS STEEL - Slow heat conductor with uneven cooking results. Is durable, easy to clean and resists staining.

CAST IRON - A poor heat conductor however will retain heat very well. Cooks evenly once cooking temperature is reached. Not recommended for use on ceramic cooktops.

PORCELAIN-ENAMEL on METAL - Heating characteristics will vary depending on base material. Porcelain-enamel coating must be smooth to avoid scratching ceramic cooktops.

GLASS - Slow heat conductor. Not recommended for ceramic cooktop surfaces because it may scratch the glass.

ENGLISH

Before Setting Oven Controls

CAUTION This range has a fan that will turn “ON” and “OFF” by itself to keep the electronics cool. It may continue to run after the range has been turned “OFF”, but may also stop immediately and then turn “ON” after a while.

Oven Vent Location - Models with Coil Elements

The oven is vented **through the right rear coil element**. When the oven is on, warm air is released through the vent(s). This venting is necessary for proper air circulation in the oven and good baking results. **DO NOT** block the vent(s). Doing so may cause cooking failures, fire or damage to the appliance.

OVEN VENT

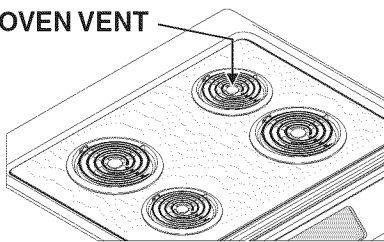

Oven Vent Location - Models with Ceramic Glass Cooktop

The oven vent is located **at right side of the front panel** and visible when the oven door is open. When the oven is on, hot air is released through the vents. This venting is necessary for proper air circulation in the oven and good baking results.

OVEN VENT

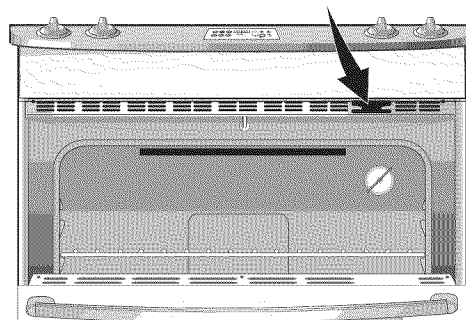

Removing and Replacing Oven Racks

To remove, pull the rack forward until it stops. Lift up front of rack and slide out. **To replace**, fit the rack onto the guides on the oven walls. Tilt the front of the rack upward and slide the rack back into place.

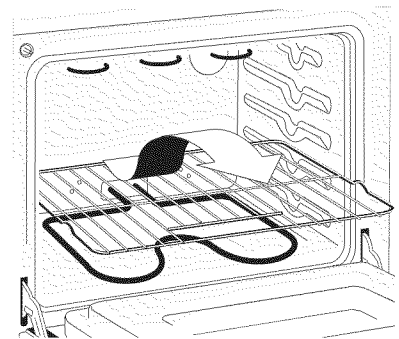

Arranging Oven Racks

ALWAYS ARRANGE OVEN RACKS WHEN THE OVEN IS COOL (PRIOR TO OPERATING THE OVEN). Always use oven mitts when the oven is hot.

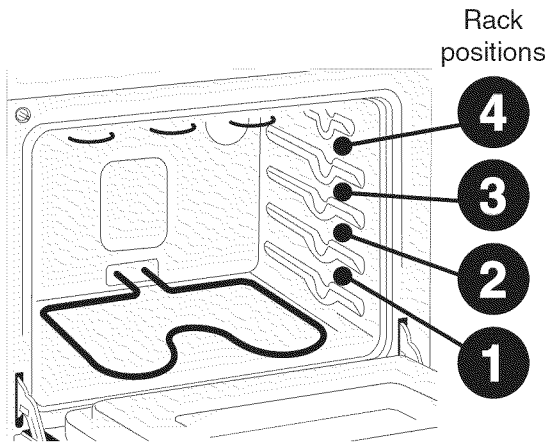

RECOMMENDED RACK POSITIONS FOR BROILING, BAKING & ROASTING

Food	Rack position
Broiling meats, chicken or fish	3 or 4
Cookies, cakes, pies, biscuits & muffins	2 or 3
1 rack	2 & 4
Multiple racks	2 & 4
Frozen pies, angel food cake, yeast, bread, casseroles, small cuts of meat or poultry	1 or 2
Turkey, roast or ham	1

Note: Always use caution when removing food.

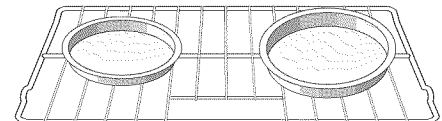

1 Oven Rack

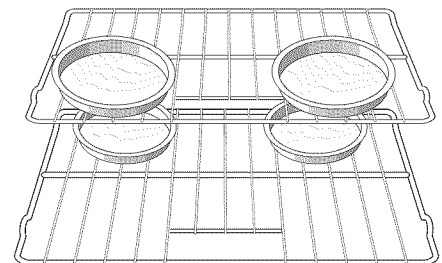

Multiple Oven Racks

Air Circulation in the Oven

For best air circulation and baking results allow 2-4” (5-10,2 cm) around the cookware for proper air circulation and be sure pans and cookware do not touch each other, the oven door, sides or back of the oven cavity. The hot air must circulate around the pans and cookware in the oven for even heat to reach around the food.

Control Pad Functions

Note: The appearance of your oven control may differ slightly from the one illustrated below. However, all functions are the same. Also, push buttons or pads may be shaped differently than those appearing in this Use and Care Guide.

READ THE INSTRUCTIONS CAREFULLY BEFORE USING THE OVEN. For satisfactory use of your oven, become familiar with the various functions of the oven as described below.

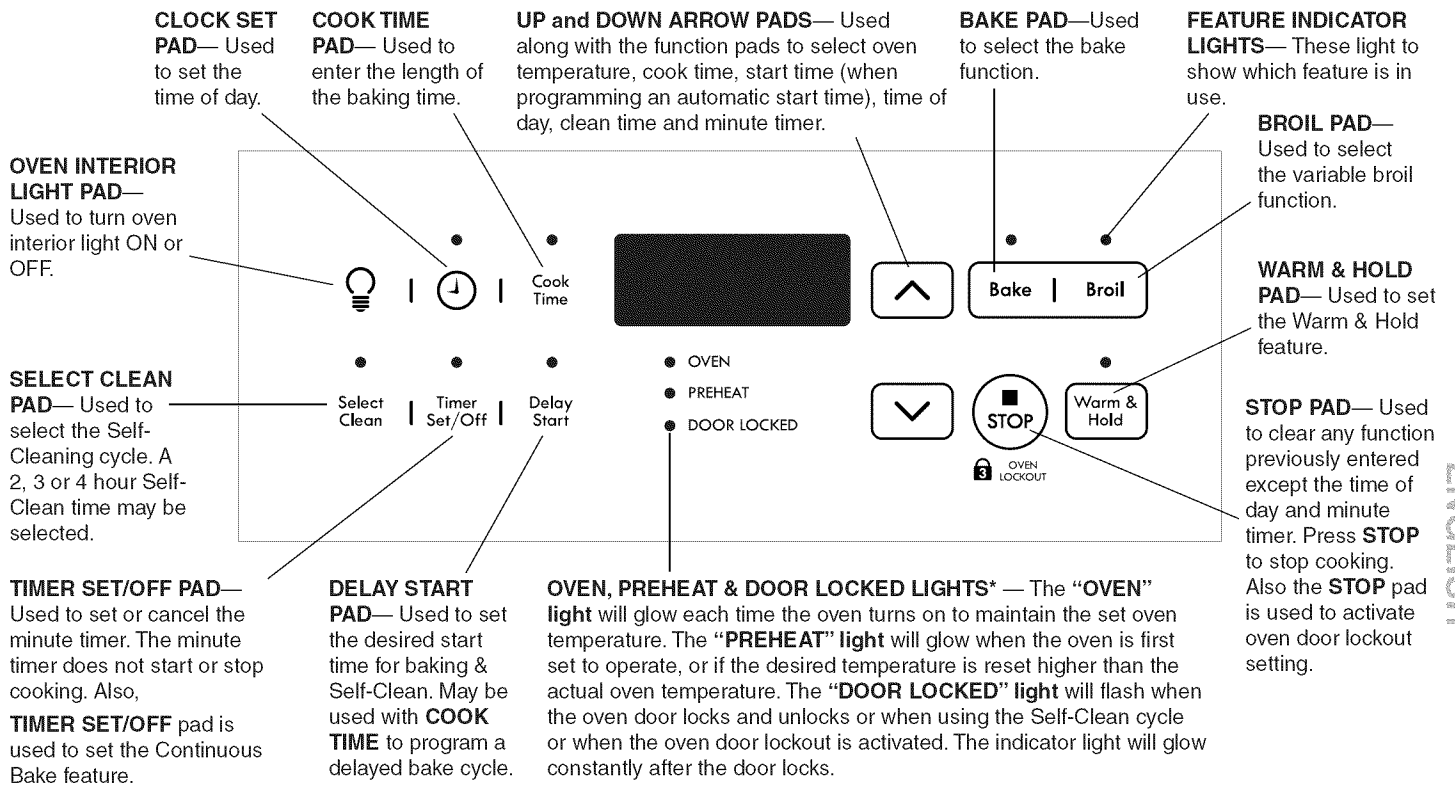

ENGLISH

*Note: The **OVEN** indicator light on the electronic display will turn ON and OFF when using the Bake feature and during preheat. This is normal and indicates that the oven is cycling to maintain the selected baking temperature. When the pre-heat indicator light turns OFF, your oven has reached the set temperature.

For a silent control panel

When choosing a function, a beep will be heard each time a pad is pressed. If desired, the control can be programmed for silent operation. Press and hold **Delay Start** pad. After 5 seconds, the control will beep once. This will block the controls from sounding when a pad is pressed. To return to normal sound operation, press and hold **Delay Start** pad again for 5 seconds until the control beeps once.

Temperature conversion

The electronic oven control is set to operate in °F (Fahrenheit) when shipped from the factory. The oven can be programmed for any temperature from 170°F to 550°F (77°C to 287°C).

To change the temperature to °C (Celsius) or from °C to °F (control should not be in a Bake or Clean mode):



1. Press **Broil** pad. “— —” appears in the display.
2. Press and hold the **UP** pad until “HI” appears in the display.
3. Press and hold **Broil** pad until °F or °C appears in the display.
4. Press the **UP** or **DOWN** pad to change °F to °C or °C to °F.
5. Press any control pad to return to normal operating mode.

Setting Oven Controls





Note: The time of day **must** first be set in order to operate the oven.

To Set the Clock

When the range is first plugged in, or when the power supply to the range has been interrupted, the display will flash "12:00".

1. Press  pad once (do not hold pad down).
2. Within 5 seconds, press and hold the  or  pad until the correct time of day appears in the display.
Note: The clock cannot be changed during any timed bake or Self-Clean cycle.



To Set the Timer:

1. Press  pad.
2. Press the  pad to increase the time in one minute increments. Press and hold the  pad to increase the time in 10 minute increments. The timer can be set for any amount of time from 1 minute to 11 hours and 59 minutes.
Note: If the  pad is pressed first, the timer will advance to 11 hours and 59 minutes.
3. The display shows the timer countdown in minutes until 1 minute remains. Then the display will count down in seconds.
4. When the set time has run out, the timer will beep 3 times. It will then continue to beep 3 times every 60 seconds until  pad is pressed.



Note: The indicator light located above the  pad will glow while the minute timer is active.

Note: The timer does not start or stop cooking. It serves as an extra timer in the kitchen that will beep when the set time has run out. The timer can be used alone or during any of the other oven functions. When the timer is in use with any other function, the timer will be shown in the display. To view other functions, press the pad for that function.

To Change the Timer while it is in use:

While the timer is active and shows in the display, press and hold the  or  pad to increase or decrease the time.

To Cancel the Timer before the set time has run out: Press  pad.







Note: To turn the **time of day** display **OFF** or **ON** in the display press  pad and hold for 7 seconds (the control will beep once) and then release. This feature does not remove the set time of day from the memory of the control. When the display is turned OFF the time of day will reappear for a few seconds any time the  pad is touched.

Setting Oven Controls (cont'd)



To Set or Change the Temperature for Baking

The oven can be programmed to bake at any temperature from 170°F to 550°F (77°C to 287°C).

To Set the Controls for Baking:

1. Press **Bake** pad. “— — —” appears in the display.
2. Within 5 seconds, press the  or  pad. The display will show “350°F (177°C)”. By pressing and holding the  or  pad, the temperature can then be adjusted in 5°F increments (1°C if the control is set to display Celsius).
3. As soon as the  or  pad is released, the oven will begin heating to the selected temperature. When the oven temperature reaches the desired baking temperature, the preheat indicator light will turn OFF and the control will beep 3 times.
4. To cancel baking, press  pad.



To Change the Oven Temperature after Baking has Started:

1. Press **Bake** pad and make sure the bake temperature is displayed.
2. Press the  or  pad to increase or decrease the set temperature.

To Set Control for Continuous Bake or 12 Hour Energy Saving

The oven control has a built-in 12 Hour Energy Saving feature that will shut off the oven if the control is left on for more than 11 hours and 59 minutes. The oven can be programmed to override this feature for continuous baking.



To set control for continuous baking:

1. Press and hold  pad down for 5 seconds until tone is heard, “— — hr” will appear in display for continuous cooking. The current time of day will return to the display.
2. To cancel the Continuous Bake function, press and hold  pad for 5 seconds until tone is heard. “12hr” will appear in display indicating that the control has returned to the 12 Hour Energy Saving feature.

To Set Control for Oven Lockout

The control can be programmed to lock the oven door and lock out the oven control pads.



To set Control for Oven Lockout feature:

1. Press and hold  pad for 3 seconds. “Loc” will appear in display, the “Door Locked” indicator light will flash and the motor driven door lock will begin to close automatically. **DO NOT open oven door** while the indicator light is flashing. Allow about 15 seconds for the oven door to lock. Once the oven door is locked, the current time of day will appear in the display.
2. To cancel the Oven Lockout feature, press and hold  pad for 3 seconds. The control will unlock the oven door and resume normal operation.







Note: While in the Oven Lockout mode when the BAKE, BROIL, WARM & HOLD, COOK TIME, DELAY START and SELECT CLEAN pads are pressed, “Loc” will appear in the display until the control pad is released. The OVEN LIGHT, CLOCK and TIMER pads will still operate.

Setting Oven Controls (cont'd)











To Set the Timed Bake and Delay Start Features

The  **COOK TIME** and  **DELAY START** pads operate the features that will turn the oven ON and OFF at the times you select in advance. The oven can be programmed to start immediately and shut off automatically (Timed Bake) or to begin baking at a later time with a delayed start time (Delay Start).

To Program the Oven to Begin Baking Immediately and To Shut Off Automatically (Timed Bake):

1. Be sure that the clock shows the correct time of day.
2. Place the food in the oven.
3. Press **Bake** pad. “— — — °” appears in the display.
4. The oven will turn ON and begin heating.
5. Within 5 seconds, press the  or  pad. The display will show “350°F (177°C).” By holding the  or  pad, the temperature can then be adjusted in 5°F increments (1°C if the control is set to display Celsius).
6. Press  pad. “:00” will flash in the display (HR:MIN).
7. Press the  or  pad until the desired baking time appears in the display.



To Program Oven for a Delayed Start Time and to Shut-Off Automatically (Delayed Start Bake):

1. Be sure that the clock shows the correct time of day.
2. Place the food in the oven.
3. Press **Bake** pad. “— — — °” appears in the display.
4. Within 5 seconds, press the  or  pad. The display will show “350°F (177°C).” By holding the  or  pad, the temperature can then be adjusted in 5°F increments (1°C if the control is set to display Celsius).
5. Press  pad. “:00” will flash in the display (HR:MIN).
6. Press the  or  pad until the desired baking time appears.
7. Press  pad. The earliest possible start time will appear in the display.
8. Press the  or  pad until the desired start time appears in the display.
9. The oven will turn ON at the delayed start time and begin heating.

When the Set Bake Time Runs Out:

1. “End” will appear in the display window and the oven will shut off automatically.
2. The control will beep 3 times every 60 seconds until  pad is pressed.

To Change the Oven Temperature or Bake Time after Baking has Started:

1. Press the function pad you want to change.
2. Press the  or  pad to adjust the setting.

⚠ CAUTION Use caution with the Timed Bake and Delayed Start features. Foods that can easily spoil such as milk, eggs, fish, meat or poultry, should be chilled in the refrigerator first. Even when chilled, they should not stand in the oven for more than 1 hour before cooking begins, and should be removed promptly when cooking is completed.

Setting Oven Controls (cont'd)

Oven Baking Information

For best results, preheat the oven before baking cookies, breads, cakes, pies or pastries, etc. There is no need to preheat the oven for roasting meat or baking casseroles.



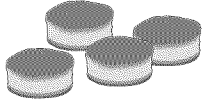
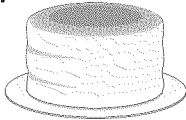
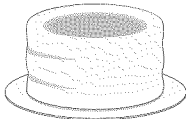
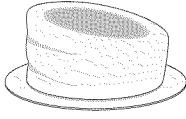
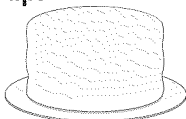

The cooking times and temperatures needed to bake a product may vary slightly from your previously owned appliance. Refer to “**Adjusting the Oven Temperature**” section.

Baking Problems and Solutions Chart		
Baking Problems	Causes	Corrections
Cookies and biscuits burn on the bottom. 	<ul style="list-style-type: none"> • Cookies and biscuits put into the oven before the preheating time is completed. • Oven rack overcrowded. • Dark pan absorbs heat too fast. 	<ul style="list-style-type: none"> • Allow oven to preheat to the selected temperature before placing food in oven. • Choose pan sizes that will permit 5.1cm to 10.2cm (2” to 4”) of air space on all sides when placed in the oven. • Use a medium-weight aluminum baking sheet.
Cakes too dark on top or bottom. 	<ul style="list-style-type: none"> • Cakes put into the oven before preheating time is completed. • Rack position too high or low. • Oven too hot. 	<ul style="list-style-type: none"> • Allow oven to preheat to the selected temperature before placing food in the oven. • Use proper rack position for baking needs. • Set oven temperature 25°F/12°C lower than recommended.
Cakes not done in the center. 	<ul style="list-style-type: none"> • Oven too hot. • Incorrect pan size. • Pan not centered in oven. 	<ul style="list-style-type: none"> • Set oven temperature 25°F/12°C lower than recommended. • Use pan size suggested in recipe. • Use proper rack position and place pan so there is 5.1cm to 10.2cm (2” to 4”) of space on all sides of pan.
Cakes not level. 	<ul style="list-style-type: none"> • Range not level. • Pan too close to oven wall or rack overcrowded. • Pan warped. 	<ul style="list-style-type: none"> • Place a marked glass measuring cup filled with water on the center of the oven rack. If the water level is uneven, refer to the installation instructions for leveling the range. • Be sure to allow 5.1cm to 10.2cm (2” to 4”) of clearance on all sides of each pan in the oven. • Do not use pans that are dented or warped.
Foods not done when cooking time is up. 	<ul style="list-style-type: none"> • Oven too cool. • Oven overcrowded. • Oven door opened too frequently. 	<ul style="list-style-type: none"> • Set oven temperature 25°F/12°C higher than suggested and bake for the recommended time. • Be sure to remove all pans from the oven except the ones to be used for baking. • Open oven door only after shortest recommended baking time.

Setting Oven Controls (cont'd)

To Set for Broiling:

Note: For optimum browning results when broiling, preheat the broil element for 3 to 4 minutes.

1. Arrange the oven rack while oven is still cool. Position the rack as suggested in the **Broil Rack Position Table** below.
2. Press **Broil** pad. “— —” will appear in display.
3. Press and hold the  or  pad until the desired broil setting level appears in the display. Press the  pad for **HI** broil or the  pad for **LO** broil. Most foods may be broiled at the **HI** broil setting. Select the **LO** broil setting to avoid excess browning or drying of foods that should be cooked to the well-done stage.
4. Preheat for 5 minutes before broiling.
4. Place the insert on the broil pan (not supplied with appliance), then place the food on the insert (See Fig. 1). **DO NOT** use the broil pan without the insert or cover the insert with **aluminum foil**. The exposed fat could ignite.
5. Place the pan on the oven rack. **Open the oven door to the broil stop position** (See Fig. 2).
6. Broil on one side until food is browned. Turn and broil food on 2nd side.
Note: Always pull the oven rack out to the stop position before turning or removing the food.
7. When broiling is finished, press  pad.

Broil Rack Position Table (Refer to Figure 3)

Note: It is recommended to cook food 3 to 5 inches away from the broil element.

Rack Position	Food category
4th rack position	Medium-rare steaks & hamburgers
3rd rack position	Fish, medium steaks & pork chops
3rd rack position	Well-done foods such as chicken & lobster

CAUTION Should an oven fire occur, close the oven door and turn the oven OFF. If the fire continues, use a fire extinguisher. **DO NOT** put water or flour on the fire. Flour may be explosive.

To Operate the Oven Light

The interior oven light will automatically turn ON when the oven door is opened. Press  pad to turn the interior oven light ON and OFF whenever the oven door is closed.

The interior oven light is located at the upper right rear wall of the oven interior and is covered with a glass shield held by a wire holder. The glass shield must be in place whenever the oven is in use. To change the interior oven light, see “Changing the Oven Light” in the **General Care & Cleaning** section.

Not supplied
with appliance

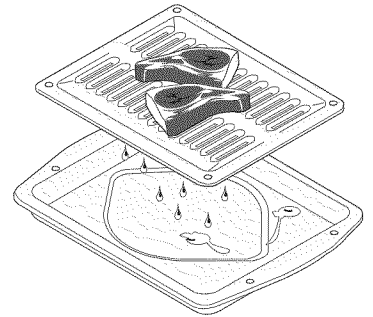

Figure 1

Note: The broiler pan and the insert are available by mail order.

Note: The broiler pan and the insert allows grease to drain and be kept away from the high heat of the broiler. **DO NOT** use the pan without the insert. **DO NOT** cover the insert with foil; the exposed grease could ignite.

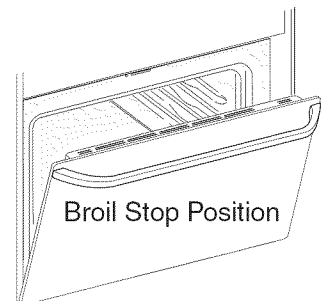

Figure 2

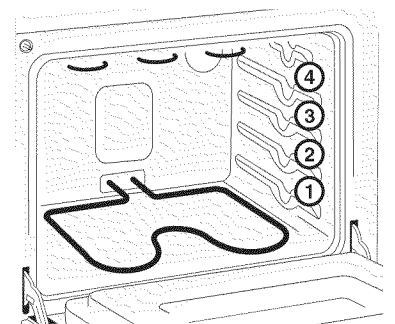

Figure 3

Setting Oven Controls (cont'd)

Setting the Warm & Hold™ Feature

The **Warm & Hold** pad turns ON the Serve Warm & Hold feature and will maintain an oven temperature of 170° F (77°C). The **Warm & Hold** feature will keep oven baked foods warm for serving up to 3 hours after cooking has finished. After 3 hours the Warm & Hold feature will shut the oven OFF automatically. The Warm & Hold feature may be used without any other cooking operations or can be set to turn ON automatically after cooking has finished using **TIMED BAKE** or **DELAY START BAKE**.

To set Warm & Hold:

1. Arrange interior oven racks and place baked food in oven. If the food is already in the oven go to step 2.
2. Press **Warm & Hold** pad. “— —” will appear in the display and the Warm & Hold indicator light above the pad will turn ON.
Note: If no further pads are touched within 25 seconds the request to turn ON Warm & Hold will be cleared.
3. Press **▲** or **▼** pad to start.
4. To turn Warm & Hold OFF at any time press **STOP** pad. The Warm & Hold indicator light above the pad will turn OFF.

To set Warm & Hold to turn ON automatically:

1. Arrange interior oven racks and place food in oven. Set the oven properly for **Timed Bake** or **Delay Start Bake**.
2. Press **Warm & Hold** pad. “— —” will appear in the display and the Warm & Hold indicator light above the pad will turn ON.
3. To turn Warm & Hold OFF at any time press **STOP** pad. The Warm & Hold indicator light above the pad will turn OFF.

Adjusting the Oven Temperature

Your oven temperature control has been precisely set at the factory. This setting may differ from your previous oven, however, so your recipe times may not give you the results you expect. If you think that the oven is cooking too hot or too cool for your recipe times, you can adjust the control so that the oven cooks hotter or cooler than the temperature displayed.

To Adjust Oven Temperature:

1. Press **Bake** pad.
2. Set the temperature to 550°F (287°C) by pressing and holding the **▲** pad.
3. Within 2 seconds, press and hold **Bake** pad until the 2 digit display appears. Release **Bake** pad. The display now indicates the amount of degrees offset between the original factory temperature setting and the current temperature setting. If the oven control has the original factory calibration, the display will read “0.”
4. The temperature can now be adjusted up or down 35°F or 19°C, in 5°F or 1°C steps by pressing and holding the **▲** or **▼** pad. Adjust until the desired amount of offset appears in the display. When lowering the oven temperature, a minus sign (-) will appear before the number to indicate that the oven will be cooler by the displayed amount of degrees.
5. When you have made the desired adjustment, press **STOP** pad to go back to the time of day display.

Note: Oven temperature adjustments made will not change the Self-Cleaning feature temperature.

Self-Cleaning

CAUTION During the Self-Cleaning cycle, the outside of the range can become very hot to the touch. **DO NOT** leave small children unattended near the appliance.

CAUTION The health of some birds is extremely sensitive to the fumes given off during the Self-Cleaning cycle of any range. Move birds to another well-ventilated room.

CAUTION DO NOT line the oven walls, racks, bottom or any other part of the range with **aluminum foil**. Doing so will destroy heat distribution, produce poor baking results and cause permanent damage to the oven interior (aluminum foil will melt to the interior surface of the oven).

CAUTION DO NOT force the oven door open. This can damage the automatic door locking system. Use caution when opening the door after the Self-Cleaning cycle is completed. The oven may still be **VERY HOT**.

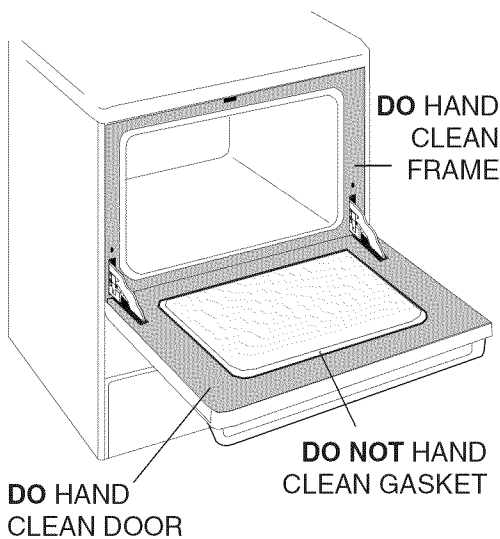

Note: See additional cleaning information for the oven door in the **General Care & Cleaning** section.

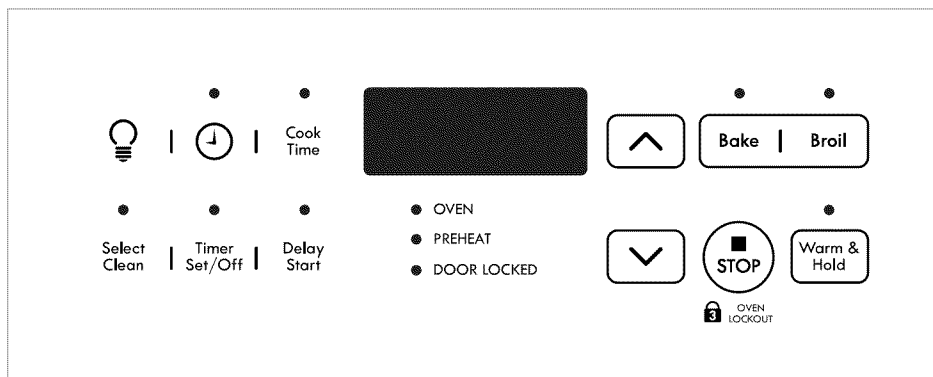

Self-Cleaning Oven

A Self-Cleaning oven cleans itself with high temperatures (well above cooking temperatures) which eliminate soils completely or reduces them to a fine powdered ash you can wipe away with a damp cloth.

Adhere to the following cleaning precautions:

- **DO NOT** use oven cleaners or oven protective coatings in or around any part of the Self-Cleaning oven.
- **DO NOT** clean the oven door gasket. The woven material of the oven door gasket is essential for a good seal. Care should be taken not to rub, damage or remove the gasket.
- **DO NOT** use any cleaning materials on the oven door gasket. Doing so could cause damage.
- **Remove all utensils and any aluminum foil. These items cannot withstand high cleaning temperatures.**
- Oven racks do not have to be removed, but remaining in the oven during the Self-Clean will turn them slightly blue and dull their finish. If left in, after the cycle is complete and the oven has cooled, rub the sides of the oven racks with wax paper or a cloth containing a small amount of salad oil (this will make the racks glide easier into the rack position).
- **Remove any excessive spillovers** in the oven cavity **before** starting the Self-Cleaning cycle. To clean, use hot, soapy water and a cloth. Large spillovers can cause heavy smoke or fire when subjected to high temperatures. **DO NOT** allow food spills with a high sugar or acid content (such as milk, tomatoes, sauerkraut, fruit juices or pie filling) to remain on the surface as they may leave a dull spot even after cleaning.
- Clean any soil from the oven frame, the door liner outside the oven door gasket and the small area at the front center of the oven bottom. These areas heat sufficiently to burn soil on. Clean with soap and water. Do not hand clean door gasket.

NOTE: Prior to setting the Self-Clean cycle, any spills remaining on the oven bottom should be removed.

What to Expect during Cleaning

While the oven is in operation, the oven heats to temperatures much higher than those used in normal cooking. Sounds of metal expansion and contraction are normal. Odor is also normal as the food soil is being removed. Smoke may appear through the oven vent.

If heavy spillovers are not wiped up before cleaning, they may flame and cause more smoke and odor than usual. This is normal and safe and should not cause alarm. If available, use an exhaust fan during the self-cleaning cycle.







Self-Cleaning (cont'd)

Self-Clean Time Length

For satisfactory results, use a 2 hour Self-Clean cycle for **light soils**, a 3 hour cycle for **average**, and a 4 hour cycle for **heavy soils**. **NOTE:** The kitchen area should be well ventilated using an open window, ventilation fan or exhaust hood during the Self-Clean cycle. This will help eliminate the normal odors associated with the Self-Clean cycle.

To Set the Controls for a Self-Clean Cycle or a Delayed Start Self-Clean Cycle:

(**Note:** If you do not want to start a **Delayed** Self-Clean Cycle, skip steps 2 & 3.)

1. Be sure the clock shows the correct time of day.
2. Press  pad. The “:” in the time of day will flash.
3. Press and hold the  pad to scroll to the time to start the delayed Self-Clean cycle. Release the pad when the desired time is displayed.
4. Press  pad. “— — —” appears in the display.
5. Press the  or  pad once. “3:00” appears in the display for a 3 hour cycle. To change to a 2 hour cycle press  pad. “2:00” appears in the display. To select a 4 hour cycle press  pad. “4:00” appears in the display.
As soon as the controls are set, the motor driven lock will begin to close automatically and the “LOCK” indicator light will flash. **DO NOT** open the oven door while the light is flashing (it takes about 15 seconds for the oven door to lock).
6. “CLn” will appear in the display during the Self-Clean cycle and the “LOCK” light will glow until the Self-Cleaning cycle is complete or cancelled and the oven temperature has cooled.

When the Self-Clean Cycle is Completed:

1. The time of day or “End” will appear in the display window and the “Clean” and “LOCK” light will continue to glow.
2. Once the oven has cooled down for about 1 HOUR and the “LOCK” light has gone out, the oven door can be opened.
3. If “End” is in the display and the Select Clean indicator light remains ON, press  pad. The time of day will appear in the display.

NOTE: When the oven is cool, wipe away any residue or powdered ash with a damp cloth or paper towel.

Stopping or Interrupting a Self-Cleaning Cycle

If it becomes necessary to stop or interrupt a Self-Cleaning cycle:

1. Press  pad.
2. Once the oven has cooled down for about 1 HOUR and the “LOCK” light has gone out, the oven door can be opened.
3. Restart the Self-Clean cycle once all conditions have been corrected.

⚠ CAUTION To avoid possible burns use care when opening the oven door after the Self-Cleaning cycle. Stand to the side of the oven when opening the door to allow hot air or steam to escape.

⚠ CAUTION DO NOT force the oven door open. This can damage the automatic door locking system. Use caution and avoid possible burns when opening the door after the Self-Cleaning cycle has completed. The oven may still be VERY HOT.

General Care & Cleaning

Cleaning Various Parts of Your Range

Before cleaning any part of the range, be sure all controls are turned OFF and the range is cool. **Remove spills and heavy soiling as soon as possible. Regular cleanings now will reduce the extent and difficulty of major cleaning later.**

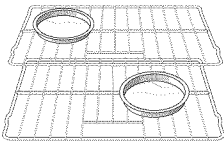
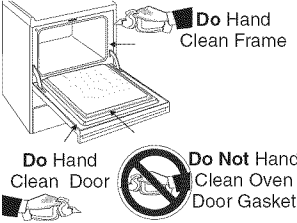
Surfaces	How to Clean
Aluminum & Vinyl Control Panel and Trim Pieces	Use hot, soapy water and a cloth. Dry with a clean cloth. Before cleaning the control panel, turn all controls to OFF and remove the control knobs. To remove, pull each knob straight off the shaft. Clean using hot, soapy water and a dishcloth. Rinse with a clean water and a dishcloth. Be sure to squeeze excess water from the cloth before wiping the panel; especially when wiping around the controls. Excess water in or around the controls may cause damage to the appliance. Be sure to rinse the cleaners as bluish stains may occur during heating and cannot be removed. To replace knobs after cleaning, line up the flat sides of both the knob and the shaft; then push the knob into place.
Glass, Painted and Plastic Body Parts, Control Knobs and Decorative Trim Pieces	Using a soft cloth, clean with mild dish detergent and water or a 50/50 solution of vinegar and water. Follow by rinsing the area with clean water; dry and polish with a soft cloth. Glass cleaners may be used if sprayed on a soft cloth first. DO NOT spray liquids directly on the control pad and display area. Do not use large amounts of water on the control panel - excess water on the control area may cause damage to the appliance. Do not use other liquid cleaners, abrasive cleaners, scouring pads, or paper towels - they will damage the finish. To remove control knobs, turn to the OFF position; grasp firmly and pull straight off the shaft. To replace knobs after cleaning, line up the flat sides of both the knob and the shaft; then push the knob into place.
Stainless Steel (some models) Oven door & drawer front panel	Clean with hot, soapy water and dishcloth. Rinse with clean water and cloth. Do not use cleaners with high concentrations of chlorides or chlorines. Do not use harsh scrubbing cleaners. Only use kitchen cleaners that are especially made for cleaning stainless steel. Always be sure to rinse the cleaners off from the surface as bluish stains may occur during heating that cannot be removed.
Porcelain Enamel Broiler Pan and Insert (some models), Door Liner, Body Parts and Warmer Drawer and Drawer Cavity.	Gentle scouring with a soapy scouring pad will remove most spots. Rinse with a 1:1 solution of clear water and ammonia. If necessary, cover difficult spots with an ammonia-soaked paper towel for 30 to 40 minutes. Rinse with clean water and a damp cloth, and then scrub with a soap-filled scouring pad. Rinse and wipe dry with a clean cloth. Remove all cleaners or the porcelain may become damaged during future heating. DO NOT use spray oven cleaners on the cooktop.
Oven Racks 	Remove racks. See "Removing and Replacing Oven Racks" under Before Setting Oven Controls . Use a mild, abrasive cleaner, following manufacturer's instructions. Rinse with clean water and dry. After cleaning the racks, rub the sides of the racks with wax paper or a cloth containing a small amount of baby oil or salad oil (this will make the racks glide easier into the rack positions).
Oven Door 	Use soap & water to thoroughly clean the top, sides and front of the oven door. Rinse well. You may use a glass cleaner on the outside glass of the oven door. DO NOT immerse the door in water. DO NOT spray or allow water or the glass cleaner to enter the door vents. DO NOT use oven cleaners, cleaning powders or any harsh abrasive cleaning materials on the outside of the oven door. DO NOT clean the oven door gasket. The oven door gasket is made of a woven material, on Self-Cleaning models, which is essential for a good seal. Care should be taken not to rub, damage or remove this gasket.
Surface Elements and Drip Bowls (Models with Coil Surface Elements)	Surface elements can be unplugged and removed to make cleaning the drip bowls easier. The surface elements clean themselves when they are turned on. Food spilled on a hot element will burn off. Food spilled on a cold element can be cleaned with a damp cloth—any remaining soil will burn off the next time element is used. NEVER IMMERS A SURFACE ELEMENT IN WATER. To remove surface element and drip bowls, follow the instructions under General Care & Cleaning . To clean drip bowls, wash in hot, soapy water or in the dishwasher. Rinse and dry while still warm. Hard-to-remove, burned-on soils can be removed by soaking the drip bowls for about 20 minutes in a slightly diluted liquid cleanser or solution made of equal parts ammonia and water. A nylon scrubber may be used after soaking. DO NOT use abrasive cleanser or steel wool, as they will scratch the surface. Always rinse with clean water and polish, and dry with a soft cloth. To replace drip bowls and surface elements, follow the instructions under General Cleaning .

General Care & Cleaning (cont'd)

Models with Coil Surface Elements

Porcelain Enamel Cooktop Cleaning Instructions

⚠ WARNING Do not use a cooktop cleaner on a hot cooktop. The fumes can be hazardous to your health, and can chemically damage the cooking surface.

⚠ CAUTION Before cleaning the surface cooktop, be sure the controls are turned to OFF and the cooktop is cool.

⚠ CAUTION DO NOT use commercial oven cleaners on the exterior surfaces including rangetop and door frame.

Correct and consistent cleaning is essential to maintaining your porcelain enamel cooktop. If food spills and grease spatters are not removed, they may burn onto the surface of the cooktop and cause permanent discoloration.

Daily Cleaning

For normal soil:

1. Allow cooktop surface to cool.
2. Wipe off spills and spatters using a clean paper towel or a clean cloth with warm, soapy water.
3. If needed, use a **non-abrasive** plastic type **no-scratch** pad or other mild household cleaners.
4. Be sure to rinse off the cleaners or the porcelain may become damaged during future heating.

For heavy, burned-on soil:

1. Allow cooktop surface to cool.
2. Use a soap filled scouring pad with warm water or cover heavily soiled spots with a solution of clear water and ammonia. Scour gently. Rinse and wipe dry with a clean cloth.
3. If any soil remains, apply a few drops of a recommended cooktop cleaning cream on the spots and rub gently using a clean damp cloth or scouring pad. Buff with a dry cloth until all soil and cream are removed. Frequent cleaning with the cooktop cleaning cream leaves a protective coating which helps in preventing scratches and abrasions.

For sugary spillovers:

Sugary spills can chemically damage your cooktop surface. Therefore, you must begin cleaning the spills while the cooktop is still hot. Use caution when following the steps below.

1. Turn off all surface units and remove all pans immediately.
2. Put on an oven mitt, wipe up carefully or move hot spills away from the element area with a clean damp cloth.
3. Allow the cooktop to cool. Follow the instructions above for heavy, burned-on soil.

SURFACES	CLEANING AGENTS	INSTRUCTIONS
Porcelain enamel (cooktop, surface under cooktop)	Mild cleaners or non-abrasive plastic type no-scratch pad	Use a damp sponge or dampened soap pad, rinse and dry.
Broil Insert Control Panel	Hot, soapy water or cleaner cream.	Use a clean soapy, dampened cloth or paper towel, remove soil and dry. Do not use abrasive products.

Coil Surface Element

To Remove and Replace Surface Elements and Drip Bowls

ATTENTION: Never leave lids on the coil elements as they could be permanently damaged if the coil is turned on by accident.

Prior to cleaning the drip bowls make sure the coil elements are cold and the control knobs are turned to OFF

Coil elements clean themselves when they are turned on.

Coil elements and drip bowls are removable and allow you to clean the drip bowls.

To remove a coil element, push against the front edge and lift element up and out.

To clean by hand, wash the drip bowls in hot sudsy water. For hard to remove spots, use nylon scrubber with soap. Rinse and dry while still warm.

⚠ CAUTION Never immerse coil elements in water.

⚠ CAUTION Be careful not to bend terminal ends when replacing elements after cleaning.

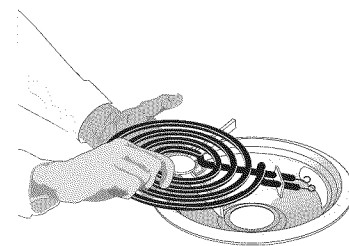

General Care & Cleaning (cont'd)

Models with Coil Surface Elements (cont'd)

To Raise the Top for Cleaning

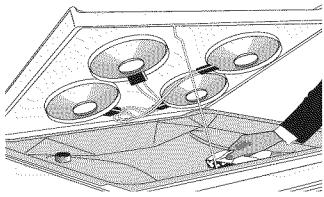

A rod swings up to support the top for cleaning underneath.

1. Grasp the sides and lift from the front. A lift-up rod will support the top in its raised position. Only lift the top high enough to allow the support rod to rest in place under the front of the cooktop.
2. Clean underneath using a clean cloth and hot, soapy water.
3. To lower the top, lift the top slightly and lower the rod. Lower the range top down into the range frame.

CAUTION When lowering the lift-up range top, grasp the sides with fingertips only. Be careful not to pinch fingers. **DO NOT** drop or bend the range top when raising or lowering. This could damage the surface.

Models with Ceramic Glass Cooktop

Ceramic Glass Cooktop Cleaning & Maintenance

Consistent and proper cleaning is essential to maintaining your Ceramic glass cooktop

Prior to using your cooktop for the first time, apply the recommended CookTop® Cleaning Creme to the ceramic surface (on the web visit www.sears.com for replacement cooktop cleaner, item number 40079). Buff with a **non-abrasive** cloth or **no-scratch** cleaning pad. This will make cleaning easier when soiled from cooking. The special cooktop cleaning cream leaves a protective finish on the glass to help prevent scratches and abrasions.

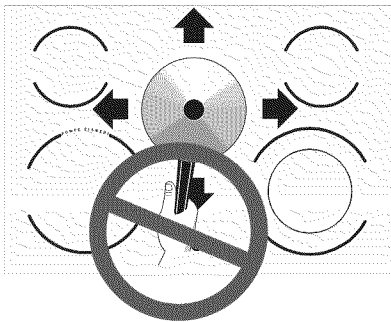

Sliding aluminum or copper clad bottom pans on the cooktop can cause metal markings on the cooktop surface. These marks should be removed **immediately** after the cooktop has cooled using the cooktop cleaning cream. Metal marks can become permanent if not removed prior to future use.

Cookware (cast iron, metal, ceramic or glass) with rough bottoms can mark or scratch the cooktop surface. **Do not slide anything metal or glass** across the cooktop. **Do not** use your cooktop as a cutting board or work surface in the kitchen. **Do not** cook foods directly on the cooktop surface without a pan. **Do not** drop heavy or hard objects on the glass cooktop, because they may cause it to crack.

Cleaning Recommendations for the Ceramic Glass Cooktop

CAUTION Before cleaning the cooktop, be sure the controls are turned to **OFF** and the cooktop is **COOL**.

WARNING **DO NOT** use a cooktop cleaner on a hot cooktop. The fumes can be hazardous to your health, and can chemically damage the ceramic glass surface.

For light to moderate soil:

Apply a few drops of CookTop® Cleaning Creme directly to the cooktop. Use a paper towel or use a **non-abrasive** plastic type **no-scratch** pad to clean the entire cooktop surface. Make sure the cooktop is cleaned thoroughly, leaving no residue.

For heavy, burned on soil:

Apply a few drops of CookTop® Cleaning Creme directly to the soiled area. Rub the soiled area using a **non-abrasive** plastic type **no-scratch** pad, applying pressure as needed. Do not use the pad you use to clean the cooktop for any other purpose. If soils remain, carefully scrape soils with a metal razor blade scraper, holding scraper at a 30 degree angle to the surface. Remove loosened soils, then apply a few drops of cleaning cream and buff surface clean.

IMPORTANT NOTE: Damage to the ceramic glass cooktop may occur if you use an abrasive type scratch pad. Only use cleaning products that have been specifically designed for ceramic glass cooktop.

Plastic or foods with a high sugar content:

These types of soils need be removed immediately if spilled or melted onto the ceramic cooktop surface. Permanent damage (such as pitting of the cooktop surface) may occur if not removed **immediately**. After turning the surface elements **OFF**, use a razor blade scraper or a metal spatula with a mitt and scrape the soil from the hot surface (as illustrated).

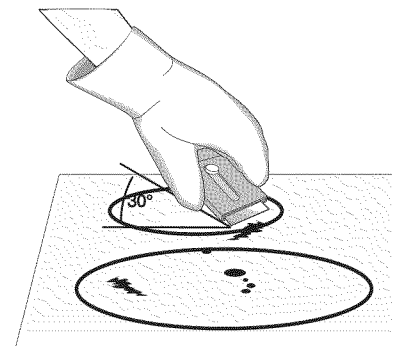

General Care & Cleaning (cont'd)

Models with Ceramic Glass Cooktop (cont'd)

Do not use the following on the ceramic glass cooktop:

- Do not use abrasive cleaners and scouring pads, such as metal and some nylon pads. They may scratch the cooktop, making it more difficult to clean.
- Do not use harsh cleaners, such as chlorine bleach, ammonia or oven cleaners, as they may etch or discolor the cooktop.
- Do not use dirty sponges, cloths or paper towels, as they can leave soil or lint on the cooktop which can burn and cause discoloration.

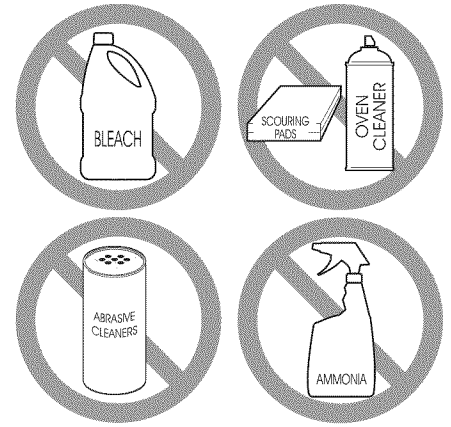

Special Caution for Aluminum Foil and Aluminum Cooking Utensils

- **Aluminum foil**
Use of aluminum foil will damage the cooktop. Do not use under any circumstances.
- **Aluminum utensils**
Since the melting point of aluminum is much lower than that of other metals, care must be taken when aluminum pots or pans are used. Pans that boil dry may permanently damage cooktop by breaking, fusing to, or marking it.

Care and Cleaning of Stainless Steel (Stainless Steel models only)

Some models are equipped with stainless steel exterior parts. Special care and cleaning are **required** for maintaining the appearance of stainless parts. Please refer to the table provided at the beginning of the **General Care & Cleaning** section in this Use & Care Guide.

Storage Drawer

Use the storage drawer for storing cooking utensils. The drawer can be removed to facilitate cleaning under the range. Use care when handling the drawer.

Removing and Replacing Storage Drawer

To remove the drawer:

1. Pull empty drawer out to the roller guide stop.
2. Tilt the drawer up and pull it out over the rollers.

To replace the drawer:

1. Insert the rear end of the drawer into the opening.
2. Fit the drawer end rollers onto the guide rails.
3. Push the drawer in until it stops, then lift to allow the rollers to clear the roller guide stop, and push in.

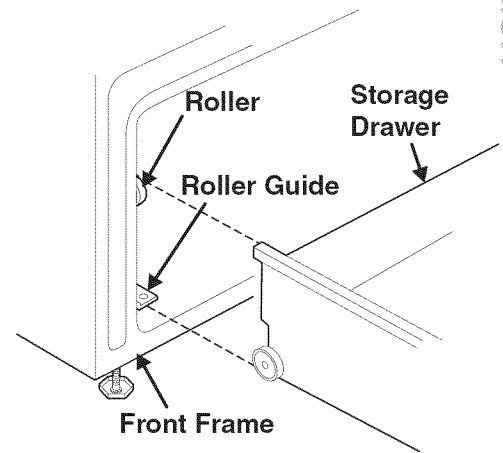

Changing Oven Light

⚠ CAUTION Be sure the oven is unplugged and all parts are COOL before replacing the oven light bulb. Do not turn the oven light on during a self-cleaning cycle. High temperature will reduce lamp life.

On some models an interior oven light will turn on automatically when the oven is opened.

The oven light may be turned on when the door is closed by using the oven light switch located on the Electronic Oven control.

The oven light bulb is covered with a glass shield held in place by a wire holder.

THIS GLASS SHIELD MUST ALWAYS BE IN PLACE WHEN THE OVEN IS IN USE.

To Replace the Light Bulb:

⚠ CAUTION BE SURE OVEN IS COOL

1. Turn the power off at the main source.
2. Wear a leather-faced glove for protection against possible broken glass.
3. Replace bulb with a 40 Watt appliance bulb only.
4. Press wire holder to one side to release glass shield, change bulb and be sure to replace glass shield.

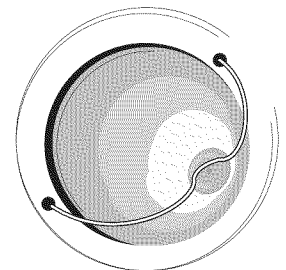

General Care & Cleaning (cont'd)

Removing and Replacing the Lift-Off Oven Door

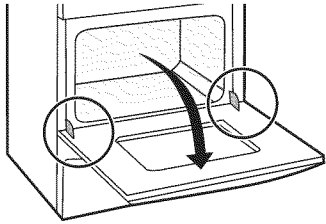

Door Hinge locations
with oven door fully open

Fig. 1

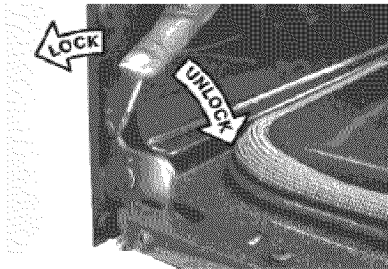

Fig. 2

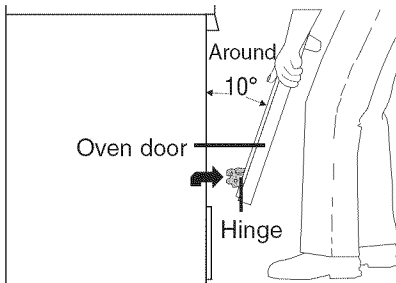

Fig. 3

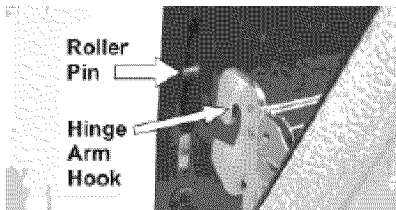
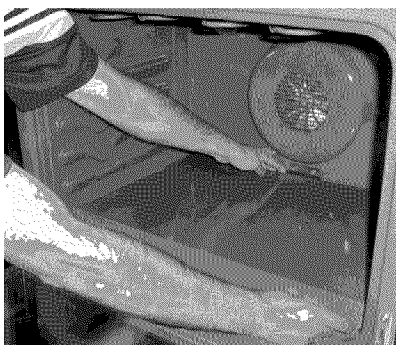

Fig. 4



⚠ CAUTION The door is heavy. For safe, temporary storage, lay the door flat with the inside of the door facing down.

To Remove Oven Door:

1. Open oven door completely (horizontal with floor - See Fig. 1).
2. Pull the door hinge locks on both left and right door hinges down from the oven frame completely towards the oven door (See Fig. 2). A tool such as a small flat-blade screwdriver may be required.
3. Firmly grasp both sides of oven door along the door sides (Do not use the oven door handle - See Fig. 3).
4. Close the door to the broil stop position (the oven door will stop into this position just before fully closing).
5. With the oven door in the broil stop position, lift the oven door hinge arms over the roller pins located on each side of the oven frame (See Fig. 4).

To Replace Oven Door:

1. Firmly grasp both sides of oven door along the door sides (Do not use the oven door handle - See Fig. 3).
2. Holding the oven door at the same angle as the removal position, seat the hook of the hinge arm over the roller pins located on each side of the oven door frame (See Fig. 4). The hook of the hinge arms must be fully seated onto the roller pins.
3. Fully open the oven door (horizontal with floor - See Fig. 1).
4. Push the door hinge locks up towards and into the oven frame on both left and right oven door hinges (See Fig. 2) to the locked position.
5. Close the oven door.

Special Door Care Instructions - Most oven doors contain glass that can break.

Read the following recommendations:

1. Do not close the oven door until all the oven racks are fully in place.
2. Do not hit the glass with pots, pans, or any other object.
3. Scratching, hitting, jarring or stressing the glass may weaken its structure causing an increased risk of breakage at a later time.

To Remove the "Hidden Bake" Cover (some models)

1. In order to remove the "hidden bake" cover, pull the back edge with one hand about ½ inch and lift up the "hidden bake" cover with both hands. (See picture)
2. When re-installing the "hidden bake" cover, be sure to put it all the way to the back of the oven and lay it down on the 2 shoulder screws. Then push the front edge of the cover in its place below the front bracket.

To have easier access to the "hidden bake" cover, you can remove the oven door by following the instructions on previous page.

IMPORTANT: Always replace the "hidden bake" cover before the next use.

Before you call

Solutions to Common Problems

Before you call for service, review this list. It may save you time and expense. The list includes common occurrences that are not the result of defective workmanship or materials in this appliance.

OCCURRENCE	POSSIBLE CAUSE/SOLUTION
Oven Control Beeps and Displays any F code error (example F11).	Electronic control has detected a fault condition. Press STOP to clear the display and stop the beeping. Reprogram the oven. If a fault reoccurs, record the fault number. Press STOP and call Sears or another qualified servicer.
d-O is displayed.	The door was left open and controls set for self-cleaning cycle. Simply close the door.
Range not level. Bad cooking results.	Place oven rack in center of oven. Place a level on the oven rack. Adjust leveling legs at base of range until the rack is level. Contact installing agent if rack and cabinet cutout flooring are not level. Kitchen cabinet misalignment may make oven appear to be not level. Be sure cabinets are square and level. Contact cabinet maker to correct problem.
Adjust leveling legs at base of range until the rack is level.	Cabinets not square or are built in too tight. Contact a cabinet maker to correct the problem. Contact builder or installer to make appliance accessible. Carpeting interferes with range. Provide sufficient space so range can be lifted over carpet.
Entire oven does not operate.	When the oven is first plugged in, or when the power supply to the oven has been interrupted, the display will flash. The oven cannot be programmed until the clock is set. Be sure electrical cord is securely connected into the electrical junction box. Cord/plug is not installed and/or connected. Cord is not supplied with oven. Contact Sears or another qualified servicer. Service wiring not complete. Contact Sears or another qualified servicer. Power outage. Check house lights to be sure. Call your local electric company. Short in cord/plug. Replace cord/plug. Controls are not set properly. See instructions under Setting Oven Controls to set the controls. House fuse has blown or circuit breaker has tripped immediately following installation. House fuse may not be fully engaged. Check fuse and screw or engage circuit breaker securely.
Surface element does not heat.	No power to the appliance. Check steps under "Entire range or oven does not operate" in this Before You Call checklist. Too low heat setting. Turn control to a slightly higher setting until element comes on. Incorrect control is on. Be sure to use correct control for the element to be used.
Surface element too hot or not hot enough.	Incorrect control setting. Raise or lower setting until proper amount of heat is obtained. Dial markings are an indicator of relative heat settings and will vary slightly. Voltage is incorrect. Be sure appliance is properly connected to the power source specified in the installation instructions. If you are not sure about this requirement call 1-800-4-MY-HOME® for service (See back cover). Lightweight or warped pans were used. Be sure to use proper cookware. Use only flat bottom, evenly balanced medium or heavyweight cookware. Heavy and medium weight pans heat evenly. Because lightweight pans heat unevenly, foods may burn easily.
Surface element turns off by itself.	This is normal. The element temperature rises gradually and evenly. As the temperature rises, the element will glow red. To maintain the selected setting, the element will cycle ON and OFF. The heating element retains enough heat to provide a uniform and consistent heat during the OFF cycle.
Food not heating evenly.	Lightweight or warped pans were used. Be sure to use proper cookware. Use only flat bottom, evenly balanced medium or heavyweight cookware. Heavy and medium weight pans heat evenly. Because lightweight pans heat unevenly, foods may burn easily. Incorrect control setting. Raise or lower setting until proper amount of heat is obtained.
Drip bowls are pitting or rusting.	Foods with acids, such as tomatoes, if allowed to stand in/on bowls will cause corrosion. Remove and wash drip bowls as soon as possible after a spillover. Normal environment. Houses along sea coast are exposed to salt air. Protect bowls as much as possible from direct exposure to salt air.

OCCURRENCE	POSSIBLE CAUSE/SOLUTION
Drip bowls turning color or distorted out of shape.	Bottom surface of cookware extends beyond surface elements and touches cooktop surface. This can cause high enough temperatures to discolor the drip bowls. DO NOT use cookware of this type. Pan sizes should be matched to the size of the element. Replacement drip bowls may be purchased from Sears Parts & Repair.
Scratches or abrasions on cooktop surface.	Surface elements not seated properly in terminal. Turn control to OFF. Be sure surface element is COOL. Lift out surface element. Position element properly, following instructions under General Care & Cleaning .
Scratches or abrasions on cooktop surface.	Coarse particles such as salt or sand between cooktop and utensils can cause scratches. Be sure cooktop surface and bottoms of utensils are clean before usage. Small scratches do not affect cooking and will become less visible with time.
Scratches or abrasions on cooktop surface.	Cleaning materials not recommended for ceramic-glass cooktop have been used. See “ Ceramic Glass Cooktop Cleaning & Maintenance ” section under General Care & Cleaning.
Scratches or abrasions on cooktop surface.	Cookware with rough bottom has been used. Use smooth, flat-bottomed cookware.
Metalmarks.	Sliding or scraping of metal utensils on cooktop surface. Do not slide metal utensils on cooktop surface. Use a ceramic-glass cooktop cleaning cream to remove the marks. See “ Ceramic Glass Cooktop Cleaning & Maintenance ” section under General Care & Cleaning.
Brown streaks or specks.	Boilovers are cooked onto surface. Use razor blade scraper to remove soil. See “ Ceramic Glass Cooktop Cleaning & Maintenance ” section under General Care & Cleaning.
Areas of discoloration with metallic sheen.	Mineral deposits from water and food. Remove using a ceramic glass cooktop cleaning cream. Use cookware with clean, dry bottoms.
Oven light does not work.	Burned-out or loose bulb. Follow the instructions under Changing Oven Light to replace or tighten the bulb.
Fan noise during cooking operation.	A cooling fan may automatically turn on and off to cool internal parts. This is normal, and the fan may continue to run even after oven has been turned OFF, but may also stop immediately and then turn ON after a while.
Oven smokes excessively during broiling.	Oven door is closed. Door should be open during broiling.
Oven smokes excessively during broiling.	Meat too close to the broiler unit. Reposition the rack to provide more clearance between the meat and the broiler. Preheat broil element for quick searing operation.
Oven smokes excessively during broiling.	Meat not properly prepared. Remove excess fat from meat. Slash remaining fatty edges to prevent curling, but do not cut into the lean.
Oven smokes excessively during broiling.	Grid on broiler pan wrong-side up. Grease does not drain into broiler pan. Always place the grid on the broiler pan with the ribs up and the slots down to allow grease to drip into the pan.
Oven smokes excessively during broiling.	Broiler pan used without grid or grid cover with foil. DO NOT use the broiler pan without the grid or cover the grid with foil.
Oven smokes excessively during broiling.	Oven needs to be cleaned. Grease has built up on oven surfaces. Regular cleaning is necessary when broiling frequently. Old grease or food spatters cause excessive smoking.
Poor baking results	Many factors affect baking results. See Baking for hints, causes and corrections. See Adjusting Oven Temperature .
Self-cleaning cycle does not work.	Make sure the oven door is closed.
Self-cleaning cycle does not work.	Controls not set properly. Follow instructions.
Self-cleaning cycle does not work.	Self-cleaning cycle was interrupted. Follow steps under «Stopping or Interrupting a Self-Cleaning Cycle» in the Use & care Guide.
Soil not completely removed after self-cleaning cycle is completed.	Failure to hand clean oven frame and door liner outside the oven door gasket before starting the self-clean cycle. Hand clean burned on residue with a stiff nylon brush and water or a nylon scrubber. Do not clean the oven door gasket or it will be damaged.
Soil not completely removed after self-cleaning cycle is completed.	Excessive spillovers in oven. Set the self-clean cycle for longer cleaning time.
Flames inside oven or smoke from vent.	Excessive spillovers in oven. This is normal, especially for high oven temperatures, pie spillovers or for large amounts of grease on bottom of oven. Wipe up excessive spillovers.

PROTECTION AGREEMENTS

Master Protection Agreements

Congratulations on making a smart purchase. Your new Kenmore® product is designed and manufactured for years of dependable operation. But like all products, it may require preventive maintenance or repair from time to time. That's when having a Master Protection Agreement can save you money and aggravation.

The Master Protection Agreement also helps extend the life of your new product. Here's what the Agreement* includes:

- ☑ **Parts and labor** needed to help keep products operating properly **under normal use**, not just defects. Our coverage goes **well beyond the product warranty**. No deductibles, no functional failure excluded from coverage – **real protection**.
- ☑ **Expert service** by a force of more than **10,000 authorized Sears service technicians**, which means someone you can trust will be working on your product.
- ☑ **Unlimited service calls and nationwide service**, as often as you want us, whenever you want us.
- ☑ **«No-lemon» guarantee** – replacement of your covered product if four or more product failures occur within twelve months.
- ☑ **Product replacement** if your covered product can't be fixed.
- ☑ **Annual Preventive Maintenance Check** at your request – no extra charge.
- ☑ **Fast help by phone** – we call it **Rapid Resolution** – phone support from a Sears representative on all products. Think of us as a «talking owner's manual».
- ☑ **Power surge protection** against electrical damage due to power fluctuations.
- ☑ **\$250 Food Loss Protection** annually for any food spoilage that is the result of mechanical failure of any covered refrigerator or freezer.
- ☑ **Rental reimbursement** if repair of your covered product takes longer than promised.
- ☑ **10% discount** off the regular price of any non-covered repair service and related installed parts.

Once you purchase the Agreement, a simple phone call is all that it takes for you to schedule service. You can call anytime day or night, or schedule a service appointment online.

The Master Protection Agreement is a risk free purchase. If you cancel for any reason during the product warranty period, we will provide a full refund. Or, a prorated refund anytime after the product warranty period expires. Purchase your Master Protection Agreement today!

Some limitations and exclusions apply. For prices and additional information in the U.S.A. call 1-800-827-6655.

*** Coverage in Canada varies on some items. For full details call Sears Canada at 1-800-361-6665.**

Sears Installation Service

*For Sears professional installation of home appliances, garage door openers, water heaters, and other major home items, in the U.S.A. or Canada call **1-800-4-MY-HOME**®.*

Acuerdos maestros de protección

Enhorabuena por haber hecho una compra inteligente. Su nuevo producto Kenmore® está diseñado y fabricado para brindarle años de funcionamiento fiable. Pero, como cualquier producto, puede necesitar mantenimiento preventivo o reparaciones periódicas. Es por eso que tener un Acuerdo maestro de protección podría ahorrarle dinero y molestias.

El Acuerdo maestro de protección también sirve para prolongar la durabilidad de su nuevo producto. El acuerdo* incluye lo siguiente:

- ☑ **Piezas y mano de obra** necesarias para contribuir a mantener el funcionamiento adecuado de los productos **utilizados en condiciones normales de uso**, no sólo en caso de defectos de los productos. Nuestra cobertura va **mucho más allá que la garantía del producto**. No se aplican deducibles ni exclusiones por fallas del funcionamiento: es decir, **verdadera protección**.
- ☑ **Servicio técnico por expertos** (más de **10000 técnicos autorizados de Sears**), lo cual significa que quien repare o realice el mantenimiento de su producto será un profesional de confianza.
- ☑ **Servicio técnico a escala nacional y número ilimitado de llamadas de solicitud de servicio técnico**: se puede poner en contacto con nosotros cuantas veces lo desee y cuando lo desee.
- ☑ **Garantía «sin sorpresas»**: se reemplaza el producto cubierto por el acuerdo si ocurren cuatro o más fallas del producto en un periodo de 12 meses.
- ☑ **Reemplazo del producto**: en caso de que no se pueda reparar el producto cubierto por el acuerdo.
- ☑ **Revisión anual preventiva de mantenimiento del producto**: puede solicitarla en cualquier momento, sin costo alguno.
- ☑ **Rápida asistencia telefónica**, la cual denominamos **Solución rápida**: es decir, asistencia telefónica a través de cualquiera de nuestros representantes de Sears, sobre cualquiera de nuestros productos. Piense en nosotros como en un «manual parlante del usuario».
- ☑ **Protección contra fallas eléctricas**, contra daños debidos a fluctuaciones de la corriente eléctrica.
- ☑ **\$250 al año para cubrir cualquier posible deterioro de alimentos** que haya tenido que desechar debido a una falla mecánica de cualquiera de nuestros refrigeradores o congeladores cubiertos por este acuerdo.
- ☑ **Devolución de gastos de alquiler de electrodomésticos** si la reparación de su producto asegurado toma más que el tiempo prometido.
- ☑ **10% de descuento** aplicable tanto a los costos del servicio de reparación, como de las piezas instaladas relacionadas que no hayan quedado cubiertos por este acuerdo.

Una vez que haya realizado el pago de este acuerdo, bastará una simple llamada telefónica para concertar una visita de servicio. Puede llamar a cualquier hora del día o de la noche, o bien concertar una visita de servicio por Internet.

La adquisición del Acuerdo maestro de protección es una inversión exenta de riesgos. Si por cualquier motivo decide cancelar dicho acuerdo durante el periodo de garantía del producto, le haremos un reintegro total del valor. O bien un importe proporcional si cancela el acuerdo en cualquier otro momento posterior al vencimiento del periodo de garantía del producto. ¡Adquiera hoy mismo su Acuerdo maestro de protección!

Algunas limitaciones y exclusiones podrían aplicarse. Para solicitar precios e información adicional, llame al 1-800-827-6655 (en los EE.UU.).

*** La cobertura en Canadá varía en el caso de algunos artículos. Para obtener detalles completos al respecto, llame al 1-800-361-6665 de Sears de Canadá.**

Servicio de instalación de Sears

*Para solicitar la instalación por profesionales de Sears de electrodomésticos, abridores de puertas de garaje, calentadores de agua y otros artículos de uso prioritario en el hogar, llame al **1-800-4-MY-HOME** en los EE.UU. o Canadá.*

Get it fixed, at your home or ours!

Your Home

For expert troubleshooting and home solutions advice:

manage my home

www.managemyhome.com

For repair – **in your home** – of **all** major brand appliances, lawn and garden equipment, or heating and cooling systems, **no matter who made it, no matter who sold it!**

For the replacement parts, accessories and owner's manuals that you need to do-it-yourself.

For Sears professional installation of home appliances and items like garage door openers and water heaters.

1-800-4-MY-HOME[®] (1-800-469-4663)

Call anytime, day or night (U.S.A. and Canada)

www.sears.com www.sears.ca

Our Home

For repair of carry-in items like vacuums, lawn equipment, and electronics, call anytime for the location of your nearest

Sears Parts & Repair Service Center

1-800-488-1222 (U.S.A.)

www.sears.com

1-800-469-4663 (Canada)

www.sears.ca

To purchase a protection agreement on a product serviced by Sears:

1-800-827-6655 (U.S.A.)

1-800-361-6665 (Canada)

Para pedir servicio de reparación a domicilio, y para ordenar piezas:

1-888-SU-HOGAR[®]

(1-888-784-6427)

Au Canada pour service en français:

1-800-LE-FOYER^{MC}

(1-800-533-6937)

www.sears.ca

Sears