

BOSCH

YOUR LIFE. OUR INSPIRATION.

DISHWASHER USE AND CARE MANUAL

MODEL: SHE4AM, SHE5AM, SHX3AM, SHE5AL, SHX5AL, SHX6AP

GUIDE D'ENTRETIEN ET D'UTILISATION DU LAVE-VAISSELLE

MODEL: SHE4AM, SHE5AM, SHX3AM, SHE5AL, SHX5AL, SHX6AP

MANUAL DE USO Y CUIDADO PARA LAVADORA DE PLATOS

MODEL: SHE4AM, SHE5AM, SHX3AM, SHE5AL, SHX5AL, SHX6AP



Congratulations, and Thank You from Bosch!

Thank you for selecting a Bosch dishwasher. You have joined the many consumers who demand quiet and superior performance from their dishwashers.

This manual was written with your safety and convenience in mind, and the information contained herein is very important. We highly recommend that you read this manual before you use your dishwasher for the first time.

To learn even more about your dishwasher and available accessories, as well as many other top-quality Bosch appliances, visit our website at www.boschappliances.com.

Please contact us if you have any questions or comments. Call **1-800-944-2904**, or write to:

BSH Home Appliances, Corp.
5551 McFadden Avenue
Huntington Beach, CA 92649

Enjoy!

IMPORTANT SAFETY INSTRUCTIONS	3
Dishwasher Components.....	4
Dishwasher Features and Options.....	4-5
Dishware Materials.....	6
Preparing and Loading the Dishware	6-8
Dishware Preparation	6
Loading the Dishwasher	6-8
Adding Detergent and Rinse Agent	9-10
Wash Cycles and Options.....	10
Operating the Dishwasher.....	11-13
Operating the SHX3AM	11
Operating the SHE5AM	12
Operating the SHE4AM	13
Care and Maintenance	14-16
Detailed Wash Cycle Information/Sanitized	16
Self Help.....	17-19
Customer Service	20
Statement of Warranties.....	21

⚠ Important Safety Instructions - Save This Information ⚠

NOTICE

Never use steam cleaning products to clean your dishwasher. The manufacturer will not be liable for possible damages or consequences.

Never use harsh chemicals to clean your dishwasher. Some chloride-containing cleaning products can damage your dishwasher and may present health hazards!

It is highly recommended for the end use consumer to become familiar with the procedure to shut off the incoming water supply and the procedure to shut off the incoming power supply. See the Installation Instructions or speak with your installer for more information.

WARNING

Misuse of the dishwasher can result in serious injury or death. Do not use the dishwasher in any way not covered in this manual or for any purpose other than those explained on the following pages.

Severe product damage and/or injury could result from the use of unqualified service technicians or non-original replacement parts. All repairs must be performed by a qualified service technician using only original equipment factory replacement parts.

Electrical shock or fire could result if the electrical supply for the dishwasher covered in this manual is incorrectly installed or if the dishwasher has been improperly grounded. Do not use the dishwasher covered in this manual if you are not certain the electrical supply has been correctly installed or the dishwasher has been properly grounded.

WARNING: To reduce the risk of fire, electrical shock, or serious injury, observe the following:

- This appliance must be grounded to a metal, permanent wiring system, or an equipment grounding conductor must be run with the circuit conductors and connected to the equipment grounding terminal or lead on the dishwasher. See the **Installation Instructions** included with this dishwasher for more information on electrical requirements.
- Use this dishwasher only for its intended function, which is the washing of household dishware and kitchenware.
- This dishwasher is provided with **Installation Instructions** and this **Use and Care Manual**. Read and understand all instructions before using the dishwasher.
- Use only detergents or rinsing agents recommended for use in a dishwasher, and keep them out of the reach of children.
- When loading items to be washed:
 - Locate sharp items so that they are not likely to damage the door seal.
 - Load knives and other sharp utensils with their HANDLES UP to reduce the risk of cut-type injuries.
- Do not wash plastic items unless they are marked "dishwasher safe" or the equivalent. For plastic items not so marked, check the manufacturer's recommendations.
- Do not operate your dishwasher unless all enclosure panels are in place.
- Do not tamper with or override controls and interlocks.
- Do not abuse, sit on, or stand on the door or dish racks of the dishwasher.
- To reduce the risk of injury, do not allow children to play in or on the dishwasher.
- When children become old enough to operate the appliance, it is the legal responsibility of the parents or legal guardians to ensure that they are instructed in safe practices by qualified persons.
- Under certain conditions, hydrogen gas may be produced in a hot water system that has not been used for two weeks or more. Hydrogen gas is explosive. Before using a dishwasher that is connected to a hot water system that has been unused for two weeks or longer, turn on all hot water faucets and let the water flow from each for several minutes. This will release any accumulated hydrogen gas. As the gas is explosive, do not smoke or use an open flame during this time.
- Remove the door to the washing compartment when removing an old dishwasher from service or discarding.
- To avoid floor damage and possible mold growth, do not allow wet areas to remain around or under the dishwasher.
- Protect your dishwasher from the elements. Protect against freezing to avoid possible damage to the fill valve. Damage caused by freezing is not covered by the warranty.
- When you dispose your old appliance make sure you remove the door or disable the latch.

Dishwasher Components

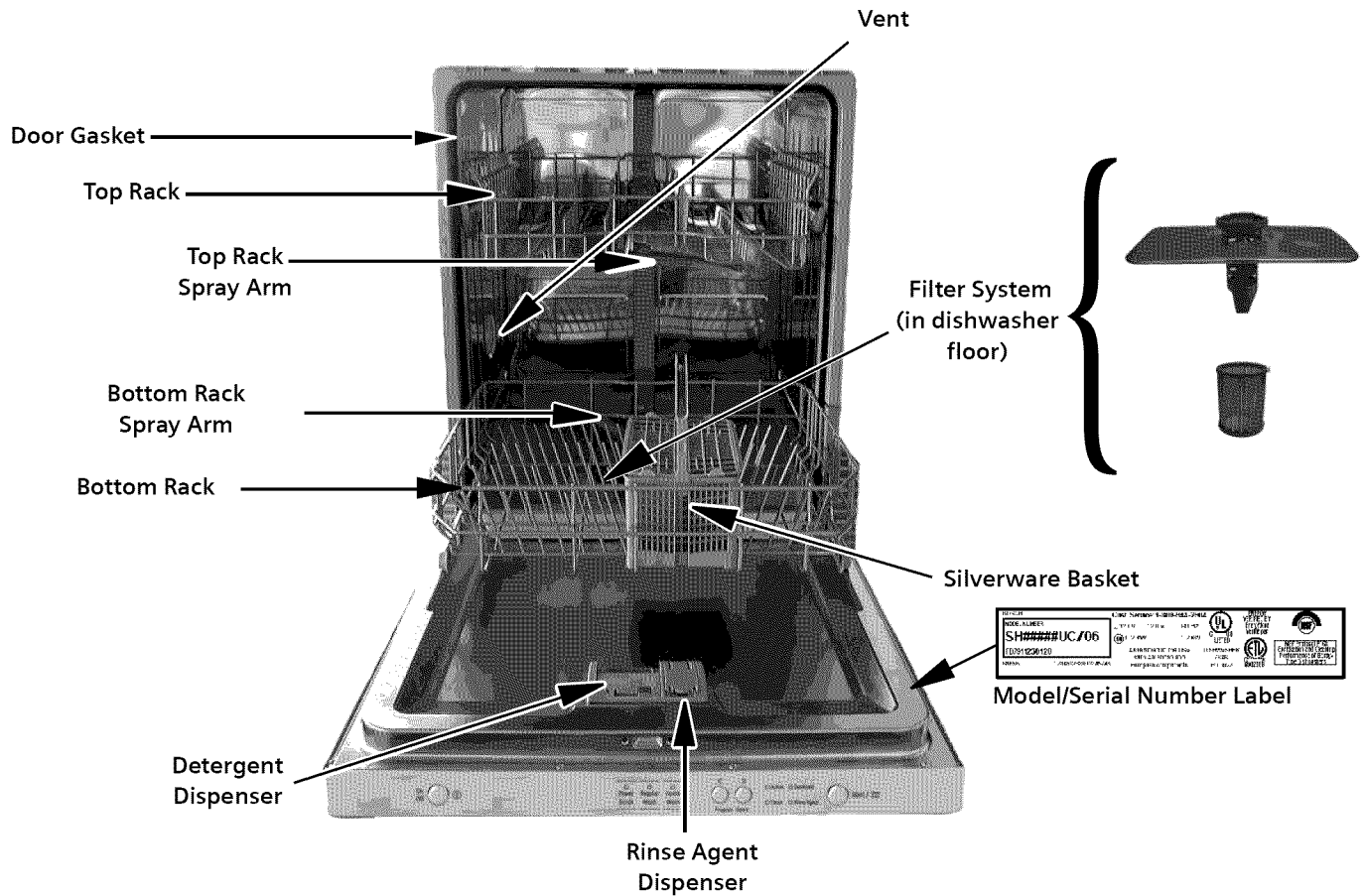

Dishwasher Features and Options

Noise Reduction System: A two-pump motor system, the Suspension Motor™, and insulation make this dishwasher one of the quietest in North America.

Nylon Coated Racks: Eliminate cuts and nicks, and have a five-year warranty.

Flow-Through Heater™: Heats water to a temperature of up to 160°F.

Condensation Drying: A high temperature final rinse, a low temperature stainless steel tub, and the sheeting action of a rinse agent result in drying that is hygienic, energy efficient, and economical.

Triple Filtration System: Three filters ensure distribution of clean water and protect the main pump and the drain pump from foreign material.

Dishwasher Features and Options

Model Number	SHX3AM	SHE5AM	SHE4AM02	SHE4AM12	SHE5AL	SHX5AL	SHX6AP
Control Panel Design	Hidden Top Control	Exposed Front Control	Exposed Front Control	Exposed Front Control	Hidden Top Control	Hidden Top Control	Hidden Top Control
Audible Cycle Completion Signal	yes	no	no	no	no	yes	yes
Clean Light	yes	no	yes	yes	yes	yes	yes
Refill Rinse Agent Indicator Light	yes	yes	yes	yes	yes	yes	yes
Sanitize Light	yes	yes	yes	yes	yes	yes	yes
Upper Rack Flip Tines	yes	yes	yes	yes	yes	yes	yes
Lower Rack Flip Tines	no	yes	no	no	no	no	no
Child Lock Button Suspension	no	yes	yes	yes	yes	no	no
Silverware Basket	standard	flexible	standard	standard	standard	standard	flexible
Height Adjustable Upper Rack	no	yes	no	yes	no	no	yes
Time Remaining Indicator	no	yes	no	no	no	no	no
Half Load	no	yes	no	yes	yes	yes	yes
Extra Dry Heat	yes	yes	yes	yes	yes	yes	yes
OPTIDRY™	no	yes	no	no	no	no	no

Dishware Materials

NOTE: Before using your dishwasher for the first time, check the information in this section. Some items are not dishwasher safe and should be hand-washed; others require special loading. Contact the item's manufacturer if you are unsure about the item's dishwasher suitability.

Recommended

Aluminum: Colored anodized aluminum may fade over time. Minerals in your water may cause the aluminum to darken or spot. This can usually be removed by using a soap-filled steel wool pad.

China, Crystal, Stoneware: Some hand-painted pieces may discolor, fade, or spot. Hand-wash these pieces. Position fragile glassware so that it will not topple over or contact other pieces during the wash cycle.

Glass: Milk glass may yellow.

Non-Stick Coatings: Apply a light coating of vegetable oil to non-stick surfaces after drying.

Plastics: Make sure the piece is dishwasher safe.

Stainless Steel, Sterling Silver, and Silver Plate: Place these pieces so that they do not contact dissimilar metals.

Not Recommended

Acrylic: Cracking (small cracks throughout the acrylic) may occur.

Adhesive-Joined Pieces: Adhesives that join materials such as plastic, wood, bone, steel copper, tin, etc. may loosen.

Bone-Handled Utensils: Handles may separate.

Iron: Iron will rust. Hand-wash and dry immediately.

Non-Dishware Items: Your dishwasher is intended for use in cleaning ONLY standard household dishware and kitchenware.

Pewter, Brass, Bronze: Pewter will tarnish. Hand-wash and dry immediately.

Tin: Tin will rust. Hand-wash and dry immediately.

Wood: Wooden bowls, wooden utensils, and wood-handled utensils can crack, warp, and lose their finish.

Preparing and Loading the Dishware

Dishware Preparation

Do not pre-wash items having loosely-attached soiling. Remove large food particles, bones, seeds, toothpicks, and excessive grease. Items having burned-on, baked-on or starchy soils may require pre-treatment.

Loading the Dishwasher

Check the Materials section of this manual if you are unsure about an item's dishwasher suitability.

Load only dishwasher-safe items into the dishwasher. Load dishes in the dishwasher racks so that the insides of bowls, pots, and pans are face downwards. Avoid nesting and contact points between dishes. Separate items of dissimilar metals.

Loading the Top Rack

Figures 1 and 2 show typical 10 and 12 place load patterns for the top rack.

NOTE: Make sure items do not protrude through the bottom of the racks and block the spray arms.

NOTICE

To avoid dishwasher damage, do not load the dishwasher with objects such as paper products, plastic bags, packing materials, or anything other than normal dishware and kitchenware.

Figure 1
10 place setting top rack

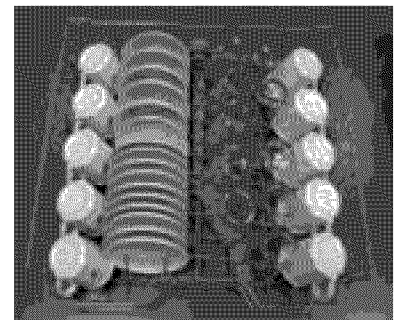

Figure 2
12 place setting top rack

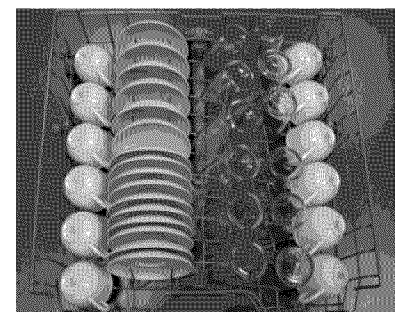

Figure 3

10 place setting bottom rack

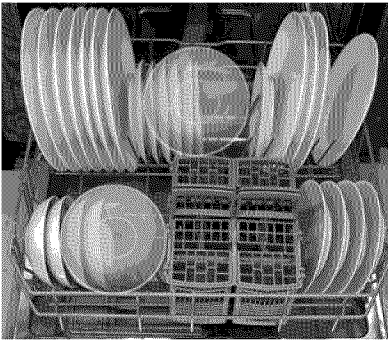

Figure 4

12 place setting bottom rack

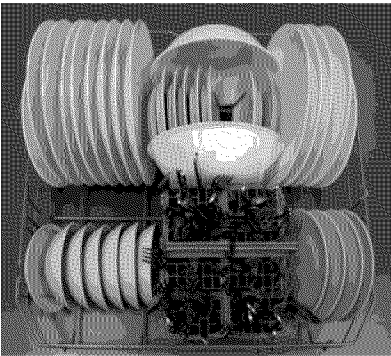

Figure 5

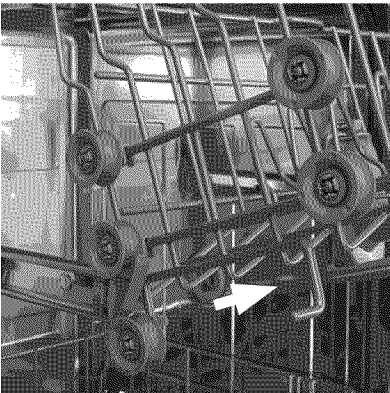

Figure 6

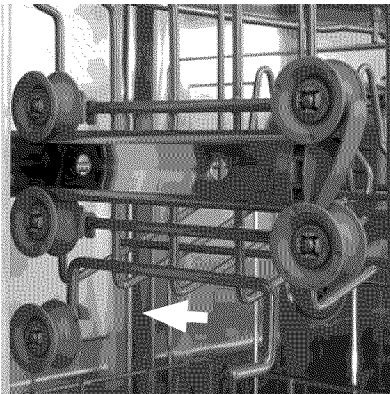
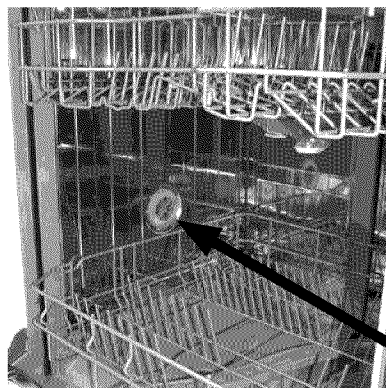

Figure 7



Do not load the dishwasher with anything other than dishwasher-safe dishware and kitchenware.

Top Rack Accessories

Top Rack Flip Tines

Flip Tines fold down to make loading the racks easier in some instances. Grasp the tines, release from notch, and fold the tines downward. When the top rack is loaded, push it into the dishwasher.

NOTE: When pushing the top rack into the dishwasher, push it until it stops against the back of the tub so the top rack spray arm will connect to the water supply in the rear of the tub. Do not push the top rack with the door.

Rack Height Adjustment (select models)

Remove the empty rack by pulling it out of the dishwasher to the point that it can be lifted upward, as shown in Figure 5. Pull the rack outward and up until the rollers are completely free of the roller guides. Re-insert the rack with the other set of rollers on the roller guides, as shown in Figure 6.

Loading the Bottom Rack

Place large items in the bottom rack. Load pots, pans and bowls upside-down. Figures 3 and 4 show typical mixed loads for the bottom rack. Do not block the vent at left side of tub (see Figure 7)

Bottom Rack Flip Tines

Flip Tines fold down to make loading the racks easier in some instances. Grasp the tines and fold them downward.

Loading the Silverware Basket

NOTE: The silverware basket tops can be folded up to accommodate large or oddly-shaped items.

With the silverware basket tops down, load the silverware basket following the patterns suggested in Figures 8 (for standard basket) and 9 (for flexible basket). Place knives with their handles up, and forks and spoons with their handles down.

If large or oddly-shaped items are to be loaded into the silverware basket with the tops up, load the items so that they do not nest together. Load knives and sharp utensils with their handles up.

CAUTION

The sharp points and edges of knives and other sharp utensils can cause serious injuries. Load knives and other sharp utensils with sharp points and edges down. Do not allow children to handle or play near knives and sharp utensils.

The Standard Silverware Basket

This basket fits in the front-middle of the lower rack.

The Flexible Silverware Basket

This basket is designed for maximum versatility. The basket splits along its length, resulting in two halves that may be placed in a variety of positions in the lower rack, greatly increasing the lower rack's loading versatility.

To split the Flexible Silverware Basket:

1. Grasp the basket as shown in Figure 10A, and slide the two halves in opposite directions, as shown in Figure 10A.
2. Pull the two halves apart, as shown in Figure 10B.

Some suggestions for placing the two halves in the lower rack are shown in Figure 11.

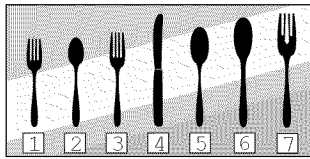
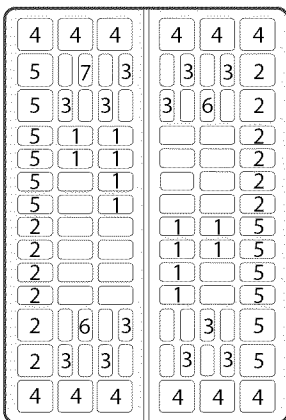
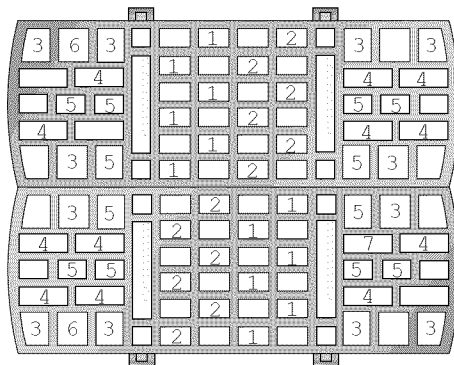

Figure 8



12 place setting
(Select Models)

Figure 9



12 place setting
(Select Models)

Figure 10

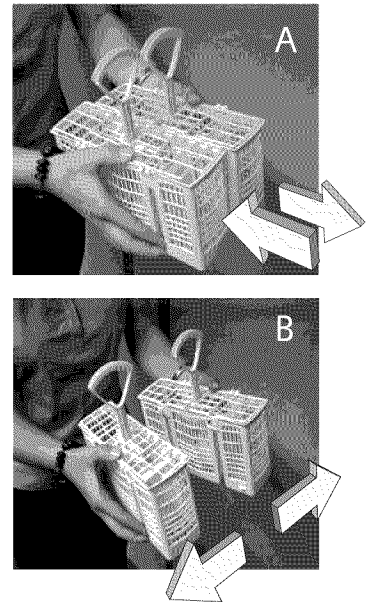

Figure 11

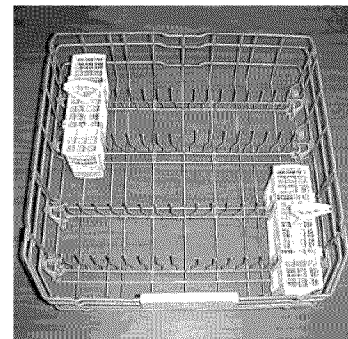
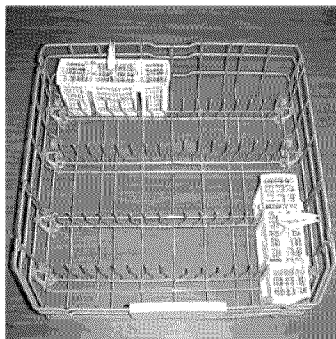
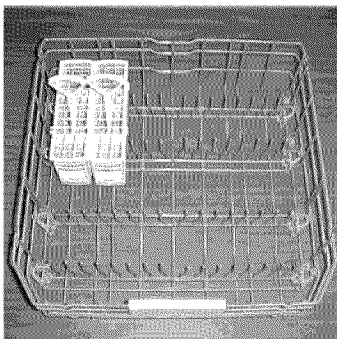
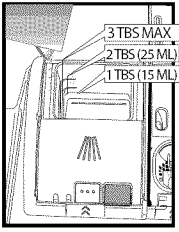
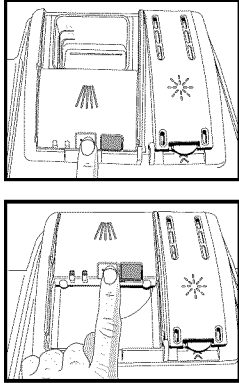

Figure 12
Add Detergent



- Use fresh powdered detergent for best results
- 1 tablespoon will clean most loads
- 3 tablespoons Max, do not overfill
- When using detergent tabs, lay them flat to avoid contact with the cover

Figure 13
To close



- Place finger as shown above, slide forward, then press down FIRMLY until you hear >CLICK<

Figure 14
To open the cover

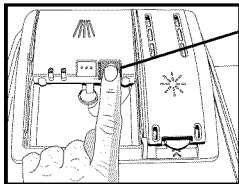

- Push button

Figure 15
To add Rinse Agent

Always use Rinse Agent even if your detergent contains Rinse Agent

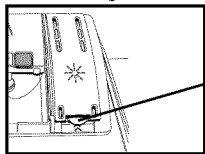

- Add Rinse Agent when the light on the control panel illuminates
- Lift tab to open

Figure 16

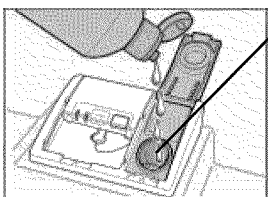

- To add Rinse Agent pour in the oval

Adding Detergent and Rinse Agent

Detergent

Use only detergent specifically designed for dishwashers. For best results, use fresh powdered dishwashing detergent.

NOTICE

To avoid dishwasher damage, do not use hand dishwashing products in your dishwasher.

This dishwasher uses less water so you need to use less detergent. With soft water, 1 tablespoon (15ml) of detergent will clean most loads. The detergent dispenser cup has lines that measure detergent to 1 tablespoon (15ml) and 1.75 tablespoons (25ml). 3 tablespoons (45ml) of detergent will completely fill the detergent dispenser cup.

NOTICE

To avoid dishware damage, do not use too much detergent if your water supply is soft. Using too much detergent in soft water may cause etching in glassware.

NOTE: If you do not know the hardness of your water supply, use 15ml of detergent. Increase the amount of detergent, if necessary, to the least amount required to get your dishware and kitchenware clean.

Use the measuring lines in the detergent dispenser cup as a guide to measure the amount of detergent recommended in Table 1.

Table 1 - Recommended Detergent Amount				
Wash Cycle	Unit	Water Type		
		Hard	Medium	Soft
Power Scrub Plus	ml	45	45	25-45
	Tbsp	3	3	1.75 to 3
Auto Wash	ml	25-45	25	15-25
	Tbsp	1.75 to 3	1.75	1 to 1.75
Regular Wash	ml	25-45	25	15-25
	Tbsp	1.75 to 3	1.75	1 to 1.75
Quick Wash/ Delicate Economy	ml	25	15-25	15
	Tbsp	1.75	1 to 1.75	1
Rinse & Hold		None	None	None

Filling the Detergent Dispenser

Fill the dispenser cup as recommend in Table 1. (See Figure 12 for additional information.)

To close, place finger as shown in Figure 13, slide forward, then press down until you hear a *click*.

To open the detergent dispenser cover, press the gray release tab as shown in Figure 14.

Adding Rinse Agents

To achieve proper drying, always use a liquid rinse agent, even if your detergent contains a rinse agent or drying additive.

Rinse Agent Dispenser

Open the rinse agent dispenser by lifting the tab with your thumb.

NOTE: The dishwasher indicates low rinse agent either by showing the symbol * in the countdown display, or illuminating the refill rinse agent light (model dependent).

Add liquid rinse agent to the dispenser as shown in Figure 16 until the rinse agent reservoir is full. Wipe up any excess rinse agent that puddles when the dispenser reservoir is full.

NOTE: After filling the rinse agent dispenser, the indicator light will go out in a few minutes after the dishwasher door is shut (select models only).

Wash Cycles (See Cycle Chart)

Always make sure your dishware is dishwasher safe. Refer to the **Dishware Materials** section of this manual for guidance.

Power Scrub Plus

Cleans items having baked-on or hard dried-on food soils. These items may require soaking or hand scouring.

Auto Wash

Cleans large loads with loosely attached food soils.

Regular

Thoroughly cleans large loads having loosely attached normal soiling.

Delicate/Economy

For delicate or heirloom dishwasher and silverware or other special items. Always make sure that the items are dishwasher safe. Refer to the Materials section of this manual for further information. Hand washing may be the best treatment of such items.

Quick Wash

For lightly soiled items with easy to remove food soils.

Rinse and Hold

Allows you to rinse the food soil off of a partial load and hold them in the dishwasher until there is a full load.

Dishware Drying

At the end of the cycle the dishwasher will stop and a period of condensation drying will follow.

Wash Cycle Options

OPTIDRY™

This feature senses when the unit is low on Rinse Agent and automatically increases the drying time. For best performance, always use a liquid Rinse Agent even if your detergent contains a drying additive.

Half Load

In the Power Scrub Plus, Regular, Auto wash and Delicate/Economy cycles you can reduce the energy and water consumption when washing small, lightly soiled loads that fill approximately half of the dishwasher's capacity. To activate, select the Half Load button in addition to Power Scrub Plus, Regular, Auto wash or Delicate/Economy cycle.

Delay Start

This option allows you to delay the start time of your dishwasher.

Sanitized Light

When the Sanitized light appears, it means that the dishware and kitchenware that was just washed has been sanitized according to the requirements of the National Sanitation Foundation (NSF). For more information on NSF certification, refer to the Wash Cycle Information section of this manual.

Unloading the Dishwasher

Unload the bottom rack first. Unload the silverware basket(s). They are easily removed for unloading. Unload the top rack.

	Wash Cycles					
	Power Scrub Plus	Auto Wash	Regular	Delicate / Econo	Quick Wash	Rinse and Hold
SHX3AM	X		X		X	
SHE5AM	X	X	X	X	X	
SHE4AM0	X		X		X	X
SHE4AM1	X	X	X		X	
SHE5AL	X	X	X	X	X	
SHX5AL	X	X	X	X	X	
SHX6AP	X	X	X	X	X	X

OPERATING THE SHX3AM, SHX5AL, & SHX6AP

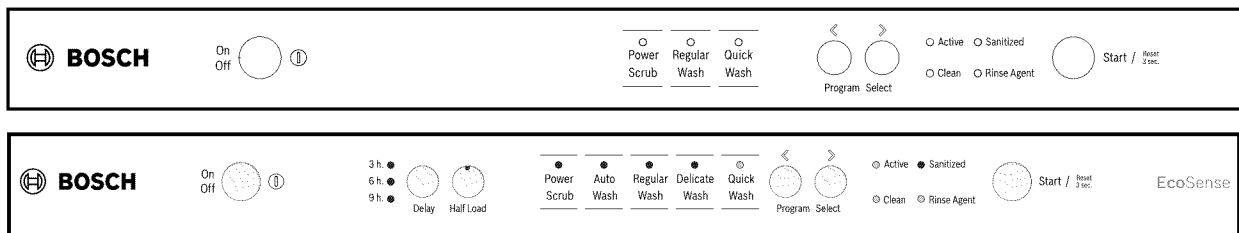

⚠ WARNING

You could be seriously scalded if you allow hot water to splash out of the dishwasher. **OPEN THE DOOR CAREFULLY** during any wash or rinse cycle. Do not fully open the door until water noises have stopped.

To Start Unit:

- Door must be open. Press the "ON/OFF" button to turn the unit on.
- One of the Wash Cycle Indicator Lights will be flashing to show you are in the Wash Cycle selection mode.
- Press the "<" or ">" button to select the desired wash cycle.
- Press the "START" button (Wash Cycle Indicator Light will stop flashing)
- Close the door to start the cycle

Note: Rinse Agent Indicator Light will be illuminated if the unit needs Rinse Agent.

Note: If you close the door without pressing the start button the unit will beep.

To Cancel the Cycle:

- Open the door just far enough to expose the controls. Be careful of water Splash Out!
- Press and hold the "START/RESET" button until the "Active" Indicator Light goes out.
- Close the door and wait for about 1 minute for the dishwasher to drain.
- Open the door and press the "ON/OFF" button.
- You are now ready to start a new cycle.

Setting Options (Rinse Agent Amount / Extra Dry Heat Activation / Cycle Completion Signal Tone Level)

- Door must be open. Press the "ON/OFF" button to turn the unit on.
- One of the Wash Cycle Indicator Lights will be flashing to show you are in the Wash Cycle selection mode.
- To enter the Options Setup Mode, press and hold down the ">" button, then press and release the "START RESET" button, then release the ">" button.
- The "Clean" Indicator Light and at least one addition Indicator Light will be flashing to show you are in the Options Setup Mode.
- Press the ">" button to select the option you would like to adjust.
 - If the "CLEAN" and "RINSE AGENT" Indicator Lights are flashing you are ready to set the amount of Rinse Agent the unit will dispense.
 - If the "CLEAN" and "SANITIZED" Indicator Lights are flashing you are ready to turn your Extra Dry Heat option on/off.
 - If the "CLEAN" and "SANITIZED" and "RINSE AGENT" Indicator Lights are flashing you are ready to set the Cycle Completion Signal Tone Level.

To Set the Amount of Rinse Agent Dispensed

NOTE: If your glasses have spots you need more Rinse Agent. If your glasses have streaks you need less Rinse Agent.

- With the "CLEAN" and "RINSE AGENT" Indicator Lights flashing.
- Press the "<" button to change the amount of Rinse Agent Dispensed.
- As you press the "<" button you will notice the Wash Cycle Indicator Lights illuminating.
 - If none of the Wash Cycle Indicator Lights are illuminated, the Rinse Agent Dispenser is turned off.
 - If one of the Wash Cycle Indicator Lights are illuminated, the Rinse Agent Dispenser is set to deliver the lowest charge of Rinse Agent.
 - If two of the Wash Cycle Indicator Lights are illuminated, the Rinse Agent Dispenser is set to deliver a medium charge of Rinse Agent.
 - If three of the Wash Cycle Indicator Lights are illuminated, the Rinse Agent Dispenser is set to deliver the largest charge of Rinse Agent.
- Press "START" to save your settings.

To Turn the Extra Dry Heat On or Off

- With the "CLEAN" and "SANITIZED" Indicator Lights flashing.
- Press the "<" button to change the Extra Dry Heat setting.
- As you press the "<" button you will notice the Wash Cycle Indicator Lights illuminating.
 - If none of the Wash Cycle Indicator Lights are illuminated, the Extra Dry Heat option is turned off.
 - If one of the Wash Cycle Indicator Lights are illuminated, the Extra Dry Heat is turned on.
- Press "START" to save your settings.

To Set the Cycle Completion Signal Tone Level

- With the "CLEAN" and "SANITIZED" and "RINSE AGENT" Indicator Lights flashing.
- Press the "<" button to change the Cycle Completion Signal Tone Level.
- As you press the "<" button you will notice the Wash Cycle Indicator Lights illuminating and the Cycle Completion Signal Tone level changing.
 - If none of the Wash Cycle Indicator Lights are illuminated, there will be no tone. The Cycle Completion Signal is turned off.
 - If one of the Wash Cycle Indicator Lights are illuminated, there will be a low Cycle Completion Signal Tone Level.
 - If two of the Wash Cycle Indicator Lights are illuminated, there will be a medium Cycle Completion Signal Tone Level.
 - If three of the Wash Cycle Indicator Lights are illuminated, you will be at the maximum Cycle Completion Signal Tone Level.
- Press "START" to save your settings.

OPERATING THE SHE5AM & SHE5AL

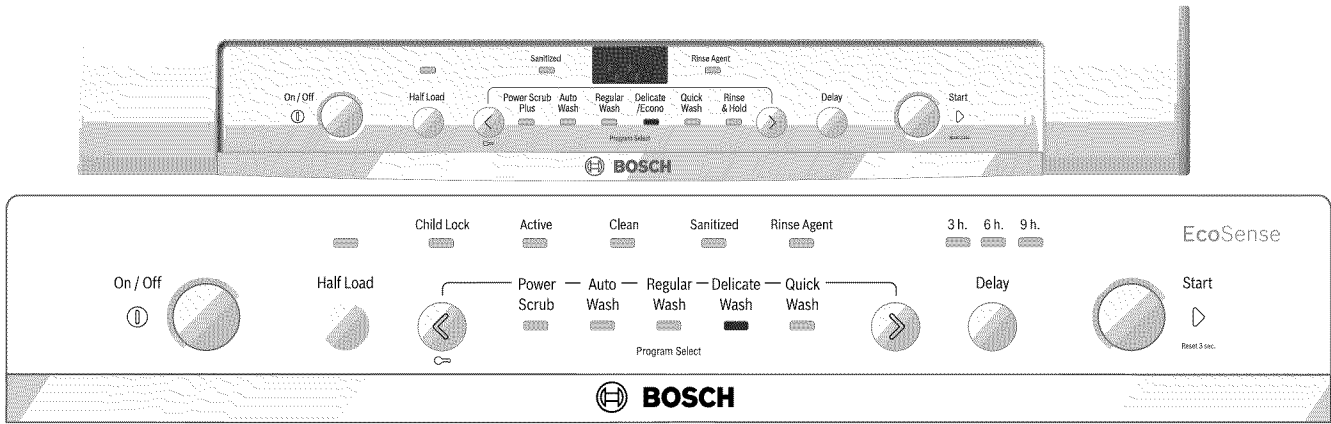

⚠ WARNING

You could be seriously scalded if you allow hot water to splash out of the dishwasher. **OPEN THE DOOR CAREFULLY** during any wash or rinse cycle. Do not fully open the door until water noises have stopped.

To Start Unit:

- Door must be closed. Press the "ON/OFF" button to turn the unit on.
- The Countdown Display and one of the Wash Cycle Indicator Lights will be flashing to show you are in the Wash Cycle selection mode.
- Press the "<" or ">" button to select the desired wash cycle.
- If desired select the "HALF LOAD" or "DELAY START" features at this point.
 - In addition to your Wash Cycle selection, for small loads of lightly soiled dishes press the "HALF LOAD" button. This will save energy, water.
 - If you would like to delay the start time of the dishwasher press the "DELAY" button until the desired delay time (1-24 hrs.) shows in the Countdown Display window.
- Press the "START" button to begin the cycle (Wash Cycle Indicator Light will stop flashing)

Note: Rinse Agent Indicator Light will be illuminated if the unit needs Rinse Agent.

Child Lock

- After pressing the "START" button you can activate the Child Lock feature.
- Press and hold down the "<" button until "CL" appears in the Countdown Display window. Now any button you press (except ON/OFF) will not function and "CL" will display each time.
- To deactivate, press and hold the "<" button until the "CL" disappears from the Countdown Display window.

To Cancel the Cycle:

- Press and hold the "START/RESET" button until the Countdown Display reads "0:01".
- Wait until the Countdown Display reads "0:00" and turn the unit off.
- You are now ready to start a new cycle.

Note: You cannot cancel a cycle with the Child Lock feature activated.

Setting Options (Rinse Agent Amount / Extra Dry Heat Activation)

- Door must be closed. Press the "ON/OFF" button to turn the unit on.
- One of the Wash Cycle Indicator Lights will be flashing to show you are in the Wash Cycle selection mode.
- To enter the Options Setup Mode, press and hold down the ">" button, then press and release the "START RESET" button, then release the ">" button.
- The "Sanitized" Indicator Light will be flashing to show you are in the Options Setup Mode.
- Press the ">" button to select the option you would like to adjust
 - If the Countdown Display shows a "d:00" or "d:01" are ready to turn your Extra Dry Heat option on/off.
 - If the Countdown Display shows a "r:00" through "r:06" you are ready to set the amount of Rinse Agent the unit will dispense.

To Turn the Extra Dry Heat On or Off

- With the Countdown Display showing a "d:00" or "d:01" press the "<" button to change the setting.
 - "d:00" means the Extra Dry Heat is off.
 - "d:01" means the Extra Dry Heat is on
- Press "START" to save your settings.

To Set the Amount of Rinse Agent Dispensed

NOTE: If your glasses have spots you need more Rinse Agent. If your glasses have streaks you need less Rinse Agent.

- With the Countdown Display showing "r:00" through "r:06" (r:00 = no rinse aid & r:06 = highest rinse aid) press the "<" button to change the amount of Rinse Agent the unit will dispense.
- Press "START" to save your settings.

OPERATING THE: SHE4AM0

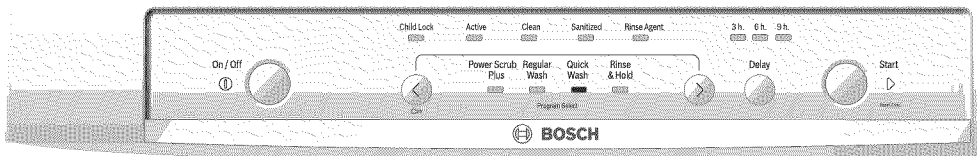

SHE4AM1

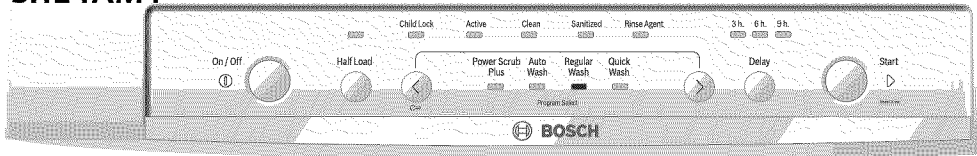

⚠ WARNING

You could be seriously scalded if you allow hot water to splash out of the dishwasher. **OPEN THE DOOR CAREFULLY during any wash or rinse cycle. Do not fully open the door until water noises have stopped.**

To Start Unit:

- Door must be closed. Press the "ON/OFF" button to turn the unit on.
- One of the Wash Cycle Indicator Lights will be flashing to show you are in the Wash Cycle selection mode.
- Press the "<" or ">" button to select the desired wash cycle.
- If desired select the "HALF LOAD" or "DELAY START" features at this point.
 - If you would like to delay the start time of the dishwasher press the "DELAY" button until the desired delay time (3/6/9 hrs.) shows on the Indicator Lights.
 - In addition to your Wash Cycle selection, for small loads of lightly soiled dishes press the "HALF LOAD" button. This will save energy and water (SHE4AM1# only).
- Press the "START" button to begin the cycle (Wash Cycle Indicator Light will stop flashing and the "Active" Indicator Light will illuminate)

Note: Rinse Agent Indicator Light will be illuminated if the unit needs Rinse Agent.

Child Lock

- After pressing the "START" button you can activate the Child Lock feature.
- Press and hold down the "<" button until Child Lock Indicator Light illuminates (Light goes out when button is released).
- Now any button you press (except ON/OFF) will not function and the Child Lock Indicator Light illuminates when pressing.
- To deactivate, press and hold the "<" button until the Child Lock Indicator Light goes out.

To Cancel the Cycle:

- Press and hold the "START/RESET" button until the "Active" Indicator Light goes out.
- Wait for about 1 minute for the dishwasher to drain.
- Press the "ON/OFF" button.

- You are now ready to start a new cycle

Note: You cannot cancel a cycle with the Child Lock feature activated.

Setting Options (Rinse Agent Amount / Extra Dry Heat Activation)

- Door must be closed. Press the "ON/OFF" button to turn the unit on.
- One of the Wash Cycle Indicator Lights will be flashing to show you are in the Wash Cycle selection mode.

- To enter the Options Setup Mode, press and hold down the ">" button, then press and release the "START RESET" button, then release the ">" button.

- The "Clean" Indicator Light and at least one additional Indicator Light will be flashing to show you are in the Options Setup Mode.
- Press the ">" button to select the option you would like to adjust
 - If the "CLEAN" and "RINSE AGENT" Indicator Lights are flashing you are ready to set the amount of Rinse Agent the unit will dispense.
 - If the "CLEAN" and "SANITIZED" Indicator Lights are flashing you are ready to turn your Extra Dry Heat option on/off.

To Set the Amount of Rinse Agent Dispensed

NOTE: If your glasses have spots you need more Rinse Agent. If your glasses have streaks you need less Rinse Agent.

- With the "CLEAN" and "RINSE AGENT" Indicator Lights flashing.
- Press the "<" button to change the amount of Rinse Agent Dispensed.
- As you press the "<" button you will notice the Wash Cycle Indicator Lights illuminating
 - If none of the Wash Cycle Indicator Lights are illuminated, the Rinse Agent Dispenser is turned off.
 - If one of the Wash Cycle Indicator Lights are illuminated, the Rinse Agent Dispenser is set to deliver the lowest charge of Rinse Agent.
 - If two of the Wash Cycle Indicator Lights are illuminated, the Rinse Agent Dispenser is set to deliver a medium charge of Rinse Agent.
 - If three of the Wash Cycle Indicator Lights are illuminated, the Rinse Agent Dispenser is set to deliver the largest charge of Rinse Agent.
- Press "START" to save your settings.

To Turn the Extra Dry Heat On or Off

- With the "CLEAN" and "SANITIZED" Indicator Lights flashing.
- Press the "<" button to change the Extra Dry Heat setting.
- As you press the "<" button you will notice the Wash Cycle Indicator Lights illuminating
 - If none of the Wash Cycle Indicator Lights are illuminated, the Extra Dry Heat option is turned off.
 - If one of the Wash Cycle Indicator Lights are illuminated, the Extra Dry Heat is turned on.
- Press "START" to save your settings.

Figure 17

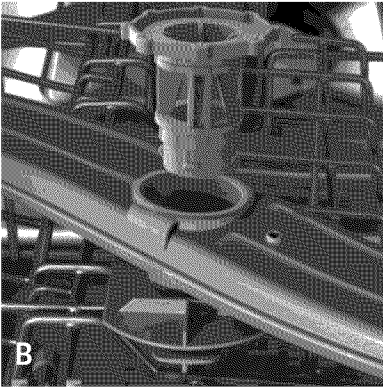
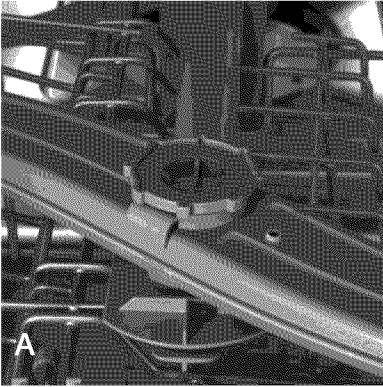

Figure 18

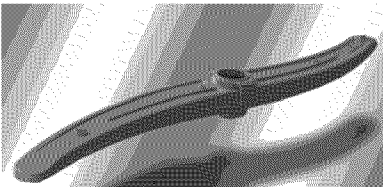
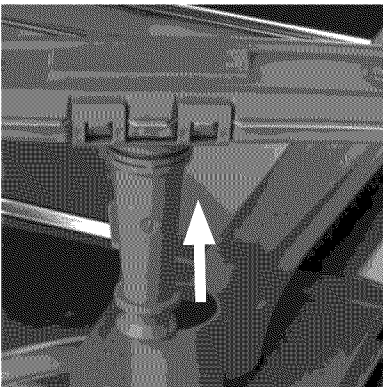

Figure 19



Care and Maintenance

Maintenance Tasks

Certain areas of your dishwasher require occasional maintenance. The maintenance tasks are easy to do and will ensure continued superior performance from your dishwasher. These tasks are:

- Winterizing Your Dishwasher
- Wiping up Spills and Splash-out
- Clean the Stainless Steel Inner Door and Tub
- Check/Clean the Spray Arm Nozzles
- Check/Clean the Filter System
- Clean the Exterior Door Panel
- Clean the Door Gasket

Winterizing Your Dishwasher

If your dishwasher will be unused for an extended period of time in a location that experiences freezing temperatures (e.g., in a holiday home or through a vacation period), have your dishwasher winterized by an authorized service center.

NOTICE

To avoid dishwasher damage, do not allow water to remain in your dishwasher systems through extended periods of freezing temperatures. Freezing temperatures can damage your dishwasher.

Wiping Up Spills and Splash-out

Water may occasionally splash out of your dishwasher, especially if you interrupt a cycle or open the dishwasher door during a cycle. To avoid floor damage and possible mold growth, do not allow wet areas to remain around or under the dishwasher.

Check/Clean the Stainless Steel Inner Door and Tub

Clean the outer edges of the inside door panel regularly to remove debris that might collect there from normal loading.

If spots begin to appear on the stainless steel tub or inner door, make sure the rinse agent reservoir is full.

Check/Clean the Spray Arm Nozzles

Occasionally check the spray arms to ensure that the spray arm nozzles (holes) are unobstructed. You must remove the spray arms to check them for obstruction.

To remove the top spray arm:

1. Remove the empty top rack from the dishwasher.
2. Turn the rack upside-down. The top spray arm is held in position by a locking nut as shown in Figure 17A. Turn the locking nut counter-clockwise 1/8 turn and remove it, as shown in Figure 17B to release the spray arm.
3. Remove the spray arm as shown in Figure 18.
4. Look for obstruction in the spray nozzles.
5. If the spray nozzles need cleaning, flush them under running water.

To reinstall the top spray arm:

1. Return the top spray arm to its installed position.

2. Return the locking nut to its installed position and turn it 1/8 turn clockwise.
3. Return the top rack to the top rack roller guides.

To remove the bottom spray arm:

1. Remove the empty bottom rack from the dishwasher tub.
2. Grasp and lift the bottom spray arm as shown in Figure 19.
3. Look for obstruction in the spray nozzles.
4. If the spray nozzles need cleaning, flush them under running water.

To reinstall the bottom spray arm:

1. Return the bottom spray arm to its installed position and press it so that it snaps into place.
2. Return the bottom rack to its installed position.

Check/Clean the Filter System

This dishwasher has a filter system that consists of a Large Object Trap/Cylinder Filter assembly and a Fine Filter. The filter system is located on the inside of your dishwasher under the lower rack and is easily accessible.

During normal use, the filter system is self-cleaning. You should occasionally inspect it for foreign objects and clean it when necessary.

⚠ CAUTION

To avoid injury, do not reach into the large object trap with your fingers. The large object trap could contain sharp objects.

To Remove the Large Object Trap/Cylinder Filter Assembly:

1. Remove the bottom rack.
2. Grasp the assembly as shown in Figure 20 and turn it counter clockwise 1/4 turn.
3. Lift out the assembly as shown in Figure 21 and 22.
4. Carefully examine the assembly. If you find debris in the Large Object Trap, turn it upside-down and gently tap it on a surface such as a countertop to dislodge and remove the debris. Flush the Cylinder Filter clean by holding it under running water. Place parts back in unit and lock as shown in Figure 23.

Figure 20

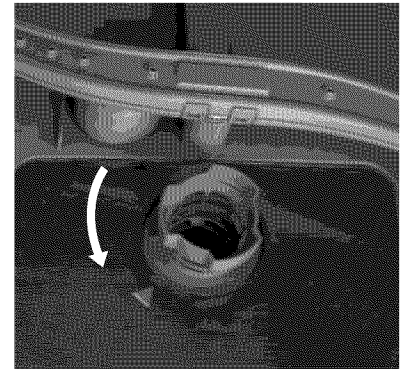

To open - turn counterclockwise.

Figure 21

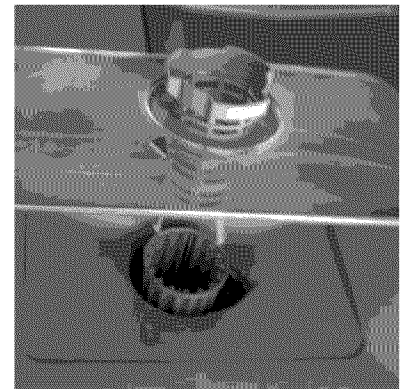

Large Object Trap

Figure 22

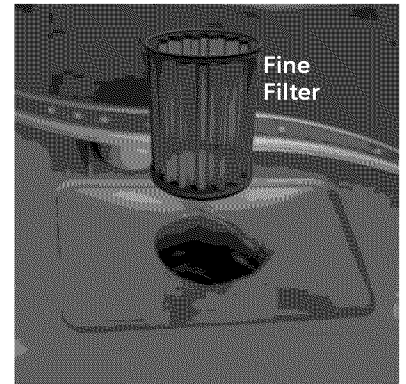
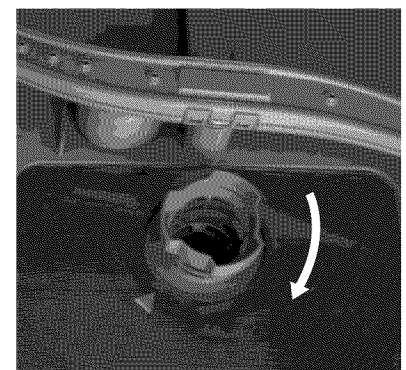

Figure 23



To close - turn clockwise.

Clean the Exterior Door Panel

Colored Doors

Use only a soft cloth that is lightly dampened with soapy water.

Stainless Steel Doors

Use a soft cloth with a non-abrasive cleaner (preferably a liquid spray) made for cleaning stainless steel. For the best results, apply the stainless steel cleaner to the cloth, then wipe the surface.

Clean the Door Gasket and Door Seal

Regularly clean the door gasket with a damp cloth to remove food particles and other debris. Also clean the door seal, located inside the dishwasher at the bottom of the door.

Wash Cycle Information

NOTE: To save energy, this dishwasher has a “Smart Control” that automatically adjusts the cycle based on soil loads and incoming water temperature. The “Smart Control” makes decisions that can cause the cycle time and water usage to adjust intermittently. The cycle times listed in the Use and Care manual are based on normal soil loads and 120°F incoming water and will vary based on your actual conditions.

See the Cycles Chart to determine the cycles available for your specific model.

NOTE: On select models, the Half Load feature will reduce the water

consumption by approximately 30 percent in the Power Scrub Plus, Regular, and Auto Wash cycles. The ECO option may be selected for the Power Scrub Plus, Auto, Regular and Delicate cycles on select models. This reduces energy consumption approximately 10% due to lower main wash and final rinse temperatures, but extends cycle length 5-10 minutes to maintain drying performance and the water usage will be unmodified in comparison to the normal program cycles.





THE NSF SYMBOL

A dishwasher or a dishwasher cycle that has the NSF symbol has been certified by the NSF International to meet very strict requirements of wash time and water temperature to ensure dishware and kitchenware sanitization. These requirements are explained in the document NSF/ANSI 184, Residential Dishwashers. More information on NSF Certification is available at the NSF website, <http://www.nsfconsumer.org/home/appliances.asp>.

Your dishwasher is NSF certified. The dishwasher cycles that are NSF certified are shown in the following chart. When these cycles are complete, the “Sanitized” indicator on your dishwasher control panel will illuminate.

NOTE: If your household water supply is too hot, your dishwasher’s heating time may be reduced and the “Sanitized” light or symbol may not illuminate. Your Dishwasher Installation Manual has information on the recommended temperature for your household hot water supply.

Cycle Data

		 Power Scrub Plus	 Auto Wash*	Regular Wash	Delicate/Economy*	Quick Wash	Rinse & Hold*
	Cycle Time (in minutes)	130	105-125	95-119	80	30	9
Water Consumption in gallons	Minimum	6.8	3.6	2.3	3.0	3.0	1.0
	Maximum	6.8	6.5	5.4	3.0	3.0	1.0
Water Consumption in liters	Minimum	25.6	13.6	8.7	11.3	11.3	4.0
	Maximum	25.6	24.6	20.5	11.3	11.3	4.0
Wash Temp °F		160°	130°-150°	122°-131°	122°	113°	Incoming
Rinse Temp °F		156°	156°	149°-156°	156°	122°	Incoming

*Select Models - refer to Cycle Chart

Half Load Function

Cycle Time (in minutes)	110	99-110	90-110	75	Not Available
Water Consumption (l)	17.9	10.5-15.9	8.7-15.9	10.9	
Water Consumption (gal)	4.7	2.8- 4.2	2.3- 4.2	2.9	

Self Help

Dishwashers may occasionally exhibit problems that are unrelated to a malfunction of the dishwasher itself. The following information may help you with a dishwasher problem without involving a repair professional.

Problem	Cause	Action
Dishwasher does not start	<ol style="list-style-type: none"> 1. Door may not be properly latched. 2. Unit may not be turned on. 3. Unit not reset or previous cycle not completed. 4. Delay start engaged. 5. Interruption of electrical power supply to dishwasher or blown fuse. 6. Child lock activated (select models). 7. The door may have been closed without first selecting a cycle. 8. Water supply may not be turned on. 	<ol style="list-style-type: none"> 1. Shut the door completely. 2. Press the main power switch to turn unit on. 3. To reset, refer to "Canceling or changing the cycle" section in this manual. 4. To reset, refer to "Delay Start" section in this manual. 5. Check circuit breaker. 6. Deactivate the child lock. Refer to "Child Lock" section in this manual if applicable. 7. Select a cycle and close the door. 8. Check and turn on water supply.
Dishwasher beeping (end of cycle signal)	<p>Default factory settings alert the customer that the cycle has completed by beeping. This feature can be deactivated if so desired.</p>	<p>To adjust the volume or deactivate, refer to "Cycle Completion Signal" section in this manual.</p>
Display does not illuminate or console lights are not on	<ol style="list-style-type: none"> 1. A fuse may have been blown or circuit breaker tripped. 2. Door not closed or latched. <p><i>Note: For models with controls on the top portion of the door, the display only illuminates when the door is opened and controls are visible.</i></p>	<ol style="list-style-type: none"> 1. Check the fuse or circuit breaker box and replace the fuse or reset the breaker if necessary. 2. Ensure that door is properly latched and completely closed.
Dishwasher seems to run a long time	<ol style="list-style-type: none"> 1. Incoming water is not warm enough. 2. Cycle time can vary due to soil and water conditions. 3. Rinse agent dispenser is empty. 4. Dishwasher connected to cold water supply. <p><i>Note: Refer to "Cycle Chart Data" section in this manual for typical cycle length.</i></p>	<ol style="list-style-type: none"> 1. Before starting a cycle, run hot water faucet at the sink nearest to the dishwasher. 2. Sensors in the dishwasher automatically increase the cycle time to ensure a good wash when heavy soil is detected. 3. Add rinse agent. 4. Verify dishwasher is connected to hot water supply plumbing.
Dishes aren't getting clean enough	<ol style="list-style-type: none"> 1. Spray arm movement is obstructed. 2. Spray arm nozzles clogged. 3. Improper use of detergents. 4. Filters could be clogged. 5. Dishes are nested or loaded too close together. 6. Selected wash cycle is not suitable for food soil conditions. 	<ol style="list-style-type: none"> 1. Ensure that spray arm movement is not blocked by hand rotating spray arms. 2. Remove the spray arms and clean according to "Check/Clean the Spray Arm Nozzles" in Care and Maintenance section of this manual. 3. Increase or decrease detergent depending on the water hardness. Refer to Table under "Adding Detergent and Rinse Agent". 4. Clean the filter. Refer to "Check/Clean the Filter System" under Care and Maintenance section of this manual. 5. Rearrange load such that water spray can reach all items in the dishwasher. See also "Preparing and Loading" section of this manual. 6. Refer to "Wash Cycle" section in Operating the Dishwasher section of this manual.

Problem	Cause	Action
Dishes are not getting dry enough	<ol style="list-style-type: none"> 1. Rinse agent dispenser is empty. (Rinse agent indicator is activated). 2. Improper loading of dishes. 3. Selected cycle does not include drying. <p><i>Note: Plastic or Teflon do not typically dry as completely as other items due to their inherent properties.</i></p>	<ol style="list-style-type: none"> 1. Add rinse agent. The use of rinse agent improves drying. 2. Rearrange load to ensure items are not nested. Refer also to the "Preparing and Loading" section of this manual. 3. Rinse and Hold setting does not include drying cycle, <i>Note: Select models offer an extra heating options to improve drying performance. Refer to "Wash Cycle options" under the Operating the Dishwasher section of this manual.</i>
Odor	<ol style="list-style-type: none"> 1. Food debris is present at the bottom of the dishwasher. 2. Food particles are present near the door seal. 3. Dishes left too long in unit before running a cycle. 4. Residual water is present at the bottom of the dishwasher. 5. Drain hose is obstructed. 	<ol style="list-style-type: none"> 1. Remove the filters and clean according to the "Check/Clean the Filter System" section of this manual. 2. Refer to "Clean the Door Gasket and Door Seal" in the Care and Maintenance section of this manual . 3. Run a Rinse/Hold cycle if you do not intend to immediately wash the dishes. 4. Ensure the unit has completely drained from the last cycle. Refer to the "Canceling or changing the cycle" section of this manual. 5. Remove any obstructions from the drain hose by calling qualified personnel. <i>Note: If odor still persists, run the Normal/Regular cycle until it flushes and interrupt the cycle and place an 8 oz. cup of distilled white vinegar solution on the top rack and then finish the cycle.</i>
Dishwasher not filling with water	<ol style="list-style-type: none"> 1. Restriction in the water supply system. 2. Previous wash cycle was not completed. 3. Delay-start is active. 	<ol style="list-style-type: none"> 1. Ensure that the water supply valve (typically located under kitchen sink) is open and check that the water supply line has no kinks and clogs. 2. Refer to the "Canceling or changing the cycle" section of this manual. 3. Cancel the delay-start or wait until delay-start time completes (times out). Refer to the "Delay Start" section of this manual.
Water Leaks	<ol style="list-style-type: none"> 1. Suds 2. Door seal could be pulled away from track. 3. Condensation vent is blocked. 4. Improper installation. 	<ol style="list-style-type: none"> 1. Wrong type of detergent results in suds and leaks. Use only dishwasher detergents. If suds still persist, then add one tablespoon of vegetable oil at the bottom of the dishwasher and run the desired cycle. 2. Ensure that door seal is in the track. 3. Ensure that condensation vent is not blocked. 4. Have proper installation verified by qualified personnel (water supply, drain system, leveling, plumbing).
Tub stains	<ol style="list-style-type: none"> 1. Stains on the dishwasher interior are due to hardness of water. 2. Silverware in contact with tub. 	<ol style="list-style-type: none"> 1. Concentrated Lemon juice can reduce the build up of hard water stains. Run a normal cycle until it flushes and interrupt the cycle and then place an 8 oz. cup of the concentrated lemon solution on the top rack and finish the cycle. This can be done periodically to avoid build up. 2. Ensure that the silverware does not make contact with the tub while running a cycle.

Problem	Cause	Action
Streaks on glassware or residue on the dishes	Incorrect rinse agent setting.	Depending on the hardness of water, adjust the rinse agent dispenser. Refer to "Adding Detergent and Rinse Agent" section in this manual for adjustment.
Fascia panel discolored or marked	Abrasive cleaner used.	Use mild detergents with soft damp cloth.
Noise during wash cycle	The dishes may not be arranged properly.	Water circulation sound is normal, but if you suspect items are banging into each other or into the spray arms, refer to the "Preparing and Loading" section of this manual for optimal arrangement.
Detergent dispenser cover will not shut	<ol style="list-style-type: none"> 1. Improper operation of detergent cover. 2. Previous cycle has not been finished, reset, or cycle was interrupted. 	<ol style="list-style-type: none"> 1. Refer to "Adding Detergent and Rinse Aid" section of this manual for instructions on opening and closing the dispenser. 2. Refer to the "Canceling or changing the cycle" section of this manual.
Unable to select desired cycle	Previous cycle has not finished.	Refer to the "Canceling or changing the cycle" section of this manual.

Customer Service

Your Bosch dishwasher requires no special care other than that described in the Care and Maintenance section. If you are having a problem with your dishwasher, before calling for service please refer to the Self Help section. If service is necessary, contact your dealer or installer or an authorized service center. **Do not attempt to repair the appliance yourself.** Any work performed by unauthorized personnel may void the warranty.

If you are having a problem with your Bosch dishwasher and are not pleased with the service you have received, please take the following steps (in the order listed below) until the problem is corrected to your satisfaction:

1. Contact your installer or the Bosch Authorized Service Contractor in your area.
2. Contact customer service through our website, www.boschappliances.com.
3. Write us at the address below:

BSH Home Appliances, Corporation
5551 McFadden Avenue
Huntington Beach, CA 92649

4. Call us at 1-800-944-2904.

Please be sure to include your model information listed below as well as an explanation of the problem and the date it originated.

You will find the model and serial number information on the label located on the right edge of the dishwasher door as shown in Figure 32.

Also, if you are writing, please include a daytime phone number where you can be reached.

Please make a copy of your invoice and keep it with this manual. The customer must show proof of purchase to obtain warranty service.

Your Model Information:

- Model Number _____
- Serial Number _____
- Date Purchased _____
- Date Installed _____

⚠ CAUTION

Removing any cover or pulling the dishwasher from the cabinet can expose hot water connections, electrical power and sharp edges or points.

Figure 25



Model and Serial Number Label

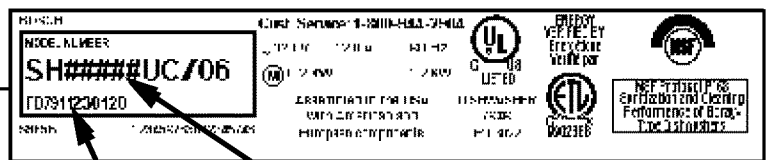

Serial Number Model Number

Statement of Limited Product Warranty

Bosch Dishwashers

What this Warranty Covers & Who it Applies to: The limited warranty provided BSH Home Appliances (“Bosch”) in this Statement of Limited Product Warranty applies only to Bosch dishwashers (“Product”) sold to you, the first using purchaser, provided that the Product was purchased: (1) for your normal, household (non-commercial) use, and has in fact at all times only been used for normal household purposes; (2) new at retail (not a display, “as is”, or previously returned model), and not for resale, or commercial use; and (3) within the United States or Canada, and has at all times remained within the country of original purchase. The warranties stated herein apply only to the first purchaser of the Product and are not transferable.

- Please make sure to return your registration card; while not necessary to effectuate warranty coverage, it is the best way for Bosch to notify you in the unlikely event of a safety notice or product recall.

How Long the Warranty Lasts: Bosch warrants that the Product is free from defects in materials and workmanship for a period of three hundred sixty five (365) days (i.e., 1 year) from the date of purchase. The foregoing timeline begins to run upon the date of purchase, and shall not be stalled, tolled, extended, or suspended, for any reason whatsoever. Labor and shipping costs are included in this basic coverage.

Extended Limited Warranty: Bosch also provides these additional limited warranties:

- **2 Year Limited Warranty:** Bosch will repair or replace any component that proves to be defective in materials or workmanship (excludes labor charges).
- **5 Year Limited Warranty on Electronics:** Bosch will repair or replace any Bosch microprocessor or printed circuit board if it proves to be defective in materials or workmanship (excludes labor charges).
- **5 Year Limited Warranty on Dish Racks:** Bosch will replace the upper or lower dish rack (excluding rack components), if the rack proves defective in materials or workmanship (excludes labor charges).
- **Lifetime Warranty against Stainless Steel Rust Through:** Bosch will replace your dishwasher with the same model or a current model that is substantially equivalent or better in functionality, if the inner liner should rust through (excludes labor charges). Bosch will replace the stainless steel door if the door should rust through (excludes labor charges).

The foregoing timeline begins to run upon the date of purchase, and shall not be stalled, tolled, extended, or suspended, for any reason whatsoever.

Repair/Replace as Your Exclusive Remedy: During this warranty period, Bosch or one of its authorized service providers will repair your Product without charge to you (subject to certain limitations stated herein) if your Product proves to have been manufactured with a defect in materials or workmanship. If reasonable attempts to repair the Product have been made without success, then Bosch will replace your Product (upgraded models may be available to you, in Bosch’s sole discretion, for an additional charge). All removed parts and components shall become the property of Bosch at its sole option. All replaced and/or repaired parts shall assume the identity of the original part for purposes of this warranty and this warranty shall not be extended with respect to such parts. Bosch’s sole liability and responsibility hereunder is to repair manufacturer-defective Product only, using a Bosch-authorized service provider during normal business hours. For safety and property damage concerns, Bosch highly recommends that you do not attempt to repair the Product yourself, or use an un-authorized servicer; Bosch will have no responsibility or liability for repairs or work performed by a non-authorized servicer. If you choose to have someone other than an authorized service provider work on your Product, **THIS WARRANTY WILL AUTOMATICALLY BECOME NULL AND VOID.** Authorized service providers are those persons or companies that have been specially trained on Bosch products, and who possess, in Bosch’s opinion, a superior reputation for customer service and technical ability (note that they are independent entities and are *not* agents, partners, affiliates or representatives of Bosch). Notwithstanding the foregoing, Bosch will not incur any liability, or have responsibility, for the Product if it is located in a remote area (more than 100 miles from an authorized service

provider) or is reasonably inaccessible, hazardous, threatening, or treacherous locale, surroundings, or environment; in any such event, if you request, Bosch would still pay for labor and parts and ship the parts to the nearest authorized service provider, but you would still be fully liable and responsible for any travel time or other special charges by the service company, assuming they agree to make the service call.

Out of Warranty Product: Bosch is under no obligation, at law or otherwise, to provide you with any concessions, including repairs, pro-rates, or Product replacement, once this warranty has expired.

Warranty Exclusions: The warranty coverage described herein excludes all defects or damage that are not the direct fault of Bosch, including without limitation, one or more of the following: (1) use of the Product in anything other than its normal, customary and intended manner (including without limitation, any form of commercial use, use or storage of an indoor product outdoors, use of the Product in conjunction with air or water-going vessels); (2) any party’s willful misconduct, negligence, misuse, abuse, accidents, neglect, improper operation, failure to maintain, improper or negligent installation, tampering, failure to follow operating instructions, mishandling, unauthorized service (including self-performed “fixing” or exploration of the appliance’s internal workings); (3) adjustment, alteration or modification of any kind; (4) a failure to comply with any applicable state, local, city, or county electrical, plumbing and/or building codes, regulations, or laws, including failure to install the product in strict conformity with local fire and building codes and regulations; (5) ordinary wear and tear, spills of food, liquid, grease accumulations, or other substances that accumulate on, in, or around the Product; and (6) any external, elemental and/or environmental forces and factors, including without limitation, rain, wind, sand, floods, fires, mud slides, freezing temperatures, excessive moisture or extended exposure to humidity, lightning, power surges, structural failures surrounding the appliance, and acts of God. In no event shall Bosch have any liability or responsibility whatsoever for damage to surrounding property, including cabinetry, floors, ceilings, and other structures or objects around the Product. Also excluded from this warranty are scratches, nicks, minor dents, and cosmetic damages on external surfaces and exposed parts; Products on which the serial numbers have been altered, defaced, or removed; service visits to teach you how to use the Product, or visits where there is nothing wrong with the Product; correction of installation problems (you are solely responsible for any structure and setting for the Product, including all electrical, plumbing or other connecting facilities, for proper foundation/flooring, and for any alterations including without limitation cabinetry, walls, floors, shelving, etc.); and resetting of breakers or fuses.

TO THE EXTENT ALLOWED BY LAW, THIS WARRANTY SETS OUT YOUR EXCLUSIVE REMEDIES WITH RESPECT TO PRODUCT, WHETHER THE CLAIM ARISES IN CONTRACT OR TORT (INCLUDING STRICT LIABILITY, OR NEGLIGENCE) OR OTHERWISE. THIS WARRANTY IS IN LIEU OF ALL OTHER WARRANTIES, WHETHER EXPRESS OR IMPLIED. ANY WARRANTY IMPLIED BY LAW, WHETHER FOR MERCHANTABILITY OR FITNESS FOR A PARTICULAR PURPOSE, OR OTHERWISE, SHALL BE EFFECTIVE ONLY FOR THE PERIOD THAT THIS EXPRESS LIMITED WARRANTY IS EFFECTIVE. IN NO EVENT WILL THE MANUFACTURER BE LIABLE FOR CONSEQUENTIAL, SPECIAL, INCIDENTAL, INDIRECT, “BUSINESS LOSS”, AND/OR PUNITIVE DAMAGES, LOSSES, OR EXPENSES, INCLUDING WITHOUT LIMITATION TIME AWAY FROM WORK, HOTELS AND/OR RESTAURANT MEALS, REMODELLING EXPENSES IN EXCESS OF DIRECT DAMAGES WHICH ARE DEFINITELY CAUSED EXCLUSIVELY BY BOSCH, OR OTHERWISE. SOME STATES DO NOT ALLOW THE EXCLUSION OR LIMITATION OF INCIDENTAL OR CONSEQUENTIAL DAMAGES, AND SOME STATES DO NOT ALLOW LIMITATIONS ON HOW LONG AN IMPLIED WARRANTY LASTS, SO THE ABOVE LIMITATIONS MAY NOT APPLY TO YOU. THIS WARRANTY GIVES YOU SPECIFIC LEGAL RIGHTS, AND YOU MAY ALSO HAVE OTHER RIGHTS WHICH VARY FROM STATE TO STATE. No attempt to alter, modify or amend this warranty shall be effective unless authorized in writing by an officer of BSH.

How to Obtain Warranty Service: TO OBTAIN WARRANTY SERVICE FOR YOUR PRODUCT, YOU SHOULD CONTACT THE NEAREST BOSCH AUTHORIZED SERVICE CENTER, OR CALL 800-944-2904, or write Bosch at: BSH Home Appliances - 5551 McFadden Avenue, Huntington Beach, CA 92649 /