

Installation Instructions

READ BEFORE INSTALLING UNIT OPP5K Window Mounting

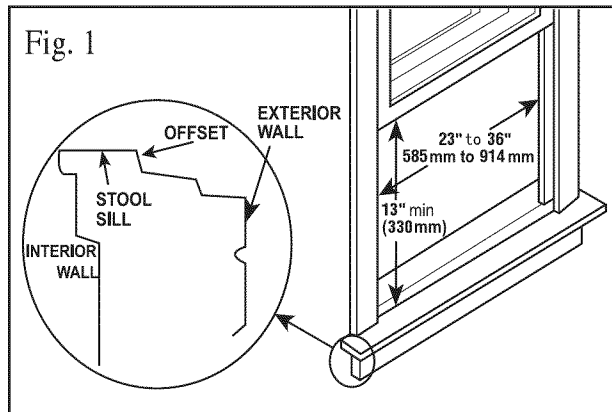

Your air conditioner is designed to install in standard double hung windows with opening widths of 23 to 36 inches (584 mm to 914 mm) (FIG. 1)

Lower sash must open sufficiently to allow a clear vertical opening of 13 inches (330mm). **Side louvers and the rear of the AC must have clear air space to allow enough airflow through the condenser, for heat removal. The rear of the unit must be outdoors, not inside a building or garage.**



NOTE: SAVE CARTON and these INSTALLATION INSTRUCTIONS for future reference. The carton is the best way to store unit during winter, or when not in use.

Some assembly is required. Please read these instructions carefully.

Mounting Hardware		Qty.
	3/4" screws	7
	lock frame	2
	sash lock	1

TOOLS NEEDED:



- Phillips Screw Driver
- Drill (If pilot holes are needed)

NOTE: DO NOT USE ANY SCREWS OTHER THAN THOSE SPECIFIED HERE

CAUTION

When handling unit, be careful to avoid cuts from sharp metal edges and aluminum fins on front and rear coils.

Before installing unit, the top rail must be assembled on the unit.

Top Rail Hardware	Qty.
	3/8" Screw 4
	Top Rail 1

TOOL NEEDED:

- Phillips Screwdriver

A. Remove the air conditioner from the carton and place on a flat surface.

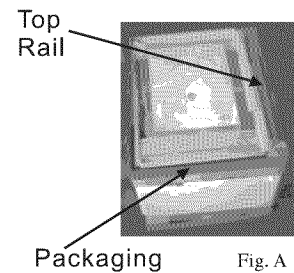

B. Remove top rail from the bottom of the packaging material as shown in Fig. A

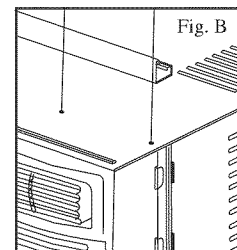

C. Align the hole in the top rail with those in the top of the unit as shown in Fig. B

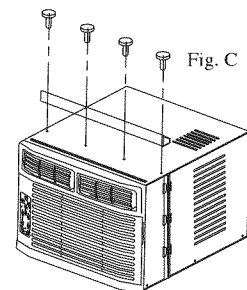

D. Secure the top rail to the unit with the 3/8" Screws as shown in Fig. C

NOTE: FOR SAFETY REASONS, ALL FOUR (4) SCREWS MUST BE SECURELY FASTENED.

How to Install

NOTE: Top Rail and Sliding Panels at each side are offset to provide the proper pitch to the rear of (5/16"). This is necessary for proper condensed water utilization and drainage. If you are not using the Side Panels for any reason, this pitch to the rear must be maintained!

1 Place unit on floor, a bench or a table. There is a Left and Right Window Filler Panel - be sure to use the proper panel for each side. When installed the flange for securing the panel in place to the window sill will be facing into the room.

A. Hold the Accordion Panel in one hand and gently pull back the center to free the open end. See Figure 2.

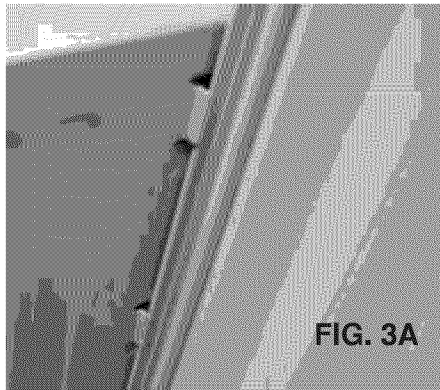
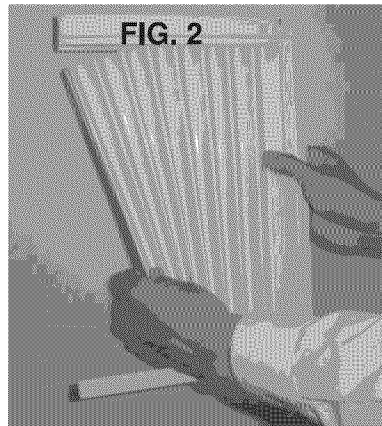

B. Slide the free end ("T" section) of the panel directly into the cabinet as shown in Figures 3A, 3B & 4. Slide the panel down. Be sure to leave enough space to slip the top and bottom of the frame into the rails on the cabinet.

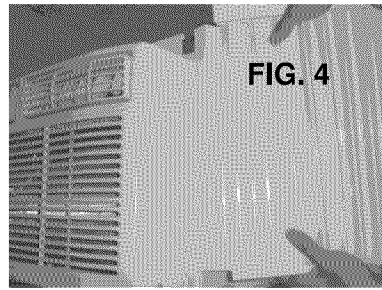
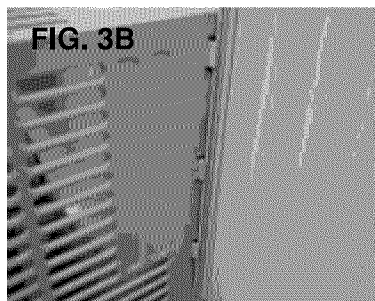

C. Once the panel has been installed on the side of the cabinet, make sure it sits securely inside the frame channel by making slight adjustments. Slide the top and bottom ends of the frame into the top and bottom rails of the cabinet. Figure 5.

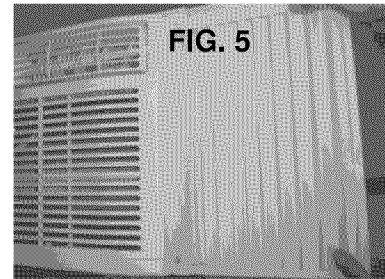

D. Slide the panel all the way in and repeat on the other side.

NOTE: If storm window blocks AC, see FIG. 14.

2 Keep a firm grip on the air conditioner, carefully place the unit into the window opening so the bottom of the air conditioner frame is against the window sill (FIG. 6 & FIG. 6A). Carefully close the window behind the top rail of the unit.

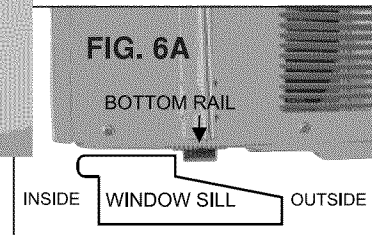
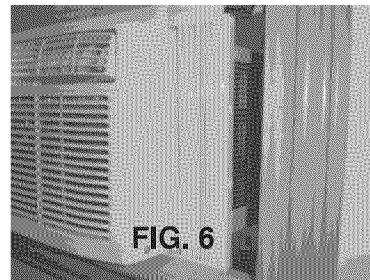

3 Extend the side panels out against the window frame (FIG. 7).

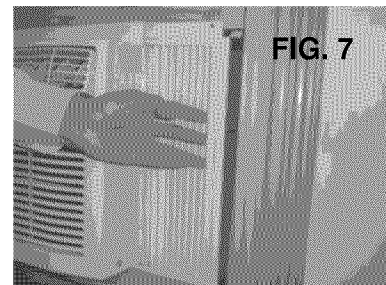

4 Place the frame lock between the frame extensions and the window sill as shown (Fig. 8). Drive 3/4" (19 mm) locking screws through the frame lock and into the sill (FIG. 9). **NOTE:** To prevent window sill from splitting, drill 1/8" (3 mm) pilot holes before driving screws.

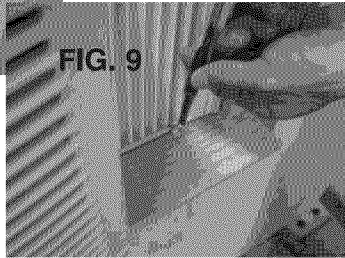
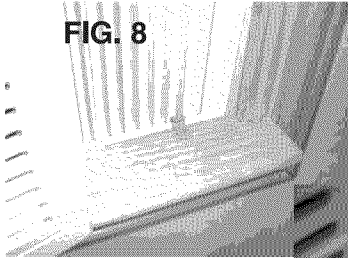

5 Drive 1/2" (13 mm) locking screws through frame holes into window sash (FIG. 10/11).

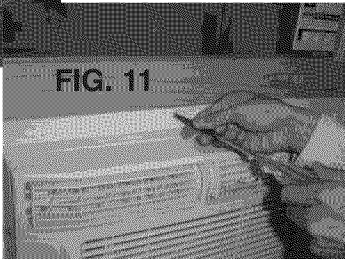

6 To secure lower sash in place, attach right angle sash lock with 3/4" (19 mm) screw as shown (FIG. 12).

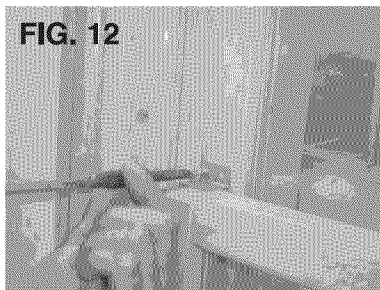

7 Cut foam seal and insert in the space between the upper and lower sashes (FIG. 13).

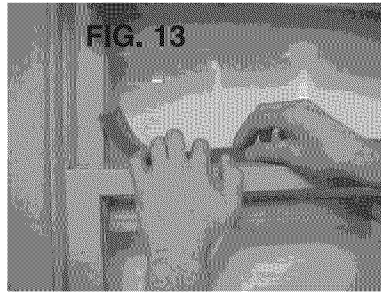

If AC is Blocked by Storm Window

Add wood as shown in FIG. 14, or remove storm window before air conditioner is installed.

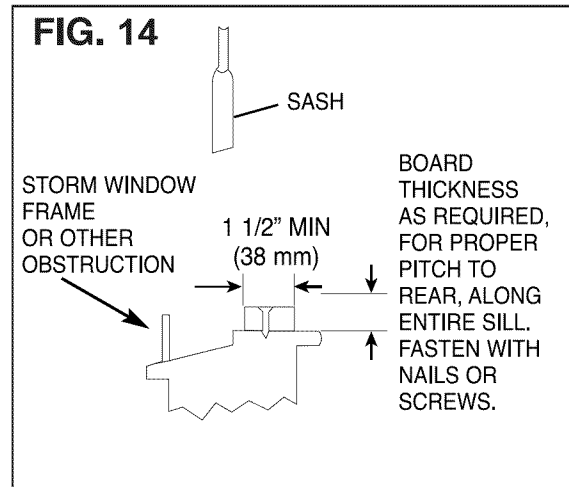

If Storm Window Frame must remain, be sure the drain holes or slots are not caulked or painted shut. Accumulated Rain Water or Condensation must be allowed to drain out.

Removing AC From Window

- * Turn AC off, and disconnect power cord.
- * Remove sash seal from between windows, and unscrew sash lock.
- * Remove screws installed through frame and frame lock.
- * Close (slide) side panels into frame.
- * Keeping a firm grip on air conditioner; raise sash and carefully "rock" air conditioner backward to drain any condensate water in base of unit. Be careful not to spill any remaining water while lifting unit from window. Store parts WITH air conditioner.