



INSTRUCTION MANUAL

EN

NOTICE D'UTILISATION

FR

MANUAL DE INSTRUCCIONES

ES

***FREE STANDING REFRIGERATOR
REFRIGERATEUR POSE LIBRE
FRIGORÍFICO INDEPENDIENTE***

FAB DESIGN

THANK YOU FOR YOUR TRUST AND FOR BUYING THIS APPLIANCE.

THE FAB28 REFRIGERATOR IS FOR USE IN THE UNITED STATE OF AMERICA ONLY AND MUST BE USED FOR STORING FRESH FOODS AT THE TEMPERATURE OF 32°F AND HIGHER.

LOW TEMPERATURE COMPARTMENT IS USED FOR STORING FROZEN FOODS (STORING TIME DEPENDS ON KIND OF FOOD, THERMOSTAT SETTING AND MARKING ON THE LOW TEMPERATURE COMPARTMENT DOOR).

3 - 22

NOUS VOUS REMERCIONS DE LA CONFIANCE QUE VOUS NOUS AVEZ TÉMOIGNÉE EN CHOISSANT CET APPAREIL.

LE RÉFRIGÉRATEUR FAB28 EST À UTILISER EXCLUSIVEMENT AUX ETAS UNIT D'AMERIQUE ET IL FAUT ÊTRE UTILISÉ IMPERATIVEMENT POUR LA CONSERVATION DES ALIMENTS FRAÎCHES À UNE TEMPÉRATURE DE 32°F OU SUPÉRIEURE.

LE COMPARTIMENT À BASSE TEMPÉRATURE EST DESTINÉ À LA CONSERVATION DE DENRÉES CONGELÉES (LE TEMPS DE CONSERVATION DÉPEND DU TYPE D'ALIMENT, DU RÉGLAGE DU THERMOSTAT ET DU MARQUAGE SUR LA PORTE).

23 - 42

GRACIAS POR SU CONFIANZA AL ADQUIRIR ESTE APARATO.

ESTE FRIGORÍFICO ESTÁ DISEÑADO ÚNICAMENTE PARA SER UTILIZADO EN LOS ESTADO UNIDOS DE AMERICA Y PARA CONSERVAR ALIMENTOS FRESCOS A UNA TEMPERATURA DE 0° C O SUPERIOR.

EL COMPARTIMENTO CONGELADOR SE EMPLEA PARA CONSERVAR ALIMENTOS CONGELADOS (EL PERÍODO DE CONSERVACIÓN DEPENDE DEL TIPO DE ALIMENTO, DEL AJUSTE DEL THERMOSTATO Y DE LO QUE INDIQUE LA PUERTA DEL COMPARTIMENTO CONGELADOR).

43 - 62

1. IMPORTANT SAFETY INSTRUCTIONS	4
2. PROPER DISPOSAL OF YOUR REFRIGERATOR	5
3. INSTALLATION INSTRUCTIONS	6
3.1 Unpack the Refrigerator	6
3.2 Location requirements	7
3.3 Positioning and levelling the appliance	8
3.4 Electrical requirements	9
4. PRODUCT DESCRIPTION	10
4.1 Intended use of the refrigerator	10
4.2 Shelves	10
4.3 Bottle shelf	10
4.4 Refrigerator compartment defrosting water drain	11
4.5 Fruit and vegetable box	11
4.6 Door shelves and containers	11
4.7 Inside lighting	11
4.8 Operating noise	11
5. REFRIGERATOR USE	12
5.1 Using the controls	12
5.2 Storing fresh food	12
5.3 Freezing food	13
5.4 Freezing compartment use	14
5.5 Thawing frozen foods	14
5.6 Making ice-cubes	15
6. REFRIGERATOR CARE	16
6.1 Defrosting the refrigerator	16
6.2 Defrosting the freezer	16
6.3 Cleaning the refrigerator	16
6.4 Changing the inside light bulb	17
6.5 Power interruptions	17
6.6 Vacation and moving care	18
7. TROUBLESHOOTING	19



INSTRUCTIONS FOR THE USER: these provide recommendations for use, a description of the controls and the correct procedures for cleaning and maintaining the appliance

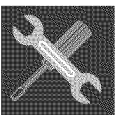

INSTRUCTIONS FOR THE INSTALLER: these are intended for the **qualified engineer** who is able to install, commission and test the appliance

1. IMPORTANT SAFETY INSTRUCTIONS



READ AND SAVE THESE INSTRUCTIONS – Your Safety And the Safety of Others Are Very Important. We have provided many important safety messages throughout this manual and on your appliance. Read all instructions before using your appliance and always obey all safety messages.



RECOGNIZE SAFETY INFORMATION

This is a safety alert symbol. This symbol alerts you to potential hazards that can kill or hurt you and others.

UNDERSTAND SIGNAL WORDS

A signal word – DANGER, WARNING, or CAUTION – is used with the safety-alert symbol. DANGER identifies the most serious hazards. It means you can be killed or seriously injured if you do not immediately follow instructions. WARNING means you can be killed or seriously injured if you do not follow instructions. CAUTION indicates a potentially hazardous situation which, if not avoided, may result in minor or moderate injury.



WARNING - FOR YOUR SAFETY

- Use this appliance only for its intended purpose as described in this Instruction Manual.
- Ensure proper installation in accordance with the Installation Instructions before using this appliance.
- Use two or more people to move and install refrigerator.
- Do not climb, stand or hang on the shelves in the refrigerator. This could cause serious injury or result in damage to the refrigerator.
- Never allow children to play with the refrigerator and use the drawers, shelves and others parts of the appliance only as described in this handbook.
- Never store explosive or flammable substances, such as gasoline in or in the vicinity of this refrigerator or use gasoline or other flammable vapors or liquids in the vicinity of this or any other appliance. Read product labels for warnings regarding flammability and other hazards.
Failure to do so can result in death, explosion or fire.
- Use nonflammable cleaner.
- High alcohol drinks must only be stored sealed and vertical.
- Never touch frozen product straight from the freezer or put it in your mouth. This can cause burn injury due to very low temperatures.
- Unplug your refrigerator before cleaning and making repairs.
- Disconnect power before installing ice maker (on ice maker kit ready models only).

2. PROPER DISPOSAL OF YOUR REFRIGERATOR



DANGER - CHILD SAFETY

- **CHILD ENTRAPMENT HAZARD:** Child entrapment and suffocation are not problems of the past. Junked or abandoned refrigeration products are still dangerous – even if they will sit for “just a few days.” If you are getting rid of your old appliance, please follow these instructions to help prevent accidents.

Before you throw away your old refrigerator/freezer:

- Remove doors;
- Leave shelves in place so children may not easily climb inside;
- Have refrigerant removed by a qualified service technician.
- Destroy or recycle the carton, plastic bags, and any exterior wrapping material immediately after the refrigerator is unpacked. Children should NEVER use these items to play. They can cause suffocation and death.
- Do not allow children to climb, stand or hang on the shelves in the refrigerator.
- Never allow children to play with the refrigerator.

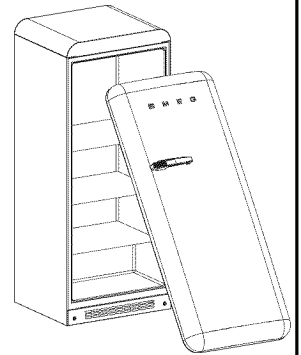

ELECTRICAL INFORMATION

To reduce the risk of fire, electric shock, or injury to persons when using this refrigerator, follow basic precautions, including the following:

- The power cord to this appliance is equipped with a three-prong grounding plug for your protection against electrical shock hazards. It must be plugged directly into a properly grounded three-prong receptacle.
- Do not, under any circumstances, cut or remove the third (ground) prong from the power cord. For personal safety, this appliance must be properly grounded.
- Have the wall outlet and circuit checked by a qualified electrician to make sure the outlet is properly grounded.
- Do not use an adapter plug.
- Do not use an extension cord.
- Never unplug an appliance by pulling on the power cord. Always grip the plug firmly and pull straight out from the outlet to prevent damaging the power cord.
- Unplug the refrigerator before servicing.



3. INSTALLATION INSTRUCTIONS

3.1 Unpack the Refrigerator



WARNING

Excessive Weight Hazard

Use two or more people to move and install refrigerator.

Failure to do so can result in back or other injury.

3.1.1 Remove the Packaging

- Remove tape and glue residue from surfaces before turning on the refrigerator. Rub a small amount of liquid dish soap over the adhesive with your fingers. Wipe with warm water and dry.
- Do not use sharp instruments, rubbing alcohol, flammable fluids, or abrasive cleaners to remove tape or glue. These products can damage the surface of your refrigerator. For more information, see “en.”
- On some models, shelves, bins, door shelf rails, and other feature parts may be packaged in the Interior FeaturePak. Follow the instructions contained in the package for proper assembly.
- Properly dispose of packaging.

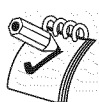

When Moving Your Refrigerator:

- Your refrigerator is heavy. When moving the refrigerator for cleaning or service, be sure to protect the floor.
- Always pull the refrigerator straight out when moving it.
- Do not wiggle or “walk” the refrigerator when trying to move it, as floor damage could occur.

3.1.2 Clean Before Using

After you remove all of the package materials, clean the inside of your refrigerator before using it. See the cleaning instructions in “6. REFRIGERATOR CARE.”



Important information to know about glass shelves and covers:

Do not clean glass shelves or covers with warm water when they are cold. Shelves and covers may break if exposed to sudden temperature changes or impact, such as bumping.

For your protection, tempered glass is designed to shatter into many small, pebble-size pieces. This is normal. Glass shelves and covers are heavy. Use special care when removing them to avoid impact from dropping.



3.2 Location requirements



WARNING



Explosion Hazard

Keep flammable materials and vapors, such as gasoline, away from refrigerator.

Failure to do so can result in death, explosion, or fire.

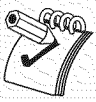

NOTE: It is recommended that you do not install the refrigerator near an oven, radiator, or other heat source. If this is unavoidable, a suitable insulating panel must be used to allow the appliance to work properly.

- Always place the refrigerator in a dry place with satisfactory ventilation. Never expose it to direct sunlight or install it outdoors. Depending on its climate class, the appliance can be used in different temperature conditions.
- The climate class is specified on the nameplate of the fridge, which is positioned in the bottom lefthand corner of the body of the refrigerator.
- Choose a place that is near a grounded electrical outlet. **Do not use an extension cord or an adapter plug.**
- To ensure proper ventilation for your refrigerator, allow for a 1/2" (12.70 mm) space on each side. Allow 3" (7.5 cm) of space between overhead cabinets and refrigerator top. Allow at least 1" (25.40 mm) between back of cabinet and the wall. If your refrigerator has an ice maker, make sure you leave some extra space at the back for the water line connections.
- If you are installing your refrigerator next to a fixed wall, leave 2" (5.08 cm) minimum on the hinge side (depending on your model) to allow for the door to swing open.
- Level the refrigerator. See "3.3 Positioning and levelling the appliance".

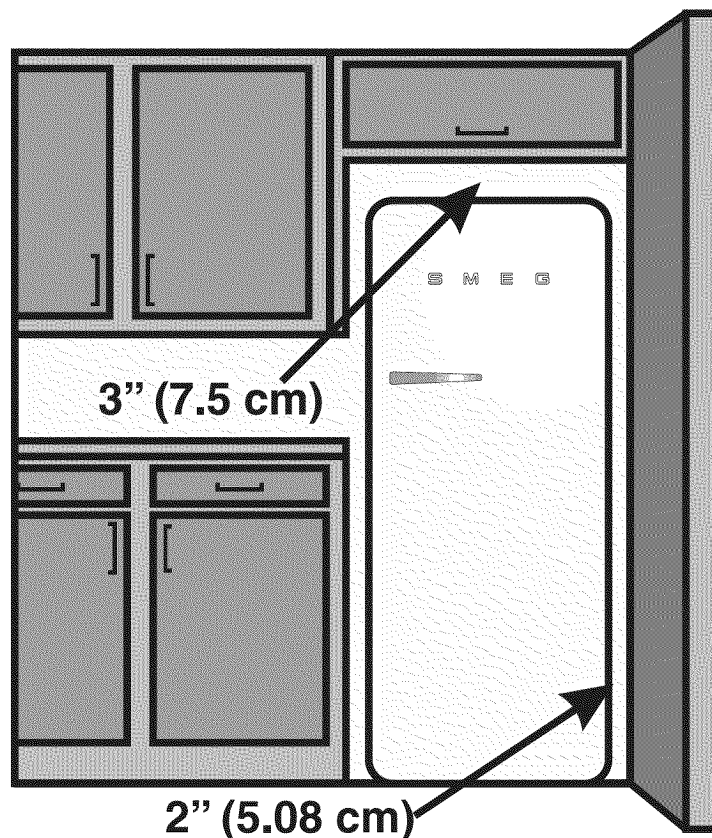



The temperature conditions are listed in the table below:

Class	Ambient temperature
SN (Subnormal)	from + 50° F to + 89° F
N (Normal)	from + 61° F to + 89° F
ST (Subtropical)	from + 64° F to + 100° F
T (Tropical)	from + 64° F to + 109° F

- The refrigerator must be placed at least 1 1/6" from electric or gas cookers and at least 11 5/6" from combustion or radiation heating systems.
- To allow proper cooling of the condenser, the refrigerator must not be positioned too close to the wall. To prevent this, the appliance comes complete with two plastic spacers which must be fitted to the top of the condenser (pic. 1). If the refrigerator is installed underneath a wall cupboard, its distance from it must be at least 2".

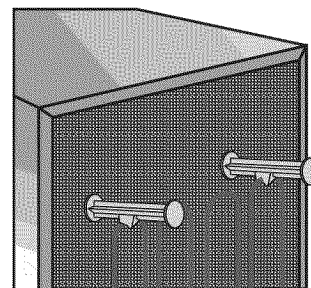

pic. 1)

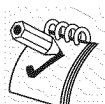

NOTE: Pay attention not to scratch or damage the floor when installing the appliance. If necessary, when positioning slide the refrigerator over pieces of wood or a mat to the point decided for connection to the electrical mains.

3.3 Positioning and levelling the appliance

Place the refrigerator on a stable and level floor. In case the floor is not perfectly level, use the two adjustable feet on the front part of the fridge (pic. 2). To ensure major stability, easier movement and a correct positioning of the product, two additional wheels (pic. 3) are present at the rear. In any case we recommend to move the refrigerator very carefully in order to avoid floor damage (especially in case of wooden floor).

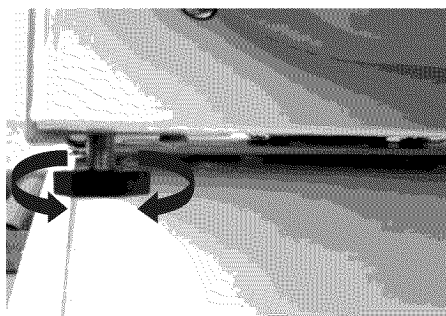

pic. 2)

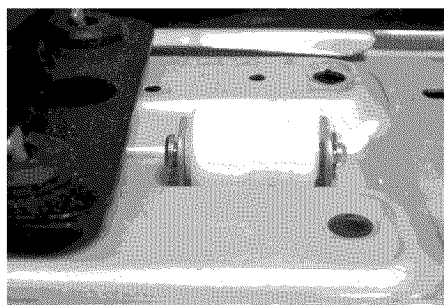

pic. 3)



3.4 Electrical requirements



Electrical Shock Hazard

Plug into a grounded 3-prong outlet.

Do not remove ground prong.

Do not use an adapter.

Do not use an extension cord.

Failure to follow these instructions can result in death, fire, or electrical shock.



NOTE: Before you move your refrigerator into its final location, it is important to make sure you have the proper electrical connection.

- Before switching the refrigerator on for the first time, leave it vertical for at least two hours. Then connect the appliance's power supply lead to a main socket with earth contact, installed in accordance with electrical safety regulations. The rated voltage and frequency are stated on the nameplate inside the refrigerator compartment.
- The appliance must be connected to the electrical mains and earthed in compliance with the relevant regulations and requirements. The appliance is able to withstand short fluctuations in voltage of no more than 15% less or 10% more than the rated voltage stated on the nameplate.
- If the power supply lead has to be replaced, this operation must only be carried out by an **authorised technical service engineer**.
- The socket must be accessible after the appliance has been placed.

3.4.1 Recommended Grounding Method

A 115 Volt, 60 Hz., AC only 15- or 20-amp fused, grounded electrical supply is required. It is recommended that a separate circuit serving only your refrigerator be provided. Use an outlet that cannot be turned off by a switch. **Do not use an extension cord.**

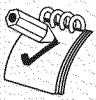

NOTE: Before performing any type of installation, cleaning, or removing a light bulb, turn the control (Thermostat, Refrigerator or Freezer Control depending on the model) on position 0 (STOP) and then disconnect the refrigerator from the electrical source. When you are finished, reconnect the refrigerator to the electrical source and reset the control (Thermostat, Refrigerator or Freezer Control depending on the model) to the desired setting.



4. PRODUCT DESCRIPTION

4.1 Intended use of the refrigerator



WARNING

Never allow children to play with the refrigerator and use the drawers, shelves and other parts of the appliances only as described in this handbook.

The appliance is specifically constructed for domestic use and is therefore suitable for the refrigeration and storage of fresh and frozen foods, and the production of ice-cubes. The appliance is not designed or manufactured for professional use.

The refrigerator has undergone the necessary tests on the tightness of the refrigeration circuit and complies with the safety regulations for electrical appliances.

Refrigerator (A): compartment for storing fresh foods

Freezer compartment (B): compartment for storing frozen foods, for freezing fresh foods and making ice-cubes

To open the door, pull the handle towards you.

To close, push the door towards its hook and check that it snaps shut.

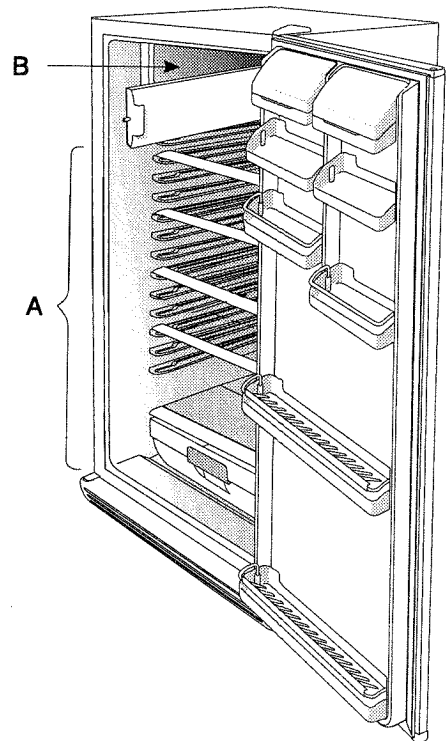

4.2 Shelves

Each refrigerator comes complete with several shelves which can be set at different heights by placing them on the runners provided. Each shelf has a safety fitting to prevent it from being pulled completely out or accidentally removed. To remove it from the appliance, lift it at the back and extract it. Then change the position of the shelves as you require. For easy removal of all internal accessories, the door has to be opened completely.

4.3 Bottle shelf

Like ordinary shelves, the bottle shelf (pic.4), can also be set at different heights. It can be fitted into the refrigerator compartment in two different positions: horizontally or with the front part raised so that the bottles can be placed on a slant. To remove the bottle shelf, lift it at the back and pull it outward.

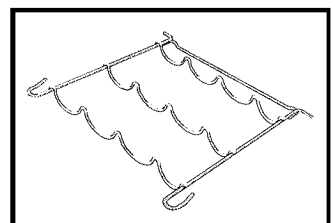

pic. 4)

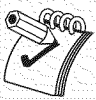

NOTE: If you wish to place bottles of above-average length on the bottle shelf, this must be set at a height which will not prevent the door from closing properly.

4.4 Refrigerator compartment defrosting water drain

The rear of the refrigerator compartment, underneath the refrigerating plate, has a channel and a hole for collecting the defrosting water. To ensure the refrigerator can function properly, take care never to block this hole. It is best to check and clean it regularly using a piece of stiff wire.

4.5 Fruit and vegetable box

This container is at the bottom of the refrigerator compartment, which is fitted with a glass shelf to cover fresh foods that require constant humidity for optimum storage.

4.6 Door shelves and containers

The inside of the door is fitted with special shelves and boxes to take eggs, butter, dairy products, tubes, preserves and other small packages. The bottom of the door has a shelf to take vertical bottles. To stop bottles from falling when the door is opened and closed, they must be secured with the special retainer rod supplied.

All door shelves and boxes can be removed for cleaning. To remove them from the door, tap them upward with your fist on one side of the insertion zone and then on the other.

- Do not place excessively heavy bottles on the bottle shelf;
- Place bottles on the shelf gently when loading them (pic. 5);
- When removing bottles, do not pull them in a diagonal direction as this may over-strain the retainer rod (pic. 6);
- Avoid dropping the bottles into place



pic. 5)

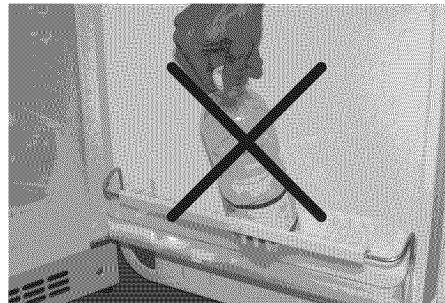

pic. 6)

4.7 Inside lighting

When the refrigerator door is open, the light comes on; it remains on until the door is completely closed again. The light comes on even if the refrigerator thermostat is set on "0" (STOP), meaning that the refrigerator is switched off.

4.8 Operating noise

The refrigerator and freezer are cooled by means of a compressor system. In order to maintain the preset temperature inside the refrigerator and freezer sections, the compressor comes into operation in response to the level of cooling required, and may operate continuously if necessary. When the compressor starts up a humming sound will be heard, tending to drop in volume after a few minutes.

Another normal refrigerator operating noise is a gurgling due to the coolant flowing through the pipes in the circuit. This noise is perfectly normal and does not mean that the appliance is malfunctioning. If it is over-loud, there may be other causes. In this case, check that:

- The refrigerator is properly leveled on the floor and does not vibrate when the compressor is in operation: **adjust the feet provided as appropriate;**
- The drawers, shelves and door boxes are correctly fitted and securely in place: **fit correctly;**
- **Bottles and containers on the various shelves are stable and not touching;** the vibration due to operation of the compressor may generate some noise;



5. REFRIGERATOR USE

5.1 Using the controls

The knob in the top right-hand corner of the refrigerator is used to set the operating temperature both in the refrigerator and in the freezer (pic. 7). When the knob is turned to 0 (STOP), the appliance is switched off.

The operating settings are from 1 to 7. These numbers do not mean temperatures, but just operating levels. The temperature inside the appliance gets reduced by increasing the operating level: The lowest temperature will therefore be reached by positioning the knob on 7.

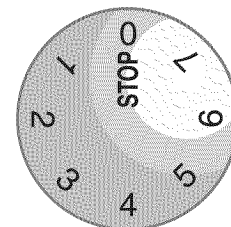

pic. 7)

Only use the highest (coldest) settings (6-7) if absolutely necessary: With these settings the temperatures inside the refrigerators compartment may be close to 32°F, and the electricity consumption will be higher. In normal operating conditions, a normal setting (2-3) is recommended to provide effective storage of fresh food in the main compartment and frozen food in the freezing compartment.

NOTE:

- Changes in wheather conditions (temperature and humidity) and the frequency at which the two compartments' door are opened may affect the refrigerator operating temperatures.
- Give your refrigerator time to cool down completely before adding food. It is best to wait 24 hours before you put food into the refrigerator.
- If you add food before the refrigerator has cooled completely, your food may spoil. Adjusting the Control to a higher (colder) level might not improve the performance of the appliance.

5.2 Storing fresh food



WARNING

Never store explosive substances in the appliance and high-alcohol drinks must only be stored sealed and vertical.

- Foods to be stored in the refrigerator should be properly packed as to prevent mixing various moisture degrees and odors (in polyethylene bags or sheet, aluminium foil, wax paper, or stored in covered containers or bottles).
- Never store inflammable, volatile or explosive substances.
- Beverages with high alcohol percentage shall be stored in tightly sealed bottles in vertical position.
- Food should not touch the rear wall of the refrigerator!
- Some organic solutions like volatile oils in lemon and orange peel, acid in butter etc. can cause damages when in contact with plastic surfaces or gaskets for longer period of time.
- Unpleasant odor inside the refrigerator is a sign that something is wrong with foods or that your refrigerator needs cleaning. Unpleasant odor can be eliminated or reduced by washing the interior of the refrigerator with a mild solution of water and vinegar. We also recommend using activated carbon filters to clean the air or to neutralize odors.
- If you plan a longer journey, make sure to remove quickly perishable articles of food out of the appliance before you leave.



Instructions for the User

EN

FRESH FOOD STORAGE TIME IN THE REFRIGERATOR

ARTICLE OF FOOD	STORAGE PERIOD (DAYS)													
	1	2	3	4	5	6	7	8	9	10	11	12	13	14
Butter	+	+	+	+	+	+	+	=	=	=	=	=		
Eggs	+	+	+	+	+	+	+	+	+	+	=	=	=	=
Meat: fresh uncut	+	+	=											
Meat: chopped	+	=												
Meat: smoked	+	+	+	+	+	+	+	+	+	+	=	=	=	=
Fish	+	=												
Marinade	+	+	+	+	+	+	+	+	+	+	=	=	=	=
Root	+	+	+	+	+	+	+	+	=	=	=	=	=	=
Cheese	+	+	+	+	=	=	=	=	=	=	=	=	=	=
Sweets	+	+	=	=	=	=								
Fruits	+	+	=	=	=	=	=	=	=	=				
Prepared dishes	+	+	=	=										

recommended storage time / = possible storage time

5.3 Freezing food



WARNING

Never touch frozen product straight from the freezer or put it in your mouth. Burn can occur due to very low temperatures.



NOTE: The maximum amount of fresh foods which can be frozen in a 24-hour period is indicated on the nameplate. Do not exceed the stated amount, as it reduces the freezer's efficiency and its capability of preserving the already frozen foods.

For models equipped with the intensive freezing switch: turn on the switch ❄️ and turn the thermostat knob to the position 5-7 twenty-four hours before you freeze a large quantity of fresh foods. After 24 hours have gone by, put in the fresh foods and after another 24 hours have gone by, turn off the switch and turn the thermostat knob to the desired position.

FROZEN FOOD STORAGE TIME IN THE FREEZER

FOOD	STORAGE PERIOD (IN MONTHS)											
	1	2	3	4	5	6	7	8	9	10	11	12
Vegetables								+	+	+		
Fruit										+	+	+
Bread - Confectionery			+									
Milk			+									
Ready-meals			+									
Meat: beef										+	+	+
veal								+	+	+		
pork				+	+	+						
poultry								+	+	+		
game						+	+	+				
minced meat				+								
Smoked sausage	+											
Fish: oily			+									
lean	+											
Offal		+										



5.4 Freezing compartment use

5.4.1 Refrigerator without intensive cooling switch

24 hours before freezing a large amount of fresh foods turn the thermostat to a setting between 5 and 7. After the 24 hours have passed, store the fresh foods and turn the thermostat knob to the setting of your choice

5.4.2 Refrigerator with intensive cooling switch

- 24 hours before freezing a large amount of fresh foods, turn on the switch on the thermostat regulator box. The function is enabled by putting the switch in the “❄️”, position, and is turned off by putting it back on the symbol 0.
- After turning on the intensive cooling function, turn the thermostat to a setting between 5 and 7.
- After the 24 hours have passed, store the fresh foods, turn off the switch and turn the thermostat knob to the setting of your choice.
- This procedure should be used the first time the refrigerator is turned on, and whenever it is turned on after a period out of use, to lower the temperature in the freezer compartment more quickly.

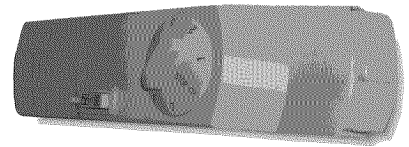

NOTE: Cooling fan and intensive freezing cannot operate at the same time.



5.4.3 Rapid freezing

- To activate this function press switch ❄️. When this function is set, the refrigerator operates continuously, allowing rapid freezing of fresh foods. Small amount of fresh foods (up to about 4,4lb / 2Kg.), can be frozen even without activating the rapid freezing function.
- To avoid wasting electricity, do not keep this function activated, unless absolutely necessary. The rapid freezing switch should be used the first time the freezer is switched on, and after a period of more than 7 days in which it wasn't used.

NOTE: Do not place fresh or frozen foods inside the freezing compartment until the red light – which indicates that the rapid freezing process is going on – has gone off.



5.5 Thawing frozen foods

- Partially thawed foods should be eaten as soon as possible. Low temperatures preserve foods but they do not destroy the micro-organisms which are activated after thawing, which may cause the stored foods to deteriorate. If thawed foods smell and look normal, they can be cooked and if required re-frozen once they have cooled.
- Depending on their type and intended use, frozen foods can be thawed correctly at room temperature, in the refrigerator, in an electric oven (conventional or fan), or in a microwave oven using the relevant function.

CAUTION: Do not refreeze frozen foods which have thawed completely





5.6 Making ice-cubes

Recommended thermostat setting for ice making is position between **3** and **5**.

Fill the ice cube tray (two thirds of it) with cold water or with any liquid suitable for freezing and insert the tray into the freezing compartment. Dry the bottom of the tray, as it may stick to the bottom of the freezing compartment.

The best method to get ice cubes out of the tray is to hold the tray under cold tap water for a second, turn it around and slightly bend it.

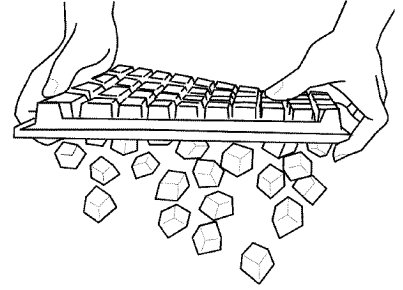



6. REFRIGERATOR CARE

6.1 Defrosting the refrigerator

The refrigerator compartment has automatic defrosting. During normal operation of the refrigerator, frost forms on its back wall when the compressor is working and dissolves when it is not in operation. When the compressor is not working, the frost which has built up on the back wall melts and the water flows into the opening provided in the bottom of the body of the refrigerator. From here, it flows into the tray on the compressor, where it evaporates.



NOTE: The amount of ice which forms on the inside back wall may vary with changes in weather conditions (temperature and humidity), how often the door is opened, the appliance operating temperatures and the amount of fresh foods stored inside (especially fruits and vegetables).

6.2 Defrosting the freezer

The freezer compartment has to be defrosted manually. When the thickness of frost or ice on the shelves exceeds 3/4" or 2 cm, the freezer should be defrosted. A few hours before defrosting, use the knob provided to set the thermostat on 7 in order to further lower the temperature of the frozen foods. Then turn the knob to the 0 (STOP) setting and disconnect the plug from the electrical mains. Remove the frozen foods from the freezer compartment and protect them from thawing while cleaning. Place a container underneath the pipe to collect the defrosted water.

6.3 Cleaning the refrigerator



WARNING



Explosion Hazard
Use nonflammable cleaner.
failure to do so can result in death, explosion, or fire.

Clean both refrigerator and freezer compartment about once a month to prevent odors from building up.

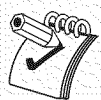

NOTE: Because air circulates between both sections, any odors formed in one section will transfer to the other. You must thoroughly clean both sections to eliminate odors. To prevent odor transfer and drying out of food, wrap or cover foods tightly.

To clean you refrigerator:

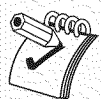

NOTE: Do not use abrasive or harsh cleaners such as window sprays, scouring cleaners, flammable fluids, celaning waxes, concentrated detergents, bleaches or cleansers containing petroleum products on plastic parts, interior and door liners or gasket. Do not use paper towels, scouring pads, or other harsh cleaning tools. Pay attention not to wet the electrical lighting components with water or other detergents.



Instructions for the User

EN

- 1 Unplug the refrigerator or disconnect the power;
- 2 Hand wash, rinse, and dry removable parts and interior surfaces thoroughly. Use a clean sponge or soft cloth and a mild detergent in warm water. Do not apply excessive strength when removing internal removable parts. Never wash removable plastic parts in the dishwasher;
- 3 Wash stainless steel and painted metal exteriors with a clean sponge or soft cloth and a mild detergent in warm water. Dry thoroughly with a soft cloth.

To allow the refrigerator to operate at full efficiency, periodically clean the condenser on the rear with a brush or a vacuum cleaner (pic. 8).

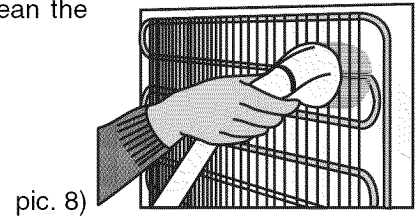

pic. 8)

Periodically check the tray above the compressor, and clean it if necessary (pic. 9).

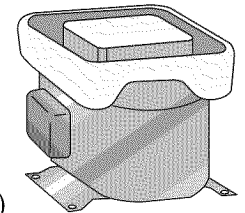

pic. 9)

6.4 Changing the inside light bulb

Before changing the bulb, make sure that the light has not stopped working simply because the part inside the lamp socket has become loose. In all cases, whether you wish to check that the socket is connected correctly or change the bulb, for safety reasons the plug must be removed from the power socket. Use your fingers to squeeze the cover (in the direction shown by the arrow 1) to remove it from its seat. Extract it (by pulling it in direction 2) and change the bulb (E14, max 15 W).

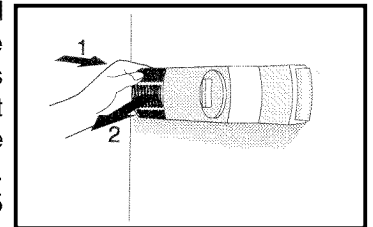

6.5 Power interruptions

If the power will be out for 24 hours or less, keep the door or doors closed (depending on your model) to help food stay cold and frozen.

If the power will be out for more than 24 hours, do one of the following:

- Remove all frozen food and store it in a frozen food locker.
- Place 2 lbs (907 g) of dry ice in the freezer for every cubic foot (28 L) of freezer space. This will keep the food frozen for 2 to 4 days.
- If neither a food locker nor dry ice is available, consume or can perishable food at once.

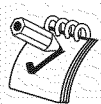

NOTE: A full freezer stays cold longer than a partially filled one. A freezer full of meat stays cold longer than a freezer full of baked goods. If you see that food contains ice crystals, it may be refrozen, although the quality and flavor may be affected. If the condition of the food is poor, dispose of it.



6.6 Vacation and moving care

6.6.1 Vacations

If you choose to leave the refrigerator on while you're away, use up any perishable and freezer other items.

Alternatively, you can choose to turn the refrigerator off before you leave, and follow these steps:

- 1 Remove all food from the refrigerator.
- 2 Turn the control knob to **0** (STOP).
- 3 Clean the refrigerator, wipe it and dry it well.
- 4 Tape rubber or wood blocks to the top of the door to prop it open far enough for air to get in. This stops odor and mold from building up.

6.6.2 Moving

When you are moving your refrigerator to a new home, follow these steps to prepare it for the move:

- 1 Remove all food from the refrigerator and pack all frozen food in dry ice.
- 2 Empty the ice bin,
- 3 Turn the control knob to **0** (STOP),
- 4 Unplug the refrigerator,
- 5 Empty water from the defrost pan,
- 6 Clean, wipe and dry thoroughly.
- 7 Take out all removable parts, wrap them well and tape them together so they don't shift and rattle during the move.



Instructions for the User

7. TROUBLESHOOTING

Try the solutions suggested here first in order to avoid the cost of an unnecessary service call.

 <p>WARNING</p>	<p>Electrical Shock Hazard Plug into a grounded 3 prong outlet. Do not remove ground prong. Do not use an adapter. Do not use an extension cord. Failure to follow these instructions can result in death, fire, or electrical shock.</p>
---	--

PROBLEM	POSSIBLE CAUSE	PROBABLE SOLUTION
Noisy operation The compressor starts up too often or operates continuously:	- compressor and condenser cooling inadequate:	- see "4.8 Operating noise" section - check that the rear of the appliance is properly ventilated as explained in point "3.2 Location requirements" and that the condenser is not over-dirty;
The compressor does not start up:	- rise in outside temperature; - doors opened often or for long periods; - too much fresh food placed in the appliance - temperature regulator on 0 (stop). - power supply lead not connected to the electrical mains; - mains socket not supplying electrical power.	- freeze less food at a time; - connect the lead to the power supply;
Refrigerator section not cooled sufficiently	- inside temperature setting thermostat set too low (1-2) (provides a higher temperature inside the appliance); - door opened often or for long periods; - door not closing properly - rise in outside temperature.	- contact the electricity supplier - Turn the regulator to an intermediate setting (4-5). - open the door less often and for as short a time as possible; - check that the foods are arranged on the shelves correctly and are not preventing the door from closing properly, and that the refrigerator is well levelled on the floor; - check that the gasket is sealing properly and is not damaged.
Water in bottom of refrigerator compartment:	"Condensation drain" opening blocked or frozen	- Clear the drain opening
Door hard to open just after closing:		- if you attempt to open the door again just after closing it (especially the freezer door), considerable strength is required. This is because of the vacuum caused by cooling of the warm air that has entered the appliance.



Instructions for the User

PROBLEM	POSSIBLE CAUSE	PROBABLE SOLUTION
Temperature inside freezer not low enough to freeze foods properly	<ul style="list-style-type: none">- inside temperature setting thermostat set too low;- door opened often or for long periods;- door not closing with an airtight seal;- too much sugar in foods for freezing	<ul style="list-style-type: none">- Turn the regulator to an intermediate setting (4-5).- open the door less often and for as short a time as possible;- check that the foods are arranged on the shelves correctly, that the gasket is sealing properly and is not damaged, and that the refrigerator is well levelled on the floor;- some foods can only be completely frozen at very low temperatures (ice-cream, concentrated fruit-juices)
Too much condensation forming in refrigerator section	<ul style="list-style-type: none">- check that the door gaskets are providing an airtight seal on the refrigerator;- door opened often or for long periods;- too much fresh food (fruit and vegetables) placed on the shelves.- Foods not properly covered or stored in airtight containers	<ul style="list-style-type: none">- In case of cracks, try to soften the gasket by pulling it with one hand and sliding your closed fingers along the inside- open the door less often and for shorter times, especially when the appliance is working in warm, humid conditions;- place less food inside the refrigerator section;- Cover the containers and seal foods.
Temperature inside refrigerator section too cold - fresh foods are freezing:	<ul style="list-style-type: none">- cooling temperature regulator device set too high (meaning lower temperature inside the appliance)	<ul style="list-style-type: none">- Turn the regulator to a lower setting (1-2).- cover foods using suitable bags and containers;- do not place fruit and vegetables inside when too wet- do not place foods inside touching the back of the refrigerator.



Instructions for the User

PROBLEM	POSSIBLE CAUSE	PROBABLE SOLUTION
Too much ice forming on back wall of refrigerator section (layer of frost more than 1 cm thick):	<ul style="list-style-type: none">- Cooling temperature regulator device set too high (meaning lower temperature inside the appliance);- door opened often or for long periods;	<ul style="list-style-type: none">- Turn the regulator to a lower setting (1-2) to increase the temperature inside the appliance slightly;- check that the gaskets are providing an airtight seal;- open the door less often and for shorter times;- rise in atmospheric temperature and humidity;- do not place hot food or drinks inside the refrigerator;
Too much ice forming in freezer	<ul style="list-style-type: none">- inside temperature setting thermostat set on too low a temperature;	<ul style="list-style-type: none">- Turn the regulator to a lower setting (1-2) to increase the temperature inside the appliance slightly;- check that the gaskets are providing an airtight seal: If they are cracked, try to soften the gasket by pulling it with one hand and sliding your closed fingers along the inside;- open the door less often and for shorter times;- rise in atmospheric temperature and humidity;- do not place hot food or drinks inside the freezer;
Front of cabinet hot to the touch		<ul style="list-style-type: none">- the refrigerator is operating normally. Inside the cabinet there is a surface cooling system designed to restrict the formation of condensation in the area where the door gasket closes.



Instructions for the User

PROBLEM	POSSIBLE CAUSE	PROBABLE SOLUTION
Condensation forming on the gasket of the freezer compartment door or on the wall of the freezer compartment next to the door	The gasket is not providing an airtight seal on the freezer compartment.	<ul style="list-style-type: none">- Adjust the hinge if necessary: undo the two screws and raise or lower the hinge slightly as required. Then tighten the screws to fix it in place. If the condensation is on the top, raise the hinge; if it is on the bottom, lower it.- open the door less often and for shorter times, especially in warm, humid weather conditions;

AFTER-SALES SERVICE – READING THE NAMEPLATE.

IF THE PROBLEMS WITH THE PRODUCT YOU HAVE PURCHASED ARE NOT AMONGST THOSE DESCRIBED ABOVE AND IF YOU NEED MORE INFORMATION, PLEASE CONTACT THE AUTHORISED AFTER-SALES SERVICE. YOU WILL FIND THE ADDRESS AND TELEPHONE IN YOUR LOCAL TELEPHONE DIRECTORY UNDER **SMEG**.

TO SPEED UP THE SERVICE, PLEASE BE READY TO INFORM OUR CALL SERVICE OPERATORS OF THE MODEL OF THE PRODUCT YOU HAVE PURCHASED AND THE SERIAL NUMBER MARKED ON THE NAMEPLATE INSIDE THE BODY OF THE REFRIGERATOR. THANK YOU IN ADVANCE FOR YOUR ASSISTANCE.