

SEARS

OWNERS
MANUAL

MODEL NO.
833.14334

CAUTION:
Read Rules for
Safe Operation
and Instructions
Carefully

557-5199

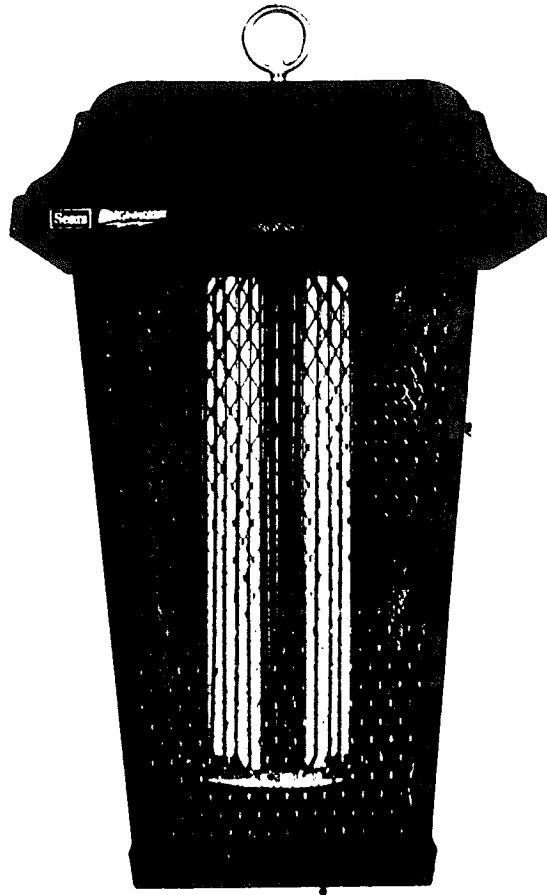

BIGWACKER

ELECTRONIC INSECT KILLER

- Operating Instructions
- Repair Parts

Sold by SEARS, ROEBUCK AND CO., Chicago, IL. 60684 U.S.A.

For Best Results, Read This Manual Before Installing Your New Sears Bugwacker

Full One Year Warranty

If, within one year from the date of purchase, this electronic insect killer fails due to a defect in materials or workmanship, Sears will repair it free of charge.

Warranty service is available by simply returning your unit to the nearest Sears store or Service Center throughout the United States. This warranty gives you specific legal rights, and you may also have other rights which vary from state to state.

Sears, Roebuck and Co.
Department 698/731A
Sears Tower, Chicago, IL 60684

RULES FOR SAFE USE OF BUGWACKER®

1. Install the unit 6 to 8 feet above the ground to prevent children, pets and wildlife from coming in contact with it.
2. Use grounded 115/120 volt AC outlet and 3-wire grounded extension cord. For permanent installation, check local codes and consult an electrician or authoritative instruction book before installing.
3. Never place fingers or hands, or insert any objects into the unit while it is connected to electrical outlet.
4. Always disconnect the unit before servicing, handling or disassembling unit.
5. Clean dead insects from bottom of unit frequently to reduce risk of fire.
6. Connect unit to properly grounded outlet only.
7. Keep extension cord connections dry and off the ground.
8. Don't abuse power cord. Never carry unit by cord or yank it to disconnect from receptacle.
9. Keep power cord from heat, oil and sharp edges.

ASSEMBLY

1. Remove Bugwacker from carton and check to make sure no transportation damages have occurred.

The carton should contain the following:

- 1 - Bugwacker electronic bug killer
- 2 - Plastic bag containing the following:
 - 1 - gold colored hanging ring
 - 1 - threaded fitting

Save your carton and the cardboard fillers for storing your Bugwacker during the off-season.

2. Refer to Illustration A.

- A. Assemble the threaded fitting (2) into gold colored hanging ring (1).
- B. Screw hanging ring and fitting into hole in hood and tighten until snug.

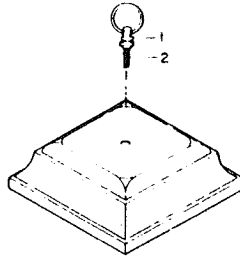

INSTALLATION

1. Your Bugwacker should be hung or post mounted from a pole, bracket or post mounted from a pole, bracket or post (available as accessories) at a height of 6 to 8 feet above the ground. This is the flying altitude for many types of light-sensitive insects and will increase the unit's effectiveness.
2. Plug electrical cord into a three-wire grounded outdoor extension cord. Lamp will emit a soft bluish glow.

Note: A momentary arc may occur across the high voltage grids when first plugged in. This is due to the surge of electricity. It will stop and resume normal operation.

3. Refer to Illustration B. Placement of the unit is essential to its maximum effectiveness. Since the Bugwacker is a luring device, it should not be located in the area intended for human activity. It should be placed 25 to 50 feet away, and between the source of insects (i.e. woods, lowlands, etc.) and the areas to be protected.

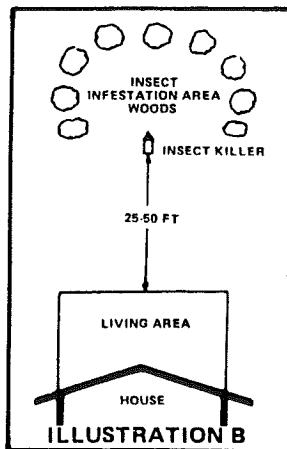

If additional light is required in the area of human activity, it should be provided by yellow light. Studies have shown that insects are less attractive to yellow light.

4. Sears Bugwackers are ideal for backyards, pools, patios, summer homes, trailer homes, campgrounds, marinas, outdoor recreational areas, gardens or anywhere flying insects are a problem.

EXTENSION CORDS

Outdoor extension cords must be used with this Bugwacker. Use extension cords marked SJW-A, or SJTW-A and tagged "suitable for use with outdoor appliances".

The electrical rating of the extension cord must be as great as the electrical rating of your Bugwacker.

Use only three-wire extension cords which have three-prong grounding type plugs and three-pole receptacles which accept the products plug.

Appropriate extension cords and devices for retaining an extension cord connection to the Bugwacker power cord are available at your local Sears store. Replace or repair damaged cords.

GROUNDING INSTRUCTIONS

Your Bugwacker is equipped with an appropriate three-conductor cord and three-prong grounding type plug to fit the proper grounding type receptacle. To reduce the risk of electrical shock, plug must be plugged into an appropriate outlet that is properly installed and grounded.

Your Bugwacker has a grounding plug that looks like the plug shown below and is intended for use on a circuit that has an outlet as shown below.

GROUNDING RECEPTACLE

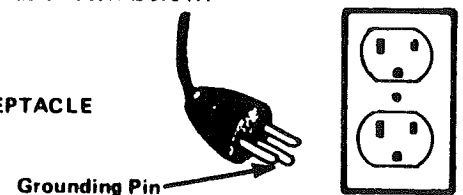

Consult a qualified electrician or serviceman if the grounding instructions are not completely understood, or if doubt as to whether proper grounding exists.

OPERATION

1. **General:** Your new Sears Bugwacker is designed to attract light-sensitive flying insects with black light, and to kill them cleanly without the use of poisons, fogs, sprays or chemicals.

Insects are drawn to the fluorescent bulb, and killed by an electrostatic grid when they pass through it. The insects do not have to actually touch the grid to be killed. The moisture in their bodies is enough to trigger the arc, so that even the tiniest of bugs are eliminated.

The handsome, lantern-styled Bugwacker sheds a soft, glowing decorative light which is harmless to your eyes and costs only pennies a day to enjoy. The 70 watts of Black Light energy make this unit a powerful insect killer that is ecologically safe, effective and economical to operate.

2. **Night Flying Insects:** Night flying insects such as mosquitoes, gnats, moths, etc., respond to the black light rays emitted by the Bugwacker's ultra-violet bulbs. These insects are sensitive to light, and take cover during the heat of day in grass, shrubs and other foliage.



Skeeter Lure accessory Stock no. 14305 manually operated or Stock no. 14306 fully automatic with photo cell included. 4 times as effective in luring and killing biting mosquitoes than Bugwacker alone. Emits moisture, heat and carbon dioxide, which makes the mosquitoes respond to the light as if a human were there.

3. **Day Flying Insects:** Day flying insects such as flies, hornets, beetles and wasps do not respond mainly to black light rays as do night flying insects. These insects respond more to odor.

Your Bugwacker can be equipped to attract these insects by use of a bait tray available as an accessory.

Note: Bait tray cannot be used when Bugwacker is post mounted.

Hornets, beetles or wasps can be lured with bait consisting of honey, syrup, perfume or a mixture of sugar and water

House Flies can be lured with meat or fish scraps or with a special pheromone available as an accessory, (Stock no. 14322), at your Sears retail store. This fly pheromone acts as a sex attractant, and is effective in luring houseflies, blowflies, garbage flies and many other types commonly found in yards and barns.

Stable Flies can be lured to Bugwacker by using stable fly attractant accessory (Stock no. 14323), available at your Sears store.

Gypsy moths can be lured during daylight hours with a gypsy moth sex pheromone available as an accessory (Stock no. 14321) at your Sears retail store. Use of this pheromone also increases the effectiveness of the Bugwacker in attracting and killing this pest during evening hours.

4. Most insect pests have a breeding cycle of ten to fourteen days. Daily operation of your Bugwacker is recommended to reduce insect population by interrupting this breeding cycle.

Night flying insects become active at dusk and again just prior to dawn. For maximum effectiveness, operate your Bugwacker 24 hours a day or use photocell for automatic operation.

5. **Automatic "ON/OFF" Feature:** Refer to Illustration C. Your Sears Bugwacker is equipped with a photoelectric cell that turns the bulb ON at dusk and OFF at dawn. To activate this control, insert a pencil or insulated screwdriver through the outer protected screen and move the switch to the "ON" position.

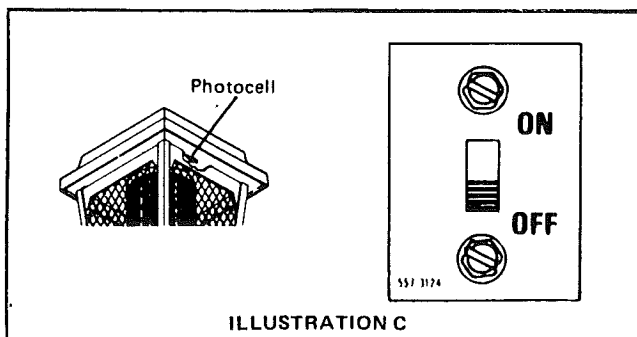

ILLUSTRATION C

6. The insect killer is designed and U.L. Listed for year-round outdoor use and will not be damaged by rain or moisture. If, during heavy rain, excessive arcing occurs and is objectionable, simply disconnect unit.

MAINTENANCE

1. **Cleaning:** Your Sears Bugwacker is equipped with self-cleaning grids, and requires no special maintenance other than cleaning insect debris from the bottom of the unit. This should be done frequently using a small brush or blower such as portable hair dryer, or the exhaust attachment of a vacuum cleaner. **BE SURE TO UNPLUG THE UNIT BEFORE CLEANING.**

Bait or collection trays, if used, should be emptied often to reduce the risk of fire.

2. **Bulb Replacement:** Bulb life is approximately 4500 hours. However, **bulb should be replaced every season to ensure maximum output** invisible ultra-violet, or "black light", frequency range.

3. Store your Bugwacker indoors when not in use — out of reach of children. Do not clean your Bugwacker with a water spray or the like.

BULB REPLACEMENT

Refer to Illustration D.

1. Disconnect unit from electric source.
2. Depress latch and remove plastic cover at base of unit.
3. Remove rubber boot from bottom of bulb. Bulb can now be pulled down out of the upper socket.
4. Insert bulb. Replace rubber boot. Fit bulb into upper socket.
5. Replace plastic cover and secure latch.

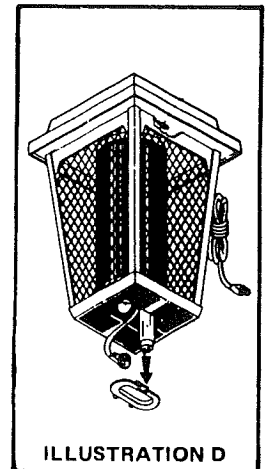
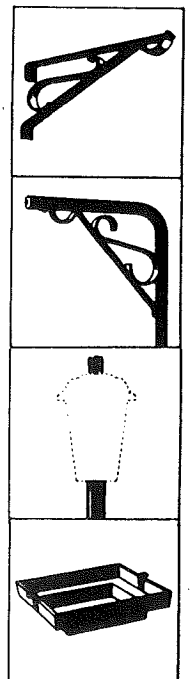

ILLUSTRATION D

ACCESSORIES

Accessories available for your Bugwacker include:

1. **Wall Bracket**, Stock no. 1473 — a welded steel bracket with a unique locking feature to help prevent theft.
2. **Lantern Pole**, Stock no. 14301 — a 1¼ inch diameter steel tube with a welded steel scroll and a unique locking feature to help prevent theft.
3. **Lantern Post**, Stock no. 14302 — a 3-inch diameter steel tube with a universal mounting adapter and a gold colored eagle top trim.
4. **Bait/Collection Tray**, Stock no. 14304 — snaps on and off for easy removal. Durable all-weather construction.



SEARS ELECTRONIC INSECT KILLER – MODEL NO. 833.14334

REF. NO.	PART NO.	DESCRIPTION	QTY.
1	554 722	HANGING RING	1
2	596 1565 P02	THREADED NIPPLE, 1" LONG	1
3	567 420	NEOPRENE WASHER	1
4	596 784	REDUCING BUSHING	1
5	555 5314 SR	HOOD	1
6	245 6260 P27	THREAD CUTTING SCREW, F, 8-32 x 3/8	4
7	596 785	LOCKNUT	1
8	544 5288	GRID SPACER	5
9	544 3750	SPACER INSULATOR	2
10	245 6245 P28	SHEET METAL SCREW, NO. 8 x 1/2	8
11	532 3006	BALLAST	2
12	576 4890	TRANSFORMER	1
13	505 3370	BULB SOCKET ASSY	2
14	552 3369 P03	REFLECTOR	2
15	555 3534	BULB RETAINER	1
16	512 392 P26	BULB BOOT WIRE, 26" LONG	2
17	552 5202	TOP PLATE	1
18	531 2034	STARTER	2
19	512 5140	POWER CORD	1
20	571 5170	STARTER SOCKET	2
21	245 6236 P11	SHEET METAL SCREW, NO. 6 x 3/8	3
22	544 3749	MOUNTING INSULATOR	3
23	245 6245 P12	SHEET METAL SCREW, NO. 6 x 1/2	3
24	512 404 P02	HV GRID WIRE	2
25	530 2815 S	BULB, BLACK LIGHT	2
26	553 2846 P01	INNER GRID	1
27	553 2847 P01	OUTER GRID	1
28	505 3377	BASKET ASSY	1
29	505 4031	PHOTOCELL ASSY	1
30	245 6260 P25	THREAD CUTTING SCREW, F, 8-32 x 1/4	2
31	557 5199	OWNER'S MANUAL	1

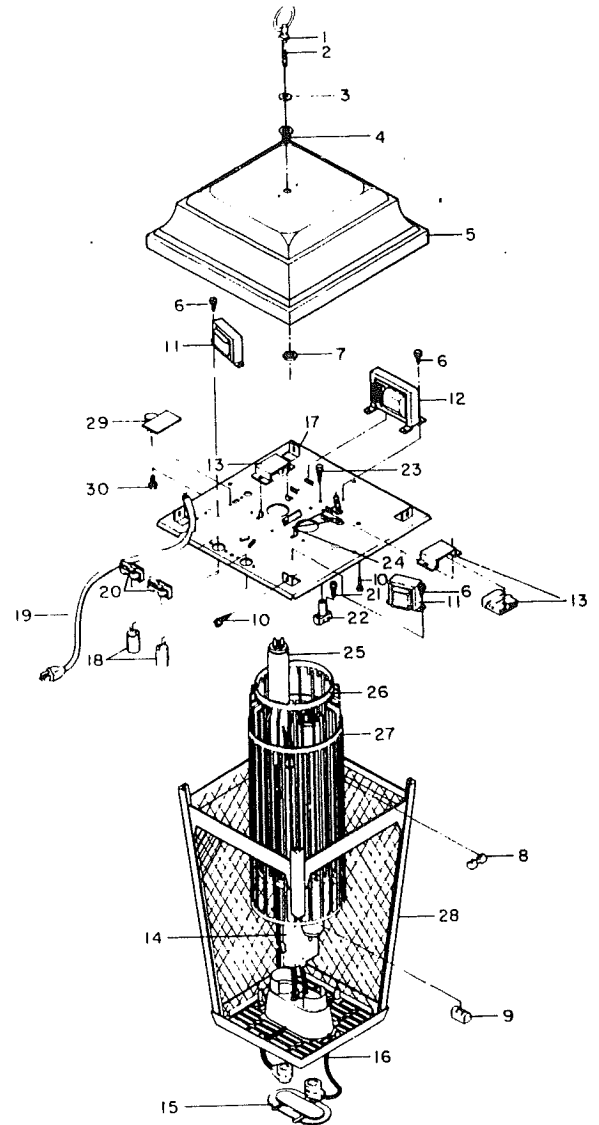

TROUBLESHOOTING AND REPAIR ANALYSIS

PROBLEM	POSSIBLE CAUSE	CORRECTION
A. Bulbs do not light and no high voltage on grid.	1. No electrical power.	1. Check fuse or circuit breaker. 2. Check extension cord. (If used.)
B. Bulbs light but no grid high voltage.	1. Shorted grids.	1. Examine grids to see if inner and outer grids are free from foreign material, dirt or a build-up of dead insects. 2. Check to make sure inner grid and outer grid are not touching. Use insulated screwdriver.
C. Grid voltage present but bulbs do not light.	1. Lamp(s) not seated properly. 2. Starter defective. 3. Burned-out bulb(s).	1. Check all sockets for proper seating and alignment. 2. Replace if needed. 3. Replace if needed.
D. Intermittent or continuous sparking between grids.	1. Gap between grids is too small. 2. Grid clogged with foreign material. 3. Grid not seated in insulator.	1. Unplug unit and adjust grids by bending back into alignment using screwdriver blade. 2. Clean grid using an air blower. 3. Look for proper grid seating at all insulators.

Any problems you encounter that are not corrected by the action recommended in this chart should be referred to your nearest Sears Service Center.

SEARS

**OWNERS
MANUAL**

**MODEL NO.
833.14334**

**HOW TO ORDER
REPAIR PARTS**

BUGWACKER

ELECTRONIC INSECT KILLER

The Model Number will be found on label attached to the upper section of the unit. Always mention the Model Number when requesting service or repair parts for your ELECTRONIC INSECT KILLER.

All parts listed herein may be ordered from any Sears Service Center and most Sears stores.

**WHEN ORDERING REPAIR PARTS, ALWAYS
GIVE THE FOLLOWING INFORMATION:**

- | | |
|----------------------------|--|
| 1. PART NUMBER | 3. MODEL NUMBER
833.14334 |
| 2. PART DESCRIPTION | 4. NAME OF ITEM
ELECTRONIC INSECT KILLER |

If the parts you need are not stocked locally, your order will be electronically transmitted to a Sears Repair Parts Distribution Center for "expedited handling".

Sold by SEARS, ROEBUCK AND CO., Chicago, IL. 60684 U.S.A.