

# SHARP®

## LC-32SB27UT

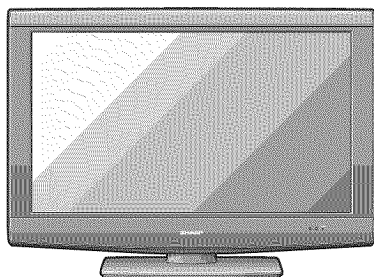

LIQUID CRYSTAL  
TELEVISION

### OPERATION MANUAL ENGLISH



**NOM** 1245



**IMPORTANT** : Please read this operation manual  
before starting operating the equipment.

## Supplied Accessories

Make sure the following accessories are provided with the product.



Remote control unit  
(×1)  
Page 8



"AA" size battery  
(×2)  
Page 9



AC cord  
(×1)  
Page 8



Stand unit  
(×1)  
Page 7



Operation manual  
(×3 languages)

#### NOTE

- Always use the AC cord supplied with the TV.

To avoid scratching the frame or screen, please use a soft, lint free cloth for cleaning. Approved cleaning cloths are available directly from Sharp in single (00Z-LCD-CLOTH) or triple (00Z-LCD-CLOTH-3) packs. Call 1-800-BE-SHARP for ordering, or VISIT [www.sharpusa.com/SharpDirect](http://www.sharpusa.com/SharpDirect).

**IMPORTANT:**

To aid reporting in case of loss or theft, please record the TV's model and serial numbers in the space provided. The numbers are located at the rear of the TV.

Model No.:

Serial No.:

# IMPORTANT INFORMATION

**WARNING:** TO REDUCE THE RISK OF FIRE OR ELECTRIC SHOCK, DO NOT EXPOSE THIS PRODUCT TO RAIN OR MOISTURE.



**CAUTION**

RISK OF ELECTRIC SHOCK  
DO NOT OPEN



CAUTION: TO REDUCE THE RISK OF ELECTRIC SHOCK,  
DO NOT REMOVE COVER (OR BACK).  
NO USER-SERVICEABLE PARTS INSIDE.  
REFER SERVICING TO QUALIFIED SERVICE  
PERSONNEL.



The lightning flash with arrow-head symbol, within an equilateral triangle, is intended to alert the user to the presence of uninsulated "dangerous voltage" within the product's enclosure that may be of sufficient magnitude to constitute a risk of electric shock to persons.



The exclamation point within a triangle is intended to alert the user to the presence of important operating and maintenance (servicing) instructions in the literature accompanying the product.

**CAUTION:** TO PREVENT ELECTRIC SHOCK, MATCH WIDE BLADE OF PLUG TO WIDE SLOT, FULLY INSERT.

**WARNING:** FCC Regulations state that any unauthorized changes or modifications to this equipment not expressly approved by the manufacturer could void the user's authority to operate this equipment.

**CAUTION:** This product satisfies FCC regulations when shielded cables and connectors are used to connect the unit to other equipment. To prevent electromagnetic interference with electric appliances such as radios and televisions, use shielded cables and connectors for connections.

# IMPORTANT INFORMATION

## DECLARATION OF CONFORMITY:

SHARP LIQUID CRYSTAL TELEVISION, MODEL LC-32SB27UT

This device complies with Part 15 of the FCC Rules. Operation is subject to the following two conditions:

(1) This device may not cause harmful interference, and (2) this device must accept any interference received, including interference that may cause undesired operation.

## RESPONSIBLE PARTY:

SHARP ELECTRONICS CORPORATION

Sharp Plaza, Mahwah, New Jersey 07495-1163

TEL: 1-800-BE-SHARP

For Business Customers: URL <http://www.sharppusa.com>

## INFORMATION:

This equipment has been tested and found to comply with the limits for a Class B digital device, pursuant to Part 15 of the FCC Rules. These limits are designed to provide reasonable protection against harmful interference in a residential installation. This equipment generates, uses and can radiate radio frequency energy and, if not installed and used in accordance with the instructions, may cause harmful interference to radio communications. However, there is no guarantee that interference will not occur in a particular installation. If this equipment does cause harmful interference to radio or television reception, which can be determined by turning the equipment off and on, the user is encouraged to try to correct the interference by one or more of the following measures:

- Reorient or relocate the receiving antenna.
- Increase the separation between the equipment and receiver.
- Connect the equipment into an outlet on a circuit different from that to which the receiver is connected.
- Consult the dealer or an experienced radio/TV technician for help.

"Note to CATV system installer: This reminder is provided to call the CATV system installer's attention to Article 820-40 of the National Electrical Code that provides guidelines for proper grounding and, in particular, specifies that the cable ground shall be connected to the grounding system of the building, as close to the point of cable entry as practical."

This product utilizes tin-lead solder, and fluorescent lamp containing a small amount of mercury. Disposal of these materials may be regulated due to environmental considerations. For disposal or recycling information, please contact your local authorities, the Electronic Industries Alliance: [www.eiae.org](http://www.eiae.org), the lamp recycling organization: [www.lamprecycle.org](http://www.lamprecycle.org) or Sharp at 1-800-BE-SHARP (For U.S.A. only)

## Trademarks

• Manufactured under license from Dolby Laboratories. "Dolby" and the double-D symbol are trademarks of Dolby Laboratories.

• "HDMI, the HDMI logo and High-Definition Multimedia Interface are trademarks or registered trademarks of HDMI Licensing LLC."

• Products that have earned the ENERGY STAR® are designed to protect the environment through superior energy efficiency.

# DEAR SHARP CUSTOMER

Thank you for your purchase of the Sharp Liquid Crystal Television. To ensure safety and many years of trouble-free operation of your product, please read the Important Safety Instructions carefully before using this product.

## IMPORTANT SAFETY INSTRUCTIONS

Electricity is used to perform many useful functions, but it can also cause personal injuries and property damage if improperly handled. This product has been engineered and manufactured with the highest priority on safety. However, improper use can result in electric shock and/or fire. In order to prevent potential danger, please observe the following instructions when installing, operating and cleaning the product. To ensure your safety and prolong the service life of your Liquid Crystal Television, please read the following precautions carefully before using the product.

- 1) Read these instructions.
- 2) Keep these instructions.
- 3) Heed all warnings.
- 4) Follow all instructions.
- 5) Do not use this apparatus near water.
- 6) Clean only with dry cloth.
- 7) Do not block any ventilation openings. Install in accordance with the manufacturer's instructions.
- 8) Do not install near any heat sources such as radiators, heat registers, stoves, or other apparatus (including amplifiers) that produce heat.
- 9) Do not defeat the safety purpose of the polarized or grounding-type plug. A polarized plug has two blades with one wider than the other. A grounding type plug has two blades and a third grounding prong. The wide blade or the third prong are provided for your safety. If the provided plug does not fit into your outlet, consult an electrician for replacement of the obsolete outlet.
- 10) Protect the power cord from being walked on or pinched particularly at plugs, convenience receptacles, and the point where they exit from the apparatus.
- 11) Only use attachments/accessories specified by the manufacturer.
- 12) Use only with the cart, stand, tripod, bracket, or table specified by the manufacturer, or sold with the apparatus. When a cart is used, use caution when moving the cart/apparatus combination to avoid injury from tip-over.
- 13) Unplug this apparatus during lightning storms or when unused for long periods of time.
- 14) Refer all servicing to qualified service personnel. Servicing is required when the apparatus has been damaged in any way, such as power-supply cord or plug is damaged, liquid has been spilled or objects have fallen into the apparatus, the apparatus has been exposed to rain or moisture, does not operate normally, or has been dropped.



### Additional Safety Information

- 15) Power Sources—This product should be operated only from the type of power source indicated on the marking label. If you are not sure of the type of power supply to your home, consult your product dealer or local power company. For products intended to operate from battery power, or other sources, refer to the operating instructions.
- 16) Overloading—Do not overload wall outlets, extension cords, or integral convenience receptacles as this can result in a risk of fire or electric shock.
- 17) Object and Liquid Entry—Never push objects of any kind into this product through openings as they may touch dangerous voltage points or short-out parts that could result in a fire or electric shock. Never spill liquid of any kind on the product.
- 18) Damage Requiring Service—Unplug this product from the wall outlet and refer servicing to qualified service personnel under the following conditions:
  - a) When the AC cord or plug is damaged,
  - b) If liquid has been spilled, or objects have fallen into the product,
  - c) If the product has been exposed to rain or water,
  - d) If the product does not operate normally by following the operating instructions.  
Adjust only those controls that are covered by the operating instructions as an improper adjustment of other controls may result in damage and will often require extensive work by a qualified technician to restore the product to its normal operation,
  - e) If the product has been dropped or damaged in any way, and
  - f) When the product exhibits a distinct change in performance - this indicates a need for service.
- 19) Replacement Parts—When replacement parts are required, be sure the service technician has used replacement parts specified by the manufacturer or have the same characteristics as the original part. Unauthorized substitutions may result in fire, electric shock, or other hazards.
- 20) Safety Check—Upon completion of any service or repairs to this product, ask the service technician to perform safety checks to determine that the product is in proper operating condition.
- 21) Wall or ceiling mounting—When mounting the product on a wall or ceiling, be sure to install the product according to the method recommended by the manufacturer.

# IMPORTANT SAFETY INSTRUCTIONS

- **Outdoor Antenna Grounding** — If an outside antenna is connected to the television equipment, be sure the antenna system is grounded so as to provide some protection against voltage surges and built-up static charges. Article 810 of the National Electrical Code, ANSI/NFPA 70, provides information with regard to proper grounding of the mast and supporting structure, grounding of the lead-in wire to an antenna discharge unit, size of grounding conductors, location of antenna-discharge unit, connection to grounding electrodes, and requirements for the grounding electrode.

EXAMPLE OF ANTENNA GROUNDING AS PER NATIONAL ELECTRICAL CODE, ANSI/NFPA 70

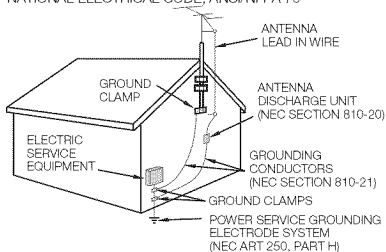

NEC — NATIONAL ELECTRICAL CODE

- Turn off the main power and unplug the AC cord from the wall outlet before handling.
- Use a soft cloth and gently wipe the surface of the display panel. Using a hard cloth may scratch the panel surface.
- Use a soft damp cloth to gently wipe the panel when it is really dirty. (It may scratch the panel surface when wiped strongly.)
- If the panel is dusty, use an anti-static brush, which is commercially available, to clean it.
- To protect the panel, do not use a dirty cloth, liquid cleaners or chemical cloth to clean it, such materials may damage the panel surface.
- To clean the outer cabinet, use the same method. Do not use liquid or aerosol cleaners.



- **Water and Moisture** — Do not use this product near water - for example, near a bath tub, wash bowl, kitchen sink, or laundry tub; in a wet basement; or near a swimming pool; and the like.
- **Stand** — Do not place the product on an unstable cart, stand, tripod or table. Placing the product on an unstable base can cause the product to fall, resulting in serious personal injuries as well as damage to the product. Use only a cart, stand, tripod, bracket or table recommended by the manufacturer or sold with the product. When mounting the product on a wall, be sure to follow the manufacturer's instructions. Use only the mounting hardware recommended by the manufacturer.
- **Selecting the location** — Select a place with no direct sunlight and good ventilation.
- **Ventilation** — The vents and other openings in the cabinet are designed for ventilation. Do not cover or block these vents and openings since insufficient ventilation can cause overheating and/or shorten the life of the product. Do not place the product on a bed, sofa, rug or other similar surface, since they can block ventilation openings. This product is not designed for built-in installation; do not place the product in an enclosed place such as a bookcase or rack, unless proper ventilation is provided or the manufacturer's instructions are followed.
- The Liquid Crystal panel used in this product is made of glass. Therefore, it can break when the product is dropped or applied with impact. Be careful not to be injured by broken glass pieces in case the panel breaks.
- **Heat** — The product should be situated away from heat sources such as radiators, heat registers, stoves, or other products (including amplifiers) that produce heat.
- The Liquid Crystal panel is a very high technology product with 1,049,088 pixels, giving you fine picture details. Occasionally, a few non-active pixels may appear on the screen as a fixed point of blue, green or red. Please note that this does not affect the performance of your product.
- **Lightning** — For added protection for this television equipment during a lightning storm, or when it is left unattended and unused for long periods of time, unplug it from the wall outlet and disconnect the antenna. This will prevent damage to the equipment due to lightning and power-line surges.
- **Power Lines** — An outside antenna system should not be located in the vicinity of overhead power lines or other electric light or power circuits, or where it can fall into such power lines or circuits. When installing an outside antenna system, extreme care should be taken to keep from touching such power lines or circuits as contact with them might be fatal.
- To prevent fire, never place any type of candle or flames on the top or near the TV set.
- To prevent fire or shock hazard, do not place the AC cord under the TV set or other heavy items.
- Do not display a still picture for a long time, as this could cause an afterimage to remain.
- To prevent fire or shock hazard, do not expose this product to dripping or splashing.
- No objects filled with liquids, such as vases, should be placed on the product.
- Do not insert foreign objects into the product. Inserting objects in the air vents or other openings may result in fire or electric shock. Exercise special caution when using the product around children.

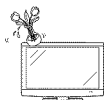

## Precautions when transporting the TV

- When transporting the TV, never carry it by holding or otherwise putting pressure onto the display. Be sure to always carry the TV by two people holding it with two hands — one hand on each side of the TV.

# IMPORTANT SAFETY INSTRUCTIONS

## CHILD SAFETY:

### It Makes A Difference How and Where You Use Your Flat Panel Display

Congratulations on your purchase! As you enjoy your new product, please keep these safety tips in mind:



#### THE ISSUE

- The home theater entertainment experience is a growing trend and larger flat panel displays are popular purchases. However, flat panel displays are not always supported on the proper stands or installed according to the manufacturer's recommendations.
- Flat panel displays that are inappropriately situated on dressers, bookcases, shelves, desks, speakers, chests or carts may fall over and cause injury.

#### THIS MANUFACTURER CARES!

- The consumer electronics industry is committed to making home entertainment enjoyable and safe.

#### TUNE INTO SAFETY

- One size does NOT fit all. Follow the manufacturer's recommendations for the safe installation and use of your flat panel display.
- Carefully read and understand all enclosed instructions for proper use of this product.
- Don't allow children to climb on or play with furniture and television sets.
- Don't place flat panel displays on furniture that can easily be used as steps, such as a chest of drawers.
- Remember that children can become excited while watching a program, especially on a "larger than life" flat panel display. Care should be taken to place or install the display where it cannot be pushed, pulled over, or knocked down.
- Care should be taken to route all cords and cables connected to the flat panel display so that they cannot be pulled or grabbed by curious children.

#### WALL MOUNTING: IF YOU DECIDE TO WALL MOUNT YOUR FLAT PANEL DISPLAY, ALWAYS:

- Use a mount that has been recommended by the display manufacturer and/or listed by an independent laboratory (such as UL, CSA, ETL).
- Follow all instructions supplied by the display and wall mount manufacturers.
- If you have any doubts about your ability to safely install your flat panel display, contact your retailer about professional installation.
- Make sure that the wall where you are mounting the display is appropriate. Some wall mounts are not designed to be mounted to walls with steel studs or old cinder block construction. If you are unsure, contact a professional installer.
- A minimum of two people are required for installation. Flat panel displays can be heavy.

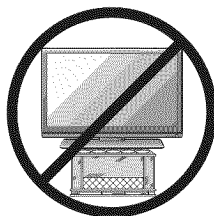

**Note:** CEA is the preeminent trade association promoting growth in the \$161 billion U.S. consumer electronics industry. More than 2,200 companies enjoy the benefits of CEA membership, including legislative advocacy, market research, technical training and education, industry promotion and the fostering of business and strategic relationships.

# QUICK REFERENCE

## Attaching/Detaching the Stand

- Before attaching (or detaching) the stand, unplug the AC cord from the AC INPUT terminal.
- Before performing work spread cushioning over the base area to lay the TV on. This will prevent it from being damaged.

### CAUTION

- Attach the stand in the correct direction.
- Do not remove the stand from the TV unless using an optional wall mount bracket to mount it.
- Be sure to follow the instructions. Incorrect installation of the stand may result in the TV falling over.

- 1 Confirm that there are 4 screws supplied with the stand unit.



- 2 ① Insert the stand into the openings on the bottom of the TV.

- Be sure to attach the stand to the TV with the wider side of the base facing forward.

- ② Insert and tighten the 4 screws into the 4 holes on the bottom of the stand.

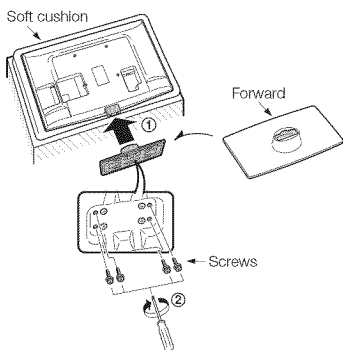

### NOTE

- To detach the stand, perform the steps in reverse order.

## Setting the TV on the Wall

### CAUTION

- This TV should be mounted on the wall only with the AN-37AG5 (SHARP) wall mount bracket. The use of other wall mount brackets may result in an unstable installation and may cause serious injuries.
- Installing the TV requires special skill that should only be performed by qualified service personnel. Customers should not attempt to do the work themselves. SHARP bears no responsibility for improper mounting or mounting that results in accident or injury.

## Using an optional bracket to mount the TV

- You can ask a qualified service professional about using an optional AN-37AG5 bracket to mount the TV to the wall.
- Carefully read the instructions that come with the bracket before beginning work.

### Hanging on the wall

AN-37AG5 wall mount bracket.  
(See the bracket instructions for details.)

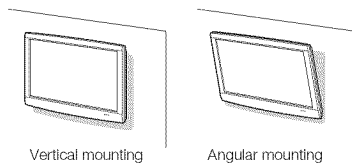

### About setting the TV angle

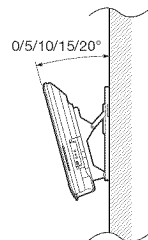

- The center of the display:  $\frac{5}{16}$  inch (7.5 mm) above the "A" position.
- Refer to the operation manual of AN-37AG5 for details.

### NOTE

- Detach the cable clamp on the rear of the TV when using the optional mount bracket.
- Due to the terminal configuration on this TV, when you wall-mount this model, make sure there is enough space between the wall and the TV for the cables.
- To use this TV mounted on a wall, first remove the adhesive tape at the 4 locations on the rear of the TV, and then use the screws supplied with the wall mount bracket to secure the bracket to the rear of the TV.

## QUICK REFERENCE

### QUICK INSTALLATION TIPS

- 1 Attach your antenna to the back of the television.  
(See page 9.)
- 2 Connect the AC plug for the television into the AC outlet.

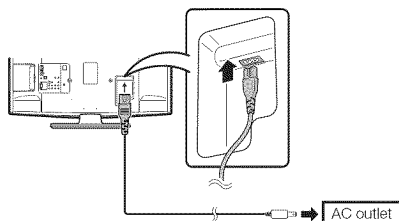

- Place the TV close to the AC outlet, and keep the power plug within reach.

#### NOTE

- **TO PREVENT RISK OF ELECTRIC SHOCK, DO NOT TOUCH UN-INSULATED PARTS OF ANY CABLES WITH THE AC CORD CONNECTED.**

- 3 How to turn on the television for the first time.  
A) Press **POWER** on the television.

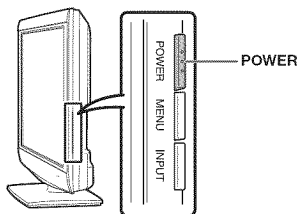

- B) The **POWER** indicator on the front of the television lights **GREEN**.

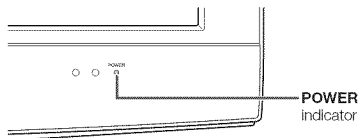

#### NOTE

- Speakers cannot be detached from the TV.
- TV angle cannot be adjusted.

### Using the Remote Control Unit

Use the remote control unit by pointing it towards the remote control sensor on the TV. Objects between the remote control unit and the remote control sensor may prevent proper operation.

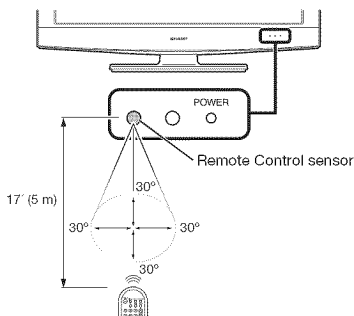

#### ■ Cautions regarding the remote control unit

- Do not expose the remote control unit to shock. In addition, do not expose the remote control unit to liquids, and do not place in an area with high humidity.
- Do not install or place the remote control unit under direct sunlight. The heat may cause deformation of the remote control unit.
- The remote control unit may not work properly if the remote control sensor on the TV is under direct sunlight or strong lighting. In such cases, change the angle of the lighting or the TV, or operate the remote control unit closer to the remote control sensor.

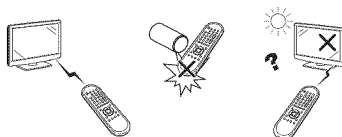

#### IMPORTANT:

The **POWER** indicator on the television should light **GREEN** indicating you have power to the television.

If the **POWER** indicator on the television still does not light up, press **POWER** on the remote control to turn the power on.

#### IMPORTANT:

IF THE UNIT DOES NOT POWER ON - UNPLUG THE TELEVISION FROM THE OUTLET AND REPEAT THE INSTALLATION STEPS.

IF YOU STILL ENCOUNTER NO POWER, PLEASE CONTACT US AT 1-800-BE-SHARP.



# Preparation

## Antennas

To enjoy a clearer picture, use an outdoor antenna. The following is a brief explanation of the types of connections that are used for a coaxial cable. If your outdoor antenna uses a 75-ohm coaxial cable with an F-type connector, plug it into the antenna terminal at the rear of the TV set.

1. A 75-ohm system is generally a round cable with F-type connector that can easily be attached to a terminal without tools (Commercially available).
2. A 300-ohm system is a flat "twin-lead" cable that can be attached to a 75-ohm terminal through a 300/75-ohm adapter (Commercially available).

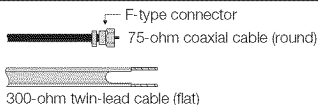

### NOTICE F-type connector should be finger-tightened only.

When connecting the RF cable to the TV set, do not tighten F-type connector with tools. If tools are used, it may cause damage to your TV set. (The breaking of internal circuit, etc.)

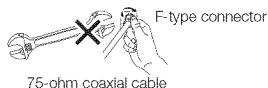

## Connecting Antenna Cable

• Connect the antenna cable to the TV using one of the methods in the illustration as shown (①, ②, ③ or ④).

### ① Cable without a CATV converter

### ② VHF/UHF antenna

### ③ Combination VHF/UHF antenna

### ④ Separate VHF/UHF antenna

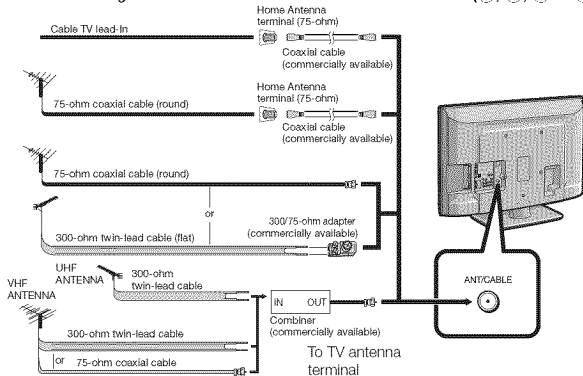

## Installing Batteries in the Remote Control Unit

If the remote control fails to operate TV functions, replace the batteries in the remote control unit.

- 1 Open the battery cover.
- 2 Insert two "AA" size batteries (supplied with the product).
- 3 Close the battery cover.

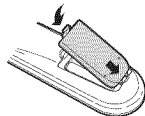
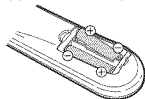
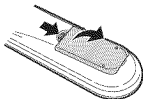

- Place the batteries with their terminals corresponding to the (+) and (-) indications in the battery compartment.

### CAUTION

Improper use of batteries can result in chemical leakage or explosion. Be sure to follow the instructions below.

- Do not mix batteries of different types. Different types of batteries have different characteristics.
- Do not mix old and new batteries. Mixing old and new batteries can shorten the life of new batteries or cause chemical leakage in old batteries.
- Remove batteries as soon as they are worn out. Chemicals that leak from batteries that come in contact with skin can cause a rash. If you find any chemical leakage, wipe thoroughly with a cloth.
- The batteries supplied with this product may have a shorter life expectancy due to storage conditions.
- If you will not be using the remote control unit for an extended period of time, remove batteries from it.

# Part Names

## TV (Front)

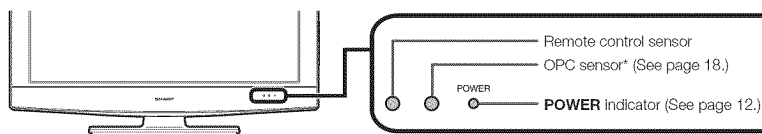

\*OPC: Optical Picture Control

## TV (Rear/Side)

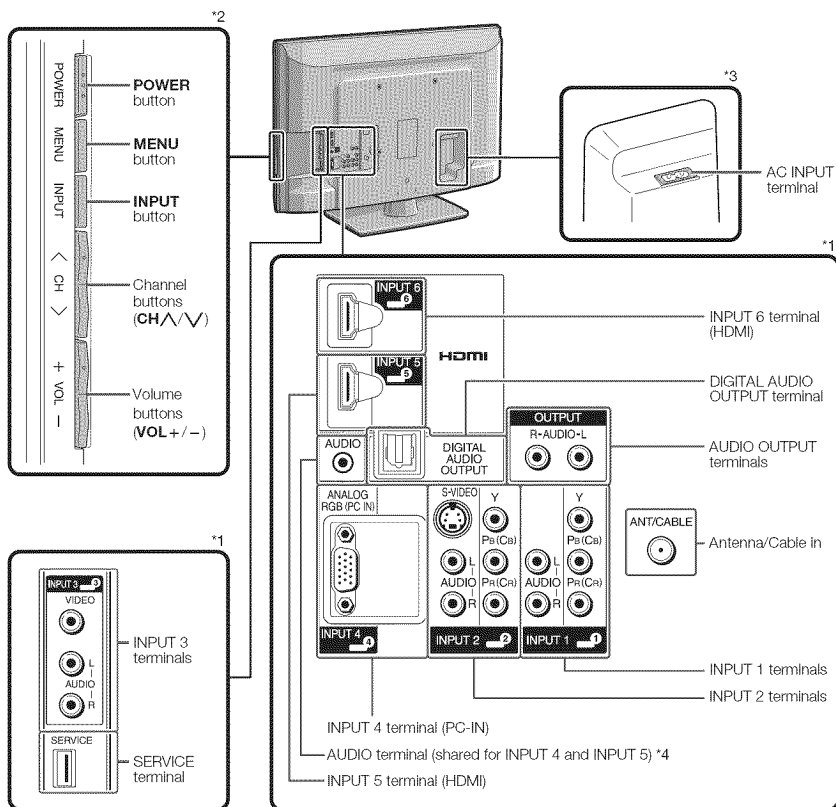

\*1 See page 11 for external equipment connection.

\*2 See page 17 for button operations.

\*3 See page 8 for connecting the AC cord.

\*4 See page 21 for details on the PC Audio Select function.

### NOTE

• The illustrations in this operation manual are for explanation purposes and may vary slightly from the actual operations.

# Connecting to External Equipment

You can connect many types of external equipment to your TV like a Blu-ray disc player, DVD player, VCR, Digital TV tuner, HDMI equipment, game console or camcorder. To view external source images, select the input source from **INPUT** on the remote control unit or on the TV. (See page 15.)

## CAUTION

- To protect equipment, always turn off the TV before connecting any external equipment.
- Please read the relevant operation manual (Blu-ray disc player, etc.) carefully before making connections.

## Connecting a Blu-ray disc player, DVD player, Digital TV STB (Air or Cable), VCR, game console or camcorder

| Terminal on the TV              | Cable  | Terminal on external equipment |
|---------------------------------|--|--------------------------------|
| <b>INPUT 3</b><br>              | <br>AV cable (commercially available)  |                                |
| <b>INPUT 1 or 2</b><br>         | <br>Component video cable (commercially available)<br><br>Audio cable (commercially available) |                                |
| <b>INPUT 2</b><br>              | <br>S-VIDEO cable (commercially available)<br><br>Audio cable (commercially available)         |                                |
| <b>INPUT 5 or 6</b><br>         | <br>HDMI-certified cable (commercially available)  |                                |
| <b>DIGITAL AUDIO OUTPUT</b><br> | <br>Optical fiber cable (commercially available)   |                                |
| <b>AUDIO OUTPUT</b><br>         | <br>Audio cable (commercially available)   |                                |

## NOTE

- \*1 • The Component terminals take priority over the S-VIDEO (INPUT 2) terminal.
- \*2 • When using an HDMI-DVI conversion cable, input the audio signal to AUDIO terminal of INPUT 5. When you input the audio signal via the AUDIO terminal with INPUT 5, set "PC Audio Select" to "Input 5 (HDMI)". (See page 21.)
- \*3 • Digital audio can only be output when receiving a digital broadcast.

## Connecting a PC

| Terminal on the TV      | Cable   | Terminal on PC |
|-------------------------|---|----------------|
| <b>INPUT 4</b><br>      | <br>RGB cable (commercially available)<br><br>Ø 3.5 mm stereo minijack cable (commercially available) |                |
| <b>INPUT 5 or 6</b><br> | <br>HDMI-certified cable (commercially available)   |                |

## NOTE

- When connecting a PC to the INPUT 4, set "PC Audio Select" to "Input 4 (PC)". (See page 21.)
- When connecting a PC to the INPUT 5, set "PC Audio Select" to "Input 5 (HDMI)". (See page 21.)
- The HDMI terminals only support digital signal.
- Refer to page 30 for a list of PC signals compatible with the TV.

# Watching TV

## Turning On/Off the Power

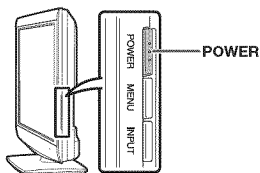

Press **POWER** on the TV or on the remote control unit to turn the power on.

- The POWER Indicator (Green): The TV is on. (After a few seconds, a window appears with sound.)

### NOTE

- The initial setup starts when the TV powers on for the first time. If the TV has been turned on before, the initial setup will not be invoked. For changing the settings of the initial setup, perform EZ setup on the Setup menu on page 20.

Press **POWER** on the TV or on the remote control unit again to turn the power off.

- The TV enters standby and the image on the screen disappears.
- The POWER Indicator on the TV turns off.

### NOTE

- If you are not going to use this TV for a long period of time, be sure to remove the AC cord from the AC outlet.
- Weak electric power is still consumed even when the TV is turned off.

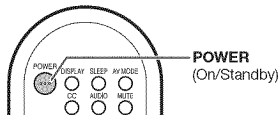

## Initial Setup

When you turn on the TV for the first time, it will automatically memorize the broadcasting channels available in the region where you live. Perform the following steps before you press **POWER** on the remote control unit.

1. Insert the batteries into the remote control unit. (See page 9.)
2. Connect the antenna cable to the TV. (See page 9.)
3. Plug in the AC cord to the AC outlet. (See page 8.)

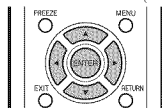

### Language (Language setting)

Select from among 3 languages: English, French and Spanish.

- 1 Press **▲/▼** to select the desired language listed on the screen, and then press **ENTER**.



### TV Location

Select "Home" or "Store" for the location where you plan to install the TV. This product qualifies for ENERGY STAR V3.0 in Home mode default setting.

- 2 Press **▲/▼** to select "Home" or "Store", and then press **ENTER**.

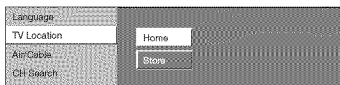

**Home:** "Power Saving" is set to "Off", and AV MODE is set to "STANDARD".

**Store:** "Power Saving" is set to "Off" and AV MODE is set to "DYNAMIC (Fixed)". Picture Reset and Feature Demo can be set.

**Picture Reset:** AV MODE will be set to "DYNAMIC (Fixed)" regardless of whether Picture Reset is "On" or "Off". If you select "On", AV MODE will be reset to "DYNAMIC (Fixed)" if there is no operation for 30 minutes. When "Off" is selected, AV MODE will be set to "DYNAMIC (Fixed)".

**Feature Demo:** When "On" is selected, after all the settings are completed, the Feature Demo screen is displayed if there is no operation for several minutes.

### NOTE

- ENERGY STAR qualification is based on AV MODE "STANDARD".

### Air/Cable (Antenna setting)

Make sure what kind of connection is made with your TV when selecting "Air" or "Cable".

- 3 Press **▲/▼** to select "Air" or "Cable", and then press **ENTER**.

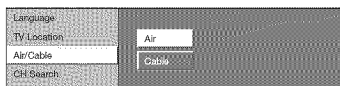

### CH Search (Channel search)

Channel auto search makes the TV look for all channels viewable in the set area.

- 4 ① After "Air/Cable" has been set, "CH Search" is highlighted. Press **ENTER**.



- ② Press **▲/▼** to select "Analog & Digital" to search both analog and digital broadcasts or "Digital" to search only digital broadcasts or "Analog" to search only analog broadcasts, and then press **ENTER**.

- ③ Press **▲/▼** to select "Yes", and then press **ENTER**.



- The Channel search will start automatically.

### NOTE

- If no channel is found, confirm the type of connection made with your TV and try EZ Setup again. (See page 20.)
- For changing the settings of the initial setup, perform EZ setup on the Setup menu on page 20.

# Direct Button Operation

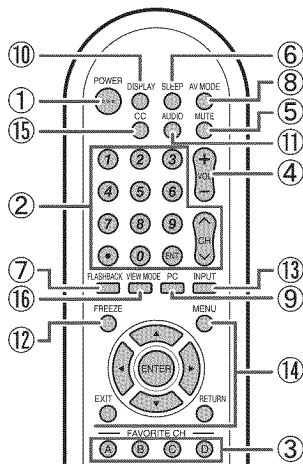

## 1 POWER

You can turn on the TV or put it on standby by pressing **POWER** on the TV or on the remote control unit. (See page 12.)

## 2 Changing Channels

You can change channels by pressing **CH**  $\wedge$ / $\vee$  or **0-9**,  $\bullet$  (DOT).

### Examples:

To select a 1 or 2-digit channel number (e. g., Channel 5):  
Press **5**  $\rightarrow$  **ENT**.

To select a 3-digit channel number (e. g., Channel 115):  
Press **1**  $\rightarrow$  **1**  $\rightarrow$  **5**  $\rightarrow$  **ENT**.

To select a 4-digit channel number (e. g., Channel 22.1):  
Press **2**  $\rightarrow$  **2**  $\rightarrow$   $\bullet$  (DOT)  $\rightarrow$  **1**  $\rightarrow$  **ENT**.

### NOTE

- When selecting a 1-digit channel number, it is not necessary to press **0** before the number.
- When you enter **0-9** only, channel selection will be made if there is no operation within a few seconds.
- If you push "0" by itself, nothing will happen.
- Complete the above steps within a few seconds.
- When you enter **0-9** and  $\bullet$  (DOT), channel selection will be made if there is no operation within a few seconds.

## 3 FAVORITE CH

You can select 4 preset favorite channels in 4 different categories.

Press **A**, **B**, **C** or **D**.

- While watching the TV, you can toggle the selected channels by pressing **A**, **B**, **C** and **D**.

### NOTE

- See page 26 for details of favorite channel settings.

## 4 Changing Volume

You can change the volume by pressing **VOL +/-** on the TV or on the remote control unit.

- To increase the volume, press **VOL +**.
- To decrease the volume, press **VOL -**.



### Audio status

| Output device | Output Select  |          |
|---------------|----------------|----------|
|               | Fixed          | Variable |
| Speaker       | Variable sound | Mute     |

- When "Output Select" is set to "Variable", the indicator on the screen changes as shown below.



### NOTE

- See page 25 for details on the Output Select function.

## 5 MUTE

Mutes the current sound output.

Press **MUTE**.

- " $\text{C}\text{X}$ " will be displayed on the screen for 30 minutes, and the sound is silenced.

### NOTE

- Within 30 minutes of pressing **MUTE**, mute can be canceled by pressing **VOL +/-** or **MUTE**.
- Mute will be canceled after 30 minutes have passed. However, the TV will not suddenly output a loud sound as the volume level is set to 0 automatically.

## 6 Sleep Timer

Allows you to set a time when the TV automatically switches to standby.

Press **SLEEP**.

- The remaining time displays when the sleep timer has been set.
- Each time you press **SLEEP**, the remaining time switches as shown below.

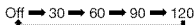

- When set, the time automatically starts counting down.
- If you want to adjust the sleep timer, you can press **SLEEP** twice then change the time setting.
- When it is 5 minutes before the time expires, the remaining time will start to keep appearing every minute.

### NOTE

- Select "Off" by pressing **SLEEP** to cancel the sleep timer.
- The TV will enter standby when the remaining time reaches 0.

## 7 FLASHBACK

Press **FLASHBACK** to switch to the previously tuned channel.

- Press **FLASHBACK** again to switch back to the currently tuned channel.

### NOTE

- FLASHBACK** will not work if no channel has been changed after the TV is turned on.

## Direct Button Operation

### ⑧ AV MODE

AV MODE gives you several viewing options to choose from to best match the surrounding environment of the TV, which can vary due to factors like room brightness, type of program watched or the type of image input from external equipment.

Press **AV MODE**. Current AV MODE displays.

- Press **AV MODE** again before the mode displayed on the screen disappears. The mode changes as shown below:

#### Example:

When the input source is TV, INPUT 1, 2 or 3 terminals

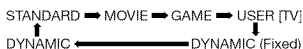

#### Example:

When the input source is INPUT 4, 5 or 6 terminals

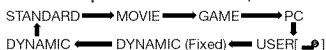

**STANDARD:** For a highly defined image in a normal lighting.

**MOVIE:** For a movie.

**GAME:** Lowers image brightness for easier viewing.

**PC:** For PC.

**USER:** Allows the user to customize settings as desired. You can set the mode for each input source.

**DYNAMIC (Fixed):** Changes the image and sound settings to the factory preset values. No adjustments are allowed.

**DYNAMIC:** For a clear-cut image emphasizing high contrast, useful for sports viewing.

### NOTE

- You can select a different AV MODE item for each input mode. (For example, select STANDARD for TV input and DYNAMIC for INPUT 1.)
- When you play games, "GAME" is recommended for AV MODE.

### ⑨ PC

Allows you to gain quick access to PC mode. Press **PC**.

### ⑩ DISPLAY

Displays channel information being viewed. Press **DISPLAY**.

### ⑪ AUDIO

#### ■ MTS/SAP stereo mode

The TV has a feature that allows reception of sound other than the main audio for the program. This feature is called Multi-channel Television Sound (MTS). The TV with MTS can receive mono sound, stereo sound and Secondary Audio Programs (SAP). The SAP feature allows a TV station to broadcast other information, which could be audio in another language or something completely different like weather information.

You can enjoy Hi-Fi stereo sound or SAP broadcasts where available.

- **Stereo broadcasts:** View programs like live sporting events, shows and concerts in dynamic stereo sound.
- **SAP broadcasts:** Receive TV broadcasts in either MAIN or SAP sound. MAIN sound: The normal program soundtrack (either in mono or stereo). SAP sound: Listen to a second language, supplementary commentary or other information. (SAP is mono sound.)

If stereo sound is difficult to hear.

- Obtain a clearer sound by manually switching to fixed mono-sound mode.

You can change MTS as shown below to match the television broadcast signal.

Press **AUDIO** to toggle between audio modes.

**Examples: when receiving MTS and SAP**

STEREO mode: STEREO ↔ MONO  
STEREO + SAP mode: ST(SAP) ↔ SAP(ST) ↔ MONO

MAIN + SAP mode: MAIN ↔ SAP

MONO mode: MONO

#### ■ Digital broadcasting audio mode

The types of audio transmitted in a digital broadcast include SURROUND as well as MONO and STEREO. In addition, it is possible for multiple audio tracks to accompany a single video track.

Press **AUDIO** to toggle between audio modes.

**Example: when receiving Digital broadcasting**

Audio1: STEREO ↔ Audio2: STEREO  
↕ Audio3: SURROUND ↕

### NOTE

- MTS only operates while in TV mode.

### ⑫ FREEZE

Allows you to capture and freeze a moving image that you are watching.

Press **FREEZE**.

- A moving image is captured.
- Press **FREEZE** again to cancel the function.

### NOTE

- When this function is not available, "No displaying still image available." will display.
- The still image automatically goes out after 30 minutes.
- If you are using the freeze function and a broadcast activates the V-CHIP BLOCK, the freeze function will be canceled and a V-CHIP BLOCK message will appear.

## Direct Button Operation

### 13 INPUT

To view external source images, select the input source using **INPUT** on the remote control unit or on the TV.

#### 1 Press **INPUT**.

- A list of selectable sources appears.

#### 2 Press **INPUT** again or press $\blacktriangle/\blacktriangledown$ to select the input source.

- An image from the selected source automatically displays.
- Each time **INPUT** is pressed, the input source toggles.
- If the corresponding input is not plugged in, you cannot change the input. Be sure to connect the equipment beforehand.

### NOTE

- See page 11 for external equipment connection.
- Press **PC** to switch to an image from the PC.

### 14 Operating On-Screen Display Menu

You can operate the on-screen display menu by using the following buttons.

**MENU**: Displays the menu screen.

$\blacktriangle/\blacktriangledown/\blackleft/\blackright$ : **ENTER**: Select a desired item on the screen.

**RETURN**: Returns to the previous menu screen.

**EXIT**: Turns off the menu screen.

### NOTE

- For operating the on-screen display menu, see "Menu Operation Buttons" on page 17.

### 15 Closed Captions and Digital Closed Captions

Your TV is equipped with an internal Closed Caption decoder. It allows you to view conversations, narration and sound effects as subtitles on your TV. Closed Captions are available on some TV programs and on some VHS home video tapes at the discretion of the program provider.

Digital Closed Caption service is a new caption service available only on digital TV programs (also at the discretion of the service provider). It is a more flexible system than the original Closed Caption system, because it allows for a variety of caption sizes and font styles. When the Digital Closed Caption service is in use, it will be indicated by the appearance of DTVCC.

Not all programs and VHS videotapes offer closed captions. Please look for the **[CC]** symbol to ensure that captions will be shown.

In the Closed Caption system, there can be more than one caption service provided. Each is identified by its own number. The "CC1" and "CC2" services display subtitles of TV programs superimposed over the program's picture.

In the Closed Caption system, the "T1 (TEXT1)" or "T2 (TEXT2)" services display text that is unrelated to the program being viewed (e.g., weather or news). These services are also superimposed over the program currently being viewed.

#### 1 Press **CC**.

- This will present the Closed Caption information display.

#### 2 Press **CC** while the Closed Caption information is still on the screen.

- Press repeatedly until you select the desired closed caption service.



Closed Caption Information

- Regardless of whether or not an analog broadcast provides Closed Caption service, the closed caption display will toggle in the sequence: CC1, CC2, T1, and T2.
- When a digital broadcast provides Closed Caption service, the closed caption display will toggle in the sequence: DTVCC (actual service), CC1, CC2, T1, and T2. CC1, CC2, T1, and T2 are always displayed.

#### Example:

If a program has three services (DTVCC, CC1 and T1 (TEXT1)), the closed caption display will toggle in this sequence:

**1/5 DTVCC**  $\rightarrow$  **2/5 CC1**  $\rightarrow$  **3/5 CC2**  $\rightarrow$  **4/5 T1**  $\rightarrow$  **5/5 T2**  $\rightarrow$  **OFF**

- The **CC** button keeps a record of the last service selected in its memory. If the last closed caption mode (e.g. 1/5 DTVCC) you selected is not available for the next program, or on another channel, the closed caption service that is available is automatically selected. Closed Caption services that appear in parentheses will not be stored in the **CC** button's memory as your last selected service. Only services that you have selected with the **CC** button are stored.

#### Examples:

In a case where there are two closed caption services provided (for instance, DTVCC and CC1), and DTVCC is displayed as your current selection, if DTVCC is not broadcast for the next program, the other closed caption service, CC1, will be displayed.

### NOTE

- When "Power Saving" is set to "Standard" or "Advanced", the Power Saving leaf icon appears on the channel information window. See page 19 for details of Power Saving settings.
- See page 25 for detailed closed caption settings.
- When the program contains no closed caption, "-" displays in the closed caption information. (Only when receiving a digital broadcast.)
- Four kinds of closed caption service (CC1, CC2, T1 (TEXT1), T2 (TEXT2)) are potentially available, but a broadcast may contain none or only some of these services at the discretion of the program provider.

## Direct Button Operation

### 16 VIEW MODE

You can select the screen size.

#### 1 Press **VIEW MODE**.





- The View Mode menu displays.
- The menu lists the View Mode options selectable for the type of video signal currently being received.

#### 2 Press **VIEW MODE** or $\blacktriangle/\blacktriangledown$ while the View Mode menu is displayed to select a desired item on the menu.

- You can sequentially select a View Mode that has its own aspect ratio.

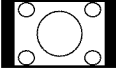
#### ■ For 4:3 programs

##### Example: Screen size images

| Side Bar  | S.Stretch (Smart stretch)   | Zoom  | Stretch  |
|---|---|---|--|
|  |  |  |   |
| Suitable for viewing conventional 4:3 programs in their normal format.            | Suitable for stretching 4:3 programs to fill the screen.                          | Suitable for viewing wide-screen 2.35:1 anamorphic DVDs in full screen.           | This mode is useful for 1.78:1 DVDs. When viewing 1.85:1 DVDs, stretch mode will still show very thin black bands at the top and bottom of the screen. |

#### ■ For HD programs

**Stretch:** Suitable for viewing wide-screen 1.78:1 aspect ratio program, stretch mode will still show very thin black bands at the top and bottom of the screen.

**Full Screen:** Displays an image faithful to the input signal in full screen.

**S.Stretch (Smart stretch):** Suitable for stretching 4:3 programs to fill the screen.

**Zoom:** Suitable for viewing wide-screen 2.35:1 aspect-ratio programs in full screen.

#### NOTE





- When using Full Screen, it is possible to see noise or bars around different outer portions of the screen. Please change view mode to correct this.

#### ■ For PC input mode

#### NOTE

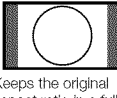
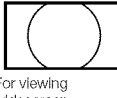
- Connect the PC before making adjustments. (See page 11.)
- Selectable screen size may vary with input signal type.

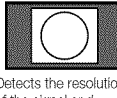
##### Example: Screen size images

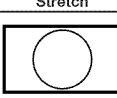
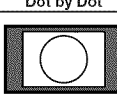
|   |  |  |  |   |
|---|--|--|--|---|
| <b>Input signal</b><br><br>4:3  | <b>Normal</b><br><br>Keeps the original aspect ratio in a full screen display. | <b>Zoom</b><br><br>For viewing widescreen programs. The top and bottom of the image is cropped.                                    | <b>Stretch</b><br><br>An image fully fills the screen. | <b>Dot by Dot</b><br><br>Detects the resolution of the signal and displays an image with the same number of pixels on the screen. |
| <b>Input signal</b><br><br>16:9 | <b>Stretch</b><br><br>An image fully fills the screen.                        | <b>Dot by Dot</b><br><br>Detects the resolution of the signal and displays an image with the same number of pixels on the screen. |  |   |



# On-Screen Display Menu

## On-Screen Display Menu Operation

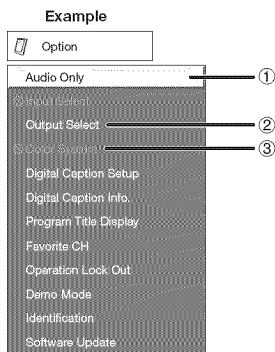
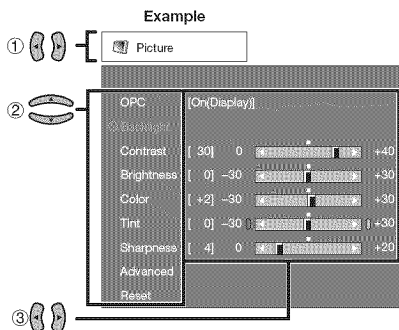

The bar above is an operational guide for the remote control. The bar will change in accordance with each menu setting screen.

- 1 Press **MENU** to display the MENU screen.
- 2 ① Press **◀/▶** to select the desired menu.  
② Press **▲/▼** to select a specific adjustment item, and then press **ENTER**.
- ③ Press **▲/▼** (or **◀/▶**) to select or adjust the desired setting, and then press **ENTER**.
- 3 Press **MENU** to exit.

- ① Item displayed in yellow
  - This indicates the Item currently selected.
  - Press **ENTER** to go to the adjustment screen for this item.
- ② Item displayed in white
  - This indicates that the item can be selected.
- ③ Item displayed in gray
  - This indicates that the item cannot be selected. There are various reasons why the items cannot be selected, but the main reasons are as follows:
    - Nothing is connected to the selected Input terminal.
    - The function is not compatible with the current input signal.

### NOTE

- Menu options differ in the selected input modes, but the operating procedures are the same.
- The screens in the operation manual are for explanation purposes (some are enlarged, others cropped) and may vary slightly from the actual screens.

## Menu Operation Buttons

### Using the remote control

Use the following buttons on the remote control to operate the menu.

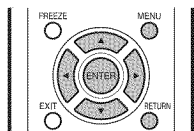

- MENU:** Press to open or close the menu screen.
- ▲/▼/◀/▶:** Press to select a desired item on the screen or adjust a selected item.
- ENTER:** Press to go to the next step or complete the setting.
- RETURN:** Press to return to the previous step.

### Using the control panel of the main unit

You can also operate the menu with the control panel of the main unit.

Button operations on the control panel correspond to the ones on the remote control as shown below.

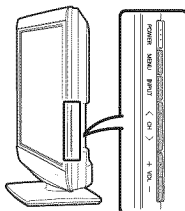

- MENU:** MENU on the remote control.
- INPUT:** ENTER on the remote control.
- CH▲/▼:** Cursor ▲/▼ on the remote control.
- VOL+/-:** Cursor ◀/▶ on the remote control.

## On-Screen Display Menu

### Picture Menu

Adjusts the picture to your preference with the following picture settings.

#### Example



| Selected item     | ◀ button                  | ▶ button                   |
|-------------------|---------------------------|----------------------------|
| <b>Backlight</b>  | The screen dims           | The screen brightens       |
| <b>Contrast</b>   | For less contrast         | For more contrast          |
| <b>Brightness</b> | For less brightness       | For more brightness        |
| <b>Color</b>      | For less color intensity  | For more color intensity   |
| <b>Tint</b>       | Skin tones become reddish | Skin tones become greenish |
| <b>Sharpness</b>  | For less sharpness        | For more sharpness         |

- For resetting all Picture adjustment items to the factory preset values, press ▲/▼ to select "Reset", press **ENTER**, press ▲/▼ to select "Yes", and then press **ENTER**.

### OPC Setting

Automatically adjusts the brightness of the screen.

**On(Display):** Displays the OPC effect on the screen while adjusting the brightness of the screen.

**On:** Automatically adjusts.

**Off:** The brightness is fixed at the value set in "Backlight".

#### NOTE

- When set to "On", the Optical Picture Control (OPC) senses the surrounding light and automatically adjusts the backlight brightness. Make sure nothing obstructs the OPC sensor, which could affect its ability to sense surrounding light.
- When set to "On(Display)", OPC effect displays on the screen while the OPC adjusts the screen brightness.

### Advanced Picture Setting

This TV provides various advanced functions for optimizing the picture quality.

#### C.M.S. (Color Management System)

Color tone is managed using the six-color adjustment setting.

**C.M.S.-Hue:** This is a standard to adjust the color either more reddish or more bluish in tone.

**C.M.S.-Saturation:** Increases or decreases the saturation of a selected color.

**C.M.S.-Value:** A higher value makes the image brighter. A lower value makes the image darker.

#### NOTE

- For resetting all adjustment items to the factory preset values, press ▲/▼ to select "Reset", and then press **ENTER**.

#### Color Temp. (Color Temperature)

For a better white balance, use color temperature correction.

**High:** White with bluish tone  
**Mid-High:**  
**Middle:**  
**Mid-Low:**  
**Low:** White with reddish tone

↑↓

#### Active Contrast

Automatically adjusts the image contrast according to the scene.

**On:** Automatically adjusts the image contrast.

**Off:** No adjustment.

#### Film Mode (3:2 pull-down)

Automatically detects a film-based source (originally encoded at 24 frames/second), analyzes it then recreates each still film frame for high-definition picture quality.

**On:** Detects, analyzes, converts film source.

**Off:** Normal viewing mode.

#### NOTE

- "Film Mode" is not selectable when channel display shows an input resolution of 480p or 720p.

#### Digital Noise Reduction

Produces a clearer video image.

**Off:** No adjustment

**High/Middle/Low:** Select a desired level for viewing a clearer video image.

#### 3D-Y/C

Provides high quality images with minimal dot crawl and cross color noise.

**Slow:** For still images.

**Standard:** Normal adjustment.

**Fast:** For moving images.

**Off:** For Game Mode.

#### NOTE

- 3D-Y/C is available for input signal from Composite Video and analog broadcasts (air and cable).

## On-Screen Display Menu

### Monochrome

For viewing a video in monochrome.

**On:** For viewing in monochrome.

**Off:** Normal color.

### Range of OPC

The brightness level range of the OPC sensor's automatic adjustments can be set according to your preferences.

The adjustment range of the OPC sensor can be set to a maximum of +16 and a minimum of -16.

**Max.:** -15 through +16

**Min.:** -16 through +15

#### NOTE

- The maximum setting cannot be set to a smaller number than the minimum setting.
- The minimum setting cannot be set to a bigger number than the maximum setting.
- Depending on the brightness of the surrounding light, the OPC sensor might not operate if the adjustment range is small.

## Audio Menu

You can adjust the sound quality to your preference with the following settings.

#### Example

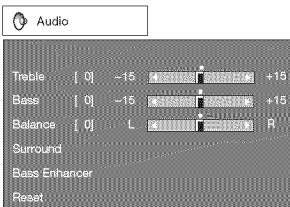

| Selected item  | ◀ button                              | ▶ button                             |
|----------------|---------------------------------------|--------------------------------------|
| <b>Treble</b>  | For weaker treble                     | For stronger treble                  |
| <b>Bass</b>    | For weaker bass                       | For stronger bass                    |
| <b>Balance</b> | Decrease audio from the right speaker | Decrease audio from the left speaker |

#### NOTE

- Audio menu is grayed out when Output Select is set to "Variable". (See page 25.)
- For resetting all Audio adjustment items to the factory preset values, press ▲/▼ to select "Reset", press **ENTER**, press ▲/▼ to select "Yes", and then press **ENTER**.

### Surround

Surround function allows you to enjoy realistic "live" sound.

**On:** Surround function is on.

**Off:** Normal sound.

#### NOTE

- Audio menu is grayed out when Output Select is set to "Variable". (See page 25.)
- For some discs, setup may be required on your DVD player. In this case, please refer to the operation manual of your DVD player.

### Bass Enhancer

This function allows you to enjoy bass-enhanced sound.

**On:** Bass Enhancer function is on.

**Off:** Normal sound.

#### NOTE

- Audio menu is grayed out when Output Select is set to "Variable". (See page 25.)

## Power Control Menu

Power control setting allows you to save energy.

#### Example



### Power Saving

This function allows you to automatically reduce the backlight brightness in order to decrease the power consumption and increase the backlight lifespan.

**Standard:** Reduces the backlight brightness to 80%.

When set to "Standard", appears on the screen.

**Advanced:** Reduces the backlight brightness to 70%.

When set to "Advanced", appears on the screen.

**Off:** The backlight brightness is the same value of your settings in the selected AV MODE.

#### NOTE

- "Power Saving" does not function when you set "AV MODE" to "DYNAMIC (Fixed)".
- When "OPC" is set to "On(Display)" or "On" while "Power Saving" is set to "Standard" or "Advanced", the Power Saving leaf icon appears to the left of "OPC" in the Picture menu screen.
- When "OPC" is set to "Off" while "Power Saving" is set to "Standard" or "Advanced", the Power Saving leaf icon appears to the left of "Backlight" in the Picture menu screen.

### No Signal Off

When set to "Enable", the power will automatically shut down if there is no signal for 15 minutes.

#### NOTE

- When it is 5 minutes before the power shuts down, the remaining time will start to keep appearing every minute.
- "Disable" is the factory preset value.
- When a TV program finishes, this function may not operate.

### No Operation Off

You can set the time length the TV takes to automatically shut the power down when there is no operation.

**30min/3Hour/Disable**

#### NOTE

- When it is 5 minutes before the power shuts down, the remaining time will start to keep appearing every minute.
- "Disable" is the factory preset value.

## Setup Menu

Example

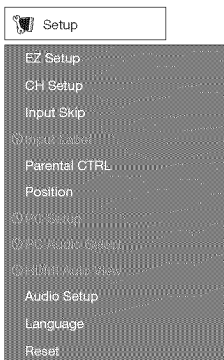

### EZ Setup

You can run EZ Setup again, even after setting up the preset channels.

**Language:** Select from among 3 languages (English, French and Spanish).

**TV Location:** Select "Home" or "Store" for the location where you plan to install the TV. This product qualifies for ENERGY STAR V3.0 in Home mode default setting.

**Home:** "Power Saving" is set to "Off", and AV MODE is set to "STANDARD".

**Store:** "Power Saving" is set to "Off" and AV MODE is set to "DYNAMIC (Fixed)". Picture Reset and Feature Demo can be set.

**Picture Reset:** AV MODE will be set to "DYNAMIC (Fixed)" regardless of whether Picture Reset is "On" or "Off". If you select "On", AV MODE will be reset to "DYNAMIC (Fixed)" if there is no operation for 30 minutes. When "Off" is selected, AV MODE will be set to "DYNAMIC (Fixed)".

**Feature Demo:** When "On" is selected, after all the settings are completed, the Feature Demo screen is displayed if there is no operation for several minutes.

- ENERGY STAR qualification is based on AV MODE "STANDARD".

**Air/Cable:** Make sure what kind of connection is made with your TV when selecting "Air" or "Cable".

**CH Search:** Channel auto search makes the TV look for all channels viewable in the set area.

#### NOTE

- See "Initial Setup" on page 12 for setting each item.
- If no channel is found, confirm the type of connection made with your TV and try EZ Setup again.

### CH Setup

If initial setup does not memorize all the channels in your region, follow the instructions below to manually memorize the channels.

**Air/Cable:** Make sure what kind of connection is made with your TV when selecting "Air" or "Cable".

**CH Search:** Channel auto search makes the TV look for all channels viewable in the set area.

**CH Memory:** You can select the channels to skip in each ANALOG (Air), ANALOG (Cable), DIGITAL (Air) and DIGITAL (Cable).

**On:** Skips channels. (Channel selection disabled using CH ^/V.)

**Off:** Does not skip channels. (Channel selection enabled using CH ^/V.)

**Antenna Setup Digital:** In order to receive digital air broadcasts, you need a digital broadcast antenna. You can confirm the antenna configuration through the "Antenna Setup Digital" screen. If necessary, adjust the direction of the antenna to obtain the maximum signal strength.

**Signal Strength:** The signal strength of DIGITAL channel is displayed. The signal information is based on the current channel.

**Channel Strength:** Input the 2-digit channel number to check the signal strength of the selected channel. Make sure the signal is strong enough for each channel.

- This function is available for DIGITAL (Air) only.

#### NOTE

- See "Initial Setup" on page 12 for setting each item.
- If no channel is found, confirm the type of connection made with your TV and try channel search again.

### Input Skip

This setting allows you to skip the HDMI or PC-IN input ("Input 4 (PC)", "Input 5 (HDMI)" and "Input 6 (HDMI)") on the Input Selection operation.

**Yes:** Skips the input.

**No:** Does not skip input.

### Input Label

Let's you set the input terminal displayed when using the INPUT SOURCE menu or channel display. Press ▲/▼/◀/▶ to select the new name for the input mode.

#### NOTE

- You cannot change labels if the INPUT SOURCE is TV.

## On-Screen Display Menu

### Position

For adjusting a picture's horizontal and vertical position.

**H-Pos.:** Centers the image by moving it to the left or right.

**V-Pos.:** Centers the image by moving it up or down.

#### NOTE

- For resetting adjustments to the factory preset values, press ▲/▼ to select "Reset", and then press **ENTER**.
- When connecting a PC to the HDMI terminal, the image position will be automatically adjusted. It cannot be manually adjusted.
- Adjustments are stored separately according to input source.
- When a DTV channel is selected, the horizontal position cannot be adjusted.
- The horizontal and/or vertical position may not be able to be adjusted or it may be adjusted only to a certain degree.

### PC Setup

#### Input Signal (for Analog PC Input Mode Only)

Some input signals may have to be registered manually to display properly. The pair of input signals (resolutions) in the list below is not distinguishable when received. In such a case, you have to set the correct signal manually. After setting once, it will display when the same signal (resolution) is input again.

1024 x 768

1360 x 768

#### NOTE

- You can only select the "Input Signal" on the Setup menu when receiving one of the 2 input signals listed above.

#### Auto Sync. (for Analog PC Input Mode Only)

For automatically adjusting the PC image.

**Yes:** Auto Sync. starts.

**No:** This function does not work.

#### NOTE

- When Auto Sync. is successful, "Completed" displays. If not, Auto Sync. failed.
- Auto Sync. may fail even if "Completed" displays.
- Auto Sync. may fail if the computer image has low resolution, has unclear (black) edges, or is moved while executing Auto Sync.
- Be sure to connect the PC to the TV and switch it on before starting Auto Sync.

### Fine Sync.

Ordinarily you can easily adjust the picture as necessary to change image position using Auto Sync. In some cases, however, manual adjustment is needed to optimize the image.

**H-Pos.:** Centers the image by moving it to the left or right.

**V-Pos.:** Centers the image by moving it up or down.

**Clock:** Adjust when the image flickers with vertical stripes.

**Phase:** Adjust when characters have low contrast or when the image flickers.

#### NOTE

- For resetting all Fine Sync. adjustment items to the factory preset values, press ▲/▼ to select "Reset", and then press **ENTER**.
- It is not necessary to adjust the "Clock" or "Phase" when a digital signal is being input, so it cannot be selected.
- The default cursor position may not be in the center, because the screen position variable ranges may be asymmetrical.

### PC Audio Select

Determines whether the AUDIO terminal is used for INPUT 4 (PC-IN) or INPUT 5 (HDMI).

**Input 4 (PC):** Select this item when the audio signal is input via the INPUT 4 (PC-IN) terminal using an analog RGB cable.

**Input 5 (HDMI):** Select this item when the audio signal is input via the INPUT 5 (HDMI) terminal using an HDMI-DVI conversion cable.

#### NOTE

- When "PC Audio Select" is set to "Input 5 (HDMI)", sound will not be produced if you use only an HDMI-certified cable to connect HDMI-compatible equipment. To produce sound, you should make an analog audio connection.
- If you want to connect HDMI-compatible equipment using only an HDMI-certified cable, set "PC Audio Select" to "Input 4 (PC)".

### HDMI Auto View

To watch an HDMI or PC-IN equipment image, select "INPUT5" or "INPUT6" from "INPUT SOURCE" menu using INPUT on the remote control unit or on the TV.

**Enable:** To use View Mode based on signal recognition, including an HDMI signal.

**Disable:** No function.

#### NOTE

- Refer to your external equipment operation manual for the signal type.
- When connecting an HDMI-DVI conversion adapter/cable to the HDMI terminal, the image may not come in clearly.

## On-Screen Display Menu

### Audio Setup

You can output digital audio to an AV amplifier or similar device whose DIGITAL AUDIO INPUT terminal is connected to the DIGITAL AUDIO OUTPUT terminal on the TV. Please select an audio output format compatible with the audio format of the program you are watching and the equipment connected.

**PCM:** The optical output terminal outputs audio signal in PCM form. If your digital audio system does not support Dolby Digital, select "PCM".

**Dolby Digital:** The optical output terminal outputs audio signal in Dolby Digital form. It reproduces sound from surround program of digital.

### Language

You can also select a language from the Setup menu. Select from among 3 languages: English, French and Spanish.

### Reset

If complex adjustments are made and the settings cannot be restored to normal, you can reset the settings to the factory preset values.

- 1 "Return to factory pre-setting" displays on the screen.
  - If you have already set the Secret No., input the 4-digit secret number here.
- 2 Select "Yes".
  - After the reset has been completed, the power shuts off and then comes back on. The screen will have returned to its original settings.

### NOTE

- The Channel Setup settings will not be changed.
- The Language settings will not be changed.
- The Secret number settings will not be changed.
- The TV Location settings will not be changed.

### Parental CTRL (Parental Control Setting)

#### Secret No.

Allows you to use a secret number to protect certain settings from being accidentally changed.

#### IMPORTANT:

Three conditions must be met to enable the V-Chip (see pages 22 to 24):

1. Secret No. is registered.
2. V-Chip/V-Chip (DTV Only) settings have been made.
  - The "V-Chip (DTV Only)" will only be selectable when a new rating system can be downloaded via digital broadcasting in the U.S.
3. "Status" is set to "On".

#### ■ New Secret No.

You can set and change the secret number by using 0-9.

**Input Secret No.:** When you change the secret number, enter the old 4-digit secret number here. The cursor moves to "New Secret No."

**New Secret No.:** When you set the new secret number, enter the new 4-digit secret number here. The cursor moves to "Reconfirm".

**Reconfirm:** Enter the same 4-digit number you set in "New Secret No."

#### ■ Secret No. Clear

You can clear your secret number.

**Yes:** Your secret number is cleared.

**No:** Your secret number is not cleared.

### NOTE

- As a precautionary measure, make a note of your secret number and keep it in a familiar place.
- If the secret number is cleared, the Status setting automatically sets to "Off". "V-Chip" and "Status" will not be selectable from the menu.

### Status

Used to enable or disable the parental control function.

This function will not be selectable from the menu if you do not first configure your secret number.

**On:** Enables Parental CTRL.

**Off:** Disables Parental CTRL.

### V-Chip

V-CHIP is an electronic filtering device built into your TV. This tool gives parents a great degree of control over broadcasts accessed by their children. It allows parents to select programs judged suitable for child viewing while blocking ones judged not suitable. It does so automatically once you activate the V-CHIP feature in your TV. "V-Chip" and "Status" will not be selectable from the menu if you do not first configure your secret number.

- The U.S. has two rating systems for viewing content: TV Parental Guidelines and movie ratings.
- The TV Parental Guidelines work in conjunction with the V-CHIP to help parents screen out inappropriate television shows from their children.
- Movie ratings are used for original movies rated by the Motion Picture Association of America (MPAA) as watched on cable TV and not edited for television. The V-CHIP can also be set to block MPAA-rated movies.

### NOTE

- The setting automatically enters "Block" for any ratings below your selection.
- If Status is not set to "On", the configuration settings will not work.

## On-Screen Display Menu

### MPAA (Voluntary movie rating system)

#### Example

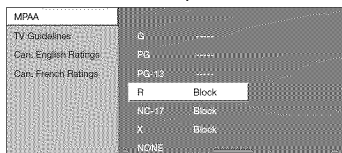

Press **▲**/**▼** to adjust the item to your desired position. "Block" indicates the item is blocked. Press **MENU** to exit.

#### NOTE

- Voluntary movie rating system only uses an age-based rating.

### TV Parental Guidelines

#### Example

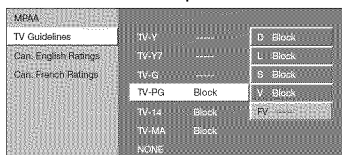

#### Example

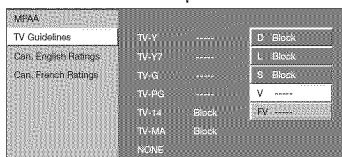

**G:** General audiences. All ages admitted.

**PG:** Parental guidance suggested. Some material may not be suitable for children.

**PG-13:** Parents strongly cautioned. Some material may be inappropriate for children under 13.

**R:** Restricted. Under 17 requires accompanying parent or adult guardian (age varies in some jurisdictions).

**NC-17:** No one 17 and under admitted.

**X:** X is an older rating that is unified with NC-17 but may be encoded in the data of older movies.

Press **▲**/**▼** to adjust the item to your desired position.

"Block" indicates the item is blocked. Press **MENU** to exit.

### When setting an individual content-based rating item:

- 1 Press **▶** or **ENTER** to access blocked content items from the currently selected age-based rating item.
- 2 Press **▲**/**▼** to select an individual item, and then press **ENTER** to unblock it ("Block" is removed). Repeat the same steps for the other items.
- 3 Press **◀** or **RETURN** to register after all individual content rating items are set.

| Rating           |                                     | Content                     |                 |                            |                          |   |
|------------------|-------------------------------------|-----------------------------|-----------------|----------------------------|--------------------------|---|
|                  |                                     | FV<br>(Fantasy<br>violence) | V<br>(Violence) | S<br>(Sexual<br>situation) | L<br>(Adult<br>language) | D<br>(Sexually<br>suggestive<br>dialog) |
| Suggested<br>age | TV-Y (All children)                 | ☒                           | ☒               | ☒                          | ☒                        | ☒                                       |
|                  | TV-Y7 (Directed to older children)  | ✗                           | ☒               | ☒                          | ☒                        | ☒                                       |
|                  | TV-G (General audience)             |                             | ☒               | ☒                          | ☒                        | ☒                                       |
|                  | TV-PG (Parental Guidance suggested) |                             | ✗               | ✗                          | ✗                        | ✗                                       |
|                  | TV-14 (Parents strongly cautioned)  |                             | ✗               | ✗                          | ✗                        | ✗                                       |
|                  | TV-MA (Mature audience only)        |                             | ✗               | ✗                          | ✗                        |   |

☒ : The content rating can be set, but this rating is not normally broadcast by TV stations.

✗ : Content rating can be set.

## On-Screen Display Menu

### Canadian Rating Systems (Canadian English ratings and Canadian French ratings)

- The TV rating systems in Canada are based on the Canadian Radio-Television and Telecommunications Commission (CRTC) policy on violence in television programming.
- While violence is the most important content element to be rated, the structure developed takes into consideration other program content like language, nudity, sexuality and mature themes.
- When setting the V-CHIP on the Canadian system you can choose either the Canadian English ratings or the Canadian French ratings.

### Canadian English Ratings

#### Example

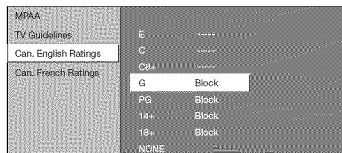

Press **▲/▼** to adjust the item to your desired position. "Block" indicates the item is blocked. Press **MENU** to exit.

- E:** Exempt: Includes news, sports, documentaries and other information programming; talk shows, music videos, and variety programming.
- C:** Children: Intended for younger children under the age of 8 years. Pays careful attention to themes that could threaten their sense of security and well-being.
- C8+:** Children over 8 years old: Contains no portrayal of violence as the preferred, acceptable, or only way to resolve conflict; nor encourage children to imitate dangerous acts which they may see on the screen.
- G:** General: Considered acceptable for all age groups. Appropriate viewing for the entire family, contains very little violence, physical, verbal or emotional.
- PG:** Parental Guidance: Intended for a general audience, but may not be suitable for younger children (under the age of 8) because it could contain controversial themes or issues.
- 14+:** Over 14 years: Could contain themes where violence is one of the dominant elements of the storyline, but it must be integral to the development of plot or character. Language usage could be profane and nudity present within the context of the theme.
- 18+:** Adults: Intended for viewers 18 years and older and might contain depictions of violence, which while related to the development of plot, character or themes, are intended for adult viewing. Could contain graphic language and portrayals of sex and nudity.

### Canadian French Ratings

#### Example

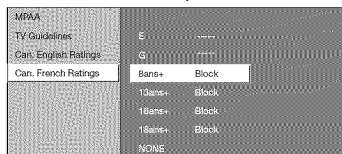

Press **▲/▼** to adjust the item to your desired position. "Block" indicates the item is blocked. Press **MENU** to exit.

- E:** Exempt programming.
- G:** General: All ages and children, contains minimal direct violence, but may be integrated into the plot in a humorous or unrealistic manner.
- 8ans+:** General but inadvisable for young children: May be viewed by a wide public audience, but could contain scenes disturbing to children under 8 who cannot distinguish between imaginary and real situations. Recommended for viewing with parent.
- 13ans+:** Over 13 years: Could contain scenes of frequent violent scenes and therefore recommended for viewing with parent.
- 16ans+:** Over 16 years: Could contain frequent violent scenes and intense violence.
- 18ans+:** Over 18 years: Only for adult viewing. Could contain frequent violent scenes and extreme violence.

### How to temporarily release the V-CHIP BLOCK

When the V-CHIP BLOCK is working and censors a broadcast, "V-CHIP HAS BEEN ACTIVATED." displays.

- 1 Press **ENTER** while the V-CHIP is working, and then the secret number setting menu displays.
- 2 Input the 4-digit secret number by using **0-9**. At this time V-CHIP BLOCK temporarily releases.

### Reactivating the temporarily released V-CHIP BLOCK

You can reactivate the temporarily released V-CHIP BLOCK as shown below.

- Select "Status" setting from the Parental CTRL menu to reactivate BLOCK. (See page 22.)
- Select "V-Chip" setting ("MPAA", "TV Guidelines", "Can. English Ratings" or "Can. French Ratings") from the Parental CTRL to reactivate BLOCK. (See pages 22 to 24.)
- Switch off the TV power.

#### NOTE

- Performing any of the three above will activate the V-CHIP BLOCK.



### Option Menu

Example



#### Audio Only

When listening to music from a music program, you can turn the screen off and enjoy audio only.

**On:** Audio is output without screen image.

**Off:** Both screen images and audio are output.

#### NOTE

- The screen image will return to normal when a button (except those for audio adjustment, such as **VOL**, **MUTE**, **AUDIO**) is pressed.

#### Input Select

If the image does not come in clearly from the external equipment connected to INPUT 2, you may need to change the input signal type setting from the list below:

**Auto/COMPONENT/S-TERMINAL**

#### NOTE

- If the selected signal type is incorrect, images are not displayed at all or are displayed without any color.
- Refer to your external equipment operation manual for the signal type.
- If you set INPUT 2 to Auto, the TV will automatically select the input signal.
- Setting INPUT 2 signal selection to "Auto" when other equipment is connected will result in the following connection priority.

#### INPUT 2:

- ① COMPONENT VIDEO
- ② S-VIDEO

#### Output Select

Allows you to select what controls the audio output.

**Fixed:** Sound via speaker is adjusted with **VOL +/-** on the remote control unit or **VOL +/-** on the TV. Sound via the AUDIO OUTPUT terminal is not adjustable and outputs at a consistent level.

**Variable:** Sound via the AUDIO OUTPUT terminal is adjusted with **VOL +/-** on the remote control unit or **VOL +/-** on the TV. Sound via speaker is muted.

#### Color System

Select the video signal system compatible with your equipment from the list below:

**Auto/NTSC/PAL-M/PAL-N**

#### NOTE

- "Color System" can only be set for the INPUT 2 S-VIDEO and INPUT 3 VIDEO.

#### Digital Caption Setup

This function allows you to adjust the closed caption screen appearance to suit your preference. You can adjust 8 items: "Font Size", "Font Style", "Font Color", "Font Opacity", "Background Color", "Background Opacity", "Font Edge" and "Edge Color".

#### Example:

**Selectable items available for "Font Style".**

**Default:** The font specified by broadcasting station or default font.

**Type 0:** Proportional font used in the MENU screen.

**Type 1:** Monospaced with serifs.

**Type 2:** Proportionally spaced with serifs.

**Type 3:** Monospaced without serifs.

**Type 4:** Proportionally spaced without serifs.

**Type 5:** Casual font type.

**Type 6:** Cursive font type.

**Type 7:** Small capitals.

#### NOTE

- For resetting adjustments to the factory preset values, press **▲/▼** to select "Reset", and then press **ENTER**.
- The default value depends on the broadcasting station.

#### Digital Caption Info.

##### (Digital Caption Information)

This function allows viewing of digital closed caption information for the digital broadcast program being viewed.

#### NOTE

- This list is not displayed for analog broadcasts or external input audio/video.
- This information is not included in CC1, CC2, T1 (TEXT1), or T2 (TEXT2), and is not displayed in a list.

#### Program Title Display

Select the CH display when changing channels for digital broadcasting.

**On:** "Program Info." displays.

**Off:** "Program Info." does not display.

## On-Screen Display Menu

### Favorite CH (Favorite Channel Setting)

This function allows you to program 4 favorite channels, in 4 different categories. By setting the favorite channels in advance, you can select your favorite channels easily.

#### To register your favorite channel:

Select "Register" and then press **ENTER**. Press  $\blacktriangle/\blacktriangledown/\blacktriangleleft/\blacktriangleright$  to select the position in the category, and then press **ENTER** to register.

#### To delete your favorite channel:

Select "1 Data Clear" and then press **ENTER**. Press  $\blacktriangle/\blacktriangledown/\blacktriangleleft/\blacktriangleright$  to select the channel you want to delete, and then press **ENTER**. Select "Yes" and then press **ENTER**. To delete all the favorite channels, select "All Data Clear".

#### NOTE

- Before setting the channel, select the channel you want to register as a favorite channel.

### Operation Lock Out

This function locks the operation buttons on the TV and the remote control.

**Off:** No adjustment.

**RC Control Lock:** All buttons on the remote control are locked.

**Button Control Lock:** All buttons on the TV, except **POWER**, are locked.

#### NOTE

- To unlock the buttons on the remote control, press **MENU** on the TV, and then select "Off" on the MENU screen.
- To unlock the buttons on the TV, press **MENU** on the remote control, and then select "Off" on the MENU screen.

### Demo Mode

Select to play the Demo Mode.

**On:** Play product feature demo.

**Off:** This function does not work.

#### NOTE

- If the power is turned off or the AC cord is unplugged when the TV is in demo mode, the TV will start in demo mode when it is turned back on.

### Identification

The current version of the TV software is displayed.

### Software Update

This function allows software updates by inserting a USB memory device with the update file into the SERVICE terminal on the TV.

To check for the availability of a software update, visit [www.sharppusa.com](http://www.sharppusa.com). If you have any questions, please call 1-800-BE-SHARP (800-237-4277).

#### CAUTION

- Do not remove the USB memory device or unplug the AC cord while the software is being updated.
- Be sure to properly follow the whole procedure described below, step by step. Otherwise, for example, the TV cannot read the data in the USB memory device and software updating will fail.

- 1 Insert the USB memory device with the update file into the SERVICE terminal on the TV.

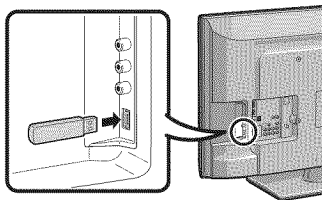

- 2 Press **MENU** to display the MENU screen, and then press  $\blacktriangleleft/\blacktriangleright$  to select "Option".
- 3 Press  $\blacktriangle/\blacktriangledown$  to select "Software Update", and then press **ENTER**.
  - If you have already set the Secret No., go to step 4.

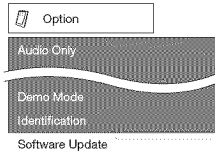

- 4 Input the 4-digit secret number by using 0-9.



- 5 Press **ENTER** to start checking the data in the USB memory device.



## On-Screen Display Menu

- 6 During the data checking, "Checking" blinks.

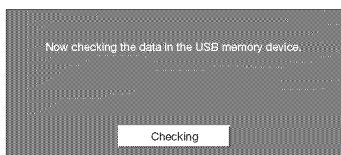

- The current version of the TV software and the version of the update file on the USB memory device are displayed. To update the TV software with the update file, select "Yes", and then press **ENTER**.

### Example

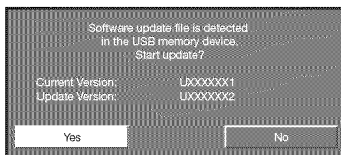

- If the USB memory device is not properly installed or the correct update file cannot be found on the USB memory device, an error message is displayed.
- Check the file on the USB memory device, and then reinsert the USB memory device correctly.



- 7 Press **ENTER** to start updating.
- The screen becomes dark for a while until the update screen can be displayed. Please wait for the update screen to appear. Do not unplug the AC cord.

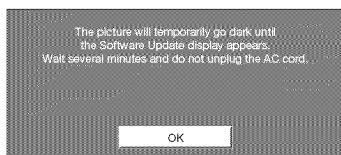

### Example

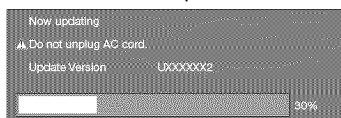

### CAUTION

- **Do not remove the USB memory device or unplug the AC cord while the software is being updated.**

- 8 When the software is successfully updated, a screen is displayed indicating that the update process is completed.

After this screen is displayed, the TV automatically turns off and then turns on again.

### Example

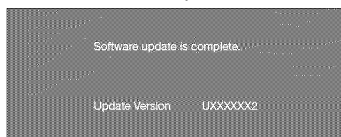

- If the update has failed, check the file in the USB memory device and try Software Update again.



- 9 After the screen shown below is displayed, press **ENTER**.



- 10 Remove the USB memory device.

# Appendix

## Troubleshooting

| Problem   | Possible Solution  |
|---|--|
| <ul style="list-style-type: none"><li>• No power</li></ul>  | <ul style="list-style-type: none"><li>• Check If you pressed <b>POWER</b> on the remote control unit. (See page 12.) If the indicator on the TV does not light up, press <b>POWER</b> on the TV.</li><li>• Is the AC cord disconnected? (See page 8.)</li><li>• Has the power been turned on? (See page 12.)</li></ul>   |
| <ul style="list-style-type: none"><li>• Unit cannot be operated.</li></ul>                          | <ul style="list-style-type: none"><li>• External influences such as lightning, static electricity, may cause improper operation. In this case, operate the unit after first turning off the power of the TV or unplugging the AC cord and replugging it in after 1 or 2 minutes.</li></ul>   |
| <ul style="list-style-type: none"><li>• Remote control unit does not operate.</li></ul>             | <ul style="list-style-type: none"><li>• Are batteries inserted with polarity (+, -) aligned? (See page 9.)</li><li>• Are batteries worn out? (Replace with new batteries.)</li><li>• Are you using it under strong or fluorescent lighting?</li><li>• Is a fluorescent light illuminated near the remote control sensor?</li></ul>   |
| <ul style="list-style-type: none"><li>• Picture is cut off/with sidebar screen.</li></ul>           | <ul style="list-style-type: none"><li>• Is the image position correct? (See page 21.)</li><li>• Are screen mode adjustments such as picture size made correctly? (See page 16.)</li></ul>  |
| <ul style="list-style-type: none"><li>• Strange color, light color, or color misalignment</li></ul> | <ul style="list-style-type: none"><li>• Adjust the picture tone. (See pages 18 and 19.)</li><li>• Is the room too bright? The picture may look dark in a room that is too bright.</li><li>• Check the input signal setting. (See page 21.)</li></ul>   |
| <ul style="list-style-type: none"><li>• Power is suddenly turned off.</li></ul>                     | <ul style="list-style-type: none"><li>• Is the sleep timer set? (See page 13.)</li><li>• Check the power control settings. (See page 19.)</li><li>• The unit's internal temperature has increased. Remove any objects blocking vent or clean.</li></ul>  |
| <ul style="list-style-type: none"><li>• No picture</li></ul>  | <ul style="list-style-type: none"><li>• Is connection to other components correct? (See page 11.)</li><li>• Is correct input signal source selected after connection? (See page 25.)</li><li>• Is the correct input selected? (See page 25.)</li><li>• Is picture adjustment correct? (See pages 18 and 19.)</li><li>• Is "On" selected in "Audio Only"? (See page 25.)</li><li>• Is a non-compatible signal being input? (See page 30.)</li></ul> |
| <ul style="list-style-type: none"><li>• No sound</li></ul>  | <ul style="list-style-type: none"><li>• Is the volume too low? (See page 13.)</li><li>• Is "Variable" selected in "Output Select"? (See page 25.)</li><li>• Have you pressed <b>MUTE</b> on the remote control unit? (See page 13.)</li></ul>  |
| <ul style="list-style-type: none"><li>• The TV sometimes makes a cracking sound.</li></ul>          | <ul style="list-style-type: none"><li>• This is not a malfunction. This happens when the cabinet slightly expands and contracts according to change in temperature. This does not affect the TV's performance.</li></ul>   |

## Troubleshooting-Digital Broadcasting

The error message about reception of broadcast

| The example of an error message displayed on a screen                          | Possible Solution   |
|--|---|
| <ul style="list-style-type: none"><li>• Failed to receive broadcast.</li></ul> | <ul style="list-style-type: none"><li>• Check the antenna cable. Check that the antenna is correctly setup.</li></ul> |
| <ul style="list-style-type: none"><li>• No broadcast now.</li></ul>            | <ul style="list-style-type: none"><li>• Check the broadcast time in the program guide.</li></ul>                      |

## Cautions regarding use in high and low temperature environments

- When the unit is used in a low temperature space (e.g. room, office), the picture may leave trails or appear slightly delayed. This is not a malfunction, and the unit will recover when the temperature returns to normal.
- Do not leave the unit in a hot or cold location. Also, do not leave the unit in a location exposed to direct sunlight or near a heater, as this may cause the cabinet to deform and the Liquid Crystal panel to malfunction. Storage temperature: -4°F to +140°F (-20°C to +60°C)

## Specifications

| Item                                  |                    | Model: LC-32SB27UT   |   |
|---------------------------------------|--------------------|--|---|
| LCD panel                             |                    | 32" Class (31 1/2" Diagonal)<br>Active Matrix (a-Si TFT LCD) |   |
| Resolution                            |                    | 1,049,088 pixels (1,366 × 768)                               |   |
| TV Function                           | TV-standard (CCIR) | American TV Standard ATSC/NTSC System                        |   |
|                                       | Receiving Channel  | VHF/UHF  | VHF 2-13ch, UHF 14-69ch   |
|                                       |                    | CATV   | 1-135ch (non-scrambled channel only)  |
|                                       |                    | Digital Terrestrial Broadcast (DVBSE)                        | 2-69ch  |
|                                       |                    | Digital cable <sup>1</sup> (64/256 QAM)                      | 1-135ch (non-scrambled channel only)  |
| Audio multiplex                       | BTSC System        |  |   |
| Backlight                             |                    | 60,000 hours (at Backlight Standard position)                |   |
| Audio out                             |                    | 10W × 2  |   |
| Terminals                             | Rear               | INPUT 1  | COMPONENT in  |
|                                       |                    | INPUT 2  | COMPONENT in, S-VIDEO in  |
|                                       |                    | INPUT 4  | ANALOG RGB (PC) in (15-pin mini D-sub female connector), Audio in (Ø 3.5 mm jack) |
|                                       |                    | INPUT 5  | HDMI in with HDCP, Audio in (Ø 3.5 mm jack)                                       |
|                                       |                    | INPUT 6  | HDMI in with HDCP   |
|                                       |                    | ANT/CABLE  | 75 Ω Unbalance, F Type × 1 for Analog (VHF/UHF/CATV) and Digital (AIR/CABLE)      |
|                                       |                    | AUDIO  | Audio in (Ø 3.5 mm jack)  |
|                                       |                    | DIGITAL AUDIO OUTPUT   | Optical Digital audio output × 1 (PCM/Dolby Digital)                              |
|                                       | Side               | OUTPUT   | Audio out   |
|                                       |                    | INPUT 3  | AV in   |
|                                       | SERVICE            | Software update  |   |
| OSD language                          |                    | English/French/Spanish                                       |   |
| Power Requirement                     |                    | AC 120 V, 60 Hz  |   |
| Power Consumption                     |                    | 105 W (0.3 W Standby with AC 120V)                           |   |
| Weight                                | TV + stand         | 26.5 lbs./12.0 kg  |   |
|                                       | TV only            | 24.3 lbs./11.0 kg  |   |
| Dimension <sup>2</sup><br>(W × H × D) | TV + stand         | 31 47/64 × 22 61/64 × 9 49/64 inch                           |   |
|                                       | TV only            | 31 47/64 × 21 1/32 × 4 11/64 inch                            |   |
| Operating temperature                 |                    | +32°F to +104°F (0°C to +40°C)                               |   |

<sup>1</sup> Emergency alert messages via Cable are unreceivable.

<sup>2</sup> The dimensional drawings are shown on the Spanish operation manual.

- As part of policy of continuous improvement, SHARP reserves the right to make design and specification changes for product improvement without prior notice. The performance specification figures indicated are nominal values of production units. There may be some deviations from these values in individual units.

## Optional Accessory

The listed optional accessory is available for the Liquid Crystal Television. Please purchase it at your nearest shop.

- Additional optional accessories may be available in the near future. When purchasing, please read the newest catalogue for compatibility and check the availability.

| Part name          | Model number |
|--------------------|--------------|
| Wall mount bracket | AN-37AG5     |

## PC Compatibility Chart

It is necessary to set the PC correctly to display XGA and WXGA signal.

| PC | Resolution | Horizontal Frequency | Vertical Frequency | VESA Standard |   |
|----|------------|----------------------|--------------------|---------------|---|
| PC | VGA        | 720 x 400            | 31.5 kHz           | 70 Hz         | — |
|    |            |                      | 31.5 kHz           | 60 Hz         | O |
|    |            | 640 x 480            | 37.9 kHz           | 72 Hz         | O |
|    |            |                      | 37.5 kHz           | 75 Hz         | O |
|    | SVGA       | 800 x 600            | 35.1 kHz           | 56 Hz         | O |
|    |            |                      | 37.9 kHz           | 60 Hz         | O |
|    |            |                      | 48.1 kHz           | 72 Hz         | O |
|    |            |                      | 46.9 kHz           | 75 Hz         | O |
|    |            |                      | 48.4 kHz           | 60 Hz         | O |
|    |            |                      | 56.5 kHz           | 70 Hz         | O |
|    | XGA        | 1024 x 768           | 60.0 kHz           | 75 Hz         | O |
|    |            |                      | 47.7 kHz           | 60 Hz         | O |
|    | WXGA       | 1360 x 768           | 47.7 kHz           | 60 Hz         | O |

VGA and XGA are registered trademarks of International Business Machines Corp.

### CLEARING THE SECRET NUMBER

If you forget the secret number, clear the secret number using the following procedure.

- Select an item from the list below to display the secret number input screen. (For operating the on-screen display menu, see page 17.)
  - "EZ Setup", "CH Setup", "Parental CTRL" or "Reset" on the Setup menu.
  - "Software Update" on the Option menu.
- Press and hold both **CH/** and **VOL+** on the TV simultaneously until the message appears on the screen.

The secret number is      .

#### NOTE

- As a precautionary measure, make a note of your secret number above, cut it from this manual, and keep it in a safe place.

# Calling for Service

For location of the nearest Sharp Authorized Service, or to obtain product literature, accessories, supplies, or customer assistance, please call 1-800-BE-SHARP.

## LIMITED WARRANTY

### CONSUMER LIMITED WARRANTY

SHARP ELECTRONICS CORPORATION warrants to the first consumer purchaser that this Sharp brand Liquid Crystal Display product (the "Product"), when shipped in its original container, will be free from defective workmanship and materials, and agrees that it will, at its option, either repair the defect or replace the defective Product or part thereof with a new or remanufactured equivalent at no charge to the purchaser for parts or labor for the period(s) set forth below.

This warranty does not apply to any appearance items of the Product or if the serial number or model number affixed to the Product has been removed, defaced, changed, altered or tampered with. This warranty does not cover installation or signal reception problems. This limited warranty will not apply if the Product has been or is being used in a commercial setting or application; this warranty is meant solely for the non-commercial, household use of the Product by consumers in their home or residence. If you intend to or already use this Product for commercial purposes or in a commercial setting, there are warranties available to cover your use of this Product, the terms of which may vary. Please contact **1-888-GO-SHARP** for further information.

In order to enforce your rights under this limited warranty, you should follow the steps set forth below. You must be able to provide proof of purchase to the servicer, which proof must include the date of purchase.

To the extent permitted by applicable state law, the warranties set forth are in lieu of, and exclusive of, all other warranties, express or implied. Specifically ALL OTHER WARRANTIES OTHER THAN THOSE SET FORTH ABOVE ARE EXCLUDED. ALL EXPRESS AND IMPLIED WARRANTIES INCLUDING THE WARRANTIES OF MERCHANTABILITY, FITNESS FOR USE, AND FITNESS FOR A PARTICULAR PURPOSE ARE SPECIFICALLY EXCLUDED. IF, UNDER APPLICABLE STATE LAW, IMPLIED WARRANTIES MAY NOT VALIDLY BE DISCLAIMED OR EXCLUDED, THE DURATION OF SUCH IMPLIED WARRANTIES IS LIMITED TO THE PERIOD(S) FROM THE DATE OF PURCHASE SET FORTH BELOW. THIS WARRANTY GIVES YOU SPECIFIC LEGAL RIGHTS. YOU MAY ALSO HAVE OTHER RIGHTS WHICH VARY FROM STATE TO STATE.

The warranties given herein shall be the sole and exclusive warranties granted by Sharp and shall be the sole and exclusive remedy available to the purchaser and only for the time periods set forth herein. No other representations or promises made by anyone are permitted. Correction of defects, in the manner and for the period of time described herein, shall constitute complete fulfillment of all liabilities and responsibilities of Sharp to the purchaser with respect to the Product, and shall constitute full satisfaction of all claims, whether based on contract, negligence, strict liability or otherwise. Sharp does not warrant nor shall Sharp be liable, or in any way responsible, for Products which have been subject to abuse (including, but not limited to, improper voltage), accident, misuse, negligence, lack of reasonable care, alteration, modification, tampering, misuse, improper operation or maintenance or any damages or defects in the Product which were caused by repairs or attempted repairs performed by anyone other than a Sharp authorized servicer. Nor shall Sharp be liable or in any way responsible for any incidental or consequential economic or property damage. Some states do not allow limits on warranties or on remedies for breach in certain transactions; in such states, the limits herein may not apply.

**THIS LIMITED WARRANTY IS VALID ONLY IN THE FIFTY (50) UNITED STATES, THE DISTRICT OF COLUMBIA AND PUERTO RICO.**

### Model Specific Section

#### Your Product Model Number & Description:

LC-32SB27UT LCD Color Television

(Be sure to have this information available when you need service for your Product.)

#### Warranty Period for this Product:

One (1) year parts and labor from the date of purchase.

#### Additional Exclusions from Warranty Coverage (if any):

Image Retention resulting from a fixed image being displayed for long periods of time is not covered by this Limited Warranty (see Operation Manual on how to prevent this).

#### Where to Obtain Service:

From a Sharp Authorized Servicer located in the United States. To find the location of the nearest Sharp Authorized Servicer, please call Sharp toll free at 1-800-BE-SHARP.

#### What to do to Obtain Service:

Ship prepaid or carry in your Product to a Sharp Authorized Servicer. Be sure to have proof of purchase available. If you ship the Product, be sure it is insured and packaged securely. Please use two persons to carry the Product, transport it in its original packaging, and ensure that the Product is covered to avoid scratches and damage. Sharp shall not be responsible for lost, stolen or misdirected mail or for damage to the product incurred during shipping.

TO OBTAIN PRODUCT INFORMATION OR PURCHASE ACCESSORIES AND EXTENDED WARRANTIES, CALL **1-800-BE-SHARP** OR VISIT [www.sharpsusa.com](http://www.sharpsusa.com)

# SHARP®

## SHARP ELECTRONICS CORPORATION

Sharp Plaza, Mahwah, New Jersey 07495-1163

## SHARP CORPORATION

**SHARP®****LIMITED WARRANTY***Consumer Electronics Products***Congratulations on your purchase!**

Sharp Electronics of Canada Ltd. (hereinafter called "Sharp") gives the following express warranty to the first consumer purchaser for this Sharp brand product, when shipped in its original container and sold or distributed in Canada by Sharp or by an Authorized Sharp Dealer:

Sharp warrants that this product is free, under normal use and maintenance, from any defects in material and workmanship. If any such defects should be found in this product within the applicable warranty period, Sharp shall, at its option, repair or replace the product as specified herein.

This warranty shall not apply to:

- (a) Any defects caused or repairs required as a result of abusive operation, negligence, accident, improper installation or inappropriate use as outlined in the owner's manual.
- (b) Any Sharp product tampered with, modified, adjusted or repaired by any party other than Sharp, Sharp's Authorized Service Centres or Sharp's Authorized Servicing Dealers.
- (c) Damage caused or repairs required as a result of the use with items not specified or approved by Sharp, including but not limited to head cleaning tapes and chemical cleaning agents.
- (d) Any replacement of accessories, glassware, consumable or peripheral items required through normal use of the product including but not limited to earphones, remote controls, AC adapters, batteries, temperature probe, stylus, trays, filters, belts, ribbons, cables and paper.
- (e) Any cosmetic damage to the surface or exterior that has been defaced or caused by normal wear and tear.
- (f) Any damage caused by external or environmental conditions, including but not limited to transmission line/power line voltage or liquid spillage.
- (g) Any product received without appropriate model, serial number and CSA/cUL markings.
- (h) Any products used for rental or commercial purposes.
- (i) Any installation, setup and/or programming charges.

Should this Sharp product fail to operate during the warranty period, warranty service may be obtained upon delivery of the Sharp product together with proof of purchase and a copy of this LIMITED WARRANTY statement to an Authorized Sharp Service Centre or an Authorized Sharp Servicing Dealer. In home warranty service may be provided at Sharp's discretion on any Sharp television with the screen size of 27" or larger and on any Sharp Over-the-Range Microwave Oven.

This warranty constitutes the entire express warranty granted by Sharp and no other dealer, service centre or their agent or employee is authorized to extend, enlarge or transfer this warranty on behalf of Sharp. To the extent the law permits, Sharp disclaims any and all liability for direct or indirect damages or losses or for any incidental, special or consequential damages or loss of profits resulting from a defect in material or workmanship relating to the product, including damages for the loss of time or use of this Sharp product or the loss of information. The purchaser will be responsible for any removal, reinstallation, transportation and insurance costs incurred. Correction of defects, in the manner and period of time described herein, constitute complete fulfillment of all obligations and responsibilities of Sharp to the purchaser with respect to the product and shall constitute full satisfaction of all claims, whether based on contract, negligence, strict liability or otherwise.

**WARRANTY PERIODS:**

|                          | Parts & Labour (exceptions noted)               |
|--------------------------|---|
| Audio Product            | 1 year  |
| Camcorder                | 1 year  |
| DVD Product              | 1 year  |
| Projector                | 1 year (lamp 90 days)                           |
| LCD TV                   | 1 year  |
| Microwave Oven           | 1 year (magnetron component-4 additional years) |
| Air Purifier             | 1 year  |
| Portable Air Conditioner | 1 year  |

To obtain the name and address of the nearest Authorized Sharp Service Centre or Dealer, please contact:  
SHARP ELECTRONICS OF CANADA LTD. 335 Britannia Road East, Mississauga, Ontario L4Z 1W9

For more information on this Warranty, Sharp Extended Warranty Offers, Sharp Canada Products, Accessory Sales, Dealer or Service Locations, please call (905) 568-7140  
Visit our Web site: [www.sharp.ca](http://www.sharp.ca)

