

ZV457MG9 A

DIGITAL VIDEO DISC RECORDER & VIDEO CASSETTE RECORDER WITH DIGITAL TUNER



THANK YOU FOR CHOOSING MAGNAVOX.

NEED HELP FAST?

READ YOUR QUICK GUIDE AND/OR OWNER'S MANUAL FIRST FOR QUICK TIPS THAT MAKE USING YOUR MAGNAVOX PRODUCT MORE ENJOYABLE.

IF YOU HAVE READ YOUR INSTRUCTIONS AND STILL NEED ASSISTANCE,
YOU MAY ACCESS OUR ONLINE HELP AT [HTTP://WWW.MAGNAVOX.COM/SUPPORT](http://www.magnavox.com/support)
OR CALL **1-800-605-8610** WHILE WITH YOUR PRODUCT.

INSTRUCCIONES EN ESPAÑOL INCLUIDAS.



4. Prepare

- 1 After all the connections are complete, connect the AC power cord.
- 2 Insert two Size AA (R6) batteries.
- 3 Press [STANDBY-ON] to turn on the unit.
- 4 Turn on your TV.
- 5 Press the button on the TV's remote control that accesses the external input channel repeatedly until you see "Initial Setup" menu. (Please refer to your TV's owner's manual.)

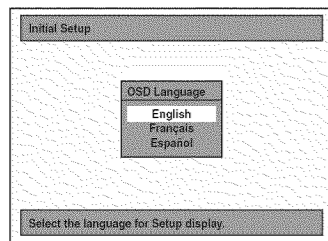
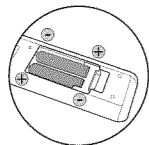

If the TV is connected by an HDMI cable, it may take a while for the "Initial Setup" menu to come up.

- 6 Use [▲/▼] to select your desired language, then press [OK].
- 7 Use [▲/▼] to select the type of broadcasting signal, then press [OK].

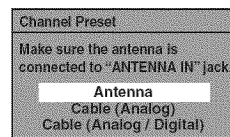

"Auto Presetting Now"

If a PBS (public broadcasting station) is available in your area, clock setting will automatically be performed and the correct clock will be displayed following the channel preset procedure. Initial setting is then complete. Press [RETURN] to exit.

If a PBS (public broadcasting station) is not available in your area, press [OK]. Then proceed to step 5 in "Manual Clock Setting" on page 32 in the Owner's Manual.

5. Record(DVD)

Press [DVD] first.

- 1 Insert a recordable disc (refer to page 26 in the Owner's Manual on how to insert a disc).

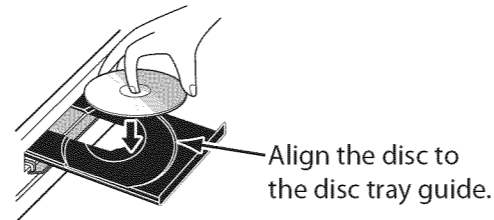

- 2 Press [REC MODE] repeatedly to select a recording mode.

- 3 Select the appropriate external input channel by pressing [SOURCE] or [CHANNEL+ /-]. Press [DTV/TV] to select analog TV or digital TV, then use [CHANNEL+ /-] or [the Number buttons] and [.] (for digital TV channels) to select a desired channel to record.

- 4 Press [REC] to start recording.

- 5 Press [STOP] to stop recording.

The title list will appear automatically after writing to a disc completes.

e.g.) DVD+R

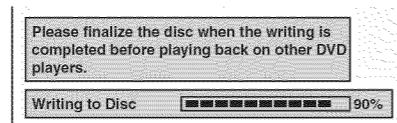

- Press [STOP] to exit the title list.

You will need to finalize DVD+R, DVD-RW or DVD-R to play them back on other DVD players. Refer to page 54 in the Owner's Manual on how to finalize a disc.



For more info, please contact **1-800-605-8610** or visit : <http://www.magnavox.com/support>



Please read the supplied Owner's Manual for the detailed instructions.

MAGNAVOX

Quick Guide

Digital Video Disc Recorder & Video Cassette Recorder with Digital Tuner ZV457MG9 A

1. Antenna Connection > 2. Select > 3. Connect > 4. Prepare > 5. Record (DVD)

1. Antenna Connection

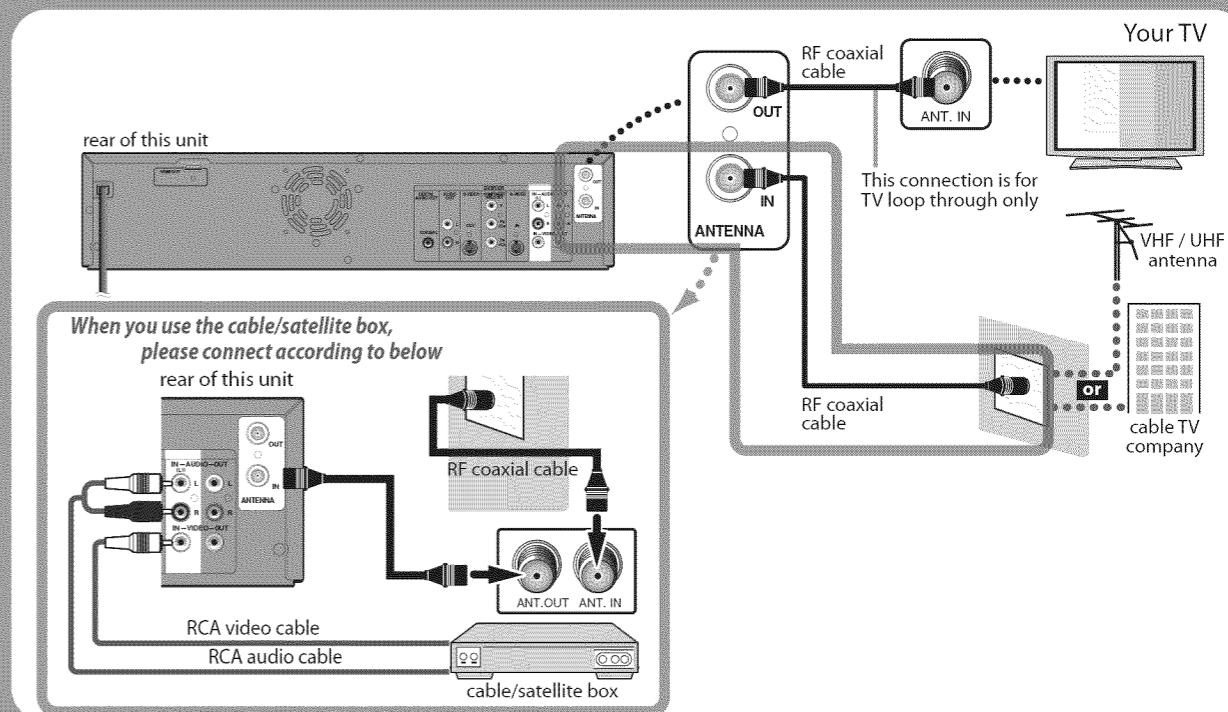

select the appropriate connection

Connect

Best progressive compatible

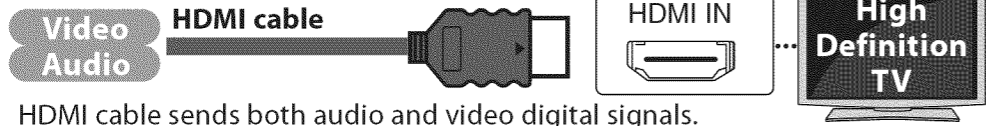

HDMI cable sends both audio and video digital signals. (No additional audio connection is required.)

- HDMI cable not included.** High Speed HDMI Cable (also known as HDMI category 2 cable) is recommended for the better compatibility.

D I Cable

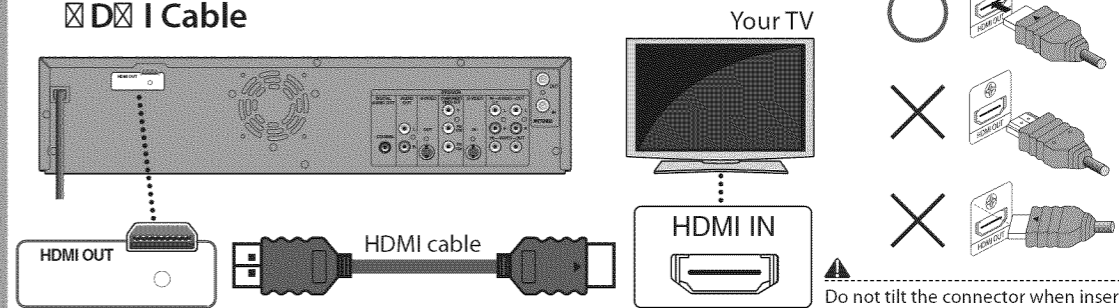

Better progressive compatible 80p

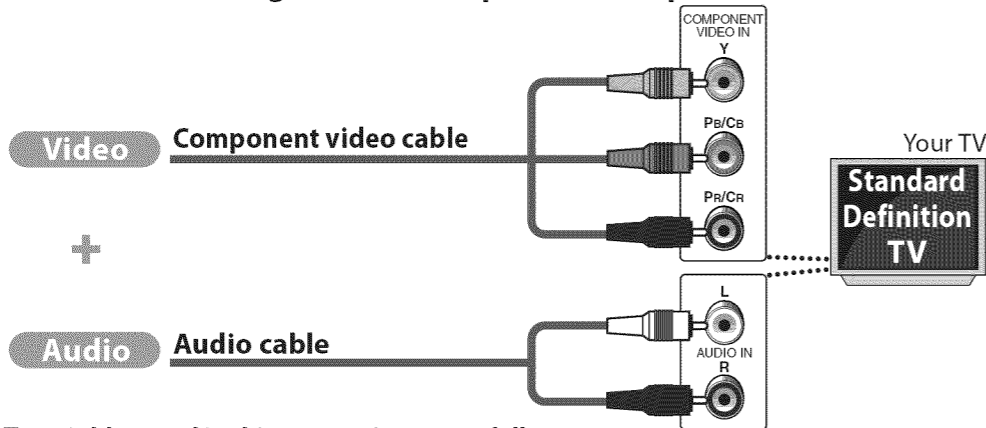

- Cables used in this connection are as follows:**
 - Audio cable (L/R) x 1 (Included)
 - Component video cable x 1 (Cable not included.)

Component Video Cable and Audio Cable

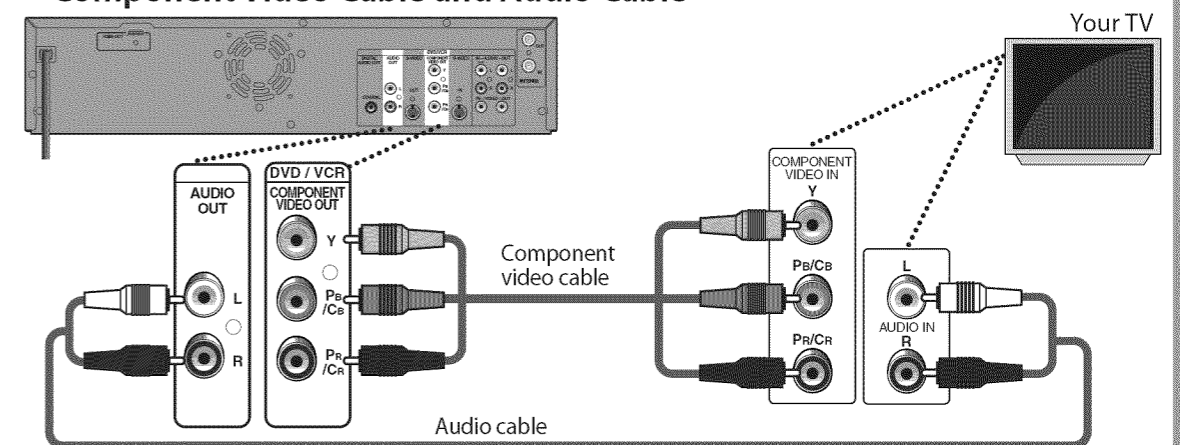

Basic supports only 80i resolution.

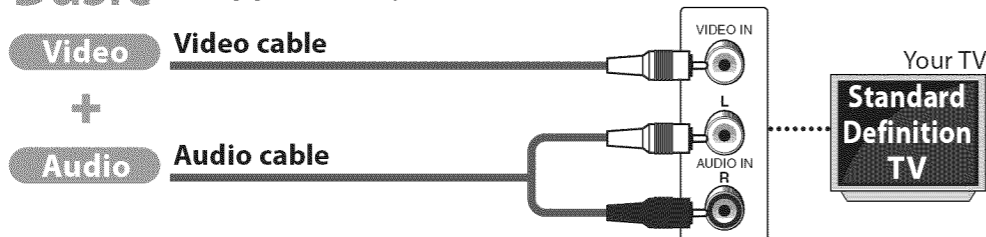

Refer to "Connecting to a TV Using the S-Video Out Jack" on page 17 in the Owner's Manual for the connection using an S-video cable.

- Cables used in this connection are as follows:**
 - Audio cable (L/R) x1 (Included)
 - Video cable x1 (Included)

Video Cable and Audio Cable

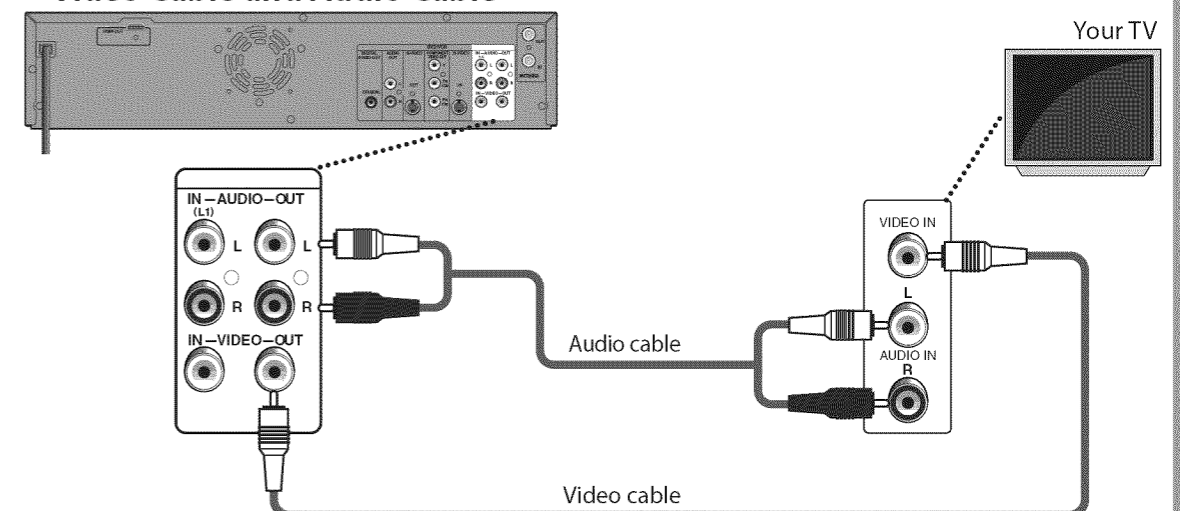

SAFETY INFORMATION

The model and serial numbers of this unit may be found on the cabinet.
You should record and retain those numbers for future reference.

Model No.: _____

Serial No.: _____

WARNING: TO REDUCE THE RISK OF FIRE OR ELECTRIC SHOCK, DO NOT EXPOSE THIS APPARATUS TO RAIN OR MOISTURE. APPARATUS SHALL NOT BE EXPOSED TO DRIPPING OR SPLASHING AND NO OBJECTS FILLED WITH LIQUIDS, SUCH AS VASES, SHALL BE PLACED ON THE APPARATUS.



CAUTION
RISK OF ELECTRIC SHOCK
DO NOT OPEN



CAUTION:

TO REDUCE THE RISK OF ELECTRIC SHOCK, DO NOT REMOVE COVER (OR BACK). NO USER SERVICEABLE PARTS INSIDE. REFER SERVICING TO QUALIFIED SERVICE PERSONNEL.



The lightning flash with arrowhead symbol, within an equilateral triangle, is intended to alert the user to the presence of uninsulated "dangerous voltage" within the product's enclosure that may be of sufficient magnitude to constitute a risk of electric shock to persons.



The exclamation point within an equilateral triangle is intended to alert the user to the presence of important operating and maintenance (servicing) instructions in the literature accompanying the appliance.

The important note is located on the rear or bottom of the cabinet.

IMPORTANT SAFETY INSTRUCTIONS

1. Read these instructions.
2. Keep these instructions.
3. Heed all warnings.
4. Follow all instructions.
5. Do not use this apparatus near water.
6. Clean only with dry cloth.
7. Do not block any ventilation openings. Install in accordance with the manufacture's instructions.
8. Do not install near any heat sources such as radiators, heat registers, stoves, or other apparatus (including amplifiers) that produce heat.
9. Do not defeat the safety purpose of the polarized or grounding-type plug. A polarized plug has two blades with one wider than the other. A grounding type plug has two blades and a third grounding prong. The wide blade or the third prong are provided for your safety. If the provided plug does not fit into your outlet, consult an electrician for replacement of the obsolete outlet.
10. Protect the power cord from being walked on or pinched particularly at plugs, convenience receptacles, and the point where they exit from the apparatus.
11. Only use attachments/accessories specified by the manufacturer.
12. Use only with the cart, stand, tripod, bracket, or table specified by the manufacturer, or sold with the apparatus. When a cart is used, use caution when moving the cart/apparatus combination to avoid injury from tip-over.
13. Unplug this apparatus during lightning storms or when unused for long periods of time.
14. Refer all servicing to qualified service personnel. Servicing is required when the apparatus has been damaged in any way, such as power-supply cord or plug is damaged, liquid has been spilled or objects have fallen into the apparatus, the apparatus has been exposed to rain or moisture, does not operate normally, or has been dropped.



FCC WARNING

This equipment may generate or use radio frequency energy. Changes or modifications to this equipment may cause harmful interference unless the modifications are expressly approved in the manual. The user could lose the authority to operate this equipment if an unauthorized change or modification is made.

RADIO-TV INTERFERENCE

This equipment has been tested and found to comply with the limits for a Class B digital device, pursuant to Part 15 of the FCC Rules. These limits are designed to provide reasonable protection against harmful interference in a residential installation. This equipment generates, uses, and can radiate radio frequency energy and, if not installed and used in accordance with the instructions, may cause harmful interference to radio communications. However, there is no guarantee that interference will not occur in a particular installation. If this equipment does cause harmful interference to radio or television reception, which can be determined by turning the equipment off and on, the user is encouraged to try to correct the interference by one or more of the following measures:

- 1) Reorient or relocate the receiving antenna.
- 2) Increase the separation between the equipment and receiver.
- 3) Connect the equipment into an outlet on a circuit different from that to which the receiver is connected.
- 4) Consult the dealer or an experienced radio/TV technician for help.

This Class B digital apparatus complies with Canadian ICES-003.

Cet appareil numérique de la classe B est conforme à la norme NMB-003 du Canada.

Disconnect the mains plug to shut off when find trouble or not in use. The mains plug shall remain readily operable.

SAFETY INFORMATION

CAUTION: Danger of explosion if battery is incorrectly replaced. Replace only with the same or equivalent type.
WARNING: Batteries (Battery pack or battery installed) shall not be exposed to excessive heat such as sunshine, fire, or the like.

LASER SAFETY

This apparatus employs a laser. Only a qualified service person should remove the cover or attempt to service this apparatus, due to possible eye injury.

CAUTION: Use of controls or adjustments or performance of procedures other than those specified herein may result in hazardous radiation exposure.

CAUTION: Visible and invisible laser radiation when open and interlock defeated. Do not stare into beam.

LOCATION: Inside, near the deck mechanism.

IMPORTANT COPYRIGHT INFORMATION

Unauthorized copying, broadcasting, public performance and lending of discs are prohibited. This product incorporates copyright protection technology that is protected by U.S. patents and other intellectual property rights. Use of this copyright protection technology must be authorized by Macrovision, and is intended for home and other limited viewing uses only unless otherwise authorized by Macrovision. Reverse engineering or disassembly is prohibited.

Do not place the unit on the furniture that is capable of being tilted by a child and an adult leaning, pulling, standing or climbing on it. A falling unit can cause serious injury or even death.

To Avoid the Hazards of Electrical Shock and Fire

- Do not handle the power cord with wet hands.
- Do not pull on the power cord when disconnecting it from an AC outlet. Grasp it by the plug.
- Do not put your fingers or objects into the unit.

Location and Handling

- Do not install the unit in direct sunlight, near strong magnetic fields, or in a place subject to dust or strong vibration.
- Avoid a place with drastic temperature changes.
- Install the unit in a horizontal and stable position. Do not place anything directly on top or bottom of the unit. Depending on your external devices, noise or disturbance of the picture and/or sound may be generated if the unit is placed too close to them. In this case, please ensure enough space between the external devices and the unit.
- Depending on the environment, the temperature of this unit may increase slightly. This is not a malfunction.
- Be sure to remove the disc and unplug the AC power cord from the outlet before carrying the unit.

Dew Condensation Warning

- Dew condensation may form inside the unit in the following conditions. If so, do not use this unit at least for a few hours until its inside gets dry.
 - The unit is moved from a cold place to a warm place.
 - Under conditions of high humidity.
 - After heating a cold room.

Note about Recycling

- This unit's packaging materials are recyclable and can be reused. Please dispose of any materials in accordance with your local recycling regulations.
- Batteries should never be thrown away or incinerated but disposed of in accordance with your local regulations concerning chemical wastes.



Notice for Progressive Scan Output

- Consumers should note that not all high definition television sets are fully compatible with this product and may cause artifacts to be displayed in the picture. In case of picture problems with 525(480) progressive scan output, it is recommended that the user switch the connection to the 'standard definition' output. If there are questions regarding your TV set compatibility with this 525p(480p) DVD player, please contact our customer service center.

SAFETY INFORMATION

Supplied Accessories

remote control (NB884UD) with batteries (AAx2)

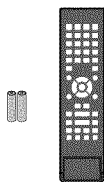

RF coaxial cable (WPZ0901TM005/WPZ0901TM002)



RCA audio/video cables (WPZ0102TM018/WPZ0102LTE01)



owner's manual (1VMN26713)

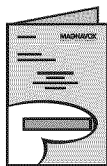

quick guide (1VMN26714)

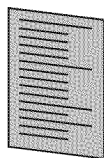

Maintenance

Servicing

- Please refer to relevant topics on "TROUBLESHOOTING" on pages 97-100 before returning the product.
- If this unit becomes inoperative, do not try to correct the problem by yourself. There are no user-serviceable parts inside. Turn the unit to the standby mode, unplug the power plug and please call our help line mentioned on the front page to locate an Authorized Service Center.

Cleaning the cabinet

- Use a soft cloth slightly moistened with a mild detergent solution. Do not use a solution containing alcohol, spirits, ammonia or abrasive.

Cleaning discs

- When a disc becomes dirty, clean it with a cleaning cloth. Wipe the disc from the center to out. Do not wipe in a circular motion.
- Do not use solvents such as benzine, thinner, commercially available cleaners, detergent, abrasive cleaning agents or antistatic spray intended for analog records.

Cleaning the disc lens

- If this unit still does not perform properly although you refer to the relevant sections and to "TROUBLESHOOTING" in this owner's manual, the laser optical pickup unit may be dirty. Consult your dealer or an Authorized Service Center for inspection and cleaning of the laser optical pickup unit.

Disc handling

- Handle the discs so that fingerprints and dust do not adhere to the surfaces of the discs.
- Always store the disc in its protective case when it is not used.

Auto head cleaning

- Automatically cleans video heads as you insert or remove a cassette, so you can see a clear picture.
 - Playback picture may become blurred or interrupted while the TV program reception is clear. Dirt accumulated on the video heads after a long period of use, or the usage of rental or worn tapes can cause this problem. If a streaky or snowy picture appears during playback, the video heads in your unit may need to be cleaned.
1. Please visit your local Audio/Video store and purchase a good quality VHS video head cleaner.
 2. If a video head cleaner does not solve the problem, please consult your dealer or an Authorized Service Center.

Note

- Remember to read the instructions along with the video head cleaner before use.
- Clean video heads only when problems occur.

IR signal check

If the remote control does not work properly, you can test if the remote control sends out the infrared signal with AM radio or a digital camera (including built-in camera of cellular phone). It will help to define the cause of malfunction.

• With an AM radio:

Tune an AM radio to a station with no broadcasting. Press a button on remote control toward the radio. Sound will be fluttering when you press any key and the radio receives the signal. This means the remote control is working.

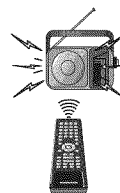

• With a digital camera (including built-in camera of cellular phone):

Direct a digital camera to remote control, press and hold a button on remote control. If infrared light appears through digital camera, the remote control is working.



SAFETY INFORMATION

Trademark Information



is trademark of Eastman Kodak Company.



Manufactured under license from Dolby Laboratories. Dolby and the double-D symbol are trademarks of Dolby Laboratories.

Dolby Digital Recording

“Dolby® Digital Recording enables consumers to record high-quality video with stereo sound on recordable DVD discs. The technology, when utilized instead of PCM recording, also saves recordable disc space, allowing for higher video resolution or extended recording time on each DVD. DVDs created using Dolby Digital Recording will play back on all DVD-video players.”

Note: This is true when the players are compatible with actual recordable DVD discs.



HDMI, the HDMI logo and High-Definition Multimedia Interface are trademarks or registered trademarks of HDMI Licensing LLC.

© 2009 Funai Electric Co., Ltd.

All rights reserved. No part of this manual may be reproduced, copied, transmitted, disseminated, transcribed, downloaded or stored in any storage medium, in any form or for any purpose without the express prior written consent of Funai. Furthermore, any unauthorized commercial distribution of this manual or any revision hereto is strictly prohibited.

Information in this document is subject to change without notice. Funai reserves the right to change the content herein without the obligation to notify any person or organization of such changes.

FUNAI with the  design is a registered trademark of Funai Electric Co., Ltd and may not be used in any way without the express written consent of Funai. All other trademarks used herein remain the exclusive property of their respective owners. Nothing contained in this manual should be construed as granting, by implication or otherwise, any license or right to use any of the trademarks displayed herein. Misuse of any trademarks or any other content in this manual is strictly prohibited. Funai shall aggressively enforce its intellectual property rights to the fullest extent of the law.

CONTENTS

Introduction

SAFETY INFORMATION	2
FEATURES	8
Symbols Used in this Owner's Manual	9
FUNCTIONAL OVERVIEW	10
Front Panel	10
Rear Panel	11
Remote Control	12
Front Panel Display	14

Connections

CONNECTION	15
Antenna Connection (Required)	15
Overview	15
Connecting to a TV with an HDMI™	16
Compatible Port	16
Connecting to a TV Using	
Component Video Out Jacks	17
Connecting to a TV Using the S-Video Out Jack	17
Connecting to a TV Using Audio / Video Jacks	18
Connecting to a Cable / Satellite Box	19
Connecting to a TV without Audio / Video Jacks	20
Digital Audio Connection	21

Basic Setup

BEFORE YOU START	22
Finding the Viewing Channel on Your TV	22
Guide to On-Screen Display / Menu	23
Main Menu	25
Switching DVD / VCR Mode	26
How to Insert a Disc / Cassette Tape	26
INITIAL SETTING	27
CHANNEL SETTING	28
Auto Channel Scan	28
Adding / Deleting Channels	29
SETTING THE CLOCK	31
Auto Clock Setting	31
Manual Clock Setting	32
Daylight Saving Time	32
TUNER SETTINGS	33
Switching Analog Mode / Digital Mode	33
Channel Selection	33
Selecting TV Audio	34
DTV Closed Caption	36
Closed Caption Style	37

Recording

INFORMATION ON DVD RECORDING	39
BEFORE RECORDING	40
Make Recording Compatible	40
Setting for Auto Chapter	40
Recording the DTV Closed Caption	40
BASIC RECORDING &	
ONE-TOUCH TIMER RECORDING	41
TIMER RECORDING	43
Hints for Timer Recording	46
OVERWRITING UNNECESSARY TITLE	47
Overwriting from the Beginning of the Title	47
Overwriting in the Middle of the Title	47
Hints for Overwriting	48
SETTINGS FOR AN EXTERNAL DEVICE	49
Connection to an External Device	49
Recording from an External Device	50
BI-DIRECTIONAL DUBBING	51
SETTING A DISC TO PROTECT	53
PLAYING THE DISCS ON OTHER DVD PLAYERS	54
Finalizing a Disc	54
Auto Finalizing	55

CONTENTS

Playback

INFORMATION ON PLAYBACK	56
BASIC PLAYBACK	58
Direct Playback	58
Playback from the Title List	59
Playing Back an Audio CD and a CD-RW / -R with MP3 / JPEG Files	60
Using the Title / Disc Menu	61
Pause	61
SPECIAL PLAYBACK	62
Resume Playback	62
Fast Forward / Fast Reverse Playback	62
Skipping TV Commercials During Playback	62
Rapid Playback	62
Step by Step Playback	63
Slow Forward / Slow Reverse Playback	63
Zoom	63
Marker Setting	64
Repeat Playback	64
Random Playback	65
Slide Show	65
Program Playback	65
SEARCH	66
Title / Chapter Search	66
Track Search	66
Time Search	67
SELECTING THE FORMAT OF AUDIO AND VIDEO ..	68
Switching Subtitles	68
Switching Audio Soundtrack	68
Switching Virtual Surround System	69
Switching Camera Angles	69
Reducing Block Noise	69

Editing

INFORMATION ON DISC EDITING	70
Guide to a Title List	70
Editing Discs	70
EDITING DISCS	71
Deleting a Title	71
Putting Names on Titles	72
Setting Chapter Marks	73
Clearing Chapter Marks	74
Hiding Chapters	76
Setting Pictures for Thumbnails	77
Dividing a Title	78
Putting Name on Disc	79
Erasing Disc	80
Making Edits Compatible	81

Function Setup

LIST OF SETTINGS	82
SETUPS	85
Playback	85
Display	88
Video	91
HDMI	92
Reset All	93

VCR Functions

VCR FUNCTIONS	94
Information on VCR Functions	94
Playback	94
Recording	94
One-touch Timer Recording (OTR)	95
Index Search	95
Time Search	96
Other Operations	96

Others

TROUBLESHOOTING	97
LANGUAGE CODE	101
GLOSSARY	102
SPECIFICATIONS	103

Español

ESPAÑOL	104
----------------------	------------

LIMITED WARRANTY	Back cover
-------------------------------	-------------------

FEATURES

This unit not only plays back DVD, CD and VCR but also offers features for you to record on DVD and edit them after that. The following features are offered with this unit.

Recording

This unit is compatible with DVD+RW/DVD-RW, which are rewritable repeatedly and DVD+R/DVD-R, which are available for recording once. Even if you choose DVD-RW/DVD-R, these discs will automatically be recorded in the DVD+VR mode. Also, this unit allows you to record to the cassette tape. You can choose either one for your convenience.

DVD

VCR

Up to 12 program recording:

You can program the unit to record up to 12 programs within a one-month period. Daily or weekly program recordings are also available.

One-touch timer recording (OTR):

You can easily set a recording time as you prefer. Every time [REC] is pressed during recording, the recording time will be increased by 30 minutes up to 6 hours for DVD, and 8 hours for VCR. The recording automatically stops when the recording time you set is reached or the disc is full.

Dubbing mode:

You can copy a DVD to a cassette tape or copy a cassette tape to a DVD. This function will be possible only if the DVD or a cassette tape is not copy protected. You cannot record on a cassette tape when its erase-protection tab is removed.

Left channel stereo recording:

This unit can record the sound of the left channel monaural input as left and right channels automatically.

DVD

Automatic chapter mark setting:

Chapter marks will be put on recordings as you set before attempting to record.

Automatic title list making:

The unit makes a title list with the index automatically.

Playback

DVD

Theater surround sound in your home:

When connecting the unit to an amplifier or a decoder which is compatible with Dolby Digital, you can experience the theater surround sound from discs with surround sound system.

Quick search for what you want to watch:

You can easily find the part you want to watch using the search function. Search for a desired point on a disc by title, chapter or time.

Virtual surround system:

You can enjoy stereophonic space through your existing 2 channel stereo system.

Playing back MP3 / JPEG / Kodak Picture CD files:

You can enjoy MP3 / JPEG / Kodak Picture CD files which are recorded on CD-RW/-R.

VCR

Quick search for what you want to watch:

You can easily find the part you want to watch using the index search/time search functions. An index mark will be assigned at the beginning of each recording you make. For time search function, you can go to a specific point on a cassette tape by entering the exact amount of time you wish to skip.

Editing

DVD

Deleting titles:

You can delete titles which you do not need anymore.

Putting names on titles:

You can put your favorite names on titles.

Setting / clearing chapter marks:

You can set / clear chapter marks on titles.

Hiding chapters:

To keep others from playing back some chapters without permission, you can hide chapters.

Setting pictures for thumbnails:

You can change pictures for thumbnails.

Dividing titles (DVD+RW/DVD-RW only):

You can divide a title into 2 or more.

Putting name on disc:

You can put your favorite disc name.

Compatibility

DVD

Available for playing back discs on a regular DVD player:

Recorded discs can be played back on regular DVD players, including computer DVD drives compatible with DVD-video playback. Although DVD+R are playable on other units without finalization in most cases, it is recommended to finalize in order to stabilize the performance. For DVD-RW/-R, you need to finalize the recorded discs to play back on other DVD players.

Others

DVD

VCR

Progressive scan system

Unlike conventional interlace scanning, the progressive scan system provides less flickering and images in higher resolution than that of traditional television signals.

HDMI (High-Definition Multimedia Interface)

You can enjoy clearer audio/video output when connecting this unit to a display device with an HDMI-compatible port.

Symbols Used in this Owner's Manual

To specify for what disc type each function is, we put the following symbols at the beginning of each item to operate.

- * DVD-RW/-R recorded in VR mode or non compatible recording format are not playable.
- * DVD-RW recorded in the mode other than +VR is not recordable on this unit unless you erase all contents in the disc (refer to page 80).
- * DVD-R recorded in the mode other than +VR is not recordable on this unit.

Symbol	Description
--------	-------------

For Recording, Playing Back, and Editing

	Description refers to DVD+RW
---	------------------------------

	Description refers to DVD+R
---	-----------------------------

	Description refers to DVD-RW
---	------------------------------

	Description refers to DVD-R
---	-----------------------------

For Recording and Playing Back

	Description refers to VHS tapes Use only cassettes marked VHS (VHS)
---	--

For Playback only

	Description refers to DVD-video
---	---------------------------------

	Description refers to audio CD
---	--------------------------------

	Description refers to video CD with PBC function
---	--

	Description refers to video CD without PBC function
---	---

	Description refers to CD-RW/-R with MP3 files
---	---

	Description refers to CD-RW/-R with JPEG files (Kodak Picture CD files included)
---	--

If you do not find any of the symbols listed above under the function heading, the operation is applicable to all media.

FUNCTIONAL OVERVIEW

Front Panel

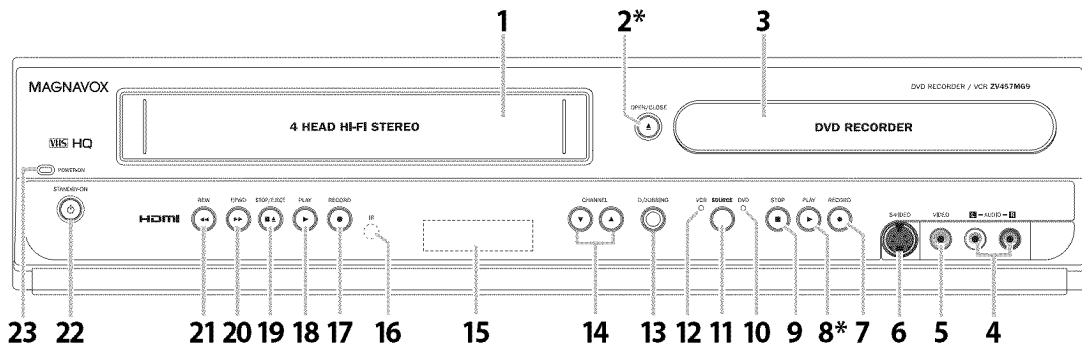

(*) The unit can also be turned on by pressing these buttons or inserting a cassette tape.

- 1. Cassette compartment (VCR)**
Insert a cassette tape here.
- 2. ▲ OPEN/CLOSE button (DVD)***
Press to open or close the disc tray.
- 3. Disc tray (DVD)**
Place a disc when it is open.
- 4. AUDIO input jacks (L2) (DVD/VCR)**
Use to connect external device with an RCA audio cable.
- 5. VIDEO input jack (L2) (DVD/VCR)**
Use to connect external device with an RCA video cable.
- 6. S-VIDEO input jack (L2) (DVD/VCR)**
Use to connect the S-video output of external device with an S-video cable.
- 7. ● RECORD button (DVD)**
 - Press once to start a recording.
 - Press repeatedly to start the one-touch timer recording.
- 8. ► PLAY button (DVD)***
Press to start or resume playback.
- 9. ■ STOP button (DVD)**
Press to stop playback or recording.
Press to stop the proceeding timer recording in DVD.
- 10. DVD indicator**
Lights up when the DVD output mode is selected.
- 11. SOURCE button (DVD/VCR)**
Press to select the component you wish to operate.
- 12. VCR indicator**
Lights up when the VCR output mode is selected.
- 13. D.DUBBING button (DVD/VCR)**
Press to start VCR to DVD (DVD to VCR) duplication which you set in the main menu.
- 14. CHANNEL ▼ / ▲ buttons (DVD/VCR)**
Press to change the channel up and down.
- 15. Display (DVD/VCR)**
Refer to "Front Panel Display" on page 14.
- 16. Infrared sensor window (DVD/VCR)**
Receive signals from your remote control so that you can control the unit from a distance.
- 17. ● RECORD button (VCR)**
Press once to start a recording. Press repeatedly to start the one-touch timer recording.
- 18. ► PLAY button (VCR)**
Press to start playback.
- 19. ■ ▲ STOP/EJECT button (VCR)**
 - Press to remove the cassette tape from the cassette compartment.
 - Press to stop cassette tape playback or recording.
 - Press to stop the proceeding timer recording in VCR.
- 20. ►► F.FWD button (VCR)**
Press to rapidly advance the cassette tape, or view the picture rapidly in forward during playback (forward search).
- 21. ◀◀ REW button (VCR)**
Press to rewind the cassette tape, or to view the picture rapidly in reverse during playback (rewind search).
- 22. ⏻ STANDBY-ON button (DVD/VCR)**
Press to turn on the unit, or to turn the unit to the standby mode. (To completely shut down the unit, you must unplug the AC power cord.)
- 23. POWER-ON indicator (DVD/VCR)**
Red LED lights up when power is on.

Rear Panel

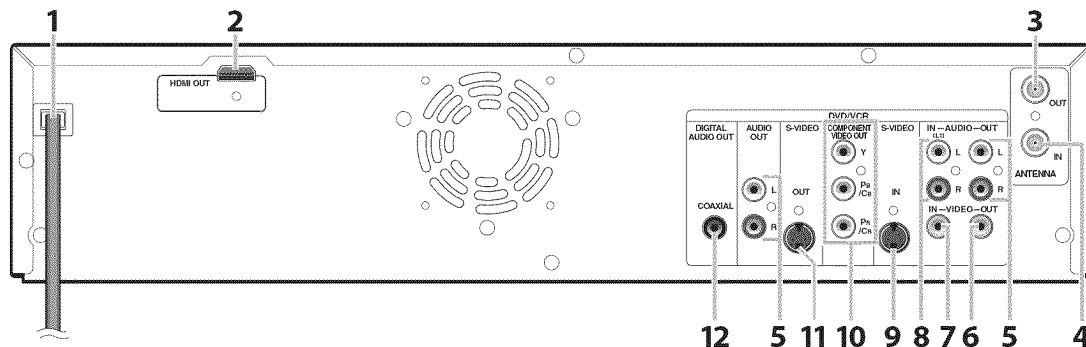

1. AC Power Cord

- Connect to a standard AC outlet to supply power to this unit.
- Unplug this cord from the AC outlet to completely shut down the unit.

2. HDMI OUT jack

Use an HDMI cable to connect to a display with an HDMI compatible port.

3. ANTENNA OUT jack

Use to connect an RF coaxial cable to pass the signal from the ANTENNA IN to your TV monitor.

4. ANTENNA IN jack

Use to connect an antenna.

5. AUDIO OUT jacks

Use to connect a TV monitor, AV receiver or other device with an RCA audio cable.

6. VIDEO OUT jack

Use to connect a TV monitor, AV receiver or other device with an RCA video cable.

7. VIDEO IN jack (L1)

Use to connect external device with an RCA video cable.

8. AUDIO IN jacks (L1)

Use to connect external device with an RCA audio cable.

9. S-VIDEO IN jack (L1)

Use to connect the S-video output of external device with an S-video cable.

10. COMPONENT VIDEO OUT jacks

Use to connect a TV monitor with component video inputs with a component video cable.

11. S-VIDEO OUT jack

Use to connect the S-video input of a TV monitor, AV receiver or other device with an S-video cable.

12. COAXIAL DIGITAL AUDIO OUT jack

Use to connect an AV receiver, Dolby Digital decoder or other device with a digital audio coaxial input jack with a digital audio coaxial cable.

Note

- Do not touch the inner pins of the jacks on the rear panel. Electrostatic discharge may cause permanent damage to the unit.
- This unit does not have the RF modulator.

Caution on using S-video, component, or HDMI connection for VCR:

- Only the playback video/audio are available with these connections.

FUNCTIONAL OVERVIEW

Remote Control

Installing the Batteries in the Remote Control

Install the batteries (AAx2) matching the polarity indicated inside battery compartment of the remote control.

1 Open the cover.

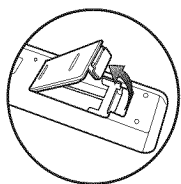

2 Insert batteries.

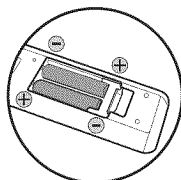

Make sure to match + and - on the batteries to the marks indicated in the battery compartment.

3 Close the cover.

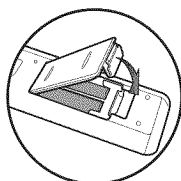

Note

Incorrect use of batteries can result in hazards such as leakage and bursting. Please observe the following:

- Do not mix new and old batteries together.
- Do not use different kinds of batteries together. Although they may look similar, different batteries may have different voltages.
- Make sure that the + and - ends of each battery match the indications in the battery compartment.
- Remove batteries from battery compartment that is not going to be used for a month or more.
- When disposing of used batteries, please comply with governmental regulations or environmental public instruction's rules that apply in your country or area.
- Do not recharge, short-circuit, heat, burn or disassemble batteries.







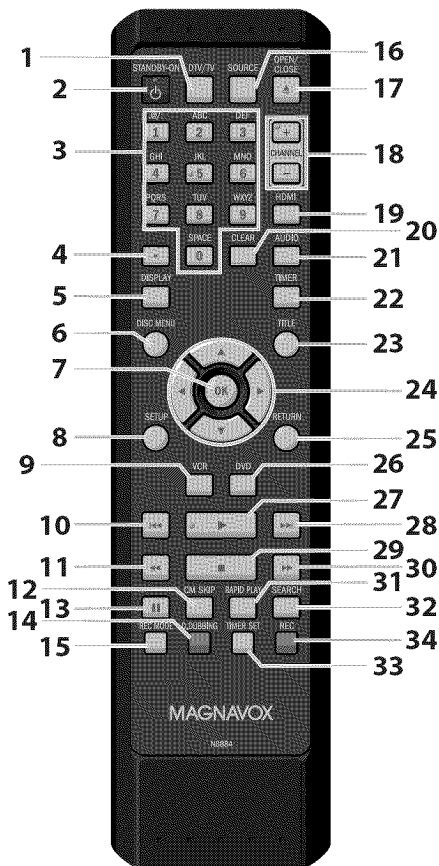
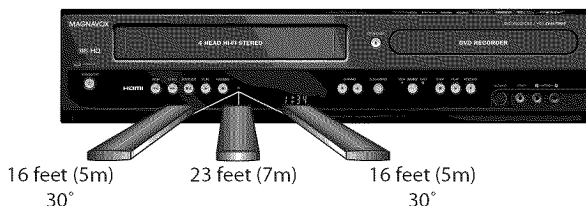







Using a Remote Control

Keep in mind the following when using the remote control:



- Make sure that there are no obstacles between the remote control and the infrared sensor window on the unit.
- Remote operation may become unreliable if strong sunlight or fluorescent light is shining on the infrared sensor window of the unit.
- Remote control for different devices can interfere with each other. Avoid using remote control for other device located close to the unit.
- Replace the batteries when you notice a fall off in the operating range of the remote control.
- The maximum operable ranges from the unit are as follows.
 - **Line of sight:** approx. 23 feet (7m)
 - **Either side of the center:** approx. 16 feet (5m) within 30°
 - **Above:** approx. 16 feet (5m) within 15°
 - **Below:** approx. 10 feet (3m) within 30°



FUNCTIONAL OVERVIEW

- 1. DTV/TV button (DVD/VCR)**
 - Press to switch between digital TV (DTV) mode and analog TV (TV) mode.
- 2. STANDBY-ON  button (DVD/VCR)**
 - Press to turn on the unit, or to turn the unit to the standby mode. (To completely shut down the unit, you must unplug the AC power cord.)
- 3. Number/Character buttons (DVD/VCR)**
 - Press to select channel numbers.
 - Press to select a title/chapter/track/file on display.
 - Press to enter values for the settings in the main menu.
 - Press to enter title names.
 - Press to start the index/time search in VCR mode.
- 4. Confirm () button (DVD/VCR)**
 - Analog mode:**
 - Press to confirm the channel selection made by [the Number buttons].
 - Digital mode:**
 - Press to confirm the major / minor channel selection made by [the Number buttons].
- 5. DISPLAY button (DVD/VCR)**
 - Press to display the display menu on or off.
- 6. DISC MENU button (DVD)**
 - Press to display the disc menu.
- 7. OK button (DVD/VCR)**
 - Press to confirm or select menu items.
- 8. SETUP button (DVD/VCR)**
 - Press to display the main menu.
 - During DVD playback, press and hold for more than 3 seconds to switch the progressive scanning mode to the interlace mode.
- 9. VCR button**
 - Press to select the VCR output mode.
- 10. PREV  button (DVD)**
 - During playback, press to return to the beginning of the current chapter, track or file.
 - When playback is in pause, press repeatedly to reverse the playback step by step.
- 11. REW  button (DVD/VCR)**
 - DVD mode:**
 - During playback, press to fast reverse playback.
 - When playback is paused, press to slow reverse playback.
 - VCR mode:**
 - During playback, press to rewind the cassette tape or to view the picture rapidly in reverse.
- 12. CM SKIP button (DVD)**
 - During playback, press to skip 30 seconds.
- 13. PAUSE  button (DVD/VCR)**
 - Press to pause playback or recording.
- 14. D.DUBBING button (DVD/VCR)**
 - Press to start VCR to DVD (DVD to VCR) duplication which you set in the main menu.
- 15. REC MODE button (DVD/VCR)**
 - Press repeatedly to switch the recording mode.
- 16. SOURCE button (DVD/VCR)**
 - Press to select the appropriate input.
- 17. OPEN/CLOSE  button (DVD/VCR)**
 - DVD mode:**
 - Press to open or close the disc tray.
 - VCR mode:**
 - Press to remove the cassette tape from the cassette compartment.
- 18. CHANNEL + / - buttons (DVD/VCR)**
 - DVD mode:**
 - Press to change the channel up and down.
 - VCR mode:**
 - Press to change the channel up and down.
 - Press to adjust the tracking during playback or in slow motion of the cassette tape.
 - While playback is in still mode, you can adjust the picture blurred vertically.
- 19. HDMI button (DVD)**
 - Press to set the HDMI connector's video signal output mode.
- 20. CLEAR button (DVD/VCR)**
 - DVD mode:**
 - Press to clear the password once entered or to cancel the programming for CD or to clear the selected marker number, etc.
 - VCR mode:**
 - Press to reset the tape counter.
- 21. AUDIO button (DVD/VCR)**
 - DTV mode:**
 - Press to switch the audio language for digital TV.
 - DVD mode:**
 - Press to display the audio menu during playback.
 - VCR mode:**
 - During playback of a Hi-Fi videotape, press to change the audio out setting.
- 22. TIMER button (DVD/VCR)**
 - Press to display the timer programming list.
- 23. TITLE button (DVD)**
 - Press to display the title list.
- 24. Cursor  /  /  /  buttons (DVD/VCR)**
 - Press to select items or settings.
- 25. RETURN button (DVD/VCR)**
 - Press to return to the previously displayed menu screen.
- 26. DVD button**
 - Press to select the DVD output mode.
- 27. PLAY  button (DVD/VCR)**
 - Press to start playback or resume playback.
- 28. NEXT  button (DVD)**
 - During playback, press to skip to the next chapter, track or file.
 - When playback is in pause, press repeatedly to forward the playback step by step.
- 29. STOP  button (DVD/VCR)**
 - Press to stop playback or recording.
 - DVD mode:**
 - Press to exit from the title list.
- 30. FFW  button (DVD/VCR)**
 - DVD mode:**
 - During playback, press to fast forward playback.
 - When playback is paused, press to slow forward playback.
 - VCR mode:**
 - During playback, press to rapidly advance the cassette tape or view the picture rapidly in forward.
 - When playback is paused, press to view the cassette tape in slow motion.
- 31. RAPID PLAY button (DVD)**
 - During playback, press to play back in a slightly faster/slower mode with keeping the audio quality.
- 32. SEARCH button (VCR)**
 - Press to call up the index or time search menu.
- 33. TIMER SET button (DVD/VCR)**
 - Press to set the unit in the timer standby mode. In the timer standby mode, press to cancel the mode and to turn the unit on.
- 34. REC button (DVD/VCR)**
 - Press once to start a recording.
 - Press repeatedly to start the one-touch timer recording.

Note

- If you turn this unit to the standby mode, [OPEN/CLOSE ] on the remote control is not available. Be sure to use [ OPEN/CLOSE] or [ STOP/EJECT] on the unit.

FUNCTIONAL OVERVIEW

Front Panel Display

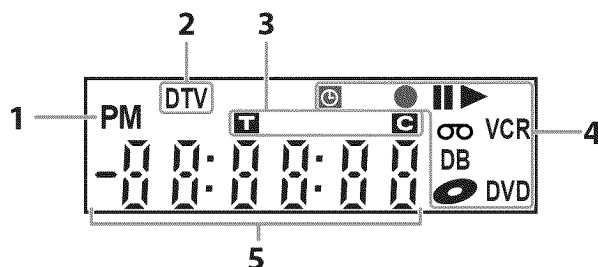

- | | | |
|--|--|---|
| <p>1.</p> <p>PM : Appears in the afternoon with the clock display.</p> <p>2.</p> <p>DTV : Appears when the channel is in DTV mode.</p> <p>3. Title / track / file and chapter mark</p> <p>T : Appears when indicating a title / track / file number.</p> <p>C : Appears when indicating a chapter number.</p> <p>4. Current status of the unit</p> <p> : Appears when playback is in pause, or in step by step playback.</p> <p>▶ : Appears when playing back a disc, or a cassette tape.</p> <p>▶▶ : Appears during slow forward / reverse playback.</p> | <p>⏰ : Appears when the timer programming or OTR has been set or is proceeding.</p> <p>⏰ : Flashes when all timer recordings have been finished.</p> <p>● : Appears during recording process.</p> <p>● : Flashes when a recording is in pause.</p> <p>Ⓛ : Appears when this unit is in DVD output mode and a disc is in the unit.</p> <p>Ⓛ : Appears during duplication process.</p> <p>Ⓛ : Appears when this unit is in VCR output mode and a cassette tape is in the unit.</p> <p>Ⓛ : Appears during duplication process.</p> <p>VCR : Appears when this unit is in VCR output mode.</p> <p>Ⓛ : Appears when the timer recording is proceeding in VCR.</p> <p>Ⓛ : Appears when VCR is in the timer recording standby mode.</p> <p>Ⓛ : Flashes when a program cannot be performed for some reasons.</p> | <p>DVD : Appears when this unit is in DVD output mode.</p> <p>Ⓛ : Appears when the timer recording is proceeding in DVD.</p> <p>Ⓛ : Appears when DVD is in the timer recording standby mode.</p> <p>Ⓛ : Flashes when a program cannot be performed for some reasons.</p> <p>DB : Appears during VCR to DVD duplication process.</p> <p>Ⓛ : Appears during DVD to VCR duplication process.</p> |
|--|--|---|

5. Displays the following

- Elapsed playback time
- Current title / chapter / track / file number
- Recording time / remaining time
- Clock
- Selected channel number
- Remaining time for one-touch timer recording
- Selected HDMI output mode
- VCR tape counter

Display Message

	Appears when the disc tray is opening.		Appears when HDMI output mode (480p) is selected.
	Appears when the disc tray is closing.		Appears when HDMI output mode (720p) is selected.
	Appears when a disc is loaded on the disc tray.		Appears when HDMI output mode (1080i) is selected.
	Appears when data is being recorded on a disc.		Appears when HDMI output mode (1080p) is selected.
	Appears when the PBC function is activated. (Video CD playback only. Refer to page 57.)		

CONNECTION

Read this first:

- 1) Disconnect the AC power cords of the devices from the AC outlet.
- 2) Make the connection as illustrated below.
- 3) After making all the connections, connect the AC power cords of the devices.

- Connect this unit directly to the TV. If the RCA audio/video cables are connected to a VCR, pictures may be distorted due to the copy protection system.

Antenna Connection (Required)

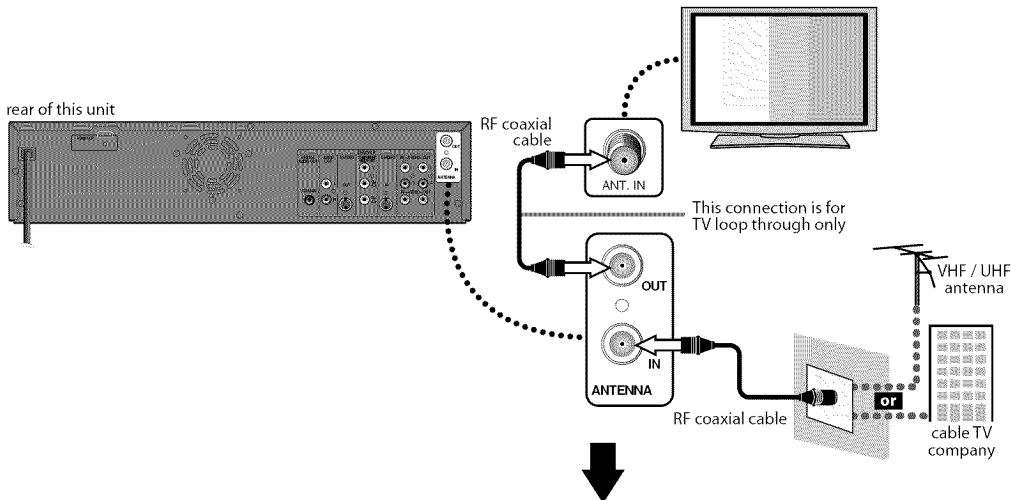

Choose one of the following connections depending on the jacks on your TV.

Note

- For your safety and to avoid damage to the device, please unplug the RF coaxial cable from the ANTENNA IN jack before moving the unit.
- If you use an antenna to receive analog TV, it should also work for DTV reception. Outdoor or attic antennas will be more effective than set-top versions.
- ANTENNA OUT jack is for tuner pass through only. DVD playback through the RF is not possible.

Supplied cables used in this connection are as follows:

- RF coaxial cable x 1
- Please purchase the rest of the necessary cables at your local store.

Overview

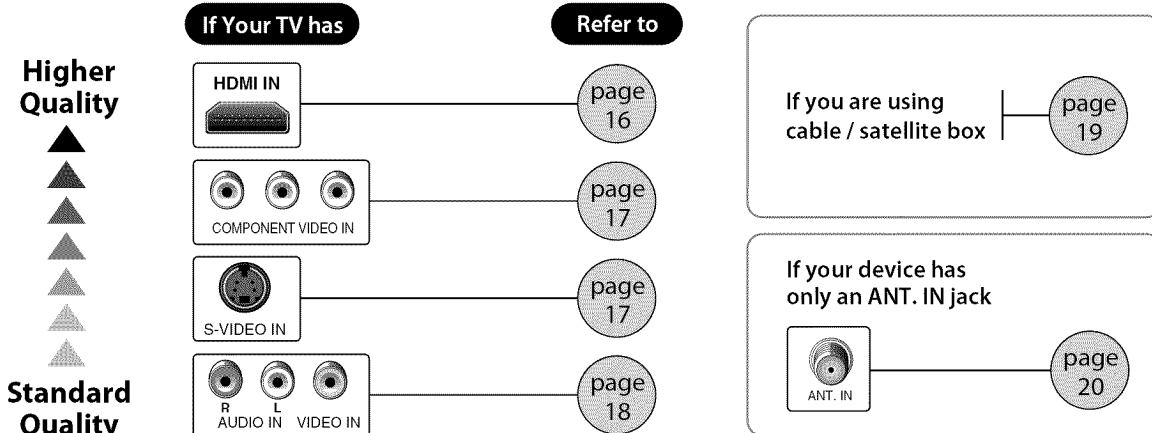

CONNECTION

Connecting to a TV with an HDMI™ Compatible Port

- HDMI outputs the video / audio signals without converting to analog signals.
- No audio connection is required.

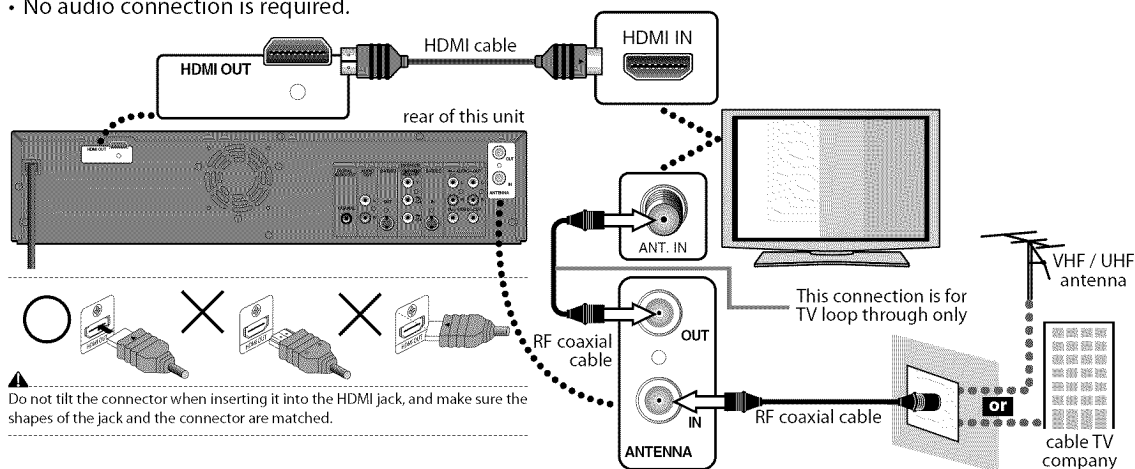

Supplied cables used in this connection are as follows:

- RF coaxial cable x 1
- Please purchase the rest of the necessary cables at your local store.

HDMI Mode and Actual Output Signals

Press **[HDMI]** to select the HDMI output mode. The output mode changes as follows every time **[HDMI]** is pressed.

Front Panel Display	Video Output Signal
480P	480 Progressive
Press [HDMI]	↓
720P	720 Progressive
Press [HDMI]	↓
1080i	1080 interlaced
Press [HDMI]	↓
1080P	1080 Progressive
Press [HDMI]	

Copyright protection system

To play back the digital video images of a DVD via an HDMI connection, it is necessary that both the player and the display device (or an AV amplifier) support a copyright protection system called HDCP (high-bandwidth digital content protection system). HDCP is copy protection technology that comprises data encryption and authentication of the connected AV device. This unit supports HDCP. Please read the operating instructions of your display device (or AV amplifier) for more information.

*HDMI: High Definition Multimedia Interface

- The HDMI mode that is not supported by display device will be skipped.

Note

- Some devices with an HDMI input may not operate properly with this unit.
- When using an HDCP-incompatible display device, the image will not be viewed properly.
- Among the devices that support HDMI, some devices can control other devices via the HDMI connector; this unit cannot be controlled by another device via the HDMI connector.
- The audio signals from the HDMI connector (including the sampling frequency, the number of channels and bit length) may be limited by the device that is connected.
- Among the monitors that support HDMI, some do not support audio output (for example, projectors). In connections with device such as this unit, audio signals are not output from the HDMI output connector.
- When this unit's HDMI connector is connected to a DVI-D compatible monitor (HDCP compatible) with an HDMI-DVI converter cable, the signals are output in digital RGB.
- When the power failure occurs, or when you unplug the unit, some problems in the HDMI setting might occur. Please check and set the HDMI setting again.
- HDMI video resolution cannot be changed when the unit is in VCR mode.

CONNECTION

Connecting to a TV Using Component Video Out Jacks

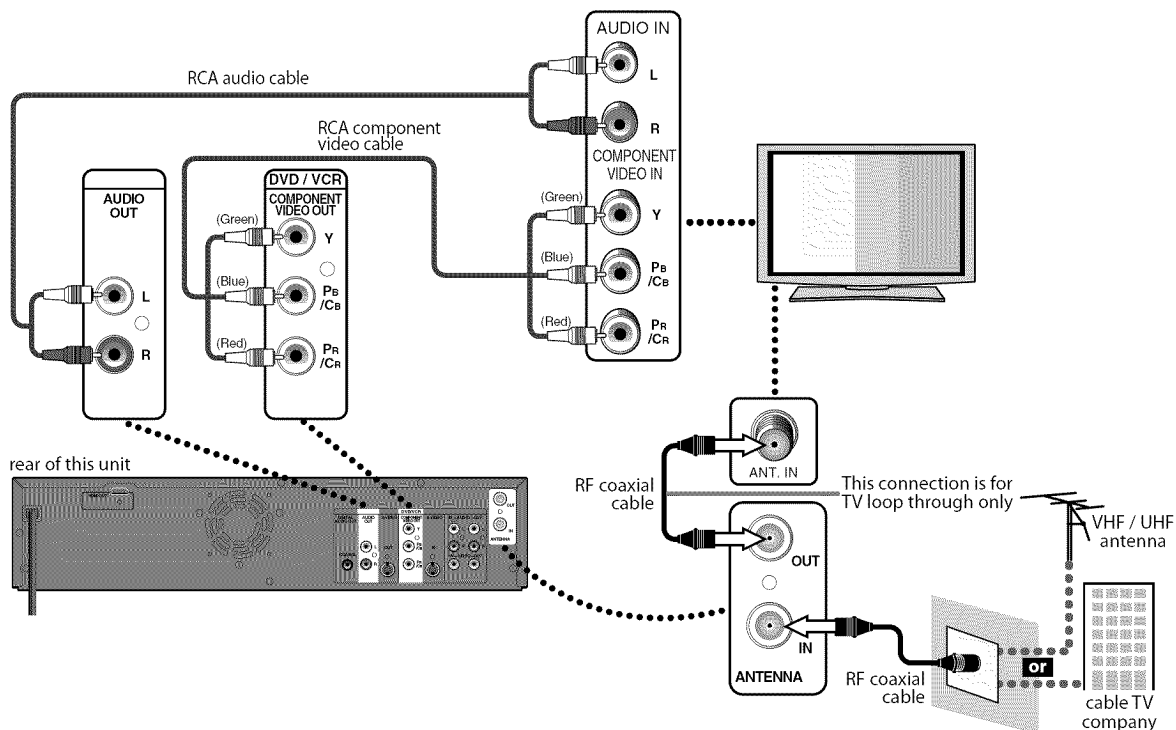

Connecting to a TV Using the S-Video Out Jack

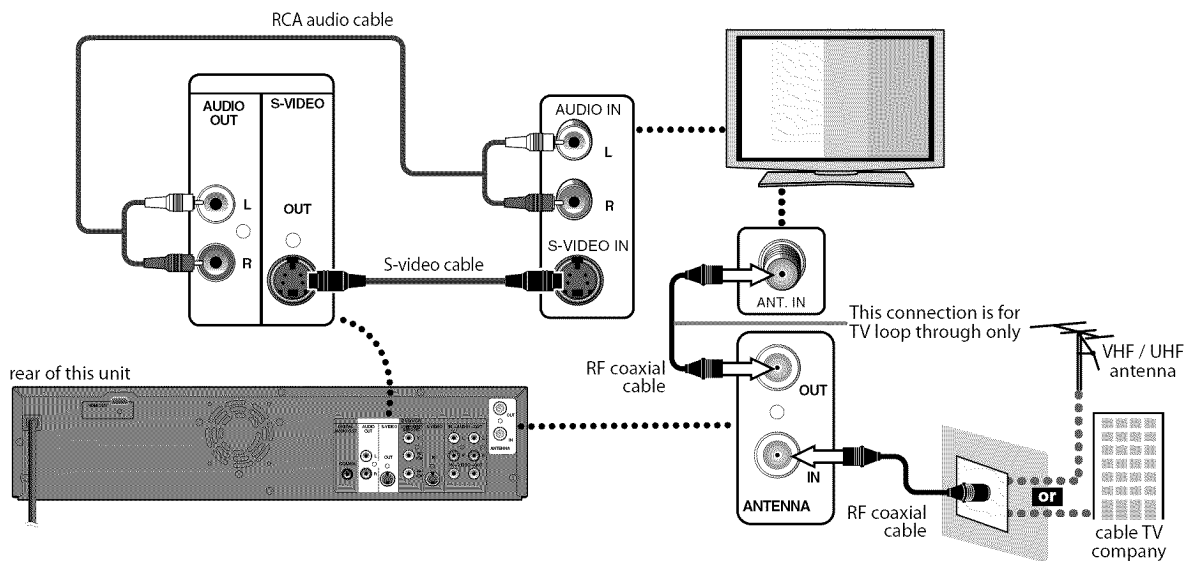

Supplied cables used in this connection are as follows:

- RF coaxial cable x 1
- RCA audio cable (L/R) x 1

Please purchase the rest of the necessary cables at your local store.

CONNECTION

Connecting to a TV Using Audio / Video Jacks

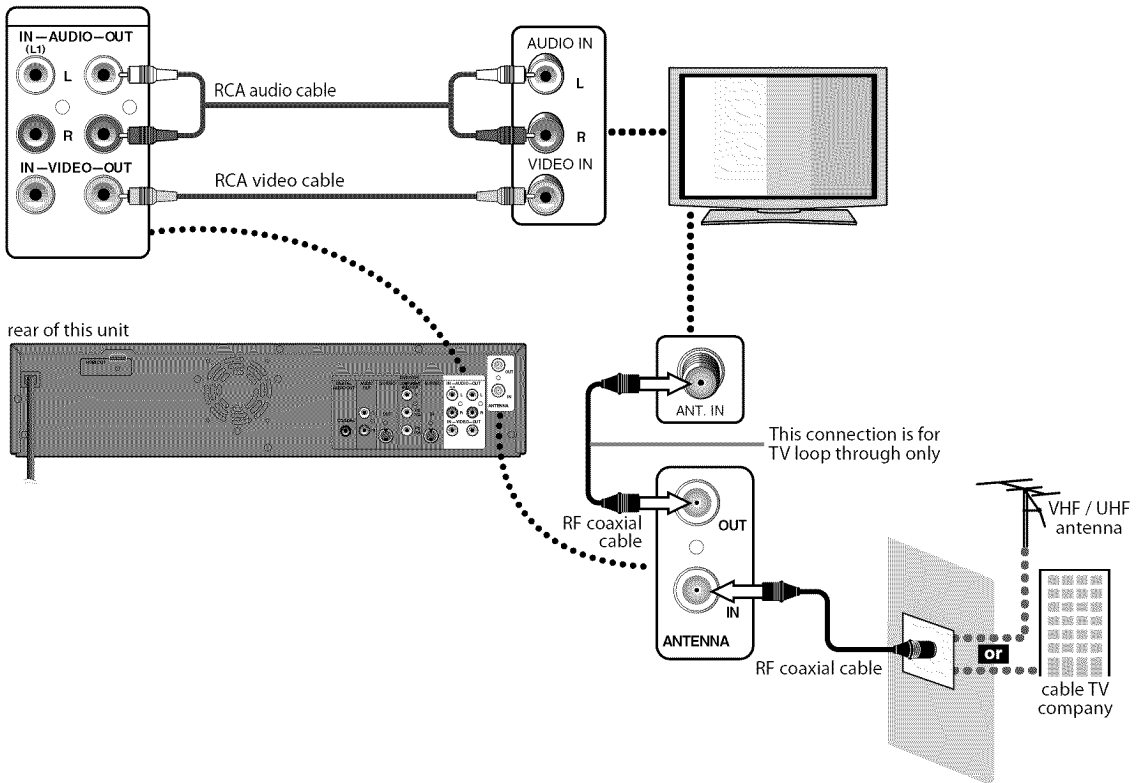

Supplied cables used in this connection are as follows:

- RF coaxial cable x 1
- RCA audio cable (L/R) x 1
- RCA video cable x 1

Please purchase the rest of the necessary cables at your local store.

CONNECTION

Connecting to a Cable / Satellite Box

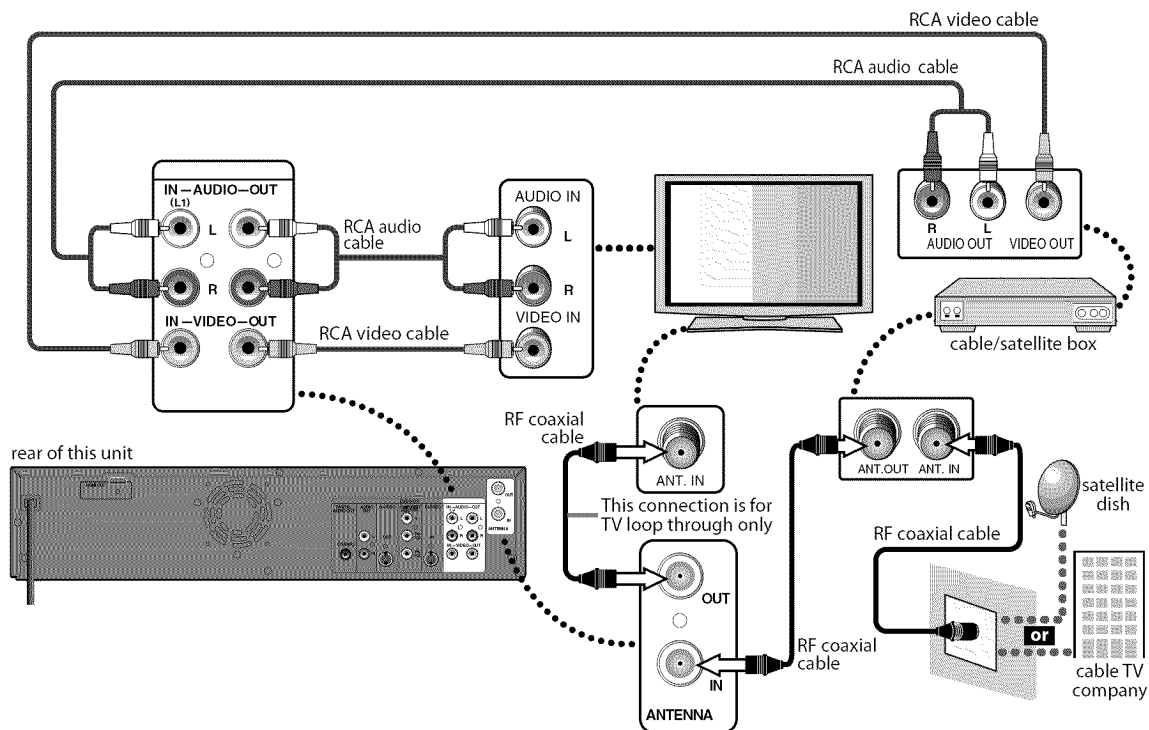

Supplied cables used in this connection are as follows:

- RF coaxial cable x 1
- RCA audio cable (L/R) x 1
- RCA video cable x 1

Please purchase the rest of the necessary cables at your local store.

Note

- Required cables and connecting methods differ depending on the cable/satellite box. For more information, please contact your cable/satellite provider.
- Instead of using VIDEO OUT jack of this unit, you can also use S-VIDEO OUT jack, COMPONENT VIDEO OUT jack or HDMI OUT jack for connecting to your TV.

With this setup:

- You can record any unscrambled channel by selecting the channel on the cable/satellite box. Be sure that the cable/satellite box is turned on.
- **You cannot record one channel while watching another channel.**

CONNECTION

Connecting to a TV without Audio / Video Jacks

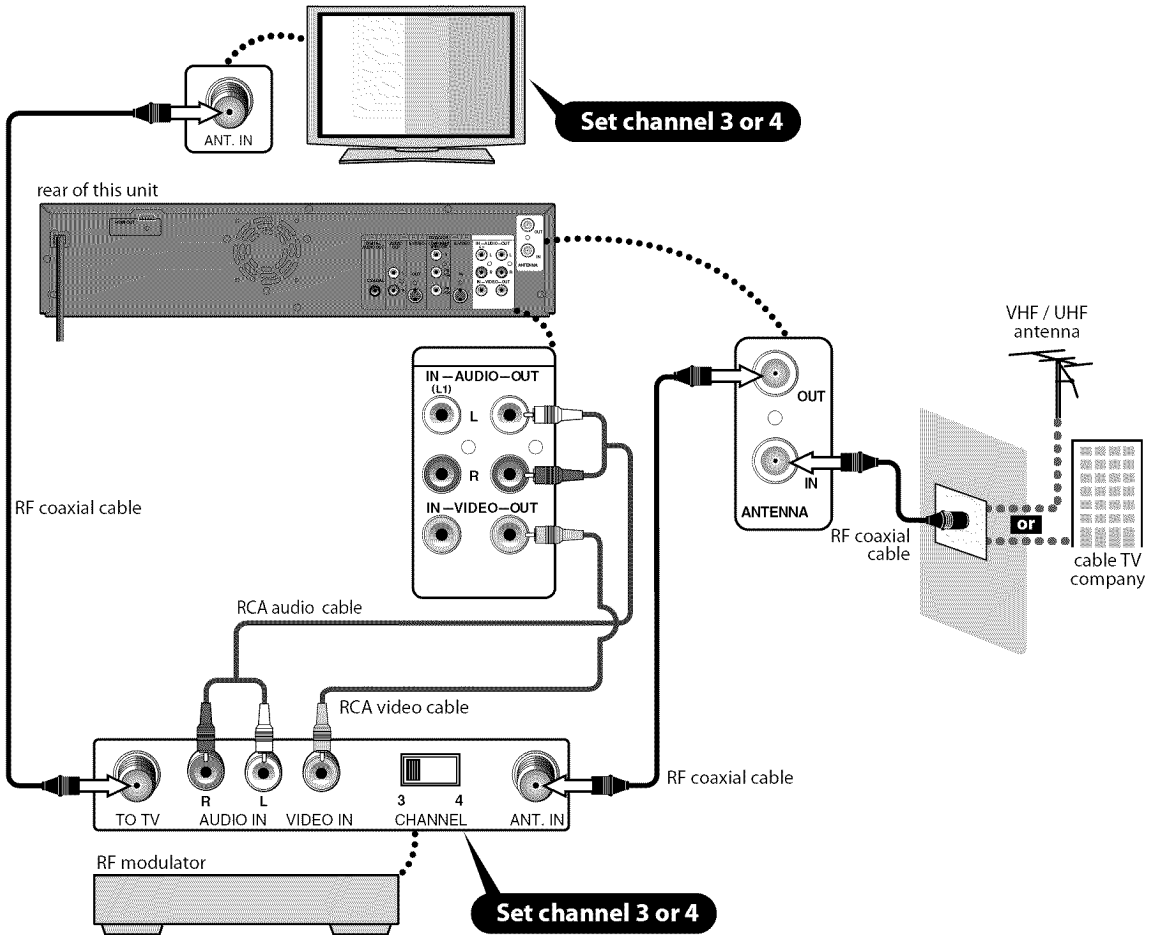

Supplied cables used in this connection are as follows:

- RF coaxial cable x 1
- RCA audio cable (L/R) x 1
- RCA video cable x 1

Please purchase the rest of the necessary cables at your local store.

Note

- **RF modulator is not supplied with this unit. You need to purchase it at your local store.**
- The quality of picture may become poor if this unit is connected to an RF modulator.

CONNECTION

Digital Audio Connection

Coaxial Cable Connection

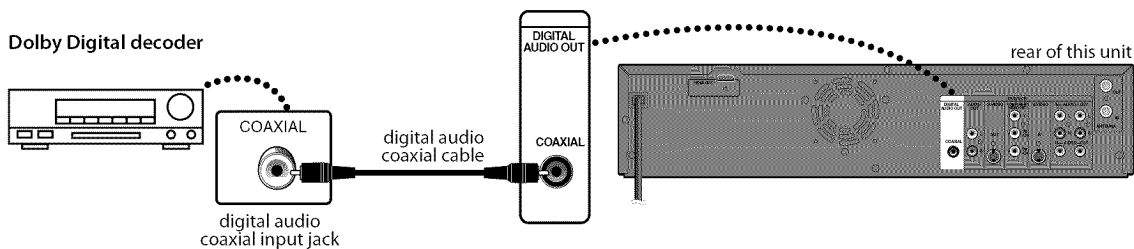

HDMI Audio Connection

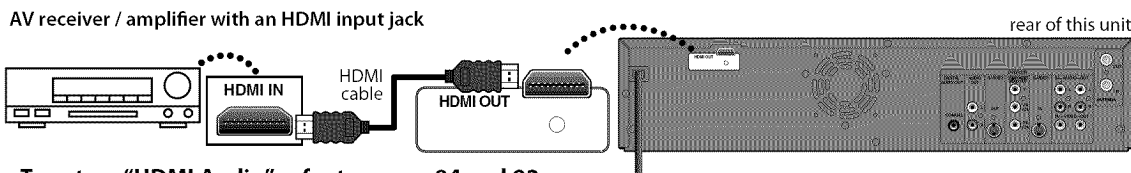

To set up "HDMI Audio" refer to pages 84 and 92.

To set up "Dolby Digital" refer to pages 82 and 87.

Audio format (disc)	Dolby Digital Setting of this unit	HDMI	Digital Output
Dolby Digital	PCM	2channel PCM	2channel PCM
	Stream	Dolby Digital	Dolby Digital
LPCM	PCM	2channel PCM	—
	Stream		

Actual Output

Cables not included.

Please purchase the necessary cables at your local store.

Note

- The audio source on a disc in a Dolby Digital multi channel surround format cannot be recorded as digital sound by an MD or DAT deck.
- By connecting this unit to a Dolby Digital decoder, you can enjoy high-quality Dolby Digital multi channel surround sound as movie theaters.
- Playing back a DVD using incorrect settings may generate noise distortion and may also damage the speakers.

2 Channel Analog Audio Connection

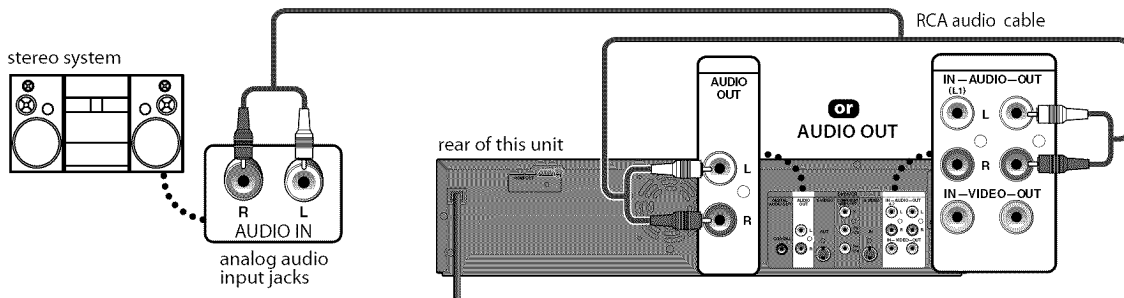

Supplied cables used in this connection are as follows:

- RCA audio cable (L/R) x 1

BEFORE YOU START

After you have completed all the connections, you must find the viewing channel (external input channel) on your TV.

Finding the Viewing Channel on Your TV

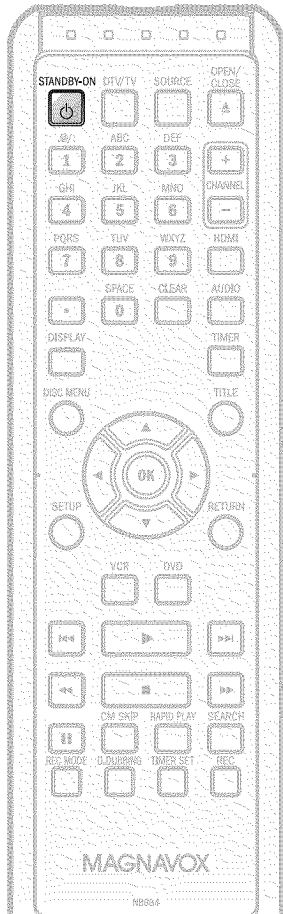

1 After you have made all the necessary connections, press [STANDBY-ON 

2 Turn on your TV.
 • If connected to your VCR make sure it is switched off or in standby mode before proceeding.

3 Press “2” on the TV’s remote control, then press channel down button repeatedly until you see “Initial Setup” menu.

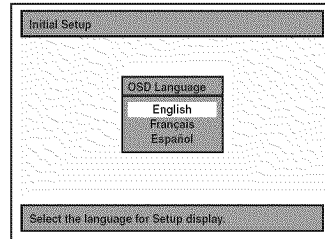

This is the correct viewing channel (external input channel) for the recorder.

- For some TVs, there may be a button on the TV’s remote control that accesses the external input channel. It may be labeled “SOURCE”, “AV”, or “SELECT”. In such case, press it repeatedly. Refer to your TV’s user manual for details.
- If more than 10 minutes have passed since you have turned on the unit, you may see the MAGNAVOX screen saver instead of “Initial Setup” menu.

MAGNAVOX screen saver:

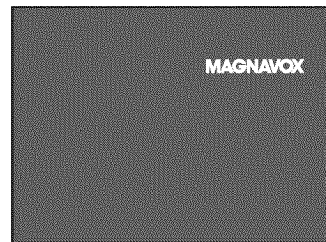

4 Proceed to step 2 in “INITIAL SETTING” on page 27.

Input Mode Names for Common TV Brands (Example)

Admiral	AUX	Panasonic	TV/VIDEO
Curtis Mathis	LINE1, LINE2, 00, 90, 91, 92, 93	RCA	INPUT, TV/VCR, 00, 90, 91, 92, 93
GE	INPUT, TV/VCR, 00, 90, 91, 92, 93	Samsung	TV/VIDEO
Hitachi	INPUT, AUX	Sanyo	VIDEO
JVC	VIDEO, VIDEO 1, VIDEO 2, VIDEO 3	Sharp	00
Kenwood	AUX	Sony	VIDEO1, VIDEO2, VIDEO3
LXI-Series	00	Toshiba	TV/GAME
Magnavox	AUX CHANNEL	Zenith	00

Note

- Video input selection varies for different brand’s models of TVs.
- Consult your TV manufacturer if none of the above is successful.

BEFORE YOU START

This unit uses the following on-screen displays and menus to guide you to the easy operations. The on-screen displays give you the information on the loaded disc or the disc/file in playback, or the HDMI status, etc. The menus allow you to change the various kinds of settings for playing back, recording, or editing to suit your preference.

Guide to On-Screen Display / Menu

The on-screen display changes in the following order as you press [DISPLAY].

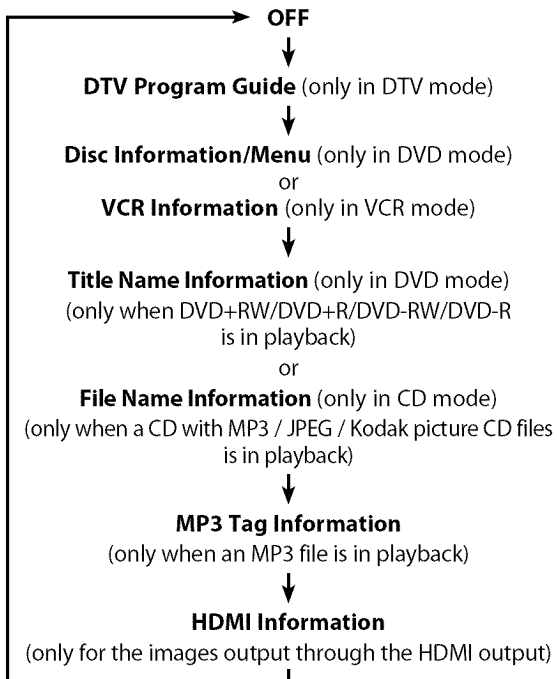

DTV Program Guide

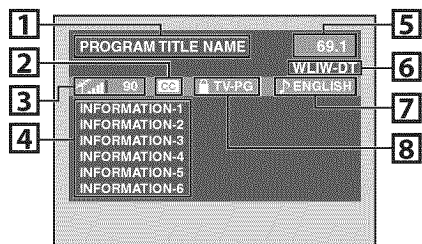

1. Program title (max. 2 lines displayed)
2. Closed Caption (Indicates that the program being broadcast is available with closed captioning.)
3. Signal strength (Indicates the signal strength of the current channel.)
4. Program guide (max. 6 lines displayed)
5. Channel number
6. Broadcast station
7. Audio language ("Other" is displayed when the audio language cannot be acquired, or the acquired languages are other than English, Spanish or French.)
8. Program rating

Note

- When the program guide is displayed in more than 7 lines, use [▲ / ▼] to scroll.
- "No description provided." is displayed when the program guide is not provided.

Disc Information / Menu

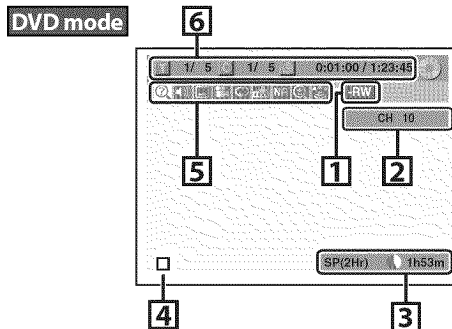

* This is an example screen only for explanation. Displayed items vary depending on the disc you inserted.

1. Indicates a disc type.
2. Indicates a channel number or selected external input channel.
3. Indicates a recording mode and possible recording time left.
4. Indicates an operation status.
5. Each icon means:

- : Search
- : Audio
- : Subtitle
- : Angle
- : Repeat
- : Marker
- : Noise Reduction
- : Zoom
- : Surround

6. Indicates the current title number/total number of titles, the current chapter number/total number of chapters, and time lapse of the current title playback/total duration of the title.

BEFORE YOU START

VCR Information

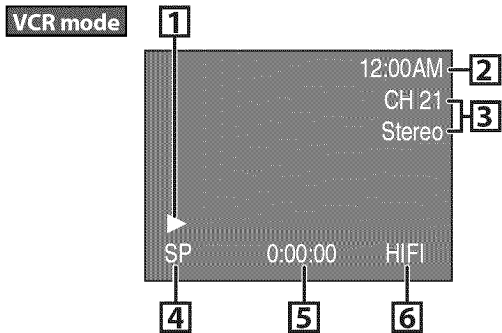

* This is an example screen only for explanation. Displayed items vary depending on the cassette tape you inserted.

* During stop mode or pause, VCR information is not available with HDMI connection.

1. Indicates current video status.
2. Indicates the current time.
3. Indicates a current channel number (or selected external input channel) and an audio status of the program.
4. Indicates a recording or playing back mode.
5. Indicates a tape counter.
6. Audio status of the current cassette tape.

Title/File Name Information

Title Name Information

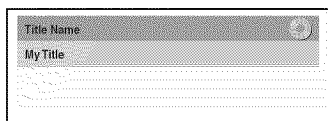

File Name Information

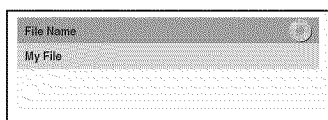

MP3 Tag Information

• First, track name will be displayed.

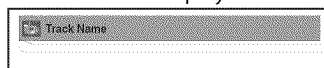

• If you press **[DISPLAY]** one more time, artist name will be displayed.

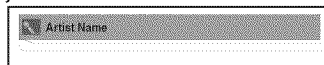

• If you press **[DISPLAY]** one more time, album name will be displayed.

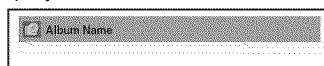

• If there is no artist, track or album name, "Not Available" will be displayed.

HDMI Information

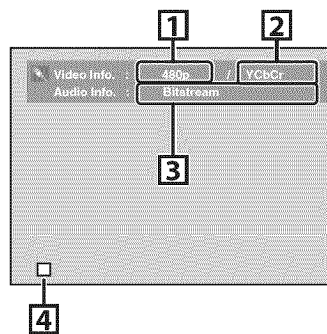

*1. Indicates the resolution of the HDMI output image.

*2. Indicates the HDMI video format.

*3. Indicates the HDMI audio format.

4. Indicates current disc status.

* "-" will be displayed, when it does not have any information.

BEFORE YOU START

Main Menu

Press **[SETUP]** to display the main menu. Then use **[▲ / ▼]** to select a menu and press **[OK]** to display the menu. These menus provide entries to all main functions of the unit.

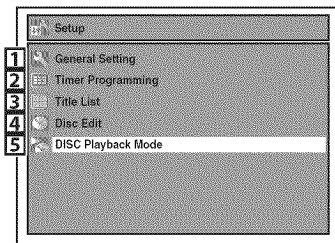

1. General Setting:

To go to general setting menu.

2. Timer Programming:

To program a timer recording.

3. Title List:

To call up the title list.

4. Disc Edit:

To set up the DVD setting.

5. DISC Playback Mode:

To set up the disc playback setting.

- "DISC Playback Mode" is available only when an audio CD, a video CD, a CD-RW/-R with MP3 / JPEG / Kodak picture CD files is inserted into the unit.

General Setting Menu

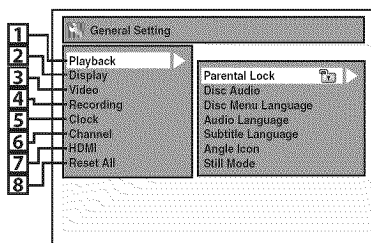

1. Playback:

To set up the unit to play back discs as you prefer.

2. Display:

To set up the OSD screen as you prefer.

3. Video:

To set up the video setting.

4. Recording:

To set up the unit to record to discs as you prefer.

5. Clock:

To set up the clock of the unit as you need.

6. Channel:

To adjust the channel setting of the unit as you prefer.

7. HDMI:

To set up the HDMI connection setting.

8. Reset All:

To reset the setting to the factory default.

Disc Edit / DISC Playback Mode

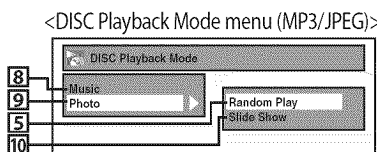
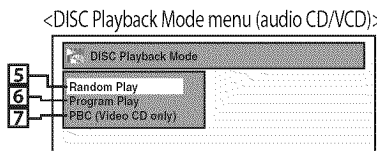
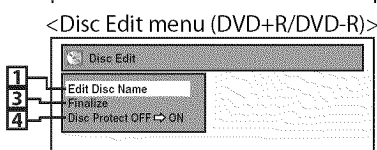
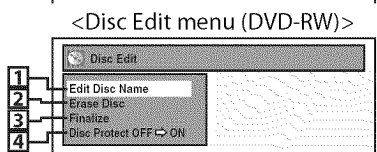
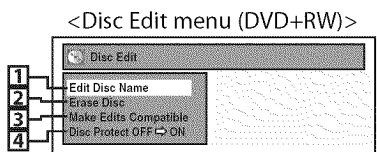

1. Edit Disc Name:

Allows you to rename the disc.

2. Erase Disc: (DVD+RW/DVD-RW only)

Allows you to erase all contents in the disc and format it.

3. Make Edits Compatible: (DVD+RW only)

Allows you to memorize the editing status on the disc if you have added or deleted chapters, or made chapters hidden on this unit, and to effect it when playing back on the other unit.

Finalize: (DVD+R/DVD-RW/-R only)

Allows you to finalize a disc containing recorded titles.

4. Disc Protect :

Allows you to protect a disc from accidental editing or recording.

5. Random Play:

Allows you to activate the random playback feature.

6. Program Play: (audio CD/video CD only)

Allows you to activate the program playback feature.

7. PBC (Video CD only):

Allows you to select images or information on the menu screen by activating PBC (playback control) function.

8. Music :

Allows you to make setting for MP3 playback.

9. Photo :

Allows you to make setting for JPEG playback.

10. Slide Show: (JPEG / Kodak Picture CD files only)

Allows you to select the display time of the slide show mode.

BEFORE YOU START

Switching DVD / VCR Mode

Because this product is a combination of a VCR and a DVD recorder, you must select first which component you wish to operate.

DVD mode

Press **[SOURCE]** on the front panel, or press **[DVD]** on the remote control.

(Verify that the DVD indicator is lit.)

VCR mode

Press **[SOURCE]** on the front panel, or press **[VCR]** on the remote control.

(Verify that the VCR indicator is lit.)

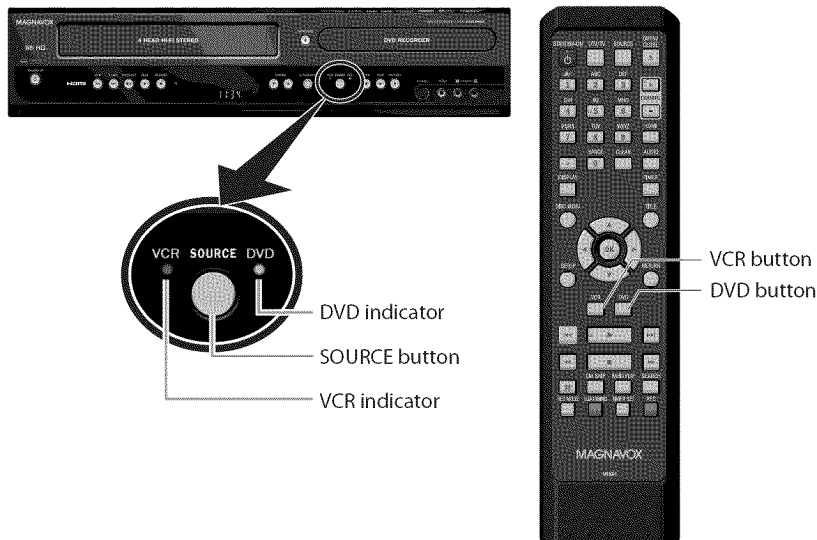

Note

- You cannot switch the mode while in the timer-standby mode.
- Playback will stop when you change the output mode.

How to Insert a Disc / Cassette Tape

How to Insert a Disc

- 1) Press **[DVD]**.
- 2) Press **[OPEN/CLOSE ▲]** to open the disc tray.
- 3) Place the disc on the disc tray with its label side facing up.

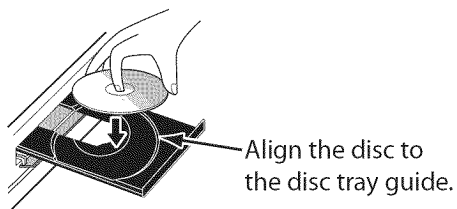

- 4) Press **[OPEN/CLOSE ▲]** to close the disc tray.

It may take a while to load the disc.

To eject the disc:

Press **[OPEN/CLOSE ▲]** to open the disc tray, then remove the disc before turning the unit to the standby mode.

How to Insert a Cassette Tape

- 1) Press **[VCR]**.
- 2) Insert a cassette tape as illustrated below.

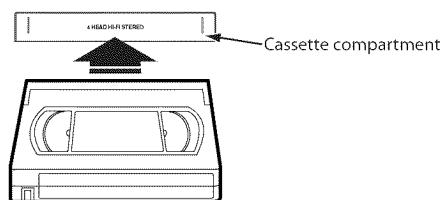

- Insert from the flap side first with the window side facing up.

To eject the cassette tape:

Press **[STOP/EJECT ▲]** on the front panel or press **[OPEN/CLOSE ▲]** on the remote control.

Note

- If you turn this unit to the standby mode, **[OPEN/CLOSE ▲]** on the remote control is not available. Be sure to use **[▲ OPEN/CLOSE]** or **[■ ▲ STOP/EJECT]** on the unit.

INITIAL SETTING

You need to follow these steps when you turn on this unit for the first time.

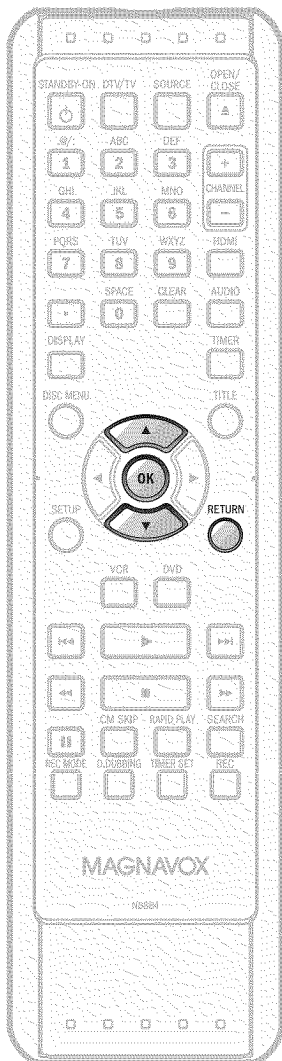

1 Follow the procedure in “Finding the Viewing Channel on Your TV” on page 22 to display “Initial Setup” menu.

2 Use [▲ / ▼] to select your desired language, then press [OK].

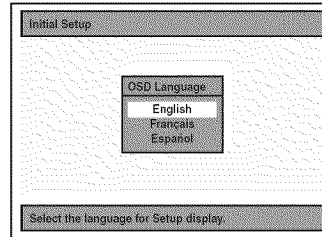

3 Use [▲ / ▼] to select the type of broadcasting signal, then press [OK].

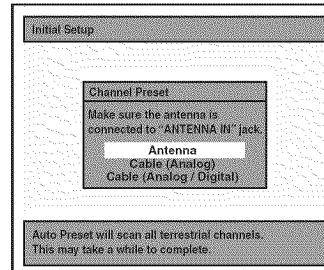

The unit will start getting channels available in your area.

Antenna:

(When using antenna)

The channels broadcasted in analog TV and digital TV are automatically scanned and memorized. Only the receivable channels in the area will be memorized.

Cable (Analog):

(When using basic cable)

The channels broadcasted in analog CATV are automatically scanned and memorized.

Cable (Analog / Digital):

(When using basic cable)

The channels broadcasted in analog CATV and digital CATV are automatically scanned and memorized.

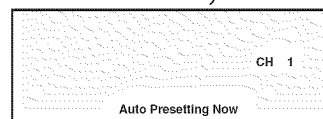

4 If a PBS (public broadcasting station) is available in your area, clock setting will automatically be performed and the correct clock will be displayed following the channel preset procedure. Initial setting is then complete. Press [RETURN] to exit.

If a PBS (public broadcasting station) is not available in your area, press [OK]. Then proceed to step 5 in “Manual Clock Setting” on page 32.

CHANNEL SETTING

If you have changed antenna connection, we recommend that you program available channels in your area with the following procedures.

Auto Channel Scan

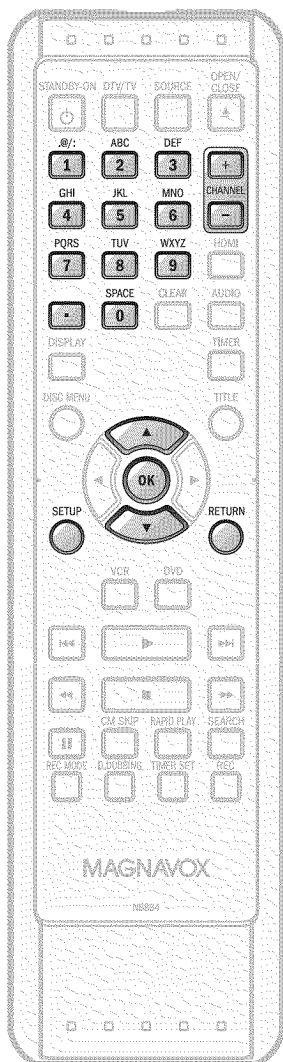

1 Press [SETUP] and use [▲ / ▼] to select “General Setting”, then press [OK].

“General Setting” menu will appear.

2 Use [▲ / ▼] to select “Channel”, then press [OK].

“Channel” menu will appear.

3 Use [▲ / ▼] to select “Auto Channel Preset”, then press [OK].

4 Use [▲ / ▼] to select the type of broadcasting signal, then press [OK].

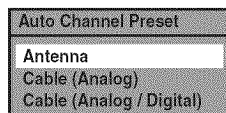

The unit will start getting channels available in your area.

- When aerial antenna is connected, select “Antenna”.
- When connected to CATV, select “Cable (Analog)” or “Cable (Analog / Digital)”.

To cancel the auto channel preset during scanning:

Press [RETURN] to go the previous screen or [SETUP] to cancel.

5 When scanning is over, press [SETUP] to exit.

To cycle through only the memorized channels, use [CHANNEL + / -].

To select a channel directly (including the ones not memorized), use [the Number buttons] and [•] (for digital TV channels).

Note

- If the auto channel preset is canceled during presetting, some channels not yet preset may not be received.
- You cannot change the channel when either VCR or DVD is in any recording mode (basic recording, one-touch timer recording or timer recording).

CHANNEL SETTING

Adding / Deleting Channels

You may want to add or delete TV channels if your channel lineup changes or if you no longer watch some channels.

Adding channel is only available for the analog TV channels.

Make sure

- You perform "Auto Channel Scan" before adding or deleting the channels.

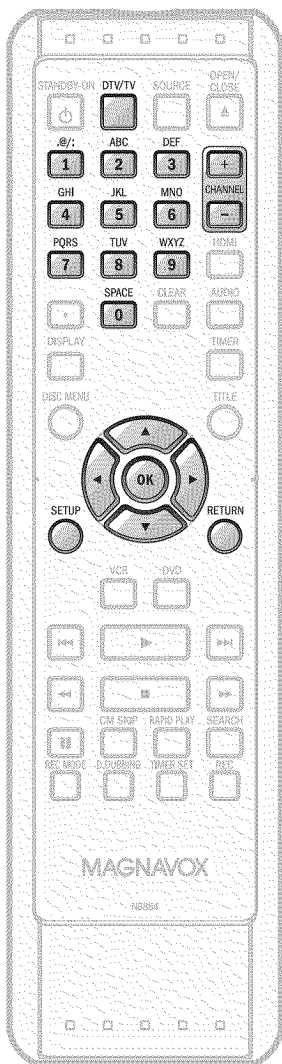

1 Press [DTV/TV] to select the mode (DTV or TV) to/from which you want to add/delete channels.

2 Press [SETUP] and use [▲ / ▼] to select "General Setting", then press [OK].

"General Setting" menu will appear.

3 Use [▲ / ▼] to select "Channel", then press [OK].

"Channel" menu will appear.

4 Use [▲ / ▼] to select "Manual Channel Preset", then press [OK].

Auto Channel Preset
Manual Channel Preset
TV Audio Select

- If you are adding or deleting analog TV/CATV channels, go to **ANALOG** to continue.
- If you are deleting digital TV/CATV channels, go to **DIGITAL** to continue.

CHANNEL SETTING

ANALOG

5 Select the channel number to add or delete.

- Use [CHANNEL + / -] to cycle through only the memorized channels.
- Use [◀ / ▶] to cycle through all the channels including the ones not memorized.
- Use [the Number buttons] to select a channel directly.
- When a memorized channel is selected, "Add" is checked and highlighted as a default.
- When an unmemorized channel is selected "Delete" is checked and highlighted as a default.

6 Use [▲ / ▼] to select "Add" or "Delete", then press [OK].

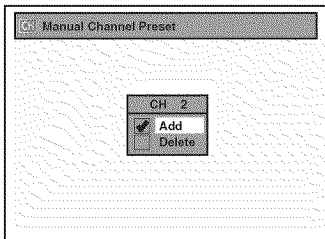

Your setting will be activated and it will automatically switch to the next channel so that you can continue adding or deleting channels.

7 Press [SETUP] to exit.

DIGITAL

5 Select the channel number to delete.

- Only the major channel is displayed in "Manual Channel Preset" menu. (The channel number displayed in the parenthesis is a virtual channel number)
- Use [CHANNEL + / -] to cycle through only the memorized channels.
- You cannot use [◀ / ▶] for the digital TV channel selection.
- Use [the Number buttons] to select a channel directly.
- When a memorized channel is selected, "Add" is checked and highlighted as a default.
- When an unmemorized channel is selected "Delete" is checked and highlighted as a default.

6 Use [▲ / ▼] to select "Delete", then press [OK]. Then select the next channel to delete.

- If the setting is complete, press [RETURN] to activate "Manual Channel Preset".

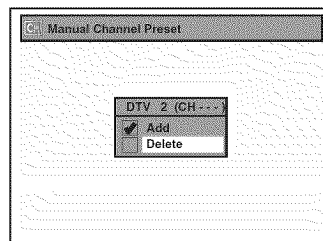

Your setting will be activated.

WARNING:

- For the digital TV channels, you cannot recover the deleted channels once they are deleted unless you perform the auto channel preset again.

7 Press [SETUP] to exit.

SETTING THE CLOCK

Set the clock before you try the timer programming. If a PBS (public broadcasting station) is available in your area, follow "Auto Clock Setting" below. If not, follow "Manual Clock Setting" on page 32.

Auto Clock Setting

This unit can set the time and date automatically by referring to a PBS station.

Make sure

- The antenna/cable TV connections are correct.
- Channels are set. (Refer to page 28.)
- If this unit is connected to a cable/satellite box, select the local PBS station on them to set the clock automatically.

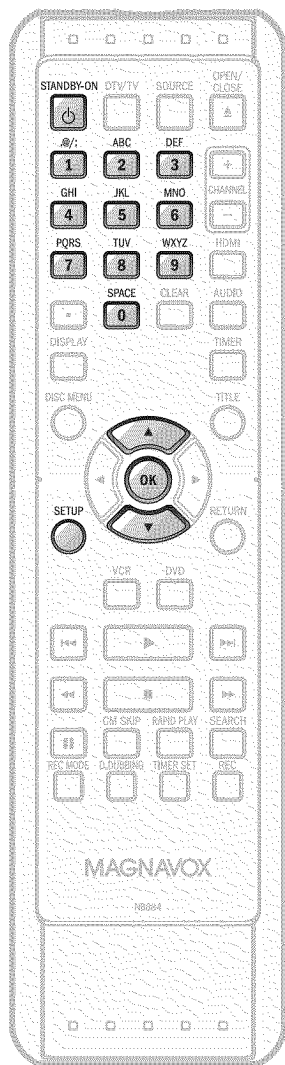

1 Press [SETUP] and use [▲ / ▼] to select "General Setting", then press [OK].

"General Setting" menu will appear.

2 Use [▲ / ▼] to select "Clock", then press [OK].

"Clock" menu will appear.

3 Use [▲ / ▼] to select "Auto Clock Setting", then press [OK].

4 Use [▲ / ▼] to select "Auto", then press [OK].

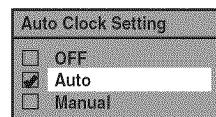

5 Press [SETUP] to exit.

6 Press [STANDBY-ON ○] to turn the unit to the standby mode.

This unit will search for the time only when the power is in the standby mode. Leave it in standby for several minutes to give this unit time to set the clock.

If the unit chooses an incorrect PBS channel, set the PBS channel manually by following the steps below.

1 Select "Manual" at step 4, then press [OK].

2 Use [the Number buttons] or [▲ / ▼] to enter your PBS channel number, then press [OK].

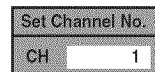

3 Press [SETUP] and turn the unit to the standby mode.

Note

- The clock may set itself automatically after you connect the antenna/cable signal and plug in the power cord.
- Only the analog PBS channel signal is effective for auto clock setting.
- The unit receives the clock data at 12:00 a.m. / p.m. from the PBS channel when the unit is in the standby mode.

SETTING THE CLOCK

Manual Clock Setting

1 Press [SETUP] and use [▲ / ▼] to select "General Setting", then press [OK].

"General Setting" menu will appear.

2 Use [▲ / ▼] to select "Clock", then press [OK].

"Clock" menu will appear.

3 Use [▲ / ▼] to select "Clock Setting", then press [OK].

4 Use [▲ / ▼] to select calendar or time, then press [OK].

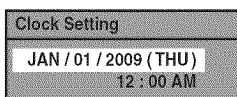

5 Use [◀ / ▶] to select an item to set, and use [▲ / ▼] to select the contents to suit your preference, then press [OK] when you finish setting all the contents.

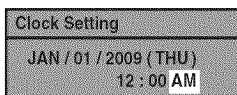

Your setting will be activated.

The clock start counting when you press [OK].

6 Press [SETUP] to exit.

Daylight Saving Time

When "Daylight Saving Time" is "ON", the unit clock will automatically adjust the time in order to fit the daylight saving time.

"ON (MAR - NOV)" has been selected as the default.

1 Press [SETUP] and use [▲ / ▼] to select "General Setting", then press [OK].

"General Setting" menu will appear.

2 Use [▲ / ▼] to select "Clock", then press [OK].

"Clock" menu will appear.

3 Use [▲ / ▼] to select "Daylight Saving Time", then press [OK].

4 Use [▲ / ▼] to select "ON (MAR - NOV)", "ON (APR - OCT)" or "OFF", then press [OK].

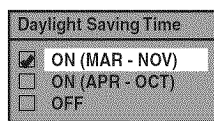

ON (MAR - NOV):

Move forward one hour on the second Sunday in March and move back one hour on the first Sunday in November.

ON (APR - OCT):

Move forward one hour on the first Sunday in April and move back one hour on the last Sunday in October.

5 Press [SETUP] to exit.

Note

- Your setting will be canceled if you press [SETUP] before pressing [OK] at step 5.
- Your clock setting will be lost if either there is a power failure or this unit has been unplugged for more than 30 seconds when you set the clock manually.
- For setting the day, year, hour, and minute, [the Number buttons] can also be used.
- You can set the built-in calendar from the year 2008 up to 2058.

TUNER SETTINGS

Switching Analog Mode / Digital Mode

You can easily switch the analog TV (NTSC) and digital TV (ATSC) with the remote control.

Press **[DTV/TV]** on the remote control.

- The analog mode and digital mode switch alternately.

Channel Selection

Select channels by using **[CHANNEL + / -]** or **[the Number buttons]** found on remote control.

[CHANNEL + / -]

Use **[CHANNEL + / -]** to change the channel.

[the Number buttons]

Press the channel number with **[the Number buttons]** to select a channel you want to watch.

<Analog TV Channels>

Enter the channel number with **[the Number buttons]** to select a channel you want to watch.

For 1-digit number

e.g.) 2 ch: **[0] + [2], [2] + [•]** or
 [2] + leave it for 2 seconds.

For 2-digit number

e.g.) 12ch: **[1] + [2]**

<Digital TV Channels>

Enter the major and minor channel number with **[the Number buttons]** to select a channel you want to watch.

For 1-digit number

e.g.) 2.2 ch:
major channel **[0] + [2] or [2] + [•]**
minor channel **[0] + [2], [2] + [•] or**
 [2] + leave it for 2 seconds.

For 2-digit number

e.g.) 35.16ch:
major channel **[3] + [5]**
minor channel **[1] + [6]**

- If you enter 1 digit for major channel and leave it for 2 seconds, the number will be taken as the major channel and lowest minor channel of the major channel will be displayed.
- If there is no minor channel input, lowest minor channel of the major channel will be displayed.

Note

- It may take up to 5 to 7 seconds to switch the digital TV channels.
- In digital TV broadcasting, 2 or more channels, called minor channels, are simultaneously broadcast on one main channel, called major channel.

About digital TV broadcasting:

With its high definition broadcast, digital broadcasting far surpasses analog broadcasting in both its picture and sound quality.

What is the minor channel?

By using high compression technology, digital broadcasting offers a service that enables multiple signals to send simultaneously.

Therefore, you can select more than one program per major channel since digital broadcasting technology distinguishes between multiple channels broadcast by a single network.

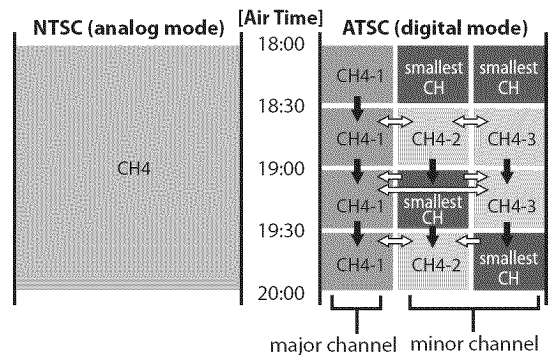

➔ : change automatically

⇨ : change manually by using **[CHANNEL +/-]**

TUNER SETTINGS

This section describes how to switch the TV audio. When you record a TV program, only the audio selected here will be recorded.

Selecting TV Audio

Digital TV

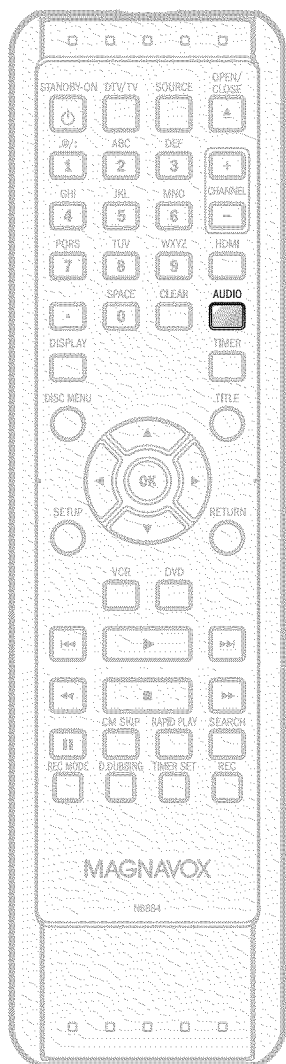

1 Press [AUDIO] to cycle through available audio languages.

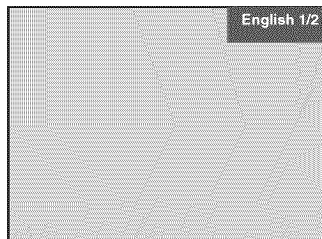

- When you press **[AUDIO]**, selected language will be displayed on the TV screen.
- Every time you press **[AUDIO]**, the language will be switched.
e.g.) English 1/3 → Spanish 2/3 → Other 3/3
- Available languages differ depending on the broadcast.
- The language information display will automatically disappear.
- When you record digital TV broadcasting, the audio language you have selected will be recorded.

Note

- You cannot change the audio language for the recording of digital TV broadcasting.
- Pressing **[AUDIO]** does not control external device audio.
- When there is only one audio channel on the broadcast, pressing **[AUDIO]** does not display anything.

TUNER SETTINGS

Selecting TV Audio (cont'd)

Analog TV

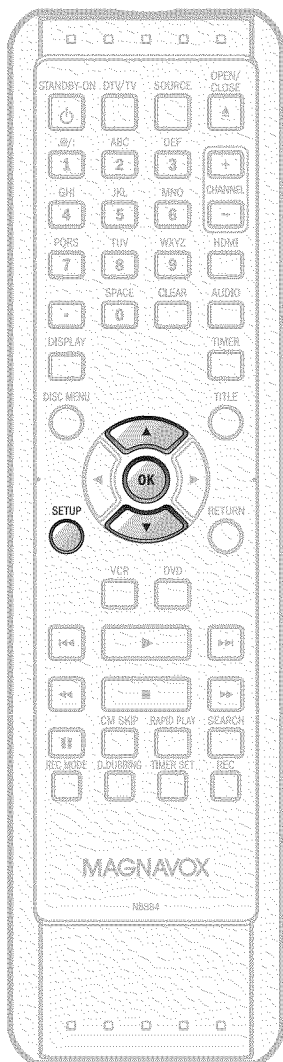

1 Press [SETUP] and use [▲ / ▼] to select "General Setting", then press [OK].

"General Setting" menu will appear.

2 Use [▲ / ▼] to select "Channel", then press [OK].

"Channel" menu will appear.

3 Use [▲ / ▼] to select "TV Audio Select", then press [OK].

4 Use [▲ / ▼] to select "Stereo" or "SAP", then press [OK].

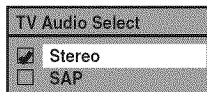

Stereo:

Outputs main-audio.

SAP (secondary audio program):

Outputs sub-audio.

5 Press [SETUP] to exit.

Note on recording analog TV audio

• When you record an analog TV program available in second audio or stereo, you have to select either "Stereo" or "SAP" in "General Setting" menu beforehand. Refer to the following table to check an appropriate setting.

Selected audio	Broadcast audio	Disc recording	Audio output
Stereo	STEREO+SAP	STEREO	STEREO
	STEREO	STEREO	STEREO
	MONO+SAP	MONO	MONO
	MONO	MONO	MONO
SAP	STEREO+SAP	SAP	SAP
	STEREO	STEREO	STEREO
	MONO+SAP	SAP	SAP
	MONO	MONO	MONO

TUNER SETTINGS

DTV Closed Caption

Digital TV

Digital TV has its own closed captions called DTV CC. Use this menu to change the settings for DTV CC.

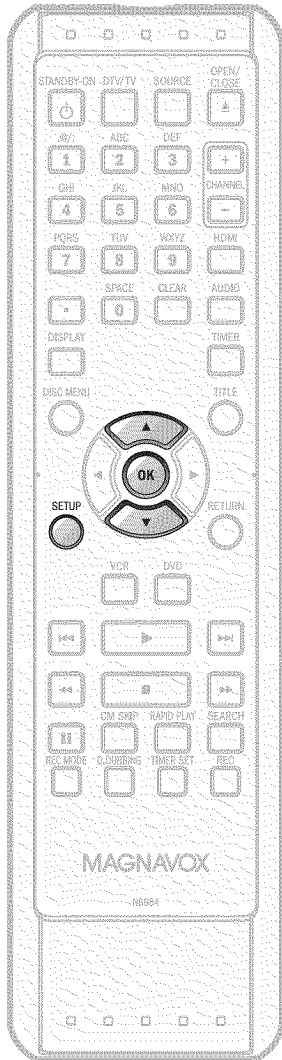

1 Press [SETUP] and use [▲ / ▼] to select "General Setting", then press [OK].
"General Setting" menu will appear.

2 Use [▲ / ▼] to select "Display", then press [OK].

3 Use [▲ / ▼] to select "DTV CC", then press [OK].

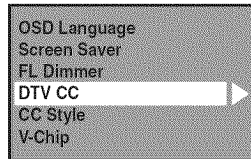

4 Use [▲ / ▼] to select "Caption Service", then press [OK].

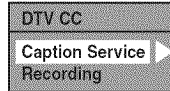

5 Use [▲ / ▼] to the desired DTV closed caption, then press [OK].



OFF:

Select if you do not want DTV CC. This is the default.

Service 1 to Service 6:

Select one of these before changing any other item in the closed caption menu. Choose "Service 1" under normal circumstances.

6 Press [SETUP] to exit.

TUNER SETTINGS

Closed Caption Style

Digital TV

Digital TV can also change the style of its closed caption such as font, color or size, etc.

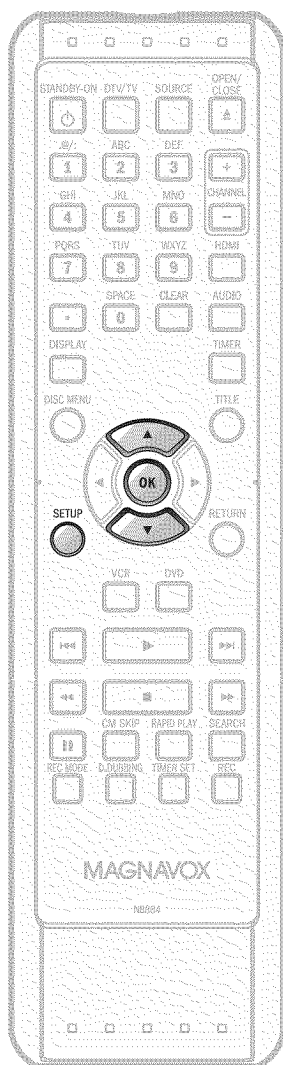

1 Press [SETUP] and use [▲ / ▼] to select “General Setting”, then press [OK].

“General Setting” menu will appear.

2 Use [▲ / ▼] to select “Display”, then press [OK].

3 Use [▲ / ▼] to select “CC Style”, then press [OK].

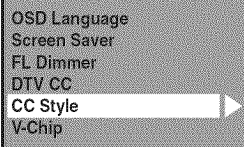

4 Use [▲ / ▼] to select “User Setting”, then press [OK].

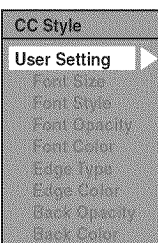

5 Use [▲ / ▼] to select “ON”, then press [OK].

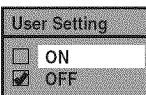

6 Use [▲ / ▼] to select the item and switch the setting for each item you want to set, then press [OK].

- When "User Setting" is set to "ON", you can set the following items. CC style set by "User Setting" will be displayed.
- The setting description for each item is shown below.

Font size of the displayed caption can be switched as below.

Font Size	
<input checked="" type="checkbox"/>	Large
<input type="checkbox"/>	Middle
<input type="checkbox"/>	Small

Font style of the displayed caption can be switched as below.

Font Style	
<input checked="" type="checkbox"/>	Style1
<input type="checkbox"/>	Style2
<input type="checkbox"/>	Style3
<input type="checkbox"/>	Style4
<input type="checkbox"/>	Style5
<input type="checkbox"/>	Style6
<input type="checkbox"/>	Style7
<input type="checkbox"/>	Style8

Font opacity of the displayed caption can be switched as below.

Font Opacity	
<input checked="" type="checkbox"/>	Solid
<input type="checkbox"/>	Transparent
<input type="checkbox"/>	Translucent
<input type="checkbox"/>	Flash

Font color of the displayed caption can be switched as below.

Font Color	
<input checked="" type="checkbox"/>	White
<input type="checkbox"/>	Black
<input type="checkbox"/>	Red
<input type="checkbox"/>	Green
<input type="checkbox"/>	Blue
<input type="checkbox"/>	Yellow
<input type="checkbox"/>	Magenta
<input type="checkbox"/>	Cyan

<Edge Type>

Edge type of the displayed caption can be switched as below.

Edge Type	
<input checked="" type="checkbox"/>	None
<input type="checkbox"/>	Raised
<input type="checkbox"/>	Depressed
<input type="checkbox"/>	Uniform
<input type="checkbox"/>	L.Shadow
<input type="checkbox"/>	R.Shadow

<Edge Color>

Edge color of the displayed caption can be switched as below.

Edge Color	
<input type="checkbox"/>	White
<input checked="" type="checkbox"/>	Black
<input type="checkbox"/>	Red
<input type="checkbox"/>	Green
<input type="checkbox"/>	Blue
<input type="checkbox"/>	Yellow
<input type="checkbox"/>	Magenta
<input type="checkbox"/>	Cyan

<Back Opacity>

Background opacity of the displayed caption can be switched as below.

Back Opacity	
<input checked="" type="checkbox"/>	Solid
<input type="checkbox"/>	Transparent
<input type="checkbox"/>	Translucent
<input type="checkbox"/>	Flash

<Back Color>

Background color of the displayed caption can be switched as below.

Back Color	
<input type="checkbox"/>	White
<input checked="" type="checkbox"/>	Black
<input type="checkbox"/>	Red
<input type="checkbox"/>	Green
<input type="checkbox"/>	Blue
<input type="checkbox"/>	Yellow
<input type="checkbox"/>	Magenta
<input type="checkbox"/>	Cyan

7 Press [SETUP] to exit.

INFORMATION ON DVD RECORDING







Before you make a recording, read the following information.

Recordable Discs

This unit can record to DVD+RW, DVD+R, DVD-RW and DVD-R.

DVD+R/DVD-R can only be recorded to once. DVD+RW/DVD-RW can be recorded to and erased many times.

DVD-RW/-R will be recorded in the DVD+VR mode automatically in this unit.

Logos	Attributes
 DVD+ReWritable	8cm/12cm, single-sided, single layer disc Approx. max. recording time (SLP mode): 360 minutes (4.7GB) (for 12cm) 108 minutes (1.4GB) (for 8cm)
 DVD+R	
 DVD+RW	
 DVD+R	
 DVD-RW	
 DVD-R	

- Following discs are recommended for good recording quality and are proven to be compatible with this unit. However, depending on the media condition the unit may not read the disc properly.

Verbatim	DVD+R 8x,	DVD+RW 4x,
	DVD-R 8x,	DVD-RW 2x
JVC	DVD-RW 4x	
Maxell	DVD+R 4x/8x/16x,	DVD-R 8x/16x
SONY	DVD+R 4x/8x/16x, DVD+RW 4x	
TDK	DVD+R 4x/8x/16x	

Performance of any other discs are not guaranteed.

- **You can play back DVD+RW on most DVD players without finalizing. However, if you have added or deleted chapters, or made chapters hidden, you must perform "Make Edits Compatible" before being able to see those effects on other units. (Refer to page 81 for more details.) To play back discs other than DVD+RW on other DVD players, you will need to finalize.**

Unrecordable Discs

- DVD-RW recorded in the mode other than +VR is not recordable on this unit unless you erase all contents in the disc (refer to page 80).
- DVD-R recorded in the mode other than +VR is not recordable on this unit.

Recording Mode

You can select a recording mode among 6 options, and the recording time will depend on the recording mode you select as follows.

Disc size	Recording mode	Recording time	Video/sound quality
8cm Disc	HQ (1Hr)	18 min	☆☆☆☆☆☆ (good)
	SP (2Hr)	36 min	☆☆☆☆☆
	SPP (2.5Hr)	45 min	☆☆☆☆
	LP (3Hr)	54 min	☆☆☆
	EP (4Hr)	72 min	☆☆
	SLP (6Hr)	108 min	☆ (poor)
12cm Disc	HQ (1Hr)	60 min	☆☆☆☆☆☆ (good)
	SP (2Hr)	120 min	☆☆☆☆☆
	SPP (2.5Hr)	150 min	☆☆☆☆
	LP (3Hr)	180 min	☆☆☆
	EP (4Hr)	240 min	☆☆
	SLP (6Hr)	360 min	☆ (poor)

- The recording time is only an estimate. The actual recording time may differ.
- The audio and video quality gets poorer as the recording time becomes longer.
- Each time [REC MODE] is pressed, recording mode and its allowed recording time will be displayed.

Note

- **This unit cannot record to CD-RW or CD-R.**
- All high definition pictures will be down converted to the standard definition pictures when they are recorded on this unit.
- DVD+RW/+R, DVD-RW/-R and CD-RW/-R recorded on a personal computer or a DVD or CD recorder may not be played back if the disc is damaged or dirty or if there is condensation on the player's lens.
- If you record a disc using a personal computer, even if it is recorded in a compatible format it may not be played back because of the settings of the application software used to create the disc. (Check with the software publisher for more detailed information.)
- Since the recording is made by the VBR (variable bit rate) method, depending on the picture you are recording, the actual remaining time for recording may be a little shorter than the remaining time displayed on the TV screen.
- You cannot record copy-protected program using this unit. (Copy-protected signal is included in DVD-video or some satellite broadcasts.)
- You cannot record "copy-once only" program on DVD.

BEFORE RECORDING

Make Recording Compatible



Use this feature to make the unfinalized +VR mode discs recorded on other unit recordable on this unit. When you make an additional recording on this unit with "Make Recording Compatible" set to "ON", the title menu is automatically converted to our style.

1) Press [SETUP] and use [▲ / ▼] to select "General Setting", then press [OK].

"General Setting" menu will appear.

2) Use [▲ / ▼] to select "Recording", then press [OK].

"Recording" menu will appear.

3) Use [▲ / ▼] to select "Make Recording Compatible", then press [OK].

4) Use [▲ / ▼] to select "ON" or "OFF", then press [OK].

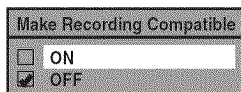

ON: Title list will be replaced when you make additional recordings to the discs recorded by other units.

OFF: Prohibiting additional record to the disc that has a title list created by other units.

5) Press [SETUP] to exit.

Setting for Auto Chapter

You can set a specified time for chapter marks.

1) Press [SETUP] and use [▲ / ▼] to select "General Setting", then press [OK].

"General Setting" menu will appear.

2) Use [▲ / ▼] to select "Recording", then press [OK].

"Recording" menu will appear.

3) Use [▲ / ▼] to select "Auto Chapter", then press [OK].

4) Use [▲ / ▼] to select a desired time option, then press [OK].

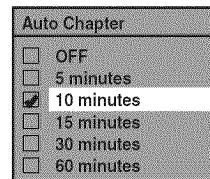

5) Press [SETUP] to exit.

Note

- The interval for auto chapter may be up to two minutes different from the time option you set.
- A blank chapter may be created depending on the remaining time of the disc.

Recording the DTV Closed Caption

You can record the DTV Closed Caption as the part of the image for the recording program and see the recorded closed caption even with the TV that is not closed caption compliant.

1) Press [SETUP] and use [▲ / ▼] to select "General Setting", then press [OK].

2) Use [▲ / ▼] to select "Display", then press [OK].

3) Use [▲ / ▼] to select "DTV CC", then press [OK].

4) Use [▲ / ▼] to select "Recording", then press [OK].

- If "Caption Service" is set to "OFF", you cannot select "Recording".

5) Use [▲ / ▼] to select "ON", then press [OK].

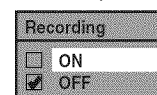

6) Press [SETUP] to exit.

Note

- If "Caption Service" is set to "OFF", the caption will not be recorded.

BASIC RECORDING & ONE-TOUCH TIMER RECORDING

Follow the steps to record TV programs.

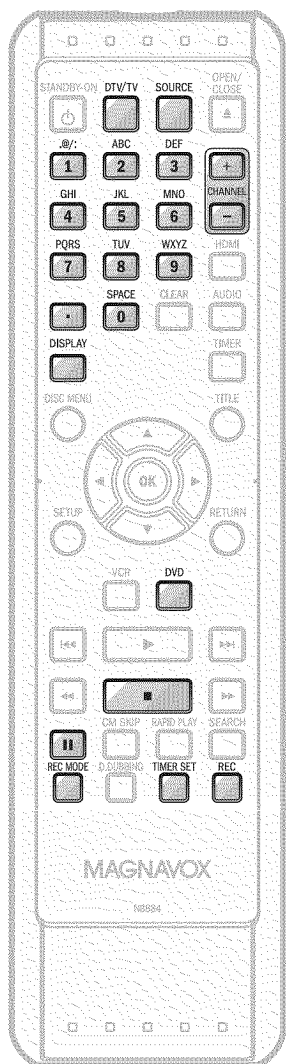

1 Press [DVD] first. Insert a recordable disc (refer to page 26 on how to insert a disc).

* Make sure the disc is compatible with this unit. (Refer to page 39 for the list of compatible discs.)

It may take a while to load the disc.

- When inserting a brand-new DVD+RW/DVD-RW, the unit automatically starts to format.
- If titles have been recorded on the disc, the title list is displayed. Press [STOP ■] to exit the title list.

2 Press [REC MODE] repeatedly to select a recording mode.

Refer to "Recording Mode" on page 39.

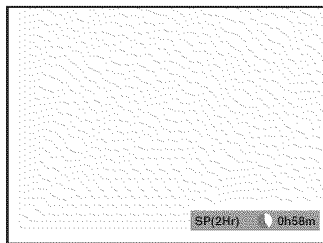

3 Select the appropriate external input channel by pressing [SOURCE] or [CHANNEL + / -].

Press [DTV/TV] to select analog TV or digital TV, then use [CHANNEL + / -] or [the Number buttons] and [•] (for digital TV channels) to select a desired channel to record.

Refer to "Switching Analog Mode/Digital Mode" and "Channel Selection" on page 33.

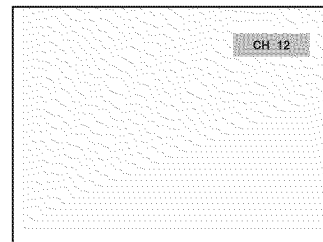

4 Press [REC] to start recording.

"●" will be displayed for 4 seconds.

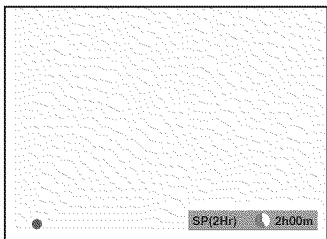

Press [PAUSE III] to pause recording.
Press [PAUSE III] or [REC] again to restart recording.

To set one-touch timer recording (OTR)...

This is a simple way to set the recording time in blocks of 30 minutes.

Press [REC] repeatedly until the desired recording time (30 minutes to 6 hours) appears on the TV screen. One-touch timer recording will start.

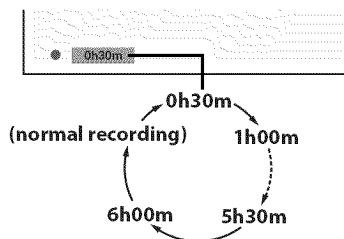

To change the recording length during the one-touch timer recording:

Press [REC] repeatedly until the desired length appear.

To cancel the one-touch timer recording within the specified time:

Press [STOP ■].

5 Press [STOP ■] to stop recording.

The recorded title will appear in the title list. (Refer to "Guide to a Title List" on page 70.) e.g.) DVD+R

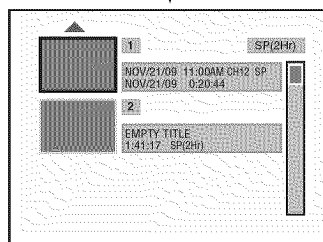
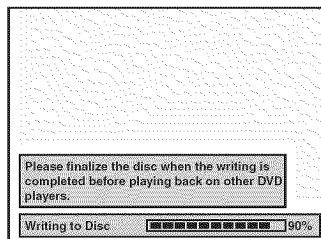

• Press [STOP ■] to exit the title list.

Note

- When you press [REC], recording starts immediately and continues until the disc is full or you stop recording.
- This unit cannot record images as aspect ratio of 16:9. The 16:9 images will be recorded as 4:3.
- When the unit clock has not been set, the space for a date and time of title names will be blank.
- When you record a TV program, you have to select the TV channel audio beforehand. Only the selected channel audio will be recorded. Refer to "Selecting TV Audio" on pages 34-35 for more details.
- This unit cannot record in both stereo and SAP (secondary audio program) at the same time.
- You cannot change the recording mode during the recording pause mode.
- You can change a channel to be recorded during the recording pause mode.

Note for one-touch timer recording

- The remaining recording time will be displayed on the front panel display during one-touch timer recording. Press [DISPLAY] to see it on the TV screen.
- Unlike the timer recording, you can perform the following operations during one-touch timer recording.
 - Turning the power to standby to stop one-touch timer recording.
 - Using [REC] or [STOP ■] on the remote control.
- You cannot use the pause function during one-touch timer recording.
- When one-touch timer recording is finished and the power is turned to standby, the unit will switch to the timer-standby mode automatically if a timer recording has been programmed. Press [TIMER SET] to cancel the timer-standby mode to use the unit continuously.

TIMER RECORDING

You can program the unit to record up to 12 programs within a month in advance. Daily or weekly program recordings are also available.

Before recording, make sure

- Set the clock before setting a timer programming.
- Insert a recordable disc with enough recordable space.

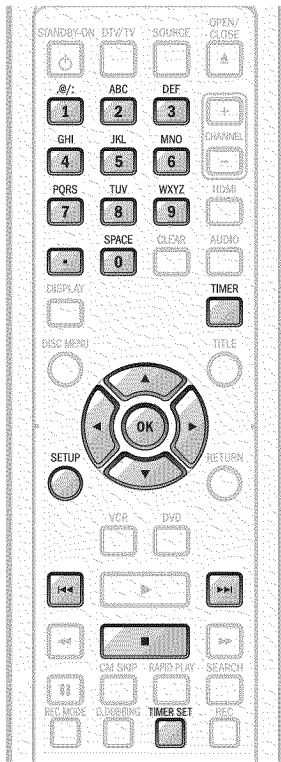

Guide to Timer Programming Display

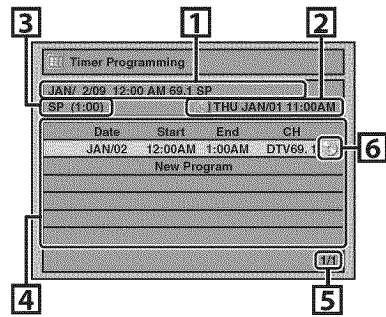

- 1 Title of a timer program (Contains date, time, channel, recording mode of the program)
- 2 Current date and time
- 3 Recording mode, and length of the recording
- 4 Timer program list
- 5 Total number of pages and current page (2 pages maximum)
- 6 Recording media ("DVD" (DVD) or "VCR") (VCR))

1 Press [TIMER].

2 Use [▲ / ▼] to select "New Program", then press [OK].

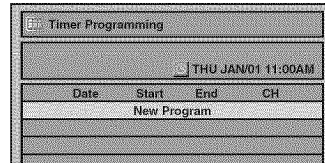

- If there are 6 or more programs, use [◀▶] to change pages.

3 Use [▲ / ▼] to enter the date, then press [▶].

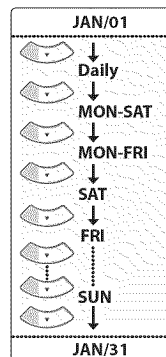

When pressing [▼] at the current date, the date will change as follows.

e.g. January 1st

Note

• If you have not set the clock yet:

- Entry screen for the clock setting will appear instead of the timer programming list at step 1. Continue with the step 5 in "Manual Clock Setting" on page 32 before setting a timer programming.
- Use [◀ / ▶] to move the cursor to the left and the right in the entry screen for the timer programming.
- If a basic recording or one-touch timer recording is in progress on one component (e.g., VCR) and the timer recording set for the other component (e.g., DVD) is about to begin, the unit automatically switches to the programmed channel for timer recording 2 minutes before the programmed starting time, and the recording in progress (for VCR) will be canceled UNLESS their recording channels are the same. If their recording channels are the same, the timer recording will start without canceling the recording currently in progress. In this case, the recording of the same channel will be made on both DVD and VCR.
- You cannot make a program whose recording time exceeds 12 hours.
- Cancel the timer-standby mode by pressing [TIMER SET] before operation for either DVD or VCR. When finished operating, press [TIMER SET] to resume the timer-standby mode.
- In the timer-standby mode, you can turn on the power and use the component (VCR or DVD) which is not currently timer-programmed.

TIMER RECORDING

4 Use [▲ / ▼ / ◀ / ▶] or [the Number buttons] to enter the start and end time, then press [▶].

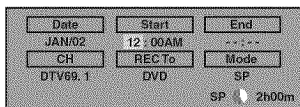

- You cannot make a program which recording time exceeds 12 hours.

5 Use [▲ / ▼ / ◀ / ▶] to select analog ("---") / digital ("DTV") mode or external input (L1 / L2), then press [▶].

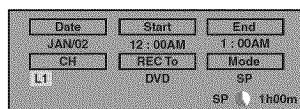

To record from external input (e.g., cable/satellite box), select L1 or L2.

Use [▲ / ▼] or [the Number buttons] to select the channel number to record, then press [▶]. For digital mode, select both major and minor channels. Refer to "How to select a channel number for the timer recording" on page 45 for more details.

e.g.) analog mode

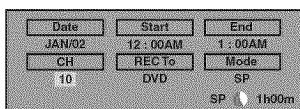

e.g.) digital mode

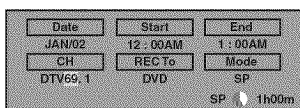

6 Use [▲ / ▼] to select the recording media ("DVD" or "VCR"), then press [▶].

e.g.) recording to DVD

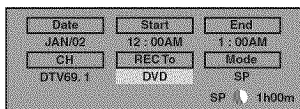

7 Use [▲ / ▼] to select a recording mode.

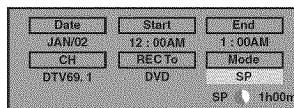

Refer to "Recording Mode" on page 39.

- When recording to DVD, you can check the remaining recordable space of the disc when you select the recording mode.

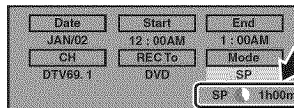

Auto recording mode select (DVD only)...

When "Auto" is selected as a recording mode, the unit calculates how much time is available on the disc and selects the best recording mode available automatically to complete recording the program.

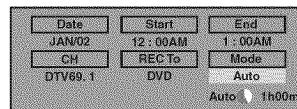

- "Auto" is only available for one program in the timer program list.
- The recording may be cut short when the available recording space of the disc is too limited.

8 Press [OK] when all items are entered. After displaying an instructive message for 10 seconds, timer program list will appear.

Press TIMER SET to Timer Standby mode.
When Timer set on DVD or VCR,
it is not available in the standby mode.
Press TIMER SET to cancel the Standby mode.

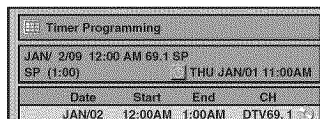

Your program setting is now stored.

- To set another program, repeat steps 2 to 8.
- To exit, press [TIMER] or [SETUP].
- When 2 or more programs are overlapped, "Timer program overlapped" appears, and the overlapped program will be displayed in blue.
- To correct the timer program refer to "Checking, canceling, or correcting the timer programming information" on page 45.

9 Press [TIMER SET] to set a timer programming.

Ⓜ will appear on the front panel display, while this unit waits to make the recording.



"VCR" will appear on the front panel display if VCR timer recording have been set.

TIMER RECORDING

How to select a channel number for the timer recording

Analog TV	For channel number 2-6 press, press [▶] or [•] to decide the channels. For other channels (7-69), the channel will be decided as soon as you enter the channel number.
Analog CATV	For channel number 1-12 press, press [▶] or [•] to decide the channels. For other channels (13-125), the channel will be decided as soon as you enter the channel number.
Digital TV	For channel number 1-9 press, press [▶] or [•] to decide the channels. For other channels (10-99), the channel will be decided as soon as you enter the channel number.
Digital CATV	For channel number 1-13 press, press [▶] or [•] to decide the channels. For other channels (14-135), the channel will be decided as soon as you enter the channel number.
minor channels	For channel number 1-9 press, press [▶] or [•] to decide the channels. For other channels (10-99), the channel will be decided as soon as you enter the channel number.

<Hint>

- You can decide the 1-digit channel number by pressing 0 first, then enter desired 1-digit channel number. e.g.) "5": **[0]+[5]**
- For selecting the channels with **[▲ / ▼]** you need to press **[▶]** or **[•]** to decide the channel number.
- For selecting the minor channels with **[▲ / ▼]**, please make sure the minor channel you are selecting is existed. **[▲ / ▼]** does not skip the non-existed minor channels.

To stop the timer recording in progress

- 1) Press **[STOP ■]** on the remote control.
- 2) Confirmation message will appear. Select "Yes", then press **[OK]**.
 - To stop the timer recording immediately, press **[■STOP]** on the unit.

Checking, canceling, or correcting the timer programming information

- 1) Press **[TIMER SET]**.
- 2) Press **[TIMER]**.
- 3) Check the information.

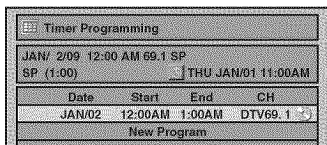

- 4-A) To delete the timer program:
 - 1 Use **[▲ / ▼]** to select the program you want to delete, then press **[OK]**.
 - 2 Use **[▲ / ▼]** to select "Delete", then press **[OK]**. Confirmation window will appear.
 - 3 Use **[▲ / ▼]** to select "Yes", then press **[OK]**.
- 4-B) To correct the timer program:
 - 1 Use **[▲ / ▼]** to select the program you want to correct, then press **[OK]**.
 - 2 Use **[▲ / ▼]** to select "Program Change", then press **[OK]**.
 - 3 Correct the timer program by using **[▲ / ▼ / ◀ / ▶]**, then press **[OK]**.
- 5) Press **[TIMER]** to exit.
- 6) Press **[TIMER SET]** to return to the timer standby mode.

Note

- Press **[TIMER]** to check the timer recording in progress. When the timer recording is proceeding, that program will be highlighted with red. In this case, you cannot select any other program.

If the timer program did not complete correctly, the error number appears in the timer programming list.

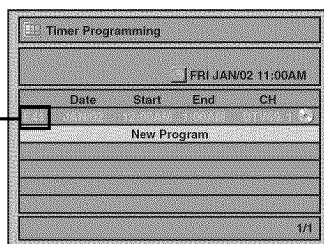



Each error number means:

E1-22 E37-39	Recording error other than below	E41	Power failed
E24	Unrecordable disc	E42	No disc when recording
E25-26	Copy prohibited program	E43	Already 49 titles recorded
E29	Disc protected	E44	Already 254 chapters recorded
E30	Disc full	E45	Copy prohibited program
E35	PCA full *1	E46	It is impossible to record additionally on a disc recorded by other units when setting "Make Recording Compatible" to "OFF".
E36	Already finalized video format disc		
E40	Some portion has not been recorded because of program overlapping. Recording did not start at the start time.		

- E23, E27, E28, E31, E32, E33 and E34 are not displayed.
- A program with the error number is grayed in the timer programming list.
- Timer program with an error number will be cleared once the entry screen for the program is displayed.
- *1 PCA is a disc's space reserved for recording test.

TIMER RECORDING

Hints for Timer Recording

- If there is a power failure or this unit has been unplugged for more than 30 seconds, the clock setting and all timer programming will be lost.
- If a disc is not inserted, "DVD" on the front panel display flashes and timer recording cannot be performed. In some cases,  will appear momentarily around the start time as the unit attempts to record. Please insert a recordable disc.
- If a cassette tape with an erase-protection tab is not in the cassette compartment or there is no cassette tape in the cassette compartment, "VCR" on the front panel display flashes and timer recording cannot be performed. Please insert a recordable cassette tape.
- If a cassette tape ends during the timer recording, the unit will automatically stop, eject the cassette tape, and turn itself to the standby mode. To continue recording, insert a recordable tape.
- When all the timer recordings are completed,  flashes. Press **[TIMER SET]** to release the unit from the timer standby mode.
- If both DVD and VCR are timer programmed, you cannot use any functions for either unit during timer standby or timer recording. If you want to use functions other than recording under such condition, cancel timer recording by pressing **[TIMER SET]** during timer standby or stop recording by pressing **[STOP]** / **[STOP/EJECT]** on the front panel of the unit during timer recording.
- To cancel the timer standby mode, press **[TIMER SET]**.
- When the starting and the ending time are the same, "Exceeds 12 hours" appears and the program setting will not be accepted.
- When the disc or cassette tape becomes full during the recording, the unit turns itself to the standby mode.
- If the starting time is earlier and the ending time is later than the current time, the recording will start right after you press **[TIMER SET]** at step 9 on page 44.
- You cannot change the audio language for the timer recording of digital TV broadcasting.
- The timer recording cannot be performed in DVD and VCR at the same time. If you set 2 programmings with the same channel and time in both devices, the program which is set first will have the priority.
- "Press TIMER SET for timer recording" will appear on the TV screen 5 minutes before the programmed starting time.

The Priority of Overlapped Settings

- Timer program which has the earlier start time will be placed first in the timer program list, and be given priority over the programs with the later start time when timer programs overlap.
- When timer programs overlap, the first 2 minutes (at the longest) of the later recording will be cut off.
- When 2 or more timer programs have the same start time, the program set first will be given priority.
- A timer recording of lower priority will be canceled or start from the middle.
- Check the overlapped timer programmings and change the priority if necessary.

■ When the starting time is the same:

A program set previously (PROG. A) has priority.

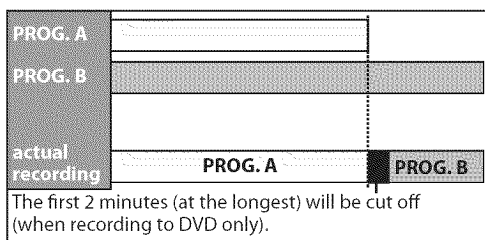

Note for DVD recording

- When the recording time of 2 programs are overlapped, or the end time of a program and the start time of another program is the same, the first 2 minutes (at the longest) of the subsequent program will be cut off.
- If the cut-off portion comes up to 3 minute or more, this program will be displayed with error number E40 in the timer programming list.

■ When the end time of the programming currently being recorded and the start time of the subsequent program are same:

The beginning of the PROG. B may be cut off.

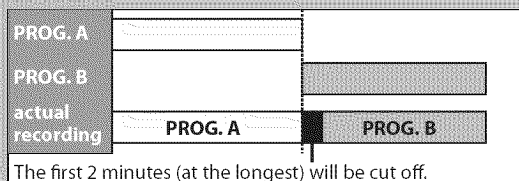

OVERWRITING UNNECESSARY TITLE

Overwriting from the Beginning of the Title



You can overwrite the existing title from the beginning.

- 1) Press **[STANDBY-ON ⏻]**.
Make sure that the TV input is set on the unit.
- 2) Load the disc that includes a title to be overwritten.

It takes a while to display the title list.

Title list will appear.

If the title list does not appear, press **[TITLE]**.

- 3) Press **[REC MODE]** repeatedly to select a recording mode.
Refer to "Recording Mode" on page 39.
- 4) Use **[▲ / ▼]** to select a title to be overwritten, then press **[OK]**.

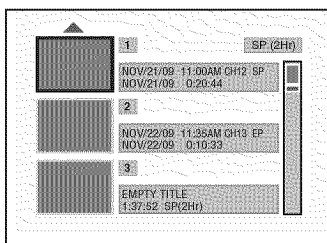

- 5) Use **[▲ / ▼]** to select "Overwrite", then press **[OK]**.

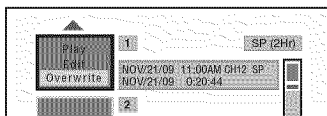

- 6) Select the channel you want to record.
(Refer to page 33 on how to select a channel.)
e.g.) DVD+RW



- 7) Press **[REC]**.
Overwriting recording starts.
The elapsed-time counter starts running.
- 8) Press **[STOP ■]** to stop recording.
Title name is also overwritten.

This operation may take a while to be completed.

Note

- The remaining recording time is displayed on the bottom right corner of the TV screen during overwriting.

Overwriting in the Middle of the Title



You can overwrite the existing title from the selected position.

- 1) Follow the steps 1, 2 and 4 on the left.
- 2) Use **[▲ / ▼]** to select "Play", then press **[OK]**.
Playback will start.
- 3) Press **[PAUSE III]** at the point from which you want to start overwriting.
- 4) Press **[REC]**.
"⏻●", display menu, channel, and the time lapse will be displayed as illustrated on the left.
- 5) Select the channel you want to record.
(Refer to page 33 on how to select a channel.)
- 6) Press **[REC]** again.
Overwriting recording starts.
- 7) Press **[STOP ■]** to stop recording.

This operation may take a while to be completed.

Note

- Recording mode of the overwriting title is the same as that of the original (overwritten) title when overwriting in the middle of the title.
- Title name will not be overwritten.

OVERWRITING UNNECESSARY TITLE

Hints for Overwriting

When you overwrite on the unnecessary title, there were various circumstances such as follows. Please note that following cases only describe the overwriting without any recording mode discrepancy. To avoid accidental deletion please check if there is no important title after the overwriting point.

When overwriting title is shorter than the existing title:

(overwriting from the beginning of the title)

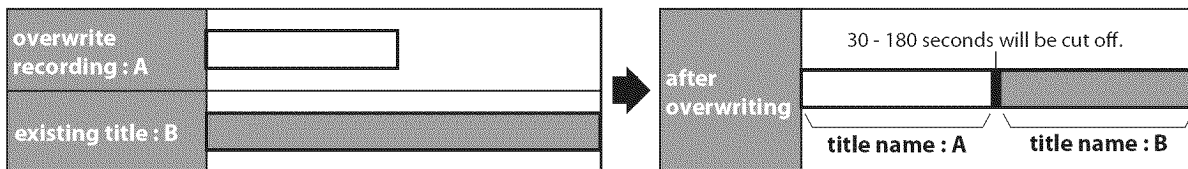

When overwriting title is longer than the existing title:

(overwriting from the beginning of the title)

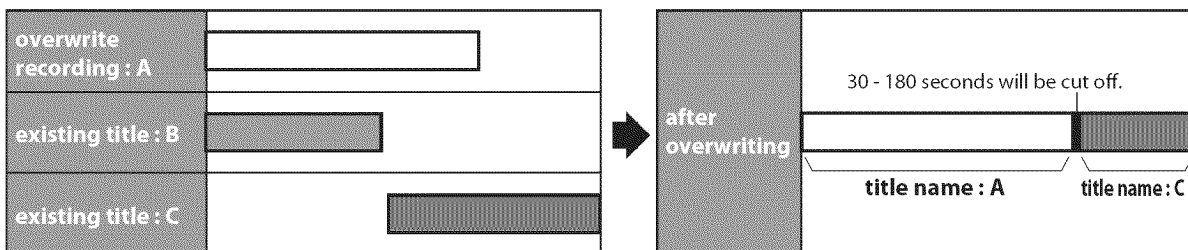
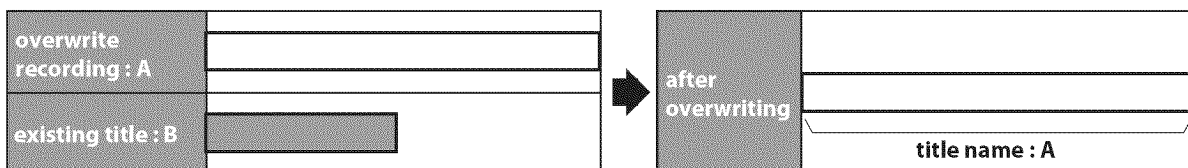

When overwriting in the middle of the title:

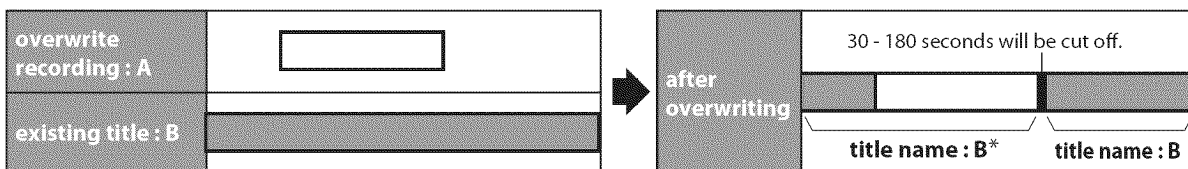

*Overwritten section and the rest of the sections will have the same title name as the original existing title (B).

Note

- When a title name is overwritten, its thumbnail is also overwritten.
- "Auto Chapter" interval time is reset at the overwriting start point.
- A chapter mark is put at the beginning of the overwrite title when overwriting in the middle of the title.

SETTINGS FOR AN EXTERNAL DEVICE

Connection to an External Device

Connect the external device properly to the unit by using input jacks either L2 (Front) or L1 (Rear).
When connecting an external device of monaural output to this unit, use AUDIO L jack of L2 (Front) or L1 (Rear).
Use S-video or the RCA audio/video cables for this connection.

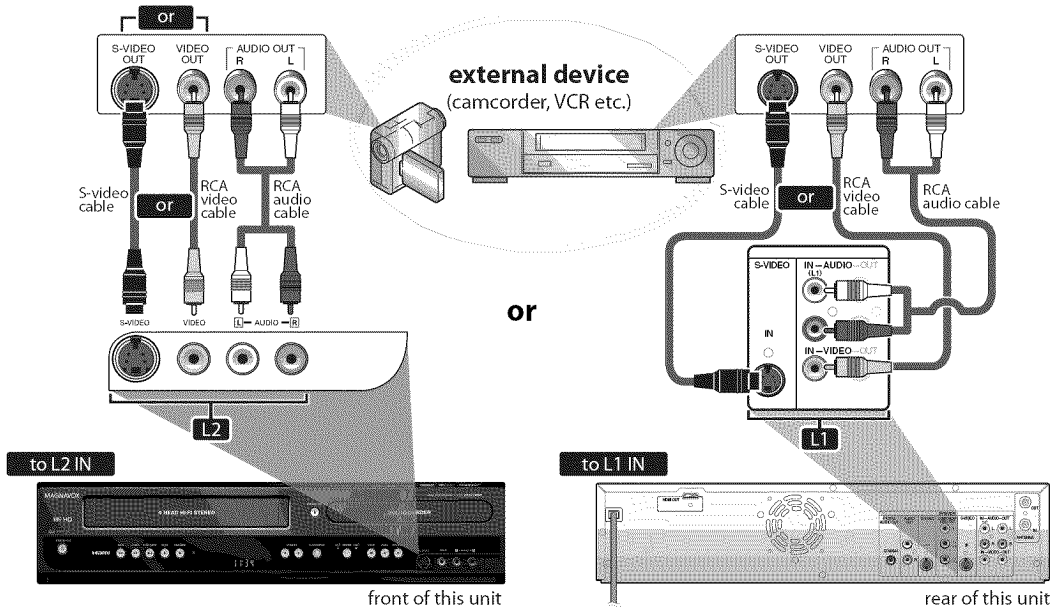

Supplied cables used in this connection are as follows:

- RCA audio cable (L/R) x 1
- RCA video cable x 1

Please purchase the rest of the necessary cables at your local store.

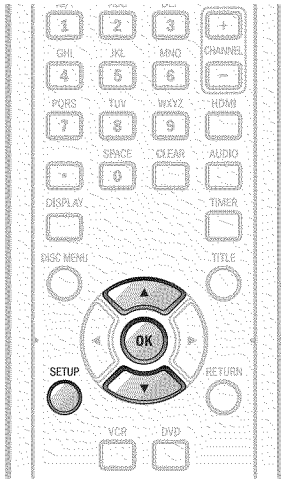

1 Press [SETUP] and use [▲ / ▼] to select "General Setting", then press [OK].

"General Setting" menu will appear.

2 Use [▲ / ▼] to select "Video", then press [OK].
Submenu will appear.

3 Use [▲ / ▼] to select "Video Input", then press [OK].

4 Use [▲ / ▼] to select desired external input, then press [OK].

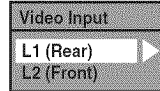

5 Use [▲ / ▼] to select the input jack type to connect, then press [OK].
If you want to use VIDEO IN jack, select "Video In".

If you want to use S-VIDEO IN jack, select "S-Video In".

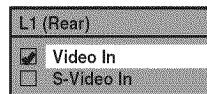

6 Press [SETUP] to exit.

SETTINGS FOR AN EXTERNAL DEVICE

Recording from an External Device

Before recording from an external device, refer to the instructions for the connection on page 49.

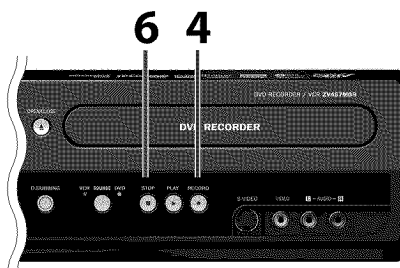
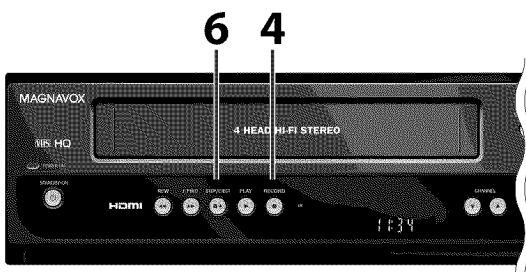
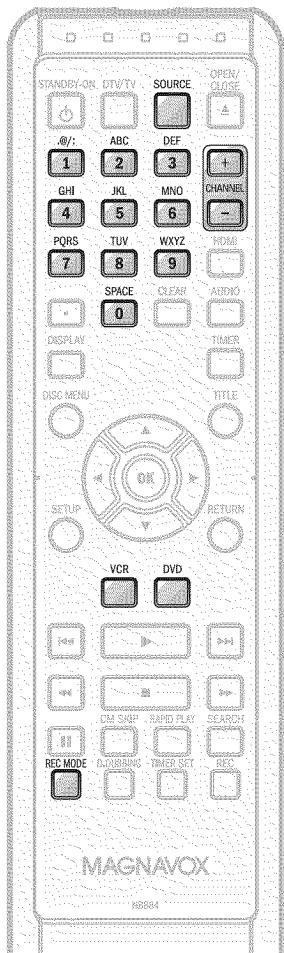

1

Recording to a DVD

Press **[DVD]**.

Insert a recordable disc (refer to page 26 on how to insert a disc).

It takes a while to load the disc.

Recording to a Cassette Tape

Press **[VCR]**.

Insert the cassette tape with an erase-protection tab intact.

2

Select the appropriate external input channel (L1 or L2) by pressing **[SOURCE]** or **[CHANNEL + / -]**.

- If the external device is connected to the rear of this unit, select L1.
- If the external device is connected to the front of this unit, select L2.
- You can also select L1 or L2 channel by using **[the Number buttons]**.
e.g.) For L1, press **[0]**, **[0]**, **[1]**.

3

Press **[REC MODE]** repeatedly to select a recording mode.

Refer to "Recording Mode" on page 39 for DVD, or "Recording" on page 94 for VCR.

4

Press **[●RECORD]** on the unit to start recording.

5

Start playback on the external device to record from.

6

For disc:

Press **[■STOP]** on the unit to stop recording.

For cassette tape:

Press **[■▲STOP/EJECT]** on the unit to stop recording.

This operation may take a while to be completed.

BI-DIRECTIONAL DUBBING

You can copy contents in a DVD to a cassette tape, or do vice versa. This function is available only when the contents are not copy-protected. (Before you start, refer to page 39 for the list of compatible discs.)

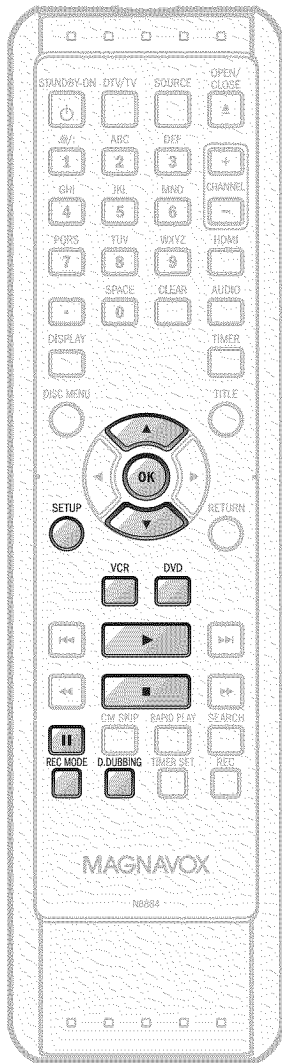

Preparing for dubbing (cassette tape to DVD):

- Insert a cassette tape to be dubbed.
- Insert a recordable DVD.
- Make sure there is enough space on the DVD.

Preparing for dubbing (DVD to cassette tape):

- Insert a disc to be dubbed.
- Insert a cassette tape with an erase-protection tab in tact.
- Make sure there is enough recordable length on the tape.

1 Press [SETUP] and use [▲ / ▼] to select "General Setting", then press [OK].

"General Setting" menu will appear.

2 Use [▲ / ▼] to select "Recording", then press [OK].

"Recording" menu will appear.

3 Use [▲ / ▼] to select "Dubbing Mode", then press [OK].

Selection menu will appear.

Note for dubbing

- Dubbing direction setting in "Dubbing Mode" menu is always reset to "VCR → DVD" whenever you turn the power to the standby mode.
- You cannot change the output mode during VCR to DVD or DVD to VCR duplication.

Note for recording to a tape:

Make sure

- the cassette tape's erase-protection tab is intact.
- the cassette tape is long enough.

Note for recording to a disc:

Make sure

- the disc is compatible (refer to page 39).

Introduction

Connections

Basic Setup

Recording

Playback

Editing

Function Setup

VCR Functions

Others

Español

BI-DIRECTIONAL DUBBING

VCR to DVD

- 4** Use [▲ / ▼] to select "VCR ⇒ DVD", then press [OK].

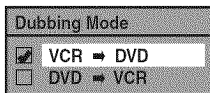

Press [SETUP] to exit.

- 5** Press [VCR], then press [PLAY ►] to find the point where you wish to start dubbing.

- 6** Press [PAUSE ■■] when you come to the desired start point.

- 7** Press [DVD], then press [REC MODE] repeatedly to select the desired recording mode.

- 8** Press [D.DUBBING].
VCR to DVD duplication will start.

- 9** Press [STOP ■] to stop the dubbing.

DVD to VCR

- 4** Use [▲ / ▼] to select "DVD ⇒ VCR", then press [OK].

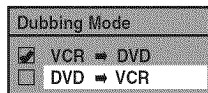

Press [SETUP] to exit.

- 5** Press [DVD], then press [PLAY ►] to find the point where you wish to start dubbing.

- 6** Press [PAUSE ■■] when you come to the desired start point.

- 7** Press [VCR], then press [REC MODE] repeatedly to select the desired recording mode.

Rewind or fast forward the tape to the point where you want to start recording.

- 8** Press [D.DUBBING].
DVD to VCR duplication will start.

- 9** Press [STOP ■] to stop the dubbing.

Note for DVD to VCR duplication

- This function is available for audio CD, but not with MP3 / JPEG / Kodak Picture CD files.
- The recording mode for VCR cannot be displayed at step 7 when using HDMI / Component / S-Video connection. To display the VCR recording mode on the screen, the unit must be connected by the VIDEO OUT jack and the TV's input select should be set to the appropriate external input channel.

Note for VCR to DVD duplication

- After starting VCR to DVD duplication, the picture may be distorted because of the auto tracking function. This is not a malfunction. Be advised to play back the tape until the picture is stabilized, then set the starting point which you wish to start recording, and start VCR to DVD duplication.
- This unit will automatically stop the duplication if playback with no image is detected for more than 3 minutes during VCR to DVD duplication.
- Playback sound mode of the dubbed contents is determined by the playback sound mode of the VCR at the point of dubbing.

SETTING A DISC TO PROTECT

To prevent accidental recording, editing or erasing the titles, you can protect them from "Disc Edit" menu.

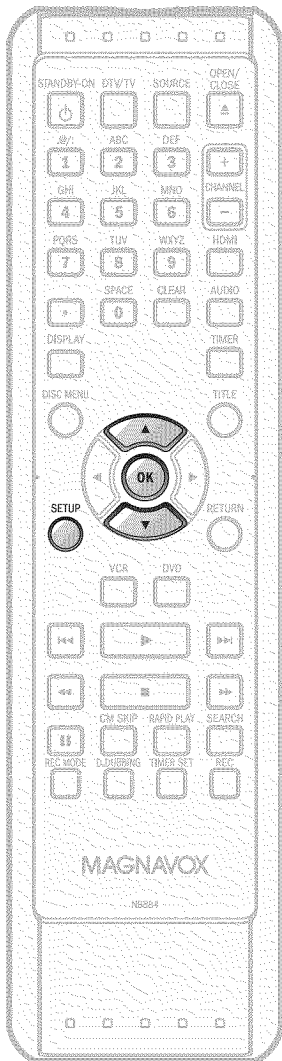

1 Press [SETUP].

2 Use [▲ / ▼] to select "Disc Edit", then press [OK].

3 Use [▲ / ▼] to select "Disc Protect OFF ➔ ON", then press [OK].
e.g.) DVD+RW

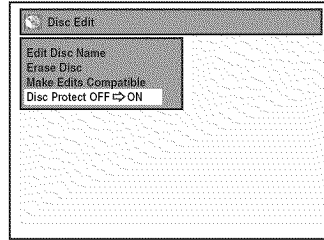

4 Use [▲ / ▼] to select "Yes", then press [OK].

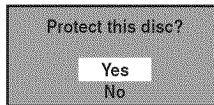

A disc will be protected.

This operation may take a while to be completed.

Note

To cancel the disc protect:

- When you insert a disc protected with this unit, "Disc Protect ON ➔ OFF" will appear instead of "OFF ➔ ON" at step 3.

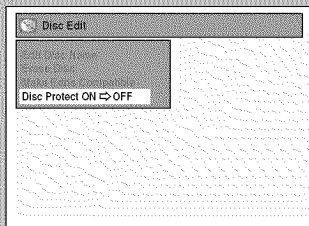

To release the protection for the disc, select "Disc Protect ON ➔ OFF" at step 3, then follow rest of the procedures.

PLAYING THE DISCS ON OTHER DVD PLAYERS

Finalizing a Disc



You will need to finalize DVD+R, DVD-RW or DVD-R to play them back on other DVD players.

Finalizing may take several minutes up to an hour.

A shorter recording period on the disc will require a longer time period for finalization. Do not unplug the power cord during finalization.

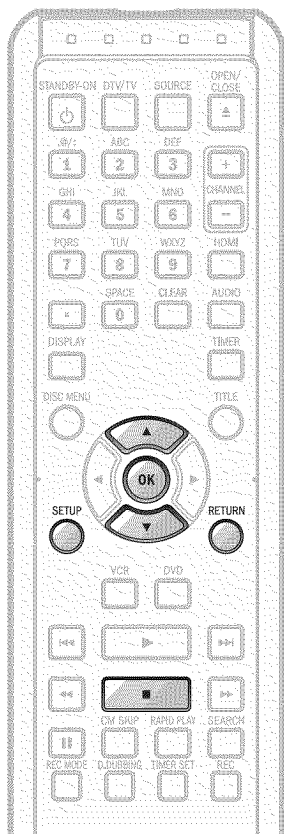

1 Press [SETUP].

2 Use [▲ / ▼] to select "Disc Edit", then press [OK].
"Disc Edit" menu will appear.

3 Use [▲ / ▼] to select "Finalize", then press [OK].

4 Use [▲ / ▼] to select "Yes", then press [OK].

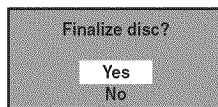

Finalizing will start.

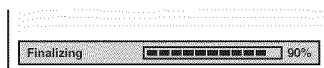

To cancel finalizing...

(DVD-RW only)

- To cancel finalizing at step 4, press [STOP ■], select "Yes" with [▲ / ▼], then press [OK]. Finalizing is canceled and the unit will be in stop mode.

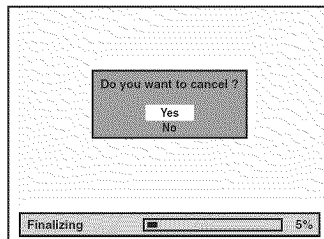

- If Ⓞ appears when pressing [STOP ■], you cannot cancel finalizing because the finalizing has been in certain progress.
- When selecting "No" and press [OK] or [RETURN], finalizing will be continued.
- You cannot cancel finalizing the DVD+R/DVD-R once it has started.

This operation may take a while to be completed.

5 Finalizing is completed.

Note

- Once you have finalized a DVD+R/ DVD-R, you cannot edit or record anything on that disc.
- There is no need to finalize DVD+RW.
- When you insert a DVD-RW finalized with this unit, "Undo Finalize" will appear instead of "Finalize".

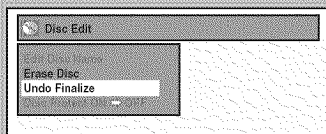

To release the finalizing for the disc, select "Undo Finalize" at step 3.

* DO NOT turn the power off or to the standby mode during finalization, this will result in malfunction.

PLAYING THE DISCS ON OTHER DVD PLAYERS

Auto Finalizing



You can finalize discs automatically using this function. You can use this function to finalize discs after finishing timer recordings and at the end of the disc space.

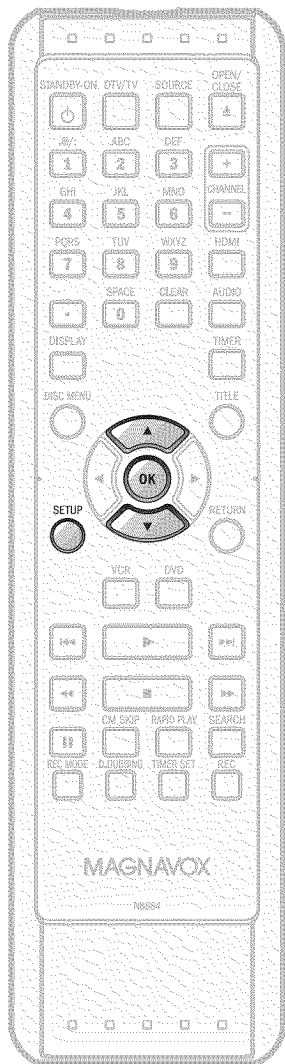

1 Press [SETUP] and use [▲ / ▼] to select “General Setting”, then press [OK].

“General Setting” menu will appear.

2 Use [▲ / ▼] to select “Recording”, then press [OK].

“Recording” menu will appear.

3 Use [▲ / ▼] to select “Auto Finalize”, then press [OK].

4 Use [▲ / ▼] to select “Disc Full” or “End of Timer Rec”, then press [OK].

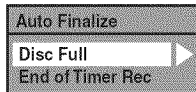

5 Use [▲ / ▼] to select “ON”, then press [OK].

e.g.) “Disc Full”

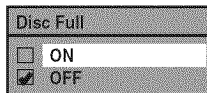

Your setting will be activated.

6 Press [SETUP] to exit.

Note

- This function is not available after finishing daily or weekly program recording.

INFORMATION ON PLAYBACK

Before you play back DVD, read the following information.

Playable Discs and Files

This unit is compatible to play back the following discs. To play back a DVD, make sure that it meets the requirements for region codes and color systems as described below. You can play back discs that have the following logos will play back on the unit. Other disc types are not guaranteed to play back.

Playable discs	Logos
DVD-video	
DVD+RW	
DVD-R	
DVD-RW (Finalized video mode discs only)	
DVD-R (Finalized video mode discs only)	
CD-DA (audio CD)	
video CD	 
CD-RW	 
CD-R	 
Kodak Picture CD	

Playable files	Media
MP3	CD-RW/-R
JPEG	

 is a trademark of DVD Format/Logo Licensing Corporation.

Unplayable Discs

The following discs will not play back on this unit.

- CD-ROM
- DVD-RAM
- DVD-ROM
- Unfinalized disc
- DVD or CD contains Windows Media™ Audio/DivX® files
- DVD-R or DVD-RW recorded in VR mode or non compatible recording format
- Blu-ray Disc
- Super Video CD
- Compact Disc-Interactive (CD-I)
- Video Single Disc (VSD)
- DVD-audio
- HD DVD

On the following disc, the sound may not be heard.

- Super audio CD - Only the sound on the CD layer can be heard. The sound on the high-density super audio CD layer cannot be heard.

Color Systems

DVD is recorded in different color systems throughout the world. The most common color system is NTSC (which is used primarily in the United States and Canada). This unit uses NTSC, so DVD you play back must be recorded in the NTSC system. You cannot play back DVD recorded in other color systems.

Region Codes

This unit has been designed to play back DVD with region 1. DVD must be labeled for ALL regions or for region 1 in order to play back on the unit. You cannot play back DVD that are labeled for other regions. Look for the symbols on the right on your DVD. If these region symbols do not appear on your DVD, you cannot play back the DVD in this unit.

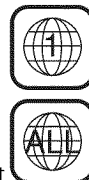

The number inside the globe refers to region of the world.

A DVD labeled for a specific region can only play back on the unit with the same region code.

INFORMATION ON PLAYBACK

PBC (playback control) for Video CD

You can select images or information on the menu screen by activating the PBC (playback control) function of the video CD.

This unit conforms to ver.1.1 and ver. 2.0 of video CD standard with PBC function.

Ver.1.1 (without PBC function): You can enjoy playback picture as well as music CD.

Ver.2.0 (with PBC function): While using a video CD with PBC function, "PBC" appears on the TV screen.

Note

- PBC setting turns to "ON" when loading video CD with PBC function, thus, even after setting PBC to "OFF" and ejecting the video CD then reloading the video CD, this setting turns to "ON" automatically.
- Some operations cannot be performed while PBC function is on. Cancel PBC function temporarily to perform those operations by following the instruction below.

- 1) Press [SETUP].
- 2) Use [▲ / ▼] to select "DISC Playback Mode", then press [OK].
"DISC Playback Mode" menu will appear.
- 3) Use [▲ / ▼] to select "PBC (Video CD only)", then press [OK].
- 4) Use [▲ / ▼] to select "ON" or "OFF", then press [OK].
Your setting will be activated.

You can play back interactive software using menu screens. Refer to instructions in the video CD.

Hint for DVD Playback

The contents of DVD are generally divided into titles. Titles may be further subdivided into chapters.

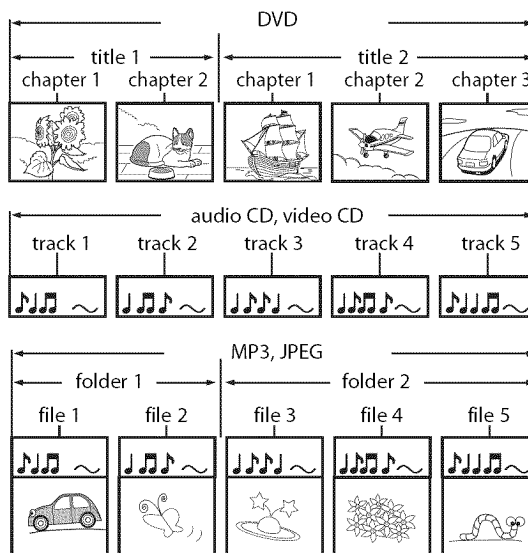

BASIC PLAYBACK

Direct Playback

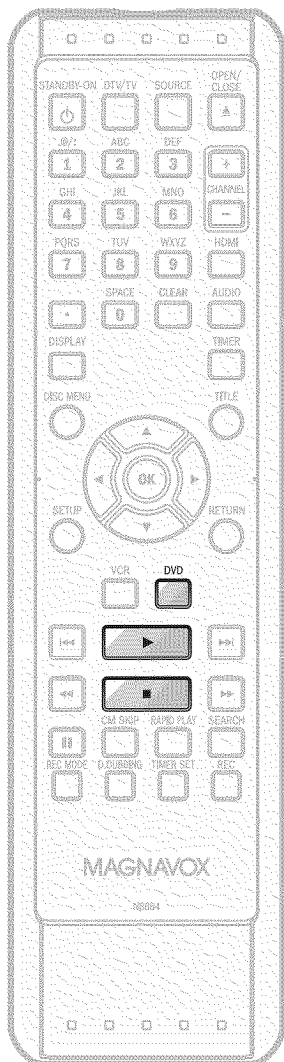

- 1** Press [DVD] first.
Insert a playable disc (refer to page 26 on how to insert a disc).

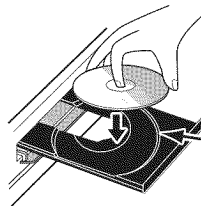

Align the disc to the disc tray guide.

* Make sure the disc is compatible with this unit.
(Refer to page 56 for the list of compatible discs.)

It may take a while to load the disc.

- 2** Press [PLAY ▶] to start playback.
If you are playing back a DVD-video or video CD with PBC function, a menu may appear.
Refer to "Using the Title / Disc Menu" on page 61.
- 3** Press [STOP ■] once to stop playback temporarily.
• Refer to "Resume Playback" on page 62.

Note

- Some discs may start playback automatically.
- You can select images or information on the menu screen by activating PBC (playback control) function (page 57).
- Playback will stop when you change the output mode.

Playback from the Title List

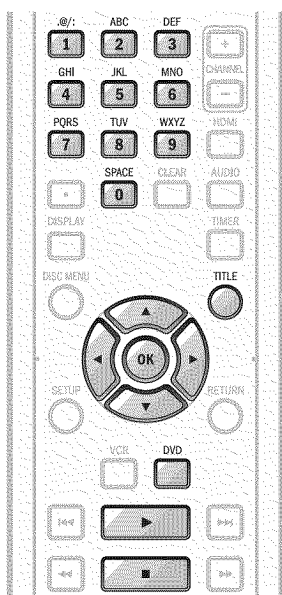

Press [DVD] first.

1 Insert a playable disc (refer to page 26 on how to insert a disc).

* Make sure the disc is compatible with this unit. (Refer to page 56 for the list of compatible discs.)

It may take a while to load the disc.

- Title list will appear automatically.
- To exit the title list, press [STOP ■].
- To resume the title list, press [TITLE].

2 Use [▲ / ▼] to select a desired title, then press [OK].

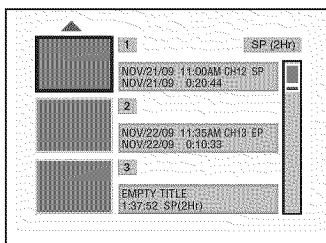

- For video CD, when "PBC (Video CD only)" in "DISC playback Mode" menu is set to "ON", the video CD main menu will appear when inserting a disc. In such case, select a numbered menu with [the Number buttons].
- Press [▶] to display the next page, and press [◀] to display the previous page.

Note

- Some discs may start playback automatically.
- You can also start playback by pressing [PLAY ▶] instead of [OK] at step 2.

If you want to see disc information, press [◀] when the first page of the title list is displayed or press [▲] when the first title is selected but not when "Play", "Edit" or "Overwrite" is highlighted.

e.g.) DVD+RW

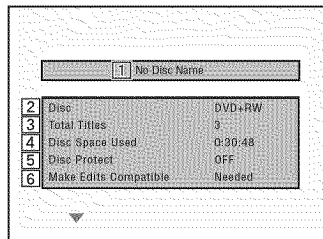

e.g.) DVD+R

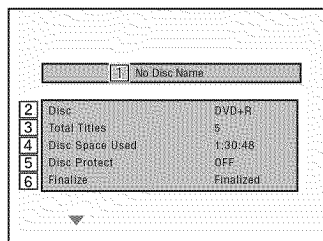

1. Disc name (Default "No Disc Name")
2. Disc type (DVD+RW/DVD+R/ DVD-RW/DVD-R)
3. Total number of title (include "EMPTY TITLE")
4. Total time of recorded disc space
5. Status of disc protection ("ON" is protected disc.)
6. Making edits compatible/finalize
 - When DVD+RW is inserted: If the disc needs to be set "Make Edits Compatible", "Needed" is displayed. Otherwise, "Not Needed" is displayed. (Refer to page 81.)
 - When DVD+R, DVD-RW or DVD-R is inserted: If "Finalize" is done, "Finalized" is displayed. Otherwise, "Unfinalized" is displayed.

3 Use [▲ / ▼] to select "Play", then press [OK].

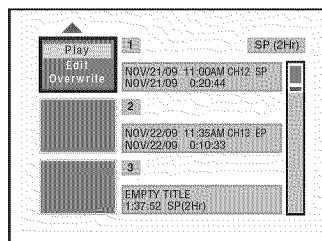

Playback will start.

4 Press [STOP ■] once to stop playback temporarily.

- Refer to "Resume Playback" on page 62.

BASIC PLAYBACK

Playing Back an Audio CD and a CD-RW / -R with MP3 / JPEG Files

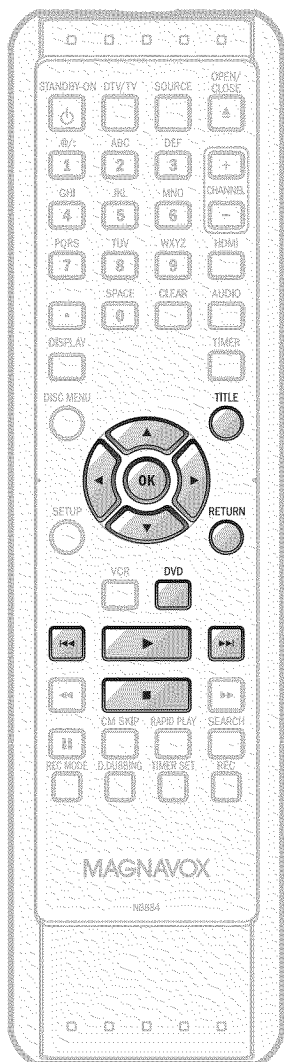

1 Press [DVD] first. Insert a playable disc (refer to page 26 on how to insert a disc).

* Make sure the disc is compatible with this unit. (Refer to page 56 for the list of compatible discs.)

It may take a while to load the disc.

When an audio CD is inserted, track list will appear. When a CD-RW/-R with MP3 / JPEG files is inserted, file list will appear.

When you insert a CD-RW/-R mixed with MP3/JPEG files, the playback media selection screen will be displayed.

For MP3, select "Music", for JPEG, select "Photo".

- To exit the track/file list, press [STOP ■].
- To resume the track/file list, press [TITLE].

2 Use [▲ / ▼] to select a desired folder or track/file, then press [OK].

e.g.) File list

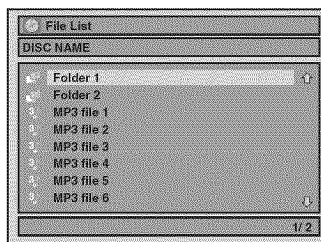

When selecting track/file:

Playback will start.





When selecting the folder (Not available for audio CD):

The files in the folder will appear.

Use [▲ / ▼] to select the file or folder you want to play back, then press [OK].

- Press [PLAY ►], [OK] or [►] to move to any lower hierarchies.
- Press [◀] or [RETURN] to move back to the previous hierarchy.

Hints for audio CD tracks and MP3 / JPEG files:

- Folders are shown by .
- Audio CD tracks are shown by .
- MP3 files are shown by .
- JPEG files are shown by .
- The system can recognize up to 255 folders, up to 99 tracks/999 files.
- Letters of a file/folder name overflowing the given space will be displayed as "...". Unrecognizable characters will be replaced with asterisks.
- If there are no files in the folder, "No Files" will be displayed.

It is recommended that files to be played back in this unit are recorded under the following specifications:

<MP3>

- Sampling frequency : 44.1 kHz or 48 kHz.
- Constant bit rate : 112 kbps - 320 kbps

<JPEG>

- Upper limit : 6,300 x 5,100 dots.
- Lower limit : 32 x 32 dots.
- File size of image maximum : 12 MB.

Note

- The audio source of MP3 files cannot be recorded as digital sound by an MD or DAT deck.
- Files whose extension is other than ".mp3(MP3)" or ".jpg / .jpeg (JPEG)" will not be listed.
- Some unplayable folders or files may be listed due to the recording status.
- High-resolution JPEG files take longer to be displayed.
- Progressive JPEG files (JPEG files saved in progressive format) cannot be played back on this unit.

BASIC PLAYBACK

Playing Back an Audio CD and a CD-RW / -R with MP3 / JPEG Files (cont'd)

Kodak Picture CD

The Picture CD is a service to convert photographs taken by a conventional film camera into digital data and write the data on a CD. You can enjoy picture images on the TV set by playing back the Picture CDs.

For details of Kodak Picture CD, contact a shop that provides developing service of Kodak Inc.

1) Press [TITLE].

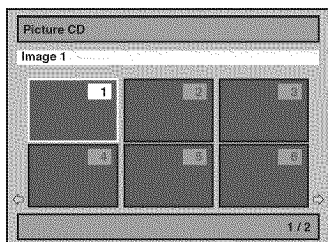

- To exit the Picture CD thumbnail List, press [RETURN] or [STOP ■].

Arrow icons mean the title list includes a next or previous page. Use [◀/▶] in the direction of the icon you wish to follow. You can quick review the six thumbnails at once between the first and last pages by pressing [◀◀] / [▶▶].

2) Use [▲ / ▼ / ◀ / ▶] to select a desired track to be played back, then press [PLAY ▶] or [OK].

An image will be played back from the selected track and go to the next one in turn.

3) Press [STOP ■] to stop playback.

- Press [TITLE] to display the thumbnail again.

Notes on JPEG and Kodak Picture CD:

- After track is displayed for 5 seconds or 10 seconds (set in "Slide Show" on page 65) the display moves to the next track.

During JPEG or Kodak Picture CD playback, press [▶] or [◀] to rotate a picture 90 degrees clockwise or counterclockwise respectively.

(Not available when the display menu appears.)

Using the Title / Disc Menu



DVD or video CD with PBC function may contain a title list, which describes the contents of the disc, or a disc menu, which guides you through the available functions in the disc.

Press [DVD] first.

1) Insert a playable disc (refer to page 26 on how to insert a disc).

- * Make sure the disc is compatible with this unit. (Refer to page 56 for the list of compatible discs.)

It may take a while to load the disc.

2) Press [TITLE] or [DISC MENU] to call up the title list or disc menu.

3) Use [▲ / ▼ / ◀ / ▶] to make a selection, and then press [OK] to enable your selection.

4) Press [STOP ■] to exit.

Note

- You can select a numbered menu with [the Number buttons] also.
- Menus vary among discs. Refer to the information accompanying the disc for details.
- [TITLE] or [DISC MENU] will not always be active with all DVD.
- For video CD, when "PBC (Video CD only)" in "DISC Playback Mode" menu is "ON", the video CD main menu will appear when inserting a disc.

Pause

1) During playback, press [PAUSE III].

Playback will be paused and sound will be muted.

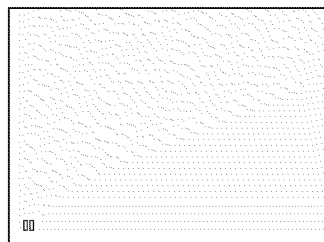

2) Press [PLAY ▶] to return to the normal playback.

Note

- On DVD, set "Still Mode" to "Field" in "Playback" menu if pictures in the pause mode are blurred. (Refer to page 87.)

SPECIAL PLAYBACK

Resume Playback

You can play back from where you stopped playing back the disc last.

1) During playback, press [STOP ■].

The resume message will appear.



2) Press [PLAY ►].

In a few seconds, playback will resume from the point at which it stopped last. You can resume playback at the same point even if you turn the unit to the standby mode.

To cancel the resume playback and start playing back the disc from the beginning, press [STOP ■] again while the playback is stopped.

Note

- For MP3 / JPEG files, playback will resume from the beginning of the file at which play back was stopped.
- Resume Playback is available when you play back the video CD without PBC function.
- Some video CD with the PBC function resume playback from the beginning of the track.

Fast Forward / Fast Reverse Playback



1) During playback, press [▶▶▶] or [◀◀◀].

Every time you press [▶▶▶] or [◀◀◀], approximate speed will be changed as follows.

Fast forward or fast reverse playback across titles (for DVD) or files (for MP3 files) is not possible.



For video CD, approximate forward/reverse speeds are 2x, 8x, 16x.

For audio CD, MP3 files, approximate speed is fixed at 8x with sound (indicated with ▶▶▶▶ / ▶▶▶▶).

2) Press [PLAY ►] to return to the normal playback.

Note

- Forward/reverse speed will be indicated with icons as follows.

forward (approx. speed)

- 2x: ▶▶
- 20x: ▶▶▶
- 40x: ▶▶▶▶

reverse (approx. speed)

- 5x: ▶▶▶
- 20x: ▶▶▶▶
- 40x: ▶▶▶▶▶

Skipping TV Commercials During Playback



You can skip TV commercials to enjoy the recorded programs without interrupting.

During playback, press [CM SKIP].

Normal playback will start at 30 seconds ahead from the point you press [CM SKIP].

Every time you press [CM SKIP], the searching point will be extended by 30 seconds ahead.

You can press [CM SKIP] up to 6 times (180 seconds).

e.g.) Press [CM SKIP] once.



(forwarding 30 seconds)



Playback will return to the normal playback.

Rapid Playback



Rapid playback function is available only during playback.

This function is available only on discs recorded in the Dolby Digital format, and plays back in a slightly faster/slower speed while keeping the sound quality just as normal playback.

1) During playback, press [RAPID PLAY].

- ▶x0.8: Press [RAPID PLAY] once during playback. Plays back approximately at 0.8 times of normal playback.
- ▶x1.3: Press [RAPID PLAY] twice during playback. Plays back approximately at 1.3 times of normal playback.
- ▶: Press [RAPID PLAY] 3 times to play back in normal speed. No effects.

2) Press [PLAY ►] to return to the normal playback.

Note

- Audio (language) setting cannot be changed while using this mode.
- This feature may not work at some point in a disc.
- Audio is PCM during rapid playback mode except when using digital audio connection.
- When using digital audio connection (COAXIAL), the LPCM sound (2 channel) will be output.

SPECIAL PLAYBACK

Step by Step Playback



1) During playback, press [PAUSE III].

Playback will be paused and sound will be muted.

2) Press [▶▶] repeatedly.

Playback will advance one frame (or step) at a time when you press [▶▶] with the sound muted.

To play back step by step backward:

Press [◀◀] repeatedly.

Every time you press the button, the playback will go backward by one frame.

- Press and hold [◀◀] / [▶▶] to reverse/ advance continuously.

3) Press [▶] to return to the normal playback.

Note

- Only step by step forward playback is available for playing back video CD.

Slow Forward / Slow Reverse Playback



1) During playback, press [PAUSE III]. Then press [▶▶] or [◀◀].

Every time you press [▶▶] or [◀◀], approximate speed will be changed as follows. (The sound will remain muted.)



2) Press [▶] to return to the normal playback.

Note

- Forward/reverse speed will be indicated with icons as follows.

forward (approx. speed)

1/16x: [▶▶▶▶]

1/8x: [▶▶▶▶▶]

1/3x: [▶▶▶▶▶▶]

reverse (approx. speed)

1/16x: [◀◀◀◀]

1/8x: [◀◀◀◀◀]

1/4x: [◀◀◀◀◀◀]

- Only slow forward is available when playing back video CD.

Zoom



1) During playback, press [DISPLAY] to bring up the display menu.

2) Use [◀/▶] to select [Z] to display the selection menu.

e.g.) DVD-video

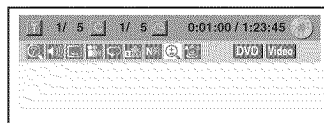

3) Use [▲/▼] to select a desired zoom factor to zoom, then press [OK].

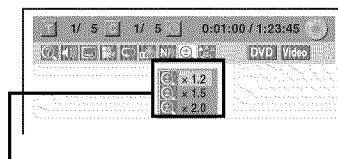

Zoom menu will appear.

There are four options

(x1.0, x1.2, x1.5 and x2.0), these are displayed excluding the current zoom rate.

Zoom area will be displayed.

4) Use [▲/▼/◀/▶] to select a desired zoom position, then press [OK].

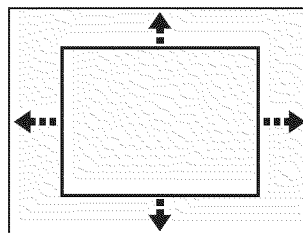

Zoom playback will start.

Note

- When selecting a smaller factor than the current one, the zoom area will not be displayed.
- To exit the zoom menu, press [RETURN] repeatedly at step 3.
- To cancel the zoom function, select "x1.0" using [▲/▼], then press [OK].
- You cannot slide the zoomed picture on some JPEG files.

SPECIAL PLAYBACK

Marker Setting



This feature allows you to assign a specific point on a disc to be called back later.

1) During playback, press [DISPLAY] to bring up the display menu.

If the display menu is already shown, skip to step 2.

2) Use [◀/▶] to select  to display the marker list.

e.g.) DVD-video

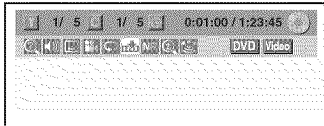

3) Use [▲ / ▼] to select a desired marker number. When it reaches the desired point, press [OK].

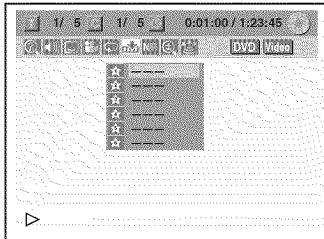

The title (track) number and the time will be displayed.

4) To return to the marker later:

Use [▲ / ▼] to select the desired marker number, then press [OK].

Note

- To clear a marker, select the marker number to be cleared, then press [CLEAR].
- All markers will be erased when you operate these operations listed below.
 - Opening the disc tray
 - Turning the unit to standby / off
 - Record on a recordable disc
- You can mark up to 6 points.
- Marker setting is not available when you play back the video CD with PBC function.

Repeat Playback

Available repeat function may vary depending the discs.

1) During playback press [DISPLAY] to bring up the display menu, then proceed to step 2), or press [REPEAT] then proceed to step 3).

If the display menu is already shown, skip to step 2.

2) Use [◀/▶] to select  to display the selection menu.

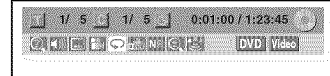

3) Use [▲ / ▼] to select a desired repeat type, then press [OK].

The selected repeat playback will start.

e.g.) DVD-video

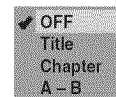

e.g.) audio CD, video CD



e.g.) MP3 / JPEG files

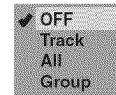

Title:

The current title will be played back repeatedly.

Chapter:

The current chapter will be played back repeatedly.

All:

The current disc will be played back repeatedly.

A-B:

Desired section can be played back repeatedly.

1) Use [▲ / ▼] to select "A-B", then press [OK].

2) Press [OK] at the desired starting point A.

3) Press [OK] at the desired ending point B.

Track:

The current track or file will be played back repeatedly.

Group:

The current folder will be played back repeatedly.

Note

- Point B for the repeat A-B playback should be set within the same title or track as point A.
- To cancel the repeat playback, select "OFF" at step 3. The repeat setting will also be canceled when you stop playback.
- You cannot select "Group" during the random playback.
- Repeat playback is not available when you play back the video CD with PBC function.
- During the A-B repeat, if you reaches the point A with any reverse playback, the reverse playback will be canceled and the A-B repeat playback resumes from point A.

SPECIAL PLAYBACK

Random Playback



You can play back a disc randomly instead of playing back in the original order.

- 1) Press [SETUP].
- 2) Use [▲ / ▼] to select "DISC Playback Mode", then press [OK].
"DISC Playback Mode" menu will appear.
For MP3, use [▲ / ▼] to select "Music", then press [OK].
For JPEG, use [▲ / ▼] to select "Photo", then press [OK].
- 3) Use [▲ / ▼] to select "Random Play", then press [OK].
Random playback will start.

Note

- To cancel random playback, press [STOP ■] twice during random playback. "OFF" appears on the TV screen.
- For video CD with PBC function, the PBC setting will be switched to off automatically when you start random playback.

Slide Show



You can select the display time between 5 seconds and 10 seconds.

- 1) Follow steps 1 and 2 in "Random Playback" on this page.
- 2) Use [▲ / ▼] to select "Slide Show", then press [OK].
- 3) Use [▲ / ▼] to select the display time, then press [OK].
- 4) Press [SETUP] to exit.

Note

- Large-size JPEG files take a few moments to be displayed.

Program Playback



You can program the disc to play back in your desired order.

- 1) Press [SETUP].
- 2) Use [▲ / ▼] to select "DISC Playback Mode", then press [OK].
"DISC Playback Mode" menu will appear.
- 3) Use [▲ / ▼] to select "Program Play", then press [OK].
- 4) Use [▲ / ▼] to select a desired track, then press [OK] or [▶].

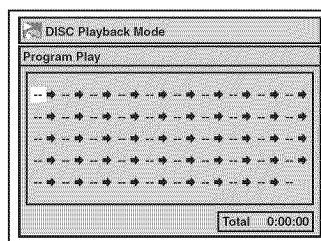

Repeat this step until you program all the desired tracks.

- 5) Press [PLAY ▶].

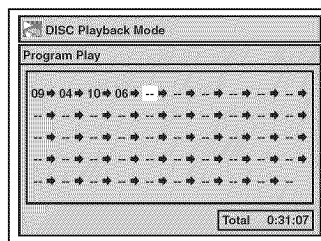

Program playback will start.

Note

- To erase tracks you selected, press [CLEAR] at step 4.
- You can make program settings up to 50 tracks.
- To cancel program playback, press [STOP ■] twice during program playback. "OFF" appears on the TV screen.
- You may also select a desired track using [the Number buttons] at step 4.
- For video CD with PBC function, the PBC setting will be switched to off automatically when you start program playback.

SEARCH

Title / Chapter Search



Using [◀◀] / [▶▶]

- 1) During playback, press [▶▶] to skip the current title or chapter and move to the next.

The title or chapter will move forward by one at a time.

• If there is no chapter in one title, the current title will be skipped.

To go back to the beginning of the current title or chapter, press [◀◀].

Press it repeatedly to go to the previous title or chapter. The title or chapter will move backward one at a time.

Using [DISPLAY]

- 1) During playback, press [DISPLAY] to bring up the display menu.

- 2) Use [◀/▶] to select , then press [OK].

e.g.) DVD-video

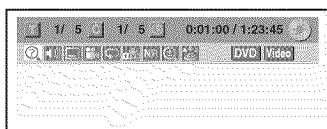

The number next to  will be highlighted.

- 3) Title:

Use [▲ / ▼] or [the Number buttons] to enter a desired title number to search, then press [OK].

Title search will start.

Chapter:

Press [▶] to move to the number next to  for chapter.

Use [▲ / ▼] or [the Number buttons] to enter a desired chapter number to search, then press [OK].

After the search, playback will start automatically.

Note

- In search mode display, total numbers of each search contents (title/chapter/time) are shown as a denominator.

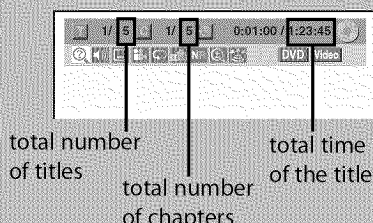

Track Search



Using [◀◀] / [▶▶]

- 1) During playback, press [▶▶] to skip the current track/file and move to the next.

The track/file will move forward one at a time.

To go back to the beginning of the current track/file, press [◀◀].

Press it repeatedly to go to the previous track/file. The track/file will move backward one at a time.

For JPEG files, press it once to go to the previous file.

Using [DISPLAY]

- 1) During playback, press [DISPLAY] to bring up the display menu.

If the display menu is already shown, skip to step 2.

- 2) Use [◀/▶] to select , then press [OK].

e.g.) audio CD

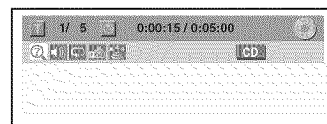

e.g.) MP3 files

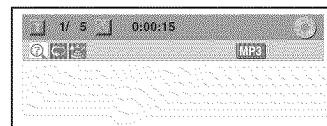

The number next to  will be highlighted.

- 3) Use [▲ / ▼] or [the Number buttons] to enter a desired track/file number to search, then press [OK].

After the search, playback will start automatically.

Note

- During CD playback you can enter a track number directly using [the Number buttons] for track search without displaying the menu.
- Track search using [DISPLAY] is not available when you play back the video CD with PBC function.

Time Search



1) **During playback, press [DISPLAY] to bring up the display menu.**
If the display menu is already shown, skip to step 2.

2) Use [◀/▶] to select , then press [OK].
e.g.) DVD-video

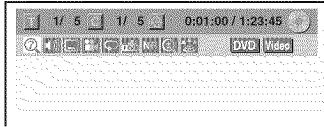

e.g.) audio CD

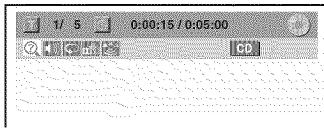

The number next to  will be highlighted.

To move to the number next to , Press [▶].

When time search is not available,  and time counter are not displayed.

3) Use [▲ / ▼ / ◀ / ▶] or [the Number buttons] to enter a desired time to search, then press [OK].
After the search, playback will start automatically.

Note

- Time search is available only in the same track, file or title.
- Time search is not available when you play back the video CD with PBC function.

SELECTING THE FORMAT OF AUDIO AND VIDEO

You can select the format of audio and video as you prefer depending on the contents of the disc you are playing back.

Switching Subtitles



DVD-video may have subtitles in 1 or more languages. Available subtitle languages can be found on the disc case. You can switch subtitle languages anytime during playback.

1) During playback, press [DISPLAY] to bring up the display menu.

2) Use [◀/▶] to select  to display the selection menu.

e.g.) DVD-video

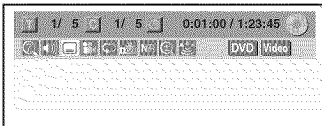

3) Use [▲/▼] to select a desired subtitle language, then press [OK].

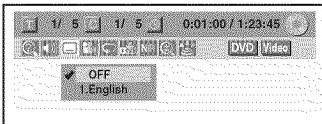

Subtitle will be displayed in the selected language. When selecting "OFF", subtitle will disappear.

Note

- Some discs will only allow you to change the subtitle from the disc menu. Press [TITLE] or [DISC MENU] to display the disc menu.
- If a 4-digit language code appears in the subtitle menu, refer to "LANGUAGE CODE" on page 101.

Switching Audio Soundtrack



When playing back a DVD-video recorded with 2 or more soundtracks (these are often in different languages), you can switch them during playback.

When playing back video CD, audio CD you can switch "L/R"(stereo), "L"(left) or "R"(right).

1) During playback press [DISPLAY] to bring up the display menu, then proceed to step 2), or press [AUDIO] then proceed to step 3).

- If the display menu is already shown, skip to step 2.

2) Use [◀/▶] to select  to display the selection menu.

3) Use [▲/▼] to select a desired audio soundtrack or audio channel, then press [OK].

For DVD-video

- Audio soundtrack will switch.

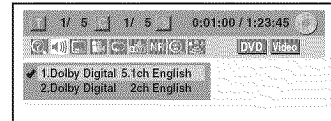

- If the title contains both main and sub audio, you can further select "L" (main), "R" (sub), or "L/R" (mixed of main and sub).

For audio CD, video CD

- Audio channel will switch.

e.g.) audio CD

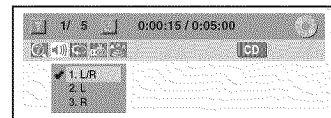

Note

- Some discs will only allow you to change the soundtrack from the disc menu. Press [TITLE] or [DISC MENU] to display the disc menu.

SELECTING THE FORMAT OF AUDIO AND VIDEO

Switching Virtual Surround System



You can enjoy stereophonic virtual space through your existing 2 channel stereo system.

1) During playback, press [DISPLAY] to bring up the display menu.

If the display menu is already shown, skip to step 2.

2) Use [◀/▶] to select  to display the selection menu.

e.g.) DVD-video

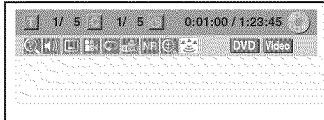

3) Use [▲/▼] to select "OFF", "Type 1" or "Type 2", then press [OK].

e.g.) DVD-video

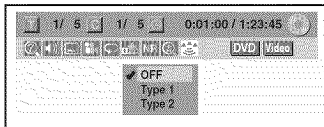

OFF : no effect

Type 1 : natural effect

Type 2 : emphasized effect

Note

- Select "OFF" in a case sound is distorted.
- The setting will be kept even when the unit is turned off .

Switching Camera Angles



Some DVD-video have scenes shot from 2 or more angles. Angle information should be on the disc case if the disc contains multi-angle scenes.

1) During playback, press [DISPLAY] to bring up the display menu.

2) Use [◀/▶] to select , then press [OK].

e.g.) DVD-video

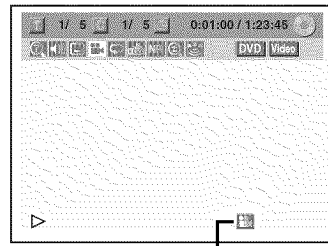

Angle icon appears when a switching camera angle is available.

Angle will switch each time you press [OK].

Note

- Angle icon does not appear on the TV screen in a case you set "Angle Icon" to "OFF" in "Playback" menu. Refer to page 87.

Reducing Block Noise



This function reduces noise in the playback picture.

1) During playback, press [DISPLAY] to bring up the display menu.

2) Use [◀/▶] to select  to display the selection menu.

e.g.) DVD-video

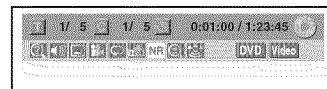

3) Use [▲/▼] to select a desired option, then press [OK].

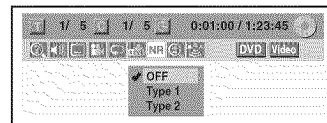

Your setting will be activated.

OFF : When playing back titles with a few noises such as DVD-video.

Type 1 : For the titles recorded in long time mode such as EP or SLP mode.

Type 2 : Same as type 1, only more effective.

INFORMATION ON DISC EDITING

Guide to a Title List

Title list allows you to check the titles recorded on the disc easily. You can choose a title to play back from this list and easily edit the titles as you prefer.

Press [DVD], then press [TITLE].

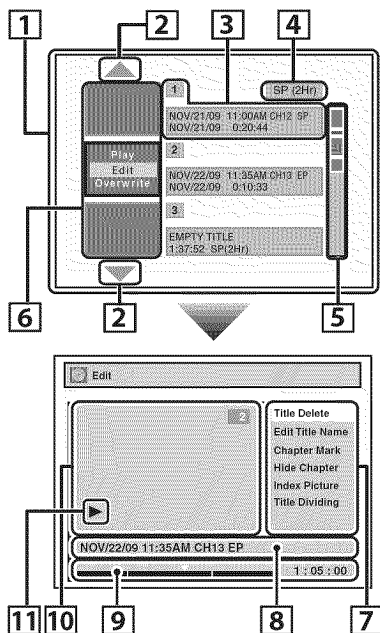

- 1. Title list:** List of the titles recorded on the disc, and their information.
- 2. Arrow:** Indicating there is a previous / next page.
- 3. Title information:** On the first line, title name (editable) is displayed. On the second line, the date recorded and length of the title are displayed.
Empty title: The portion of the disc where there is no recordings are made. As for the empty title, available recording time by the selected recording mode is displayed on the second line.
- 4. Recording mode:** Currently selected recording mode is displayed here.
- 5. Capacity indicator:** Indicating the position and the amount of each title in the disc. The portion for the selected title is highlighted.
- 6. Thumbnails:** A cut from the recorded content is displayed here.
- 7. Submenu:** Submenus for the selected menu are displayed here.
- 8. Title name (editable):** If you do not name the title, the recorded date, time, channel, and the recording mode are displayed here.
- 9. Progress bar:** Indicating the progress of the playback.
- 10. Preview window:** Preview of the selected title is displayed here.
- 11. Playback status:** Indicating the current playback status of the selected title.

Press [STOP ■] to exit the title list.

Editing Discs

You can edit discs for the following items. Be sure that once you edit titles, they will not remain as original.

- Deleting a Title (Refer to page 71.)
- Putting Names on Titles (Refer to page 72.)
- Setting Chapter Marks (Refer to page 73.)
- Clearing Chapter Marks (Refer to pages 74-75.)
- Hiding Chapters (Refer to page 76.)
- Setting Pictures for Thumbnails (Refer to page 77.)
- Dividing a Title (DVD+RW/DVD-RW only) (Refer to page 78.)
- Putting Name on Disc (Refer to page 79.)
- Erasing Disc (Refer to page 80.)
- Making Edits Compatible (Refer to page 81.)

Note

- When selecting "Edit" on pop-up menu of the title list and edit the title, the title list is displayed after writing the edited contents onto the disc.
- The capacity indicator in the right side of the title list may not indicate the precise capacity in the disc.
- The capacity indicator may not indicate the capacity for the titles of which recording time is short.
- Once you have finalized a DVD+R/ DVD-R, you cannot edit or record anything on that disc.

EDITING DISCS

Deleting a Title

You can delete a title which you do not need anymore. Please be advised that the titles once deleted cannot be brought back to the disc.

For DVD+RW/DVD-RW, when the last recorded title in the title list is deleted, the available disc space to record on will be increased. For DVD+R/DVD-R, the disc space to record on will not be changed.

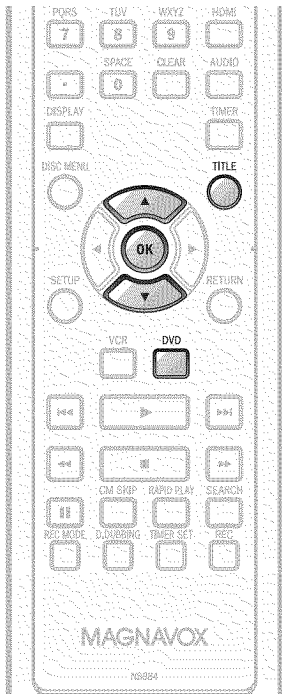

1 Press [DVD] first.
Press [TITLE].

2 Use [▲ / ▼] to select a desired title, then press [OK].

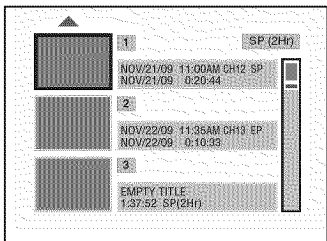

Note

- Deleted part of the titles in the capacity indicator changes in color.
- As for DVD+RW/DVD-RW if you delete the title, deleted title will be displayed as "EMPTY TITLE".

3 Use [▲ / ▼] to select "Edit", then press [OK].

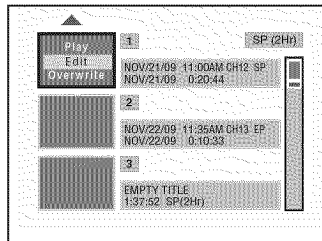

4 Use [▲ / ▼] to select "Title Delete", then press [OK].

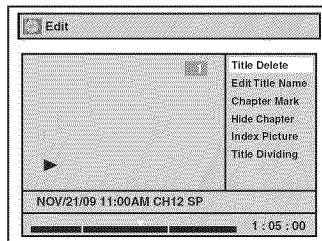

Confirmation message will appear.

5 Use [▲ / ▼] to select "Yes", then press [OK].

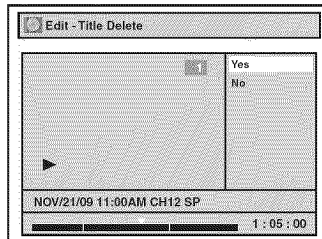

After that, "Are you sure?" will appear, select "Yes" and then press [OK].

Title will be deleted.

Data will be written onto the disc momentarily. e.g.) DVD+R/DVD-RW-R

Please finalize the disc when the writing is completed before playing back on other DVD players.

Writing to Disc [Progress Bar] 90%

This operation may take a while to be completed.

After editing is complete, the title list will appear. e.g.) DVD+RW/DVD-RW

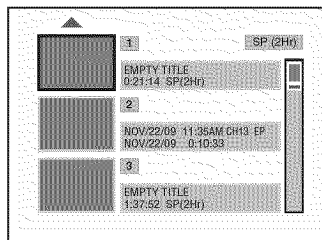

Putting Names on Titles

You can put title names on the titles and change the names from this menu.

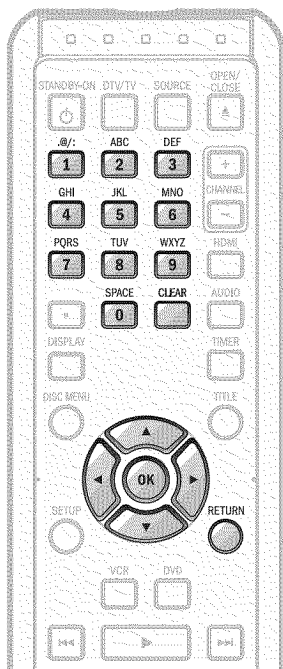

1 Follow steps 1 to 3 in “Deleting a Title” on page 71 to display “Edit” menu.

2 Use [▲ / ▼] to select “Edit Title Name”, then press [OK].

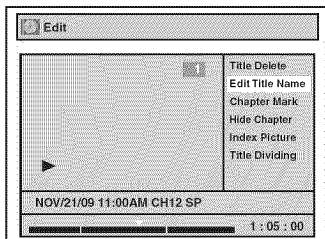

3 To enter a title name, follow the steps of “Guide to Edit Title Name” on this page.

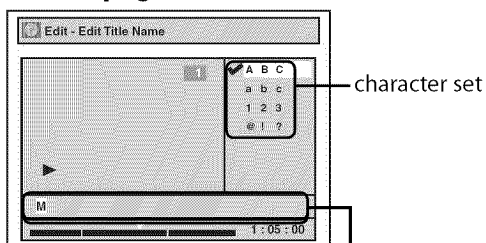

area for entering title names

4 Use [▲ / ▼] to select “Yes”, then press [OK].

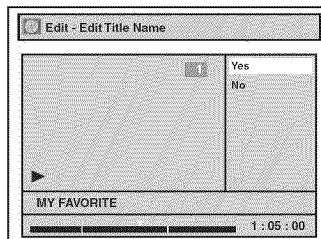

The name you entered will be activated for the title.

5 After this operation is completed, press [RETURN] to exit. Data will be written onto the disc momentarily.

This operation may take a while to be completed.

Guide to Edit Title Name

- Use [▲ / ▼] to select a desired character set, then press [OK].
- Follow the list below, use [the Number buttons] repeatedly until the desired letter appears. When you finish entering a title name, press [OK].

Select Press	ABC	abc	123	@ ! ?
[0]	<space>	<space>	0	<space>
[1]	(*1)	(*1)	1	! " # \$ % & ' () * + , - . / : ; < = > ? @ [] ^ _ { }
[2]	ABC	abc	2	(*2)
[3]	DEF	def	3	(*2)
[4]	GHI	ghi	4	(*2)
[5]	JKL	jkl	5	(*2)
[6]	MNO	mno	6	(*2)
[7]	PQRS	pqrs	7	(*2)
[8]	TUV	tuv	8	(*2)
[9]	WXYZ	wxyz	9	(*2)

*1 Press [1], character set will be changed to “@ ! ?” mode automatically.

*2 Press [2] to [9], character set will be changed to the previous input mode automatically.

- To delete letters, press [CLEAR] repeatedly. Holding [CLEAR] to delete all letters.
- Use [◀ / ▶] to move the cursor to the left and right.
- You can enter up to 30 letters.

Note

- Undefined letters in a title name are shown by “*?”. If you delete them, adjoining letters may change to “*?” or other.

Setting Chapter Marks

You can put chapter marks in each title. Once a chapter is marked, you can use it for the chapter search feature.

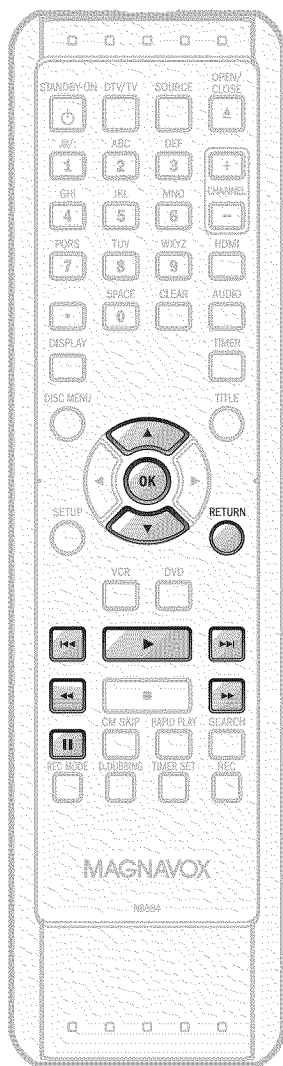

1 Follow steps 1 to 3 in “Deleting a Title” on page 71 to display “Edit” menu.

2 Use [▲ / ▼] to select “Chapter Mark”, then press [OK].
Submenu will appear.

3 Press [PLAY ►] and then [PAUSE ■] to decide the point at which you will create a new chapter mark.
• It is convenient to use [◀◀], [▶▶], [◀◀] and [▶▶] for finding the point to add a new chapter mark.

4 Use [▲ / ▼] to select “Add”, then press [OK].

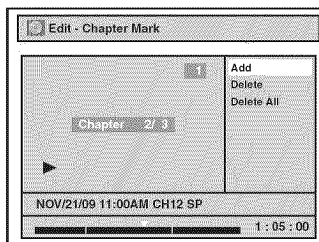

5 Use [▲ / ▼] to select “Yes”, then press [OK].

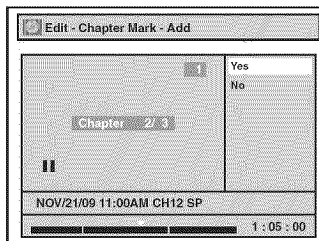

A new chapter mark will be added.

6 Press [RETURN] twice to exit.
Data will be written onto the disc momentarily.

This operation may take a while to be completed.

Note

- When the number of chapter marks in a title is 99 and the number of chapter marks in a disc is 254, chapter marks cannot be added.
- Besides the above-mentioned, it is not likely to be able to add according to recorded time and number of chapters.
- Remaining time of the disc may decrease when adding chapter marks or increase when clearing chapter marks depending on the recording time or edited contents.

Clearing Chapter Marks

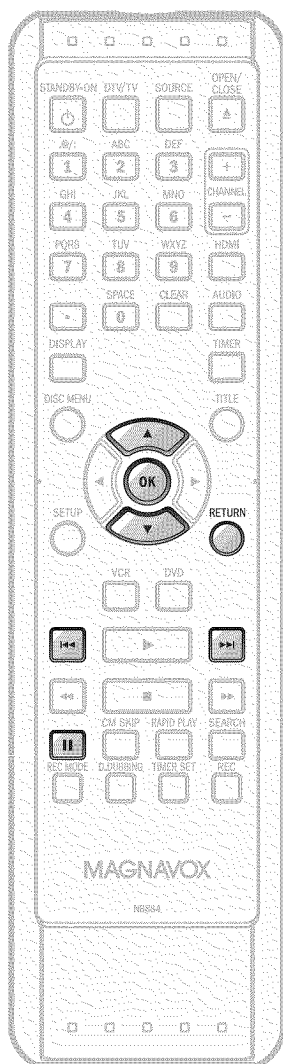

1 Follow steps 1 to 3 in “Deleting a Title” on page 71 to display “Edit” menu.

2 Use [▲ / ▼] to select “Chapter Mark”, then press [OK].
Submenu will appear.

3 Use [◀◀ / ▶▶] to select a chapter mark to be deleted, then press [PAUSE III].

Chapter mark number is displayed on the preview screen.
e.g.) DVD

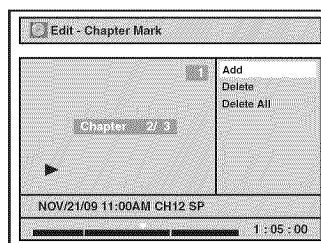

4 Use [▲ / ▼] to select “Delete”, then press [OK].

5 Use [▲ / ▼] to select “Yes”, then press [OK].

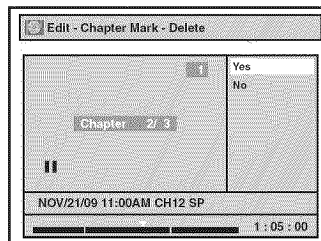

The selected chapter mark will be deleted.

6 Press [RETURN] twice to exit.
Data will be written onto the disc momentarily.

This operation may take a while to be completed.

Note

- Remaining time of the disc may decrease when adding chapter marks or increase when clearing chapter marks depending on the recording time or edited contents.
- You cannot delete the chapter mark 1.

Clearing Chapter Marks (cont'd)

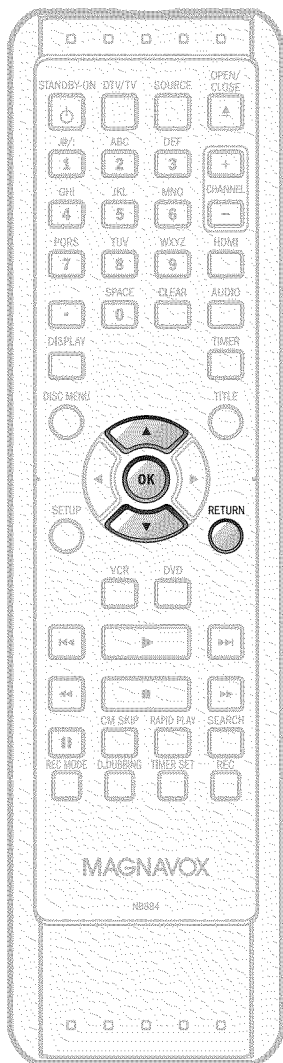

To delete all chapter marks:

- 1** Follow steps 1 to 3 in “Deleting a Title” on page 71 to display “Edit” menu.
- 2** Use [▲ / ▼] to select “Chapter Mark”, then press [OK].
Submenu will appear.
- 3** Use [▲ / ▼] to select “Delete All”, then press [OK].
- 4** Use [▲ / ▼] to select “Yes”, then press [OK].

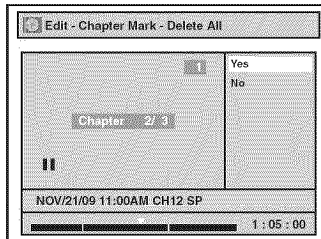

- 5** Use [▲ / ▼] to select “Yes”, then press [OK].

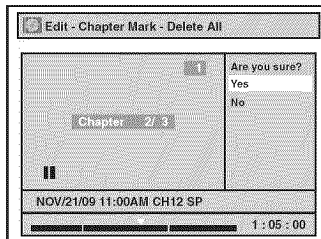

All chapter marks will be deleted.

- 6** Press [RETURN] twice to exit.
Data will be written onto the disc momentarily.

This operation may take a while to be completed.

Note

- Remaining time of the disc may decrease when adding chapter marks or increase when clearing chapter marks depending on the recording time or edited contents.

Hiding Chapters

You can hide chapters from the title list.
Hidden chapters are skipped during playback.

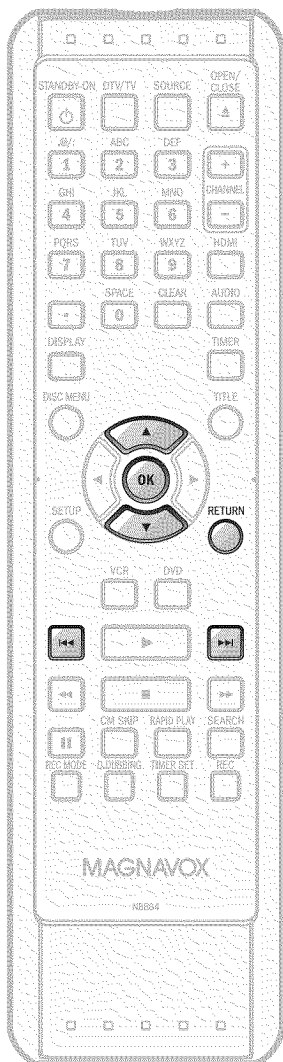

1 Follow steps 1 to 3 in “Deleting a Title” on page 71 to display “Edit” menu.

2 Use [▲ / ▼] to select “Hide Chapter”, then press [OK].
Submenu will appear.

3 Use [◀◀ / ▶▶] to decide the chapter to be hidden.

4 Use [▲ / ▼] to select “Hidden”, then press [OK].

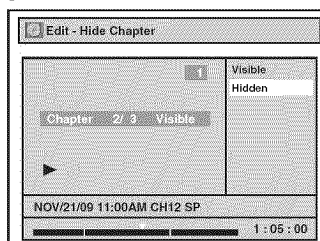

The chapter is now hidden.

5 After this operation is completed, press [RETURN] twice to exit.
Data will be written onto the disc momentarily.

This operation may take a while to be completed.

If you want hidden chapters to be “Visible”, select the chapter to be shown. Then use [▲ / ▼] to select “Visible” at the step 4 on this page.

Data will be written onto the disc momentarily.
After that, title list is displayed.

Note

- “Hidden” will be displayed in the preview window while previewing the hidden chapter.
- When you make all chapters in the title “Hidden”, “Hidden” is displayed in a thumbnail of the title list.

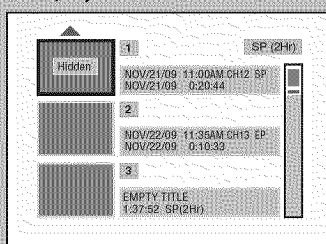

Setting Pictures for Thumbnails

You can set your desired scene as a thumbnail for each title.

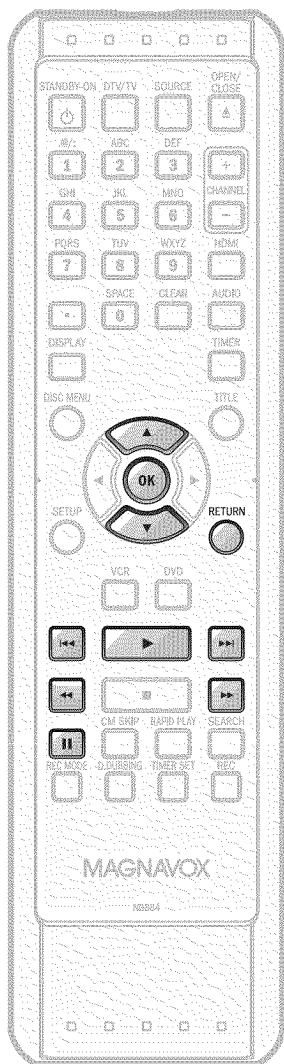

- 1** Follow steps 1 to 3 in “Deleting a Title” on page 71 to display “Edit” menu.
- 2** Use [◀◀], [▶▶], [◀], [▶], [PAUSE II] and [PLAY ▶] to decide the picture you want to select as a thumbnail.
- 3** Use [▲ / ▼] to select “Index Picture”, then press [OK].
- 4** Use [▲ / ▼] to select “Yes”, then press [OK].

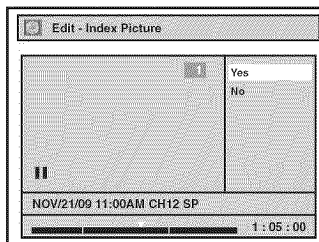

A picture for thumbnail will be set.

- 5** Press [RETURN] to exit.
Data will be written onto the disc momentarily.

This operation may take a while to be completed.

Note

- If the selected picture for a thumbnail is overwritten, the thumbnail is reset to the first scene of the title.

Dividing a Title



You can divide one title into 2 new titles.

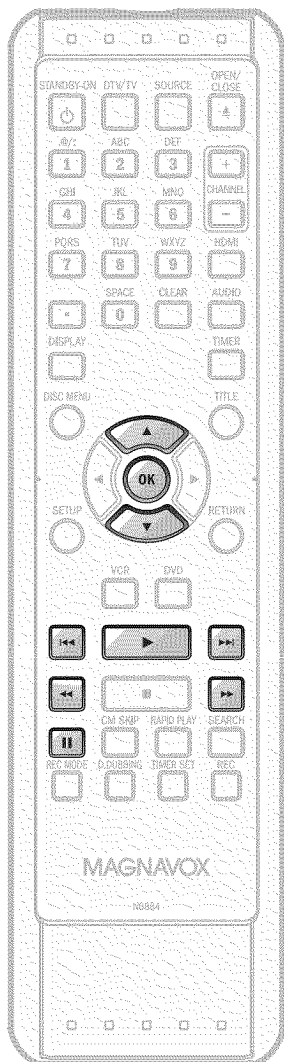

1 Follow steps 1 to 3 in “Deleting a Title” on page 71 to display “Edit” menu.

2 Use [◀◀], [▶▶], [◀◀], [▶▶], [PAUSE II] and [PLAY ▶] to decide the point at which you will divide the title.

3 Use [▲ / ▼] to select “Title Dividing”, then press [OK].

4 Use [▲ / ▼] to select “Yes”, then press [OK].

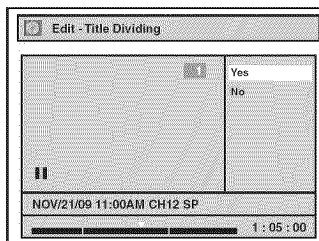

The title will be divided into 2 new titles. Both title names are identical, and thumbnails are reset to the first scene at this point.

Data will be written onto the disc momentarily.

This operation may take a while to be completed.

Note

- You cannot divide a title of the disc when the number of recording titles reaches the maximum of 49, and the number of recording chapters reaches the maximum of 254.

Putting Name on Disc

You can put a name on the disc and change it from this menu.

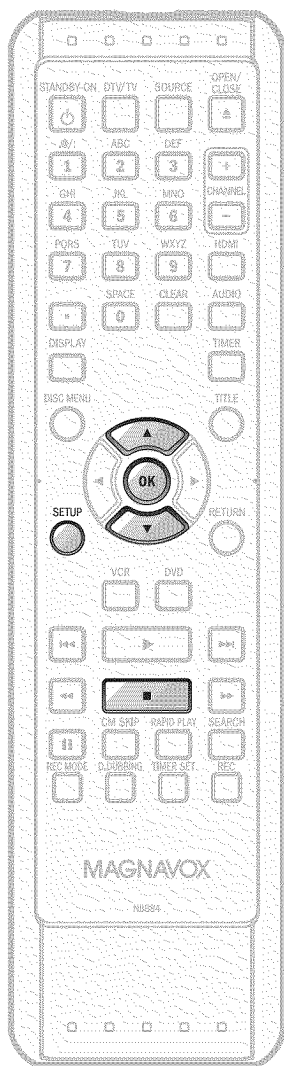

Press [STOP ■] if you are playing back a disc.

- 1** Press [SETUP].
- 2** Use [▲ / ▼] to select "Disc Edit", then press [OK].
- 3** Use [▲ / ▼] to select "Edit Disc Name", then press [OK].
e.g.) DVD+RW

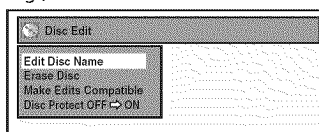

A window for entering a title name will appear.

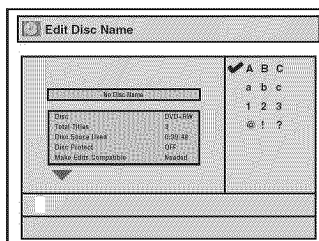

- 4** To enter a disc name, follow the steps of "Guide to Edit Title Name" on page 72.

When you finish entering a title name, press [OK].

- 5** Use [▲ / ▼] to select "Yes", then press [OK].

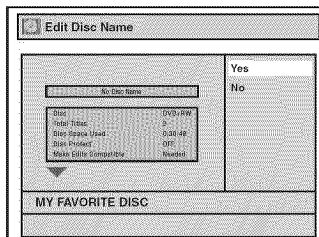

The name you entered will be activated for the title. Data will be written onto the disc momentarily.

This operation may take a while to be completed.

Note

- You cannot select "Disc Edit" when finalized DVD+R or DVD-R is inserted.

Erasing Disc



You can erase all titles on a disc.

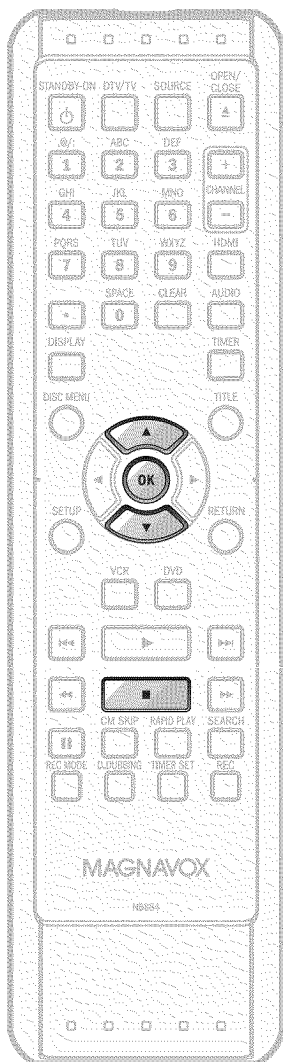

Press [STOP ■] if you are playing back a disc.

1 Follow steps 1 to 2 in “Putting Name on Disc” on page 79 to display “Disc Edit” menu.

2 Use [▲ / ▼] to select “Erase Disc”, then press [OK].
e.g.) DVD+RW

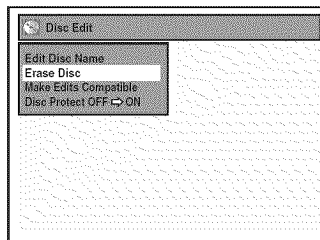

3 Use [▲ / ▼] to select “Yes”, then press [OK].

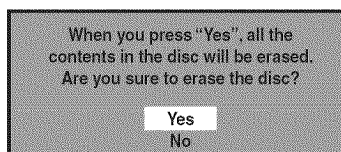

Data will be written onto the disc momentarily.

This operation may take a while to be completed.

The contents of the disc is now deleted.

Note

- When you select “Yes” at step 3, all contents of the disc will be erased.

Making Edits Compatible



If you have added or deleted chapters, or made chapters hidden, you must perform "Make Edits Compatible" to see those effects on other unit.

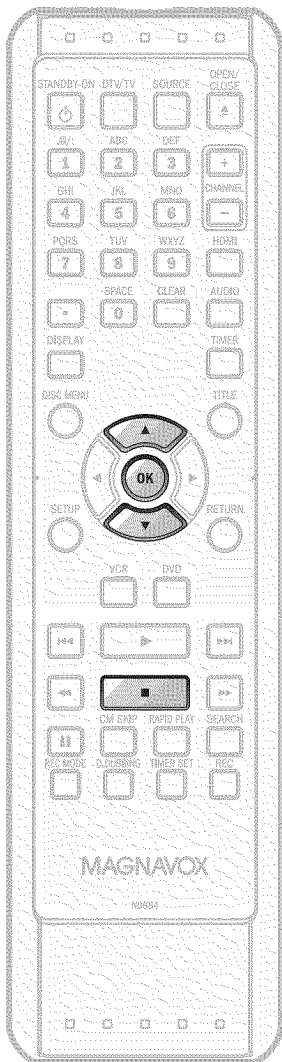

Press [STOP ■] if you are playing back a disc.

1 Follow steps 1 to 2 in "Putting Name on Disc" on page 79 to display "Disc Edit" menu.

2 Use [▲ / ▼] to select "Make Edits Compatible", then press [OK].

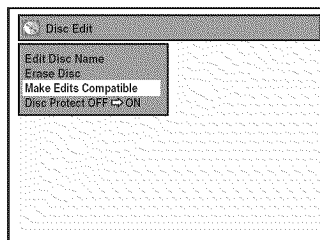

3 Use [▲ / ▼] to select "Yes", then press [OK].

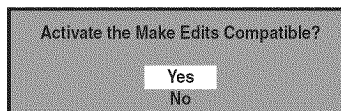

Data will be written onto the disc momentarily.

This operation may take a while to be completed.

LIST OF SETTINGS

The following table is the contents which you can set and the default setting.
Refer to the following table for useful operation.

Setup	Items (highlight is the default)		Contents		
General Setting	Playback → Pages 85-87	Parental Lock	OFF level 8 [Adult] to 1 [Kid Safe]	Set the parental level for DVD playback.	
		Disc Audio	Dynamic Range Control	ON OFF	Compressing the range of sound volume.
			PCM	48kHz 96kHz	Set whether the sound recorded in 96kHz will be down sampled in 48kHz.
				Dolby Digital	PCM Stream
		Disc Menu Language	English French Spanish Other	Set the language for disc menu language.	
		Audio Language	Original English French Spanish Other	Set the language for audio.	
		Subtitle Language	OFF English French Spanish Other	Set the language for subtitles.	
		Angle Icon	ON OFF	Set whether or not to display the angle icon.	
	Still Mode	Auto Field Frame	Set the type of still image in pausing playback.		
	Display → Pages 88-90	OSD Language	English Français Español	Set the language for OSD (on-screen display).	
		Screen Saver	OFF 1minute 5minutes 10minutes 15minutes	Set the idling time before the screen saver starts.	
		FL Dimmer	Auto Bright Dark	Set the brightness of the front panel display.	
		DTV CC → page 36	Caption Service	OFF Service1 Service2 Service3 Service4 Service5 Service6	Set the type of the DTV closed caption.
Recording → page 40			ON OFF	Set whether to record the DTV closed caption or not.	
CC Style → pages 37-38		User Setting	ON OFF	Set the CC style setting whether or not is effective.	
		Font Size	Large Middle Small	Set font size of the displayed caption.	
	Font Style	Style1 Style2 Style3 Style4 Style5 Style6 Style7 Style8	Set font style of the displayed caption.		
	Font Opacity	Solid Transparent Translucent Flash	Set the font opacity of the displayed caption.		

LIST OF SETTINGS

Setup	Items (highlight is the default)	Contents			
General Setting	Display → Pages 88-90	CC Style → pages 37-38	Font Color White Black Red Green Blue Yellow Magenta Cyan	Set the font color of the displayed caption.	
		Edge Type	None Raised Depressed Uniform L.Shadow R.Shadow	Set edge type of the displayed caption.	
		Edge Color	White Black Red Green Blue Yellow Magenta Cyan	Set edge color of the displayed caption.	
		Back Opacity	Solid Transparent Translucent Flash	Set back opacity of the displayed caption.	
		Back Color	White Black Red Green Blue Yellow Magenta Cyan	Set back color of the displayed caption.	
		V-Chip	MPAA Rating	X NC-17 R PG-13 PG G NR	Set the viewing limitation according to US movie ratings.
			TV Rating	TV-MA TV-14 TV-PG TV-G TV-Y7 TV-Y None	Set the viewing limitation according to US TV program ratings.
			Canadian English Rating	18+ 14+ PG G C8+ C E	Set the viewing limitation according to Canadian English language ratings.
	Canadian French Rating		18ans+ 16ans+ 13ans+ 8ans+ G E	Set the viewing limitation according to Canadian French language ratings.	
	Downloadable Rating		Block Setting Clear Downloadable Rating	To set the rating. Clear the downloadable rating information and its setting.	
	Change Password		Change the password.		
	Video → Page 91	Progressive Scan	ON OFF	Set to the progressive scan mode (set to "ON") or to the interlace scan mode (set to "OFF").	
		TV Aspect	4:3 Letter Box 4:3 Pan & Scan 16:9 Wide	Set a picture size according to aspect ratio of your TV.	

Introduction

Connections

Basic Setup

Recording

Playback

Editing

Function Setup

VCR Functions

Others

Español

LIST OF SETTINGS

Setup	Items (highlight is the default)		Contents		
General Setting	Video → Page 91	Video Input → Page 49	L1(Rear) Video In S-Video In	Set the video input type for the external input.	
			L2(Front) Video In S-Video In		
	Recording	Auto Chapter → Page 40	OFF 5 minutes 10 minutes 15 minutes 30 minutes 60 minutes	Insert chapter marks at even time interval.	
		Auto Finalize → Page 55	Disc Full ON OFF		Set the unit to finalize the disc automatically.
			End of Timer Rec ON OFF		
		Dubbing Mode → Pages 51-52	VCR → DVD DVD → VCR		Set the dubbing direction.
	Make Recording Compatible → Page 40	ON OFF	Set to prohibiting additional recording (OFF) or to replace the title list after recording (ON).		
	Clock → Pages 31-32	Clock Setting		Set the clock.	
		Auto Clock Setting	OFF Auto Manual	Set the clock automatically.	
		Daylight Saving Time	ON(MAR-NOV) ON(APR-OCT) OFF	Set the clock for the daylight saving time.	
	Channel → Pages 28-30	Auto Channel Preset	Antenna Cable (Analog) Cable (Analog / Digital)	Tune the channels automatically.	
		Manual Channel Preset		Tune the channels manually.	
		TV Audio Select → Page 35	Stereo SAP	Set the analog TV audio type for output and recording.	
	HDMI → Page 92	Format	RGB YCbCr	Set the color space for the HDMI output.	
		HDMI Audio	ON OFF	Set whether to output the HDMI audio signal or not.	
		RGB Range	Normal Enhanced	Set the black-white contrast level for HDMI RGB output.	
	Reset All → Page 93		Yes No	Set to the default setting.	

Note

- Your change to each setting stays on even when the power is off except for Dubbing Mode.
- An item which is not currently available is grayed in the settings.

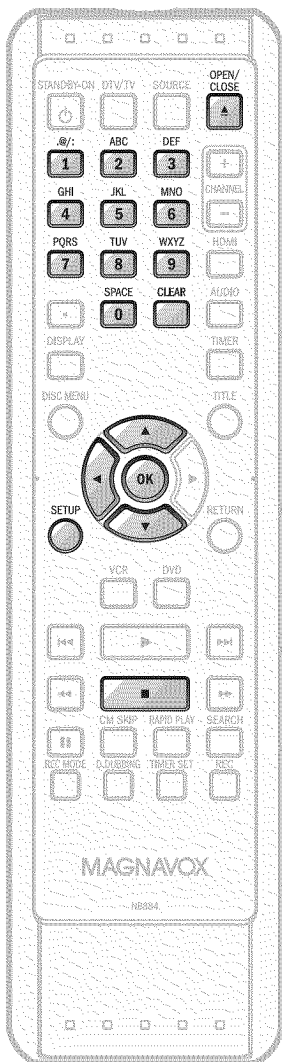

Press [STOP ■] if you are playing back a disc.

1 Press [SETUP] and use [▲ / ▼] to select "General Setting", then press [OK].

"General Setting" menu will appear.

2 Use [▲ / ▼] to select "Playback", then press [OK].

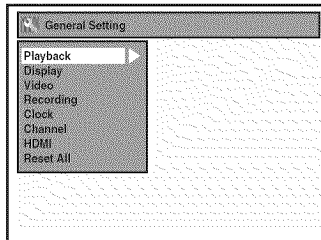

3 Use [▲ / ▼] to select a desired item, then press [OK].

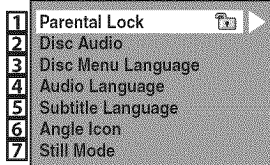

Submenu will appear.

4 Refer to **1** to **7** on pages 86-87 and set the selected item.

5 When you finish with setting, press [SETUP] to exit.

Playback (cont'd)

1 Parental Lock (Default: OFF)

Some DVD-video feature a parental lock level. Playback will stop if the ratings exceed the levels you set, it will require you to enter a password before the disc will playback. This feature prevents your children from viewing inappropriate material.

Use **[▲ / ▼]** to select the desired level, then press **[OK]**.

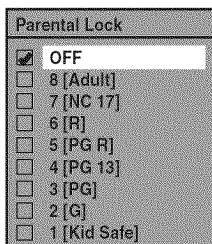

If a password has not been set yet, proceed to **A**.

If a password has been set already, proceed to **B**.

Note

- Parental lock function may not be available to some discs.
- With some DVD, it may be difficult to find if they are compatible with parental lock. Be sure to check if the parental lock function operates in the way that you have set.
- Record the password in case you forget it.
- If there is a DVD in the unit when you set up the parental lock, press **[OPEN/CLOSE ▲]** to activate the parental lock level.

A A password has not been set yet.

Use **[▲ / ▼]** to select "Yes". Use **[the Number buttons]** to enter a new password except for 4737, then press **[OK]**.

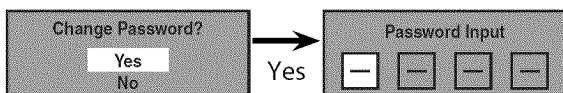

Your setting will be activated.

B A password has been set already.

• Use **[the Number buttons]** to enter the current password.



Your setting will be activated.

• If you want to change password, use **[▲ / ▼]** to select "Yes". Use **[the Number buttons]** to enter a new password except for 4737, then press **[OK]**.

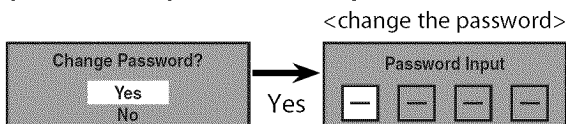

Your setting will be activated.

Note

- Press **[CLEAR]** to erase numbers entered incorrectly.
- When you forget the password or you want to clear all settings in "Parental Lock" menu, enter 4737 using **[the Number buttons]** in password input window. Password will be cleared and parental levels will be set to "OFF".

2 Disc Audio

Choose the appropriate audio setting for your external device.

It will only affect a disc playback.

Use **[▲ / ▼]** to select a desired item, then press **[OK]**.

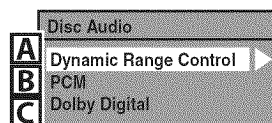

A Dynamic Range Control (Default : ON)

Set to "ON" to compress the range between soft and loud sounds.

Use **[▲ / ▼]** to select a setting, then press **[OK]**.

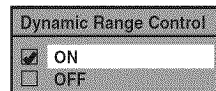

Your setting will be activated.

Note

- Dynamic range control function is available only on the discs which are recorded in the Dolby Digital format.

B PCM (Default : 48kHz)

Use **[▲ / ▼]** to select a setting, then press **[OK]**.

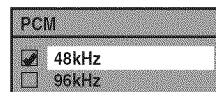

Your setting will be activated.

48kHz : If your amplifier/decoder is NOT compatible with 96kHz PCM, select "48kHz". 96kHz sound will be output in 48kHz.

96kHz : If your amplifier/decoder is compatible with 96kHz PCM, select "96kHz". 96kHz sound will be output.

Note

When playing back disc with copyright protection

- Even if you select "96kHz", the sound will be down sampled at 48kHz.

Playback (cont'd)

C Dolby Digital (Default : Stream)

Use **[▲ / ▼]** to select a setting, then press **[OK]**.

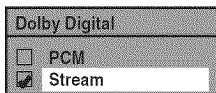

Your setting will be activated.

PCM : Converts the Dolby Digital into PCM (2 channel).
When your amplifier/decoder is NOT compatible with Dolby Digital, set to "PCM".

Stream : Outputs Dolby Digital signals
When your amplifier/decoder is compatible with Dolby Digital, set to "Stream".

3 Disc Menu Language (Default : English)

Set the language for disc menu.

Use **[▲ / ▼]** to select a setting, then press **[OK]**.

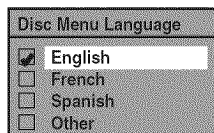

Your setting will be activated.

4 Audio Language (Default : Original)

Set the audio language.

Use **[▲ / ▼]** to select a setting, then press **[OK]**.

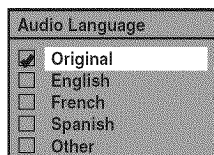

Your setting will be activated.

• When "Original" is selected, the audio language will be in the disc's default language.

5 Subtitle Language (Default : OFF)

Set the subtitle language.

Use **[▲ / ▼]** to select a setting, then press **[OK]**.

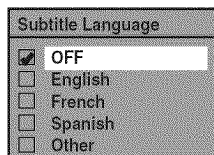

Your setting will be activated.

If "Other" is selected for **[3]** to **[5]**, press 4-digit code using **[the Number buttons]**.

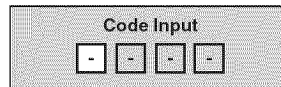

• When you finish entering the code, press **[OK]**. Refer to the language code table on page 101.

Note

- Only the languages supported by the disc can be selected.
- Audio language setting may not be available to some discs.
- You can change or switch off the subtitles on a DVD also from the disc menu if it is available.
- Press **[CLEAR]** or **[◀]** to erase numbers entered incorrectly.

6 Angle Icon (Default : ON)

Set to "ON" to show the angle icon during the playback.

Use **[▲ / ▼]** to select a setting, then press **[OK]**.

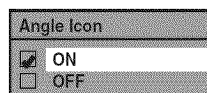

Your setting will be activated.

7 Still Mode (Default : Auto)

Select "Auto" usually.

Use **[▲ / ▼]** to select a setting, then press **[OK]**.

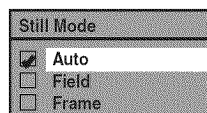

Your setting will be activated.

Auto : Optimum resolution setting ("Field" or "Frame") will be selected.

Field : Images in the still mode will be stabilized.

Frame : Images in the still mode will be highly defined.

Note

- Frame is 1 completed video image made up of 2 fields (There are 30 frames per second of NTSC video).

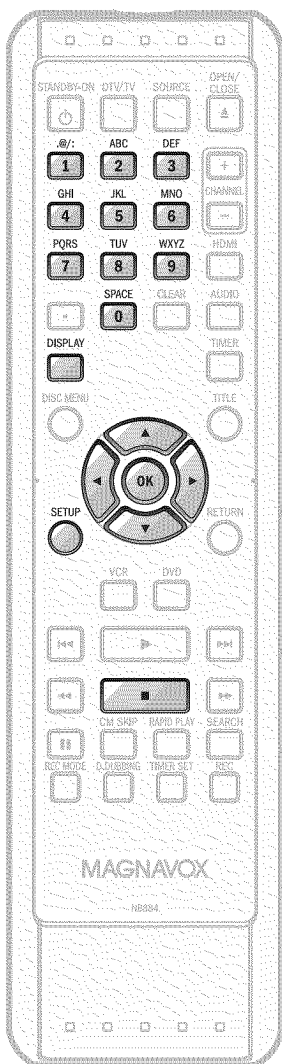

Press [STOP ■] if you are playing back a disc.

1 Press [SETUP] and use [▲ / ▼] to select "General Setting", then press [OK].

2 Use [▲ / ▼] to select "Display", then press [OK].

3 Use [▲ / ▼] to select a desired item, then press [OK].

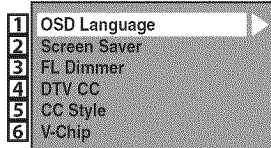

Selection menu will appear.

4 Refer to **1** to **6** on pages 88-90 and set the selected item.

• For **4** and **5** refer to pages 36-38.

5 When you finish with setting, press [SETUP] to exit.

1 OSD Language (Default : English)

Set the language for the on-screen display.

Use [▲ / ▼] to select a setting, then press [OK].

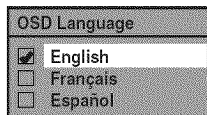

Your setting will be activated.

2 Screen Saver (Default : 10 minutes)

Set the time to activate the screen saver function on the TV screen.

Use [▲ / ▼] to select a setting, then press [OK].

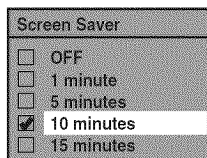

Your setting will be activated.

Display (cont'd)

3 FL Dimmer (Default: Bright)

Set the front panel display brightness.

Use **[▲ / ▼]** to select a setting, then press **[OK]**.

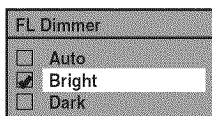

You can choose one from "Auto", "Bright" and "Dark". If "Auto" is selected, the display gets dark when the power is in the standby mode.

6 V-Chip

With the V-chip system in this unit, you can set the viewing limitation for the analog/digital TV programs received from the tuner or recorded on DVDs to prevent your children from watching inappropriate programs. If the unit detects a blocked program, a restriction message appears and you are not allowed to view or record the program.

1) Use **[the Number buttons]** to enter the access password.

If you have not set the password, first, use **[the Number buttons]** to set the access password, then press **[OK]**. The number you entered will be stored as the access password.

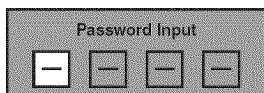

2) Use **[▲ / ▼]** to select a desired item, then press **[OK]**.

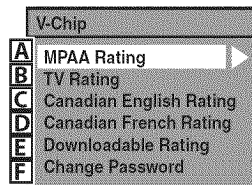

Note

- When you record a TV program blocked by the v-chip settings on the cassette tape, the audio/video signal of the blocked part cannot be recorded properly. No audio/video signal will be output when playing back that part.
- When you press **[DISPLAY]** while playing back the blocked part on the cassette tape, the counter display will not be shown properly. This is not a malfunction.

A MPAA Rating

B TV Rating

C Canadian English Rating

D Canadian French Rating

You can set the viewing limitation according to MPAA rating (US movie ratings), TV Rating (US TV program ratings), Canadian English Rating (Canadian English language Ratings), Canadian French Rating (Canadian French language Ratings).

1) Use **[▲ / ▼]** to select the desired rating, then press **[OK]** repeatedly to switch between view and block. When it is blocked a key icon will appear.

e.g.) MPAA rating

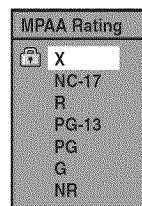

[MPAA Rating]

Rating	Category	
X	Mature audience only	higher ↑ ↓ lower
NC-17	No one under 17 admitted	
R	Restricted; under 17 requires accompanying parent or adult guardian	
PG-13	Unsuitable for children under 13	
PG	Parental guidance suggested	
G	General audience	
NR	No rating	

[TV Rating]

Rating	Category	
TV-MA	Mature audience only	higher ↑ ↓ lower
TV-14	Unsuitable for children under 14	
TV-PG	Parental guidance suggested	
TV-G	General audience	
TV-Y7	Appropriate for all children 7 and older	
TV-Y	Appropriate for all children	
None	No rating	

[Canadian English Rating]

Rating	Category	
18+	Adult audience only	higher ↑ ↓ lower
14+	Unsuitable for ages under 14	
PG	Parental guidance suggested	
G	General audience	
C8+	For children over 8	
C	For all children	
E	Exempt program	

SETUPS

Display (cont'd)

[Canadian French Rating]

Rating	Category	
18 ans+	Adult audience only	higher ↑ ↓ lower
16 ans+	Unsuitable for ages under 16	
13 ans+	Unsuitable for ages under 13	
8 ans+	Unsuitable for ages under 8	
G	General audience	
E	Exempt program	

As for TV Rating's TV-MA, TV-14, TV-PG, or TV-Y7, you can further set the sub ratings to block specific elements of programming. Press [▲ / ▼ / ◀ / ▶] to select the desired rating or sub rating, then press [OK] repeatedly to switch between view and block. Sub rating status will appear on the side of the main rating.

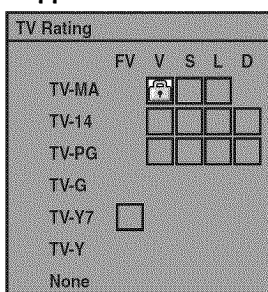

Sub Rating	Category	Rating
FV	Fantasy Violence	TV-Y7
V	Violence	TV-PG
S	Sexual Situation	TV-14
L	Coarse Language	TV-MA
D	Suggestive Dialogue	TV-PG, TV-14

Note

- Changing the main rating to block or view automatically changes all its sub ratings to the same (block or view).

E Downloadable Rating

Set the rating system via digital broadcasting, or clear the downloaded ratings.

If the broadcasting signal does not have the downloadable rating information, the message below will appear.

Downloadable Rating is currently not available.

- This message will also appear when you try to access "Downloadable Rating" after you have cleared the downloadable rating information, and the new information has not been downloaded since.

To set the rating:

Use [▲ / ▼] to select "Block Setting" then press [OK] to show the various types of ratings. Use [▲ / ▼] to select a desired rating to set, then press [OK] to show the levels for the rating. Use [▲ / ▼] to select a level, then press [OK] to switch between view or block. If you set one level to block, a key icon will appear and all the higher levels will be blocked automatically.

To clear the downloadable rating information and its setting:

Use [▲ / ▼] to select "Clear Downloadable Rating", then press [OK].

F Change Password

Change the current password.

Use [the Number Buttons] to enter new access password.

Note

- When you forget the access password at step 1), enter 4737 using [the Number buttons] in the password input window. Password will be cleared.
- Depending on the type of rating system, you may set the levels individually.

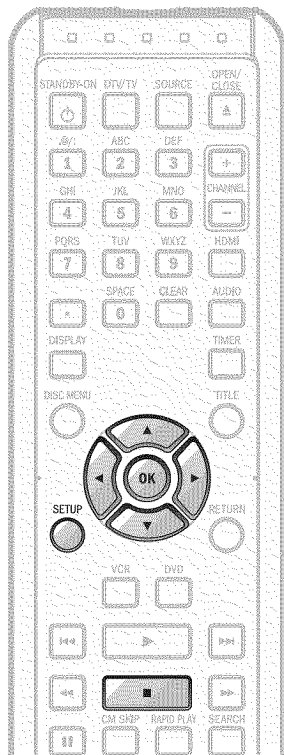

Press [STOP ■] if you are playing back a disc.

1 Press [SETUP] and use [▲ / ▼] to select "General Setting", then press [OK].

2 Use [▲ / ▼] to select "Video", then press [OK].

3 Use [▲ / ▼] to select a desired item, then press [OK].

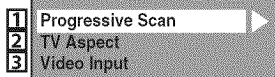

Submenu will appear.

4 Refer to **1** to **2** on this page and set the selected item.

• For **3** refer to page 49.

5 When you finish with setting, press [SETUP] to exit.

1 Progressive Scan (Default : OFF)

This unit is compatible with the progressive scan system. The feature provides you with the higher definition images than the traditional output system does. To utilize this feature, you must set progressive scan mode to "ON".

1) Use [▲ / ▼] to select "ON", then press [OK].

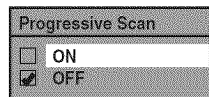

2) Use [◀ / ▶] to select "Yes", then press [OK].

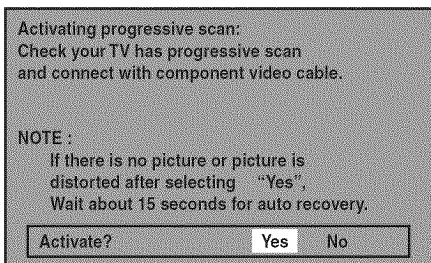

3) Use [▲ / ▼] to select "Yes" within 15 seconds, then press [OK].

Your setting will be activated.

Note

- If your TV is compatible with progressive scan (525p / 480p), you are recommended to use the HDMI or component video cable (commercially available) to connect this unit to the TV. (Refer to pages 16-17.) If not, use the RCA video cable and set the progressive scan to "OFF" or press and hold [SETUP] for more than 3 seconds during DVD playback.
- When selecting "No" or not pressing any buttons on the unit or remote control within 15 seconds at step 3, progressive scan remains to be "OFF" (interlace scan).

2 TV Aspect (Default: 4:3 Letter Box)

You can select the TV aspect ratio to match the formats of what you are playing back or watching digital TV broadcasting with the unit and your TV screen (4:3 standard or 16:9 widescreen TV).

Use [▲ / ▼] to select a setting, then press [OK].

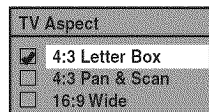

If you have a standard TV:

Select "4:3 Letter Box", so that black bars appear on the top and bottom of the TV screen when playing back a wide-screen picture. Select "4:3 Pan & Scan" for a full height picture with both sides trimmed when playing back wide-screen picture.

If you have a widescreen TV:

Select "16:9 Wide".

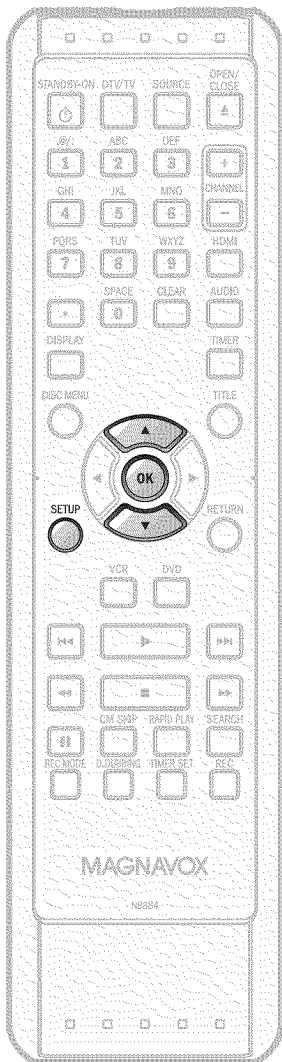

1 Press [SETUP] in stop mode and use [▲ / ▼] to select “General Setting”, then press [OK].

2 Use [▲ / ▼] to select “HDMI”, then press [OK].

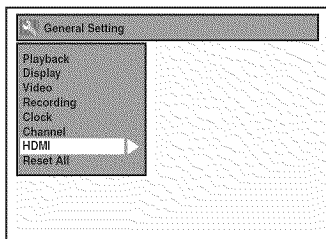

- You cannot select HDMI when an HDMI cable is not connected and the items are shown in grey color.

3 Use [▲ / ▼] to select a desired item, then press [OK].

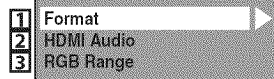

4 When you finish with the setting, press [SETUP] to exit.

1 Format (Default : RGB)

You can select the color space for HDMI output. Set the appropriate color space for your display device.

Use [▲ / ▼] to select a setting, then press [OK].

- When the connected device is not compatible with the Y/Cb/Cr, HDMI signal is output as RGB regardless of the setting.

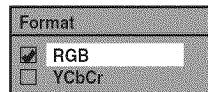

Your setting will be activated.

2 HDMI Audio (Default : ON)

If you do not want to output the audio through HDMI (when you digitally output the audio through the COAXIAL DIGITAL AUDIO OUT jack to your audio system, etc.), you can set the HDMI audio output off.

Use [▲ / ▼] to select a setting, then press [OK].

- Set to “OFF” when the HDMI sound is not output.

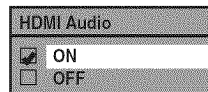

Your setting will be activated.

3 RGB Range (Default : Normal)

You can adjust the RGB range to make the dark areas of the HDMI images brighter.

Use [▲ / ▼] to select a setting, then press [OK].

- Select “Enhanced” if the black-white contrast is not clear.
- This setting is effective only for HDMI RGB output.

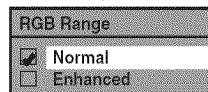

Your setting will be activated.

Reset All

Reset the setting to default.

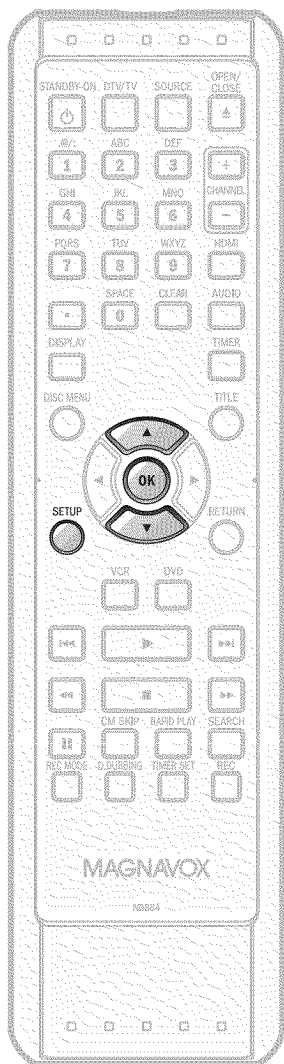

1 Press [SETUP] and use [▲ / ▼] to select “General Setting”, then press [OK].

“General Setting” menu will appear.

2 Use [▲ / ▼] to select “Reset All”, then press [OK].

3 Select “Yes” using [▲ / ▼], then press [OK].

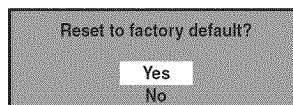

4 Select “Yes” again using [▲ / ▼], then press [OK].

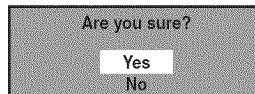

Your setting in recording will be initialized.

Note

- The settings listed below will remain unchanged even after resetting to the factory default.
- OSD language setting
- Channel setting
- Clock setting
- Parental lock setting
- V-chip setting
- Timer programming information

VCR FUNCTIONS

Information on VCR Functions

Caution on using S-video, component, or HDMI connection for VCR:

- Only the playback audio / video are available with these connections.
- Under the condition listed below, the playback image cannot be viewed. Use the standard video connection, in such case;
 - during DVD recording.
- HDMI video resolution cannot be changed when the unit is in VCR mode.

Playback



Press [VCR] first.

- 1) Insert a prerecorded tape (refer to page 26 on how to insert a cassette tape).
- 2) Press [PLAY ►] to start playback.
- 3) Press [STOP ■] to stop playback.

To pause playback:

Press [PAUSE ■■].

Playback will pause and sound will be muted.

To resume playback:

Press [PLAY ►].

Note

- When a cassette tape without erase-protection tab is inserted, the unit will start playback automatically.
- Tracking will be automatically adjusted upon playback. To adjust the tracking manually, press [CHANNEL + / -] on the remote control.
- S-VHS cassette tape is not available on this unit.
- Playback will stop when you change the output mode.

Recording



Press [VCR] first.

- 1) Insert a recordable tape with an erase-protection tab intact.

Accidental erasure prevention

To prevent accidental recording on a recorded cassette tape, remove its erase-protection tab. To record on it later, cover the hole with cellophane tape.

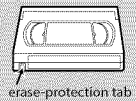

- 2) Select the recording mode using [REC MODE].

- The desired recording mode is selected in SP (standard play) or SLP (super long play) mode by pressing [REC MODE].

Recording mode:

Tape speed	Recording / playback time		
	Type of tape	T60	T120
SP mode	1hour	2hours	2-2/3hours
SLP mode	3hours	6hours	8hours

- 3) Select stereo or SAP. Refer to page 35.

- 4) Select the desired channel to record using [CHANNEL + / -] or [the Number buttons].

- 5) Press [REC] to start recording.

Press [STOP ■] to stop the recording.

To pause recording:

Press [PAUSE ■■].

To resume recording:

Press [PAUSE ■■] or [REC].

After the unit has been in pause mode for 5 minutes, it will stop automatically to protect the tape and the video head from damage.

- Refer to pages 43-46 for instructions on timer recording.

Note

- This function is available only when the unit is connected by the VIDEO OUT jack.

VCR FUNCTIONS

One-touch Timer Recording (OTR)



This feature allows you to set the recording length simply by pressing [REC] on the remote control.

Press [VCR] first.

- 1) Insert a recordable tape with an erase-protection tab intact.
- 2) Select the recording mode using [REC MODE].
(Refer to "Note for DVD to VCR duplication" on page 52 and "Recording" on page 94.)
- 3) Select stereo or SAP. Refer to page 35.
- 4) Select the desired channel to record using [CHANNEL + / -] or [the Number buttons].
- 5) Press [REC] to begin the one-touch timer recording.
You can select a fixed recording time by pressing [REC] repeatedly.

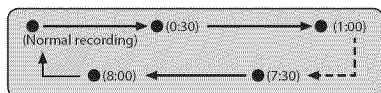

When the one-touch timer recording is finished, the unit will turn to the standby mode automatically.

To change the recording length during the one-touch timer recording:

Press [REC] repeatedly until the desired length appear.

To cancel the one-touch timer recording within the specified time:

Press [STOP ■].

Note

- The remaining recording time will be displayed on the front panel display during one-touch timer recording. Press [DISPLAY] to see it on the TV screen.
- **You cannot pause the one-touch timer recording.**
- If VCR one-touch timer recording is completed during DVD playback or recording, the VCR will be in stop mode and the DVD keeps the current mode.
- Unlike a timer recording, you can perform the following operations during the one-touch timer recording.
 - Turning the power to the standby mode to stop one-touch timer recording.
 - Using [REC] or [STOP ■] on the remote control.
- When the one-touch timer recording is finished and the power is in the standby mode, the unit will switch to the timer standby mode automatically if a timer recording has been programmed. Press [TIMER SET] to cancel the timer standby mode for using the unit continuously.
- This function is available only when the unit is connected by the VIDEO OUT jack.

Index Search



An index mark will be assigned at the beginning of each recording you make. You may skip to a specific marked point by following the steps below.

Press [VCR] first.

- 1) Press [SEARCH] so that "INDEX SEARCH" menu appears.
- 2) Using [the Number buttons], enter the number of recordings you wish to skip within 30 seconds.

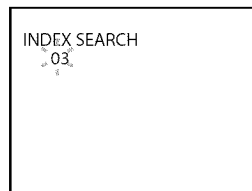

- 3) Press [◀], [▶] to start index search.

If you want to go in the forward direction, press [▶].

If you want to go in the reverse direction, press [◀].

After index search, the VCR will play back the cassette tape automatically.

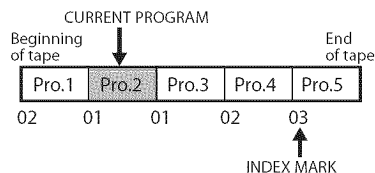

Note

- You can make the index mark up to 20.
- This function is available only when the unit is connected by the VIDEO OUT jack.

VCR FUNCTIONS

Time Search



This feature allows you to go to a specific point on a cassette tape by entering the exact amount of time you wish to skip in order to reach the point.

Press [VCR] first.

1) Press [SEARCH] repeatedly so that "TIME SEARCH" menu appears.

2) Using [the Number buttons], enter your desired time to skip within 30 seconds.

You can set the time up to 9:59.

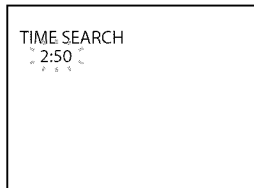

3) Press [◀◀], [▶▶] to start time search.

If you want to go in the forward direction, press [▶▶].

If you want to go in the reverse direction, press [◀◀].

After time search, the unit will play back the cassette tape automatically.

Note

- Index search and time search are not available during recording.
- Press [STOP ■] to stop the search.
- If the end of the cassette tape is reached during search, this unit will cancel the search and rewind the cassette tape.
- This function is available only when the unit is connected by the VIDEO OUT jack.

Other Operations



Press [VCR] first.

Fast forward:

When the unit is in stop mode, press [▶▶] to fast forward the cassette tape.

Rewind:

When the unit is in stop mode, press [◀◀] to rewind the cassette tape.

To cue or review picture during playback (picture search):

Press [◀◀], [▶▶] during playback.

Press it again and the unit will search in super high speed. (in the SLP mode only)

To freeze the picture on TV screen during playback (still mode):

Press [PAUSE ■]. Each time you press the button, the picture will be forwarded by one frame.

If the picture begins to vibrate vertically during the still mode, stabilize the picture by pressing [CHANNEL + / -] on remote control.

If the picture is distorted or rolling vertically, adjust the vertical hold control on your TV, if equipped.

Counter reset:

Press [CLEAR] to reset the counter to "0:00:00".

To playback in slow motion:

Press [PAUSE ■] during playback, then press [▶▶].

Press [▶▶] or [◀◀] repeatedly to select the desired speed.

Automatic rewind:

When a cassette tape is played back or fast forwarded to its end, the cassette tape will rewind to the beginning, stop and eject itself.

When you playback a cassette tape recorded in Hi-Fi stereo:

Press [AUDIO] on the remote control to select Hi-Fi or MONO for playback sound mode.

- If you have connected a stereo TV to this unit, select "HIFI".
- If you have connected a monaural TV to this unit, select "MONO".

Your Selection	HIFI		MONO
	L-channel	R-channel	
Type of recorded tape			
non Hi-Fi tapes	Monaural	Monaural	Monaural
Hi-Fi tapes recorded in Hi-Fi stereo	L	R	L+R
Hi-Fi tapes recorded main audio program	Main audio program	Main audio program	Main audio program
Hi-Fi tapes recorded second audio program	Second audio program	Second audio program	Second audio program

Note

- Still/slow mode will stop after 5 minutes to prevent damage to the cassette tape and the video head.
- To return to playback from the picture search/still/slow mode, press [PLAY ▶].

TROUBLESHOOTING

Before requesting service for this unit, check the table below for a possible cause of the problem you are experiencing. Some simple checks or a minor adjustment on your part may eliminate the problem and restore proper operation.

	Remedy	
GENERAL	The power does not turn on.	<ul style="list-style-type: none"> • Check that the AC power cord is connected securely. • Check the breaker (in case of power failure). • Press [TIMER SET] to cancel the timer standby mode.
	There is no picture.	<ul style="list-style-type: none"> • Re-connect the connecting cords securely. • Check if the connecting cords are damaged. • Check the connection to your TV (pages 15-20). • Switch the input selector on your TV (such as to "L1") so that the signal from the unit appears on the TV screen.
	TV program reception does not fill the TV screen.	<ul style="list-style-type: none"> • Try to set the channels with "Auto Channel Preset" or "Manual Channel Preset" in "Channel" menu (pages 28-30). • Select a channel of any TV program using [CHANNEL + / -].
	TV program pictures are distorted.	<ul style="list-style-type: none"> • Adjust TV antenna. • Adjust the picture. (Refer to the TV's instruction manual.) • Place the unit and TV farther apart. • Place the TV and any bunched RF coaxial cables farther apart.
	TV channels cannot be changed.	<ul style="list-style-type: none"> • Switch the input to TV. • Connect the RF coaxial cable correctly (pages 15-20).
	There is no sound or the sound is distorted.	<ul style="list-style-type: none"> • Re-connect all connections securely. • Check if the connecting cord is damaged. • Check the connections to the amplifier input. • Check if the input device setting on the amplifier is correct. • When the unit is in pause mode or in slow-motion playback mode, sound is not output. This is not a malfunction. • When the unit is in fast forward or fast reverse mode, sound is not output. This is not a malfunction. • While the setup menu or timer programming display is shown, or while the screen saver is active, the audio is muted.
	The remote control does not function.	<ul style="list-style-type: none"> • Batteries are weak. • There are obstacles between the remote control and the unit. • The remote control is far from the unit. • There are no batteries in the remote control. • Check if the unit is turned on. • Check if you are pointing the remote control at the recorder and NOT the TV. If you have a plasma TV, it may interfere with the IR signal. Try the remote with the plasma off. If the remote works, you may need to move the unit away from the plasma TV. • Press [DVD] or [VCR], whichever you need. Then, try again. • Press [TIMER SET] to cancel the timer standby mode.
	The unit does not operate properly.	<ul style="list-style-type: none"> • When static electricity, etc., causes the unit to operate abnormally, unplug the unit and then plug it in again.
	No analog TV closed captions are output.	<ul style="list-style-type: none"> • If you are using HDMI connection to watch the TV programs through this unit's tuner, analog TV closed caption cannot be output. Try using other connection.
	DVD • VCR	Playback picture is distorted.
The channel cannot be changed from the channel you are recording.		<ul style="list-style-type: none"> • Set the TV's input to "TV."
Nothing was recorded even though you set the timer setting correctly.		<ul style="list-style-type: none"> • There was a power failure during recording. • The unit's internal clock stopped due to a power failure that lasted for more than 30 seconds. Reset the clock (pages 31-32). • The program contains copy protection signals that restricts copying. • The timer setting overlapped with another setting that has priority.
Timer recording is not complete or did not start from the beginning.		<ul style="list-style-type: none"> • The timer setting overlapped with another setting that has priority (page 46). • Disc space was not enough.
Timer recording is impossible.		<ul style="list-style-type: none"> • Make sure  appears on the front panel display of this unit. If not, press [TIMER SET].

TROUBLESHOOTING

	Symptom	Remedy
DVD • VCR	No image from HDMI connection.	<ul style="list-style-type: none"> • Check the HDMI connection. (Check the status of the HDMI related indications.) • Check whether the connected monitor device or other device supports HDCP. (This unit will not output a video signal unless the other device supports HDCP.) • Check the setting of HDMI. • Check whether the output format of this unit (HDMI FORMAT) matches the supported input format of other connected device. • If the unit is connected to the unauthorized display device with an HDMI cable, the audio/video signal may not be output when playing back a commercial DVD-video.
	There is no sound or the sound is distorted.	<ul style="list-style-type: none"> • The HDMI sound is not output when "HDMI Audio" is set to "OFF". • Check the RCA audio cable connection. If you are using HDMI-DVI conversion cable, you must connect the RCA audio cable, too. • Check whether the output format of this unit (HDMI FORMAT) matches the supported input format of other connected device.
	Setup menu cannot be called up.	<ul style="list-style-type: none"> • Setup menus cannot be called up during DVD recording or DVD playback.
DVD	There is no picture.	<ul style="list-style-type: none"> • If the main menu appears on the TV screen, press [RETURN] to exit. • Check if the progressive scan mode is set correctly according to your TV (page 91).
	Picture noise appears.	<ul style="list-style-type: none"> • Clean the disc with a cleaning cloth.
	There is no sound.	<ul style="list-style-type: none"> • If you are using DIGITAL AUDIO OUT (COAXIAL) jack, check the setting in "Disc Audio" (pages 86-87). • Clean the disc with a cleaning cloth.
	Sound is noisy.	<ul style="list-style-type: none"> • Clean the disc with a cleaning cloth.
	No DTS sound is output.	<ul style="list-style-type: none"> • This unit is not compatible with DTS sound.
	The disc does not play back.	<ul style="list-style-type: none"> • No disc is inserted. • A blank disc is inserted. • The disc is upside down. Insert the disc with the labeled side facing up. • The disc is not correctly inserted. • The unit cannot play back certain discs (such as a CD-ROM) (page 56). • The region code on the DVD-video does not match the unit (page 56). • Moisture has condensed inside the unit. Remove the disc and leave the unit turned on for about 2 hours until the moisture evaporates (page 3). • If the disc was recorded on another recorder, the unit cannot play back the disc if it was not finalized.
	Discs recorded on this unit cannot be played back on other DVD players.	<ul style="list-style-type: none"> • If you are using DVD-RW/-R, please ensure you finalized the disc after recording (pages 54-55).
	The disc does not start playback from the beginning.	<ul style="list-style-type: none"> • Resume playback was activated (page 62). Press [STOP ■] twice. • You have inserted a disc whose title menu or DVD menu automatically appears on the TV screen when it is first inserted.
	The unit starts playing back the disc automatically.	<ul style="list-style-type: none"> • The DVD-video features an auto playback function.
	Some functions such as stop, search, or slow-motion playback cannot be performed.	<ul style="list-style-type: none"> • Depending on the disc, you may not be able to do some of the operations. Refer to the instruction manual supplied with the disc.
	The language for the sound track cannot be changed.	<ul style="list-style-type: none"> • The title does not have the multilingual audio tracks. • The DVD-video prohibits the changing of the language for the sound track.
	The subtitle language cannot be changed or turned off.	<ul style="list-style-type: none"> • Multilingual subtitle are not recorded on the DVD-video.
	The angles cannot be changed.	<ul style="list-style-type: none"> • Multi-angles are not recorded on the DVD-video being played back. • The angle-change operation is whenever possible as long as the disc contains a multi-angle portion. Actual change will be performed when the portion has come up. • The DVD-video prohibits changing angles. • Try changing the angle using the DVD-video's menu.
Recording does not stop immediately after you press [STOP ■] .	<ul style="list-style-type: none"> • It may take a few seconds for the unit to input disc data before recording stops. 	

TROUBLESHOOTING

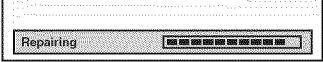
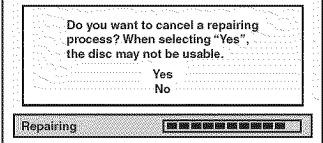
	Symptom	Remedy
DVD	The disc tray does not open when you press [OPEN/CLOSE ▲].	<ul style="list-style-type: none"> It may take a few seconds for the disc tray to open after you have recorded or edited a disc. This is because the unit is adding disc data to the disc.
	"Repairing" appears on the TV screen.  In a case you intend to cancel the repairing process. 	<ul style="list-style-type: none"> If there is a power failure or unplugging during recording, finalizing, formatting or editing (even after "Repairing" disappears), a repairing process will begin automatically just after turning the unit on again. It may take several minutes up to about several hours. If you intend to cancel the repairing process, press [▲OPEN/CLOSE] on the front panel, then select "Yes" and press [OK]. After that, press [OPEN/CLOSE ▲] to take out the disc. The disc canceled during the repairing process MAY NOT work.
VCR	Picture noise appears.	<ul style="list-style-type: none"> Head cleaning for VCR may be necessary. Refer to "Auto head cleaning" (page 4). Adjust tracking control for better picture by pressing [CHANNEL + / -] while you are playing back a cassette tape.
	The cassette tape does not play back.	<ul style="list-style-type: none"> No cassette tape is inserted.
	Recording does not start after you press [REC].	<ul style="list-style-type: none"> Make sure the cassette tape has an erase-protection tab when you record to a cassette tape. If needed, cover the hole with cellophane tape.
	The remote control does not function.	<ul style="list-style-type: none"> Check if a cassette tape is in this unit.
	The motor rotates even when playback / recording is stopped.	<ul style="list-style-type: none"> The motor may rotate for the duration of approximately 5 minutes for efficient operation. This is not a malfunction.

Introduction

Connections

Basic Setup

Recording

Playback

Editing

Function Setup

VCR Functions

Others

Español

TROUBLESHOOTING

Disc Error message	Cause	Solution
Disc Error — Please eject the disc. — Playback feature may not be available on this Disc.	<ul style="list-style-type: none"> • Unplayable disc is inserted in the unit. • The disc is upside down. 	<ul style="list-style-type: none"> • Insert the standardized disc which bear the marks on page 56. • Insert the disc with the labeled side facing up.
Region Error — Please eject the disc. — Playback is not authorized in your region.	<ul style="list-style-type: none"> • Playback is not authorized in the region of the DVD-video which you inserted in the unit. 	<ul style="list-style-type: none"> • Insert the DVD-video with region codes 1 or ALL.
Parental Lock On The current selected parental level prohibits playback.	<ul style="list-style-type: none"> • The current selected parental level prohibits playback. 	<ul style="list-style-type: none"> • Check “Parental Lock” setting in “Playback” menu (page 86).
Recording Error This program is not allowed to be recorded.	<ul style="list-style-type: none"> • The recording function encountered the copy prohibited program. 	<ul style="list-style-type: none"> • You cannot record copy prohibited programs.
Recording Error This program is not recordable in +VR mode.	<ul style="list-style-type: none"> • You are trying to record the copy-once program. 	<ul style="list-style-type: none"> • You cannot record the copy-once program.
Recording Error Can not record on this disc.	<ul style="list-style-type: none"> • You are trying to record onto the disc which is unrecordable, or the disc status is unable to record. • The disc is dirty. • The disc is damaged. 	<ul style="list-style-type: none"> • Insert the recordable disc, and ensure the disc status satisfies the recording requirements (page 39). • Clean the disc with a cleaning cloth. • Replace the disc.
Recording Error This disc is protected and not recordable.	<ul style="list-style-type: none"> • You are trying to record on to the protected disc which is set in “Disc Edit” menu. 	<ul style="list-style-type: none"> • Release the disc protect setting in “Disc Edit” menu (page 53).
Recording Error Disc is full. (No area for new recording)	<ul style="list-style-type: none"> • You are trying to record onto the disc which has no space for recording. 	<ul style="list-style-type: none"> • Insert the recordable disc with enough recording space.
Recording Error You cannot record more than 49 titles on one disc. (The maximum is 49)	<ul style="list-style-type: none"> • You are trying to record onto the disc on which the number of recording titles comes up to the maximum (49). 	<ul style="list-style-type: none"> • Delete unnecessary titles (page 71).
Recording Error You cannot record more than 254 chapters on one disc. (The maximum is 254)	<ul style="list-style-type: none"> • You are trying to record onto the DVD+RW or DVD-RW on which the number of recording chapters comes up to the maximum (254). 	<ul style="list-style-type: none"> • Delete unnecessary chapter marks (pages 74-75).
Recording Error You cannot record on this disc as Power Calibration Area is full.	<ul style="list-style-type: none"> • When recordings are performed repeatedly onto an unstable disc, this area may come up to be full. • Every time you insert a disc for recording, the disc’s working area will be taken up. And if you repeat this frequently, it will be used up sooner and you may not be able to record full 49 titles. 	<ul style="list-style-type: none"> • Insert a new disc.
Recording Error This disc is already finalized.	<ul style="list-style-type: none"> • You are trying to record onto the disc already finalized. 	<ul style="list-style-type: none"> • Release the finalizing for this disc (page 54).
Recording Error The disc has no recording compatibility. Set “Make Recording Compatible” to “ON” to convert the disc.	<ul style="list-style-type: none"> • You are trying to record onto the disc that had been recorded by other recorders. 	<ul style="list-style-type: none"> • Set “Make Recording Compatible” to “ON” to rewrite the menu, after that you will record to disc (page 40).

* If you are still having trouble with the unit after checking “TROUBLESHOOTING”, write down the error code and the error description for calling our help line mentioned on the front page to locate an Authorized Service Center.

LANGUAGE CODE

Language	Code
Abkhazian	4748
Afar	4747
Afrikaans	4752
Albanian	6563
Amharic	4759
Arabic	4764
Armenian	5471
Assamese	4765
Aymara	4771
Azerbaijani	4772
Bashkir	4847
Basque	5167
Bengali;Bangla	4860
Bhutani	5072
Bihari	4854
Bislama	4855
Breton	4864
Bulgarian	4853
Burmese	5971
Byelorussian	4851
Cambodian	5759
Catalan	4947
Chinese	7254
Corsican	4961
Croatian	5464
Czech	4965
Danish	5047
Dutch	6058
English	5160
Esperanto	5161
Estonian	5166
Faroese	5261
Fiji	5256
Finnish	5255
French	5264
Frisian	5271
Galician	5358
Georgian	5747
German	5051
Greek	5158
Greenlandic	5758
Guarani	5360
Gujarati	5367
Hausa	5447
Hebrew	5569
Hindi	5455

Language	Code
Hungarian	5467
Icelandic	5565
Indonesian	5560
Interlingua	5547
Interlingue	5551
Inupiak	5557
Irish	5347
Italian	5566
Japanese	5647
Javanese	5669
Kannada	5760
Kashmiri	5765
Kazakh	5757
Kinyarwanda	6469
Kirghiz	5771
Kirundi	6460
Korean	5761
Kurdish	5767
Laothian	5861
Latin	5847
Latvian; Lettish	5868
Lingala	5860
Lithuanian	5866
Macedonian	5957
Malagasy	5953
Malay	5965
Malayalam	5958
Maltese	5966
Maori	5955
Marathi	5964
Moldavian	5961
Mongolian	5960
Nauru	6047
Nepali	6051
Norwegian	6061
Occitan	6149
Oriya	6164
Oromo (Afan)	6159
Panjabi	6247
Pashto; Pushto	6265
Persian	5247
Polish	6258
Portuguese	6266
Quechua	6367
Rhaeto-Romance	6459
Romanian	6461

Language	Code
Russian	6467
Samoan	6559
Sangho	6553
Sanskrit	6547
Scots Gaelic	5350
Serbian	6564
Serbo-Croatian	6554
Sesotho	6566
Setswana	6660
Shona	6560
Sindhi	6550
Singhalese	6555
Siswat	6565
Slovak	6557
Slovenian	6558
Somali	6561
Spanish	5165
Sundanese	6567
Swahili	6569
Swedish	6568
Tagalog	6658
Tajik	6653
Tamil	6647
Tatar	6666
Telugu	6651
Thai	6654
Tibetan	4861
Tigrinya	6655
Tonga	6661
Tsonga	6665
Turkish	6664
Turkmen	6657
Twi	6669
Ukrainian	6757
Urdu	6764
Uzbek	6772
Vietnamese	6855
Volapuk	6861
Welsh	4971
Wolof	6961
Xhosa	7054
Yiddish	5655
Yoruba	7161
Zulu	7267

Introduction

Connections

Basic Setup

Recording

Playback

Editing

Function Setup

VCR Functions

Others

Español

GLOSSARY

Analog Audio

An electrical signal that directly represents sound. Compare this to digital audio which can be an electrical signal, but is an indirect representation of sound. See also "Digital Audio".

Aspect Ratio

The width of a TV screen relative to its height. Conventional TVs are 4:3 (in other words, the TV screen is almost square); widescreen models are 16:9 (the TV screen is almost twice as wide as it is high).

Chapter (DVD only)

Just as a book is split up into several chapters, a title on a DVD is usually divided into chapters. See also "Title".

Component Video Output

Each signal of luminance (Y) and component (P_B/C_B, P_R/C_R) is independent to output so that you can experience picture color as it is.

Also, due to compatibility with progressive video (525p/480p), you can experience higher-density picture than that in interlace (525i/480i).

Digital Audio

An indirect representation of sound by numbers. During recording, the sound is measured at discrete intervals (44,100 times a second for CD audio) by an analog-to-digital converter, generating a stream of numbers. On playback, a digital-to-analog converter generates an analog signal based on these numbers. See also "Sampling Frequency" and "Analog Audio".

Dolby Digital

The system to compress digital sound developed by Dolby Laboratories. It offers you sound of stereo(2ch) or multi channel audio.

Finalize

To make DVD, which have been recorded on, possible to play back in DVD players. With this unit, it is possible to finalize DVD+R, DVD-RW, and DVD-R.

HDMI™ (high definition multimedia interface)

A digital interface between audio and video source. It can transmit component video, audio, and control signal with one cable connection.

JPEG (joint photographic experts group)

JPEG is a method of compressing still image files. You can copy JPEG files on CD-RW/-R from a computer and play back the files on this unit.

MP3 (MPEG audio layer 3)

MP3 is a method of compressing files. You can copy MP3 files on CD-RW/-R from the computer and play back the files on this unit.

PBC (playback control) (video CD only)

This function enables you to play back interactive software using a menu screen. See also "Video CD".

PCM (pulse code modulation)

The most common system of encoding digital audio, found on CD and DAT. Excellent quality, but requires a lot of data compared to formats such as Dolby Digital and MPEG audio. For compatibility with digital audio recorders (CD, MD and DAT) and AV amplifiers with digital inputs, this unit can convert Dolby Digital and MPEG audio to PCM. See also "Digital Audio".

Progressive Scan (525p/480p)

A type of display that does not split each frame into fields, and instead scans directly through all the scanlines of each frame in order. Progressive scan provides less flickering and higher image resolution than traditional (525i/480i) TV signals. Refer to page 91 for instructions on selective progressive scan mode.

Region Code

Regions associate discs and players with particular areas of the world. This unit will only play back discs that have compatible region codes. You can find the region code of your unit by looking on the rear panel. Some discs are compatible with more than one region (or all regions).

Sampling Frequency

The rate which sound is measured by a specified interval to turn into digital audio data. The numbers of sampling in one second defines as sampling frequency. The higher the rate, the better the sound quality.

SAP (secondary audio program)

Sub-audio channel which is delivered separately from main-audio channel. This audio channel is used as an alternate in bilingual broadcasting.

S-Video Output

It delivers independently each signal of color(C) and luminance(Y) to TV as video signals, so that higher-quality picture will be gained.

Title (DVD only)

A collection of chapters on DVD. See also "Chapter".

Track

Audio CD use tracks to divide up the content of a disc. The DVD equivalent is called a chapter. See also "Chapter".

Video CD

A digital format for store video data in compact disc.

SPECIFICATIONS

General

VCR video heads	Four heads
Power requirements	120V AC, 60Hz
Power consumption	30W (standby: 3.3W)
Dimensions (width x height x depth)	17.2 x 4.0 x 10.3 inches (435 x 99.5 x 260mm)
Weight	9.5 lbs. (4.3kg)
Operating temperature	41°F (5°C) to 104°F (40°C)
Operating humidity	Less than 80% (no condensation)
TV system	ATSC / NTSC-M TV standard

Recording

Recording format	+VR (video recording) format
Recording discs	DVD+Rewritable, DVD+Recordable DVD-Rewritable, DVD-Recordable (+VR mode only)

Video recording format

Sampling frequency	13.5 MHz
Compression format	MPEG

Audio recording format

Sampling frequency	48 kHz
Compression format	Dolby Digital

Tuner

Tuning system	Channel frequency synthesized tuning system
---------------	---

Channel coverage (ATSC / NTSC)

Terrestrial	VHF 2~13, UHF 14~69
CATV	2~13, A~W, W+1~W+94 (analog W+1~W+84), A-5~A1, 5A

Terminals

Front	Audio input			
	RCA jack x 2	2V rms (input impedance: more than 22kΩ)		
	Video input			
	RCA jack x 1	1Vp-p (75Ω)		
Rear	S-video input			
	Mini DIN 4-pin x 1	Y: 1Vp-p (75Ω)	C: 286mVp-p (75Ω)	
	VHF/UHF/CATV input and output			
	F-type	75Ω unbalanced		
	Audio input			
	RCA jack x 2	2V rms (input impedance: more than 22kΩ)		
	Audio output			
	RCA jack x 4	2V rms (output impedance: more than 1kΩ)		
	Video input			
	RCA jack x 1	1Vp-p (75Ω)		
	Video output			
	RCA jack x 1	1Vp-p (75Ω)		
	S-video input			
	Mini DIN 4-pin x 1	Y: 1Vp-p (75Ω)	C: 286mVp-p (75Ω)	
	S-video output			
	Mini DIN 4-pin x 1	Y: 1Vp-p (75Ω)	C: 286mVp-p (75Ω)	
Component video out				
RCA jack x 3	Y: 1Vp-p (75Ω)	PB/CB: 700mVp-p (75Ω)	PR/CR: 700mVp-p (75Ω)	
Coaxial digital audio out				
RCA jack x 1	500mVp-p (75Ω)			
HDMI output				
HDMI jack x 1				

Note

- The specifications and design of this product are subject to change without notice.

Introduction

Connections

Basic Setup

Recording

Playback

Editing

Function Setup

VCR Functions

Others

Español

Discos Reproducibles

Este aparato es compatible con la reproducción de los siguientes discos y archivos.

Discos reproducibles	Logotipos
DVD-video	
DVD+RW	
DVD+R	
DVD-RW (Sólo discos en modo de video finalizados)	
DVD-R (Sólo discos en modo de video finalizados)	
CD-DA (CD de audio)	
CD de video	 
CD-RW	 
CD-R	 
Kodak Picture CD	

Archivos reproducibles	Soportes
MP3	CD-RW/-R
JPEG	

 es una marca registrada de DVD Format/Logo Licensing Corporation.

Códigos de Región

El número presente en el interior el globo se refiere a una región del mundo. Este aparato puede reproducir discos DVD que estén rotulados para ALL las regiones o para la región 1.



Disco Grabable

Este aparato puede grabar a DVD+RW, DVD+R, DVD-RW y DVD-R.

Los discos DVD+R/DVD-R pueden ser grabados sólo una vez. Los discos DVD+RW/DVD-RW pueden ser grabados y borrados muchas veces.

En este aparato los discos DVD-RW/-R serán grabados automáticamente en el modo DVD+VR.

Logotipos	Atributos
 	Disco de 8 cm / 12 cm, un solo lado, una sola capa Tiempo de grabación máx. aprox. (modo SLP): 360 minutos (4,7 GB) (para 12 cm) 108 minutos (1,4 GB) (para 8 cm)
DVD+RW DVD+R	
 	
DVD-RW DVD-R	

• Los siguientes discos se recomiendan para obtener una buena calidad de grabación y han sido comprobados como compatibles con este aparato. Sin embargo, según sea la condición del medio el equipo podría no leer el disco correctamente.

Verbatim	DVD+R 8x, DVD-R 8x, DVD-RW 4x	DVD+RW 4x, DVD-RW 2x
JVC	DVD-RW 4x	
Maxell	DVD+R 4x/8x/16x, DVD-R 8x/16x	
SONY	DVD+R 4x/8x/16x, DVD+RW 4x	
TDK	DVD+R 4x/8x/16x	

El comportamiento de cualquier otro disco no está garantizado.

• **Usted puede reproducir discos DVD+RW en la mayoría de los reproductores de DVD sin finalizarlos. Sin embargo, si usted ha añadido o eliminado capítulos, u ocultado capítulos, debe ejecutar "Compatibilizar edic." antes de poder ver dichos efectos en otros equipos. (Consulte la página 81.) Para reproducir discos que no sean DVD+RW en otros reproductores de DVD, usted necesitará finalizarlos.**

Disco no Grabable

- Un DVD-RW grabado en un modo distinto de +VR no será grabable en este aparato a menos que usted borre todo el contenido del disco. (Consulte la página 80.)
- Un DVD-R grabado en un modo distinto de +VR no será grabable en este aparato.

Conexión Básica

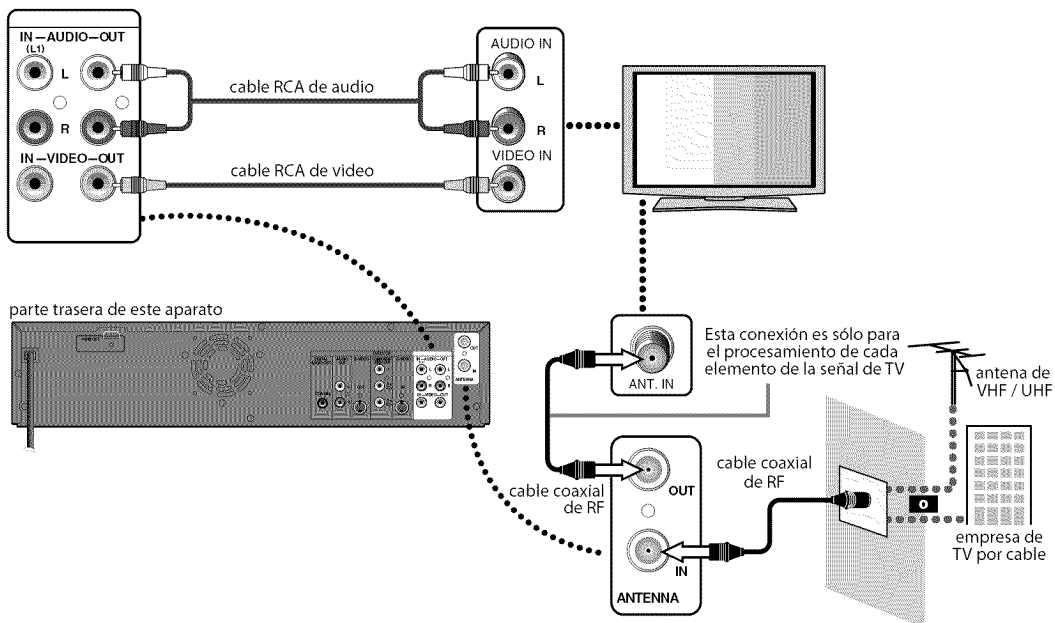

Conexión a un Televisor con un Puerto Compatible con HDMI™

- HDMI emite las señales de video / audio sin convertirlas en señales analógicas.
- No es necesaria una conexión de audio.

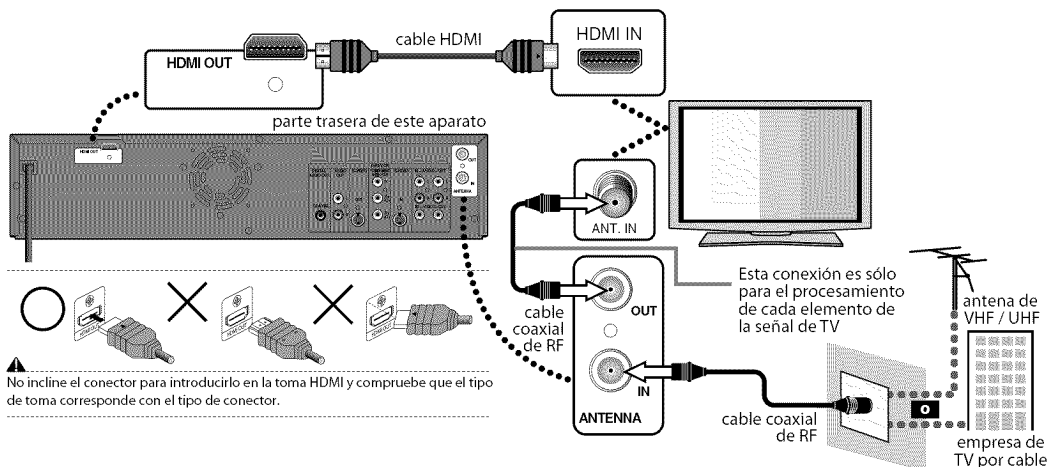

Modo HDMI y señales efectivas de salida

Presione **[HDMI]** para seleccionar el modo de salida HDMI. Cada vez que se presiona **[HDMI]** el modo de salida varía como sigue.

Pantalla del panel frontal	Señal de salida de video
480P	Progresivo de 480
Presione [HDMI]	↓
720P	Progresivo de 720
Presione [HDMI]	↓
1080i	1080 entrelazado
Presione [HDMI]	↓
1080P	Progresivo de 1080
Presione [HDMI]	



- El modo HDMI que no esté admitido por el dispositivo de exhibición será pasado por alto.

Configuración Inicial



Cuando usted encienda este aparato por primera vez necesita seguir estos pasos.

1 Presione [STANDBY-ON ].

Encienda el televisor. Seleccione la entrada a la cual está conectado el aparato.

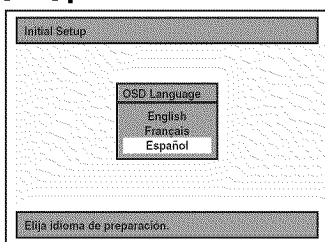



2 Utilice [ / ] para seleccionar su idioma deseado, y luego presione [OK] para establecerlo.

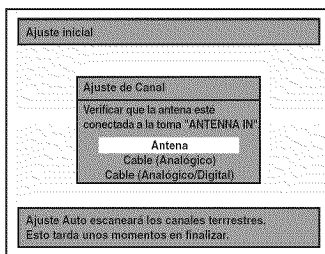

3 Utilice [ / ] para seleccionar el tipo de señal de emisión, y luego presione [OK].



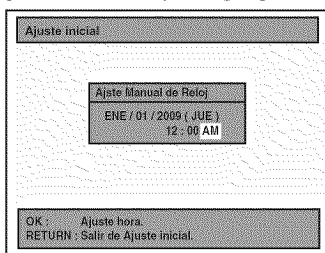

El equipo comenzará a obtener los canales disponibles en su región.

4 Utilice [ / ] para seleccionar un elemento a configurar, y utilice [ / ] para seleccionar el contenido de su preferencia, y luego presione [OK].



Grabación Básica

1 Presione [DVD]. Presione [OPEN/CLOSE ] para abrir la bandeja de discos e insertar su disco con el rótulo apuntando hacia arriba. Presione de nuevo [OPEN/CLOSE ] para cerrar la bandeja de discos.

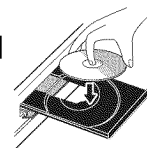

* Asegúrese de que el disco sea compatible con este aparato. (Para obtener la lista de discos compatibles consulte la página 104.)

2 Para seleccionar un modo de grabación presione [REC MODE].

Modo de grabación	Tiempo de grabación		Calidad del video y el sonido
	Disco de 8 cm	Disco de 12 cm	
HQ (1Hr)	18 min	60 min	Buena ↑ Deficiente
SP (2Hr)	36 min	120 min	
SPP (2.5Hr)	45 min	150 min	
LP (3Hr)	54 min	180 min	
EP (4Hr)	72 min	240 min	
SLP (6Hr)	108 min	360 min	

3 Presione [DTV/TV] para seleccionar TV analógica o TV digital, y a continuación, utilice [CHANNEL + / -] o [los botones numéricos] y [.] (para canales de TV digital) para seleccionar un canal que desea grabar.

4 Presione [REC] para iniciar la grabación.

Para configurar la grabación a un toque con temporizador (OTR)...

Esta es una manera sencilla de configurar el tiempo de grabación en bloques de 30 minutos.

Presione [REC] repetidamente hasta que aparezca en la pantalla del televisor la longitud deseada de grabación (30 minutos a 6 horas). Comenzará la grabación a un toque con temporizador.

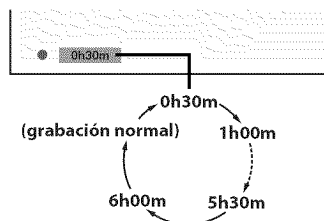

Para cambiar la duración de la grabación durante la grabación a un toque con temporizador:

Presione [REC] repetidamente hasta que aparezca la duración deseada.

Para cancelar la grabación a un toque con temporizador dentro del tiempo especificado:

Presione [STOP ].

5 Para de tener la grabación presione [STOP ].

Grabación con Temporizador

Usted puede programar el equipo para que grabe hasta 12 programas, con un mes de anticipación. También hay disponibles grabaciones de programas diarios o semanales.

Antes de grabar, asegúrese de que

- Antes de establecer una programación del temporizador configure el reloj.
- Inserte un disco grabable con suficiente espacio libre o una cinta de cassette con una lengüeta de grabación.

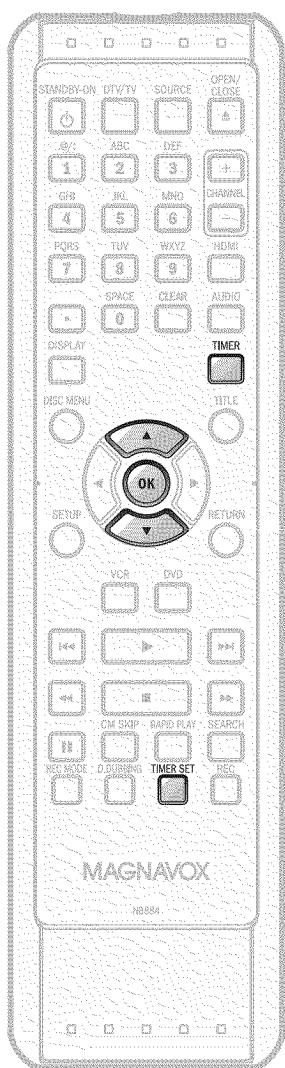

1 Presione [TIMER].

2 Utilice [▲ / ▼] para seleccionar "Prog. nuevo", y luego presione [OK].

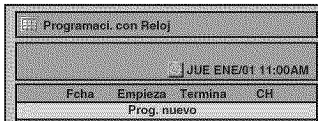

3 Configure una programación del temporizador.

4 Presione [OK].

5 Presione [TIMER SET] para configurar una programación del temporizador. Aparecerá  en el pantalla del panel frontal.

Configure la fecha.

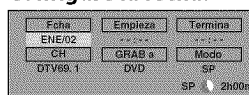

Configure las horas de inicio y finalización.

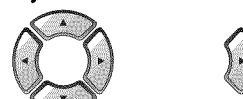
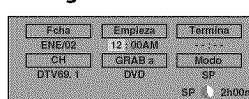

Seleccione un modo deseado de entrada y el canal a grabar.

Para obtener más detalles, consulte "How to select a channel number for the timer recording" en la página 45 del manual del usuario. ej.) modo digital

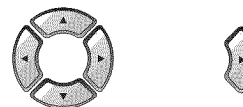
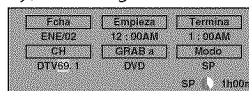

Seleccione un medio de grabación ("DVD" o "VCR").



Seleccione un modo de grabación.

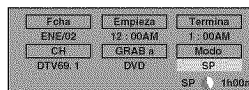

Reproducción

1 Presione [DVD].



2 Abra la bandeja de discos, y Inserte un disco.



3 Cerrar la bandeja de discos.



4 Comience a reproducir.



5 Detenga la reproducción.

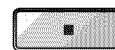

MAGNAVOX

LIMITED WARRANTY

FUNAI CORP. will repair this product, free of charge in the USA in the event of defect in materials or workmanship as follows:

DURATION:

PARTS: FUNAI CORP. will provide parts to replace defective parts without charge for one (1) year from the date of original retail purchase. Certain parts are excluded from this warranty.

LABOR: FUNAI CORP. will provide the labor without charge for a period of ninety (90) days from the date of original retail purchase.

LIMITS AND EXCLUSIONS:

THIS WARRANTY IS EXTENDED ONLY TO THE ORIGINAL RETAIL PURCHASER. A PURCHASE RECEIPT OR OTHER PROOF OF ORIGINAL RETAIL PURCHASE WILL BE REQUIRED TOGETHER WITH THE PRODUCT TO OBTAIN SERVICE UNDER THIS WARRANTY.

This warranty shall not be extended to any other person or transferee.

This warranty is void and of no effect if any serial numbers on the product are altered, replaced, defaced, missing or if service was attempted by an unauthorized service center. This limited warranty does not apply to any product not purchased and used in the United States.

This warranty only covers failures due to defects in material or workmanship which occur during normal use. It does not cover damage which occurs in shipment, or failures which are caused by repairs, alterations or products not supplied by FUNAI CORP., or damage, which results from accident, misuse, abuse, mishandling, misapplication, alteration, faulty installation, improper maintenance, commercial use such as hotel, rental or office use of this product, or damage which results from fire, flood, lightning or other acts of God.

THIS WARRANTY DOES NOT COVER PACKING MATERIALS, ANY ACCESSORIES (EXCEPT REMOTE CONTROL), ANY COSMETIC PARTS, COMPLETE ASSEMBLY PARTS, DEMO OR FLOOR MODELS.

FUNAI CORP. AND ITS REPRESENTATIVES OR AGENTS SHALL IN NO EVENT BE LIABLE FOR ANY GENERAL, INDIRECT OR CONSEQUENTIAL DAMAGES ARISING OUT OF OR OCCASIONED BY THE USE OF OR THE INABILITY TO USE THIS PRODUCT. THIS WARRANTY IS MADE IN LIEU OF ALL OTHER WARRANTIES, EXPRESS OR IMPLIED, AND OF ALL OTHER LIABILITIES ON THE PART OF FUNAI, ALL OTHER WARRANTIES INCLUDING THE WARRANTY OF MERCHANTABILITY AND FITNESS FOR A PARTICULAR PURPOSE, ARE HEREBY DISCLAIMED BY FUNAI AND ITS REPRESENTATIVES IN THE UNITED STATES.

ALL WARRANTY INSPECTIONS AND REPAIRS MUST BE PERFORMED BY AN AUTHORIZED SERVICE CENTER.

THIS WARRANTY IS ONLY VALID WHEN THE UNIT IS CARRIED-IN TO AN AUTHORIZED SERVICE CENTER.

THE PRODUCT MUST BE ACCOMPANIED BY A COPY OF THE ORIGINAL RETAIL PURCHASE RECEIPT. IF NO PROOF OF PURCHASE IS ATTACHED, THE WARRANTY WILL NOT BE HONORED AND REPAIR COSTS WILL BE CHARGED.

IMPORTANT:

THIS LIMITED WARRANTY GIVES YOU SPECIFIC LEGAL RIGHTS. YOU MAY HAVE OTHER RIGHTS THAT VARY FROM STATE TO STATE. IF, AT ANY TIME DURING THE WARRANTY PERIOD, YOU ARE UNABLE TO OBTAIN SATISFACTION WITH THE REPAIR OF THIS PRODUCT, PLEASE CONTACT FUNAI CORP.

ATTENTION:

FUNAI CORP. RESERVES THE RIGHT TO MODIFY ANY DESIGN OF THIS PRODUCT WITHOUT PRIOR NOTICE.

WARRANTY STATEMENT REGARDING NON AUTHORIZED REPAIRS:

To obtain warranty service, you must take the product, or deliver the product freight prepaid, in either its original packaging or packaging affording an equal degree of protection, to any AUTHORIZED SERVICE CENTER. FUNAI CORP. will not reimburse you for any service done by unauthorized service providers without prior written approval.

To locate your nearest AUTHORIZED SERVICE CENTER or for general service inquiries, please contact us at:

FUNAI SERVICE CORPORATION
Customer Service
Tel: 1-800-605-8610
<http://www.magnavox.com/support>
2200 Spiegel Drive Groveport, OH 43125