

FRIGIDAIRE

All about the

Use & Care

of your Electric Range

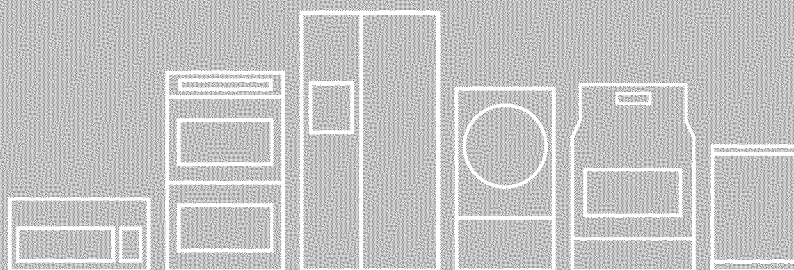

TABLE OF CONTENTS

Important Safety Instructions	3-5	Setting Oven Controls	17-28
Features at a Glance	6	Keep Warm Drawer	29-30
Before Setting Oven Controls	7-9	Self-cleaning	31-32
Before Setting Surface Controls	9-11	Care & Cleaning (EC/WD)	33-36
Setting Surface Controls	12-15	Before You Call	37-38
Oven Control Functions (1000P)	16	Major Appliance Warranty	39

PRODUCT RECORD AND REGISTRATION

Contents

Product Registration	2
Important Safety Instructions	3-5
Features at a Glance	6
Before Setting Oven Controls	7-9
Removing, replacing & arranging the oven racks	7
Effortless™ Oven Rack system and assembly	8
Before Setting Surface Controls	9-11
Cookware material types	10
Cooktop display windows	11
Setting Surface Controls	12-16
Single radiant elements	12
Bridge cooking zone	13
Keep warm zone	14
Home canning	15
Oven Controls Functions	16
Setting Oven Controls	17-28
Setting the clock	17
Changing between continuous bake or 6-Hour	
Energy Saving features	17
Setting 12 or 24 hour display modes	17
Changing oven temperature display (F° or C°)	17
Setting a silent control panel	18
Setting oven lockout	18
Setting minute timer	18
Add a minute feature	18
Setting powerplus preheat	19
Setting bake	19
Setting bake time	19
Setting delayed timed bake	20
Setting convect (convection) bake	21
Setting convect roast	21
Setting convect broil (some models)	22
Setting convect (convection) convert	22
Setting broil	23
Setting pizza feature	24
Setting chicken nuggets feature	24
Setting keep warm	24
Adjusting oven temperature	25
Operating oven light	25
My favorite	26
Setting the Sabbath mode feature	27-28
Keep Warm Drawer	29-30
Self-cleaning	31-32
Care & Cleaning	33-36
Cleaning recommendations table	33
Cooktop maintenance and cleaning	34-35
Replacing the oven light	35
Removing & replacing oven door	36
Before You Call - Solutions to common problems...	37-38
Appliance Warranty	39

Thank you for choosing **Frigidaire**.

This Use & Care Guide is part of our commitment to customer satisfaction and product quality throughout the service life of your new appliance. We view your purchase as the beginning of a relationship. To ensure our ability to continue serving you, please use this page to record important product information.

Need help??

Visit the Frigidaire web site at www.frigidaire.com

Before you call for service, there are a few things you can do to help us serve you better.

Read this Use & Care manual.

It contains instructions to help you use and maintain your range properly.

If you received a damaged range ...

immediately contact the dealer (or builder) that sold you the range.

Save time and money.

Check the section titled "Before you call". This section helps step you through some common problems that might occur. If you do need service, help is only a phone call away. A list of toll-free customer service numbers are included in the back of this manual. Or call Frigidaire Customer Services at **1-800-944-9044**, 24 hours a day, 7 days a week.

Product Registration

Registering your product with Frigidaire enhances our ability to serve you. You can register online at **www.frigidaire.com** or by dropping your Product Registration Card in the mail.

Serial plate location

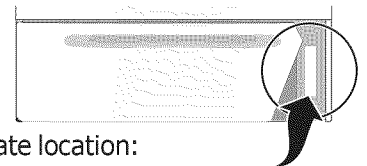

Serial plate location:
open storage drawer (some models) or
keep warm drawer (some models).

Record model & serial numbers here

Purchase date

Model number

Serial number

IMPORTANT SAFETY INSTRUCTIONS

Read all instructions before using this appliance.

Do not attempt to install or operate your appliance until you have read the safety precautions in this manual. Safety items throughout this manual are labeled with a WARNING or CAUTION statement based on the risk type.

Definitions

⚠ This is the safety alert symbol. It is used to alert you to potential personal injury hazards. Obey all safety messages that follow this symbol to avoid possible injury or death.

⚠ WARNING

WARNING indicates a potentially hazardous situation which, if not avoided, may result in death or serious injury.

⚠ CAUTION

CAUTION indicates a potentially hazardous situation which, if not avoided, may result in minor or moderate injury.

➡ IMPORTANT

IMPORTANT indicates installation, operation, maintenance or valuable information that is not hazard related.

Important Safety Instructions

- **Remove all tape and packaging before using the range.** Destroy the carton and plastic bags after unpacking the range. Never allow children to play with packaging material.
- **Proper installation—Be sure your appliance is properly installed and grounded by a qualified technician in accordance with the National Electrical Code ANSI/NFPA No. 70 latest edition and local electrical code requirements.** Install only per installation instructions provided in the literature package for this range.
- **User servicing—Do not repair or replace any part of the appliance unless specifically recommended in the manuals.** All other servicing should be done only by a qualified technician. This may reduce the risk of personal injury and damage to the range.

Ask your dealer to recommend a qualified technician and an authorized repair service. Know how to disconnect the power to the range at the circuit breaker or fuse box in case of an emergency.

⚠ WARNING

- **All ranges can tip.**
- **Injury to persons could result.**
- **Install anti-tip device packed with range.**
- **See Installation Instructions.**



To reduce the risk of tipping, the range must be secured by properly installed anti-tip bracket provided with the range. To check if the bracket is installed properly, visually check that rear leveling leg is inserted into and fully secured by the anti-tip bracket by removing lower front panel or storage drawer from the range.



For models equipped with a warmer drawer or lower oven, grasp the top rear edge of the range and carefully attempt to tilt it forward. Refer to the installation instructions for proper anti-tip bracket installation.

- **Never modify or alter the construction of a range by removing the leveling legs, panels, wire covers, anti-tip brackets/screws, or any other part of the range.**
- **Remove the oven door from any unused range if it is to be stored or discarded.**

⚠ WARNING

Stepping, leaning or sitting on the door or drawers of a range can result in serious injuries and also cause damage to the appliance. DO NOT allow children to climb or play around the range. The weight of a child on an open oven door may cause the range to tip, resulting in serious burns or other injury.

Never use your appliance for warming or heating the room.

Do not use the oven, warmer drawer or lower oven (if equipped) for storage.

Save these instructions for future reference.

IMPORTANT SAFETY INSTRUCTIONS

WARNING

- **Storage in or on appliance—flammable materials should not be stored in an oven, warmer drawer, near surface units or in the storage drawer.** This includes paper, plastic and cloth items, such as cookbooks, plasticware and towels, as well as flammable liquids. Do not store explosives, such as aerosol cans, on or near the range.
- **DO NOT LEAVE CHILDREN ALONE—children should not be left alone or unattended in the area where appliance is in use.** They should never be allowed to sit or stand on any part of the appliance, including the storage drawer, lower broiler drawer, warmer drawer or lower double oven.

CAUTION

- **Do not store items of interest to children in the cabinets above a range or on the backguard of the range.** Children climbing on the range to reach items could be seriously injured.
- **Do not touch surface heating units or surface cooking elements, areas near these units or elements, or interior surface of the oven.** Both surface heating and oven heating elements may be hot even though they are dark in color. Areas near surface cooking units may become hot enough to cause burns. During and after use, do not touch, or let clothing or other flammable materials touch these areas until they have had sufficient time to cool. Among these areas are the cook top, surfaces facing the cook top, the oven vent openings and surfaces near these openings, oven door and oven door window.
- **Wear proper apparel—loose-fitting or hanging garments should never be worn while using the appliance.** Do not let clothing or other flammable materials contact hot surfaces.

IMPORTANT

Do not attempt to operate the range during a power failure. If the power fails, always turn off the range. If the range is not turned off and the power resumes, the range will begin to operate again. Once the power resumes, reset the clock and oven function.

- **Do not use water or flour on grease fires—smother the fire with a pan lid, or use baking soda, a dry chemical or foam-type extinguisher.**
- **When heating fat or grease, watch it closely.** Fat or grease may catch fire if allowed to become too hot.
- **Use dry potholders - moist or damp potholders on hot surfaces may result in burns from steam.** Do not let potholders touch hot heating elements. Do not use a towel or other bulky cloth instead of a potholder.
- **Do not heat unopened food containers - buildup of pressure may cause container to burst and result in injury.**

IMPORTANT INSTRUCTIONS FOR USING YOUR OVEN

- **Use care when opening oven door, lower oven door or warmer drawer (if equipped)—**Stand to the side of the range when opening the door of a hot oven. Let hot air or steam escape before you remove or replace food in the oven.
- **Keep oven vent ducts unobstructed.** The oven vent is located under the left rear surface element if your model is equipped with coil elements. The oven vent is located below the backguard for models equipped with ceramic-glass cook tops. Touching the surfaces in this area when the oven is operating may cause severe burns. Also, do not place plastic or heat-sensitive items on or near the oven vent. These items could melt or ignite.
- **Placement of interior oven racks.** Always place oven racks in desired location while oven is cool. If rack must be moved while oven is hot use extreme caution. Use potholders and grasp the rack with both hands to reposition. Do not let potholders contact the hot heating elements in the oven. Remove all utensils from the rack before moving.
- **Do not use the broiler pan without its insert.** The broiler pan and its insert allow dripping fat to drain and be kept away from the high heat of the broiler. **Do not cover the broiler insert with aluminum foil. Exposed fat and grease could ignite.**
- **Protective liners—**Do not use aluminum foil to line the oven bottom. Only use aluminum foil as recommended in this manual. Improper installation of these liners may result in risk of electric shock, or fire.

IMPORTANT SAFETY INSTRUCTIONS

SELF-CLEANING OVENS

- **Clean in the self-cleaning cycle only the parts listed in this Use & Care Manual.** Before self-cleaning the oven, remove the broiler pan and any utensils or foods from the oven.
- **Do Not Use Oven Cleaners**—No commercial oven cleaner or oven liner protective coating of any kind should be used in or around any part of the oven.
- **Do Not Clean Door Gasket**—The door gasket is essential for a good seal. Care should be taken not to rub, damage or move the gasket.
- The health of some birds is extremely sensitive to the fumes given off during the self-cleaning cycle of any range. Move birds to another well-ventilated room.

IMPORTANT INSTRUCTIONS FOR CLEANING YOUR RANGE

- **Clean the range regularly to keep all parts free of grease that could catch fire.** Pay particular attention to the area around each surface element. Do not allow grease to accumulate.
- **Kitchen cleaners and aerosols—Always follow the manufacturer's recommended directions for use.** Be aware that excess residue from cleaners and aerosols may ignite causing damage and injury.
- **Clean ventilating hoods frequently—Grease should not be allowed to accumulate on the hood or filter.** Follow the manufacturer's instructions for cleaning hoods.

FOR CERAMIC-GLASS COOK TOP MODELS

- **Do not cook on broken cook top**—If cook top should break, cleaning solutions and spillovers may penetrate the broken cook top and create a risk of electric shock. Contact a qualified technician immediately.
- **Clean cook top with caution**—If a wet sponge or cloth is used to wipe spills on a hot cooking area, be careful to avoid a steam burn. Some cleaners can produce noxious fumes if applied to a hot surface.

IMPORTANT INSTRUCTIONS FOR USING YOUR COOKTOP

- **Know which knob controls each surface heating unit.** Place a pan of food on the unit before turning it on, and turn the unit off before removing the pan.
- **Use proper pan size**—This appliance is equipped with one or more surface units of different sizes. Select utensils having flat bottoms large enough to cover the surface unit heating element. The use of undersized utensils will expose a portion of the heating element to direct contact and may result in ignition of clothing. Proper relationship of utensil to element will also improve efficiency.
- **Utensil handles should be turned inward and not extend over adjacent surface elements**—To reduce the risk of burns, ignition of flammable materials, and spillage due to unintentional contact with the utensil, the handle of the utensil should be positioned so that it is turned inward, and does not extend over adjacent surface units.
- **Never leave surface elements unattended at high heat settings**—Boilovers cause smoking and greasy spillovers that may ignite, or a pan that has boiled dry may melt.
- **Do not immerse or soak removable heating elements**—Heating elements should never be immersed in water. Heating elements clean themselves during normal operation.
- **Glazed cooking utensils**—Only certain types of glass, glass/ceramic, ceramic, earthenware, or other glazed utensils are suitable for cook top service without breaking due to the sudden change in temperature. Check the manufacturer's recommendations for cook top use.
- **When flaming foods under a ventilating hood, turn the fan on.**

IMPORTANT SAFETY NOTICE

The California Safe Drinking Water and Toxic Enforcement Act requires the Governor of California to publish a list of substances known to the state to cause cancer, birth defects or other reproductive harm, and requires businesses to warn customers of potential exposure to such substances.

FEATURES AT A GLANCE

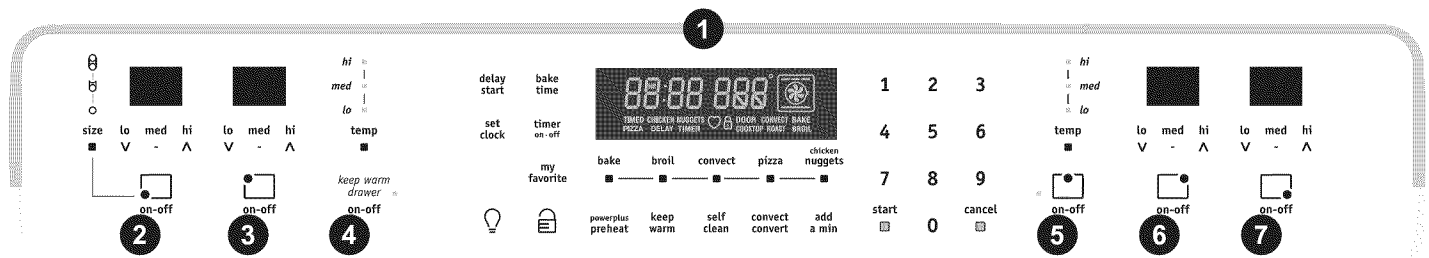

Your electric range features include:

1. Electronic oven control with kitchen timer.
2. Left front single and bridge element control.
3. Left rear single radiant element control.
4. Keep warm drawer control & indicator lights (some models).
5. Keep warm zone radiant element control & indicator (some models).
6. Right rear single radiant element control.
7. Right front dual (some models) or triple (some models) radiant element control.
8. Oven interior halogen light with removable protective shield.
9. Automatic oven door light switch.
10. Self-cleaning oven interior.
11. Self-clean door latch.
12. Dual convection fans & cover.
13. Adjustable interior oven rack(s) and Effortless Oven Rack™ system (not shown-some models).
14. Large full width 1-piece oven door handle.
15. Full width oven door with window.
16. Storage drawer with integrated drawer handle (some models).
17. Keep warm drawer (some models).
18. Large full width 1-piece keep warm drawer handle (some models).
19. Easy to clean upswept cooktop.
20. Ceramic smoothtop (elements, styles and color will vary by model).
21. 6" single radiant element.
22. **space wise** bridge cooking zone.
23. 7" single radiant element (when not set for bridge).
24. **power plus** 9" single radiant element.
25. **keep warm zone** 6" radiant element.
26. Broil pan (some models).
27. Broil pan insert (some models).
28. Keep warm drawer rack (some models).
29. Leveling legs and **anti-tip** bracket (included).

Note: The features shown for your appliance may vary according to model type & color.

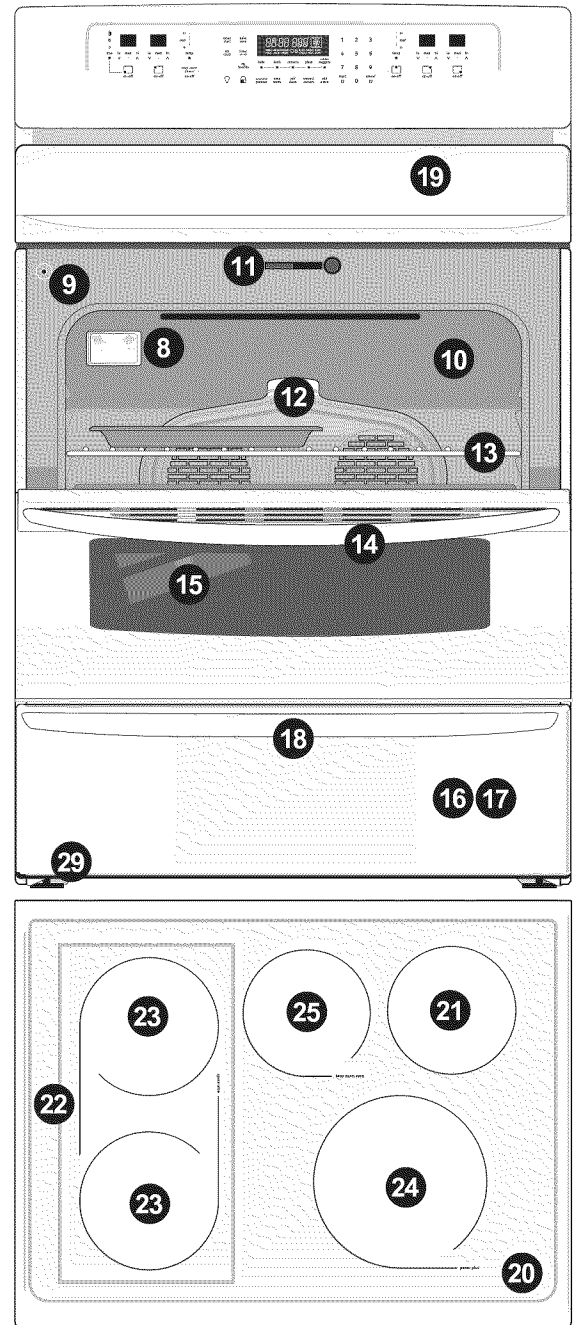
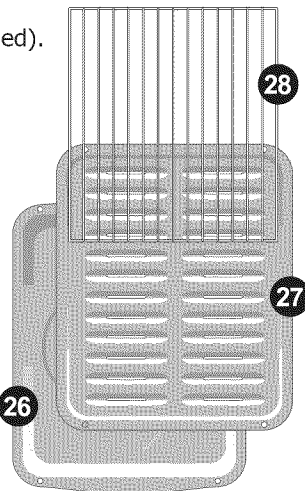

Be sure to visit us online at
www.frigidaire.com
 for a complete line of accessories.

BEFORE SETTING OVEN CONTROLS

Oven vent location

The oven vent is located **under the left side of the control panel** (See Fig. 1). When the oven is on, warm air passes through this vent. This venting is necessary for proper air circulation in the oven and good baking results. **Do not block the oven vent.**

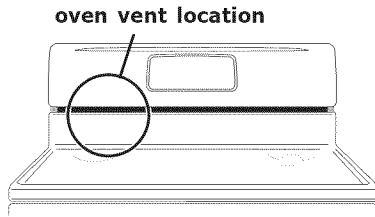

Fig. 1

Removing, replacing & arranging racks

To remove - pull the rack forward until it stops. Lift up front of rack and slide out.

To replace - fit the rack onto the guides on the oven walls. Tilt the front of the rack upward and slide the rack back into place.

Arranging - always arrange the oven racks when the oven is cool (prior to operating the oven).

Types of oven racks

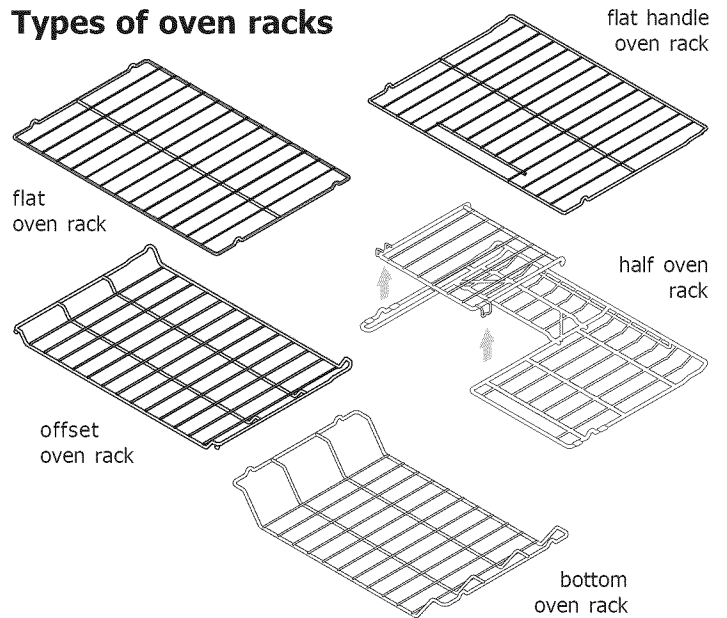

The **flat oven rack** or **flat handle oven rack** (some models) may be used for most cooking needs. The **half rack** (some models) design comes with a removable section that allows for taller cooking utensils. The **offset oven rack** (some models) is designed to place the base of the rack about 1/2 of a rack position lower than normal. This rack design provides several additional possible positions between the standard positions. To maximize oven cooking space place the **bottom oven rack** (some models) in the lowest rack position for baking or roasting large cuts of meat. The **Effortless™ Oven Rack** (some models) is described later in this section.

To maximize oven cooking space place the **bottom oven rack** (some models) in the lowest rack position for baking and when roasting large cuts of meat.

CAUTION

Always use oven mitts when using the oven. When using the appliance, oven racks and cooktop will become very hot which can cause burns.

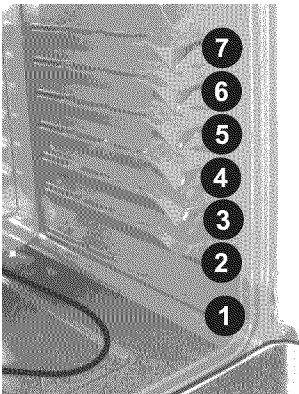

Oven with visible bake element - Fig. 2

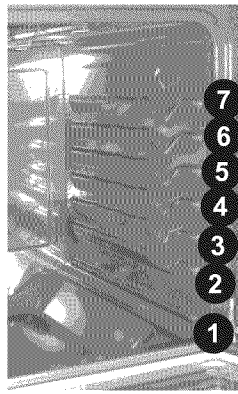

Oven with hidden Bake Element - Fig. 3*

IMPORTANT

Only the Effortless™ Oven Rack should be used in oven rack position 2. Placing any other rack in rack position 2 will prevent the oven door from fully closing.

Recommended rack positions by food type

Food type

Position models with visible bake element (Fig. 2)

Position models with hidden bake element (Fig. 3*)

Broiling meats	See broil section	See broil section
Cookies, cakes, pies, biscuits & muffins	4 or 5	4 or 5
Frozen pies, angel food cake, yeast, bread, casseroles	2 or 3	2 or 3
Small cuts of meat or poultry	1 or 2	1 or 2
Turkey, roast or ham	2	1 or 2

BEFORE SETTING OVEN CONTROLS

Effortless™ Oven Rack system

Some models are equipped with a special oven rack system that automatically partially extends the oven rack from the interior oven glides to assist in easier access to your food items. This feature works whenever the oven door is opened or closed.

To assemble the Effortless™ Oven Rack system:

1. Locate all required parts. You will need the supplied oven rack (Effortless™ Oven Rack is a flat rack with a special **dark coating** on the **left and right rack sides**) and the 2 supplied chrome connector arms.
2. Open the oven door. Be sure the oven is completely cool before proceeding.
3. Place the oven rack in positions **2, 3 or 4 only** (see previous page to verify positions). Be sure the rack connector brackets are at the rear of the range and pointing towards oven bottom (See Fig. 2).
4. Assemble one connector arm at a time. With the oven door open and the oven rack in place, install one end of the connector arm to the hole in the **door connector bracket** (Fig. 1) and the other end in the hole in the **rack connector bracket** (Fig. 2 and as in Fig. 3). The oven rack may need to be adjusted in or out in the rack position to match the length of the connector arm.
5. While holding the connector arm in place, twist the connector arm so the ends of the connector arm point **upwards** (See Figs. 4 & 5). The connector arm should now be locked into position.
6. Repeat steps 4 and 5 for the other connector arm.
7. Once both connector arms are properly in place, be sure to test the oven rack operation by gently closing the oven door. The oven rack should move in and out of the oven freely when the door is opened or closed.

CAUTION

REMOVE ALL OVEN RACKS and accessories before starting a self-clean cycle. If the oven racks are left in the oven during the self-clean cycle, the glide ability of the Effortless™ Oven Rack system will be damaged and will cause oven racks to lose their shiny finish and or turn blue. Remove **ALL** oven racks and clean according to instructions provided in the Care & Cleaning section of this manual.

Make sure the oven and oven racks are **COMPLETELY** cool and safe to touch before attempting to assemble or disassemble the Effortless™ Oven Rack system. **Never pick up hot oven rack parts.**

IMPORTANT

Only the Effortless™ Oven Rack system should be used in oven rack position 2. Placing ANY other rack in oven rack position 2 **will prevent the oven door from fully closing** and may damage the oven door, oven cavity or the door connector brackets.

If the rack system is not assembled with the connector arms the Effortless™ Oven rack may be used in oven rack positions 2 thru 6. Do not attempt to use the Effortless™ Oven rack in rack position 1.

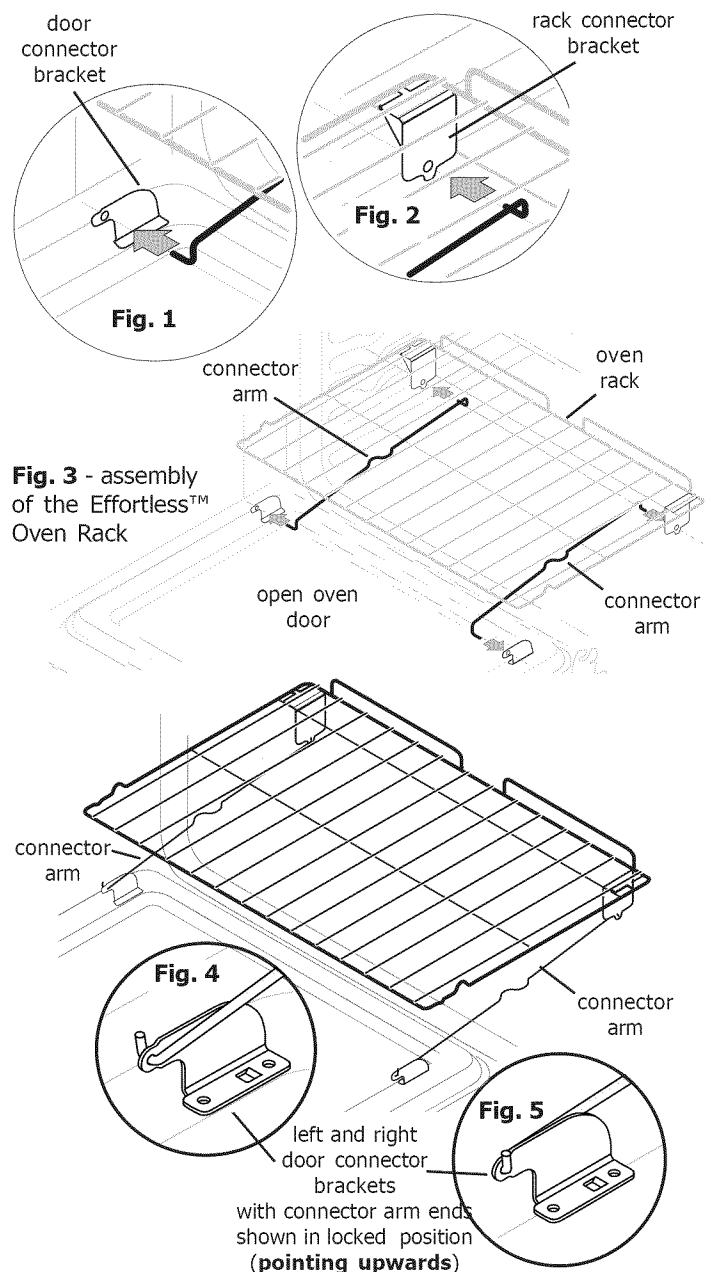

Fig. 6 - Effortless™ Oven Rack after assembly

BEFORE SETTING SURFACE CONTROLS

Air circulation in the oven

For best baking results allow 2-4" (5-10 cm) around the cookware for proper air circulation and be sure pans and cookware do not touch each other, the oven door, sides or back of the oven cavity. Hot air must be able to circulate around the pans and cookware in the oven for even heat to reach around the food.

Baking layer cakes with 1 or 2 oven racks

For best results when baking cakes using 2 oven racks, place cookware on rack positions 2 & 5 (See Fig. 1). For best results when using a single oven flat rack, place cookware on rack positions 2, 3 or 4 (See Fig. 2).

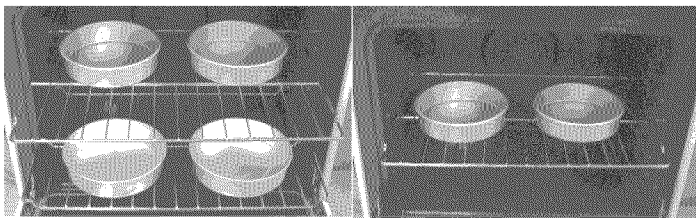

Fig. 1

Fig. 2

About the ceramic glass cooktop

The ceramic cooktop has radiant surface elements located below the surface of the glass. The design of the ceramic cooktop outlines the area of the surface element underneath. **Be sure** to match the pan size with the diameter of the element outline on the cooktop and only flat-bottomed cookware should be used.

The type and size of cookware, the number of surface elements in use and their settings are all factors that will affect the amount of heat that will spread to areas beyond the surface elements. The areas surrounding the elements may become **hot enough to cause burns**.



CAUTION

Unlike the surface elements, the **keep warm zone** will not glow red when it is **hot**.



NOTES

Radiant elements have a limiter that allows the element to cycle ON and OFF, even at the HI setting. This helps to prevent damage to the ceramic smoothtop. Cycling at the HI setting is normal and will occur more often if the cookware is too small for the radiant element or if the cookware bottom is not flat.

About the radiant surface elements

The element temperature rises gradually and evenly. As the temperature rises, the element will glow red. To maintain the selected setting the element will cycle ON and OFF. The heating element retains enough heat to provide a uniform and consistent heat during the off cycle.

For efficient cooking, turn OFF the element several minutes before cooking is complete. This will allow residual heat to complete the cooking process.

The **single** radiant elements will have one round outline pattern shown (See Fig. 3). The **keep warm zone** is designed to keep food warm only.

The **space wise** bridge feature allows the user to set the left front cooking element along with the left middle and if desired the left rear single elements into one combined cooking zone called the **space wise** bridge element (See Fig. 3). The left front and left rear elements may also be used as single independent heating elements whenever needed.

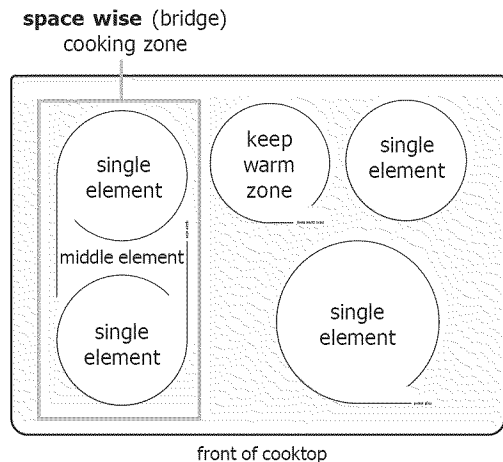
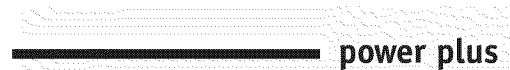

Fig. 3 (element and cooking zone locations on cooktop)

Power plus feature (some models)

Your appliance may be equipped with one or two elements on the ceramic cooktop marked **power plus**.



The power plus radiant element has a higher power level capability and is best used when bringing larger quantities of liquid to temperature or when preparing larger quantities of food.

BEFORE SETTING SURFACE CONTROLS

Cookware material types

The cookware material determines how evenly and quickly heat is transferred from the surface element to the pan bottom. The most popular materials available are:

Aluminum - Excellent heat conductor. Some types of food will cause it to darken (Anodized aluminum cookware resists staining & pitting). If aluminum pans slide across the ceramic cooktop, they may leave metal marks which will resemble scratches. Remove these marks immediately.

Copper - Excellent heat conductor but discolors easily. May leave metal marks on ceramic glass (see Aluminum).

Stainless - Slow heat conductor with uneven cooking results. Is durable, easy to clean and resists staining.

Cast Iron - A slow heat conductor however will retain heat very well. Cooks evenly once cooking temperature is reached. Not recommended for use on ceramic cooktops.

Porcelain-enamel on metal - Heating characteristics will vary depending on base material. Porcelain-enamel coating must be smooth to avoid scratching ceramic cooktops.

Glass - Slow heat conductor. Not recommended for ceramic cooktop surfaces because it may scratch the glass.

Using proper cookware

The size and type of cookware used will influence the setting needed for best cooking results. Be sure to follow the recommendations for using proper cookware as illustrated in Figs. 2 & 3.

Cookware should have flat bottoms that make good contact with the entire surface heating element (See Fig. 2). Check for flatness by rotating a ruler across the bottom of the cookware (See Fig. 3). For more information about the ceramic cooktop see "Cooktop Cleaning & Maintenance" in the **Care & Cleaning** section.

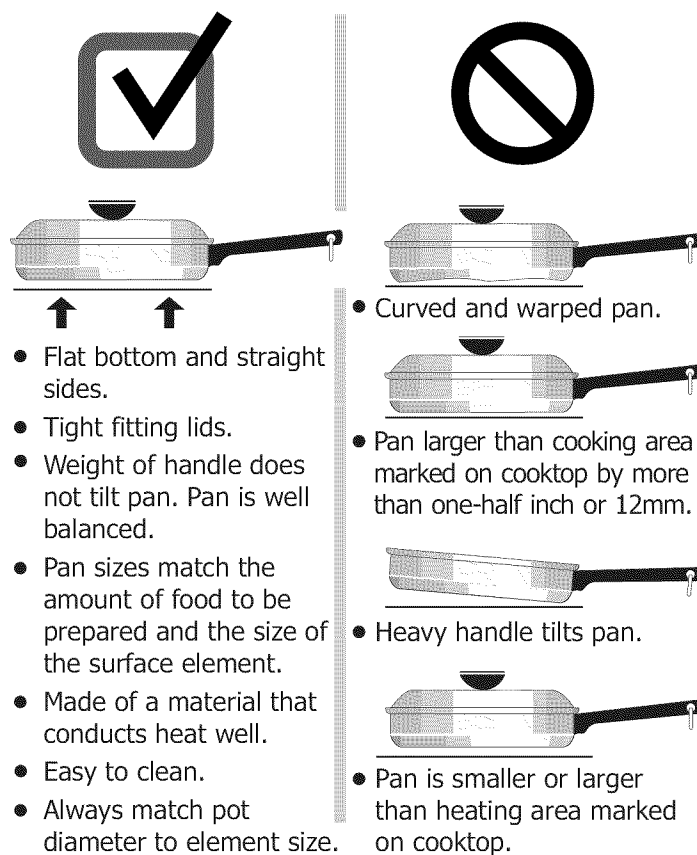

Fig. 2

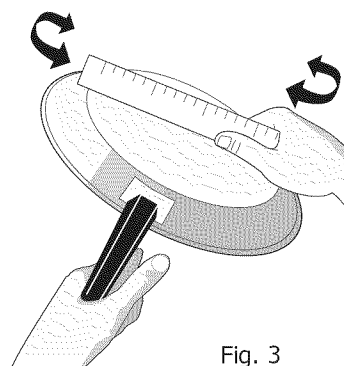

Fig. 3

BEFORE SETTING SURFACE CONTROLS

Cooktop element power level display windows

The cooktop element power level display features provide a digital display for each of the heating positions located on the cooktop. Power levels are easily controlled and monitored using the **window displays** in combination with the corresponding control touch pads.

The Triple radiant heating element (some models) has 3 cooking sizes to select from. This feature allows you to match the size of the element to the size of the cookware you are using.

Available power level settings

The cooktop control will display heat levels ranging from **Hi** (Fig. 1) to **Lo** (Fig. 6) and **OFF** (Fig. 7).

The settings between **9.5** (Fig. 2) and **3.0** (Fig. 3) decrease or increase in increments of .5 (1/2). The settings between **2.8** (Figs. 4) and **1.2** (Fig. 5) are Simmer settings which decrease or increase in increments of .2 to **Lo** (Fig. 6) for more precise settings at lower heat levels.

Use the “**Suggested power level settings table**” provided later in this section to determine the correct setting for the type of food you are preparing.

Hot surface window message (HE)

After using any radiant element the cooktop will be very hot. After turning any of these elements OFF, the cooktop will remain HOT for some time. The corresponding **HE** (hot element-Fig. 8) message will remain ON and turn OFF once that element position on the cooktop has cooled sufficiently (Fig. 7).

Lockout window message (- -)

The (- -) message will appear whenever the **lockout** feature is active (See Fig. 9). Refer to the lockout instructions for complete lockout instructions.

Sabbath Day feature (Sb) message

The display windows will show the **Sb** message whenever the Sabbath Day feature is active (Fig. 10). When activated, the Sabbath Day feature works for both the oven and cooktop together.

Once the **Sabbath Day** feature is active, changes to the heat levels for the cooktop elements will not show in the displays. The cooktop will react slower to heat level changes. See “Setting the Sabbath Day feature” for complete instructions.

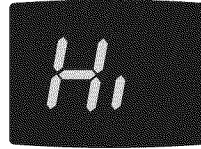

Fig. 1



Fig. 2



Fig. 3



Fig. 4

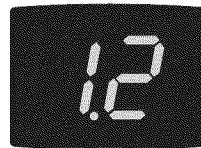

Fig. 5

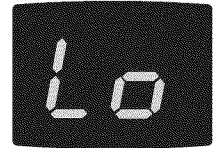

Fig. 6



Fig. 7

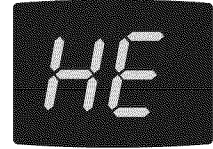

Fig. 8

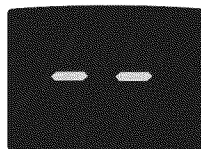

Fig. 9



Fig. 10

NOTE

When setting the size for all 3 bridge elements to heat together, both the display windows for the left front and left rear elements will display the set power level & hot element message (for models with a bridge surface element feature only).

SETTING SURFACE CONTROLS

Single radiant surface elements

The cooktop has several single radiant surface elements. Each surface element provides a constant amount of heat at each setting. A glowing red surface heating area extending beyond the bottom edge of the cookware indicates the cookware is **too small** for the surface heating area.

Start most cooking operations on a higher setting and then set to a lower setting to finish cooking. The suggested power level settings found in Fig. 1 are based when cooking with medium-weight aluminum pans with lids. Settings may vary when using other types of pans.

To operate a single radiant surface element:

- | Step | Press |
|---|-------------------------------|
| 1. Place correctly sized cookware on the radiant surface element. | |
| 2. Press and hold the on-off for the desired element position until a beep is heard. | on-off |
| 3. Press lo , med (5.0) or hi . | lo hi
v , med , ^ |

Each touch of the **lo** or **hi** pad will decrease or increase the power level by 1/2 from **9.5** through **3.0**. Simmer power levels between **3.0** and **1.2** will decrease or increase by .2 increments. **lo** is the lowest power level available.

- | | |
|--|--------|
| 4. Once cooking has completed, press on-off . | on-off |
|--|--------|

CAUTION

Radiant surface elements may appear to have cooled after they have been turned off. **The glass surface may still be hot** and burns may occur if the glass surface is touched before it has cooled sufficiently.

Do not place flammable items such as plastic salt and pepper shakers, spoon holders or plastic wrappings on top of the range when it is in use. These items could melt or ignite. Potholders, towels or wooden spoons could catch fire if placed too close to the surface elements.

Suggested power level settings table (for single, dual or triple elements)

Settings	Type of cooking
High (8.0-HI)	Start most foods, bring water to a boil, pan broiling
Medium high (5.0 - 8.0)	Continue a rapid boil, fry, deep fat fry
Medium (3.0 - 5.0)	Maintain a slow boil, thicken sauces and gravies or steam vegetables
Medium Low (2.0 - 4.0)	Keep foods cooking, poach, stew (2.8 or lower is a simmer setting)
Low (Lo - 2.0)	Keep warm, melt, simmer (2.8 or lower is a simmer setting)

Note: These settings are based when cooking with medium-weight aluminum pans with lids. Settings may vary when using other types of pans.

Fig. 1

IMPORTANT

The **HE** (hot element) message will appear in the display windows once a heating element is turned OFF and will remain ON until the heating surface area or areas have cooled sufficiently.

Do not allow aluminum foil, or ANY material that can melt to make contact with the ceramic glass cooktop. If these items melt on the cooktop they will damage the ceramic cooktop.

NOTE

The size and type of utensil used, and the amount and type of food being cooked will influence the setting needed for best cooking results.

SETTING SURFACE CONTROLS

Bridge cooking zone

The 3 left cooking zones may also be used together as a single cooking zone when setting for the Bridge feature. The **space wise bridge** cooking zone is marked on your cooktop. This feature provides the flexibility to cook with larger oblong cookware.

Indicator lights located on the backguard for the bridge element show which portions of the bridge element are set to heat.

The  symbol indicates only the left front element will

heat (Fig. 1). The  symbol indicates both the left front and left middle elements will heat together (Fig. 2).

The  indicates that all 3 elements (left front, middle and rear) will heat together (Fig. 3).

To operate one or more of the bridge radiant surface elements:

- | Step | Press |
|--|----------------------------------|
| 1. Place correctly sized cookware on the bridge radiant surface cooking zone. | |
| 2. Press and hold the on-off for the bridge element position until a beep is heard. | on-off |
| 3. Press the desired element size (once for left front, twice for left front and left middle, 3 times for left front, middle and rear). | size
■ |
| 4. Press lo , med (5.0) or hi . Each touch of the lo or hi pad will decrease or increase the power level by 1/2 from 9.5 through 3.0 . Simmer power levels between 3.0 and 1.2 will decrease or increase by .2 increments. lo is the lowest power level available. | lo , med , hi
∇ , , ∆ |
| 5. Once cooking has completed, press on-off . | on-off |

See the **Suggested power level settings table** (provided in the instructions for the single radiant elements). The size and type of utensil used, and the amount and type of food being cooked will influence the setting needed for best cooking results.

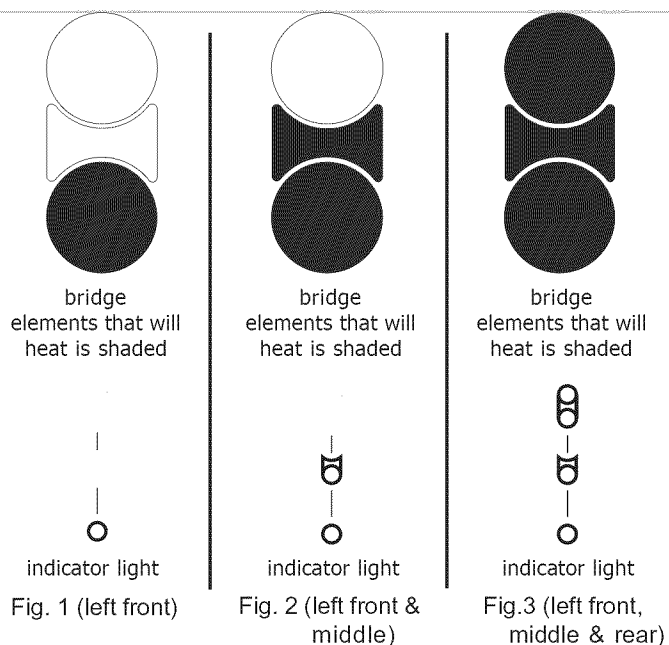

CAUTION

Radiant surface elements may appear to have cooled after they have been turned off. **The glass surface may still be hot** and burns may occur if the glass surface is touched before it has cooled sufficiently.



Do not place flammable items such as plastic salt and pepper shakers, spoon holders or plastic wrappings on top of the range when it is in use. These items could melt or ignite. Potholders, towels or wooden spoons could catch fire if placed too close to the surface elements.

IMPORTANT

The **HE** (hot element) message will appear in the display windows once a heating element is turned OFF and will remain ON until the heating surface area or areas have cooled sufficiently.

Do not allow aluminum foil, or ANY material that can melt to make contact with the ceramic glass cooktop. If these items melt on the cooktop they will damage the ceramic cooktop.

NOTES

If all 3 bridge zones are in use with the bridge feature and you need the left rear as a single element for a different reason, change the bridge size to  or  and then set the left rear position independently.

SETTING SURFACE CONTROLS

Keep warm zone

The purpose of the **keep warm** zone is to keep hot cooked foods at serving temperature. These include foods like; vegetables, gravies, casseroles, soups, stews, breads, pastries and oven-safe dinner plates.

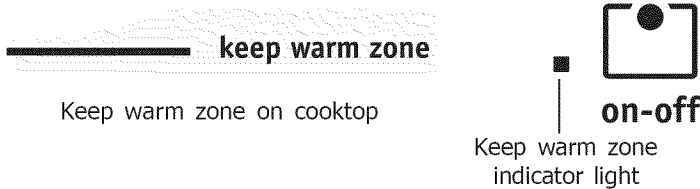

Always start with hot food. It is not recommended to heat cold food on the keep warm zone. All food placed on the keep warm zone should be covered with a lid to maintain quality.

For best results, when warming pastries or breads, the cover should have an opening to allow moisture to escape. **Do not use plastic wrap to cover food. Plastic may melt onto the surface and be very difficult to clean.** Use only dishware, utensils and cookware recommended for oven and cooktop use on the keep warm zone.

To operate keep warm zone:

- | Step | Press |
|--|--------|
| 1. Place cookware on keep warm zone . | |
| 2. Press on-off for the keep warm zone position (The keep warm indicator light will turn on). | on-off |
| 3. Press temp to choose desired temperature setting (Refer to Figs. 1, 2, 3 & 4). | temp |
| 4. When no longer needed, press on-off . | on-off |

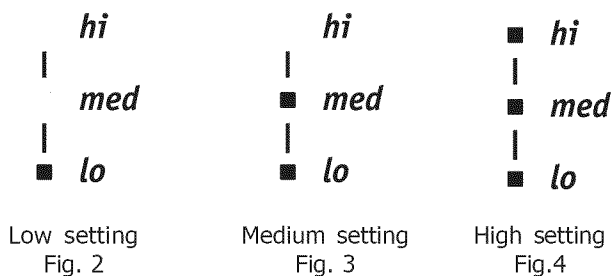

Keep warm zone temperature selection

If a particular food is not listed, start with the medium heat level, and adjust as needed. Most foods can be kept at serving temperatures by using the medium heat level (Refer to Fig. 1).

Keep warm zone recommended food settings table

Food Item	Heating Level
Breads/Pastries	lo (Low)
Casseroles	lo (Low)
Dinner plates with food	lo (Low)
Eggs	lo (Low)
Gravies	lo (Low)
Meats	med (Medium)
Sauces	med (Medium)
Soups (cream)	med (Medium)
Stews	med (Medium)
Vegetables	med (Medium)
Fried foods	hi (High)
Hot beverages	hi (High)
Soups (liquid)	hi (High)

Fig. 1

CAUTION

Unlike the surface elements, the keep warm zone will not glow red when it is hot.

Always use potholders or oven mitts when removing food from the **keep warm zone** as cookware and plates **will be hot**.

Radiant surface elements may appear to have cooled after they have been turned off. **The glass surface may still be hot** and burns may occur if the glass surface is touched before it has cooled sufficiently.

Do not place flammable items such as plastic salt and pepper shakers, spoon holders or plastic wrappings on top of the range when it is in use. These items could melt or ignite. Potholders, towels or wooden spoons could catch fire if placed too close to the surface elements.

IMPORTANT

Do not allow aluminum foil, or ANY material that can melt to make contact with the ceramic glass cooktop. If these items melt on the cooktop they will damage the ceramic cooktop.

SETTING SURFACE CONTROLS

Home Canning

Be sure to read and observe all the following points when home canning with your appliance. Check with the USDA (United States Department of Agriculture) website and be sure to read all the information they have available as well as follow their recommendations for home canning procedures.

- Use only quality flat bottom canners when home canning. Use a straight-edge to check canner bottom (see "Cookware material types" in the **Before setting surface controls** section).
- Use only a **completely flat bottom canner** with no ridges that radiate from the bottom center when home canning using a ceramic cooktop.
- **Make sure the diameter of the canner does not exceed 1 inch beyond the surface element markings or burner.** It is recommended to use smaller diameter canners on electric coil and ceramic glass cooktops.
- Start with hot tap water to bring water to boil more quickly.
- Use the highest heat setting when first bringing the water to a boil. Once boiling is achieved, reduce heat to lowest possible setting to maintain that boil.

IMPORTANT

NEVER place or straddle a cooking utensil over 2 different surface cooking areas at the same time. This may cause the ceramic cooktop to fracture.

CAUTION

Radiant surface elements may appear to have cooled after they have been turned off. **The glass surface may still be hot** and burns may occur if the glass surface is touched before it has cooled sufficiently.

Do not place flammable items such as plastic salt and pepper shakers, spoon holders or plastic wrappings on top of the range when it is in use. These items could melt or ignite. Potholders, towels or wooden spoons could catch fire if placed too close to the surface elements.

IMPORTANT

Do not allow aluminum foil, or ANY material that can melt to make contact with the ceramic glass cooktop. If these items melt on the cooktop they will damage the ceramic cooktop.

OVEN CONTROL FUNCTIONS

READ THE INSTRUCTIONS CAREFULLY BEFORE USING THE OVEN.

For satisfactory use of your oven, become familiar with the various pad functions of the oven as described below.

delay start — Use with **bake, convection, convection** and **self-clean** features to program a delayed time bake or delayed self-cleaning cycle.

timer on/off — Use to set or cancel the minute timer.

set clock pad — Use to set the time of day.

my favorite — Use to store & recall favorite recipes.

bake — Use to set the normal Bake feature.

oven light — Use to turn the oven light ON and OFF.

oven lockout — Use to activate oven lockout setting.

bake time — Use to enter the length of baking time needed.

delay start

set clock

my favorite



powerplus preheat — Use to quickly preheat the oven.

broil — Use to set broil feature.

bake time

timer on/off

my favorite

keep warm — Use to set the keep warm features.

self-clean — Use to set a 2, 3 or 4 hour self-clean cycle.

convection — Use to set the convection bake or roast features.



bake broil convection pizza chicken nuggets

powerplus preheat

keep warm

self clean

convection convert

add a min

convection convert — Use to convert a standard bake recipe to a convection bake recipe.

add a min — Use to add minutes to the timer.

pizza — Use to set the pizza features.

chicken nuggets — Use to set the chicken nuggets feature.

1 2 3

4 5 6

7 8 9

start 0 cancel

start — Use to start all oven features (not used with oven light).

cancel — Use to cancel any oven mode previously entered except the oven lockout, time of day & minute timer. Press **cancel** to stop cooking.

Minimum & maximum control settings

All of the features listed have minimum and maximum time or temperature settings that may be entered into the control. An ENTRY acceptance beep will sound each time a control pad is touched (the Oven Lockout pad is delayed by 3 seconds).

An ENTRY ERROR tone (3 short beeps) will sound if the entry of the temperature or time is below the minimum or above the maximum settings for the feature.

Feature	Min. temp. /time	Max. temp. /time
quick preheat temp.	170°F / 77°C	550°F / 288°C
bake temp.	170°F / 77°C	550°F / 288°C
broil temp.	400°F / 205°C	550°F / 288°C
timer	1 Min.	11 Hrs. 59 Mins.
self-clean time	2 hours	4 hours
convection bake	170°F / 77°C	550°F / 288°C
convection roast	170°F / 77°C	550°F / 288°C
convection broil*	170°F / 77°C	550°F / 288°C
pizza	300°F / 149°C	550°F / 288°C
chicken nuggets	300°F / 149°C	550°F / 288°C

*some models

SETTING OVEN CONTROLS

Setting the clock

When the range is first powered up, "12:00" will flash in the display (See Fig. 1).

To set the clock to 1:30:

Step	Press
1. Press set clock .	set clock
2. Enter 1:30 .	1 3 0
3. Press start .	start

NOTE

It is recommended to always set the clock for the correct time of day before using the appliance. The clock cannot be changed whenever any timed or delayed time feature is active.



Fig. 1

Changing between continuous bake setting or 6-Hour Energy Saving feature

The oven control has a factory preset built-in 6 Hour Energy Saving feature that will turn off the oven if the oven is left on for more than 6 hours. The control can be programmed to override this feature to continuously bake.

To turn off 6-Hour Energy saving mode:

Step	Press
1. Press and hold timer on•off for 6 seconds.	timer on • off
2. Press self-clean to toggle between "6 Hr OFF" (Fig. 2) or "StAY On" (Fig. 3). Select "StAY On" to turn off 6-Hour Energy Saving mode.	self clean
3. Press start to accept.	start



Fig. 2

Fig. 3

Setting 12 or 24 hour display modes

The clock display mode allows you to choose between 12 or 24 hr mode. The factory pre-set clock display mode is 12 hr. See the example below to change the default mode to 24 hr display.

To set 12 or 24 hour mode:

Step	Press
1. Press and hold set clock for 6 seconds.	set clock
2. Press self-clean to toggle between "12 Hr dAY" or "24 Hr dAY" display modes (See Figs. 4 & 5).	self clean
3. Press start to accept.	start



Fig. 4

Fig. 5

Changing oven temperature display

The oven control is preset to display °F (Fahrenheit) when shipped from the factory.

To change the temperature to display °C (Celsius) (oven should not have bake or self-clean active when setting this feature):

Step	Press
1. Press and hold broil for 6 seconds.	broil
2. Press self-clean to toggle between "FAhrn ht" or "CELSIUS" temperature display modes (Figs. 6 & 7). If Celsius display is needed, select "CELSIUS".	self clean
3. Press start to accept.	start

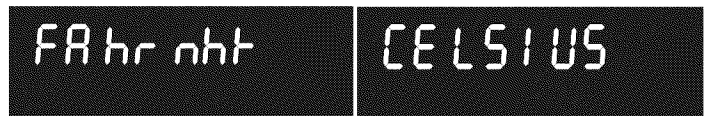

Fig. 6

Fig. 7

SETTING OVEN CONTROLS

Setting a silent control panel

Silent mode allows the oven control to operate without sounds. The control may be programmed for silent operation and later returned to operating with all the normal sounds.

To set silent mode:

- | Step | Press |
|--|--------------------|
| 1. Press and hold delay start for 6 seconds. | delay start |
| 2. Press self-clean to toggle between "bEEP On" or "bEEP OFF". Select "bEEP OFF" for silent mode. (Figs. 1 & 2) | self clean |
| 3. Press start to accept | start |

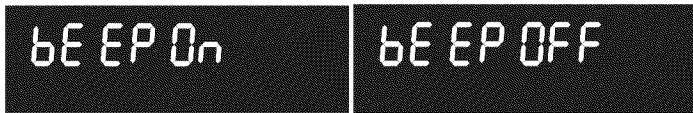



Fig. 1

Fig. 2

Setting lockout

The control may be programmed to lock the oven door, lockout the cooktop and oven control pads.

To set the lockout feature:

- | Step | Press |
|---|---|
| Press and hold lock pad for 3 seconds. "door Loc" will appear in the display until the oven door is completely locked. |  |

To unlock the lockout feature:

- | Step | Press |
|---|---|
| Press and hold lock pad for 3 seconds. Once the oven door has unlocked the "door Loc" message will no longer display (See Fig. 3). |  |

NOTES

DO NOT attempt to open the oven door while the "door Loc" (door lock) message is visible. Allow 15 seconds for the oven door to completely lock. Once the oven door has locked, the current time of day will reappear in the display. If a control pad is pressed when the oven lockout feature is active the control may triple beep which indicates the keypad action is not available when the oven lockout is active.



Fig. 3

Setting the minute timer

The timer allows you to track your cooking times without interfering with the cooking process. The timer may be set from 1 minute up to 11 hours and 59 minutes.

To set the timer for 5 minutes:

- | Step | Press |
|--------------------------------|---------------------|
| 1. Press timer on•off . | timer on•off |
| 2. Enter 5 minutes. | 5 |
| 3. Press start . | start |

Press **timer on•off** to turn the minute timer off.

NOTES

The minute timer will display hours and minutes until 1 hour remains on the timer. Once less than 1 hour remains, the display will count down in minutes and seconds. Once the timer has less than 1 minute remaining only seconds will display.

The minute timer DOES NOT start or stop the cooking process. It serves as an extra timer in the kitchen that will beep when the set time has run out. The minute timer can be used alone or while using any of the other oven features.

When the minute timer is in use during a cooking process, the minute timer will be shown in the display. To view the status of other features, press the pad once for the other feature to view the status of that feature.

Add a minute feature

Use the add 1 minute feature to set additional minutes to the timer. Each press of the key pad will add 1 additional minute. If add a minute key pad is pressed when the timer is not active, the timer will begin counting down from 1 minute.

To add 2 additional minutes to the active timer:

- | Step | Press |
|----------------------------------|------------------|
| Press add a minute twice. | add a min |

SETTING OVEN CONTROLS

Setting powerplus preheat

Use the powerplus preheat feature when **single rack baking** to quickly heat the oven to bake temperatures. Use this feature only for standard baking. A reminder tone will sound indicating when to place the food in the oven.

When the oven is finished preheating **powerplus preheat** will become just like the **bake** feature and continue to bake until cancelled.

To set powerplus preheat with a default oven set temperature of 350°F:

Step	Press
1. Press powerplus preheat .	powerplus preheat
2. Press start (See Fig. 1).	start



Fig. 1

Setting bake

Use the bake feature to cook most food items that require normal cooking temperatures. A reminder tone will sound once the oven reaches the set temperature. Bake can be set at any temperature from 170°F to 550°F.

To set bake using a default temperature of 350°F:

Step	Press
1. Press bake .	bake
2. Press start	start

To set bake for oven temperature of 425°F:

Step	Press
1. Press bake .	bake
2. Enter 425 .	4 2 5
3. Press start	start

NOTES

The oven will bake no longer than 6 hours from the last time the oven door was opened.

If you wish to continuously bake, see "Changing between continuous bake setting or 6-Hour Energy Saving feature" for further information.

Setting bake time

Use the timed bake feature to automatically turn the oven off after a desired length of time.

WARNING

FOOD POISONING HAZARD. Do not let food sit for more than one hour before or after cooking. Doing so can result in food poisoning or sickness.

To set bake to end after 30 minutes:

Step	Press
1. Press bake time .	bake time
2. Enter 30 minutes.	3 0
3. Press bake .	bake
4. Press start .	start

When the set bake time runs out:

- "END" will appear in the display window and the oven will shut-off automatically.
- The control will beep 3 times every 30 seconds as a reminder until the **cancel** key pad is pressed.

NOTES

The default maximum **bake time** setting is 6 hours.

After the **bake time** feature has been activated, press the **bake time** pad to display the bake time remaining.

The **bake time** feature may be set with the **convect bake** and **convect roast** features. Bake time will not operate with the broil feature.

The convection fan will begin rotating once the bake or bake time features are started. The convection fan will turn off once the set oven temperature is reached.

SETTING OVEN CONTROLS

To program oven for delayed bake time and to shut-off automatically

The delay start feature allows you to set a starting and ending time to the baking process. Prior to setting a delay start, be sure the time of day is set correctly. If the delay start needs to be set more than 12 hours in advance (12-24 hours), the control must first be programmed for 24 hour display mode. See "Setting 12 or 24 hour display modes" section.

WARNING

FOOD POISONING HAZARD. Do not let food sit for more than one hour before or after cooking. Doing so can result in food poisoning or sickness.

To program the oven for a delay start and to shut-off automatically (example for baking at 375°F for 50 minutes and starting at 5:30):

Step	Press
1. Press bake time .	bake time
2. Enter 50 minutes.	5 0
3. Press start .	start
4. Press delay start (See Fig. 1).	delay start
5. Enter 530 .	5 3 0
6. Press and hold start .	start
7. Enter 375 .	3 7 5
8. Press start .	start

When the set bake time runs out:

1. "**END**" will appear in the display window and the oven will shut-off automatically (See Fig. 2).
2. The control will beep 3 times every 30 seconds as a reminder until the **cancel** key pad is pressed.



Fig. 1



Fig. 2

NOTES

After the **delay start** feature has activated and started the cooking process, press the **bake time** pad to display the bake time remaining.

The **delay start** feature may be used with the **convect** or **convect convect** cooking features. Bake time will not operate when using the **broil** or **convect broil** features.

SETTING OVEN CONTROLS

Convect bake (all models)

Benefits of the convect feature

- Foods may cook up to 25 to 30% faster, saving time and energy.
- Multiple rack baking.
- No special pans or bakeware needed.

Convect uses a fan to circulate the oven's heat uniformly and continuously around the oven. This improved heat distribution allows for fast, even cooking and browning results. It also gives better baking results when using two racks at the same time.

Heated air flows around the food from all sides, sealing in juices and flavors. Breads and pastry brown more evenly. Layer cakes will have better results using the **bake** pad. Most foods baked in a standard oven can be cooked faster and more evenly with the **convect** feature.

Suggestions for convect baking

1. For optimum cooking results it is recommended to preheat the oven when baking foods such as cookies, biscuits and breads.
2. Reduce oven temperature 25°F from recipe's recommended oven temperature. Follow the remainder of the recipe's instructions using the minimum recommended cook time.
3. When using 2 oven racks at the same time, place in positions 2 & 5 for best results (Fig. 1).

Convect bake (all models)

To set convect (convection bake) with a default oven set temperature of 350°F:

- | Step | Press |
|-------------------------------------|----------------|
| 1. Press convect . | convect |
| 2. Press start (See Fig. 2). | start |



Fig. 2

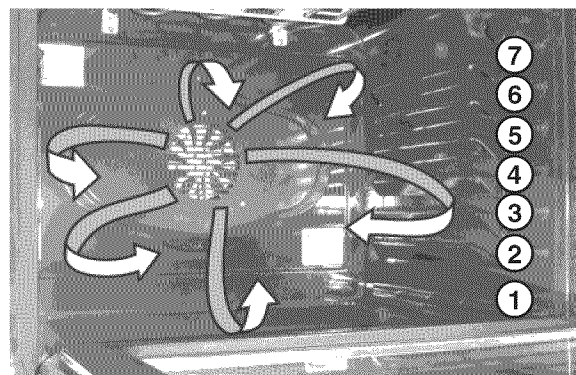

Fig. 1 (fan & lights may vary in appearance)

NOTES

When using convection bake cook time reductions may vary depending on the amount and type of food being cooked.

The convection fan will begin rotating once convection bake or convection roast has been activated.

Convect roast (all models)

Meats cooked with **convect roast** will be juicier and poultry will be crisp on the outside while staying tender and moist on the inside.

NOTE

When choosing between the **convect** features, use the convect keypad to **toggle between convect bake, convect roast or convect broil** (some models) choices.

Suggestion for convect roast

1. Preheating is not necessary when roasting foods using **convect roast**.
2. Since **convect roast** cooks food faster, reduce the cook time by 25% from the recommended cook time of your recipe (check the food at this time). If necessary, increase cook time until the desired doneness is obtained.
3. Do not cover foods when dry roasting - this will prevent the meat from browning properly.

To set convect roast (convection roast) with a default oven set temperature of 350°F:

- | Step | Press |
|-------------------------------------|----------------|
| 1. Press convect . | convect |
| 2. Press convect again. | convect |
| 3. Press start (See Fig. 3). | start |



Fig. 3

SETTING OVEN CONTROLS

Convect broil (some models*)

Use the convect broil feature to cook thicker cuts of meats that require direct exposure to radiant heat and the convection fan for optimum broiling results.

NOTE

* Some models are not equipped with the Convect broil feature. When using the convect key to toggle between the convect features models without the convection broil feature will only show the Convect Bake and Convect Roast option settings in the display.

Suggestions for convect broil:

1. Be sure to carefully follow all the recommended broil pan and insert instructions and the directions for placing the oven racks as provided in the "Broil" section in this Use & Care Guide.
2. Since **convect broil** cooks food faster, reduce the cook time by 25% from the recommended cook time of your recipe (check the food at this time). If necessary, increase cook time until the desired doneness is obtained.
3. **Close the oven door** when using convect broil.

To set convect broil* (convection broil) with a default oven set temperature of 550°F:

- | Step | Press |
|---------------------------------------|------------------------|
| 1. Press convect key 3 times*. | convect 3 times |
| 2. Press start (See Fig. 1). | start |



Fig. 1

NOTE

The convection fan will begin rotating once convection broil has been activated (some models).

Setting convect (convection) convert

The convect convert feature allows you to convert any baking recipe using the convect (convection) feature. The control uses the normal recipe settings and adjusts to a lower temperature for convection baking.

Convect convert can only be used with the convect bake feature.

To set convect using default oven set temperature of 350°F and adding the convect convert:

- | Step | Press |
|-----------------------------------|------------------------|
| 1. Press convect . | convect |
| 2. Press convect convert . | convect convert |

NOTES

When convect convert is used with a cook time or a delay start setting, the convect convert feature will display a "CF" for **check food** when the bake time is 75% complete (See Fig. 2). At this time the oven control will sound 1 long beep at regular intervals until the set cook time has finished.

The convection fan will begin rotating once convection bake or convection roast has been activated.

When using convect convert cook time reductions may vary depending on the oven set temperature.

The minimum amount of cook time allowed using the convect convert feature with a **bake time** or a **delay time bake** setting is 20 minutes.

Layer cakes will have better results using the normal **bake** feature.



Fig. 2

SETTING OVEN CONTROLS

Broil

Use the broil feature to cook meats that require direct exposure to flame heat for optimum broiling results. When broiling always remember to arrange the oven racks while oven is still cool. Position the oven rack as suggested in the **broil settings table** (See Fig. 4).

To set broil:

Step

Press

1. Place the broiler insert on the broil pan, then place meat on the insert. Remember to follow all warnings and cautions.
2. Arrange the interior oven rack to recommended position (Figs. 1 & 4). For optimum browning results, preheat oven for **5 minutes** before adding food.
3. Be sure to place food and pan directly under upper oven element. **Leave the oven door open.**
4. Press **broil**.
5. Press **start** (See Fig. 3)

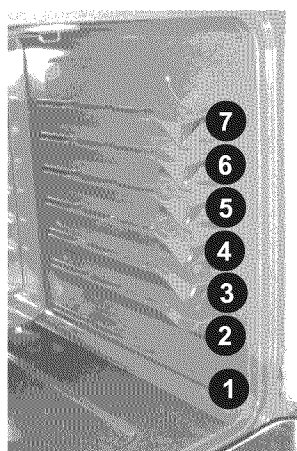

Fig. 1

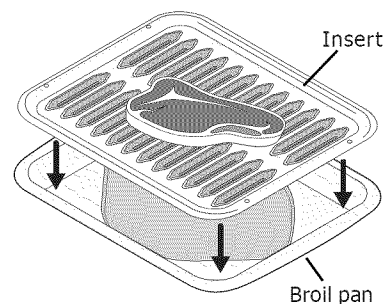

Fig. 2



Fig. 3

WARNING

Should an oven fire occur, close the oven door and turn the oven OFF. If the fire continues, use a fire extinguisher. **DO NOT** put water or flour on the fire. Flour may be explosive.

CAUTION

The broiler pan and the insert (some models) allows grease to drain and be kept away from the high heat of the broiler. **DO NOT** use the pan without the insert (Fig. 2). **DO NOT** cover the insert with foil; the exposed grease could ignite. **DO NOT** use the broil pan without the insert or cover the insert with **aluminum foil**. The exposed fat could ignite. To insure proper results use **ONLY** Electrolux Home Products, Inc. approved broil pan & insert.

NOTE

Always pull the oven rack out to the stop position before turning or removing the food.

Suggested broil settings table (electric oven)

Food	Rack position	Setting	Cook time in minutes		Doneness
			1st side	2nd side	
Steak 1" thick	6th or 7th*	550°F	6	4	Medium
Steak 1" thick	6th or 7th*	550°F	7	5	Medium-well
Steak 1" thick	6th or 7th*	550°F	8	7	Well
Pork chops 3/4" thick	6th	550°F	8	6	Well
Chicken-bone in	5th	450°F	20	10	Well
Chicken-boneless	6th	450°F	8	6	Well
Fish	6th	550°F	- as directed -	-	Well
Shrimp	5th	550°F	- as directed -	-	Well
Hamburger 1" thick	7th*	550°F	9	7	Medium
Hamburger 1" thick	6th	550°F	10	8	Well

*Use the bottom oven rack if you choose to use rack position 7.

Fig. 4

SETTING OVEN CONTROLS

Setting pizza feature

For your convenience the pizza feature provides 2 different settings. You may use the pizza feature whether starting with fresh or frozen pizza.

To set the pizza feature:

- | Step | Press |
|--|--------------|
| 1. Press pizza once to cook frozen pizza (Fig.1) or twice when setting for fresh pizza (Fig. 2). You may adjust the oven temperature to fit your needs. | pizza |
| 2. Press start | start |

NOTES

Use only 1 oven rack for best results when using the pizza feature.

The pizza setting is not timed. Be sure to monitor the time needed to finish cooking the pizza.

Follow package directions for cook time. Check pizza at the minimum recommended time.

The preset oven temperature for the frozen pizza setting is 425°F and the fresh pizza is 400°F.



Fig. 1



Fig. 2

Setting chicken nuggets feature

Use the chicken nuggets feature to cook convenience style chicken nuggets. The user may change the temperature or bake time at any time to fit their needs. Once the 20 minute preset cook time is finished the chicken nuggets feature will automatically set the oven to the **keep warm** feature for 3 hours. You may **cancel** the keep warm at any time if not needed.

To set the chicken nuggets feature:

- | Step | Press |
|------------------------------------|------------------------|
| 1. Press chicken nuggets . | chicken nuggets |
| 2. Press start (See Fig. 3) | start |



Fig. 3

Setting chicken nuggets feature (cont'd)

NOTES

After 20 minutes of cook time the **chicken nuggets** feature will automatically start the **keep warm** feature. If keep warm is not necessary, press cancel at any time to stop **keep warm**.

The **pizza** and **chicken nuggets** features will add the convection fan to the cooking process.

Setting keep warm

The keep warm feature will keep oven baked foods warm for serving up to 3 hours after cooking has finished. After 3 hours the keep warm feature will shut the oven off automatically.

The keep warm feature may be used without any other cooking operations or may be used after cooking has finished using **bake time** and or **delay start**.

WARNING

FOOD POISONING HAZARD. Do not let food sit for more than one hour before or after cooking. Doing so can result in food poisoning or sickness.

To set the oven to **keep warm**:

- | Step | Press |
|-----------------------------|------------------|
| 1. Press keep warm . | keep warm |
| 2. Press start . | start |
- "HLd" for hold will appear in the display (Fig. 4).



Fig. 4

NOTE

The keep warm feature will automatically turn the oven off after 3 hours.

SETTING OVEN CONTROLS

Adjusting the oven temperature

Your appliance has been factory calibrated and tested to ensure an accurate baking temperature. For the first few uses, follow your recipe times and temperature recommendations carefully. If you think the oven is cooking too hot or too cool for your recipe times, you can adjust the control so the oven cooks hotter or cooler than the temperature displayed.

The oven temperature may be increased +35°F (+19°C) or decreased -35°F (-19°C) from the factory settings.

Example: increase the oven temperature by 30°F:

Step	Press
1. Press and hold bake for 6 seconds.	bake
2. Enter 30.	3 0
3. Press start .	start

Example: decrease the oven temperature by 30°F:

Step	Press
1. Press and hold bake for 6 seconds.	bake
2. Enter 30.	3 0
3. Press self-clean .	self clean
4. Press start .	start

Operating the oven light

The interior oven light will automatically turn ON when the oven door is opened.

Press  to turn the interior oven light ON and OFF whenever the oven door is closed.

The interior oven light is located at the upper left rear wall of the oven interior and is covered with a glass shield. The glass shield must be in place whenever the oven is in use. The shield will protect the halogen bulb from food splatters.

To change the interior oven light, see "Changing the oven light" in the **Care & Cleaning** section.

NOTES

Oven temperature adjustments made will not affect the broil or self-cleaning feature temperatures.

If the temperature shows an adjustment of -30°F, and a +30°F adjustment is needed, you can toggle between the (-) or (+) in the display by pressing **self clean**.

DO NOT USE oven thermometers such as those found in grocery stores to check the temperature settings inside your oven. These oven thermometers may vary as much as 20 to 40 degrees from actual temperatures.

SETTING OVEN CONTROLS

My Favorite

The **my favorite feature** pad may be used to record and recall one of your favorite recipe settings. This feature will only store and recall one favorite recipe at a time.

My favorite feature may be used with bake, cook time, preheat, convection bake & roast, pizza, chicken nuggets and keep warm cooking features. This feature will not work with any other feature including delay start, broil or self-clean setting.

To record a favorite recipe setting (example shown to bake for 30 minutes with oven temperature of 325°F):

Step	Press
1. Press bake time .	bake time
2. Enter 30 minutes.	3 0
3. Press start .	start
4. Press bake .	bake
5. Enter 325 oven temperature.	3 2 5
6. Press start .	start
7. Press and hold my favorite pad for 3 seconds. The recipe was successfully stored when the heart icon appears in oven display (Fig. 1).	my favorite
8. Press cancel to stop the stored recipe from starting the oven immediately.	cancel

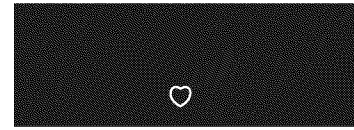

Fig.1

To recall a previously stored favorite recipe setting:

Step	Press
1. Press my favorite .	my favorite
2. Press start .	start

To erase a previously stored my favorite recipe setting:

Step	Press
1. Press my favorite .	my favorite
2. Press my favorite and hold	my favorite

until the **heart** icon disappears from the oven control display (See Fig. 1).

NOTES

If you do not wish the oven to turn ON after storing your favorite recipe be sure to press cancel in your last step.

Remember that **my favorite** feature stores or recalls only 1 recipe at any time.

If a different recipe is needed, you may record a new recipe over the old by following the example provided for "To record a favorite recipe setting." Or you may clear any previously stored recipe before recording a new recipe by following the steps provided "To erase a previously stored my favorite recipe setting."

SETTING OVEN CONTROLS

To Set the Sabbath Feature (for use on the Jewish Sabbath & Holidays)



For further assistance, guidelines for proper usage and a complete list of models with the Sabbath feature, please visit the web at <http://www.star-k.org>.



WARNING

FOOD POISONING HAZARD. Do not let food sit for more than one hour before or after cooking. Doing so can result in food poisoning or sickness.

The **bake time** and **delay start** pads are used to set the Sabbath feature. The Sabbath feature may only be used with the **bake** feature. The oven temperature may be set higher or lower after setting the Sabbath feature (the oven temperature adjustment feature should be used only during Jewish Holidays), however the display will not be visible and no audible tones will be provided when a change occurs.

Once the oven is properly set using the **bake** feature with the Sabbath mode active, the oven will remain continuously ON until cancelled. The Sabbath mode will override the factory preset 6-Hour Energy Saving feature.

If the oven light(s) are needed during the Sabbath, press the **oven light** pad **before** activating the Sabbath feature. Once the oven light is turned on and the Sabbath feature is active, the oven light will remain on until the Sabbath feature is turned OFF. If the oven light needs to be off, be sure to turn the oven light off before activating the Sabbath feature.

It is recommended that any oven temperature change with the Sabbath feature active be followed with 2 presses of the **start** pad. This will insure the oven remains ON even if the attempt to set the oven temperature was lower or higher than the oven control can accept. If the oven temperature is set incorrectly, the oven temperature will default to 170°F or 550°F. Try to set the desired oven temperature again.

To program the oven for 350°F bake and activate the Sabbath feature:

- | Step | Press |
|--|--------------------------------|
| 1. Be sure that the clock is set with the correct time of day. | |
| 2. Arrange the oven racks and place the food in the oven and close door. | |
| 3. Press bake . | bake |
| 4. Press start . | start |
| 5. If a timed bake or delayed timed bake is needed then enter the time in this step. If not, skip this step and continue to step 6. Refer to the bake time or delay start instructions. Remember the oven will shut-off after completing a timed bake or delay start and therefore may only be used once during the Sabbath/Jewish Holidays. The maximum delay start time is 11 hours & 59 minutes. | |
| 6. Press and hold both the bake time and delay start pads for at least 3 seconds simultaneously. The control will beep and SAb will appear in the display (See Fig. 1). The oven is properly set for the Sabbath once SAb appears in the display. | bake time + delay start |



Fig. 1

SETTING OVEN CONTROLS

To Set the Sabbath Feature (cont'd)

To turn off the oven but keep the Sabbath feature active:

Press **cancel**. cancel

To turn off the Sabbath feature:

Press and hold both the bake + delay
time + start
bake time and delay start pads
for at least 3 seconds. The control will beep and **SAb** will disappear from the display. The oven is no longer programmed for the Sabbath feature.

What to do during a power failure or power interruption after the Sabbath feature was activated:

Should you experience a power failure or interruption, the oven will shut-off. When power is restored the oven will not turn back on automatically. The oven will remember that it is set for the Sabbath and the oven display will show the message "SF" for Sabbath failure (Fig. 1).



Fig. 1

The food may be safely removed from the oven while still in the Sabbath feature, however the oven cannot be turned back on until after the Sabbath/Holidays.

After the Sabbath observance turn OFF the Sabbath feature. At the same time **press and hold both the**

bake + delay pads for at least 3 seconds.
time + start

SF will disappear from the display and the oven may be used with all normal functions.

NOTES

If a delay start time longer than 12 hours (maximum of 24 hours) in advance is desired, set the display mode for the 24 hour setting. For detailed instructions see the section "Setting 12 or 24 hour display modes".

It is not advised to attempt to activate any other program feature except **BAKE** while the Sabbath feature is active. **ONLY** the following key pads will function correctly with the Sabbath feature: **0-9 number pads**, **bake**, **start** & **cancel**. **ALL OTHER KEYPADS** should not be used once the Sabbath feature is activated.

You may change the oven temperature once baking has started. Press **bake**, enter the oven temperature change (170 to 550F°) and press **start** (for Jewish Holidays only). Remember that **the oven control will no longer beep or display any further changes** once the oven is set for the Sabbath feature.

If the **keep warm** feature was activated and the Sabbath feature was set the keep warm feature will automatically shut-off the oven off after 3 hours.

KEEP WARM DRAWER

Operating the keep warm drawer (some models)

The purpose of the keep warm drawer is to keep hot cooked foods at serving temperatures. It is not recommended to heat cold food in the keep warm drawer; always start with hot food.

The keep warm drawer may also be used to warm dinner plates. All food placed in the keep warm drawer should be covered with a lid or aluminum foil to maintain quality.

WARNING

- **Storage in or on appliance—flammable materials should not be stored in an oven, warmer drawer, near surface units.** This includes paper, plastic and cloth items, such as cookbooks, plasticware and towels, as well as flammable liquids. Do not store explosives, such as aerosol cans, on or near the range.
- **DO NOT LEAVE CHILDREN ALONE—children should not be left alone or unattended in the area where appliance is in use.** They should never be allowed to sit or stand on any part of the appliance, including the warmer drawer.

CAUTION

Always use potholders or oven mitts when removing food from the warmer drawer as cookware and plates will be hot and you can be burned.

IMPORTANT

Do not use plastic wrap to cover food. Plastic may melt onto the drawer and be very difficult to clean up. Use only utensils and cookware recommended by the manufacturer for use in the keep warm drawer.

Keep warm drawer indicator light

The keep warm drawer indicator light is located beside the **on-off** key (See Fig. 1). It turns on when the keep warm drawer is turned ON, and stays on until the keep warm drawer is turned OFF.

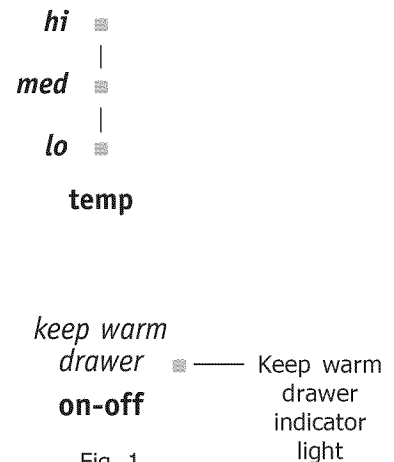

Fig. 1

Operating keep warm drawer

The electronic control located on the left side of the control panel is used to turn ON and set temperature settings for the keep warm drawer. Available temperature settings (2) are approximate, and are designated by **hi**, **med**, and **lo**. If needed, refer to **keep warm drawer recommended settings** list provided in this section.

To set the keep warm drawer:

- | Step | Press |
|--|---------------|
| 1. Arrange the keep warm drawer rack (if needed) in the keep warm drawer and place the food or dishes in the keep warm drawer. | |
| 2. Press on/off from the keep warm drawer control. | on-off |
| The keep warm indicator light will turn ON (See Fig. 1). | temp |
| 3. Press temp to choose desired temperature setting (high, medium or low-See Fig. 2). | on-off |
| 4. Once warming is finished, press on/off to turn OFF. | |

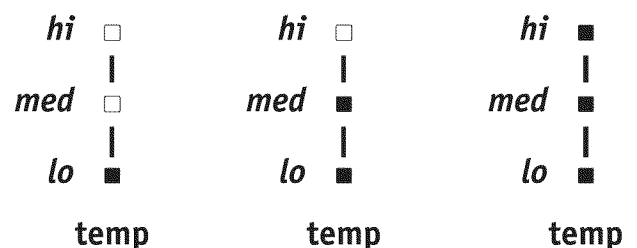

Fig. 2

KEEP WARM DRAWER

Keep warm drawer recommended settings

Recommended keep warm drawer food settings table is shown in Fig. 1. If a particular food is not listed, start with the **med** (medium) setting. If more crispness is desired, remove the lid or aluminum foil from the food.

Most foods can be kept at serving temperatures on the **med** setting. When a combination of foods are to be kept warm (for example, a meat with 2 vegetables and rolls) use the **hi** setting. To avoid heat loss, do not open the keep warm drawer often while in use.

Keep warm drawer recommended food settings	
Food Item	Setting
Bacon	hi
Hamburger patties	hi
Poultry	hi
Pork chops	hi
Fried foods	hi
Pizza	hi
Gravies	med
Casseroles	med
Eggs	med
Roasts (beef, pork or lamb)	med
Vegetables	med
Biscuits	med
Rolls (hard)	med
Pastries	med
Rolls (soft)	lo
Empty dinner plates	lo

Fig. 1

NOTES

- The keep warm drawer heating level may be adjusted at any time whenever the keep warm drawer is ON.
- The keep warm drawer will not operate whenever operating a self-cleaning cycle.
- Each time a pad is touched a beep will sound. If no further pads are touched within 10 seconds the request to turn the keep warm drawer ON will clear.

Arranging keep warm drawer rack positions

The keep warm drawer rack may be used in 2 ways:

- In the **upright position** to allow low profile food items to be placed both under and on top of the rack (for example, rolls or biscuits on top of the rack and a casserole dish underneath).
- In the **downward position** to allow you to place light weight food items and empty cookware (for example, rolls or pastries and dinner plates) on the rack.

Set the keep warm drawer rack in either position as shown below (Figs. 2 & 3).

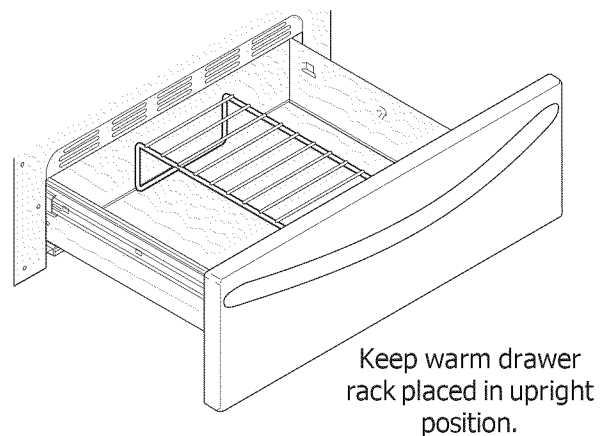

Fig. 2

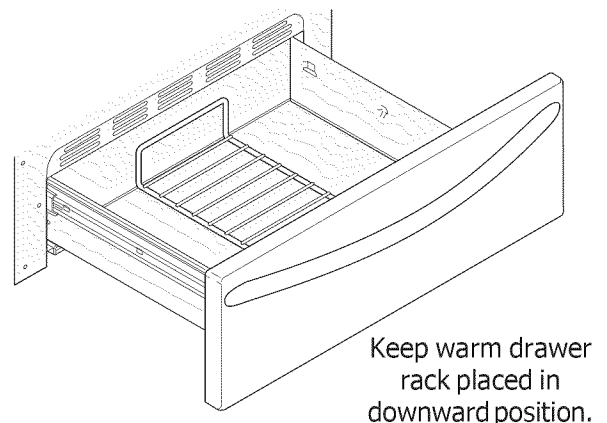

Fig. 3

Self-cleaning

A self-cleaning oven cleans itself with high temperatures (well above normal cooking temperatures) which eliminate soils completely or reduces them to a fine powdered ash you can wipe away with a damp cloth.

Your oven allows you to set 3 different self-cleaning cycle durations. A 3-hour cleaning time is best used for normal cleaning; 2-hour time for light soils and a 4-hour time option for heavier burnt-on soils.

➔ IMPORTANT

Adhere to the following self-clean precautions:

- **DO NOT** use oven cleaners or oven protective coatings in or around any part of the oven interior.
- **DO NOT** clean the oven door gasket. The woven material of the oven door gasket is essential for a good seal. Care should be taken not to rub, damage or remove the gasket.
- **DO NOT** use any cleaning materials on the oven door gasket. Doing so could cause damage (See Fig. 1).
- **Remove the broiler pan and insert, all utensils and ANY ALUMINUM FOIL. These items cannot withstand high cleaning temperatures and will melt.**
- **Completely remove ALL OVEN RACKS and ANY ACCESSORIES. If the oven racks are not removed they will lose their special coating properties and no longer slide in and out of the oven cavity effortlessly.**
- **Remove any excessive spills.** Any spills on the oven bottom should be wiped-up and removed **before starting** the self-cleaning cycle. To clean, use hot, soapy water and a cloth. Large spills can cause heavy smoke or fire when subjected to high temperatures. **DO NOT** allow food spills with a high sugar or acid content (such as milk, tomatoes, sauerkraut, fruit juices or pie filling) to remain on the surface as they may leave a dull spot even after cleaning.
- Clean any soil from the oven frame, the door liner outside the oven door gasket and the small area at the front center of the oven bottom. These areas heat sufficiently to burn soil on. Clean with soap and water. These areas are shown in white (See Fig. 1).

⚠ CAUTION

During the self-cleaning cycle, the outside of the range can become very hot to the touch. **DO NOT** leave small children unattended near the appliance.

The health of some birds is extremely sensitive to the fumes given off during the self-cleaning cycle of any range. Move birds to another well-ventilated room.

DO NOT force the oven door open. This can damage the automatic door locking system. Use caution when opening the door after the self-cleaning cycle is completed. The oven may still be **VERY HOT**.

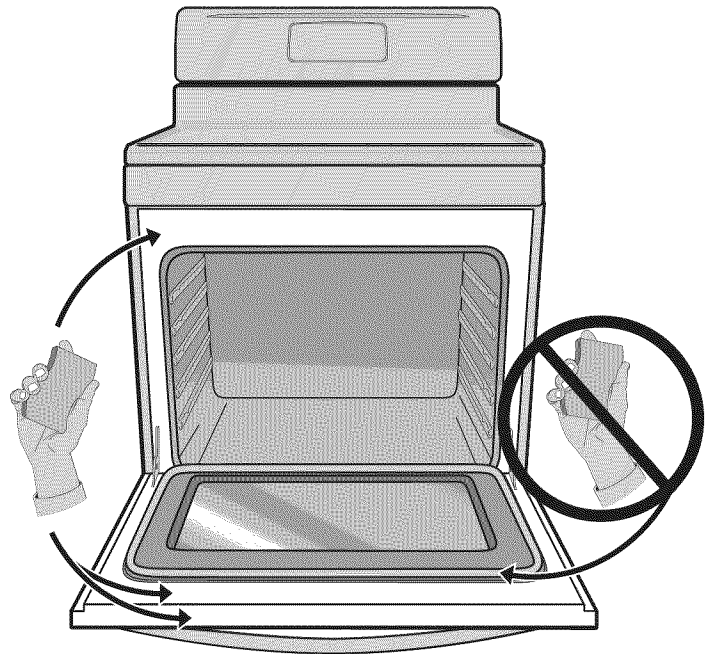

Fig. 1

SELF-CLEANING

Setting a self-clean cycle or a delayed start self-clean cycle

Examples: To start an immediate self-cleaning cycle and/or how to add a delay start time of 9:00 o'clock and shut-off self-clean automatically:

- | Step | Press |
|--|-------------|
| 1. Be sure the clock is set with the correct time of day, ALL the oven racks are removed and the oven door is closed. | |
| Go to step 5 if you wish to start the self-clean immediately. | |
| Finish steps 2 thru 6 if setting a delayed start self-clean cycle. | |
| 2. Press delay start . | delay start |
| 3. Enter 9 0 0 . | 9 0 0 |
| 4. Press start . | start |
| 5. Press self clean once for a 3-hour clean time, press self clean twice for 4-hour clean and press 3 times for a 2-hour self-clean cycle time. | self clean |
| 6. Press start . | start |

IMPORTANT

As soon as the controls are set, the motor driven door lock will begin to close automatically. "door Loc" will appear in the display (See Fig. 1). **DO NOT** open the oven door while "door Loc" is on (allow 15 seconds for the oven door to completely lock).

Once the door has locked "CLn" will appear in the display indicating the oven will begin the self-clean process (Fig. 2).



door Loc

Fig. 1



CLn

Fig. 2

When the self-clean cycle has completed:

1. The time of day and "Hot" will appear in the display window (See Fig.3).
2. Once the oven has cooled down for about 1 hour and "Hot" is no longer displayed the "door OPn" message should appear (Fig. 4). When this message turns off the oven door may be opened. Use **caution** and avoid possible burns when opening the door after the self-cleaning cycle has completed. The oven may still be **VERY HOT**.



Hot

Fig. 3



door OPn

Fig. 4

If it becomes necessary to stop a self-clean cycle once it has been activated:

1. Press **cancel**.
2. If the self-clean cycle has heated the oven to a high temperature, allow enough time for the oven to cool and for the "door OPn" message to appear (Fig. 4). When this message turns off the oven door may be opened.
3. Restart the self-clean cycle once all conditions have been corrected.

CAUTION

To avoid possible burns use care when opening the oven door after the self-cleaning cycle. **Stand to the side of the oven** when opening the door to allow hot air or steam to escape.

DO NOT force the oven door open. This can damage the automatic door locking system. Use caution and avoid possible burns when opening the door after the self-cleaning cycle has completed. The oven may still be **VERY HOT**.

NOTES

Whenever the self-clean feature is active you may check the amount of time remaining in the self-clean cycle by pressing the **self clean** pad once. The oven door will be locked until the range has cooled sufficiently. You will need to allow about **1 additional hour** to the time displayed before you can open the oven door.

When the oven is cool, wipe away any residue or powdered ash with a damp cloth or paper towel.

Cleaning recommendation table

Surface type	Recommendation
<ul style="list-style-type: none"> Aluminum (trim pieces) & vinyl Painted and plastic control knobs Painted body parts Painted decorative trim 	<p>Use hot, soapy water and a cloth. Dry with a clean cloth.</p> <p><i>For general cleaning, use hot, soapy water and a cloth. For more difficult soils and built-up grease, apply a liquid detergent directly onto the soil. Leave on soil for 30 to 60 minutes. Rinse with a damp cloth and dry. Do not use abrasive cleaners on any of these materials; they can scratch. To remove control knobs, turn to the OFF position; grasp firmly and pull straight off the shaft. To replace knobs after cleaning, line up the flat sides of both the knob and the shaft; then push the knob into place.</i></p>
<ul style="list-style-type: none"> Chrome control panel (some models) Decorative trim (some models) 	<p><i>Before cleaning the control panel, turn all controls to OFF and remove the control knobs. To remove, pull each knob straight off the shaft. Clean using hot, soapy water and a dishcloth. Rinse with a clean water using a dishcloth. Be sure to squeeze excess water from the cloth before wiping the panel; especially when wiping around the controls. Excess water in or around the controls may cause damage to the appliance. To replace knobs after cleaning, line up the flat sides of both the knob and the shaft; then push the knob into place.</i></p>
<ul style="list-style-type: none"> Easy Care™ Stainless Steel (some models) 	<p>If your range finish is Easy Care™ Stainless Steel (some models), clean the stainless with warm soapy water using a clean sponge or cloth. Rinse with clean water and dry with a soft clean cloth. DO NOT use ANY store bought cleaners like Stainless Steel cleaners or any other types of cleaners containing any abrasive, chlorides, chlorines or ammonia. It is recommended to use mild dish soap and water or a 50/50 solution of water and vinegar.</p>
<ul style="list-style-type: none"> Porcelain enamel broiler pan and broiler pan insert (if equipped) Door liner, porcelain body parts, & keep warm drawer interior (if equipped) Storage drawer interior (if equipped) 	<p>Gentle scouring with a soapy scouring pad will remove most spots. Rinse with a 1:1 solution of clear water and ammonia. <i>If necessary</i>, cover difficult spots with an ammonia-soaked paper towel for 30 to 40 minutes. Rinse with clean water and a damp cloth, and then scrub with a soap-filled scouring pad. Rinse and wipe dry with a clean cloth. Remove all cleaners or the porcelain may become damaged during future heating. Do not use spray oven cleaners on the cooktop.</p>
<ul style="list-style-type: none"> Oven racks 	<p>Oven racks must be removed from oven before starting self-clean cycle. Clean by using a mild, abrasive cleaner following manufacturer's instructions. Rinse with clean water and dry.</p>
<ul style="list-style-type: none"> Oven door 	<p>Use soap & water to thoroughly clean the top, sides and front of the oven door. Rinse well. You may use a glass cleaner on the outside glass of the oven door. Do not immerse the door in water. Do not spray or allow water or the glass cleaner to enter the door vents. Do not use oven cleaners, cleaning powders or any harsh abrasive cleaning materials on the outside of the oven door. Do not clean the oven door gasket. On self-cleaning models the oven door gasket is made of a woven material which is essential for a good seal. Care should be taken not to rub, damage or remove this gasket.</p>
<ul style="list-style-type: none"> Ceramic cooktop 	<p>See "Cooktop Cleaning and Maintenance" later in the Care & Cleaning section.</p>

CARE & CLEANING

Cooktop maintenance

➔ IMPORTANT

Consistent and proper cleaning is essential to maintaining your ceramic glass cooktop.

Prior to using your cooktop for the first time, apply some of the cooktop cleaning cream supplied with your new appliance. Buff with a **non-abrasive** cloth or no-scratch cleaning pad. This will make cleaning easier when soiled from cooking. The special cooktop cleaning cream leaves a protective finish on the glass to help prevent scratches and abrasions.

Sliding aluminum or copper clad bottom pans on the cooktop can cause metal markings on the cooktop surface. These marks should be removed **immediately** after the cooktop has cooled using the cooktop cleaning cream. Metal marks can become permanent if not removed prior to future use.

Cookware (cast iron, metal, ceramic or glass) with rough or dirty bottoms can **mark or scratch** the cooktop surface.

Do not:

- Slide anything metal or glass across the cooktop.
- Use cookware with dirt or dirt build up on bottom; replace with clean cookware before using.
- Use your cooktop as a cutting board or work surface in the kitchen.
- Cook foods directly on the cooktop surface without a pan.
- Drop heavy or hard objects on the ceramic glass cooktop, they may cause it to crack.

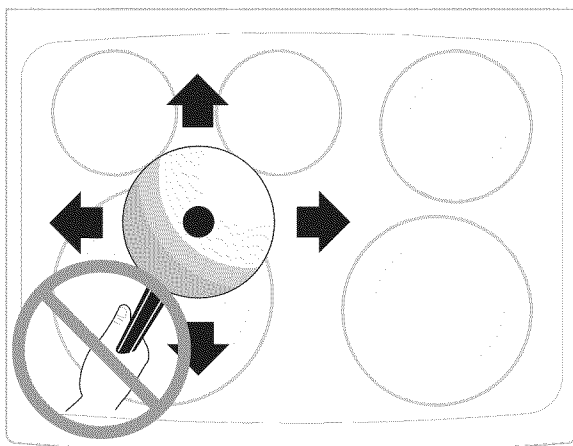

Cooktop cleaning

⚠ CAUTION

Before cleaning the cooktop, be sure the controls are turned to OFF and the cooktop is COOL.

For light to moderate soil:

Apply a few drops of CookTop® Cleaning Creme directly to the cooktop. Use a paper towel or use a non-abrasive plastic type no-scratch cleaning pad to clean the entire cooktop surface. Make sure the cooktop is cleaned thoroughly, leaving no residue.

For heavy, burned on soil:

Apply a few drops of CookTop® Cleaning Creme directly to the soiled area. Rub the soiled area using a non-abrasive plastic type no-scratch cleaning pad, applying pressure as needed. Do not use the pad you use to clean the cooktop for any other purpose.

If soils remain, carefully scrape soils with a metal razor blade scraper, holding scraper at a 30 degree angle to the surface. Remove loosened soils with cooktop cleaning cream and buff surface clean.

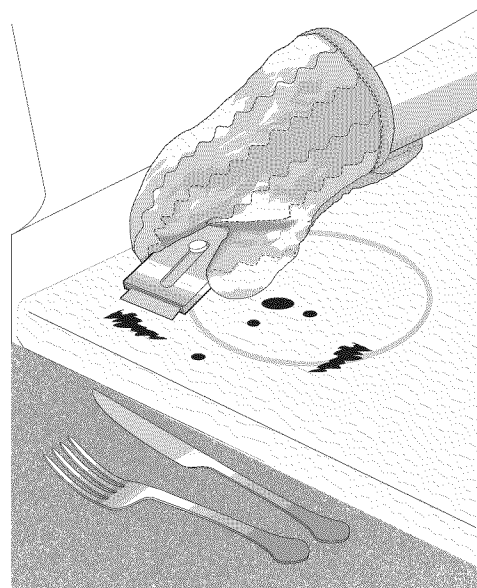

Cooktop cleaning (cont'd)

Plastic or foods with a high sugar content:

These types of soils need be removed immediately if spilled or melted onto the ceramic cooktop surface. Permanent damage (such as pitting of the cooktop surface) may occur if not removed **immediately**.

After turning the surface elements OFF, use a razor blade scraper or a metal spatula with a mitt and scrape the soil from the hot surface (as illustrated). Allow the cooktop to cool, and use the same method for heavy or burned on soils.

WARNING

DO NOT use a cooktop cleaner on a hot cooktop. The fumes can be hazardous to your health and can chemically damage the ceramic glass surface.

Do not use the following on the cooktop:

- Do not use abrasive cleaners and scouring pads, such as metal and some nylon pads. They may scratch the cooktop, making it more difficult to clean.
- Do not use harsh cleaners, such as chlorine bleach, ammonia or oven cleaners, as they may etch or discolor the cooktop.
- Do not use dirty sponges, cloths or paper towels, as they can leave soil or lint on the cooktop which can burn and cause discoloration.



IMPORTANT

Damage to the ceramic glass cooktop may occur if you use an abrasive type cleaning pad. Only use cleaning products that have been specifically designed for ceramic glass cooktops.

Caution for aluminum use on the cooktop

- **Aluminum Foil** - Use of aluminum foil on a hot cooktop will damage the ceramic cooktop. Do not use thin aluminum cooking utensils or allow aluminum foil to touch the ceramic cooktop under ANY circumstances.
- **Aluminum utensils** - The melting point of aluminum is much lower than that of other metals. Care must be taken when aluminum pots or pans are used on the cooktop. If aluminum pans are allowed to boil dry when using the cooktop, not only will the utensil be damaged or destroyed, but it may fuse to, break or mark the ceramic glass surface, permanently damaging the cooktop surface.

Replacing the oven interior light

CAUTION

Be sure the range is unplugged and all parts are COOL before replacing oven light. Wear a leather-faced glove for protection against possible broken glass.

The interior oven light bulb is located at the rear oven cavity and is covered with a glass shield. The glass shield must be in place whenever the oven is in use (See Fig. 1).

Replacing the oven interior light bulb:

1. Turn electrical power off at the main source or unplug the appliance.
2. Remove interior oven light shield (See Fig. 1).
3. Replace bulb with a new **T-4 type 40 Watt Halogen** appliance bulb. Please note: do not allow your fingers to touch the new bulb when replacing. This will shorten the life of the new bulb. Use a paper towel to cover the new bulb when installing.
4. Replace glass interior oven light shield.
5. Turn power back on again at the main source (or plug the appliance back in).
6. Be sure to reset the time of day on the clock.

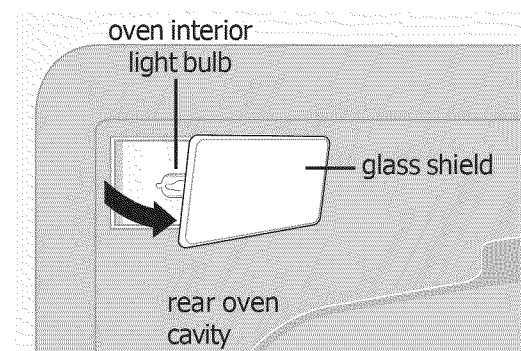

Fig. 1

CARE & CLEANING

Removing and replacing the lift-off oven door

CAUTION

The door is heavy. For safe, temporary storage, lay the door flat with the inside of the door facing down.

To remove oven door:

1. Open oven door completely (horizontal with floor - See Fig. 1).
2. Pull the door hinge locks on both left and right door hinges down from the oven frame completely towards the oven door (See Fig. 2). A tool such as a small flat-blade screwdriver may be required.
3. Firmly grasp both sides of oven door along the door sides (Do not use the oven door handle - See Fig. 3).
4. Close the door to the broil stop position (the oven door will stop into this position just before fully closing).
5. With the oven door in the broil stop position, lift the oven door hinge arms over the roller pins located on each side of the oven frame (See Fig. 4).

To replace oven door:

1. Firmly grasp both sides of oven door along the door sides (Do not use the oven door handle - See Fig. 3).
2. Holding the oven door at the same angle as the removal position, seat the hook of the hinge arm over the roller pins located on each side of the oven door frame (See Fig. 4). The hook of the hinge arms must be fully seated onto the roller pins.
3. Fully open the oven door (horizontal with floor - See Fig. 1).
4. Push the door hinge locks up towards and into the oven frame on both left and right oven door hinges (See Fig. 2) to the locked position.
5. Close the oven door.

Special door care instructions - Most oven doors contain glass that can break.

Read the following recommendations:

1. Do not close the oven door until all the oven racks are fully in place.
2. Do not hit the glass with pots, pans, or any other object.
3. Scratching, hitting, jarring or stressing the glass may weaken its structure causing an increased risk of breakage at a later time.

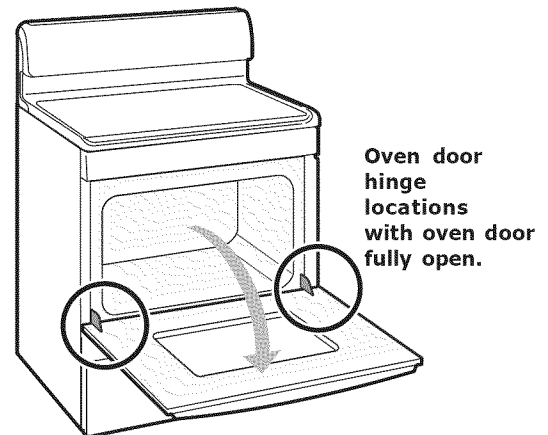

Fig. 1

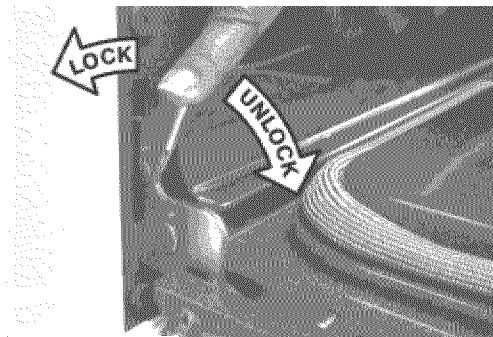

Fig. 2

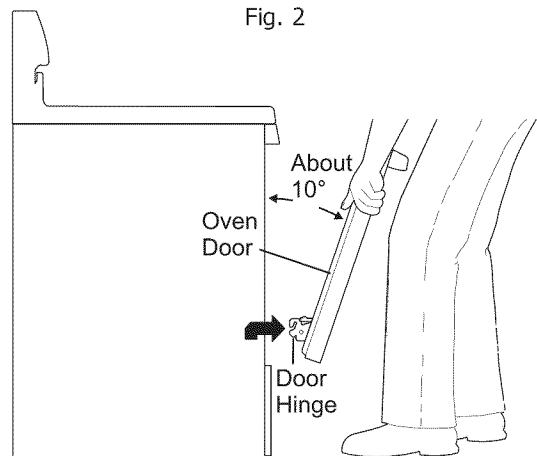

Fig. 3

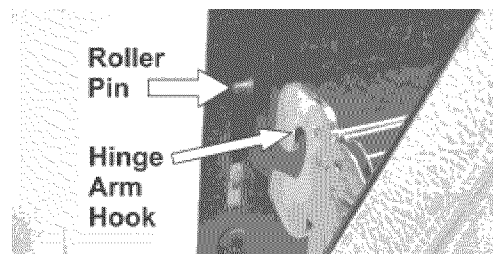

Fig. 4

Problem	Solution
Poor baking results.	<ul style="list-style-type: none"> • Many factors affect baking results. Make sure the proper oven rack position is used. Center food in the oven and space pans to allow air to circulate. Allow the oven to preheat to the set temperature before placing food in the oven. Try adjusting the recipe's recommended temperature or baking time. If you feel the oven is too hot or cool, see "Adjusting Oven Temperature" section in this Use & Care Guide.
Appliance is not level.	<ul style="list-style-type: none"> • Be sure floor is level, strong & stable enough to adequately support range. • If floor is sagging or sloping, contact a carpenter to correct the situation. • Poor installation. Place oven rack in center of oven. Place a level on the oven rack. Adjust leveling legs at base of appliance until the rack is level. • Kitchen cabinet alignment may make range appear not level. Be sure cabinets are square & have sufficient room for appliance clearance.
Cannot move appliance easily. Appliance must be accessible for service.	<ul style="list-style-type: none"> • Cabinets not square or are built in too tightly. Contact builder or installer to make appliance accessible. • Carpet interferes with appliance. Provide sufficient space so appliance can be lifted over carpet.
Surface element too hot or not hot enough.	<ul style="list-style-type: none"> • Incorrect control setting. Be sure the correct control is ON for the element that you are attempting to use.
Surface element does not heat.	<ul style="list-style-type: none"> • Lightweight or warped pans used. Use only flat, evenly balanced, medium or heavyweight cookware. Flat pans heat better than warped pans. Cookware materials and weight of the material affect heating. Heavy & medium-weight pans heat evenly. Because lightweight pans heat unevenly, foods may burn easily.
Entire appliance does not operate.	<ul style="list-style-type: none"> • The time of day is not set. The time of day must first be set in order to operate the oven. See "Setting the clock" in the Setting oven controls section. • Make sure cord/plug is plugged correctly into outlet. • Service wiring is not complete. Contact your dealer, installing agent or authorized service agent. • Electrical power outage. Check house lights to be sure. Call your local electric company for service.
Oven portion of appliance does not operate.	<ul style="list-style-type: none"> • Be sure the oven controls are set properly for the desired cooking feature. See Setting Oven Controls in this manual or read the instructions "Entire appliance does not operate" in this checklist.
Oven light does not work.	<ul style="list-style-type: none"> • Be sure the light is secure in the socket. Also see "Changing & replacing the oven light" section.
Self-cleaning cycle does not work.	<ul style="list-style-type: none"> • Oven control not set properly. Follow instructions under Self-cleaning. • Self-Cleaning cycle was interrupted. Follow steps under "Stopping or Interrupting a Self-cleaning cycle" under Self-cleaning.

BEFORE YOU CALL • Solutions to common problems

Problem	Solution
Soil not completely removed after self-cleaning cycle.	<ul style="list-style-type: none">• Failure to clean bottom, front top of oven, frame of oven or door area outside oven seal. These areas are not in the self-cleaning area, but get hot enough to burn on residue. Clean these areas before the self-cleaning cycle is started. Burned-on residue can be cleaned with a stiff nylon brush and water or a nylon scrubber. Be careful not to damage the oven gasket.
Oven smokes excessively during broiling.	<ul style="list-style-type: none">• Incorrect setting. Follow broiling instructions in Setting Oven Controls.• Make sure oven door is opened to broil stop position.• Meat too close to the broil element. Reposition the broil rack to provide proper clearance between the meat & the element. Preheat the broil element for searing.• Meat not properly prepared. Remove excess fat from meat. Cut remaining fatty edges to prevent curling, but do not cut into lean.• Broiler pan and insert wrong side up and grease not draining. Always place grid on the broiler pan with ribs up & slots down to allow grease to drip into pan (some models).• Grease has built up on oven surfaces. Regular cleaning is necessary when broiling frequently. Old grease or food spatters cause excessive smoking.
Flames inside oven or smoking from oven vent.	<ul style="list-style-type: none">• Excessive spillovers in oven. For example this will happen for pie spillovers or large amounts of grease left on the oven bottom. Wipe up excessive spillovers before starting oven. If flames or excessive smoke are present see "About broiling" in the Setting Oven Controls section.
Oven control panel beeps & displays any F code error (for example F10)	<ul style="list-style-type: none">• Oven control has detected a fault or error condition. Press CANCEL to clear the display & stop beeping. Try the bake or broil feature again. If the F code error repeats, remove power from appliance, wait 5 minutes and then repower appliance and set clock for the time of day. Try the bake or broil feature again. If the fault recurs, record fault and call for service.
Scratches or abrasions on cooktop surface.	<ul style="list-style-type: none">• Coarse particles such as salt or sand between cooktop and utensils can cause scratches. Be sure cooktop surface and bottoms of utensils are clean before usage. Small scratches do not affect cooking and will become less visible with time.• Cleaning materials not recommended for ceramic-glass cooktop have been used. See "Cooktop Cleaning and Maintenance" in the Care and Cleaning section of this Use & Care Guide.• Cookware with rough bottom has been used. Use smooth, flat-bottomed cookware.
Metal marks on the cooktop.	<ul style="list-style-type: none">• Sliding or scraping of metal utensils on cooktop surface. Do not slide metal utensils on cooktop surface. Use a ceramic-glass cooktop cleaning creme to remove the marks. See "Cooktop Cleaning and Maintenance" in the Care and Cleaning section.
Brown streaks or specks on cooktop surface.	<ul style="list-style-type: none">• Boilovers are cooked onto surface. Use razor blade scraper to remove soil. See "Cooktop Cleaning and Maintenance" in the Care & Cleaning section.
Areas of discoloration with metallic sheen on cooktop surface.	<ul style="list-style-type: none">• Mineral deposits from water and food. Remove using a ceramic-glass cooktop cleaning creme. Use cookware with clean, dry bottoms.

MAJOR APPLIANCE WARRANTY

Your appliance is covered by a one year limited warranty. For one year from your original date of purchase, Electrolux will pay all costs for repairing or replacing any parts of this appliance that prove to be defective in materials or workmanship when such appliance is installed, used and maintained in accordance with the provided instructions.

Exclusions This warranty does not cover the following:

1. Products with original serial numbers that have been removed, altered or cannot be readily determined.
2. Product that has been transferred from its original owner to another party or removed outside the USA or Canada.
3. Rust on the interior or exterior of the unit.
4. Products purchased "as-is" are not covered by this warranty.
5. Food loss due to any refrigerator or freezer failures.
6. Products used in a commercial setting.
7. Service calls which do not involve malfunction or defects in materials or workmanship, or for appliances not in ordinary household use or used other than in accordance with the provided instructions.
8. Service calls to correct the installation of your appliance or to instruct you how to use your appliance.
9. Expenses for making the appliance accessible for servicing, such as removal of trim, cupboards, shelves, etc., which are not a part of the appliance when it is shipped from the factory.
10. Service calls to repair or replace appliance light bulbs, air filters, water filters, other consumables, or knobs, handles, or other cosmetic parts.
11. Surcharges including, but not limited to, any after hour, weekend, or holiday service calls, tolls, ferry trip charges, or mileage expense for service calls to remote areas, including the state of Alaska.
12. Damages to the finish of appliance or home incurred during installation, including but not limited to floors, cabinets, walls, etc.
13. Damages caused by: services performed by unauthorized service companies; use of parts other than genuine Electrolux parts or parts obtained from persons other than authorized service companies; or external causes such as abuse, misuse, inadequate power supply, accidents, fires, or acts of God.

DISCLAIMER OF IMPLIED WARRANTIES; LIMITATION OF REMEDIES

CUSTOMER'S SOLE AND EXCLUSIVE REMEDY UNDER THIS LIMITED WARRANTY SHALL BE PRODUCT REPAIR OR REPLACEMENT AS PROVIDED HEREIN. CLAIMS BASED ON IMPLIED WARRANTIES, INCLUDING WARRANTIES OF MERCHANTABILITY OR FITNESS FOR A PARTICULAR PURPOSE, ARE LIMITED TO ONE YEAR OR THE SHORTEST PERIOD ALLOWED BY LAW, BUT NOT LESS THAN ONE YEAR. ELECTROLUX SHALL NOT BE LIABLE FOR CONSEQUENTIAL OR INCIDENTAL DAMAGES SUCH AS PROPERTY DAMAGE AND INCIDENTAL EXPENSES RESULTING FROM ANY BREACH OF THIS WRITTEN LIMITED WARRANTY OR ANY IMPLIED WARRANTY. SOME STATES AND PROVINCES DO NOT ALLOW THE EXCLUSION OR LIMITATION OF INCIDENTAL OR CONSEQUENTIAL DAMAGES, OR LIMITATIONS ON THE DURATION OF IMPLIED WARRANTIES, SO THESE LIMITATIONS OR EXCLUSIONS MAY NOT APPLY TO YOU. THIS WRITTEN WARRANTY GIVES YOU SPECIFIC LEGAL RIGHTS. YOU MAY ALSO HAVE OTHER RIGHTS THAT VARY FROM STATE TO STATE.

If You Need Service

Keep your receipt, delivery slip, or some other appropriate payment record to establish the warranty period should service be required. If service is performed, it is in your best interest to obtain and keep all receipts. Service under this warranty must be obtained by contacting Electrolux at the addresses or phone numbers below.

This warranty only applies in the USA and Canada. In the USA, your appliance is warranted by Electrolux Major Appliances North America, a division of Electrolux Home Products, Inc. In Canada, your appliance is warranted by Electrolux Canada Corp. Electrolux authorizes no person to change or add to any obligations under this warranty. Obligations for service and parts under this warranty must be performed by Electrolux or an authorized service company. Product features or specifications as described or illustrated are subject to change without notice.

USA
1.800.944.9044
Electrolux Major Appliances
North America
P.O. Box 212378
Augusta, GA 30907



Canada
1.800.265.8352
Electrolux Canada Corp.
5855 Terry Fox Way
Mississauga, Ontario, Canada
L5V 3E4