

NEED MORE INFO ON THE DTV TRANSITION ?
See page 13 in this User Manual and
please visit www.dtvtransition.org

HITACHI

Inspire the Next



LCD COLOR TELEVISION USER MANUAL L32A102 L32A102G

READ THE ENCLOSED INSTRUCTIONS CAREFULLY.
KEEP THIS USER MANUAL FOR FUTURE REFERENCE.
Record the serial number of your television for future reference.

MODEL NO. _____

SERIAL NO. _____

This serial number is located on the back and right side of the television.

If you have a question about this product please call 800-HITACHI for assistance

HIGH-DEFINITION TELEVISION
HDTV
TUNER

HDMI™
HIGH-DEFINITION MULTIMEDIA INTERFACE

Thank you for purchasing this HITACHI LCD Color Television.

The instructions in this manual are described mainly with use of the remote control.
You can also use the buttons on the TV if they have the same names as those on the remote control.
To obtain the best performance and safety, please read this manual carefully.
Please keep this manual for future reference.

Contents

Important Safety Instructions	3
Supplied Accessories	6
Preparation	6
Remote Control Batteries Installation	6
Using the Remote Control	6
Positioning the TV Set	7
Removing the Stand	7
Functional Overview	8
Front Panel	8
Side Panel	8
Rear Panel	8
Remote Control	9
Setting up your TV	10
Connecting an antenna, cable TV, or satellite TV	10
Connecting a standard video device.....	10
Connecting a component video device	11
Connecting a digital audio input	11
Connecting a computer	12
Using the basic controls	12
Turning the TV on and off	12
Adjusting the volume.....	12
Changing the video mode	12
Using your TV	12
Selecting the TV signal source	13
Changing channels	13
Using the on-screen menus	13
Memorizing channels	13
Manually editing channels	14
Viewing channel information	14
Adding favorite channels	14
Adjusting video settings	15
Adjusting audio settings	16
Using the Electronic Program Guide	16
Changing the channel settings	16
Adding a channel label	17
Adjusting timers settings	17
Adjusting setup settings	18
Setting the parental controls	19
PC input signal chart	25
Changing your computer's video resolution	25
Troubleshooting	25
Specifications	26
Service Information	27
Limited Warranty	28

Important Safety Instructions



 The lightning flash with arrowhead symbol, within an equilateral triangle, is intended to alert the user to the presence of uninsulated "dangerous voltage" within the product's enclosure that may be of a sufficient magnitude to constitute a risk of electric shock to a person.

 The exclamation point within an equilateral triangle, is intended to alert the user to the presence of important operating and maintenance (servicing) instructions in the literature accompanying the appliance.

READ BEFORE OPERATING EQUIPMENT

1. Read these instructions.
2. Keep these instructions.
3. Heed all warnings.
4. Follow all instructions.
5. Do not use this apparatus near water.
6. Clean only with a dry cloth.
7. Do not block any ventilation openings. Install in accordance with the manufacturer's instructions.
8. Do not install near any heat sources such as radiators, heat registers, stoves, or other apparatus (including amplifiers) that produce heat.
9. Do not defeat the safety purpose of the polarized or grounding-type plug. A polarized plug has two blades with one wider than the other. A grounding type plug has two blades and a third grounding prong. The wide blade or the third prong are provided for your safety. If the provided plug does not fit into your outlet, consult an electrician for replacement of the obsolete outlet.
10. Protect the power cord from being walked on or pinched particularly at plugs, convenience receptacles, and the point where they exit from the apparatus.
11. Only use the attachments/accessories specified by the manufacturer.
12.  Use only with the cart, stand, tripod, bracket, or table specified by the manufacturer, or sold with the apparatus. When a cart is used, use caution when moving the cart/apparatus combination to avoid injury from tip-over.
13. Unplug this apparatus during lightning storms or when unused for long periods of time.
14. Refer all servicing to qualified service personnel. Servicing is required when the apparatus has been damaged in any way, such as power-supply cord or plug is damaged, liquid has been spilled or objects have fallen into apparatus, the apparatus has been exposed to rain or moisture, does not operate normally, or has been dropped.

15. Grounding or Polarization- This product may be equipped with a polarized alternating-current line plug (a plug having one blade wider than the other). This plug will fit into the power outlet only one way. This is a safety feature. If you are unable to insert the plug fully into the outlet, try reversing the plug. If the plug should still fail to fit, contact your electrician to replace your obsolete outlet. Do not defeat the safety purpose of the polarized plug. Alternate Warnings - This product is equipped with a three-wire grounding-type plug, a plug having a third (grounding) pin. This plug will only fit into a grounding-type power outlet. This is a safety feature. If you are unable to insert the plug into the outlet, contact your electrician to replace your obsolete outlet. Do not defeat the safety purpose of the grounding-type plug.
16. Ventilation- Slots and openings in the cabinet are provided for ventilation and to ensure reliable operation of the product and to protect it from overheating, and these openings must not be blocked or covered. The openings should never be blocked by placing the product on a bed, sofa, rug, or other similar surface. This product should not be placed in a built-in installation such as a bookcase or rack unless proper ventilation is provided or the manufacturer's instructions have been adhered to.
17. The MAINS plug or an appliance couple is used as the disconnect device, the disconnect device shall remain readily operable.
18. Televisions are designed to comply with the recommended safety standards for tilt and stability. Do not apply excessive pulling force to the front, or top, of the cabinet which could cause the product to overturn resulting in product damage and/or personal injury.
19. Follow instructions for wall, shelf or ceiling mounting as recommended by the manufacturer.
20. An outdoor antenna should not be located in the vicinity of overhead power lines or other electrical circuits.
21. If an outside antenna is connected to the receiver be sure the antenna system is grounded so as to provide some protection against voltage surges and built up static charges. Section 810 of the National Electric Code, ANSI/NFPA No. 70-1984, provides information with respect to proper grounding for the mast and supporting structure, grounding of the lead-in wire to an antenna discharge unit, size of grounding connectors, location of antenna discharge unit, connection to grounding electrodes and requirements for the grounding electrode.

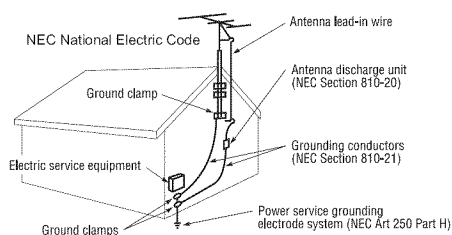

Note to the CATV system installer: This reminder is provided to call the CATV system installer's attention to Article 820-44 of the NEC that provides guidelines for proper grounding and, in particular, specifies that the cable ground shall be connected to the grounding system of the building, as close to the point of cable entry as practical.

End of life directives: Your new TV contains materials which can be recycled and reused. At the end of your TV's life, specialized companies can dismantle the discarded TV to concentrate the reusable materials and to minimize the amount of materials to be disposed of. Dispose of your old TV according to local regulations.

Safety Check

After completing any service or repair to this TV, ask the service technician to perform routine safety checks to determine that your TV is in correct operating condition.

Power source

Operate your TV only from the type of power source indicated on the marking label. If you are not sure of the type of power supplied to your home, consult your TV dealer or local power company.

The power cord is used as the disconnect device and shall remain readily operable.

Caution



To reduce the risk of electric shock, do not remove the cover or back. There are no user-serviceable parts inside. Refer servicing to qualified service personnel. To reduce the risk of fire or electric shock, do not expose your TV to rain or moisture.

Caution

To prevent electric shock, match the wide blade on the power cord plug to the wide slot on an electric outlet. If the plug does not fit, consult a licensed electrician to replace the obsolete outlet. Do not modify the power cord plug, or you will defeat this safety feature.

Warning

- To reduce the risk of fire or electric shock, do not expose this apparatus to rain or moisture.
- The LCD television should not be exposed to dripping or splashing and objects filled with liquids, such as vases, should not be placed on the television.
- This apparatus shall be connected to a mains socket outlet with a protective earthing connection.

Lead/Mercury Notice



This product contains lead and one or more non-replaceable mercury backlights. Do not put in trash. Recycle or dispose of according to applicable laws. For product recycling and disposal information, contact your local government agency or visit www.eiae.org (in USA) or www.epsc.ca (in Canada).
FOR MORE INFORMATION, CALL 800-HITACHI.

Public viewing of copyrighted material

Public viewing of programs broadcast by TV stations and cable companies, as well as programs from other sources, may require prior authorization from the broadcaster or owner of the video program material.

This product incorporates copyright protection technology that is protected by U.S. patents and other intellectual property rights. Use of this copyright protection technology must be authorized, and is intended for home and other limited consumer uses only unless otherwise authorized. Reverse engineering or disassembly is prohibited.

FEDERAL COMMUNICATIONS COMMISSION NOTICE

This equipment has been tested and found to comply with the limits for a Class B digital device, pursuant to Part 15 of the FCC Rules. These limits are designed to provide reasonable protection against harmful interference in a residential installation. This equipment generates, uses and can radiate radio frequency energy and if not installed and used in accordance with the instructions, may cause harmful interference to radio communications. However, there is no guarantee that interference will not occur in a particular installation. If this equipment does cause harmful interference to radio or television reception, which can be determined by turning the equipment off and on, the user is encouraged to try to correct the interference by one or more of the following measures:

- Reorient or relocate the receiving antenna.
- Increase the separation between the equipment and the receiver.
- Connect the equipment into an outlet on a circuit different from that to which the receiver is connected.
- Consult the dealer or an experienced radio/television technician for help.

Declaration of Conformity

This device complies with Part 15 of the FCC Rules. Operation is subject to the following two conditions :

- (1) This device may not cause harmful interference and
- (2) This device must accept any interference received, including interference that may cause undesired operation.

For questions regarding this declaration, contact:

Hitachi Home Electronics (America), Inc.
900 Hitachi Way
Chula Vista, CA 91914-3556
Tel. 800-448-2244 (800-HITACHI)
ATTN: Customer Relations

Modifications

The FCC requires the user to be notified that any changes or modifications made to this device that are not expressly approved by Hitachi Home Electronics (America), Inc, may void the user's authority to operate the equipment.

Cables

Connections to this device must be made with shielded cables with metallic RFI/EMI connector hoods to maintain compliance with FCC Rules and Regulations.

Any cables that are supplied with the system must be replaced with identical cables in order to assure compliance with FCC rules. Order Hitachi spares as replacement cables.

CHILD SAFETY:

It Makes A Difference How and Where
You Use Your Flat Panel Display

Congratulations on your purchase! As you enjoy your new product, please keep these safety tips on mind:



THE ISSUE

- The home theater entertainment experience is a growing trend and larger flat displays are popular purchases. However, flat panel displays are not always supported on the proper stands or installed according to the manufacturer's recommendations.
- Flat Panel displays that are inappropriately situated on dressers, bookcases, shelves, desks, speakers, chests or carts may fall over and cause injury.

HITACHI CARES!

- The consumer electronics industry is committed to making home entertainment enjoyable and safe.

TUNE INTO SAFETY

- One size does NOT fit all. Follow the manufacturer's recommendations for the safe installation and use of your flat panel display.
- Carefully read and understand all enclosed instructions for proper use of this product.
- Don't allow children to climb on or play with furniture and television sets.
- Don't place flat panel displays on furniture that can easily be used as steps, such as a chest of drawers.
- Remember that children can become excited while watching a program, especially on a "larger than life" flat panel display. Care should be taken to place or install the display where it cannot be pushed, pulled over, or knocked down.
- Care should be taken to route all cords and cables connected to the flat panel display so that they cannot be pulled or grabbed by curious children.

WALL MOUNTING: IF YOU DECIDE TO WALL MOUNT YOUR FLAT PANEL DISPLAY, ALWAYS:

- Use a mount that has been recommended by the display manufacturer and/or listed by an independent laboratory (such as UL, CSA, ETL).
- Follow all instructions supplied by the display and wall mount manufacturers.
- If you have any doubts about your ability to safely install your flat panel display, contact your retailer about professional installation.
- Make sure that the wall where you are mounting the display is appropriate. Some wall mounts are not designed to be mounted to walls with steel studs or old cinder block construction. If you are unsure, contact a professional installer.
- A minimum of two people are required for installation. Flat panel displays can be heavy.



 **CEA**
Consumer Electronics Association
www.CE.org/safety

Supplied Accessories

Check the supplied accessories before installation.
In case of missing or damaged, please contact the dealer immediately.

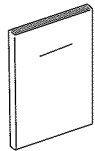

User Manual



Remote Control



Two AAA Batteries

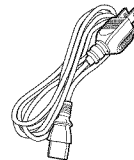

Power Cord

Preparation

Remote control Batteries Installation

1. Slide open the battery compartment cover in the direction of the arrow.
2. Insert two AAA batteries. Make sure the polarities match the indication inside the battery compartment.
3. Slide to close the battery compartment cover until it clicks.

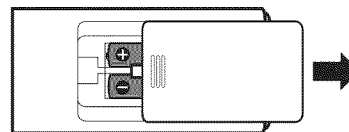

CAUTION:

- Do not insert batteries with '+' and '-' polarities reversed as this may cause the batteries to swell or rupture resulting in leakage.
- Never mix used and new batteries in the device.
- Replace all the batteries in the device at the same time.
- Remove the batteries if the remote control is not going to be used for an extended period of time.

Using the remote control

Point the remote control directly at your TV, within a 30° angle horizontally (15° to either side), and within 30° vertically of the remote control sensor on the front of your TV and within 26.25 feet (8 m) of your TV.

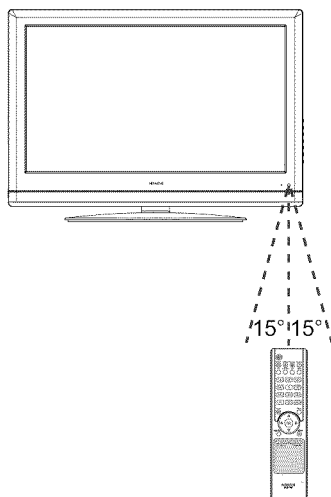

CAUTION:

- Do not expose the remote control to liquids, direct sunlight, or shock. Do not mix batteries of different types.
- Objects between the remote control and the remote control sensor may block the remote control signal.
- The range of the remote control may be diminished if direct sunlight or other strong light is shining on the remote control sensor. In this case, change the angle of the lighting, move your TV, or operate the remote control closer to the remote control sensor.

Preparation

Positioning the TV Set

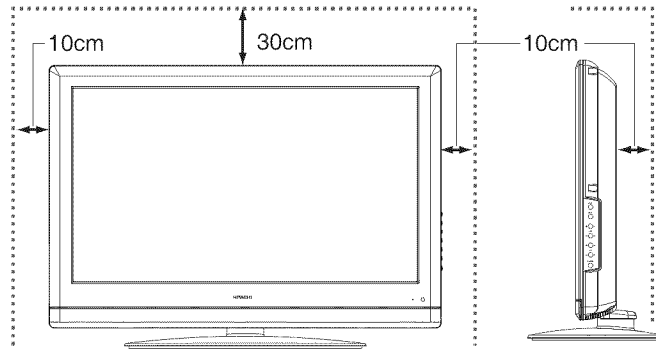

Place the TV on a firm and flat surface, leaving a space of at least 10cm around the set and 30cm from the top of the set to wall.

Removing the stand

- Before mounting the TV on the wall, the TV stand must be removed.
- Before detaching (or attaching) stand, unplug the AC cord from the AC input terminal.
- For wall bracket installation, please refer to the Installation Manual of the Wall Bracket Unit.

1

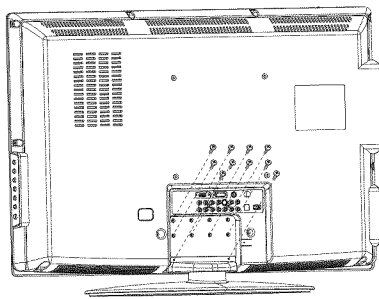

TV STAND

Unfasten the ten screws used to secure the stand in place.

2

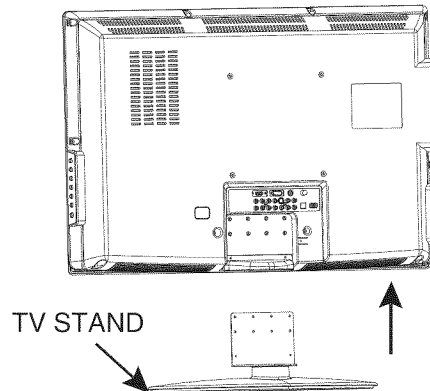

Remove the TV stand with two hands.

CAUTION

Although this LCD Television can be installed using a variety of third party wall mounting brackets/devices, such third party brackets/devices have not been tested or approved by Hitachi for use or compatibility with this LCD Television. Accordingly, Hitachi accepts no responsibility or liability for any injuries or property damage resulting from the use of such third party brackets/devices. Hitachi strongly advises that any installation of this LCD Television using wall mounting brackets/devices be performed only by a qualified and experienced television installation technician who has completed a thorough evaluation of:

- a) the weight-bearing strength and stability of the intended wall mount surface; and
- b) the weight-bearing strength and compatibility of the intended wall mount brackets/device.

Functional Overview

Front Panel

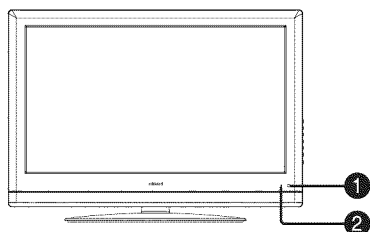

- 1 Remote control sensor**
Receives signal from the remote control.
- 2 Power indicator**
Lights up in red when the TV is in standby mode.
Lights up in blue when the TV is turned on.

Side Panel

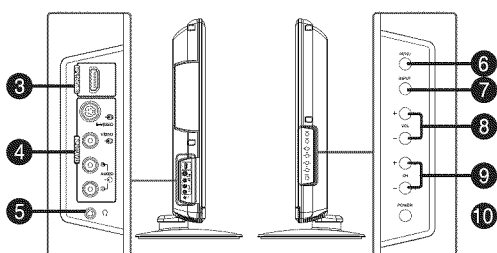

- 3 HDMI2 Input terminal**
Connect to equipment with HDMI output.
HDMI Input from a DVI source will not have sound.
- 4 AV2 Input terminal**
Connect to equipment with S-video or audio/video output.

- 5 Head Phone jack**
Connect to head phones.
- 6 MENU**
Press to enter or exit from the TV menu.
- 7 INPUT**
Press to select TV, HDMI1, HDMI2, AV1(Video), AV2(Video), AV3, RGB, AV1(S-Video), or AV2(S-Video) inputs.
- 8 Volume Up/Down (VOL+/-)**
Press to adjust the volume.
Left/Right Cursor (◀/▶)
Press to select or adjust the desired item on the TV menu.
- 9 Channel Up/Down (CH+/-)**
Press to select previous/next channel.
Up/Down Cursor (▲/▼)
Press to select or adjust the desired item on the TV menu.
- 10 POWER**
Press to turn the TV power on or off.

Rear Panel

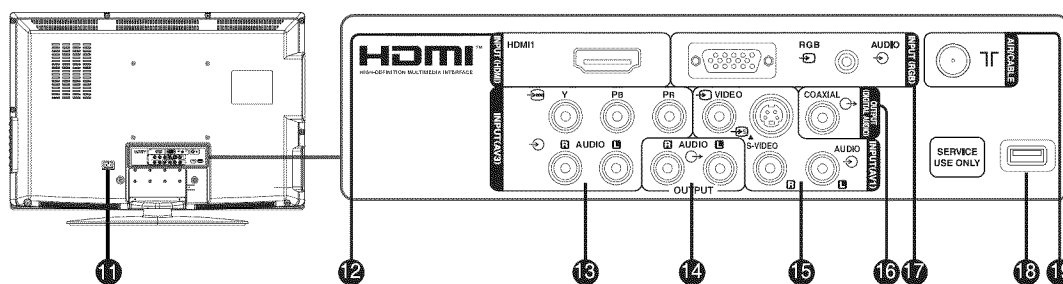

- 11 AC Input terminal**
Connect to the wall outlet, using the supplied Power Cord.
- 12 HDMI Input terminal**
Connect to equipment with HDMI output.
HDMI Input from a DVI source will not have sound.
- 13 AV3 Input terminals**
Connect to equipment with component output.
- 14 Audio Output terminal**
Connect to equipment with audio input. This audio level is fixed and cannot be adjusted using TV volume control.

- 15 AV1 Input terminal**
Connect to equipment with audio/video output.
- 16 Digital Audio Output terminal**
Connect to a equipment with digital audio input.
- 17 RGB Input terminal**
Connect to PC.
- 18 USB terminal**
For service use only.
- 19 AIR/CABLE Input terminal**
Connect to equipment with antenna output or wall antenna cable.

Remote control

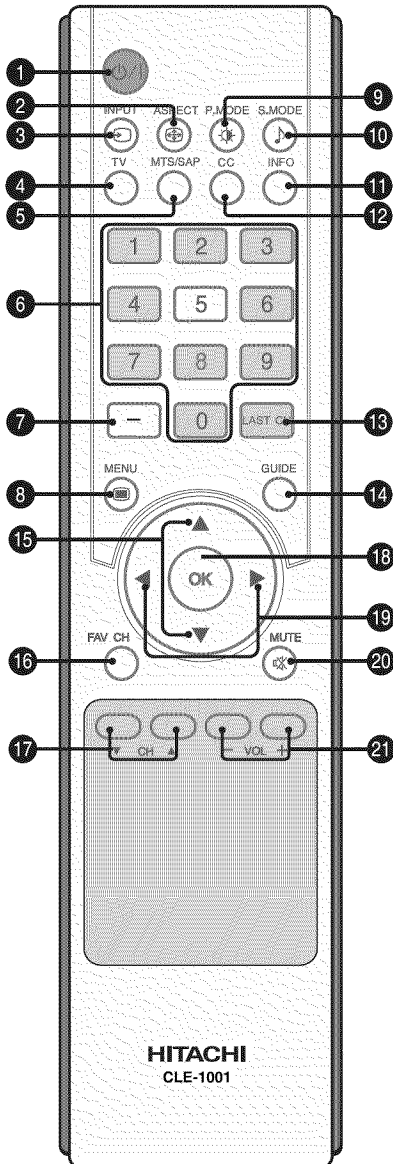

- ① **Power On/Standby** (⏻/⏻) Press to turn the TV on or off.
- ② **ASPECT** (⊕) Press to select the desired picture format.
- ③ **INPUT** (↺) Press to select TV, HDMI1, HDMI2, AV1(Video), AV2(Video), AV3, RGB, AV1(S-Video), or AV2(S-Video) inputs.
- ④ **TV** Press to change to TV mode viewing.
- ⑤ **MTS/SAP** Press to select Mono, Stereo or SAP mode.
- ⑥ **Channel Select (Numeric Keys)** Press to select the TV channel directly.

- ⑦ **Dash (-)** Press to view digital sub channels. First enter the main channel number, then press this button, then enter the sub-channel number.
- ⑧ **Menu** (☑) Press to enter or exit from the TV menu.
- ⑨ **Picture Mode** (🌞) Press to select the desired picture mode.
- ⑩ **Sound Mode** (🎵) Press to select the desired sound mode.
- ⑪ **INFO** Press to display the current channel/program information.
- ⑫ **CC** Select between Closed Caption modes.
- ⑬ **Last Channel (LAST CH)** Press to return to previously viewed channel.
- ⑭ **GUIDE** Press to display the Electronic Program Guide(EPG).
- ⑮ **Up/Down Cursor** (▲/▼) Press to select or adjust the desired item on the TV menu.
- ⑯ **FAV CH** Press to display your favorite channels list.
- ⑰ **Channel Up/Down (CH ▲/CH ▼)** Press to change up/down channel.
- ⑱ **OK** Press to confirm and execute the selection.
- ⑲ **Left/Right Cursor** (◀/▶) Press to select or adjust the desired item on the TV menu.
- ⑳ **Mute** (🔇) Press to mute or restore the volume.
- ㉑ **Volume Up/Down (VOL +/-)** Press to adjust the volume.

Setting up your TV

Connecting an antenna, cable TV, or satellite TV

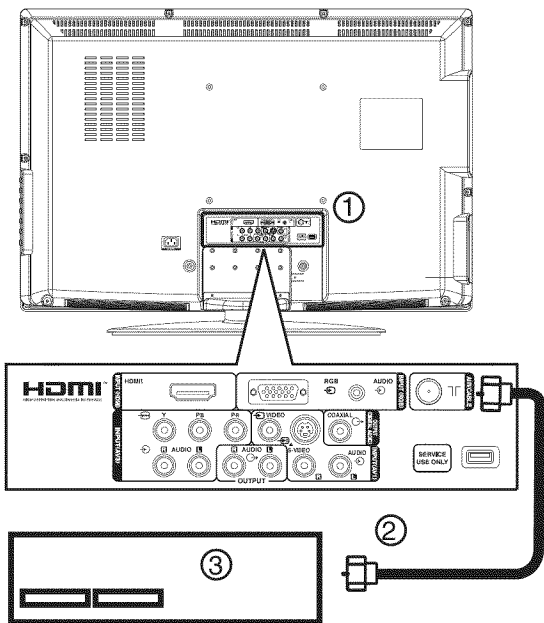

To connect an external antenna, cable TV, or satellite TV:

- 1 Plug the antenna cable (2) from an antenna, cable TV, or satellite receiver (3) to the **AIR/CABLE** jack on your TV (1).
- 2 Turn on your TV.
- 3 Press **INPUT**, then press **▲/▼** to select **TV**.

Connecting a standard video device

Note
Your TV supports multiple video source inputs. For temporary or easy-access video connections, use the side jacks (AV2). For more permanent connections, use the rear jacks (AV1).

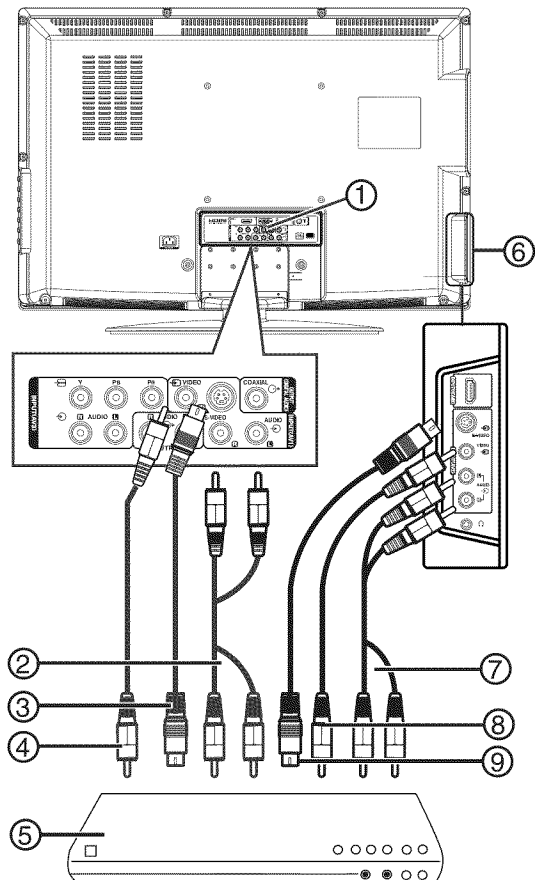

To connect a standard video device to the AV1 jacks:

- 1 Plug an RCA video cable (4) into a standard video source (5) and into the **VIDEO** jack (1) on the back of your TV.
- 2 Plug the RCA audio cables (2) into the video device's audio output jack and into the upper **AUDIO L** and **AUDIO R** jacks on the back of your TV.
- 3 Turn on your TV.
- 4 Press **INPUT**, then press **▲/▼** to select **AV1 (Video)**.

To connect an external video device to the AV2 jacks:

- 1 Plug the RCA video connector (8) into a standard video device (5) and **VIDEO** jack (6) on the side of your TV.
- 2 Plug the RCA audio connectors (7) into the audio out jacks on the video device and into the **AUDIO L** and **AUDIO R** jacks (6) on the side of your TV.
- 3 Turn on your TV.
- 4 Press **INPUT**, then press **▲/▼** to select **AV2 (Video)**.

To connect a standard S-Video device to AV1 jacks:

- 1 Plug an S-Video cable (3) into the S-Video out jack on an S-Video device (5) and into the **S-VIDEO** jack (1) on the back of your TV.
- 2 Plug RCA audio cables (2) into the S-Video device audio output jacks and into the **AUDIO L** and **AUDIO R** jacks on the back of your TV.
- 3 Turn on your TV.
- 4 Press **INPUT** and ▲/▼ to select **AV1(S-Video)**.

To connect a standard S-Video device to AV2 jacks:

- 1 Plug an S-Video cable (9) into the S-Video out jack on an S-Video device (5) and into the **S-VIDEO** jack (6) on the back of your TV.
- 2 Plug RCA audio cables (7) into the S-Video device audio output jacks and into the **AUDIO L** and **AUDIO R** jacks on the back of your TV.
- 3 Turn on your TV.
- 4 Press **INPUT** and ▲/▼ to select **AV2(S-Video)**.

To connect a progressive-scan or HDTV video source to Y/Pb/Pr jacks:

- 1 Plug a component video cable (2) into the progressive-scan or HDTV video device (3) and into the **Y/Pb/Pr** jacks (1) on the back of your TV.
- 2 Plug the RCA audio cables (4) into the audio out jacks on progressive-scan or HDTV video device and into the lower **AUDIO L** and **AUDIO R** jacks (1) on the back of your TV.
- 3 Turn on your TV.
- 4 Press **INPUT**, then press ▲/▼ to select **AV3**.

Connecting a digital audio input

You can connect your TV audio out to a digital amplifier.

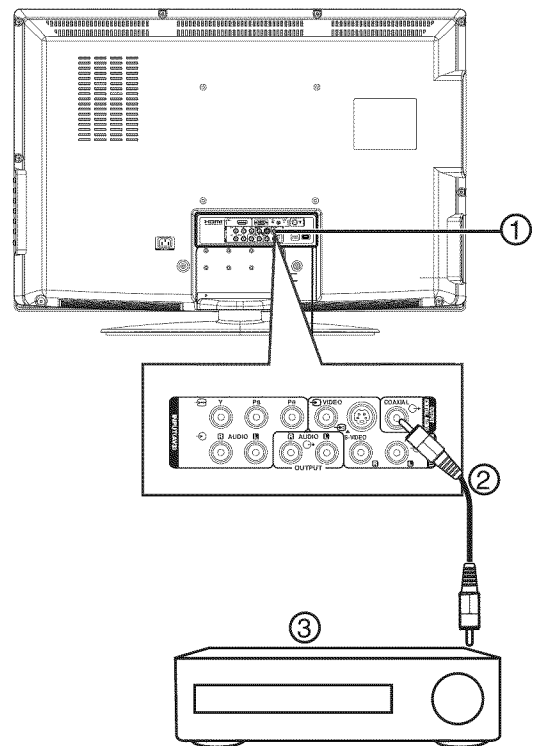

Connecting a component video device

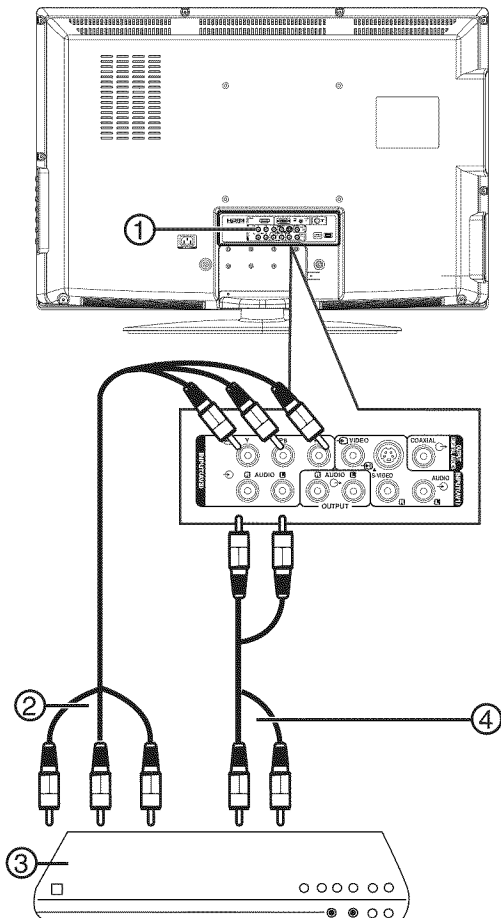

To connect to an amplifier equipped with a digital audio input:

- Plug a coaxial cable (2) into the amplifier (3) and into the **COAXIAL OUTPUT** jack (1) on the back of your TV.

Connecting a computer

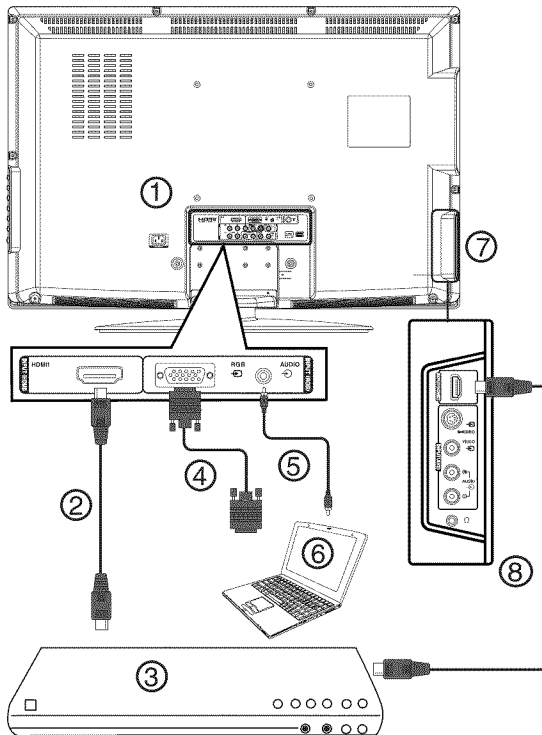

To connect a computer using VGA:

- 1 Plug a VGA cable (4) into the VGA port on the computer (6) and into the **RGB INPUT** port on the back of your TV.
- 2 Plug an audio cable (5) into the audio jack on the computer (6) and into the **AUDIO RGB INPUT** port on the back of your TV.
- 3 Turn on your TV.
- 4 Press **INPUT**, then press ▲/▼ to select **RGB**.

To connect to a computer or other HDMI device using the HDMI1 jack:

- 1 Plug an HDMI cable (2) into the HDMI port on the HDMI device (3) and into the **HDMI1 INPUT** port on the back of your TV.
- 2 Turn on your TV.
- 3 Press **INPUT**, then press ▲/▼ to select **HDMI1**.

To connect to a computer or other HDMI device using the HDMI2 jack:

- 1 Plug an HDMI cable (8) into the HDMI port on the HDMI device (3) and into the **HDMI2 INPUT** port on the side of your TV.
- 2 Turn on your TV.
- 3 Press **INPUT**, then press ▲/▼ to select **HDMI2**.

Note

When the computer goes into standby, TV shows "No Sync" message and will never turn off.

Using the basic controls

Turning the TV on and off

To turn your TV on and off:

- 1 Press **POWER** on the side of your TV or on the remote control. The power indicator turns blue.
- 2 To turn off your TV, press **POWER** again. The power indicator turns red.

Adjusting the volume

You can adjust the volume using the controls on your TV's side panel or the remote control.

To adjust the volume:

- 1 Press **VOL+** or **VOL-** to increase or decrease the volume.
- 2 Press **MUTE** to mute the sound, then press this button again to restore the sound.

Changing the video mode

Your TV supports multiple video modes.

To select the video mode:

- Press **INPUT** one or more times to select the video mode, then press **OK**. You can select:
 - TV
 - HDMI1
 - HDMI2
 - AV1(Video)
 - AV2(Video)
 - AV3
 - RGB
 - AV1(S-Video)
 - AV2(S-Video)

Using your TV

Selecting the TV signal source

To select the TV signal source:

- 1 Press **MENU**, then press ◀/▶ to highlight **Channel** icon. The *Channel* menu opens.

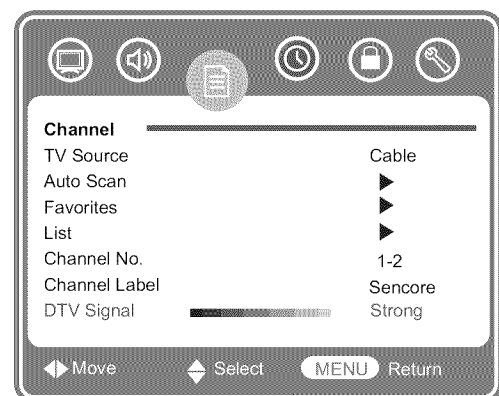

- 2 Press ▼ to enter the *Channel* menu.
- 3 Press ▲/▼ to select **TV Source**, then press ◀/▶ to select **Air** or **Cable**.
 - **Air**-VHF/UHF channels.

- **Cable**-Cable TV channels.
- 4 Press **MENU** one or more times to close the menu.

Changing channels

To change channels:

- Press the **CH+** or **CH-** on the side of your TV or the **CH ▲** or **CH ▼** on the remote control.

To enter a channel number directly:

- Press the number buttons on the remote control.
- In digital TV mode, a main (major) channel can have one or more sub. (minor) channels. Press the number buttons to enter the main channel, press the **-** button (to the left of the 0 button), then press the number button for the sub-channel. For example, if you want to watch channel 5-2, press **5**, press the **-** button, then press **2**.

To go to the previous channel:

- Press **LAST CH**.

Using the on-screen menus

Use your remote control to navigate in the on-screen menus.

To use the on-screen menus:

- 1 Press **INPUT** on the remote control to select the video source.
- 2 Press **MENU** on the remote control. The on-screen menu appears.
- 3 Press **◀/▶** to highlight the **Video**, **Audio**, **Channel**, **Timers**, **Locks**, or **Setup** icon, then press **▼** to enter the menu.
- 4 Press **▲/▼** to highlight a setting, then press **◀/▶** to change the setting.
- 5 Press **MENU** one or more times to close the menu.

Scanning Channels

To select channels with the **CH** buttons, your TV first needs to scan the channels. When your TV scans channels, it scans for channels with signals, then stores the channel information into memory.

To automatically scan channels:

- 1 Press **MENU** on the remote control, then press **◀/▶** to highlight **Channel** icon. The **Channel** menu opens.

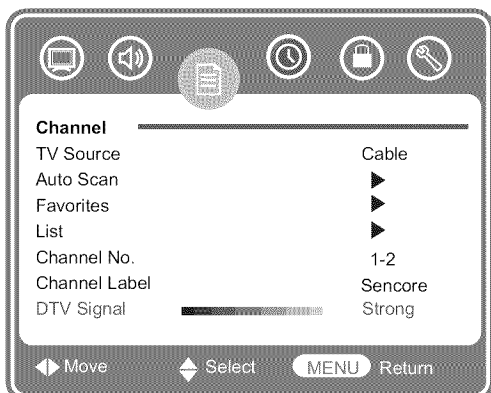

- 2 Press **▼** to enter the **Channel** menu.
- 3 Press **▲/▼** to select **Auto Scan**, then press **▶**. The **Auto Scan** sub-menu opens.

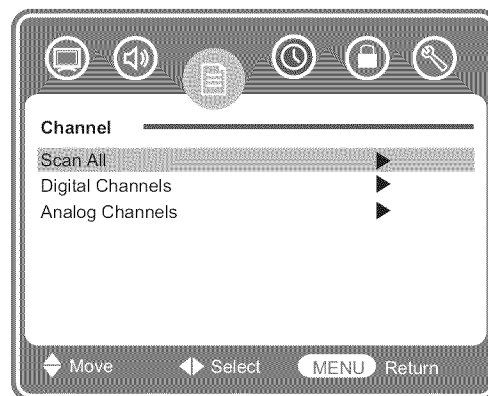

- 4 Press **▲/▼** to select the type of auto scan you want:

- **Scan all**
- **Digital Channels**
- **Analog Channels**

Then press **▶** to start the auto scan. Your TV scans for and memorizes all channels available in your area.

- 5 To stop the auto search, press **MENU**. When auto search is finished, the channel changes to the first channel in the memorized channel list.

Note

The Channel List cannot be updated by only changing the cable source. Auto Scan must be performed for the Channel List to be updated.

IMPORTANT NOTICE

United States federal law requires broadcasters to stop transmitting analog (non-digital) television signals after February 17, 2009. Accordingly, this TV's analog tuner will not be capable of receiving over-the-air analog television broadcasts after such analog broadcasts are no longer available. After February 17, 2009, this TV's analog tuner will continue to work with compatible cable and satellite TV systems, gaming consoles, VCRs, DVD players and other similar products. Both before and after February 17, 2009, this TV's digital tuner will receive available over-the-air digital television broadcasts using an antenna and other digital television broadcasts using compatible cable, satellite or other digital television system connections. Please review this Operating Guide for further information regarding such connections. Hitachi supports the DTV transition and as a member of the DTV Transition Coalition urges consumers to visit these web sites for interactive guides and further detailed information:

- www.dtvtransition.org
- www.dtv2009.gov
- www.myceknowhow.com
- www.youtube.com

Manually editing channels

To skip a channel:

- 1 Make sure that you have Auto Scanned for channels.
- 2 Press **MENU** on the remote control, then press **◀/▶** to highlight **Channel**. The *Channel* menu opens.

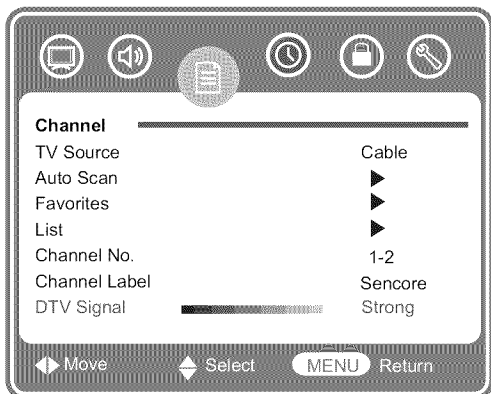

- 3 Press **▼** to enter the *Channel* menu.
- 4 Press **▲/▼** to select **List**, then press **▶**. The *List* sub-menu opens.
- 5 Press **▲/▼** to select a channel you want to skip, then press **OK**. The check mark next to channel disappears and the screen turns black.
- 6 Press **OK** again to show the channel. The check mark appears, and the screen shows the channel.

Viewing channel information

To view channel information:

- 1 In digital TV mode, select a channel you want to watch.
- 2 Press **INFO** once to display information about the channel.



- 3 Press **INFO** again to display information about the program content (if available).

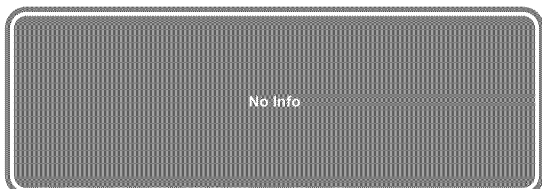

- 4 Press **INFO** again to close.

Adding favorite channels

To add channels to the favorite channel list:

- 1 Press **MENU** on the remote control, then press **◀/▶** to highlight **Channel**. The *Channel* menu opens.

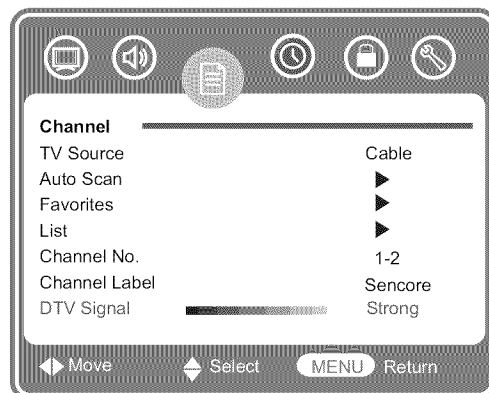

- 2 Press **▼** to enter the *Channel* menu.
- 3 Press **▲/▼** to select **Favorites**, then press **▶**. The *Favorites* sub-menu opens.

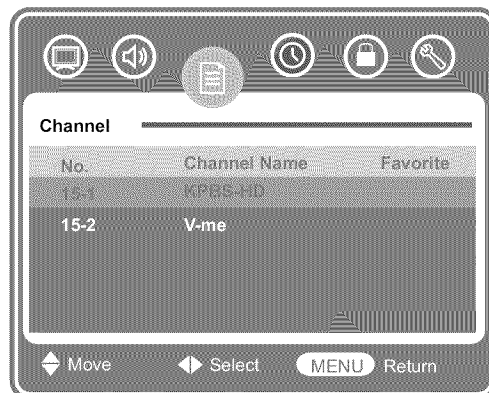

- 4 Press **▲/▼** to select a channel that you want to add to the favorite channel list.
- 5 Press **OK**. A check mark appears next to the channel, and the channel is marked as a favorite.
- 6 Repeat this procedure to select the other channels.

To select your favorite channel:

- 1 Press **FAV CH** one or more times on the remote control until the Favorite List appears on the screen.
- 2 Press **▲/▼** to select the preset for your favorite channel.

Note

The favorite channel function does not work until you have programmed your favorite channels.

To remove a channel from the favorite channel list:

- 1 Press **MENU** on the remote control, then press **◀/▶** to highlight **Channel**. The *Channel* menu opens.

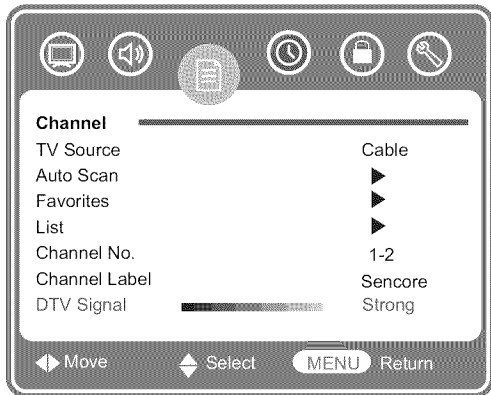

- 2 Press **▼** to enter the *Channel* menu.
- 3 Press **▲/▼** to select **Favorites**, then press **▶**. The *Favorites* sub-menu opens.

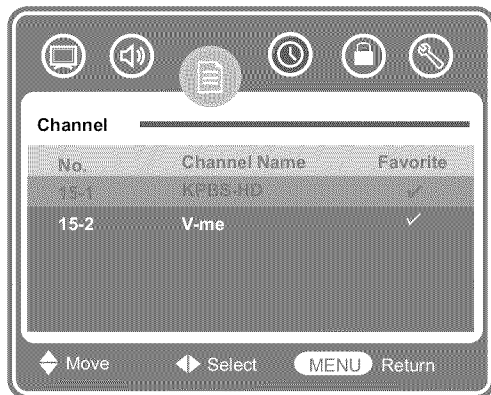

- 4 Press **▲/▼** to select the channel you want to remove.
- 5 Press **OK**. The check mark next to the channel disappears, and the channel is removed from favorite channel list.

Adjusting video settings

To adjust picture settings:

- 1 Press **MENU** on the remote control, then press **◀/▶** to highlight the **Video** icon. The *Video* menu opens.

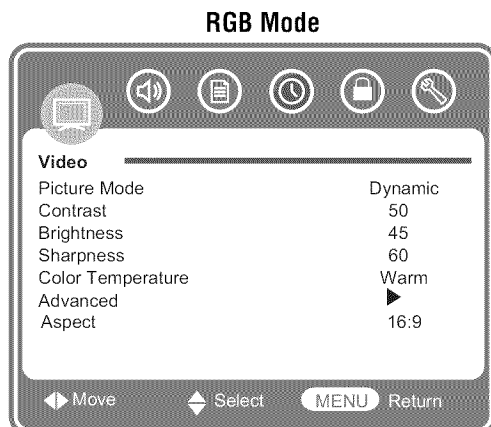

TV Mode

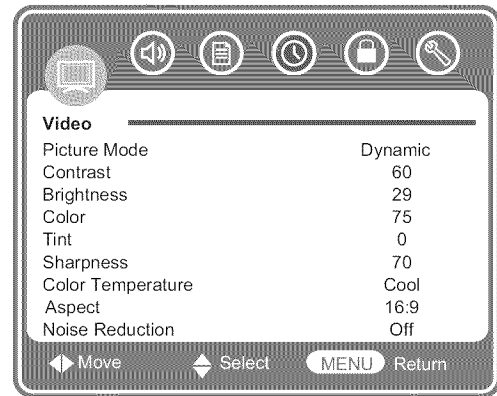

- 2 Press **▼** to enter the Video menu.
- 3 Press **▲/▼** to select one of the following settings, then press **◀/▶** to change the setting. You can select:
 - **Picture Mode-Standard, Dynamic, Soft, or Personal.**
 - **Contrast**
 - **Brightness**
 - **Color**
 - **Tint**
 - **Sharpness**
 - **Color Temperature -Normal, Warm, or Cool.**
 - **Advanced**-When **Advanced** is highlighted, press **▶** to open the advanced menu.
 - **H-Pos** (RGB mode only)
 - **V-Pos** (RGB mode only)
 - **Clock** (RGB mode only)
 - **Phase** (RGB mode only)
 - **Auto** (RGB mode only)-Press **▶** to activate the auto adjust feature for RGB mode.
 - **Aspect-4:3, 16:9, Zoom1, Zoom2 or Expanded.** (In RGB mode, only **4:3** and **16:9** are available for Aspect.)
 - **Noise Reduction-Off, Low, Medium, High or Auto.**

If the TV is operating in a weak-signal area, sometimes the Noise Reduction function can improve the reception.

- 4 Press **MENU** one or more times to close the menu.

Note
Any adjustments made to **Contrast, Brightness, Color, Tint** and **Sharpness** while in the **Standard, Dynamic, or Soft** Picture Modes will automatically be saved in the **Personal** Picture Mode Setting. Additionally, when adjustments are made the TV will automatically switch to the **Personal** Picture Mode.

Adjusting audio settings

To adjust audio settings:

- 1 Press **MENU** on the remote control, then press **◀/▶** to highlight the **Audio** icon. The *Audio* menu opens.

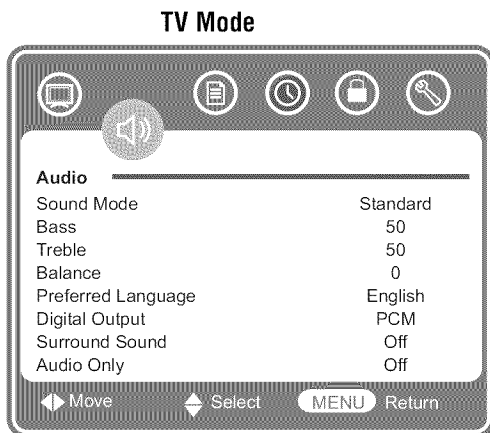
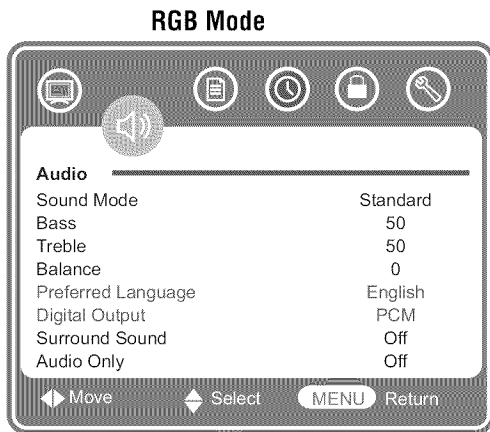

- 2 Press **▼** to enter the *Audio* menu.
- 3 Press **▲/▼** to select one of the following settings, then press **◀/▶** to change the setting. You can select:
 - **Sound Mode- Standard, Music, Movie, Sports, or Personal.**
 - **Bass**
 - **Treble**
 - **Balance**
 - **Preferred Language-English, French, or Spanish.** (Digital TV mode only)
 - **MTS-Mono, Stereo, or SAP.** (Analog TV mode only)
 - **Digital Output-PCM or RAW.**
 - **Surround Sound-On or Off.**
 - **Audio only-On or Off.** (If you select "On", the image disappears but the sound remains. Press any button to resume the image.)
- 4 Press **MENU** one or more times to close the menu.

Note

Any adjustments made to **Bass, Treble, and Balance** while in the **Standard, Music, Movie, and Sports** Sound Modes will automatically be saved in the **Personal** Sound Mode Setting. Additionally, when adjustments are made the TV will automatically switch to the **Personal** Sound Mode.

Using the Electronic Program Guide

Your TV has an Electronic Program Guide (EPG) that supplies information, such as program lists and start and end times for programs. In addition, detailed information about the program is often available in the EPG. (The availability and the amount of program details will vary depending on the broadcaster.)

To use the EPG:

- 1 In digital TV mode, select a channel you want to watch.
- 2 Press **GUIDE** on the remote control. The EPG opens with the channel that is currently active.



- 3 By repeatedly pressing **▲/▼**, the information for additional future programs can be displayed.
- 4 Press **◀/▶** to select the previous/next channel.
- 5 Press **GUIDE** one or more times to close the EPG.

Changing the channel settings

To change channel settings:

- 1 Press **MENU** on the remote control, then press **◀/▶** to highlight **Channel**. The *Channel* menu opens.

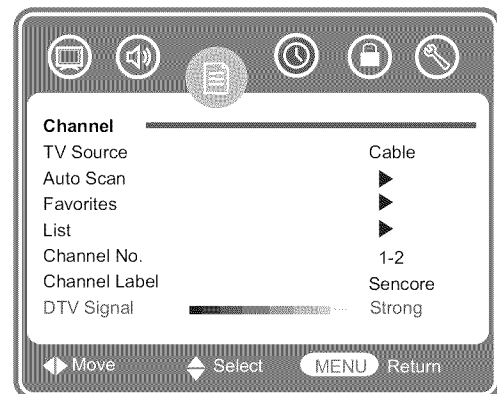

- 2 Press **▼** to enter the *Channel* menu.
- 3 Press **▲/▼** to select one of the following settings, then press **◀/▶** to change the setting. You can select:

- **TV Source-Air or Cable.**
 - **Auto Scan**-For more information, see "Scanning Channels" on page 13.
 - **Favorites**-For more information, see "Adding favorite channels" on page 14.
 - **List**-For more information, see "Manually editing channels" on page 14.
 - **Channel No.**-Press ◀/▶ to select the channel.
 - **Channel Label**-For more information, see "Adding a channel label" on this page.
 - **DTV Signal**-Display the signal strength of the Digital TV.
- 4 Press **MENU** one or more times to close the menu.

Adding a channel label

To add a channel label:

- 1 Press **MENU** on the remote control, then press ◀/▶ to highlight **Channel**. The *Channel* menu opens.

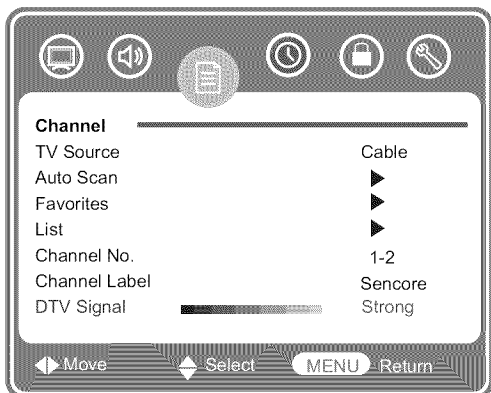

- 2 Press ▼ to enter the *Channel* menu.
- 3 Press ▲/▼ to select **Channel Label**, then press ▶ to enter the *Channel Label* sub-menu.

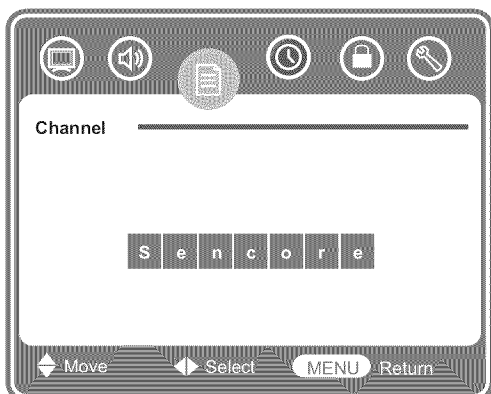

- 4 Press ◀/▶ to move the cursor, then press ▲/▼ one or more times to select each character of the new name for the channel.
- 5 Press **MENU** one or more times to close the menu.

Adjusting timers settings

To adjust timers settings:

- 1 Press **MENU** on the remote control, then press ◀/▶ to highlight the **Timers** icon. The *Timers* menu opens.

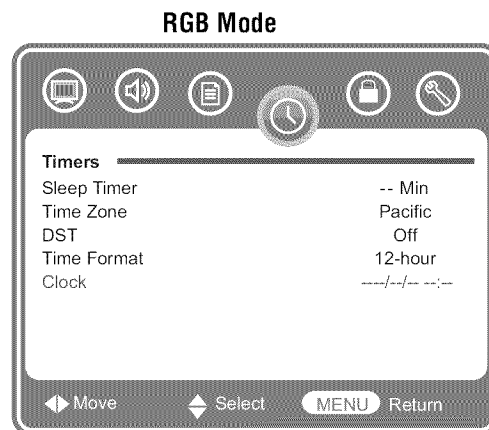

TV Mode

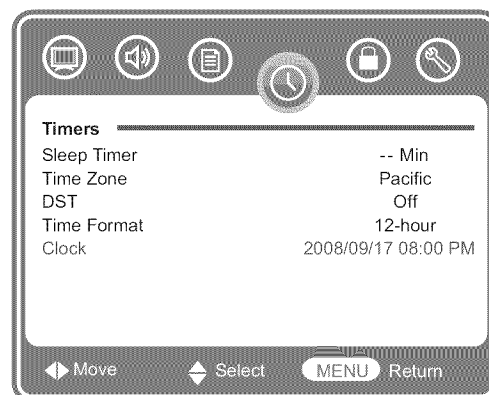

- 2 Press ▼ to enter the *Timers* menu.
- 3 Press ▲/▼ to select one of the following settings, then press ◀/▶ to change the setting. You can select:
 - **Sleep Timer**-Select the sleep time you want.
 - **Time Zone**-**Pacific, Alaska, Hawaii, Atlantic, Eastern, Central, or Mountain.**
 - **DST (Daylight Saving Time)**-**On or Off.**
 - **Time Format**-**12-hour or 24-hour.**
 - **Clock**-Display the clock time.
- 4 Press **MENU** one or more times to close the menu.

Note

- Clock can only display the clock time when on a digital channel and the time information is available.
- 30 seconds before the Sleep Timer turns off the TV, the Sleep timer counts down and shows the remaining seconds until the timer turns off the TV.
- If a power failure occurs or the TV is unplugged, all the times will be reset.

Adjusting Setup settings

To adjust setup settings:

- 1 Press **MENU** on the remote control, then press **◀/▶** to highlight the **Setup** icon. The *Setup* menu opens.

RGB Mode

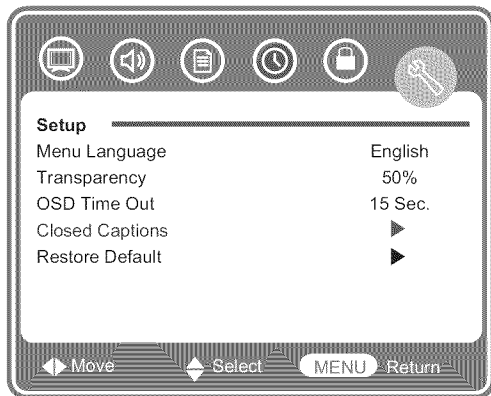

TV Mode

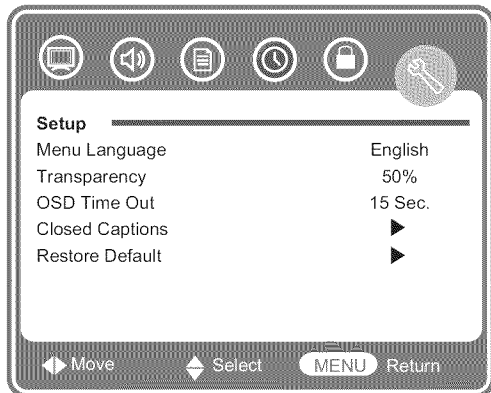

- 2 Press **▼** to enter the *Setup* menu.
- 3 Press **▲/▼** to select one of the following settings, then press **◀/▶** to change the setting. You can select:
 - **Menu Language-English, Français, or Español.**
 - **Transparency**-Adjust the menu transparency.
 - **OSD Time Out**-Adjust the display time of the OSD menu.
 - **Closed Captions**-See "Setting the closed caption mode" on this page.
 - **Restore Default**-Select **Yes**, then press **OK** to restore your TV to the default settings.
- 4 Press **MENU** one or more times to close the menu.

Setting the closed caption mode

To set the closed caption mode:

- 1 Press **MENU** on the remote control, then press **◀/▶** to highlight the **Setup** icon. The *Setup* menu opens.

TV Mode

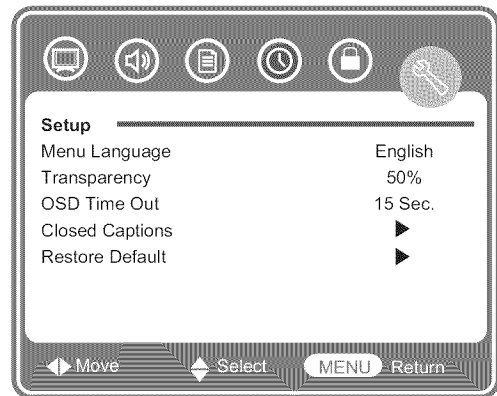

- 2 Press **▼** to enter the *Setup* menu.
- 3 Press **▲/▼** to highlight **Closed Captions**, then press **▶** to enter the *Closed Captions* sub-menu. The *Closed Captions* sub-menu opens.

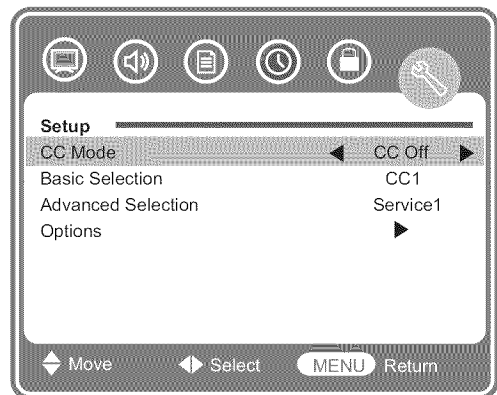

- 4 Press **▲/▼** to select one of the following settings, then press **◀/▶** to change the setting. You can select:
 - **CC Mode-CC Off, CC On, or CC On Mute.**
 - **Basic Selection-Off, CC1, CC2, CC3, CC4, Text1, Text2, Text3, or Text4.**
 - **Advanced Selection-Service1, Service2, Service3, Service4, Service5, Service6, or Off.**
 - **Options**-See "Setting the closed caption styles" on page 19.
- 5 Press **MENU** one or more times to close the menu.

Setting the closed caption styles

To set the closed caption styles:

- 1 Press **MENU** on the remote control, then press **◀/▶** to highlight the **Setup** icon. The *Setup* menu opens.

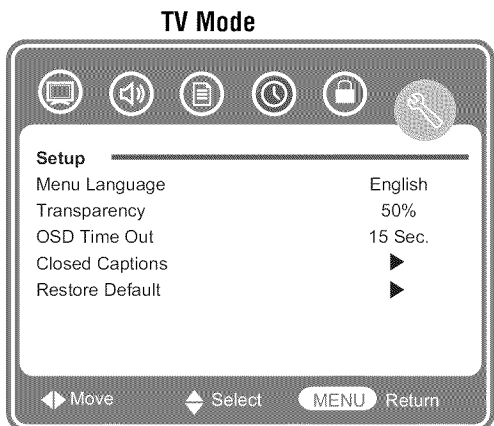

- 2 Press **▼** to enter the *Setup* menu.
- 3 Press **▲/▼** to highlight **Closed Captions**, then press **▶** to enter the *Closed Captions* sub-menu. The *Closed Captions* sub-menu opens.

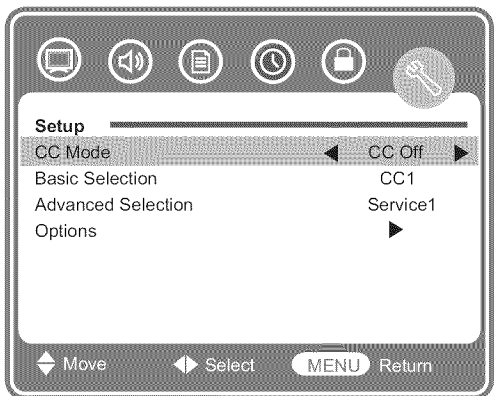

- 4 Press **▲/▼** to select **Options**, then press **▶** to enter the *Options* sub-menu. The *Options* sub-menu opens.

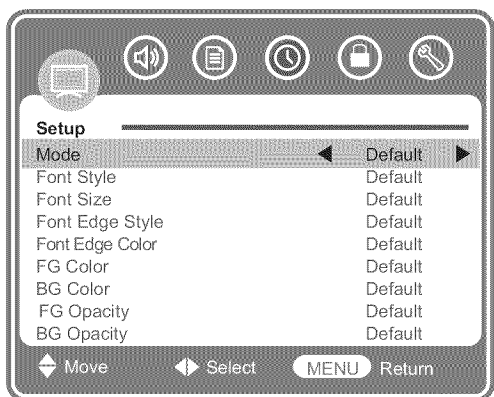

- 5 Press **▲/▼** to select one of the following settings, then press **◀/▶** to change the setting. You can select:

- **Mode**-Custom or Default. (If Default is selected, the other settings are not available.)
- **Font Style**-Default, Font0, Font1, Font2, Font3, Font4, Font5, Font6, or Font7.
- **Font Size**-Default, Normal, Large, or Small.
- **Font Edge Style**-Default, None, Raised, Depressed, Uniform, Left Shadow, or Right Shadow.
- **Font Edge Color**-Default, Black, White, Red, Green, Blue, Yellow, Magenta, or Cyan.
- **FG Color**-Default, White, Black, Red, Green, Blue, Yellow, Magenta, or Cyan.
- **BG Color**-Default, Black, White, Red, Green, Blue, Yellow, Magenta, or Cyan.
- **FG Opacity**-Default, Solid, Flashing, Translucent, or Transparent.
- **BG Opacity**-Default, Solid, Flashing, Translucent, or Transparent.

- 6 Press **MENU** one or more times to close the menu.

Setting the parental controls

To set the parental controls:

- 1 Press **MENU** on the remote control, then press **◀/▶** to highlight the **Locks** icon. The *Enter Password* screen opens.

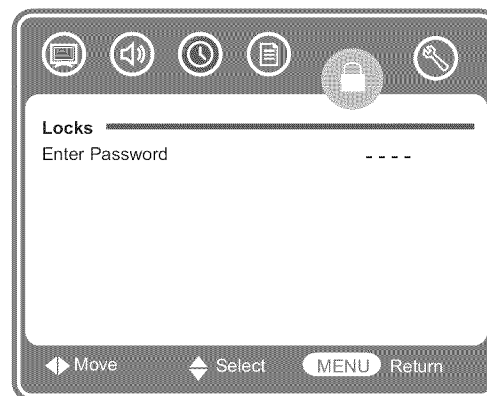

- 2 Press **▼** to enter the *Enter Password* screen.
- 3 Enter the password with the number buttons on the remote control (the default password is **0000**). The *Locks* menu opens.

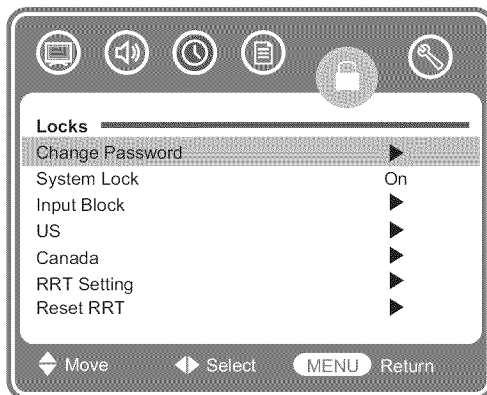

- 4 Press ▲/▼ to select one of the following settings, then press ◀/▶ to change the setting. You can select:
 - **Change Password**-For more information, see “Changing the password” on this page.
 - **System Lock-On or Off. (Input Block, US, Canada, RRT setting, and Reset RRT are only available when System Lock is set to On.)**
 - **Input Block**-To block the input source.
 - **US (United States)**-For more information, see “Setting the parental control level - US TV ratings” on page 21.
 - **Canada**-For more information, see “Setting the parental control level - Canadian ratings” on page 23.
 - **RRT Setting**-For more information, see “Setting the parental control level - RRT ratings” on page 24.
 - **Reset RRT**-Select **Yes**, then press **OK** to reset the RRT to the default settings.
- 5 Press **MENU** one or more times to close the menu.

Note
If you forgot your password, enter 9999 to disable Lock and set a new password.

- 4 Press ▲/▼ to highlight **Change Password**, then press ▶ to open the *Change Password* sub-menu.
- 5 Press the number buttons to input the old password (if you have not set a password, enter **0000**; if you forgot the password, enter **9999**). The cursor moves to the **Enter New Password** column.
- 6 Press the number buttons on the remote control to input the new password. The cursor moves to the **Confirm Password** column.
- 7 Press number buttons to input the new password again.

Blocking an input source

To block an input source:

- 1 Press **MENU** on the remote control, then press ◀/▶ to highlight the **Locks** icon. The *Enter Password* screen opens.

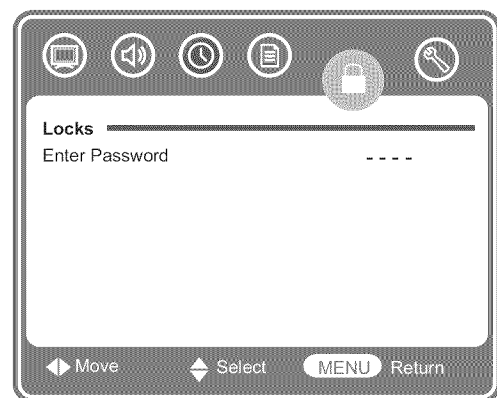

- 2 Press ▼ to enter the *Enter Password* screen.
- 3 Enter the password with the number buttons on the remote control (the default password is **0000**). The *Locks* menu opens.

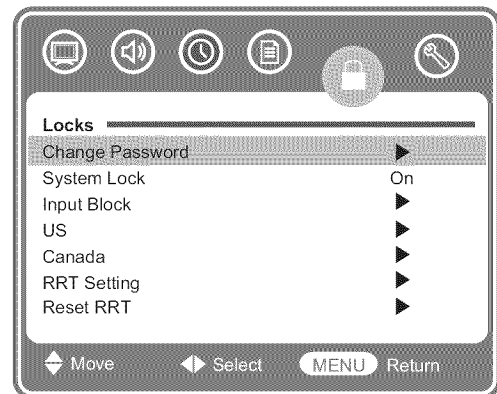

Changing the password

To change the password:

- 1 Press **MENU** on the remote control, then press ◀/▶ to highlight the **Locks** icon. The *Enter Password* screen opens.

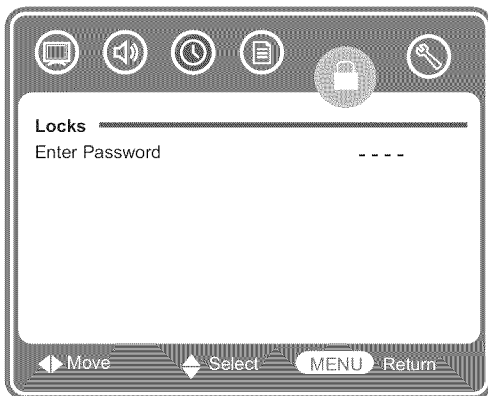

- 2 Press ▼ to enter the *Enter Password* screen.
- 3 Enter the password with the number buttons on the remote control (the default password is **0000**). The *Locks* menu opens.

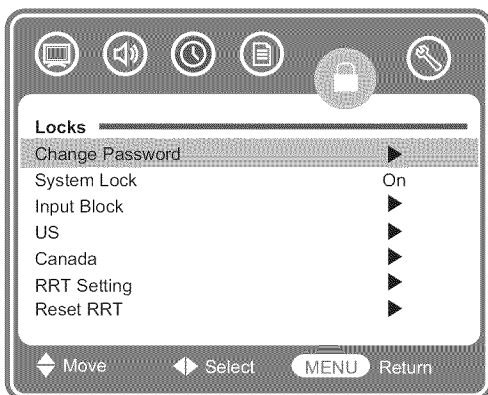

- Press **▲/▼** to highlight **Input Block**, then press **▶** to open the *Input Block* sub-menu. The *Input Block* sub-menu opens.

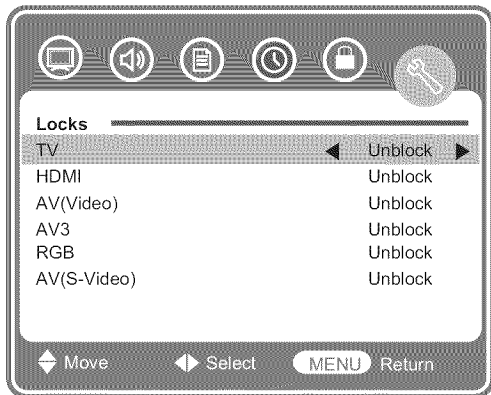

- Press **▲/▼** to select the input source you want to block, then press **◀/▶** to change the setting.
 - Block**-Block the input source. When you set the input source to **Block**, the screen turns black and sound is blocked. And "Input is blocked!" will be displayed on the screen when you exit the menu.
 - Unlock**-Unlock the input source.
- Press **MENU** one or more times to close the menu.

- Enter the password with the number buttons on the remote control (the default password is **0000**). The *Locks* menu opens.

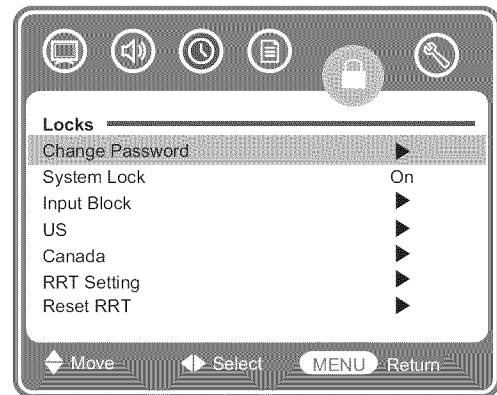

- Press **▲/▼** to highlight **US**, then press **▶** to open the *US ratings* sub-menu. The *US ratings* sub-menu opens.

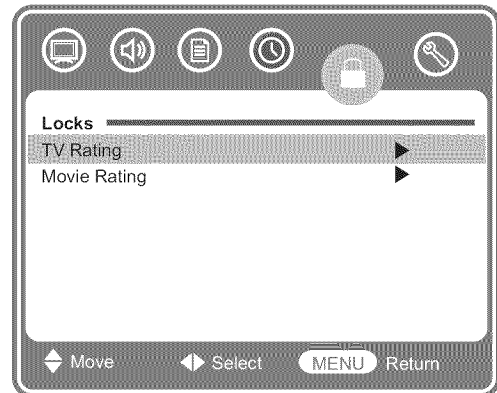

Setting the parental control level - US TV ratings

To set US TV parental control levels:

- Press **MENU** on the remote control, then press **◀/▶** to highlight the **Locks** icon. The *Enter Password* screen opens.

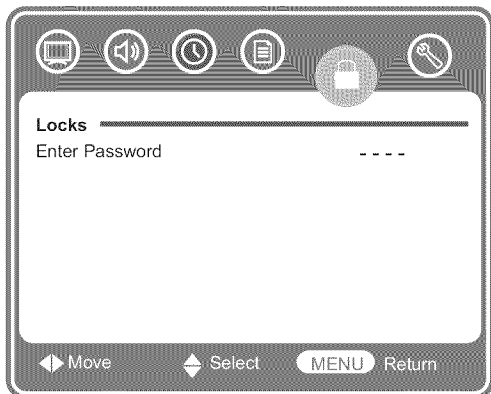

- Press **▼** to enter the *Enter Password* screen.

- Press **▲/▼** to select **TV Rating**, then press **▶** to open the *TV ratings* sub-menu. The *TV ratings* sub-menu opens.

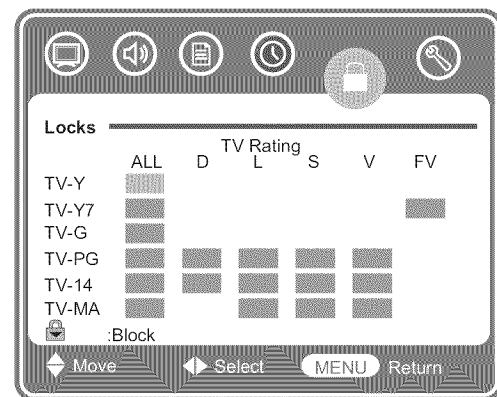

- Press **▲, ▼, ◀** or **▶** to select any of the TV ratings, then press **OK**. The Lock icon appears.

TV Parental Guidelines ratings

Rating	Description
TV-Y	All children
TV-Y7	Children over seven years of age

Rating	Description
TV-G	General audiences
TV-PG	Parental guidance suggested
TV-14	Parents strongly cautioned
TV-MA	Mature audiences only

Some of the age-based TV Parental Guidelines ratings also have content-based ratings.

Rating	Description
FV	Fantasy violence
L	Adult language
S	Sexual situations
V	Violence
D	Sexually suggestive dialog

7 Press **MENU** one or more times to close the menu.

Note

- If **System Lock** is not set to **On**, the configuration settings do not work.
- You can view blocked programs by entering the password. This temporarily switches off the parental lock. To reactivate the parental lock settings, turn off the TV. When the TV is turned on again, your parental lock settings are reactivated.

Setting the parental control level - US TV movie ratings

To set US TV movie parental control levels:

1 Press **MENU** on the remote control, then press **◀/▶** to highlight the **Locks** icon. The *Enter Password* screen opens.

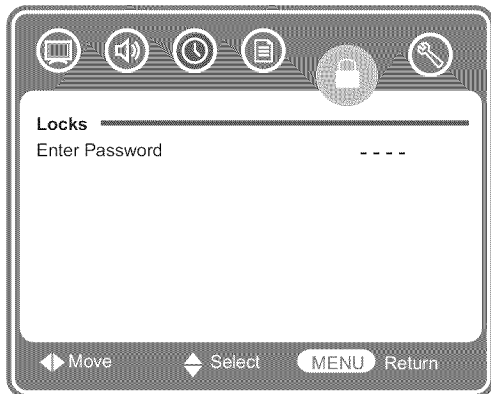

2 Press **▼** to enter the *Enter Password* screen.

3 Enter the password with the number buttons on the remote control (the default password is **0000**). The *Locks* menu opens.

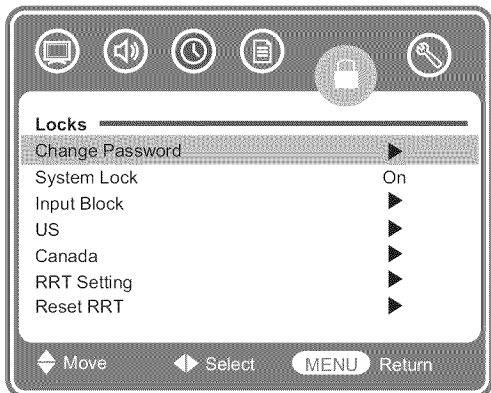

4 Press **▲/▼** to highlight **US**, then press **▶** to open the *US ratings* sub-menu. The *US ratings* sub-menu opens.

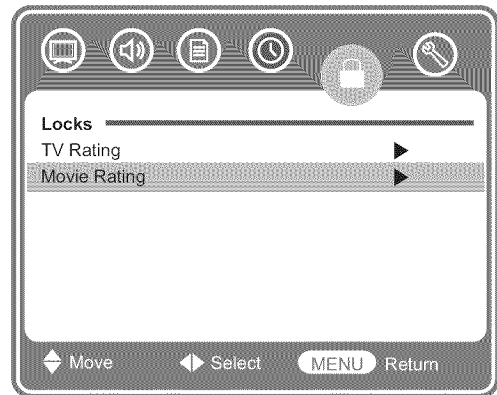

5 Press **▲/▼** to select **Movie Rating**, then press **▶** to open the *Movie ratings* sub-menu. The *Movie ratings* sub-menu opens.

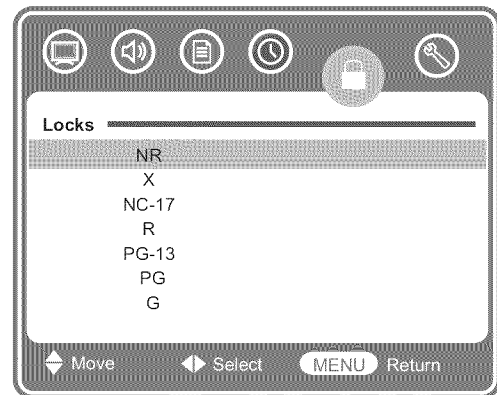

6 Press **▲** or **▼** to block or unblock the movie rating. "Lock" appears next to the movie ratings you block.

US Movie ratings

Rating	Description
NR	Not rated
X	Adults only
NC-17	Not suitable for children under 17 years of age
R	Restricted. Not suitable for children under 17 years of age unless accompanied by a parent or guardian
PG-13	Parental guidance strongly suggested. Some material may not be suitable for children under 13 years of age
PG	Parental guidance suggested. Some material may not be suitable for children
G	General audiences

7 Press **MENU** one or more times to close the menu.

Note

- If **System Lock** is not set to **On**, the configuration settings do not work.
- You can view blocked programs by entering the password. This temporarily switches off the parental lock. To reactivate the parental lock settings, turn off the TV. When the TV is turned on again, your parental lock settings are reactivated.

Setting the parental control level - Canadian ratings

To set Canadian parental control levels:

- 1 Press **MENU** on the remote control, then press **◀/▶** to highlight the **Locks** icon. The *Enter Password* screen opens.

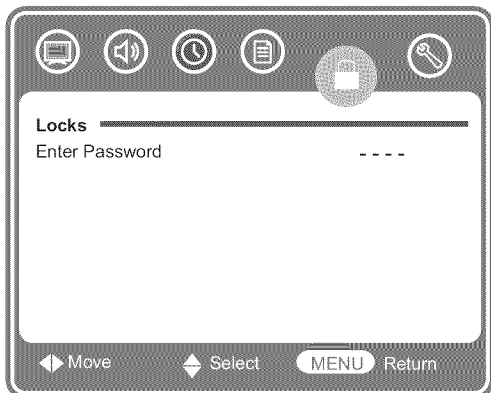

- 2 Press **▼** to enter the *Enter Password* screen.
- 3 Enter the password with the number buttons on the remote control (the default password is **0000**). The *Locks* menu opens.

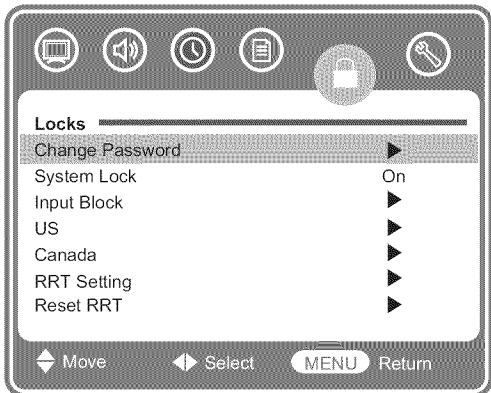

- 4 Press **▲/▼** to highlight **Canada**, then press **▶** to open the *Canada ratings* sub-menu. The *Canada ratings* sub-menu opens.



- 5 Press **▲/▼** to select **Canadian Ratings(Eng)** or **Canadian Ratings (Frn)**, then press **▶** to open the *Canada ratings* sub-menu. The *Canada ratings* sub-menu opens.

Canadian English

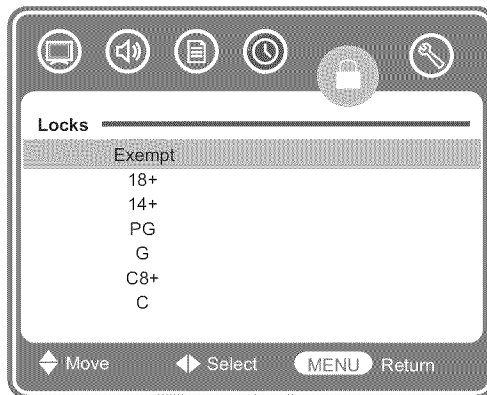

Canadian French

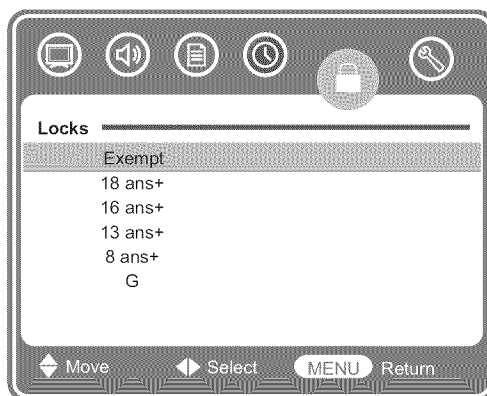

- 6 Press **▲/▼** to block or unblock the movie rating. "Lock" appears next to the movie ratings you block.

Canadian English Movie ratings

Rating	Description
Exempt	Not rated
18+	Adult programming
14+	14 years old and above
PG	Parental guidance suggested
G	General audience
C8+	Children 8 years and above
C	All Children

Canadian French Movie ratings

Rating	Description
Exempt	Not rated
18ans+	Adult programming
16ans+	Children 16 years and above
13ans+	Children 13 years and above
8ans+	Children 8 years and above
G	All Children

- 7 Press **MENU** one or more times to close the menu.

Note

- If **System Lock** is not set to **On**, the configuration settings do not work.
- You can view blocked programs by entering the password. This temporarily switches off the parental lock. To reactivate the parental lock settings, turn off the TV. When the TV is turned on again, your parental lock settings are reactivated.

Setting the parental control level - RRT ratings

The V-Chip recognizes the current RRT, which is communicated as part of the Program and System Information Protocol (*PSIP*). It depends on broadcasts which communicate a new rating system through the PSIP that both the chip and a TV's software can understand. With the RRT setting, program blocking occurs when a program rating is received that meets the pre-determined user requirement.

The following is an example of one segment.

To set the RRT rating levels:

- 1 Press **MENU** on the remote control, then press **◀/▶** to highlight the **Locks** icon. The *Enter Password* screen opens.

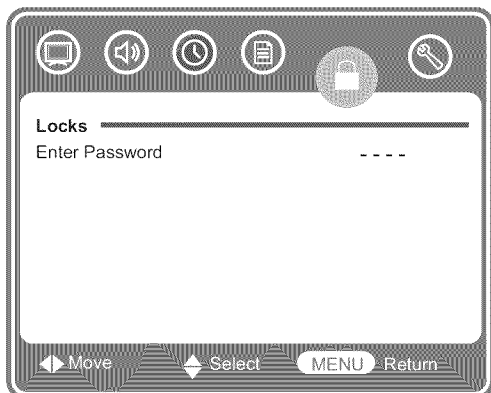

- 2 Press **▼** to enter the *Enter Password* screen.
 3 Enter the password with the number buttons on the remote control (the default password is **0000**). The *Locks* menu opens.

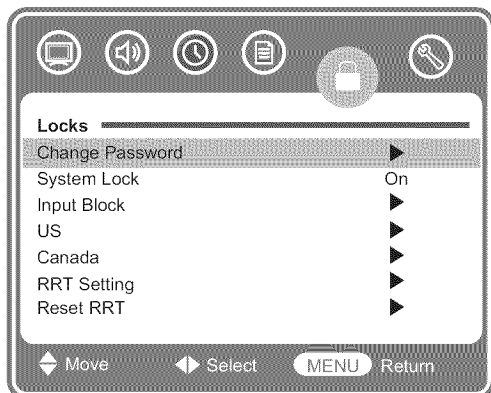

- 4 Press **▲/▼** to highlight **RRT Setting**, then press **▶** to open the *RRT ratings* sub-menu. The *RRT ratings* sub-menu opens.

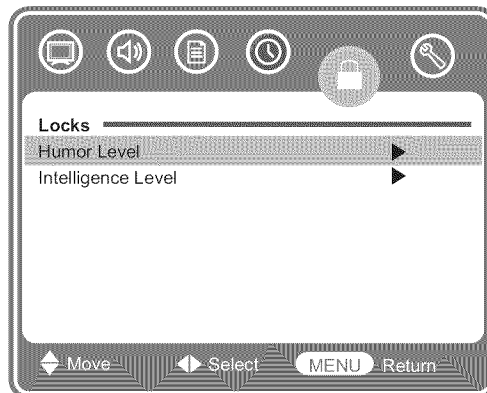

- 5 Press **▲/▼** to select **Humor Level** or **Intelligence Level**, then press **▶** to open the selected sub-menu. The selected sub-menu opens.

Humor Level

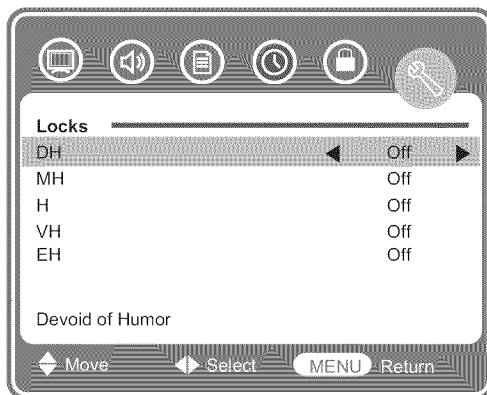

Intelligence Level

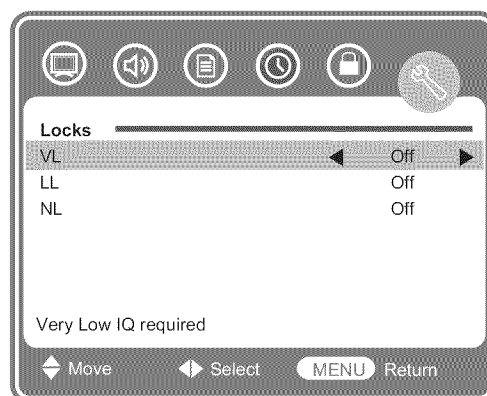

- 6 Press **▲/▼** to select the rating level you want to set, then press **◀/▶** to set the rating to **On** or **Off**. Ratings include:
- **Humor Level-DH, MH, H, VH, EH.**
 - **Intelligence Level-VL, LL, NL.**
- 7 Press **MENU** one or more times to close the menu.

PC input signal chart

The following chart shows the suggested screen resolutions.

Format	Resolution	Freq. (Hz)
VGA	640 × 480	60
	720 × 400	70
SVGA	800 × 600	60
	800 × 600	72
XGA	1024 × 768	60
WXGA	1280 × 768	60
	1360 × 768	60

- If "Unsupported Mode" appears on the screen, adjust the PC display setting to correspond to one of the settings in the above table.
- If you switch off the TV, interference lines may occur on the TV screen. This is normal.

Changing your computer's video resolution

The following example shows Windows XP® settings. Even if you use a different Windows operating system, the basic setup methods are similar. For changing video resolution on a Macintosh® computer, refer to your Macintosh® documentation.

To change your computer's video resolution:

- 1 Click **Start, Control Panel**, then double-click **Display**. The *Display Properties* dialog box opens.

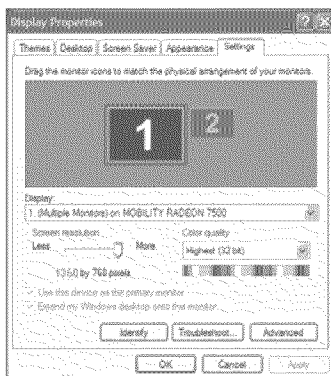

- 2 Click the **Settings** tab.
- 3 Change the screen resolution setting to a supported resolution (the ideal resolution for your TV is **1360 × 768**).
- 4 Click **OK**, then click **Yes** to save your changes.

Troubleshooting

Problem	Solution
No picture or sound	<ul style="list-style-type: none"> • Check all cable connections. • Make sure that your TV is turned on.
Picture is OK, but no sound	Check the volume level and mute setting.
Sound is OK, but no color	<ul style="list-style-type: none"> • Check the color control and adjust it. • Check the program's color features because it may be a black and white movie.
The picture has overlapped images	Make sure that the antenna is installed correctly. If not, adjust the antenna toward the broadcasting station.
Picture has snow	<ul style="list-style-type: none"> • Check the antenna and its connection. If there are problems, correct them. If all connections are tight, the problem may be with a faulty antenna or cable. • Check car traffic or neon signs that may disrupt the image.
Stripes on picture	Check for interference from other electronic devices, such as radios and televisions, and keep magnetic or electronic devices away from your TV.
Bad stereo or SAP sound	A long broadcast distance, or interference from radio waves, can cause bad sound reception. If so, change the mode to Mono.
Remote control does not work	Remove obstacles between the remote control and the player. Point the remote control at your TV's IR sensor. Install new batteries.
"Unsupported Mode" appears on the screen	Check the resolution and frequency of your computer, and adjust it to the optimum resolution for this TV: 1360×768 at 60Hz.
"No Sync" appears on the screen	Make sure that the cable is firmly connected to the computer and TV.
Image is not clear	Adjust the phase control.
Image is not centered	Adjust the horizontal control.
Picture has a few bright or dark dots	A few bright or dark dots on an LCD screen is normal. It does not affect the operation of this TV.

Specifications

Model Name		L32A102&L32A102G
Panel	Size	31.51 inches
	Resolution	1366x768
Power Requirement		AC 120V, 60 Hz
Power Consumption		115W, 1A (L32A102) 180W, 1.6A (L32A102G) 
Audio Output		7W+7W
Dimension (WxHxD)	With Stand	31.3x22.7x11 inch (795x576x280mm)
	Without Stand	31.3x21x3.3 inch (795x533x85mm)
Weight	With Stand	34.5 lbs. (15.7kg)
	Without Stand	30 lbs. (13.7kg)
Terminals	AV1	S-VIDEO, VIDEO IN, L/R AUDIO IN
	AV2	S-VIDEO, VIDEO IN, L/R AUDIO IN
	AV3	COMPONENT IN, L/R AUDIO IN
	HDMI1	HDMI IN
	HDMI2	HDMI IN
	RGB	RGB IN, AUDIO IN(Mini jack)
	OUTPUT	L/R AUDIO OUTPUT, COAXIAL DIGITAL AUDIO OUTPUT
	HEADPHONE	Mini jack
Input Signals	TV Standard	ATSC/QAM/NTSC
	Component	480i/p, 720p, 1080i
	HDMI	480i/p, 720p, 1080i
	Analog RGB	VGA-WXGA

NOTE

- Design and specifications are subject to change without notice.
- Weight and dimensions shown are approximate values only.

Service Information

800.HITACHI
(800.448.2244)

**Operational, hook up and
warranty questions for your product.**

**Monday ~ Sunday
8:00 am - 8:30 pm CST**

www.hitachi.us/tv



Sincere - Prompt - Efficient

HITACHI
Inspire the Next

HITACHI HOME ELECTRONICS (AMERICA), INC.

HITACHI has made every effort to assure you hours of trouble free operation from your Hitachi product.

Should you require service assistance with **OPERATIONAL, HOOK UP, TECHNICAL ASSISTANCE OR WARRANTY SUPPORT**, please contact our Support Hotline at **800.HITACHI (800.448.2244)**.

Our Support Hotline will provide you with the assistance you need and if necessary the location of the nearest Authorized Service Facility in your area. Please present proof of purchase and/or delivery receipts to the Hitachi Authorized Service Facility and service will be rendered in accordance with the terms of the limited warranty as stated on your warranty card or operating guide.

**Hitachi Home Electronics
(America), Inc.
Customer Service Support
PO Box 3900
Peoria, IL 61612
customerservice.ce@hhea.hitachi.com**

HITACHI HOME ELECTRONICS (CANADA)

Should you have any questions regarding warranty, service, operation or technical assistance, please contact:

In Canada: 800.HITACHI (800.448.2244)

Monday~ Friday 9:00 am – 7:00 pm EST
Saturday 9:00 am – 5:00 pm EST

Pour de plus amples renseignements sur le service durant la période couverte par la garantie, sur le fonctionnement ou pour de l'assistance technique communiquez avec:

Au Canada: 800.HITACHI (800.448.2244)

Lundi~ Vendredi 9:00 am – 7:00 pm L'EST
Samedi 9:00 am – 5:00 pm L'EST

**Hitachi Home Electronics (Canada)
Customer Service Support
PO Box 3900
Peoria, IL 61612**

Customer Record

The MODEL NAME and SERIAL NUMBER of this product is located on the backcover and also on the RIGHT SIDE of the set. Please follow the next steps to find this information and then record it in the space provided below for use in case you call 800.HITACHI, they will require this information in order to give you the proper support.

- ❶ Look on the right side of the set
- ❷ Locate the label where it shows the information related to MODEL NAME and SERIAL #.
- ❸ 800.HITACHI will require this information in order to give you the proper support regarding your questions.

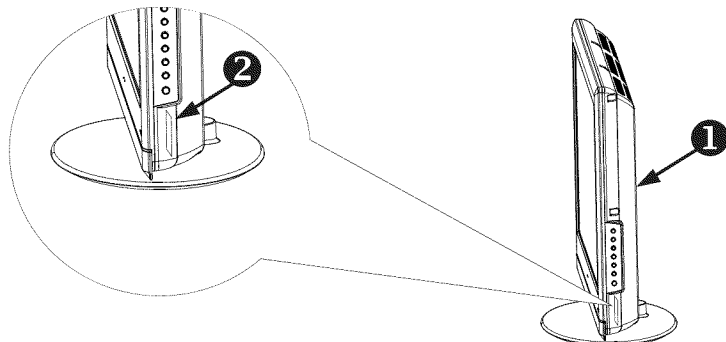

Model Name _____

Serial Number _____

Limited Warranty

Congratulations on your purchase of a new Hitachi Product display product.
 Register your product online at www.hitachi.us/tv or mail the included warranty registration card:

LIMITED WARRANTY
 Hitachi Home Electronics (America), Inc. warrants this Hitachi Product in accordance with the terms and conditions applicable to the Hitachi Product identified below:

Conditions of Hitachi Limited Warranty
 This Hitachi display product (the "Product") is warranted to be free from defects in materials and workmanship beginning on the date of purchase by the original owner and continuing for the duration of the applicable time periods specified below. If the Product is found to be defective, Hitachi will repair or replace (at Hitachi's option) defective parts at no charge, subject to the conditions of this Limited Warranty. If the original owner rejects, refuses or otherwise does not accept Hitachi's offer to repair or replace such defective parts under this Limited Warranty, this Limited Warranty shall be void and of no further force or effect. This Limited Warranty extends to the original owner only and is not transferable, and such owner must provide a dated sales receipt for the Product to qualify for parts or service under this Limited Warranty. The original owner must notify Hitachi of a defect claim during the applicable Limited Warranty period for this Limited Warranty to be effective. This Limited Warranty is valid only in the U.S.A. and Puerto Rico.

Hitachi Product:
 LCD Flat Panel Televisions

PARTS: The Limited Warranty period for parts is 1 year from the date of original purchase. During the Limited Warranty period for parts, Hitachi will replace defective parts with new or rebuilt parts (at Hitachi's option) at no charge for such parts. Any replacement part will be warranted for the remainder of the original warranty period applicable to the part replaced.
LABOR: The Limited Warranty period for labor is 1 year from the date of original purchase. During the Limited Warranty period for labor, Hitachi will repair or replace (at Hitachi's option) defective parts without charge for labor.
SERVICE LOCATION: In-home warranty service, which includes either in-home repair or free pick-up and delivery (at Hitachi's option), applies to all Hitachi Products except: (i) 32-inch and smaller LCD Flat Panel Televisions or LCD Flat Panel Monitors; (ii) Products located outside the U.S.A. or Puerto Rico; (iii) Products located more than seventy-five (75) driving miles from Hitachi's nearest Authorized Service Facility. If the foregoing clauses (i), (ii), (iii) apply, then the Product owner will be responsible for bringing/delivering the Product to a Hitachi Authorized Service Facility and, following warranty service, retrieving the Product from such Authorized Service Facility.



Hitachi is a proud supporter of the Certified Service Center program. Businesses who display the CSC certification mark have demonstrated that they operate in accordance with the high standards of professionalism prescribed by the Consortium for Certified Service Centers.

800-HITACHI (800-448-2244)

Please call 800-HITACHI (800-448-2244) for operational, hook up, warranty questions or the location of your nearest Hitachi Authorized Service Facility or Parts Distributor.

Visit our website and register your product online:

Hitachi's website features a wealth of information on Hitachi products and technologies, as well as downloadable operating guides and other useful information.

To register your new Hitachi display product online, go to:
www.hitachi.us/tv Support and Contact/Warranty Registration

IMPORTANT:

Before using or installing your Product, please complete this form and attach your sales receipt and retain them for your records. This will help facilitate proper warranty coverage.

MODEL NO.	SERIAL NO.
DEALER NAME	DATE OF PURCHASE
DEALER ADDRESS	
CITY	STATE

Warranty Limitations

This Hitachi Limited Warranty does not cover:

- A. Any Product that has been modified or repaired in a manner not previously authorized by Hitachi in writing.
- B. Any Product whose serial number has been removed, altered, replaced, defaced or rendered illegible.
- C. Any defect, malfunction, or failure caused by or resulting from improper or unauthorized service, maintenance or repair.
- D. Damage resulting from abuse, misuse, mishandling, neglect or damage caused by exposure to hostile operating environments such as areas containing dust and/or smoke.
- E. Damage caused by power surges, accidents, natural disasters or any other events or circumstances outside Hitachi's control.
- F. Any Product used in any manner inconsistent with the acceptable set-up, usage, safety or installation configurations identified in the Product's Operating Guide.
- G. Any Product used for purposes or applications, or subjected to operating conditions, other than those identified as acceptable in the Product's Operating Guide.
- H. Product repairs (including any product whose case has been opened), or part replacements provided or installed, by any person other than an Authorized Hitachi Service Facility Representative.
- I. Improper uncrating, set-up or installation or any misadjustments caused by user-operated controls.
- J. Any labor or costs associated with removing the Product from a custom cabinet or other specialized product installation that impedes direct and immediate removal of the Product from the owner's premises (must be arranged and paid by the owner).
- K. Product cabinets, cabinet parts, knobs, batteries or accessories.
- L. Product screens that have been cleaned by any method other than as specified in the Product's Operating Guide.
- M. Normal usage, degraded brightness caused by backlight aging and/or cell defects or ordinary wear and tear, including, without limitation, scratches or marks on the Product's screen, cabinet or the appearance of bright or dark screen pixels.
- N. Any Product returned for service that is damaged due to improper packaging, mishandling or shipping. (IMPORTANT: When shipping any Product to a Hitachi Authorized Service Centers, Product owner must package it securely in the original shipping container or its equivalent to prevent damage. The Product must be returned with the shipping charges prepaid and proof of purchases included in the shipping container. Failure to properly package such product during such shipment will void all warranties.)
- O. Any Product purchased or serviced outside the United States of America and Puerto Rico.
- P. Any Product that has been used for commercial purposes.

NO PERSON, AGENT, DISTRIBUTOR, DEALER, SERVICE FACILITY, OR COMPANY IS AUTHORIZED TO CHANGE, MODIFY OR AMEND THE TERMS OF THIS LIMITED WARRANTY IN ANY MANNER WHATSOEVER. EXCEPT AS PROVIDED IN THIS LIMITED WARRANTY, HITACHI MAKES NO EXPRESS WARRANTY REGARDING THIS HITACHI PRODUCT. FURTHER, ALL IMPLIED WARRANTIES RELATING TO ANY PORTION OF THIS PRODUCT, INCLUDING ANY WARRANTY OF MERCHANTABILITY OR FITNESS FOR A PARTICULAR PURPOSE, ARE LIMITED TO THE DURATION SPECIFIED UNDER THIS LIMITED WARRANTY. HITACHI SHALL NOT BE LIABLE TO THE PURCHASER OR TO ANY OTHER PERSON FOR ANY INCIDENTAL OR CONSEQUENTIAL DAMAGES OR LOSS OF PROFIT OR PRODUCT RESULTING FROM ANY DEFECT IN, OR MALFUNCTION OR FAILURE OF, THIS HITACHI PRODUCT. BECAUSE SOME STATES DO NOT ALLOW LIMITATIONS ON HOW LONG AN IMPLIED WARRANTY LASTS, OR THE EXCLUSION OF INCIDENTAL OR CONSEQUENTIAL DAMAGES, THE ABOVE LIMITATIONS MAY NOT APPLY TO YOU. THIS LIMITED WARRANTY CONFERS SPECIFIC LEGAL RIGHTS, INCLUDING CERTAIN OTHER RIGHTS THAT MAY VARY DEPENDING ON YOUR JURISDICTION.

HITACHI

Inspire the Next
