

SONY

BRAVIA

LCD Digital Color TV

Operating Instructions

KDL-65W5100
KDL-52W5100
KDL-52W5150
KDL-46W5100
KDL-46W5150
KDL-40W5100

Sony Customer Support

U.S.A.: www.sony.com/tvsupport

Canada: www.sony.ca/support

United States

1.800.222.SONY

Canada

1.877.899.SONY

Please Do Not Return
the Product to the Store

Owner's Record

The model and serial numbers are located at the side and the rear of the TV. Record these numbers in the spaces provided below. Refer to them whenever you call upon your Sony dealer regarding this TV.

Model Name

Serial No.

"CrossMediaBar" is a trademark of Sony Corporation. "XMB" is a trademark of Sony Corporation and Sony Computer Entertainment Inc.

"PlayStation" is a registered trademark and "PS3" is a trademark of Sony Computer Entertainment Inc.

DLNA[®], the DLNA Logo and DLNA CERTIFIED[™] are trademarks, service marks, or certification marks of the Digital Living Network Alliance.



CAUTION

To prevent electric shock and blade exposure, do not use this polarized AC plug with an extension cord, receptacle or other outlet unless the blades can be fully inserted.

- Operate the TV only on 120-240 V AC.
- Avoid operating the TV at temperatures below 41°F (5°C).

Licensing Information

Macintosh is a trademark of Apple Inc., registered in the U.S. and other countries.

HDMI, the HDMI logo and High-Definition Multimedia Interface are trademarks or registered trademarks of HDMI Licensing, LLC.

Ferguson Patent Properties, LLC:
U.S. Patent No. 5,717,422
U.S. Patent No. 6,816,141

Manufactured under license from Dolby Laboratories. Dolby and the double-D symbol are trademarks of Dolby Laboratories.

In the United States, TV Guide and other related marks are trademarks of Gemstar-TV Guide International, Inc. and/or its subsidiaries. In Canada, TV Guide is a registered mark of Transcontinental Inc., and is used under license by Gemstar-TV Guide International, Inc. and/or its subsidiaries.

The TV Guide On Screen system is manufactured under license from Gemstar-TV Guide International, Inc. and/or its subsidiaries.

The TV Guide On Screen system is protected by one or more of the following United States patents 6,498,895; 6,850,693; 6,396,546; 5,940,073; 6,239,794 to Gemstar-TV Guide International, Inc. and/or its subsidiaries.

Gemstar-TV Guide International, Inc. and/or its related affiliates are not in any way liable for the accuracy or availability of the program schedule information or other data in the TV Guide On Screen system and cannot guarantee service availability in your area. In no event shall Gemstar-TV Guide International, Inc. and/or its related affiliates be liable for any damages in connection with the accuracy or availability of the program schedule information or other data in the TV Guide On Screen system.

Blu-ray Disc is a trademark.

"BRAVIA" and BRAVIA, S-Force, Motionflow, BRAVIA Sync,  and DME[®] are trademarks or registered marks of Sony Corporation.

Your BRAVIA TV is ENERGY STAR[®] qualified in the "Home" mode.

It meets strict energy efficiency guidelines set by the U.S. Environmental Protection Agency and Department of Energy. ENERGY STAR is a joint program of these government agencies, designed to promote energy efficient products and practices.



Changes to certain features, settings, and functionalities of this TV (i.e. TV Guide, Picture/Sound, Light Sensor, Power Savings) can increase or change the power consumption.

Depending upon such changed settings, the power consumption may exceed the limits required for the ENERGY STAR qualification in the "Home" mode.

This manual is for the 40, 46, 52 inch and 65 class BRAVIA KDL-W series models with screen size measured diagonally. The 65 class has a 64.5 inch viewable image size (measured diagonally).

Contents

Introducing Your BRAVIA® TV

Experiencing Stunning HD with Your BRAVIA TV	4
The Four Steps to a Full HD Experience	4
TV Feature Highlights	5

Getting Started

Setting Up Your TV	6
Using a Wall-Mount Bracket	6
Securing the TV	7
Locating Inputs and Outputs	8
Connecting the TV	10
Connecting Internet & DLNA Certified™ Networks	13
Connecting Other Equipment	14
Bundling the Connecting Cables	15
Installing the TV Against a Wall or Enclosed Area	15
Running Initial Setup	16

Operating the TV

Using the Remote Control	17
Remote Control Button Description	18
TV Controls and Indicators	21

Exploring the XMB™ and TV Features

Category Icons	23
Accessing Photo, Music, and Video Content	24
BRAVIA Internet Video	25
Photo, Music, and Video	26
BRAVIA Internet Widgets	28
Favorites	30
TV Guide On Screen®	31
Background TV	33
Inputs	33
Wide Mode	34
BRAVIA® Sync™ with Control for HDMI	35

Other Information

How to Care for Your BRAVIA	36
Troubleshooting	36
Specifications	38
Index	39

Welcome to the World of BRAVIA® HDTV

Thank you for purchasing this Sony BRAVIA® high-definition television. Use the documentation listed below to get the most out of your TV.



Safety Booklet

Provides precautionary measures to keep you and your TV safe. Read this information prior to setting up your TV.



Quick Setup Guide

Provides TV setup information, illustrates sample optional equipment connection diagrams, and highlights TV features.



Operating Instructions

Provides general TV operation information.



Reference Book

Offers the most complete TV operation information available for your TV and presents advanced customization details. Access it at www.sony.com/referencebook.



The TV operation information above has been designed in an eco-friendly manner to reduce the consumption of natural resources.

Introducing Your BRAVIA® TV

Experiencing Stunning HD with Your BRAVIA TV

To experience the stunning detail of your new BRAVIA TV, you need access to high-definition (HD) programming. Your BRAVIA TV can receive and display HD programming from:

- Over-the-air broadcasting via HD-quality antenna
- HD cable subscription
- HD satellite subscription
- Blu-ray Disc™ player or other HD compatible external equipment

Contact your cable, satellite or HD service provider for information on upgrading to HD programming.

The Four Steps to a Full HD Experience

Set, Source, Sound, and Setup

Along with your BRAVIA TV **set**, a complete HD system requires a **source** of HD programming, an HD **sound** system, and a proper connection **setup**. Refer to the Quick Setup Guide, enclosed separately, for connecting other optional equipment.

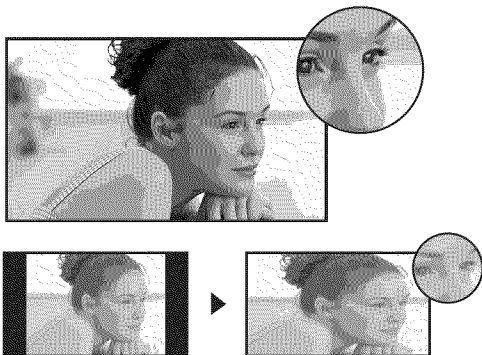

You can enjoy crisp, clear images, smooth movement, and high-impact visuals from 1080 HD signals as shown here.

When you compare a high-definition signal to a standard definition signal, you will notice a big difference in picture quality. If black bars appear as shown here, press **WIDE** on the remote control to fill the screen.

TV Feature Highlights

Your **BRAVIA** TV is equipped with the latest in TV technology.

- **Broadband Internet Connectivity: BRAVIA** Internet Video brings videos, movies and much more from the Internet to your TV (page 25). **BRAVIA** Internet Widgets allow you to access local weather, news, and much more. Displayed here is **Widgets** (page 28).
- **Digital Media Accessibility:** Use the **Photo, Music, and Video** Category icons to access photo, music, and video files from DLNA Certified™ networked equipment or Sony USB equipment. Displayed here is **Photo USB** (page 26).
- **Central Location for Your Favorite Items:** The **Favorites** feature centralizes your favorite **BRAVIA** Internet Video and **Widgets** items, **Photo, Music, Video** content, **TV channels, External Inputs, and Background TV** themes for quick and easy access (page 30).
- **Channel Programming Information: TV Guide On Screen®** provides TV programming information (page 31).
- **TV Home Menu: XMB™ (XrossMediaBar)** TV menu provides you access to TV settings, photo, music, video, TV channel listings, and more (page 22).

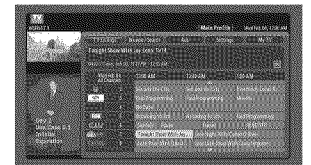
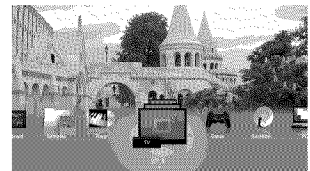
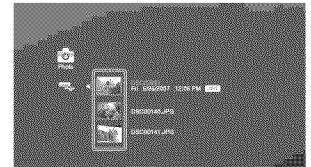
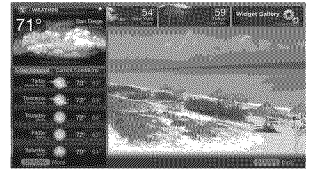

Getting Started

Setting Up Your TV

Some TV models are packaged with a detached Table-Top Stand so you can mount your TV to a wall right away. If you are not mounting the TV to a wall, you will need to attach the Table-Top Stand. You will need a Phillips screwdriver and the supplied screws to complete the task. Look for the attachment instructions provided with the TV.

Be sure to consider the following while setting up your TV:

- Disconnect all cables when carrying the TV.
- Carry the TV with the adequate number of people; larger size TVs require two or more people.
- Correct hand placement while carrying the TV is very important for safety and to avoid damage.

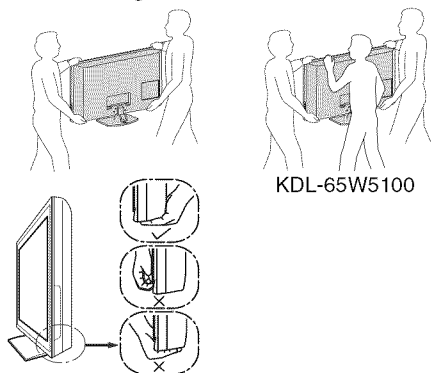

KDL-65W5100

- Ensure your TV has adequate ventilation, see page 15.
- For best picture quality, do not expose the screen to direct illumination or sunlight.
- Avoid installing the TV in a room with reflective wall and floor materials.
- Avoid moving the TV from a cold area to a warm area. Sudden room temperature changes may cause moisture condensation. This may cause the TV to show poor picture and/or poor color. Should this occur, allow moisture to evaporate completely before powering the TV on.

Using a Wall-Mount Bracket

All models can be mounted on a wall using a Wall-Mount Bracket (not supplied). Models 52 inch and larger (measured diagonally) will require removing the Table-Top Stand; refer to the instructions provided with the TV.

Prepare the TV for the Wall-Mount Bracket before making cable connections.

For product protection and safety reasons, Sony strongly recommends that you use the Wall-Mount Bracket designed for your TV and the installation should be performed by a Sony dealer or licensed contractor.

- Follow the instruction guide provided with the Wall-Mount Bracket for your model. You may also need to refer to the online Reference Book for additional information for your TV model. Sufficient expertise is required in installing this TV, especially to determine the strength of the wall for withstanding the TV's weight.
- Be sure to use the screws supplied with the Wall-Mount Bracket when attaching the mounting hooks to the TV set. (Do not use the screws that are intended for the Table-Top Stand attachment.)

The supplied M6 screws are designed so that they are 8 mm to 12 mm in length when measured from the attaching surface of the mounting hook.

Use of screws other than those supplied with the bracket may result in internal damage to the TV set or cause it to fall, etc.

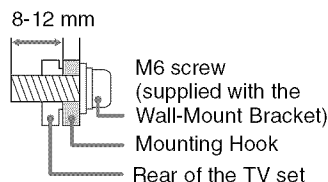

- Be sure to store the unused screws and Table-Top Stand in a safe place until you are ready to attach the Table-Top Stand. Keep the screws away from small children.



- Read the supplied Safety Booklet for additional safety information.

Securing the TV



Sony strongly recommends taking measures to prevent the TV from toppling over. Unsecured TVs may topple and result in property damage, serious bodily injury or even death.

Preventing the TV from Toppling

- Secure the TV to a wall and/or stand.
- Do not allow children to play or climb on furniture and TV sets.
- Avoid placing or hanging items on the TV.
- Never install the TV on:
 - slippery, unstable and/or uneven surfaces.
 - furniture that can easily be used as steps, such as a chest of drawers.
- Install the TV where it cannot be pulled, pushed, or knocked over.
- Route all AC power cords and connecting cables so that they are not accessible to curious children.

Detailed information available in the online Reference Book

Secure the Stand for the TV

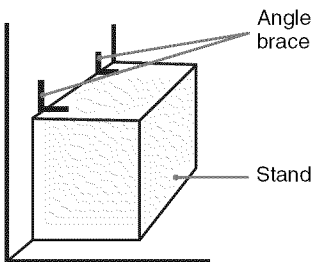

Secure the TV to the Stand

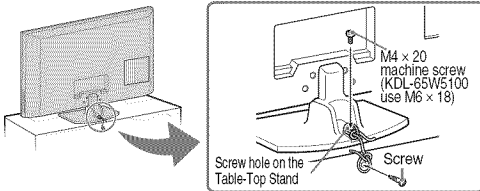

Contact Sony Customer Support to obtain the optional Support Belt Kit by providing your TV model name.

- For United States call: 1-800-488-7669
or visit: www.sony.com/accessories
- For Canada call: 1-877-899-7669

Anchor the TV to the Wall

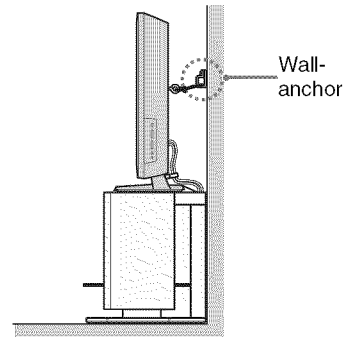
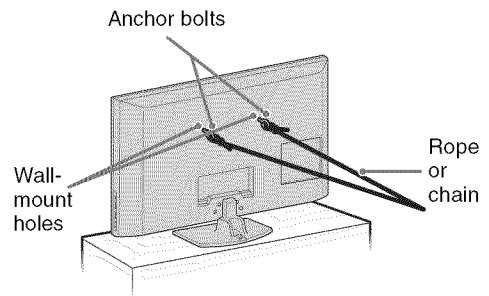

Locating Inputs and Outputs

Rear Panel

Side Panel

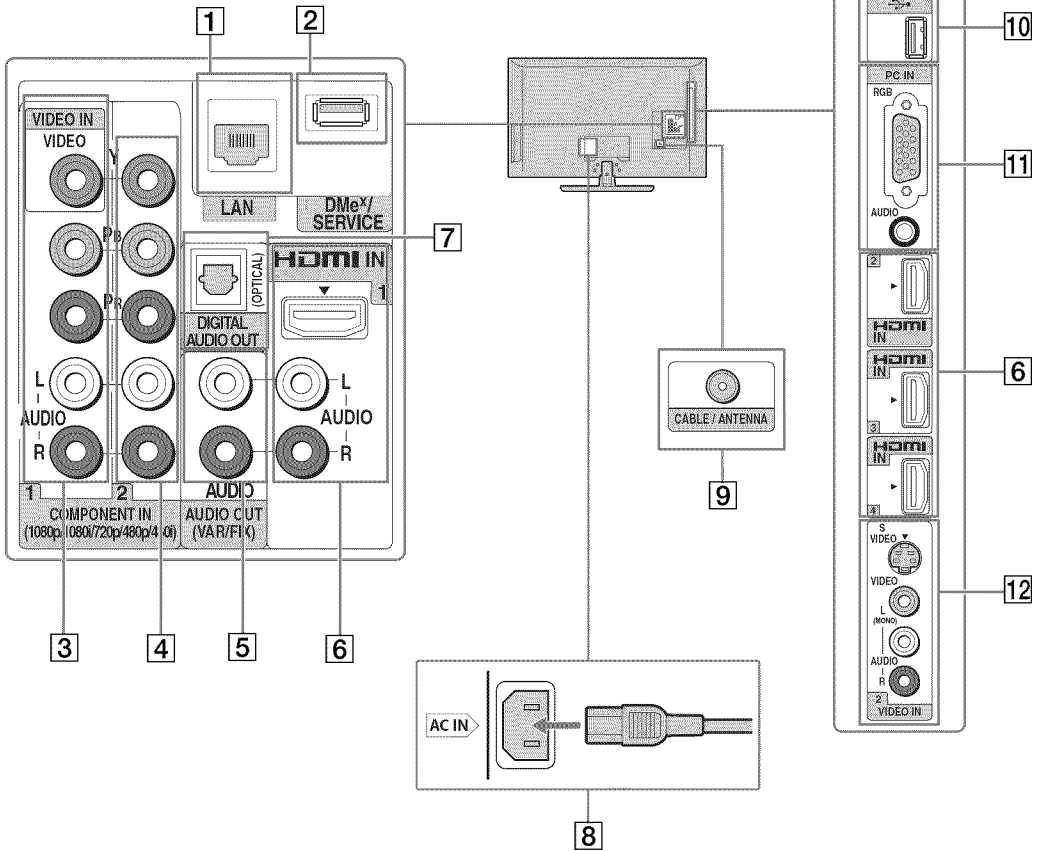

- An HDMI or Component video (YPbPr) connection is required to view 480i, 480p, 720p, 1080i and 1080p video formats. The 1080/24p video format is available only with HDMI connection. This TV displays all video input signals in a resolution of 1,920 dots × 1,080 lines.

Item	Description
1 LAN	Connects to an existing network using an Ethernet cable. Be sure to complete Network Setup (page 16).
2 DMe^x/SERVICE	This USB port is only for service unless you are connecting an optional BRAVIA Link module (DMe ^x).
3 VIDEO IN 1/ COMPONENT IN 1 (1080p/ 1080i/720p/ 480p/480i)/ L-AUDIO-R	This input port can be used as composite video input (VIDEO 1) or as component video input (COMPONENT 1). For composite use, connect the yellow jack to Y for video and use audio (L/R) for audio signals. For component connection, use Y, PB, PR for video signals and also connect the audio (L/R) for audio signals. By default, this TV will automatically detect and switch between VIDEO 1 and COMPONENT 1. To manually set the input type, press HOME , select Settings , then Channels & Inputs , then select Video/Component 1 Selection .
4 COMPONENT IN 2	Component video provides better picture quality than the S Video and composite video. Audio connection is required for the COMPONENT IN ports, connect audio (L/R).
5 AUDIO OUT (VAR/FIX)	Connects to the left and right audio input jacks of your analog audio equipment. You can use these outputs to listen to your TV's audio through your stereo system.
6 HDMI IN 1/2/3/4 L-AUDIO-R	HDMI (High-Definition Multimedia Interface) provides an uncompressed, all-digital audio/video interface between this TV and any HDMI-equipped audio/video equipment, such as a set-top box, DVD player, and A/V receiver. HDMI supports enhanced, or high-definition video, plus digital audio. Be sure to use only an HDMI cable that bears the HDMI logo. Use the HDMI IN 1 port when connecting DVI equipment with a DVI-to-HDMI cable or adapter (not supplied). Equipment using a DVI connection also requires an additional audio connection using an audio cable connected to AUDIO (L/R).
7 DIGITAL AUDIO OUT (OPTICAL)	Connects to the optical audio input of digital audio equipment that is PCM/Dolby* Digital compatible.
8 AC IN	Connects to your power source. Connect the supplied power cord to AC IN and the nearest wall outlet.
9 CABLE/ ANTENNA	RF input that connects to your cable or over-the-air antenna.
10 USB	Connects to USB equipment to access photo, music, and video files.
11 PC IN (RGB/AUDIO)	Connects to a personal computer's video and audio output connector. Can also be connected to other analog RGB equipment. For some Apple Macintosh computers, it may be necessary to use an adapter (not supplied). If an adapter is used, connect the adapter to the computer before connecting the HD15-HD15 cable. You may need to adjust the TV settings or your PC's resolution and timing (see page 12).
12 VIDEO IN 2 S VIDEO/VIDEO L (MONO)- AUDIO-R	Connects to the S VIDEO output jack of video equipment. If both composite video and S VIDEO are connected, S VIDEO signal has priority. If you have mono equipment, connect its audio output port to the TV's L (MONO) audio input port.

* Manufactured under license from Dolby Laboratories. Dolby and the double-D symbol are trademarks of Dolby Laboratories.

Connecting the TV

Cable System or VHF/UHF Antenna System

You can enjoy high-definition and standard-definition digital programming (if available in your area) along with standard-definition analog programming.

This TV is capable of receiving unscrambled digital programming for both cable (QAM and 8VSB) and external VHF/UHF antenna (ATSC).

Cable or VHF/UHF (or VHF only)



- It is strongly recommended that you connect the CABLE/ANTENNA input using a 75-ohm coaxial cable to receive optimum picture quality. A 300-ohm twin lead cable can easily be affected by radio frequency interference, resulting in signal degradation.

Cable System and VHF/UHF Antenna System

Use an optional A-B RF switch (not supplied) to switch between the cable and over-the-air antenna programming, as shown here.

Set the **Cable/Antenna** setting found

under the Settings on the **XMB™** to **Cable** or **Antenna** for the type of input signal you choose.

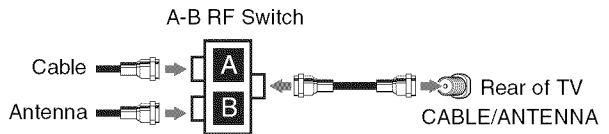

HD Cable Box/HD Satellite Box

You can enjoy high-definition programming by subscribing to a high-definition service or a high-definition satellite service. For the best possible picture, make sure you connect this equipment to your TV via the HDMI or component video (with audio) input located on the back of your TV.

Shown with HDMI Connection

Rear of TV

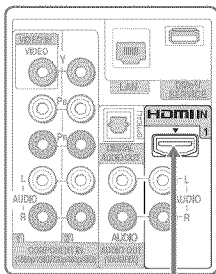

CATV/Satellite antenna cable

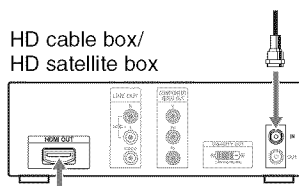

HDMI cable

Shown with DVI Connection

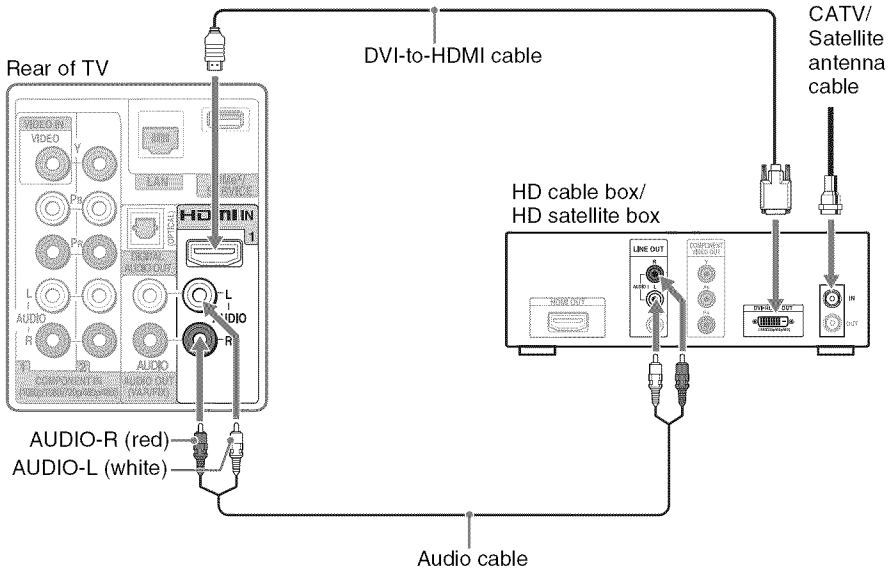

- If your equipment has a DVI output and not an HDMI output, connect the DVI output to the HDMI IN 1 (with DVI-to-HDMI cable or adapter) and connect the audio output to the AUDIO IN (L/R) of HDMI IN 1.

Shown with Component Connection

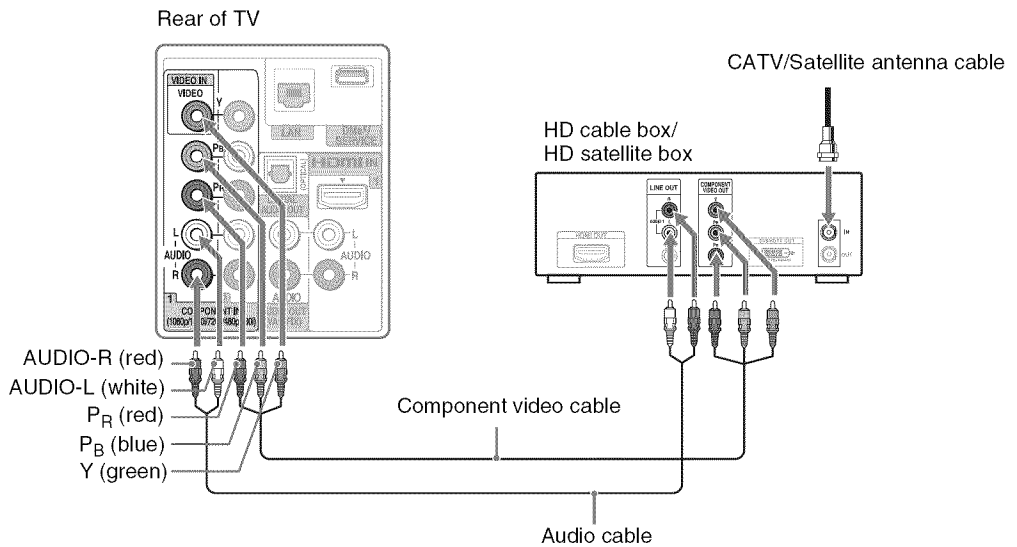

Shown with PC connection

Use the TV as a monitor for your PC by connecting an HD15-HD15 cable connection as shown to the right.

This TV can also be connected to a PC with a DVI or HDMI output. (Refer to the supplied Quick Setup Guide.)

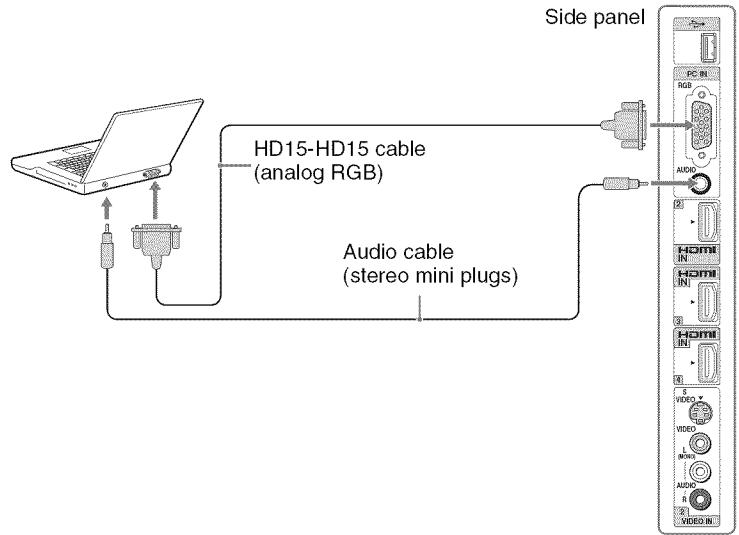

PC Input Signal Reference Chart

After connecting the PC to the TV, set the output signal from your PC according to the supported resolutions and timings indicated below.

<i>Supported resolutions</i>							
<i>Signal</i>	<i>Horizontal (Pixel)</i>	<i>x</i>	<i>Vertical (Line)</i>	<i>Horizontal frequency (kHz)</i>	<i>Vertical frequency (Hz)</i>	<i>Standard</i>	
VGA	640	x	480	31.5	60	VGA	
SVGA	800	x	600	37.9	60	VESA Guidelines	
XGA	1,024	x	768	48.4	60	VESA Guidelines	
WXGA	1,280	x	768	47.4	60	VESA	
	1,280	x	768	47.8	60	VESA	
	1,360	x	768	47.7	60	VESA	
SXGA	1,280	x	1,024	64.0	60	VESA	
HDTV*	1,920	x	1,080	67.5	60	CEA-861*	



- This TV's PC input does not support Sync on Green or Composite Sync.
- This TV's PC VGA input does not support interlaced signals.
- For the best picture quality, it is recommended to use the signals in the above chart. In plug and play, signals with a 60 Hz vertical frequency will be detected automatically. (PC reboot may be necessary.)

*The 1080p timing when applied to the HDMI input will be treated as a video timing and not PC timing. This affects **Picture** settings and **Wide Mode** settings. To view PC content set **Scene Select** to **Graphics**, **Wide Mode** to **Full**, and **Display Area** to **Full Pixel**.



- Connect the PC IN jack to the PC using an HD15-HD15 cable with ferrite core (analog RGB) and audio cable (see page 9).
- The TV enters the standby mode automatically when the PC is connected to the TV and no signal has been output from the PC for more than 30 seconds, see the online Reference Book for details.

Connecting Internet & DLNA Certified™ Networks

Connect an Ethernet cable from your home network to the LAN input of your TV to enjoy **BRAVIA** Internet features and/or connect to DLNA Certified™ media servers, see page 25 to learn more about these features.

Sample Network Connection Diagram

Internet Features

- **BRAVIA** Internet Video
- **BRAVIA** Internet Widgets

DLNA Certified™ Media Player Features

- Photo
- Music
- Video

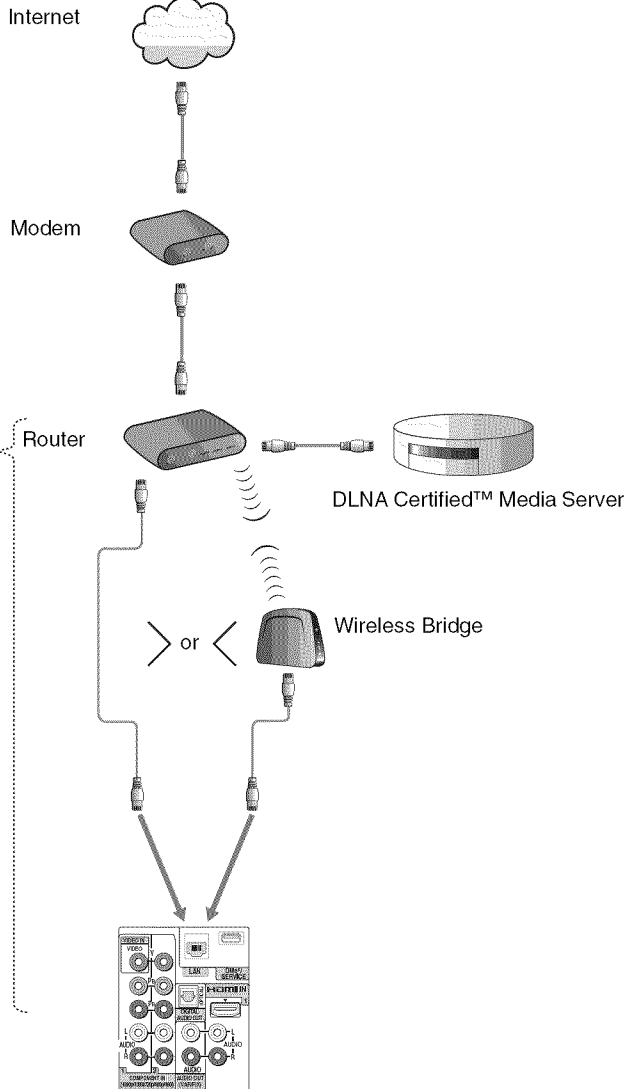

- For more information about compatible wireless bridges, visit <https://internet.sony.tv>
- Refer to your DLNA Certified equipment's operating instructions for setup and connection information.

Connecting Other Equipment

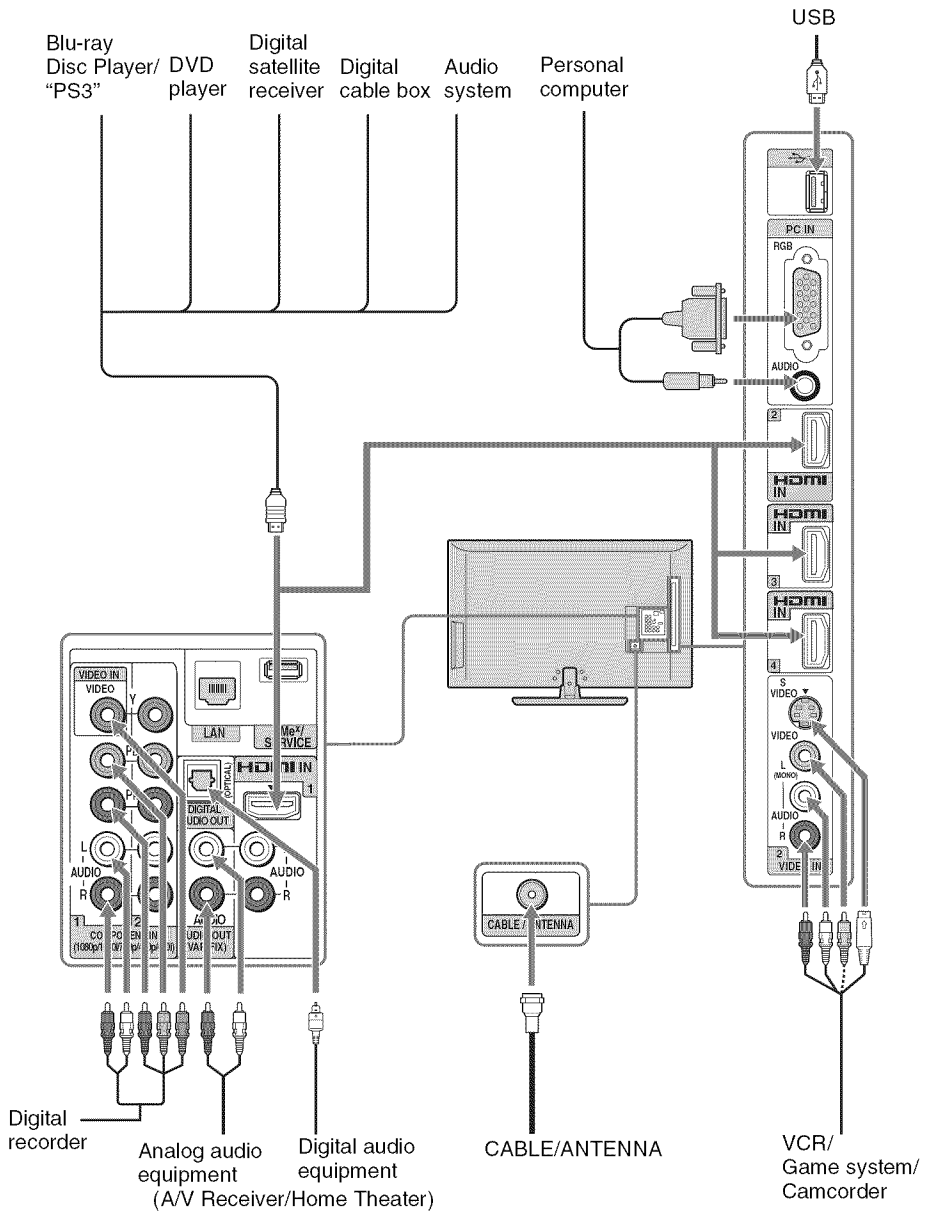

• Refer to the Quick Setup Guide (supplied) when connecting other equipment to your TV.

Bundling the Connecting Cables

Use the attached cable clumper to bundle the connecting cables. The cable clumper is located on the Table-Top Stand as illustrated. Refer to the online Reference Book when mounting the TV to a wall.

Do not bundle the AC power cord with other connecting cables. This can affect the picture quality.

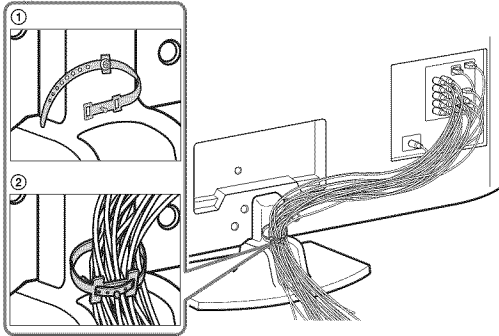

Installing the TV Against a Wall or Enclosed Area

Make sure that your TV has adequate ventilation. Allow enough space around the TV as shown below. Avoid operating the TV at temperatures below 41 °F (5 °C).

Installed with stand

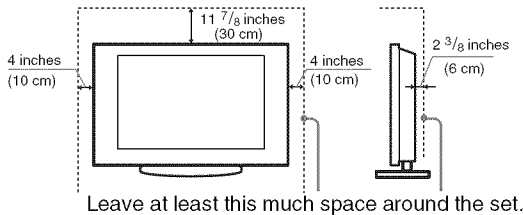

Installed on the wall

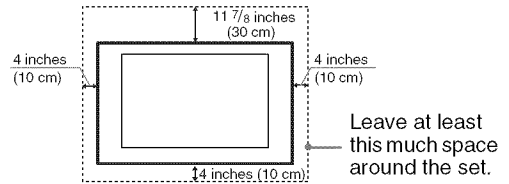

Never install the TV set as follows:

Air circulation is blocked.

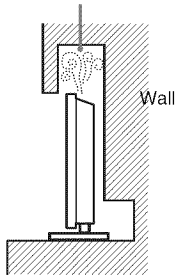

Air circulation is blocked.

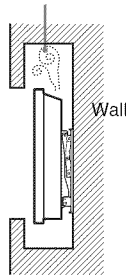

- Inadequate ventilation can lead to overheating of the TV and may cause TV damage or cause a fire.

Running Initial Setup

The **Initial Setup** screen appears when you turn on the TV for the first time.

- 1 Complete your cable connections before proceeding with the **Initial Setup** (refer to the Quick Setup Guide and the online Reference Book for additional information).
- 2 Use the following remote control buttons to navigate through the **Initial Setup**.

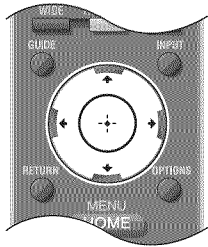
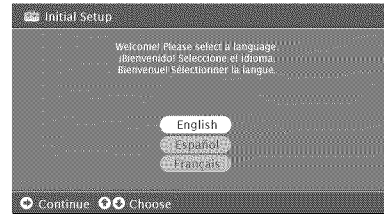

↑/↓ button:

Allows you to highlight options where applicable.

⊕ button:

Allows you to select the highlighted option.

← button:

Allows you to move back to the previous screen, where applicable.

→ button:

Allows you to move to the next screen, where applicable.

- 3 Select the language for the on-screen display (OSD) text.
- 4 Select your viewing environment. **Home** mode sets the TV display to settings optimized for home viewing (this setting is ENERGY STAR compliant). **Retail** mode changes the display settings to a default more appropriate for a store environment.
- 5 Select your country and enter your ZIP or Postal code.
- 6 Set the clock to the current date and time.
- 7 Select **Continue** to scan for available channels and enable the **TV Guide On Screen**[®] feature. If you receive channels from a cable box or satellite receiver and do not wish to use the TV's built-in tuner, select **Skip**. Selecting **Skip** will disable the **TV Guide On Screen** feature, which is only available when the TV's tuner is used.
- 8 To benefit from the network features included on this TV, connect to your existing home network (see page 13). Follow the instructions on the screen to complete **Network Setup**, or select **Skip** to complete it at a later time (optional). Refer to the online Reference Book for more details.

Initial Setup is complete. You can now begin watching your new TV.



- Enabling the TV Guide On Screen feature will increase the amount of time the TV is in Download Acquisition Mode (DAM); see page 38.
- For more information on **TV Guide On Screen**, see page 31.
- If the language that you selected in the **Language** setting is available from the broadcaster as an **Alternate Audio** language, your TV will automatically switch to the matching language with the **Alternate Audio** feature. To change the audio settings, access the **Alternate Audio** menu by pressing **OPTIONS** on the remote control when an alternate audio stream is available from the broadcaster. **Alternate Audio** is only available for digital programs (see the online Reference Book).
- To complete **Network Setup** at a later time, access the **XMB**[™] and select the **Network** icon on the **Settings** menu. Then select **Network Setup**.

Operating the TV

Using the Remote Control

Inserting Batteries into the Remote Control

Insert two size AA batteries (supplied) by matching \oplus and \ominus on the batteries to the diagram inside the battery compartment of the remote control.

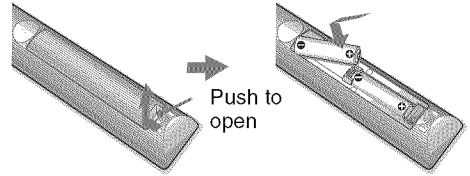

Guidelines for Remote Control

- Point your remote control directly at the IR sensor located on your TV.
- Make sure that no objects are blocking the path between the remote control and the IR sensor on your TV.
- Fluorescent lamps can interfere with your remote control; try turning off the fluorescent lamps.
- If you are having problems with the remote control, reinsert or replace your batteries and make sure that they are correctly inserted.

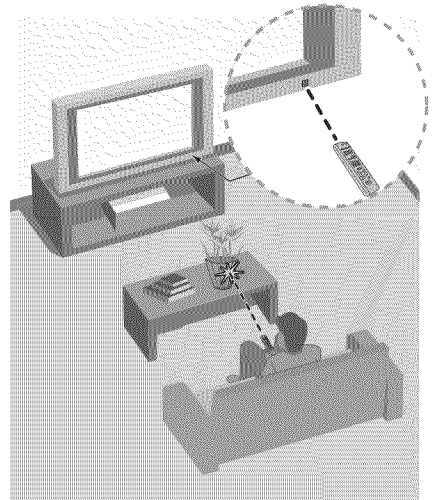

Remote Control Button Description



Button	Description
1 DISPLAY	Press once to display information about the channel/program/input you are viewing. The information will time out in a few seconds or press again to exit. You can change the display preference, press HOME and go to Preferences to set Info Banner to Small , Medium or Large .
2 CC	Press to turn Closed Captions (CC) on, off, or automatically display CC when sound is muted.
3 BRAVIA Sync	<p>These buttons are used to control the connected equipment with the Control for HDMI function (not available on all Control for HDMI equipment). Some other buttons on the remote control may also operate BRAVIA® Sync™ equipment.</p> <p>◀◀ (fast reverse): Press to play a program in fast rewind mode.</p> <p>▶ PLAY: Press to play a program at a normal speed.</p> <p> PAUSE: Press to pause playback.</p> <p>▶▶ (fast forward): Press to play a program in fast forward mode.</p> <p>SYNC MENU: Press once to display the Sync'd HDMI Devices (while a Control for HDMI device is not selected). Select the HDMI device and then press SYNC MENU to display the menu of connected equipment (not available on all Control for HDMI equipment).</p> <p>■ STOP: Press to stop playback.</p> <p>THEATER: Press to turn on and off the Theater Mode. The picture settings will be set for a cinema-like experience and the audio will be switched to the audio output of the attached speakers of your BRAVIA Sync audio system. Your BRAVIA Sync audio system must be connected by an HDMI connection to your TV (see page 35 for details).</p>



- The **5**, **PLAY** and **CH +** buttons have a tactile dot. Use them as a reference when operating the TV.

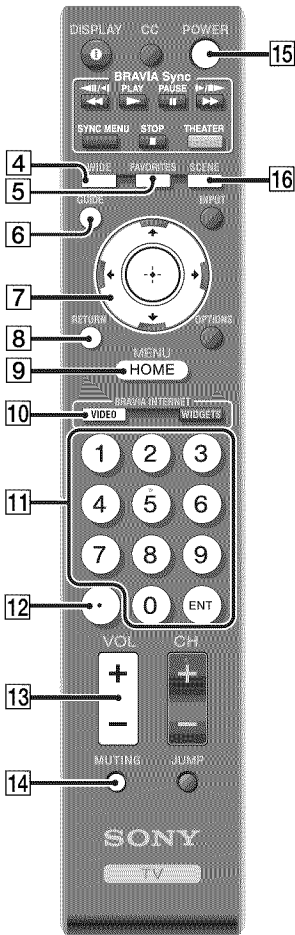

Button	Description
4 WIDE	Press repeatedly to cycle through the available Wide Mode settings (see page 34).
5 FAVORITES	Press to display Favorites menu. Press again to exit from the Favorites menu (see page 30).
6 GUIDE	Press to open the TV Guide On Screen . Press again to exit the Guide (see page 31).
7 ↑/↓/←/→ +	Press ↑/↓/←/→ to move focus/highlight. Press + to select/confirm an item.
8 RETURN	Press to go back to the previous screen or exit from the screen when displaying menu items and settings.
9 HOME	Press to display TV Home Menu/XMB™ to access TV Settings and other media and network related content (see page 22).
10 BRAVIA INTERNET VIDEO	Press to display the XMB™ with highlight on the most recently viewed Internet content provider (see page 25).
11 0-9 ENT	Press 0-9 to select a channel; the channel changes after two seconds. Press ENT to change channels immediately.
12 .	Use with 0-9 and ENT to select digital channels. For example, to enter 2.1, press 2 , . , 1 and ENT .
13 VOL +/-	Press to adjust the volume.
14 MUTING	Press to mute the sound. Press again or press VOL + to restore the sound.
15 POWER	Press to turn on and off the TV.
16 SCENE	Press to select the best picture and sound settings for the particular type of content you are viewing.

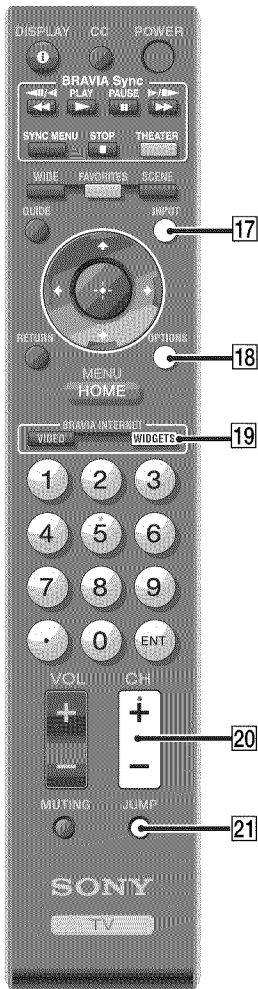

Button	Description
17 INPUT	Press to display the list of inputs. Press repeatedly to toggle through the inputs (see page 33).
18 OPTIONS	Press to display a list of convenient functions and menu shortcuts. The Options menu items vary based on current input and/or content.
19 BRAVIA INTERNET WIDGETS	Press to display the BRAVIA Internet Widgets. While the BRAVIA Internet Widgets are displayed on the screen, press again to remove the Widgets from the screen (see page 28).
20 CH +/-	Press to scan through channels. To scan quickly through channels, press and hold down either +/- .
21 JUMP	Press to jump back and forth between two channels or inputs. The TV alternates between the current channel or input and the last channel or input that was selected.



TV Controls and Indicators

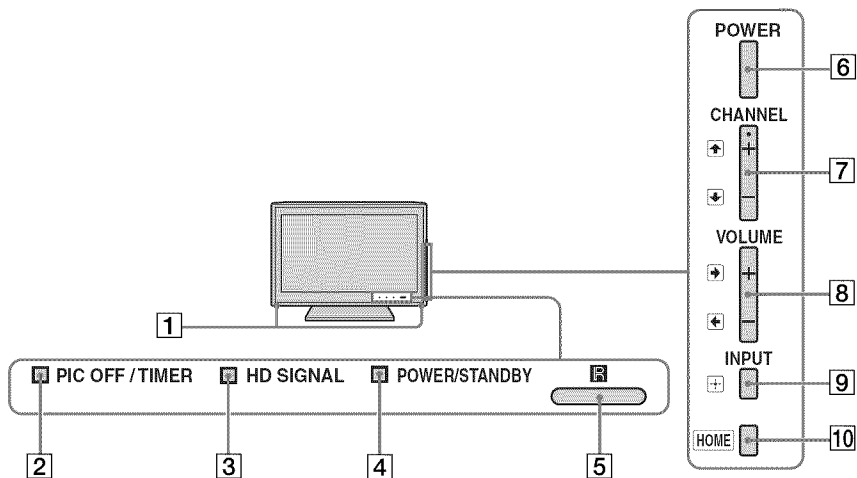

Item	Description
1 Speaker	Outputs audio signal.
2 PIC OFF/ TIMER	Lights up in orange when the Timer or Sleep Timer is set. Lights up and/or blinks in orange during a software upgrade. Lights up in green when the Power Saving is set to Picture Off .
3 HD SIGNAL	Lights up when the TV receives HD signal including up converted signals.
4 POWER/ STANDBY	Lights up in red when your TV is in PC power saving mode or during the software upgrade. Lights up in green when the TV is turned on. If the LED blinks in red continuously, this may indicate that the TV needs servicing (see contacting Sony information on the front cover).
5 (IR) Infrared Receiver	Receives IR signals from the remote control. Do not block this area, as it may interfere with remote control operation.
Light Sensor	Senses room light level and adjusts the screen brightness accordingly. Do not put anything near the sensor or the nearby general area (as shown above), as its function may be affected.
6 POWER	Press to turn on and off the TV.
7 - CHANNEL + ↓ ↑	Press to scan through channels. To scan quickly through channels, press and hold down either +/- . In the MENU screen, these buttons serve as up/down buttons.
8 - VOLUME + ← →	Press to adjust the volume. In the MENU screen, these buttons serve as left/right buttons.
9 INPUT	Press to display the list of inputs or confirm your selection. Press repeatedly to toggle through the inputs.  <ul style="list-style-type: none"> Inputs can be changed by pressing ↑/↓ and ⊕ while the list of external inputs is displayed. Refer to page 33 for information about setting up the external inputs labels. In the MENU screen, this button serves to confirm the selection or setting.
10 HOME	Press to display TV Home Menu/XMB™ to access TV Settings and other media and network related content.

Exploring the XMB™ and TV Features

Most TV functions are available from this menu screen called the **TV Home Menu/XMB™** (XrossMediaBar).

Press **HOME** to access the **TV Home Menu/XMB™**.

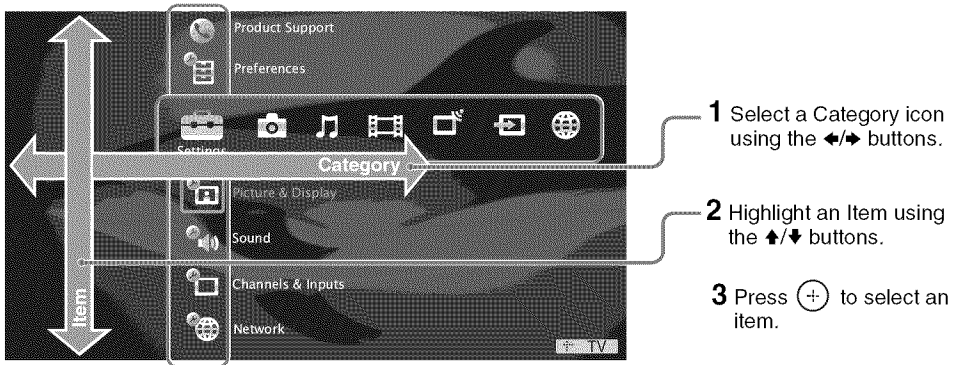

The **XMB™** displays help text that describes options available within an item.

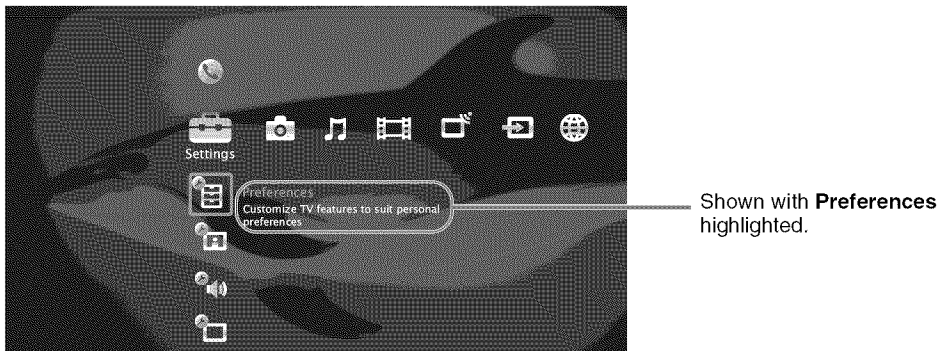

Category Icons

The Category icons organize your TV settings and TV features for quick and easy access. Press **▲/▼** to highlight an item within a Category icon and then press **(+)** to make a selection.



The **Settings** icon contains all of the necessary configurations to customize your TV settings.



Product Support for troubleshooting and TV software information and updates.



Preferences for customizing TV settings such as Timers, Parental Lock, Language, and much more.



Picture & Display for adjusting picture and display settings.



Sound for adjusting sound and speaker related settings.



Channels & Inputs for setting up TV channel list and external inputs.



Network for setting up Network related settings.



The **Photo**, **Music**, and **Video** icons organize your photo, music, and video files from Internet content providers, DLNA Certified media servers, and Sony USB



connected equipment. Be sure to select the correct icon when accessing files. Refer to the feature section for more information on these icons.



The **TV** icon provides you access to the TV channel list. You can select the **TV Guide On Screen**[®] icon located at the top of the channels list from this icon.



The **External Inputs** icon provides access to your connected equipment, see page 14.



The **Network** icon lists downloaded **BRAVIA** Internet Widgets. You can access the Widget Gallery from this icon. Refer to the feature section for more information on this icon.

Accessing Photo, Music, and Video Content

You can access a variety of Internet content by connecting to your existing home network with Internet connectivity. Your photo, music, and video files can also be accessed once you have set up a DLNA Certified equipment or after plugging in Sony USB equipment directly to your TV.

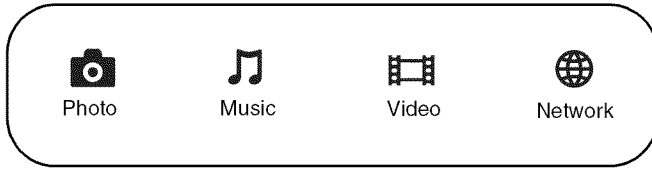

To display content under **Photo, Music, Video,** or **Network:**

- 1 Press **HOME** to display the **XMB™**.
- 2 Press **←/→** to highlight the **Photo, Music, Video,** or **Network** Category icon.
- 3 Press **▲/▼** to highlight an item and press **(+)** to select an item.

Shown here is the **XMB™** with the **Photo** icon highlighted.

Internet content provider, page 25

DLNA Certified media server, page 26

Sony USB, page 26

Sample Images, page 26

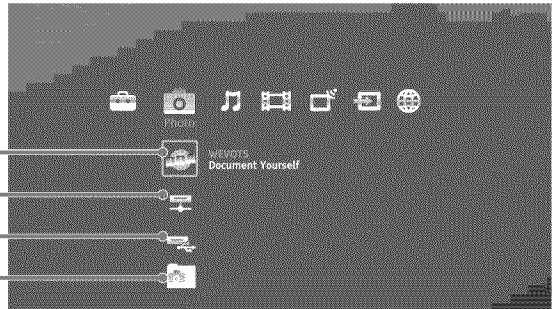

- The items displayed may vary for each category icon, your connected equipment, and the availability of Internet services.

BRAVIA Internet Video

BRAVIA Internet Video serves as a gateway delivering select Internet content and a variety of on-demand entertainment straight to your **BRAVIA** TV.

To connect to the **BRAVIA** Internet Video service, make sure that your TV is connected to your broadband home network and that you have completed the **Initial Setup** and **Network Setup** (see page 16).

The Internet content provider icons appear under the **Photo**, **Music**, **Video**, and **Network** icons on the **XMB™**. Highlight an icon and press **(+)** to open the Internet content provider's service.

Press **▲/▼/◀/▶** to navigate and **(+)** to make a selection.



The look and feel of Internet content providers may vary.

Seeking Forwards and Backwards

Some Internet content providers allow you to seek forward or seek backward. Press **▶** or **▶▶** to move forward in the video. Press **◀** or **◀◀** to move backward.

The **Control Panel** appears with a dot indicating the point at which the playback will resume. To resume playback, press **(+)** or **▶**. See the illustration below for details.

To change the speed of the seek, press the corresponding button up to three times.

Press the corresponding buttons to control playback.

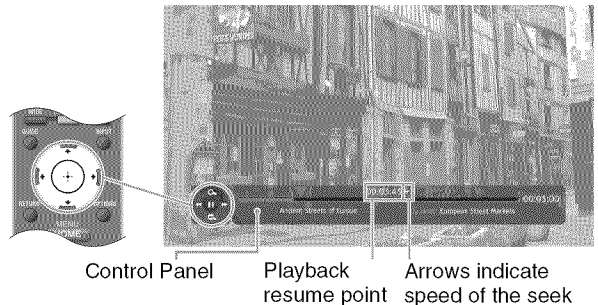

Saving to Favorites

You can save an Internet content provider to your **Favorites**; see “**Adding to Favorites**” on page 30.



- Some Internet content providers arrange videos by **Categories**; press **OPTIONS** to view more categories.
- Press **DISPLAY** to see more information on the highlighted video.
- The **Parental Lock** function set on the TV blocks video content based on the appropriate TV or Movie Rating. Refer to the online Reference Book.
- Recommended connection speed: Standard Definition video - 2.5 Mbps, High Definition video - 10 Mbps.
- To update the **BRAVIA** Internet Video content providers, select the **Network** icon from the **Settings** menu on the **XMB™**, then select **Refresh Internet Content**.

Photo, Music, and Video

Media files from DLNA Certified media servers or Sony USB equipment can easily be accessed from the **Photo**, **Music**, and **Video** Category icons. For a list of supported file formats, see page 38.

Accessing Media Files

- 1 Press **HOME** to display the **XMB™**.
- 2 Select a Category icon.
- 3 Select a DLNA Certified media server, Sony USB or sample folder. (Pressing **OPTIONS** will display additional menu items, see “Media File Options Menu” below.)
- 4 Press **+** to select an item from the List View.

Shown with **Photo** Category icon selected.

DLNA Certified
media server
USB
Samples

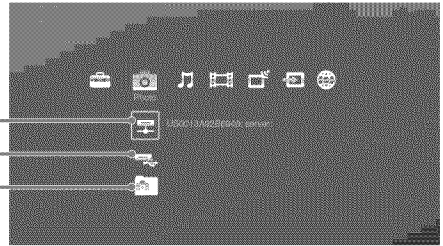

Shown with **Photo** USB media location selected.

List View

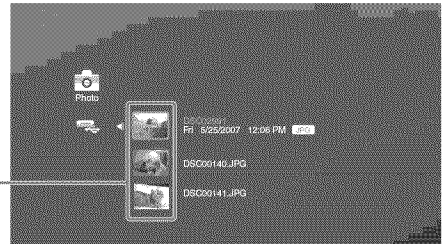

Shown here is a photo file after pressing **OPTIONS**.



Media File Options Menu

Press **OPTIONS** after accessing a media file to display a list of available options such as **Playback Method**, **Start Slideshow**, **Add to Favorites**, and **Device Actions**.

The Options Menu for each Category icon and media file selected may vary.



- Internet content may appear under each icon if the TV **Network Setup** has been completed (see page 16).
- Media files cannot be saved in the TV but can be added to **Favorites** and accessed when the equipment containing the media file is connected.
- Refer to page 13 for a sample DLNA Certified equipment or page 14 for Sony USB equipment connection diagrams.

Adding Music to a Slideshow

- 1 Highlight the **Photo** icon. Select from your DLNA Certified media servers, Sony USB connected equipment, or the sample folder.
- 2 Highlight the folder to display as a slideshow, press **OPTIONS** and then select **Playback Method**.
- 3 Select **Slideshow Music**, then select **Browse Music**.
- 4 Highlight and select an item from the list of available DLNA Certified media servers, Sony USB connected equipment, or sample folder.
- 5 Press **↓/↑** to highlight the music file or folder you would like to add to your slideshow and select **OK**.

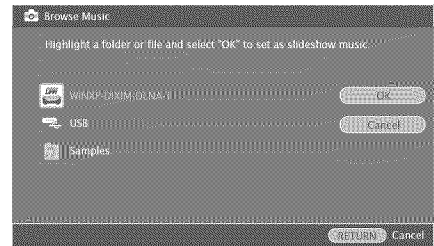
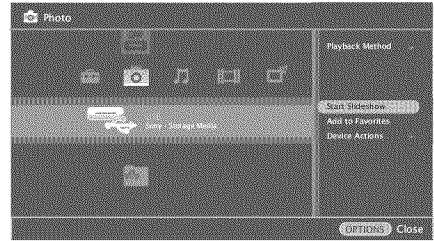

Playing Music or Video

When playing music or video files, press **⊕** to pause or play the file. Press and hold **◀** to move backward or press and hold **▶** to move forward.

Functionality of USB Equipment and DLNA Certified Media Servers

The USB functionality on this TV is compatible with most Sony brand digital cameras, MICRO VAULT USB Flash Drives, and DLNA Certified media servers but not all. Sony cannot guarantee or assure compatibility with all formats, products or in the following cases:

- Use of non-Sony brand USB equipment
- Use of video or audio clips processed on a computer
- Use of files obtained from the Internet or from printed film processing center.

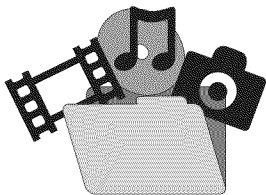

Prevent losing your files, be sure to back up all of your media files stored on USB equipment to prevent data corruption. Sony cannot accept responsibility for lost or damaged data stored on USB equipment.



- For more information on this feature, refer to the online Reference Book.

BRAVIA Internet Widgets

The **BRAVIA** Internet Widgets are small downloadable applications that provide you access to the latest in news, weather, stocks and interactive content when your TV is connected to the Internet.

Displaying Widgets

- 1 Press **WIDGETS**. Minimized Widgets called Snippets will appear.
- 2 Press **▲/▼/◀/▶** to highlight a Snippet then press **+** to launch it. The Snippet will expand into a Widget.

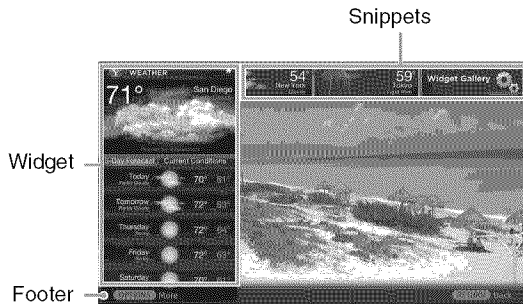
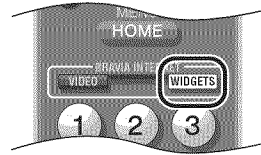

Minimizing a Widget

Press **RETURN** to minimize an expanded Widget into a Snippet or press **OPTIONS** and select **Minimize to Snippet**.

Hiding Widgets

Press **WIDGETS** or **RETURN** to hide all of the Widgets from the screen or press **OPTIONS** and select **Hide All**. To display the Widgets again, press **WIDGETS**.

Closing a Widget

Press **OPTIONS** then select **Close Widget**. When closing a Widget, all Snippets associated with the Widget will close. To relaunch the Widget, see “Launching Widgets” page 29.

Widget Gallery

Use the Widget Gallery to browse and install new Widgets. Downloaded Widgets can be launched from the **Network** Category icon of the **XMB™**, see “Launching Widgets” page 29.



- The Widget content that appears on the screen may be updated, modified or deleted at any time by the Widget provider.
- Some Widgets can be customized to your preferences such as viewing weather for your local region or viewing your preferred stocks.

Widgets Options Menu

Highlight a Widget or Snippet and press **OPTIONS** to access additional feature menu items. The menu items may vary depending on the state of the Widget/Snippet. A sample feature options menu is shown below.

Option	Description
Dock	Aligns Widgets/Snippets to the bottom of the TV screen.
Undock	Allows you to move Widgets/Snippets to any location on the TV screen.
Move	Allows you to move Widgets/Snippets to your preferred location.
Close Widget	Allows you to close a Widget and all associated Snippets.
Hide Widgets	Allows you to hide all Widgets/Snippets from the TV screen.
Hide/Show Footer	Hides or shows the footer. The footer may provide additional information and may appear for an extended period of time.

Moving Snippets on the Screen

Snippets can be moved when they are undocked.

- 1 Highlight a Snippet, press **OPTIONS** and then select **Move**.
- 2 Press **↑/↓/←/→** to move the Snippet and then press **+** to set it in your preferred location.

Snippets in Move Mode

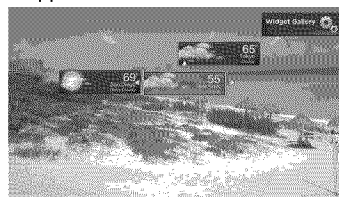

Launching Widgets

Hidden or closed Widgets can be launched from the **Network** Category icon of the **XMB™**.

- 1 Press **HOME**.
- 2 Highlight the **Network** Category icon.
- 3 Highlight a Widget and then press **+**.

Press **OPTIONS** while under the **Network** Category icon to access additional menu items.

Deleting Widgets

From the **Network** Category icon, highlight a Widget, press **OPTIONS** then select **Delete**.



- When downloading new Widgets, existing Widgets may need to be deleted from the **Network** Category icon if memory space has been exceeded.
- An expanded Widget cannot be moved using the remote control arrow buttons.
- Some Widgets may fill your entire TV screen when expanded into a full view.
- Widgets available on PCs or other devices may not be available on your TV.

Favorites

With **Favorites**, you can manage your preferred **TV** channels, **External Inputs**, **Photo**, **Music**, and **Video** content from a DLNA server or USB connected equipment, **Internet content**, **Widgets**, and **Background TV** themes for easy access.

Displaying Favorites

Press **FAVORITES**.

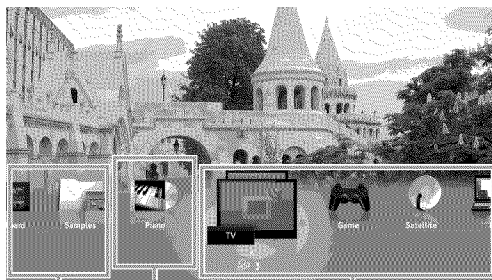

Saved Media Files/Folders

Recently Viewed
Items

Saved Inputs

Navigating Favorites

- 1 Press **←/→** to move between saved selections in a carousel-like fashion.
- 2 When the Recently Viewed list is highlighted, press **↑/↓** to move between the items.
- 3 To tune to an item, highlight its icon and press **(+)**.

Adding to Favorites

- 1 On the **XMB™**, highlight the icon of an item you wish to add and press **OPTIONS**.
- 2 Highlight **Add to Favorites** and press **(+)**.

Removing from Favorites

- 1 In the **Favorites** screen, highlight the item to remove and press **OPTIONS**.
- 2 Highlight **Remove from Favorites** and press **(+)**.



- To organize items saved to **Favorites** based on type (such as **TV** channels or **Photos**), press **OPTIONS** from the **Favorites** screen, select **Favorites View**, then choose **Stacked**.
- You can also add or remove an item while tuned to it, or while it is highlighted in **Favorites**. Press **OPTIONS** and select either **Add to Favorites** or **Remove from Favorites**.
- To clear your Recently Viewed items, highlight the list in **Favorites** and press **OPTIONS**, then select **Clear Recently Viewed**. Recently Viewed items are also cleared when the TV is powered off.
- **Auto Program** will clear your **TV** channels from **Favorites** (see page 16).
- **Initial Setup** will clear **Favorites** back to factory default.

TV Guide On Screen®

Use the Guide to find the program that you want to watch. The Guide allows you to organize and personalize the program listings.

The Guide is available with connection to your cable service or with over-the-air antenna signal. You must connect your signal directly to the TV's **CABLE/ANTENNA** input without using a cable box.

TV Guide On Screen System Elements

- Press **GUIDE** to display the **TV Guide On Screen**.

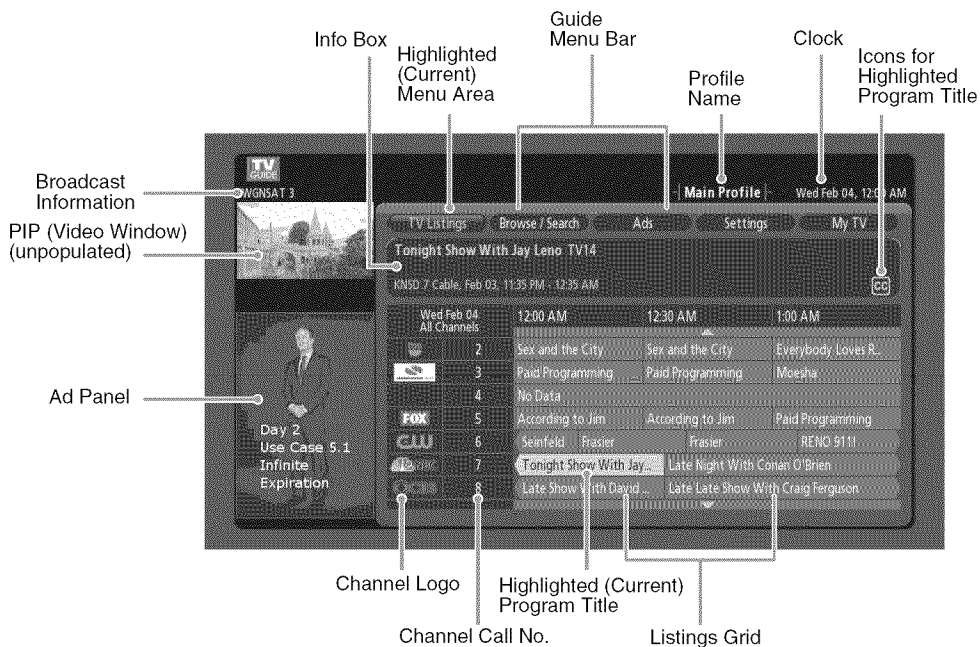

- Press **OPTIONS** to get back to the **Guide Menu Bar**. The **CH +/-** buttons can be used to page up/down through listings.

TV Listings

Up to 24 hours of program listings are available. You can also organize the program listings by categories, while TV Listings is highlighted on the Guide menu bar, press **(+)** to display a popup menu that allows you to customize the listings. For example, if you are an avid sports fan, you can customize the listings to only show sports-related channels.

Browse/Search

You can look for a program by browsing through categories or by entering a keyword or title.

Ads

Provides advertisements from TV Guide sponsors.

Settings

Under the Settings menu, you will find the Guide information and be able to set up Guide settings or profiles: **Guide Information Screen**, **Guide Settings**, **Profile Settings**, **Reset Guide**, **Edit Channels**, **Update TV Listings**, **Select Channel Lineup**.

My TV

The **My TV** feature allows you to organize the program listings by profiles such as **Movie**, **Sport**, or **Kids**. You can also create your own profile name and organize your favorite programs or channels.



When you add a favorite channel using the **OPTIONS** button while watching your program, your favorite channel will be added to the **Main Profile** under **My TV**. The channels you add to **My TV** will also automatically appear as your favorite channel in the TV's **Favorites**.

To disable the Guide feature, press **HOME** then select **Preferences** menu from the **Settings** on the **XMB™**. Look for **Program Information Source** then select the **Broadcaster** option.



- Enabling the **TV Guide On Screen** feature will increase the amount of time the TV is in Download Acquisition Mode (DAM); see page 38.
- Refer to the online Reference Book for details on how to customize the Guide or create personal profiles.

Background TV

Background TV uses the current video on your TV to create images that are similar to a screen saver.

Navigating Background TV

- 1 Tune to a channel or input.
- 2 Press **OPTIONS**.
- 3 Highlight **Background TV** and press (+).
- 4 Highlight a theme and press (+). The TV will display the current channel or input using the selected **Background TV** theme.

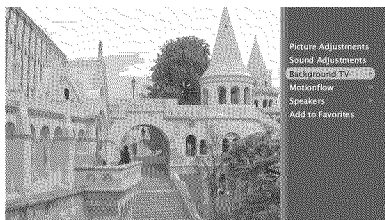

- 5 Press **RETURN** to exit the **Background TV** and return to the current channel or input.



- **Background TV** themes may also be saved to **Favorites**, so that you can launch these themes from the **Favorites** screen.

Inputs

Press **INPUT** to display the **Input** menu and toggle through the External Inputs to select the video source. The **Input** menu consists of TV mode and other equipment connected to the TV. You can label your External Inputs for easy identification by the connected equipment name rather than the name of the input.

How to Label an Input

- 1 From the **Settings** icon on the **XMB™**, select **Channels & Inputs**. Then, select **Manage Inputs**.
Press **▲/▼** to highlight the video input (Video/Component 1, Video 2, Component 2, HDMI 1-4) to which you want to assign a label, press (+) to select the input of your choice.
- 2 Press **▲/▼** to highlight one of the displayed labels corresponding to the equipment connected to that input then press (+) to label the equipment.
- 3 If you have an open input port where no equipment is connected, that input is grayed-out and skipped on the **Input** menu. You can **Enable** input ports so that they are always selectable. Refer to the online Reference Book for instructions.

Wide Mode

The **Wide Mode** feature allows you to select the screen display of your preference. Based on the original signal source, a black frame or black bars may surround the picture.

You can manually change the **Wide Mode** setting while watching TV by pressing the **WIDE** button on your remote control. For more information on customizing **Wide Mode** settings, refer to the online Reference Book.

Changing the Wide Screen Mode

Press **WIDE** repeatedly to cycle through the available modes.

4:3 Original source Standard-definition source	16:9 Original source High-definition source
↓	↓
Wide Zoom 	Wide Zoom
Normal 	Normal This mode is not available.
Full 	Full
H Stretch This mode is not available.	H Stretch
Zoom 	Zoom

- **Normal** is only available with 480i or 480p sources.
- **H Stretch** is only available with 720p, 1080i, 1080p and 1080/24p sources.

Changing the Wide Screen Mode for PC Timing

Wide Mode is also available while in the PC input mode. Press **WIDE** repeatedly to cycle through the available modes while in the PC input mode.

Incoming PC signal 800 × 600	Incoming PC signal 1,280 × 768
↓	↓
Normal 	Normal
Full 1 	Full 1
Full 2 	Full 2

BRAVIA® Sync™ with Control for HDMI

The **BRAVIA Sync** function allows this TV to communicate with other Sony equipment supporting the **Control for HDMI** function.

To connect Sony equipment with Control for HDMI

Use an HDMI cable that bears the HDMI logo for connection.

Line up the triangle on the head of the HDMI cable with the triangle on the label of the HDMI input when connecting the HDMI cable.

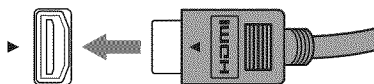

Setting the Control for HDMI

The **Control for HDMI** function must be set up in order for the TV to communicate with other **Control for HDMI** enabled equipment.

To setup the TV's **Control for HDMI**:

- 1** Select **Channels & Inputs** on the **Settings** menu.
- 2** Highlight **HDMI Settings** and press \oplus .
- 3** Select **Control for HDMI** and set it to **On**.

To verify connected devices, select **Device List** from the **HDMI Settings** menu.

For other equipment, refer to its operating instructions.

Available options using Control for HDMI

The following operations are available after you connect the supported Sony equipment with **Control for HDMI** function to your TV:

- Automatically turn off the connected equipment when you turn off the TV.
- The connected equipment and TV are turned on by One-Touch-Play.
- Possible operations with **BRAVIA Sync** buttons, see page 18.

When a Sony A/V receiver with **BRAVIA Sync** is connected, the following additional operations are possible:

- Turning on the A/V receiver when the TV is turned on.
- Automatically switching to the audio output of the A/V receiver's attached speakers.
- Adjusting the volume and muting of the A/V receiver with the TV's remote control.

Other Information

How to Care for Your BRAVIA

Safety is very important, please read and follow the safety documentation (Safety Booklet) separately provided.

Unplug the TV and other connected equipment from the wall outlet before you begin cleaning your TV.

- Wipe the LCD screen gently with a soft cloth.
- Stubborn stains may be removed with a cloth slightly moistened with a solution of mild soap and warm water.
- If using a chemically pretreated cloth, please follow the instruction provided on the package.
- Never use strong solvents such as a thinner, alcohol or benzene for cleaning.
- Do not plug in the TV into the wall outlet until the moisture from cleaning has evaporated.

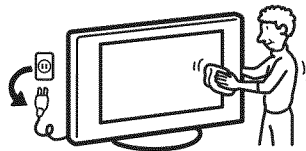

The TV should also be placed on a stable surface to prevent it from toppling over (see page 7). If you have young children or pets at home, check regularly to insure the TV is securely fastened.

Troubleshooting

Many problems with picture and sound quality are related to improper cable connection; refer to the Quick Setup Guide provided for sample connections.

Things to consider

- Check the Input selection by pressing **INPUT**. You may be watching the wrong input.
- You may have accidentally pressed the **MUTING** button on your remote control; press **MUTING** again or press **VOL +** to deactivate muting.
- The batteries may be installed incorrectly or may be low.
- An object or fluorescent light may be interfering with the remote control's operation.
- To reset the TV to factory default settings:
 - 1** Turn on the TV.
 - 2** While pressing **▲** on the Remote Control, press **POWER** on the TV. (The TV will turn itself off, then back on again.)

WARNING: The reset will clear all of your customized settings including the **Parental Lock** setting.

If you have forgotten your password, enter the master password: 4357. This password clears your previous password and allows you to enter a new password.

The online Reference Book (www.sony.com/referencebook) provides additional information on troubleshooting. Contact Sony if you need further assistance.

Declaration of Conformity

Trade Name: SONY
Model: KDL-40W5100/KDL-46W5100/
KDL-52W5100/KDL-65W5100/KDL-46W5150/
KDL-52W5150
Responsible Party: Sony Electronics Inc.
Address: 16530 Via Esprillo,
San Diego, CA 92127 U.S.A.
Telephone Number: 858-942-2230

This device complies with part 15 of the FCC rules. Operation is subject to the following two conditions:
(1) This device may not cause harmful interference, and
(2) this device must accept any interference received, including interference that may cause undesired operation.

For customers in Canada

This Class B digital apparatus complies with Canadian ICES-003.

FCC Related Information

This equipment has been tested and found to comply with the limits for a Class B digital device, pursuant to Part 15 of the FCC Rules. These limits are designed to provide reasonable protection against harmful interference in a residential installation. This equipment generates, uses and can radiate radio frequency energy and, if not installed and used in accordance with the instructions, may cause harmful interference to radio communications. However, there is no guarantee that interference will not occur in a particular installation. If this equipment does cause harmful interference to radio or television reception, which can be determined by turning the equipment off and on, the user is encouraged to try to correct the interference by one or more of the following measures:

- Reorient or relocate the receiving antenna.
- Increase the separation between the equipment and receiver.
- Connect the equipment into an outlet on a circuit different from that to which the receiver is connected.
- Consult the dealer or an experienced radio/TV technician for help.

Pursuant to FCC regulations, you are cautioned that any changes or modifications not expressly approved in this manual could void your authority to operate this equipment.

Note

This television includes a QAM demodulator which should allow you to receive unscrambled digital cable television programming via subscription service to a cable service provider. Availability of digital cable television programming in your area depends on the type of programming and signal provided by your cable service provider.

Compatible Wall-Mount Bracket and Speaker Bar Information

Use the following Sony Wall-Mount Bracket or Speaker Bar with your TV model.

Sony TV Model No.		
KDL-40W5100	KDL-46W5100/ KDL-46W5150	KDL-52W5100/ KDL-52W5150/ KDL-65W5100
Sony Wall-Mount Bracket Model No.	SU-WL500	
Sony Speaker Bar Model No.	HT-CT500	-

Use with other Wall-Mount Brackets or speaker bars may cause instability and could result in property damages or injury.

To Customers

Sufficient expertise is required for TV installations. Be sure to subcontract the installation to a Sony dealer or licensed contractor and pay adequate attention to safety during the installation.

For Customers in the United States

The lamp in this product contains mercury. Disposal of these materials may be regulated due to environmental considerations. For disposal or recycling information, please contact your local authorities or the Electronic Industries Alliance (www.eiae.org).

Specifications

Model	KDL-40W5100	KDL-46W5100/ KDL-46W5150	KDL-52W5100/ KDL-52W5150	KDL-65W5100
System				
Television system	NTSC: American TV standard ATSC (8VSB terrestrial): ATSC compliant 8VSB QAM on cable: ANSI/SCTE 07 2000 (Does not include CableCARD functionality)			
Channel coverage	Analog terrestrial: 2 - 69 / Digital terrestrial: 2 - 69 Analog Cable: 1 - 135 / Digital Cable: 1 - 135			
Panel system	LCD (Liquid Crystal Display) Panel			
Speaker output	10 W + 10 W			
Input/Output jacks				
CABLE/ANTENNA	75-ohm external terminal for RF inputs			
VIDEO IN 1/2	S VIDEO (4-pin mini DIN) (VIDEO 2 only): Y: 1.0 Vp-p, 75 ohms unbalanced, sync negative / C: 0.286 Vp-p (Burst signal), 75 ohms VIDEO: 1 Vp-p, 75 ohms unbalanced, sync negative AUDIO: 500 mVrms (Typical) / Impedance: 47 kilohms			
COMPONENT IN 1/2	YPBPR (Component Video): Y: 1.0 Vp-p, 75 ohms unbalanced, sync negative / PB: 0.7 Vp-p, 75 ohms / PR: 0.7 Vp-p, 75 ohms / Signal format: 480i, 480p, 720p, 1080i, 1080p AUDIO: 500 mVrms (Typical) / Impedance: 47 kilohms			
HDMI IN 1/2/3/4	HDMI: Video: 480i, 480p, 720p, 1080i, 1080p, 1080/24p Audio: Two channel linear PCM 32, 44.1 and 48 kHz, 16, 20 and 24 bits, Dolby Digital AUDIO (HDMI IN 1 only): 500 mVrms (Typical) / Impedance: 47 kilohms			
AUDIO OUT	500 mVrms (typical)			
DIGITAL AUDIO OUT (OPTICAL)	PCM/Dolby Digital optical signal			
PC IN	D-sub 15-pin, analog RGB, 0.7 Vp-p, 75 ohms, positive See the PC Input Signal Reference Chart on page 12.			
PC AUDIO INPUT	Stereo mini jack, 500 mVrms, (Typical) / Impedance: 47 kilohms			
USB	MPEG2, MP3, and JPEG.			
DLNA	MPEG2, LPCM, MP3, and JPEG.			
Power and others				
Power requirement	120-240 V AC, 50/60 Hz			
Power consumption				
in use	205 W	240 W	300 W	430 W
in DAM*	20 W	20 W	20 W	22 W
	(You may hear a clicking noise during the download but this is normal.)			
in standby	All models less than 0.1 W with 120 V AC and with 240 V AC less than 0.3 W			
Screen size (inches measured diagonally)	40	46	52	64.5 (65 class)
Display resolution	1,920 dots (horizontal) × 1,080 lines (vertical)			
Speaker/Full range (2) (mm) with speaker box (inches)	45 × 200 1 3/4 × 7 7/8			45 × 120 1 3/4 × 4 3/4
Tweeter (2) (mm) (inches)	16 5/8			
Dimensions with stand (mm) (inches)	958 × 649 × 303 37 3/4 × 25 5/8 × 12	1,091 × 725 × 330 43 × 28 5/8 × 13	1,240 × 821 × 358 48 7/8 × 32 3/8 × 14 1/8	1,549 × 1,014 × 423 61 × 40 × 16 3/4
without stand (mm) (inches)	958 × 596 × 86 37 3/4 × 23 1/2 × 3 1/2	1,091 × 672 × 86 43 × 26 1/2 × 3 1/2	1,240 × 767 × 86 48 7/8 × 30 1/4 × 3 1/2	1,549 × 960 × 115 61 × 37 7/8 × 4 5/8
wall-mount hole pattern (mm)	300 × 300			400 × 300
wall-mount screw size (mm)	M6 (length: refer to diagram on page 6.)			
Mass with stand (kg)/(lb.)	19.1/42.1	23.8/52.5	29.9/65.9	56.1/123.6
without stand (kg)/(lb.)	16.4/36.2	20.5/45.2	25.9/57.1	48.8/107.5
Supplied accessories	Remote control RM-YD027 (1) / Size AA batteries (2) / AC power cord (1) / Cable clumper (1 attached to the Table-Top Stand) / Operating Instructions (1) / Quick Setup Guide (1) / Warranty Card (1) / Safety and Regulatory Booklet (1) / Attaching the Table-Top Stand (1) / Screws (4) (Except KDL-52W5100, KDL-52W5150 and KDL-65W5100)			
Optional accessories	Connecting cables / Support Belt Kit / Wall-Mount Bracket / Speaker Bar: see page 37			

* Download Acquisition Mode (DAM) is used for software updates and/or collecting data for TV Guide On Screen.

⚠

- Optional accessories availability depends on its stock.
- Design and specifications are subject to change without notice.

Index

0-9 buttons 19

A

AC IN 9
AUDIO OUT jack, described 9
Auto Program 16

B

Background TV 33
BRAVIA INTERNET VIDEO button 19
BRAVIA INTERNET WIDGETS button 20
BRAVIA Sync buttons 18

C

CABLE/ANTENNA input, described 9
CC button 18
CH +/- button 20, 21
COMPONENT IN (1080p/1080i/720p/480p/480i) 9

D

DIGITAL AUDIO OUT (OPTICAL) 9
DISPLAY button 18
DLNA 13, 24
DMe[®]/SERVICE 9

E

ENT button 19

F

Favorites 30
FAVORITES button 19

G

GUIDE button 19

H

HD SIGNAL LED 21
HDMI IN 1/2/3/4 L-AUDIO-R 9
HOME button 19, 21

I

Infrared Receiver (IR) 21
INPUT button 20, 21

J

JUMP button 20

L

LAN 9
Light Sensor 21

M

MUTING button 19

O

OPTIONS button 20

P

PC IN 9
PIC OFF/TIMER LED 21
POWER button 19, 21
POWER/STANDBY LED 21

R

RETURN button 19

S

SCENE button 19
Speaker 21

T

Troubleshooting 36

U

USB 9

V

VIDEO IN 1/ COMPONENT IN 1 (1080p/1080i/720p/
480p/480i)/L-AUDIO-R 9
VIDEO IN 2 S VIDEO/VIDEO L (MONO)-AUDIO-R 9
VOL +/- button 19, 21

W

WIDE button 19

For Your Convenience

Online Reference Book:	To learn more about your TV, visit the online Reference Book at: http://www.sony.com/referencebook
Online Registration:	Be sure to register your TV. United States http://productregistration.sony.com Canada http://www.SonyStyle.ca/registration
Software Updates:	Your TV is capable of receiving software updates. For the latest information about software updates for your TV, visit: United States http://www.sony.com/tvsupport Canada http://www.sony.ca/support NOTE: If your TV is connected to the Internet, you can check for software updates by selecting Settings, Product Support and then Software Update .



FSC

Mixed Sources
Product group from well-managed
forests, controlled sources and
recycled wood or fiber

Cert no. SCS-COC-001395
www.fsc.org
© 1996 Forest Stewardship Council

<http://www.sony.net/>

Printed in U.S.A.

4-147-081-12(1)



4 1 4 7 0 8 1 1 2 1