

# FRIGIDAIRE

All about the

# Use & Care

of your Gas Range

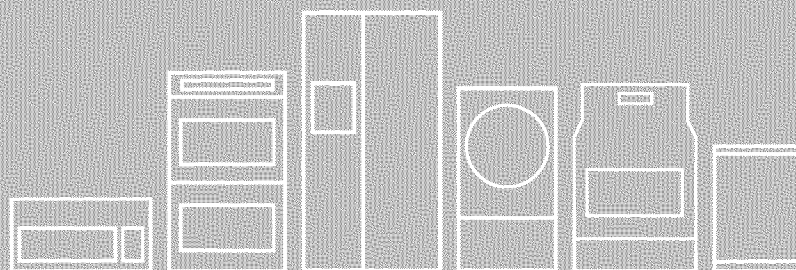

## TABLE OF CONTENTS

Important Safety Instructions .....	3-6	Setting Oven Controls .....	13-22
Features at a Glance .....	7	Setting Lower Oven .....	23-24
Before Setting Oven Controls .....	8-9	Self-Cleaning .....	25-26
Before Setting Surface Controls .....	10	Care & Cleaning (EC/DO) .....	27-30
Setting Surface Controls .....	11	Before You Call .....	31-32
Oven Control Functions (540L) .....	12	Major Appliance Warranty .....	35

# PRODUCT RECORD AND REGISTRATION

## Contents

Product Registration .....	2
<b>Important Safety Instructions .....</b>	<b>3-6</b>
<b>Features at a Glance .....</b>	<b>7</b>
<b>Before Setting Oven Controls .....</b>	<b>8-9</b>
Removing, replacing & arranging the oven racks .....	8
Effortless™ Oven Rack system and assembly .....	9
<b>Before Setting Surface Controls .....</b>	<b>10</b>
Cookware material types .....	10
<b>Setting Surface Controls .....</b>	<b>11</b>
Setting a surface burner .....	11
Seasoning, using and caring for the griddle .....	11
Home canning .....	11
<b>Oven Controls Functions .....</b>	<b>12</b>
<b>Setting Oven Controls .....</b>	<b>13-22</b>
Setting the clock .....	13
Changing between continuous bake or 6-Hour	
Energy Saving features .....	13
Setting 12 or 24 hour display modes .....	13
Changing oven temperature display (F° or C°) .....	13
Setting a silent control panel .....	14
Setting oven lockout .....	14
Setting minute timer .....	14
Add a minute feature .....	14
Setting quick preheat .....	15
Setting bake .....	15
Setting bake time .....	15
Setting delayed timed bake .....	16
Setting quick bake .....	17
Setting broil .....	18
Setting pizza feature .....	19
Setting chicken nuggets feature .....	19
Setting keep warm .....	19
Adjusting oven temperature .....	20
Operating oven light .....	20
Setting the Sabbath mode feature .....	21-22
<b>Setting Lower Oven Drawer .....</b>	<b>23-24</b>
<b>Self-Cleaning .....</b>	<b>25-26</b>
<b>Care &amp; Cleaning .....</b>	<b>27-30</b>
Cleaning recommendations table .....	27
Cleaning the lower oven .....	28
Replacing the lower oven light .....	28
Cleaning the cooktop and surface burners .....	29
Replacing the oven light .....	29
Removing & replacing oven door .....	30
<b>Before You Call - Solutions to common problems...</b>	<b>31-32</b>
<b>Appliance Warranty .....</b>	<b>35</b>

Thank you for choosing **Frigidaire**.

This Use & Care Guide is part of our commitment to customer satisfaction and product quality throughout the service life of your new appliance. We view your purchase as the beginning of a relationship. To ensure our ability to continue serving you, please use this page to record important product information.

## Need help??

**Visit the Frigidaire web site at [www.frigidaire.com](http://www.frigidaire.com)**

Before you call for service, there are a few things you can do to help us serve you better.

## Read this Use & Care manual.

It contains instructions to help you use and maintain your range properly.

## If you received a damaged range ...

immediately contact the dealer (or builder) that sold you the range.

## Save time and money.

Check the section titled "Before you call". This section helps step you through some common problems that might occur. If you do need service, help is only a phone call away. A list of toll-free customer service numbers are included in the back of this manual. Or call Frigidaire Customer Services at **1-800-944-9044**, 24 hours a day, 7 days a week.

## Product Registration

Registering your product with Frigidaire enhances our ability to serve you. You can register online at **[www.frigidaire.com](http://www.frigidaire.com)** or by dropping your Product Registration Card in the mail.

## Serial plate location

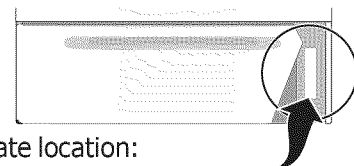

Serial plate location:  
lower oven drawer (some models) or  
storage drawer (some models).

## Record model & serial numbers here

\_\_\_\_\_  
Purchase date

\_\_\_\_\_  
Model number

\_\_\_\_\_  
Serial number

## IMPORTANT SAFETY INSTRUCTIONS

### Read all instructions before using this appliance.

Do not attempt to install or operate your appliance until you have read the safety precautions in this manual. Safety items throughout this manual are labeled with a WARNING or CAUTION statement based on the risk type.

#### Definitions

**!** This is the safety alert symbol. It is used to alert you to potential personal injury hazards. Obey all safety messages that follow this symbol to avoid possible injury or death.

#### **!** WARNING

**WARNING** indicates a potentially hazardous situation which, if not avoided, may result in death or serious injury.

#### **!** CAUTION

**CAUTION** indicates a potentially hazardous situation which, if not avoided, may result in minor or moderate injury.

#### **➔** IMPORTANT

**IMPORTANT** indicates installation, operation, maintenance or valuable information that is not hazard related.

### Important Safety Instructions

- **Remove all tape and packaging before using the range.** Destroy the carton and plastic bags after unpacking the range. Never allow children to play with packaging material.
- **Proper Installation—Be sure your appliance is properly installed and grounded by a qualified technician in accordance with the National Fuel Gas Code ANSI Z223.- latest edition, or in Canada CAN/CGA B149.1, and CAN/CGA B149.2, and the the National Electrical Code ANSI/NFPA No.70-latest edition, or in Canada CSA Standard C22.1, Canadian Electrical Code, Part 1, and local code requirements.** Install only per installation instructions provided in the literature package for this range. Ask your dealer to recommend a qualified technician and an authorized repair service. Know how to disconnect the power to the range at the circuit breaker or fuse box in case of an emergency.

#### **!** WARNING

**If the information in this manual is not followed exactly, a fire or explosion may result causing property damage, personal injury or death.**

#### **FOR YOUR SAFETY:**

- **Do not store or use gasoline or other flammable vapors and liquids in the vicinity of this or any other appliance.**
- **WHAT TO DO IF YOU SMELL GAS:**
  - **Do not try to light any appliance.**
  - **Do not touch any electrical switch; do not use any phone in your building.**
  - **Immediately call your gas supplier from a neighbor's phone. Follow the gas supplier's instructions.**
  - **If you cannot reach your gas supplier, call the fire department.**
- **Installation and service must be performed by a qualified installer, servicer or the gas supplier.**

#### **!** WARNING

- **All ranges can tip.**
- **Injury to persons could result.**
- **Install anti-tip device packed with range.**
- **See Installation Instructions.**



To reduce the risk of tipping, the range must be secured by properly installed anti-tip bracket provided with the range. To check if the bracket is installed properly, visually check that rear leveling leg is inserted into and fully secured by the anti-tip bracket by removing lower front panel or storage drawer from the range.



For models equipped with a warmer drawer or lower oven, grasp the top rear edge of the range and carefully attempt to tilt it forward. Refer to the installation instructions for proper anti-tip bracket installation.

- **Never modify or alter the construction of a range by removing the leveling legs, panels, wire covers, anti-tip brackets/screws, or any other part of the range.**

**Save these instructions for future reference.**

## IMPORTANT SAFETY INSTRUCTIONS

### WARNING

**NEVER** use this appliance as a space heater to heat or warm the room. Doing so may result in carbon monoxide poisoning.

**NEVER** cover any slots, holes or passages in the oven bottom or cover an entire rack with materials such as aluminum foil. Doing so blocks air flow through the oven and may cause carbon monoxide poisoning. Aluminum foil linings may trap heat, causing a fire hazard.

**Stepping, leaning or sitting on the door or drawers of a range can result in serious injuries and also cause damage to the appliance.** DO NOT allow children to climb or play around the range. The weight of a child on an open oven door may cause the range to tip, resulting in serious burns or other injury.

**Storage in or on appliance—flammable materials should not be stored in an oven, near surface units or in the storage drawer, warmer drawer or lower oven.** This includes paper, plastic and cloth items, such as cookbooks, plasticware and towels, as well as flammable liquids. Do not store explosives, such as aerosol cans, on or near the range.

**DO NOT LEAVE CHILDREN ALONE—children should not be left alone or unattended in the area where appliance is in use.** They should never be allowed to sit or stand on any part of the appliance, including the storage drawer, lower broiler drawer, warmer drawer or lower double oven.

### CAUTION

**Do not store items of interest to children in the cabinets above a range or on the backguard of the range.** Children climbing on the range to reach items could be seriously injured.

- **Remove the oven door from any unused range if it is to be stored or discarded.**
- **User servicing—Do not repair or replace any part of the appliance unless specifically recommended in the manuals.** All other servicing should be done only by a qualified technician. This may reduce the risk of personal injury and damage to the range.

### IMPORTANT

**For electric ignition models only: Do not attempt to operate the range during a power failure.** If the power fails, always turn off the range. If the range is not turned off and the power resumes, the range will begin to operate again. Once the power resumes, reset the clock and oven function.

### CAUTION

- **DO NOT TOUCH SURFACE BURNERS, AREAS NEAR THESE BURNERS, OVEN BURNERS OR INTERIOR SURFACES OF THE OVEN.** Both surface and oven burners may be hot even though flames are not visible. Areas near surface burners may become hot enough to cause burns. During and after use, do not touch, or let clothing or other flammable materials touch these areas until they have had sufficient time to cool. Among these areas are the cook top, surfaces facing the cook top, the oven vent openings and surfaces near these openings, oven door and window.
- **Wear proper apparel—loose-fitting or hanging garments should never be worn while using the appliance.** Do not let clothing or other flammable materials contact hot surfaces.
- **Do not use water or flour on grease fires—smother the fire with a pan lid, or use baking soda, a dry chemical or foam-type extinguisher.**
- **When heating fat or grease, watch it closely.** Fat or grease may catch fire if allowed to become too hot.
- **Use dry potholders - moist or damp potholders on hot surfaces may result in burns from steam.** Do not let potholders touch hot heating elements. Do not use a towel or other bulky cloth instead of a potholder.
- **Do not heat unopened food containers - buildup of pressure may cause container to burst and result in injury.**



## IMPORTANT SAFETY INSTRUCTIONS

### IMPORTANT INSTRUCTIONS FOR USING YOUR COOKTOP

#### **WARNING**

**Use Proper Flame Size**—Adjust flame size so it does not extend beyond the edge of the utensil. The use of undersized utensils will expose a portion of the burner flame to direct contact and may result in ignition of clothing. Proper relationship of utensil to flame will also improve efficiency.

- **Know which knob controls each surface burner.** Place a pan of food on the burner before turning it on, and turn the burner off before removing the pan.
- **Always turn knob to the full LITE position when igniting top burners.** Visually check that burner has lit. Then adjust the flame so it does not extend beyond the edge of the utensil.
- **Utensil handles should be turned inward and not extend over adjacent surface burners**—To reduce the risk of burns, ignition of flammable materials, and spillage due to unintentional contact with the utensil, the handle of the utensil should be positioned so that it is turned inward, and does not extend over adjacent surface burners.
- **Never leave surface burners unattended at high heat settings**—Boilovers cause smoking and greasy spillovers that may ignite, or a pan that has boiled dry may melt.
- **Glazed cooking utensils**—Only certain types of glass, glass/ceramic, ceramic, earthenware, or other glazed utensils are suitable for cook top service without breaking due to the sudden change in temperature. Check the manufacturer's recommendations for cook top use.
- **When flaming foods under a ventilating hood, turn the fan on.**
- **Air curtain or other overhead range hoods**, which operate by blowing a downward air flow on to a range, shall not be used in conjunction with gas ranges other than when the hood and range have been designed, tested and listed by an independent test laboratory for use in combination with each other.

### IMPORTANT INSTRUCTIONS FOR USING YOUR OVEN

- **Use care when opening oven door , warmer drawer or lower oven door**—Stand to the side of the range when opening the door of a hot oven. Let hot air or steam escape before you remove or replace food in the oven.
- **Keep Oven Vent Ducts Unobstructed.** The oven vent is located below the backguard. Touching the surfaces in this area when the oven is operating may cause severe burns. Also, do not place plastic or heat-sensitive items on or near the oven vent. These items could melt or ignite.
- **Placement of Oven Racks.** Always place oven racks in desired location while oven is cool. If rack must be moved while oven is hot use extreme caution. Use potholders and grasp the rack with both hands to reposition. Do not let potholders contact the hot heating elements in the oven. Remove all utensils from the rack before moving.
- **Do not use the broiler pan without its insert.** The broiler pan and its insert allow dripping fat to drain and be kept away from the high heat of the broiler.
- **Do not cover the broiler insert with aluminum foil. Exposed fat and grease could ignite.**
- **Protective liners**—Do not use aluminum foil to line the oven bottom. Only use aluminum foil as recommended in this manual. Improper installation of these liners may result in risk of electric shock, or fire.

### IMPORTANT SAFETY NOTICE

The California Safe Drinking Water and Toxic Enforcement Act requires the Governor of California to publish a list of substances known to the state to cause cancer, birth defects or other reproductive harm, and requires businesses to warn customers of potential exposure to such substances.

## IMPORTANT SAFETY INSTRUCTIONS

### SELF-CLEANING OVENS

- **Clean in the self-cleaning cycle only the parts listed in this Use & Care Manual.** Before self-cleaning the oven, remove the broiler pan and any utensils or foods from the oven.
- **Do Not Use Oven Cleaners**—No commercial oven cleaner or oven liner protective coating of any kind should be used in or around any part of the oven.
- **Do Not Clean Door Gasket**—The door gasket is essential for a good seal. Care should be taken not to rub, damage or move the gasket.
- The health of some birds is extremely sensitive to the fumes given off during the self-cleaning cycle of any range. Move birds to another well-ventilated room.

### IMPORTANT INSTRUCTIONS FOR CLEANING YOUR RANGE

- **Clean the range regularly to keep all parts free of grease that could catch fire.** Pay particular attention to the area around each surface element. Do not allow grease to accumulate.
- **Kitchen cleaners and aerosols**—Always follow the manufacturer's recommended directions for use. Be aware that excess residue from cleaners and aerosols may ignite causing damage and injury.
- **Clean ventilating hoods frequently**—Grease should not be allowed to accumulate on the hood or filter. Follow the manufacturer's instructions for cleaning hoods.

### Grounding Instructions

Grounding type wall receptacle

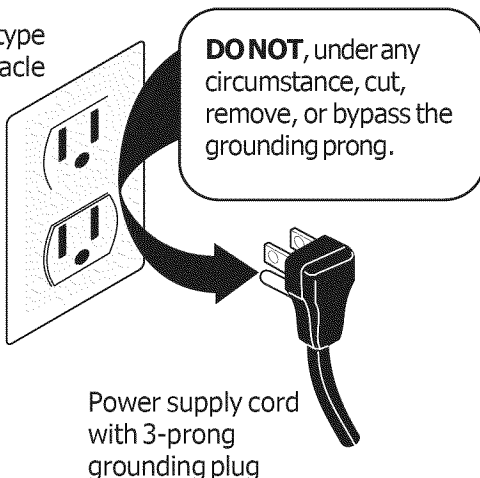

### WARNING

Avoid fire hazard or electrical shock. Do not use an adapter plug, an extension cord, or remove grounding prong from electrical power cord. Failure to follow this warning can cause serious injury, fire or death.

This appliance is equipped with a 3-prong grounding plug for your protection against shock hazard and should be plugged directly into a properly grounded receptacle. **DO NOT** cut or remove the grounding prong from this plug.

For personal safety, the range must be properly grounded. For maximum safety, the power cord must be plugged into an electrical outlet that is correctly polarized and properly grounded.

If a 2-prong wall receptacle is the only available outlet, it is the personal responsibility of the consumer to have it replaced with a properly grounded 3-prong wall receptacle installed by a qualified electrician.

See the **INSTALLATION INSTRUCTIONS** packaged with this range for complete installation and grounding instructions.

### Conversion to Liquefied Petroleum Gas

Your appliance was factory pre-set to operate on **Natural Gas ONLY**. Do not attempt to convert to this appliance to Liquefied Petroleum Gas (L.P.).

### WARNING

Personal injury or death from electrical shock may occur if the range is not installed by a qualified installer or electrician.

Any additions, changes or conversions required in order for this appliance to satisfactorily meet the application needs must be made by a qualified technician.

## FEATURES AT A GLANCE

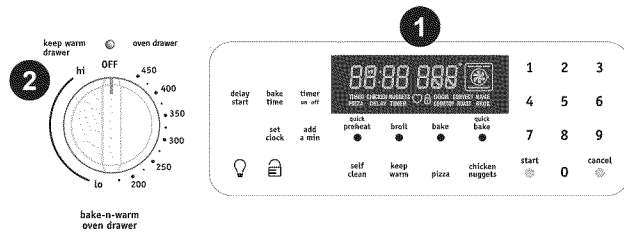

### Your gas range features include:

1. Electronic oven control with kitchen timer.
2. Bake-n-Warm™ lower oven cooking control & indicator light.
3. Left front burner valve and control knob.
4. Left rear burner valve and control knob.
5. Center accent burner valve and control knob (some models).
6. Right front burner valve and control knob.
7. Right rear burner valve and control knob.
8. Burner grates (colors vary with model).
9. Center burner grate (some models).
10. Oven interior light with removable cover.
11. Automatic oven door light switch (some models).
12. Self-cleaning oven interior.
13. Self-clean door latch.
14. Adjustable interior oven rack(s). Effortless Oven Rack™ system (not shown-some models).
15. Quick bake (convection) fan (some models).
16. Large 1-piece oven door handle.
17. Full width oven door with window.
18. Bake-n-Warm™ lower oven and drawer handle.
19. Easy to clean upswept cooktop.
20. 5,000 BTU simmer burner (some models).
21. 9,000 BTU standard burner (some models).
22. 9,000 BTU center or accent burner (some models).
23. 12,000 BTU Quick Boil burner (some models).
24. 14,000 or 17,000 BTU Quick Boil burner (some models).
25. Burner drip pan (not shown-some models).
26. Broil pan (some models).
27. Broil pan insert (some models).
28. Bake-n-Warm™ lower oven rack.
29. Cast-iron griddle grate (in place of middle grate; optional-some models).
30. Leveling legs and **anti-tip** bracket (included).

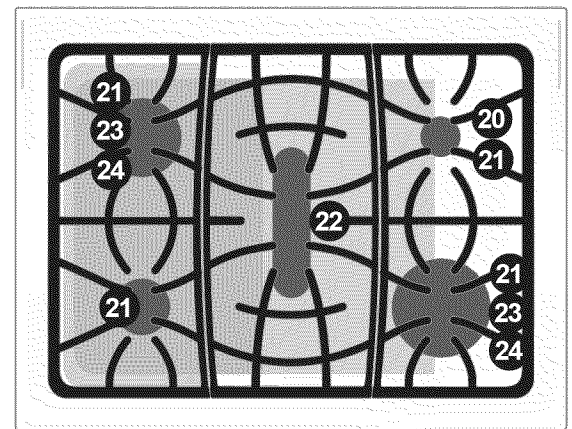
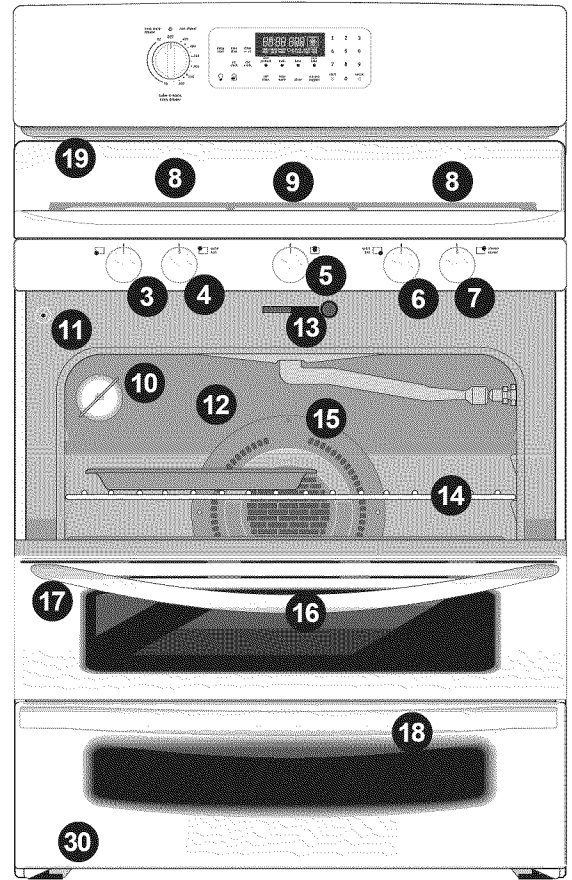
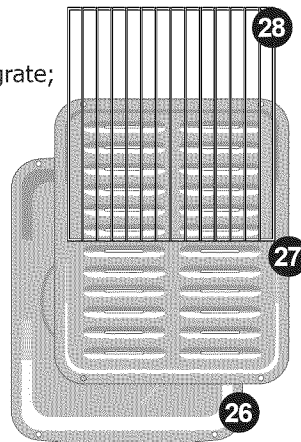
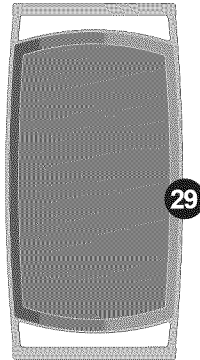

Note: The features shown for your appliance may vary according to model type & color.

Be sure to visit us online at  
[www.frigidaire.com](http://www.frigidaire.com)  
 for a complete line of accessories.

## BEFORE SETTING OVEN CONTROLS

### Oven vent location

The oven vent is located **below the control panel** (See Fig. 1). When the oven is on, warm air passes through this vent. This venting is necessary for proper air circulation in the oven and good baking results. **Do not block the oven vent.**

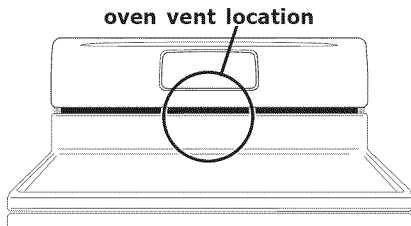

Fig. 1

### Removing, replacing & arranging racks

**To remove** - pull the rack forward until it stops. Lift up front of rack and slide out.

**To replace** - fit the rack onto the guides on the oven walls. Tilt the front of the rack upward and slide the rack back into place.

**Arranging** - always arrange the oven racks when the oven is cool (prior to operating the oven).

### CAUTION

**Always use oven mitts when using the oven.** When using the appliance, oven racks and cooktop will become very hot which can cause burns.

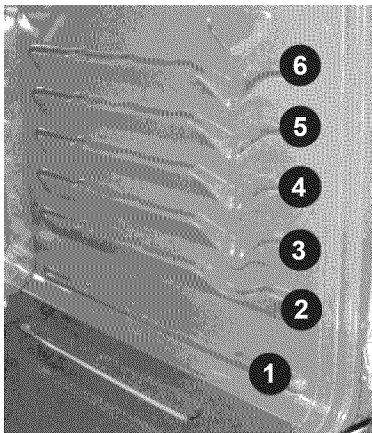
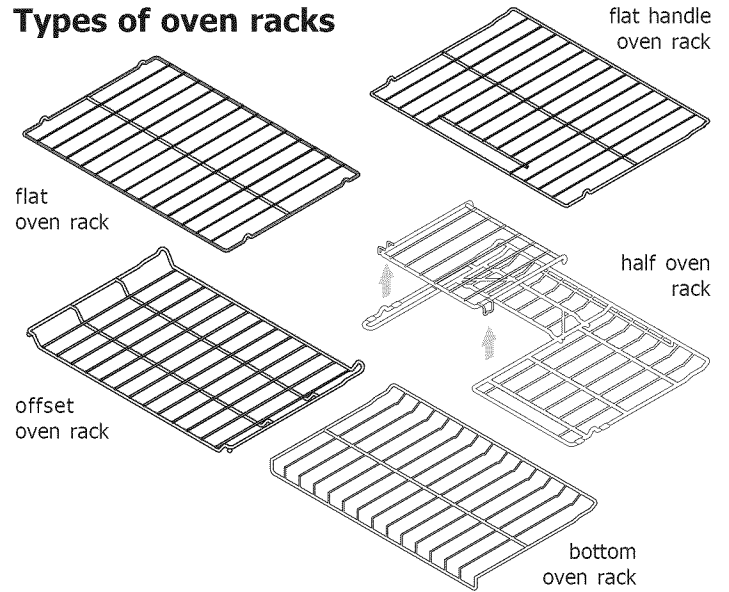

Fig. 2

### Recommended rack positions by food type

Food type	Position
Broiling meats	See broil
Cookies, cakes, pies, biscuits & muffins	3 or 4
Frozen pies, angel food cake, yeast, bread and casseroles	1 or 2
Small cuts of meat or poultry	1 or 2
Turkey, roast or ham	1

### Types of oven racks



The **flat oven rack** or **flat handle oven rack** (some models) may be used for most cooking needs. The **half rack** (some models) design comes with a removable section that allows for taller cooking utensils. The **offset oven rack** (some models) is designed to place the base of the rack about 1/2 of a rack position lower than normal. This rack design provides several additional possible positions between the standard positions. To maximize oven cooking space place the **bottom oven rack** (some models) in the lowest rack position for baking or roasting large cuts of meat. The **Effortless™ Oven Rack** (some models) is described later in this section.

### Air circulation in the oven

For best baking results allow 2-4" (5-10 cm) around the cookware for proper air circulation and be sure pans and cookware do not touch each other, the oven door, sides or back of the oven cavity. Hot air must be able to circulate around the pans and cookware in the oven for even heat to reach around the food.

### Baking layer cakes with 1 or 2 oven racks

For best results when baking cakes using 2 oven racks, place cookware on rack positions 2 & 5 (See Figs. 2 & 3). For best results when using a single oven flat rack, place cookware on rack positions 2, 3 or 4 (See Figs. 2 & 4).

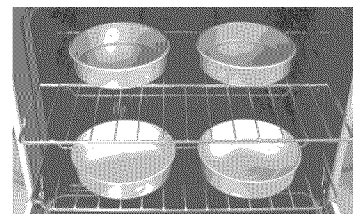

Fig. 3

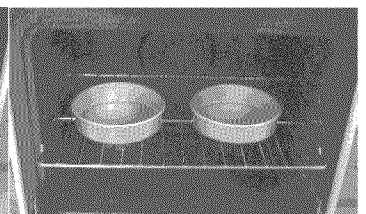

Fig. 4

## BEFORE SETTING OVEN CONTROLS

### Effortless™ Oven Rack system

Some models are equipped with a special oven rack system that automatically partially extends the oven rack from the interior oven glides to assist in easier access to your food items. This feature works whenever the oven door is opened or closed.

#### To assemble the Effortless™ Oven Rack system:

1. Locate all required parts. You will need the supplied oven rack (Effortless™ Oven Rack is a flat rack with a special **dark coating** on the **left and right rack sides**) and the 2 supplied chrome connector arms.
2. Open the oven door. Be sure the oven is completely cool before proceeding.
3. Place the oven rack in positions **2, 3 or 4 only** (see previous page to verify positions). Be sure the rack connector brackets are at the rear of the range and pointing towards oven bottom (See Fig. 2).
4. Assemble one connector arm at a time. With the oven door open and the oven rack in place, install one end of the connector arm to the hole in the **door connector bracket** (Fig. 1) and the other end in the hole in the **rack connector bracket** (Fig. 2 and as in Fig. 3). The oven rack may need to be adjusted in or out in the rack position to match the length of the connector arm.
5. While holding the connector arm in place, twist the connector arm so the ends of the connector arm point **upwards** (See Figs. 4 & 5). The connector arm should now be locked into position.
6. Repeat steps 4 and 5 for the other connector arm.
7. Once both connector arms are properly in place, be sure to test the oven rack operation by gently closing the oven door. The oven rack should move in and out of the oven freely when the door is opened or closed.

### CAUTION

**REMOVE ALL OVEN RACKS and accessories before starting a self-clean cycle.** If the oven racks are left in the oven during the self-clean cycle, the glide ability of the Effortless™ Oven Rack system will be damaged and will cause oven racks to lose their shiny finish and or turn blue. Remove **ALL** oven racks and clean according to instructions provided in the Care & Cleaning section of this manual.

Make sure the oven and oven racks are **COMPLETELY** cool and safe to touch before attempting to assemble or disassemble the Effortless™ Oven Rack system. **Never pick up hot oven rack parts.**

### IMPORTANT

**Only the Effortless™ Oven Rack system should be used in oven rack position 2.** Placing ANY other rack in oven rack position 2 **will prevent the oven door from fully closing** and may damage the oven door, oven cavity or the door connector brackets.

If the rack system is not assembled with the connector arms the Effortless™ Oven rack may be used in oven rack positions 2 thru 6. Do not attempt to use the Effortless™ Oven rack in rack position 1.

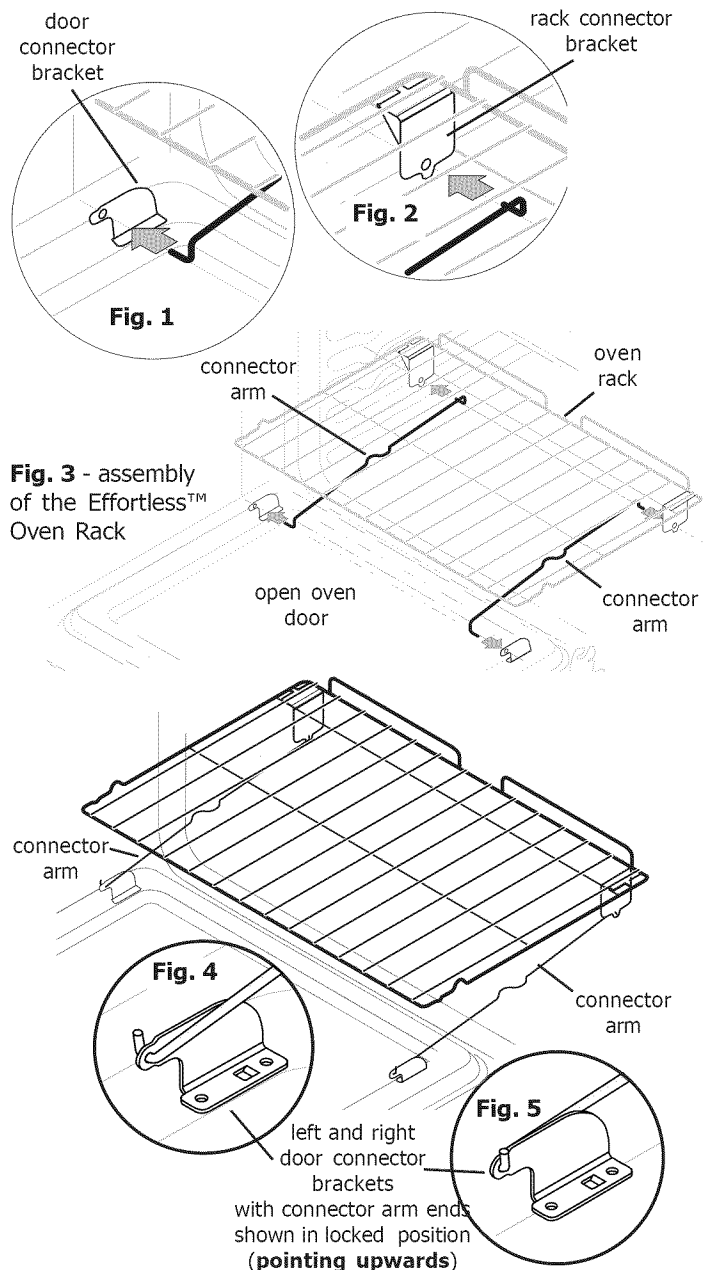

Fig. 6 - Effortless™ Oven Rack after assembly



## BEFORE SETTING SURFACE CONTROLS

### Using proper cookware

For best cooking results, cookware should have flat bottoms that rests level on the burner grate. Before using cookware, check for flatness by rotating a ruler across the bottom of the cookware (Fig. 1).

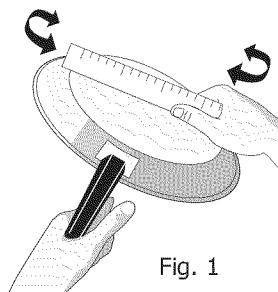

Fig. 1

### CAUTION

**Do not place flammable items** such as plastic salt and pepper shakers, spoon holders or plastic wrappings on the cooktop when it is in use. These items could melt or ignite. Potholders, towels or wooden spoons could catch fire if placed too close to the range cooktop.

### IMPORTANT

**Do not place aluminum foil, or ANY material that can melt on the range cooktop.** If these items melt they may damage the cooktop.

### NOTE

The size and type of utensil used, and the amount and type of food being cooked will influence the settings needed for best cooking results.

### Cookware material types

The most popular materials available are:

**Aluminum** - Excellent heat conductor. Some types of food will cause it to darken (Anodized aluminum cookware resists staining & pitting).

**Copper** - Excellent heat conductor but discolors easily.

**Stainless** - Slow heat conductor with uneven cooking results. Is durable, easy to clean and resists staining.

**Cast Iron** - A slow heat conductor however will retain heat very well. Cooks evenly once cooking temperature is reached.

**Porcelain-enamel on metal** - Heating characteristics will vary depending on base material.

**Glass** - Slow heat conductor.

### Set proper burner flame size

The color of the flame is the key to proper burner adjustment. A good flame is clear, blue and hardly visible in a well-lighted room. Each cone of flame should be steady and sharp. Adjust or clean burner if flame is yellow-orange.

**For most cooking;** start on the highest setting and then turn to a lower setting to complete the process. Use the recommendations below as a guide for determining proper flame size for various types of cooking (Fig. 2)

**For deep fat frying;** use a thermometer and adjust the surface knob accordingly. If the fat is too cool, the food will absorb the fat and be greasy. If the fat is too hot, the food will brown so quickly that the center will be undercooked. Do not attempt to deep fat fry too much food at once as the food will neither brown or cook properly.

Flame Size*	Type of Cooking
High Flame	Start most foods; bring water to a boil; pan broiling.
Medium Flame	Maintain a slow boil; thicken sauces, gravies; steaming.
Low Flame	Keep foods cooking; poach; stewing.

\*These settings are based for medium-weight metal or aluminum pans with lids. Settings may vary when using other types of pans.

Fig. 2

### CAUTION

Never extend the flame beyond the outer edge of the cooking utensil. A higher flame wastes energy, and increases your risk of being burned by the flame (Fig. 3).

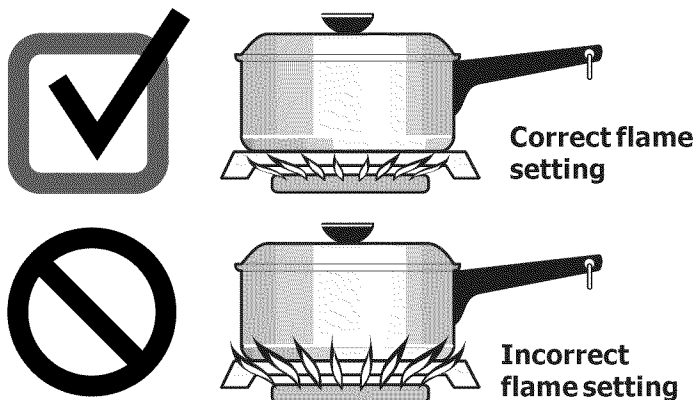

Fig. 3

## SETTING SURFACE CONTROLS

### Setting surface controls

Your gas range may be equipped with many different sized surface burners. The ability to heat food quicker and in larger volumes increases as the burner size increases. It is important to select cookware that is suitable for the amount and type of food being prepared. Select a burner and flame size appropriate for the cookware size.

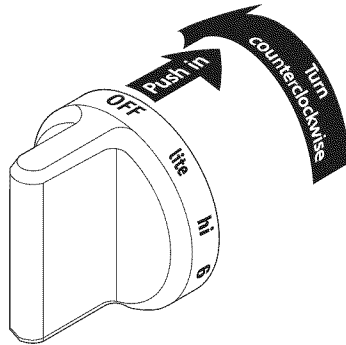

Fig. 1

The smaller **simmer** burner (some models) is best suited for simmering delicate sauces, etc. The standard size (9,500 BTU) burners may be used for most surface cooking needs.

The larger **quick boil** burner or burners (some models) are best used when bringing large quantities of liquid to temperature and when preparing larger quantities of food.

### Setting a surface burner

1. Place cooking utensil on top of surface burner grate. Make sure the cooking utensil is centered and stable on the grate.
2. Push the desired surface control knob in and turn **counterclockwise** out of the OFF position (Fig. 1).
3. Release the knob and rotate to the **lite** position. Visually check that the gas burner has lit.
4. Push the control knob in and turn **counterclockwise** to the desired flame size. Use the control knob markings and adjust the flame as needed.

### IMPORTANT

In the event of an electrical power outage, the surface burners can be lit manually. To light a surface burner, hold a lit match to the burner head, then slowly turn the surface control knob to **lite**. After burner lights push in and turn knob to desired setting. Use caution when lighting surface burners manually.

### NOTE

**DO NOT** cook with the surface control knob left in the LITE position. The electronic ignitor will continue to spark if the control knob is left in the LITE position. When setting any surface control knob to the LITE position, all electronic ignitors will spark at the same time. However, only the surface burner you are setting will ignite.

### CAUTION

**Do not place flammable items** such as plastic salt and pepper shakers, spoon holders or plastic wrappings on the cooktop when it is in use. These items could melt or ignite. Potholders, towels or wooden spoons could catch fire if placed too close to the range cooktop.

### Seasoning, using and caring for the griddle

#### Before first use:

- Wash griddle in hot soapy water. Rinse and dry completely.
- Apply a thin coat of vegetable oil to the entire surface (front and back of griddle).
- Preheat your oven to 350°F. Place the griddle on the upper rack in your oven.
- Bake griddle for 1 hour at 350°F, then turn oven OFF and let cool before removing.
- The surface may appear to have a tacky feel to it from the seasoning process. If desired, wash the griddle in hot soapy water, rinse well, and dry completely.

#### Using the griddle:

Remove the center burner grate and carefully replace with the griddle (some models). Preheat the griddle for 5 minutes on medium to medium low setting. Slow preheat ensures even heat distribution during the cooking process. **DO NOT** preheat the griddle on HI setting. Preheating on HI may warp the griddle and prevent even heat distribution.

#### After each use:

- To prevent rusting, store in a dry place and keep uncovered.
- After each use, clean with a stiff brush and hot water only.
- **Do not clean griddle in the dishwasher.**
- Dry Immediately and apply a light coating of vegetable oil to griddle before storing.

### Home Canning

Be sure to read and observe all the following points when home canning with your appliance. Check with the USDA (United States Department of Agriculture) website and be sure to read all the information they have available as well as follow their recommendations for canning procedures.

- Use only quality flat bottom canners when home canning. Use a straight-edge to check canner bottom (see "Cookware material types" in the **Before setting surface controls** section).
- Start with hot tap water to bring water to boil more quickly.
- Use the highest heat setting when first bringing the water to a boil. Once boiling is achieved, reduce heat to lowest possible setting to maintain that boil.

# OVEN CONTROL FUNCTIONS

## READ THE INSTRUCTIONS CAREFULLY BEFORE USING THE OVEN.

For satisfactory use of your oven, become familiar with the various pad functions of the oven as described below.

**bake time** — Use to enter the length of baking time needed.

**timer on / off** — Use to set or cancel the minute timer.

**quick preheat** — Use to quickly preheat the oven.

**broil** — Use to set broil feature.

**bake** — Use to enter the normal Bake feature.

**quick bake** — Use to set the quick bake convection feature.

**0 thr 9 number pads** — Use to enter temperature and times.

**delay start** — Use with **bake**, **quick bake** and **self-clean** features to program a delayed timed bake or delayed self-cleaning cycle.

**add a min pad** — Use to quickly add minute(s) to the timer.

**set clock pad** — Use to set the time of day.

**oven light** — Use to turn the oven light ON and OFF.

**oven lockout** — Use to activate oven lockout setting.

**self-clean** — Use to set a 2, 3 or 4 hour self-clean cycle.

**keep warm** — Use to set the keep warm features.

**pizza** — Use to set the pizza features.

**chicken nuggets** — Use to set the chicken nuggets feature.

**start** — Use to start all oven features (not used with oven light).

**cancel** — Use to cancel any oven mode previously entered except the oven lockout, time of day & minute timer. Press **cancel** to stop cooking.

## Minimum & maximum control settings

All of the features listed have minimum and maximum time or temperature settings that may be entered into the control. An ENTRY acceptance beep will sound each time a control pad is touched (the Oven Lockout pad is delayed by 3 seconds).

An ENTRY ERROR tone (3 short beeps) will sound if the entry of the temperature or time is below the minimum or above the maximum settings for the feature.

Feature	Min. temp. /time	Max. temp. /time
quick preheat temp.	170°F / 77°C	550°F / 288°C
bake temp.	170°F / 77°C	550°F / 288°C
broil temp.	400°F / 205°C	550°F / 288°C
timer	1 Min.	11 Hrs. 59 Mins.
self-clean time	2 hours	4 hours
quick bake	300°F / 149°C	550°F / 288°C
pizza	300°F / 149°C	550°F / 288°C
chicken nuggets	300°F / 149°C	550°F / 288°C

## SETTING OVEN CONTROLS

### Setting the clock

When the range is first powered up, "12:00" will flash in the display (See Fig. 1).

#### To set the clock to 1:30:

Step	Press
1. Press <b>set clock</b> .	<b>set clock</b>
2. Enter <b>1:30</b> .	<b>1 3 0</b>
3. Press <b>start</b> .	<b>start</b>

### NOTE

It is recommended to always set the clock for the correct time of day before using the appliance. The clock cannot be changed whenever any timed or delayed time feature is active.



Fig. 1

### Changing between continuous bake setting or 6-Hour Energy Saving feature

The oven control has a factory preset built-in 6 Hour Energy Saving feature that will turn off the oven if the oven is left on for more than 6 hours. The control can be programmed to override this feature to continuously bake.

#### To turn off 6-Hour Energy saving mode:

Step	Press
1. Press and hold <b>timer on•off</b> for 6 seconds.	<b>timer on • off</b>
2. Press <b>self-clean</b> to toggle between "6 Hr OFF" (Fig. 2) or "StAY On" (Fig. 3). Select "StAY On" to turn off 6-Hour Energy Saving mode.	<b>self clean</b>
3. Press <b>start</b> to accept.	<b>start</b>



Fig. 2

Fig. 3

### Setting 12 or 24 hour display modes

The clock display mode allows you to choose between 12 or 24 hr mode. The factory pre-set clock display mode is 12 hr. See the example below to change the default mode to 24 hr display.

#### To set 12 or 24 hour mode:

Step	Press
1. Press and hold <b>set clock</b> for 6 seconds.	<b>set clock</b>
2. Press <b>self-clean</b> to toggle between "12 Hr dAY" or "24 Hr dAY" display modes (See Figs. 4 & 5).	<b>self clean</b>
3. Press <b>start</b> to accept.	<b>start</b>



Fig. 4

Fig. 5

### Changing oven temperature display

The oven control is preset to display °F (Fahrenheit) when shipped from the factory.

#### To change the temperature to display °C (Celsius) (oven should not have bake or self-clean active when setting this feature):

Step	Press
1. Press and hold <b>broil</b> for 6 seconds.	<b>broil</b>
2. Press <b>self-clean</b> to toggle between "FAhrn ht" or "CELSIUS" temperature display modes (Figs. 6 & 7). If Celsius display is needed, select "CELSIUS".	<b>self clean</b>
3. Press <b>start</b> to accept.	<b>start</b>



Fig. 6

Fig. 7

## SETTING OVEN CONTROLS

### Setting a silent control panel

Silent mode allows the oven control to operate without sounds. The control may be programmed for silent operation and later returned to operating with all the normal sounds.

#### To set silent mode:

- | Step   | Press              |
|--|--------------------|
| 1. Press and hold <b>delay start</b> for 6 seconds.  | <b>delay start</b> |
| 2. Press <b>self-clean</b> to toggle between "bEEP On" or "bEEP OFF". Select "bEEP OFF" for silent mode. (Figs. 1 & 2) | <b>self clean</b>  |
| 3. Press <b>start</b> to accept  | <b>start</b>       |



Fig. 1



Fig. 2

### Setting oven lockout

The control may be programmed to lock the oven door and lockout the oven control pads.

#### To set the oven lockout feature:

- | Step  | Press   |
|---|---|
| Press and hold <b>lock</b> pad for 3 seconds. "door Loc" will appear in the display until the oven door is completely locked. |  |

#### To unlock the oven lockout feature:

- | Step  | Press   |
|---|---|
| Press and hold <b>lock pad</b> for 3 seconds. Once the oven door has unlocked the "door Loc" message will no longer display (See Fig. 3). |  |

### NOTES

**DO NOT attempt to open the oven door** while the "door Loc" (door lock) message is visible. Allow 15 seconds for the oven door to completely lock. Once the oven door has locked, the current time of day will reappear in the display. If a control pad is pressed when the oven lockout feature is active the control may triple beep which indicates the keypad action is not available when the oven lockout is active.



Fig. 3

### Setting the minute timer

The timer allows you to track your cooking times without interfering with the cooking process. The timer may be set from 1 minute up to 11 hours and 59 minutes.

#### To set the timer for 5 minutes:

- | Step                           | Press               |
|--------------------------------|---------------------|
| 1. Press <b>timer on•off</b> . | <b>timer on•off</b> |
| 2. Enter <b>5</b> minutes.     | <b>5</b>            |
| 3. Press <b>start</b> .        | <b>start</b>        |
- Press **timer on•off** to turn the minute timer off.

### NOTES

The minute timer will display hours and minutes until 1 hour remains on the timer. Once less than 1 hour remains, the display will count down in minutes and seconds. Once the timer has less than 1 minute remaining only seconds will display.

The minute timer DOES NOT start or stop the cooking process. It serves as an extra timer in the kitchen that will beep when the set time has run out. The minute timer can be used alone or while using any of the other oven features.

When the minute timer is in use during a cooking process, the minute timer will be shown in the display. To view the status of other features, press the pad once for the other feature to view the status of that feature.

### Add a minute feature

Use the add 1 minute feature to set additional minutes to the timer. Each press of the key pad will add 1 additional minute. If add a minute key pad is pressed when the timer is not active, the timer will begin counting down from 1 minute.

#### To add 2 additional minutes to the active timer:

- | Step                             | Press            |
|----------------------------------|------------------|
| Press <b>add a minute</b> twice. | <b>add a min</b> |



## SETTING OVEN CONTROLS

### Setting quick preheat

Use the quick preheat feature when using **single rack baking** to quickly heat the oven to bake temperatures. Use this feature only for standard baking. A reminder tone will sound indicating when to place the food in the oven.

When the oven is finished preheating **quick preheat** will become just like the **bake** feature and continue to bake until cancelled.

#### To set quick preheat with a default oven set temperature of 350°F:

Step	Press
1. Press <b>quick preheat</b> .	<b>quick preheat</b>
2. Press <b>start</b> (See Fig. 1).	<b>start</b>

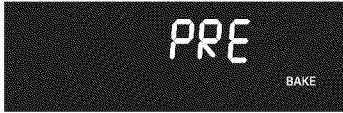

Fig. 1

### Setting bake

Use the bake feature to cook most food items that require normal cooking temperatures. A reminder tone will sound once the oven reaches the set temperature. Bake can be set at any temperature from 170°F to 550°F.

#### To set bake using a default temperature of 350°F:

Step	Press
1. Press <b>bake</b> .	<b>bake</b>
2. Press <b>start</b>	<b>start</b>

#### To set bake for oven temperature of 450°F:

Step	Press
1. Press <b>bake</b> .	<b>bake</b>
2. Enter <b>425</b> .	<b>4 2 5</b>
3. Press <b>start</b>	<b>start</b>

#### NOTES

The oven will bake no longer than 6 hours from the last time the oven door was opened.

If you wish to continuously bake, see "Changing between continuous bake setting or 6-Hour Energy Saving feature" for further information.

### Setting bake time

Use the timed bake feature to automatically turn the oven off after a desired length of time.

#### WARNING

**FOOD POISONING HAZARD.** Do not let food sit for more than one hour before or after cooking. Doing so can result in food poisoning or sickness.

#### To set bake to end after 30 minutes:

Step	Press
1. Press <b>bake time</b> .	<b>bake time</b>
2. Enter <b>30</b> minutes.	<b>3 0</b>
3. Press <b>bake</b> .	<b>bake</b>
4. Press <b>start</b> .	<b>start</b>

#### When the set bake time runs out:

- "**END**" will appear in the display window and the oven will shut-off automatically.
- The control will beep 3 times every 30 seconds as a reminder until the **cancel** key pad is pressed.

#### NOTES

The default maximum **bake time** setting is 6 hours.

After the **bake time** feature has been activated, press the **bake time** pad to display the bake time remaining.

The **bake time** feature may be set with the **convect bake** and **convect roast** features. Bake time will not operate with the broil feature.

## SETTING OVEN CONTROLS

### To program oven for delay start time and to shut-off automatically

The delay start feature allows you to set a start and end time to the cooking process. Prior to setting a delay start, be sure the **time of day is set** correctly. If the delay start needs to be set more than 12 hours in advance (12-24 hours), the control must first be programmed for 24 hour display mode. See "Setting 12 or 24 hour display modes" section.



#### WARNING

**FOOD POISONING HAZARD.** Do not let food sit for more than one hour before or after cooking. Doing so can result in food poisoning or sickness.

**To program the oven for a delay start and to shut-off automatically (example for baking at 375°F for 50 minutes and starting at 5:30):**

Step	Press
1. Press <b>bake time</b> .	bake time
2. Enter <b>50</b> minutes.	<b>5 0</b>
3. Press <b>start</b> .	start
4. Press <b>delay start</b> (See Fig. 1).	delay start
5. Enter <b>530</b> .	<b>5 3 0</b>
6. Press and hold <b>start</b> .	start
7. Enter <b>375</b> .	<b>3 7 5</b>
8. Press <b>start</b> .	start

#### When the set bake time runs out:

1. "**END**" will appear in the display window and the oven will shut-off automatically (See Fig. 2).
2. The control will beep 3 times every 30 seconds as a reminder until the **cancel** key pad is pressed.



Fig. 1



Fig. 2



#### NOTES

After the **delay start** feature has activated and started the cooking process, press the **bake time** pad to display the bake time remaining.

The **delay start** feature may be used with the **convect** or **convect convert** cooking features. Bake time will not operate when using the broil feature.

## SETTING OVEN CONTROLS

### Quick Bake

#### Benefits of the quick bake feature

- Foods may cook up to 25 to 30% faster, saving time and energy.
- Multiple rack baking.
- No special pans or bakeware needed.

**Quick bake** uses a fan to circulate the oven's heat uniformly and continuously around the oven. This improved heat distribution allows for fast, even cooking and browning results. It also gives better baking results when using two racks at the same time.

Heated air flows around the food from all sides, sealing in juices and flavors. Breads and pastry brown more evenly. Layer cakes will have better results using the **quick bake** pad. Most foods baked in a standard oven can be cooked faster and more evenly with the **quick bake** feature.

#### Suggestions for quick bake:

1. For optimum cooking results it is recommended to preheat the oven when baking foods such as cookies, biscuits and breads.
2. Reduce oven temperature 25°F from recipe's recommended oven temperature. Follow the remainder of the recipe's instructions using the minimum recommended cook time.
3. When using 2 oven racks at the same time, place in positions 2 & 5 for best results (Fig. 1).

### Setting Quick Bake

The oven may be programmed to quick bake at any temperature from 300°F to 550°F (147°C to 287°C). The factory preset quick bake temperature is 350°F (177°C).

#### To set quick bake with a default oven set temperature of 350°F:

Step	Press
1. Press <b>quick bake</b> .	<b>quick bake</b>
2. Press <b>start</b> (See Fig. 2).	<b>start</b>

#### To set quick bake for oven temperature of 450°F:

Step	Press
1. Press <b>quick bake</b> .	<b>quick bake</b>
2. Enter <b>425</b> .	<b>4 2 5</b>
3. Press <b>start</b> .	<b>start</b>

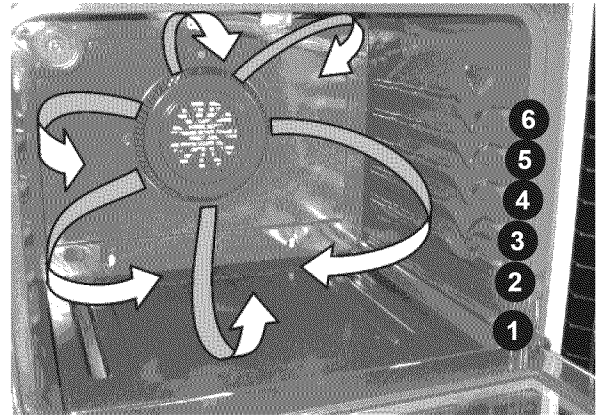

Fig. 1

#### When roasting

1. Preheating is not necessary when roasting foods using **quick bake**.
2. Since **quick bake** cooks food faster, reduce the cook time by 25% from the recommended cook time of your recipe. Check the food at this time. If necessary, increase cook time until the desired doneness is obtained.
3. Do not cover foods when dry roasting - this will keep the air from circulating around the food.

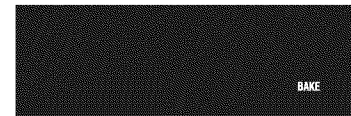

Fig. 2

### NOTES

When using quick bake cook time reductions may vary depending on the amount and type of food being cooked.

Layer cakes will have better results using the **bake** pad.

**The quick bake fan will take 6 minutes to begin rotating** once the quick bake feature has been activated.

## SETTING OVEN CONTROLS

### Broil

Use the broil feature to cook meats that require direct exposure to flame heat for optimum broiling results. When broiling always remember to arrange the oven racks while oven is still cool. Position the oven rack as suggested in the **broil settings table** (See Fig. 4).

To set **broil**:

#### Step

Press

1. Place the broiler insert on the broil pan, then place meat on the insert. Remember to follow all warnings and cautions.
2. Arrange the interior oven rack to recommended position (Figs. 1 & 4). For optimum browning results, preheat oven for **5 minutes** before adding food.
3. Be sure to place food and pan directly under upper oven burner.  
**Close the oven door.**
4. Press **broil**.
5. Press **start** (See Fig. 3)

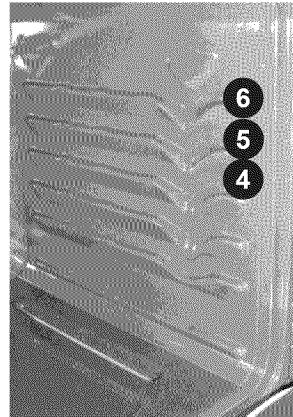

Fig. 1

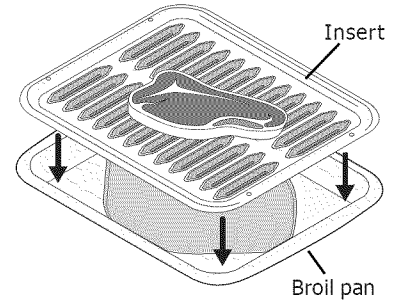

Fig. 2



Fig. 3

### WARNING

Should an oven fire occur, close the oven door and turn the oven OFF. If the fire continues, use a fire extinguisher. **DO NOT** put water or flour on the fire. Flour may be explosive.

### CAUTION

The broiler pan and the insert (some models) allows grease to drain and be kept away from the high heat of the broiler. **DO NOT** use the pan without the insert (Fig. 2). **DO NOT** cover the insert with foil; the exposed grease could ignite. **DO NOT** use the broil pan without the insert or cover the insert with **aluminum foil**. The exposed fat could ignite. To insure proper results use **ONLY** Electrolux Home Products, Inc. approved broil pan & insert.

### NOTE

Always pull the oven rack out to the stop position before turning or removing the food.

### Suggested broil settings table (gas oven)

Food	Rack position	Setting	Cook time in minutes		Doneness
			1st side	2nd side	
Steak 1" thick	5th or 6th*	550°F	8	6	Medium
Steak 1" thick	5th or 6th*	550°F	10	8	Medium-well
Steak 1" thick	5th or 6th*	550°F	11	10	Well
Pork chops 3/4" thick	5th	550°F	12	8	Well
Chicken-bone in	4th	450°F	25	15	Well
Chicken-boneless	5th	450°F	10	8	Well
Fish	5th	550°F	- as directed -		Well
Shrimp	4th	550°F	- as directed -		Well
Hamburger 1" thick	6th*	550°F	12	10	Medium
Hamburger 1" thick	5th	550°F	14	12	Well

\*Use the off-set rack if you choose to use rack position 6.

Fig. 4

## SETTING OVEN CONTROLS

### Setting pizza feature

For your convenience the pizza feature provides 2 different settings. You may use the pizza feature whether starting with fresh or frozen pizza.

#### To set the pizza feature:

- | Step   | Press        |
|--|--------------|
| 1. Press <b>pizza</b> once to cook frozen pizza (Fig.1) or twice when setting for fresh pizza (Fig. 2). You may adjust the oven temperature to fit your needs. | <b>pizza</b> |
| 2. Press <b>start</b>  | <b>start</b> |

#### NOTES

Use only 1 oven rack for best results when using the pizza feature.

The pizza setting is not timed. Be sure to monitor the time needed to finish cooking the pizza.

Follow package directions for cook time. Check pizza at the minimum recommended time.

The preset oven temperature for the frozen pizza setting is 425°F and the fresh pizza is 400°F.



Fig. 1

Fig. 2

### Setting chicken nuggets feature

Use the chicken nuggets feature to cook convenience style chicken nuggets. The user may change the temperature or bake time at any time to fit their needs. Once the 20 minute preset cook time is finished the chicken nuggets feature will automatically set the oven to the **keep warm** feature for 3 hours. You may **cancel** the keep warm at any time if not needed.

#### To set the chicken nuggets feature:

- | Step                               | Press                  |
|------------------------------------|------------------------|
| 1. Press <b>chicken nuggets</b> .  | <b>chicken nuggets</b> |
| 2. Press <b>start</b> (See Fig. 3) | <b>start</b>           |



Fig. 3

### Setting chicken nuggets feature (cont'd)

#### NOTES

After 20 minutes of cook time the **chicken nuggets** feature will automatically start the **keep warm** feature. If keep warm is not necessary, press cancel at any time to stop **keep warm**.

The **pizza** and **chicken nuggets** feature uses the convection fan. The fan will take 6 minutes to start rotating once these features have been activated.

### Setting keep warm

The keep warm feature will keep oven baked foods warm for serving up to 3 hours after cooking has finished. After 3 hours the keep warm feature will shut the oven off automatically.

The keep warm feature may be used without any other cooking operations or may be used after cooking has finished using **bake time** and or **delay start**.

#### WARNING

**FOOD POISONING HAZARD.** Do not let food sit for more than one hour before or after cooking. Doing so can result in food poisoning or sickness.

#### To set the oven to **keep warm**:

- | Step                        | Press            |
|-----------------------------|------------------|
| 1. Press <b>keep warm</b> . | <b>keep warm</b> |
| 2. Press <b>start</b> .     | <b>start</b>     |
- "HLd" for hold will appear in the display (Fig. 4).



Fig. 4

#### NOTE

The keep warm feature will automatically turn the oven off after 3 hours.



## SETTING OVEN CONTROLS

### Adjusting the oven temperature

Your appliance has been factory calibrated and tested to ensure an accurate baking temperature. For the first few uses, follow your recipe times and temperature recommendations carefully. If you think the oven is cooking too hot or too cool for your recipe times, you can adjust the control so the oven cooks hotter or cooler than the temperature displayed.

The oven temperature may be increased +35°F (+19°C) or decreased -35°F (-19°C) from the factory settings.

#### Example: increase the oven temperature by 30°F:

Step	Press
1. Press and <b>hold bake</b> for 6 seconds.	<b>bake</b>
2. Enter 30.	<b>3 0</b>
3. Press <b>start</b> .	<b>start</b>

#### Example: decrease the oven temperature by 30°F:

Step	Press
1. Press and <b>hold bake</b> for 6 seconds.	<b>bake</b>
2. Enter 30.	<b>3 0</b>
3. Press <b>self-clean</b> .	<b>self clean</b>
4. Press <b>start</b> .	<b>start</b>

### Operating the oven light

The interior oven light will automatically turn ON when the oven door is opened.

Press  to turn the interior oven light ON and OFF whenever the oven door is closed.

The interior oven light is located at the upper left rear wall of the oven interior and is covered with a glass shield held by a wire holder. The glass shield must be in place whenever the oven is in use.

To change the interior oven light, see "Changing the oven light" in the **Care & Cleaning** section.

### NOTES

Oven temperature adjustments made will not affect the broil or self-cleaning feature temperatures.

If the temperature shows an adjustment of -30°F, and a +30°F adjustment is needed, you can toggle between the (-) or (+) in the display by pressing **self clean**.

DO NOT USE oven thermometers such as those found in grocery stores to check the temperature settings inside your oven. These oven thermometers may vary as much as 20 to 40 degrees from actual temperatures.

## SETTING OVEN CONTROLS

### To Set the Sabbath Feature (for use on the Jewish Sabbath & Holidays)



For further assistance, guidelines for proper usage and a complete list of models with the Sabbath feature, please visit the web at <http://www.star-k.org>.



### WARNING

**FOOD POISONING HAZARD.** Do not let food sit for more than one hour before or after cooking. Doing so can result in food poisoning or sickness.

The **bake time** and **delay start** pads are used to set the Sabbath feature. The Sabbath feature may only be used with the **bake** feature. The oven temperature may be set higher or lower after setting the Sabbath feature (the oven temperature adjustment feature should be used only during Jewish Holidays), however the display will not be visible and no audible tones will be provided when a change occurs.

Once the oven is properly set using the **bake** feature with the Sabbath mode active, the oven will remain continuously ON until cancelled. The Sabbath mode will override the factory preset 6-Hour Energy Saving feature.

If the oven light(s) are needed during the Sabbath, press the **oven light** pad **before** activating the Sabbath feature. Once the oven light is turned on and the Sabbath feature is active, the oven light will remain on until the Sabbath feature is turned OFF. If the oven light needs to be off, be sure to turn the oven light off before activating the Sabbath feature.

It is recommended that any oven temperature change with the Sabbath feature active be followed with 2 presses of the **start** pad. This will insure the oven remains ON even if the attempt to set the oven temperature was lower or higher than the oven control can accept. If the oven temperature is set incorrectly, the oven temperature will default to 170°F or 550°F. Try to set the desired oven temperature again.

### To program the oven for 350°F bake and activate the Sabbath feature:

- | Step   | Press                          |
|--|--------------------------------|
| 1. Be sure that the clock is set with the correct time of day.   |                                |
| 2. Arrange the oven racks and place the food in the oven and close door.   |                                |
| 3. Press <b>bake</b> .   | <b>bake</b>                    |
| 4. Press <b>start</b> .  | <b>start</b>                   |
| 5. If a <b>timed bake</b> or <b>delayed timed bake</b> is needed then enter the time in this step. If not, skip this step and continue to step 6. Refer to the <b>bake time</b> or <b>delay start</b> instructions. Remember the oven will shut-off after completing a <b>timed bake</b> or <b>delay start</b> and therefore may only be used once during the Sabbath/Jewish Holidays. The maximum <b>delay start</b> time is 11 hours & 59 minutes. |                                |
| 6. Press and <b>hold both the</b> <b>bake time</b> and <b>delay start</b> pads for at least 3 seconds simultaneously. The control will beep and <b>SAb</b> will appear in the display (See Fig. 1). The oven is properly set for the Sabbath once <b>SAb</b> appears in the display.   | <b>bake time + delay start</b> |



Fig. 1

## SETTING OVEN CONTROLS

### To Set the Sabbath Feature (cont'd)

To turn off the oven but keep the Sabbath feature active:

Press **cancel**. cancel

To turn off the Sabbath feature:

Press and hold both the bake time + delay start  
**bake time and delay start pads**  
**for at least 3 seconds**. The control will beep and **SAb** will disappear from the display. The oven is no longer programmed for the Sabbath feature.

**What to do during a power failure or power interruption after the Sabbath feature was activated:**

Should you experience a power failure or interruption, the oven will shut-off. When power is restored the oven will not turn back on automatically. The oven will remember that it is set for the Sabbath and the oven display will show the message "SF" for Sabbath failure (Fig. 1).



Fig. 1

The food may be safely removed from the oven while still in the Sabbath feature, however the oven cannot be turned back on until after the Sabbath/Holidays.

After the Sabbath observance turn OFF the Sabbath feature. At the same time **press and hold both** the

**bake time + delay start** pads for at least 3 seconds.

**SF** will disappear from the display and the oven may be used with all normal functions.

### NOTES

If a delay start time longer than 12 hours (maximum of 24 hours) in advance is desired, set the display mode for the 24 hour setting. For detailed instructions see the section "Setting 12 or 24 hour display modes".

It is not advised to attempt to activate any other program feature except **BAKE** while the Sabbath feature is active. **ONLY** the following key pads will function correctly with the Sabbath feature: **0-9 number pads**, **bake**, **start** & **cancel**. **ALL OTHER KEYPADS** should not be used once the Sabbath feature is activated.

You may change the oven temperature once baking has started. Press **bake**, enter the oven temperature change (170 to 550F°) and press **start** (for Jewish Holidays only). Remember that **the oven control will no longer beep or display any further changes** once the oven is set for the Sabbath feature.

If the **keep warm** feature was activated and the Sabbath feature was set the keep warm feature will automatically shut-off the oven off after 3 hours.

## SETTING LOWER OVEN DRAWER

### Dual features of Bake-n-Warm™ oven drawer

The lower oven feature is ideal for cooking foods such as pizza, casseroles, baked potatoes and frozen convenience foods. The purpose of the keep warm drawer feature is to keep hot cooked foods at serving temperature. Always start with hot food. It is NOT recommended to heat cold food in the keep warm drawer.

#### WARNING

**KEEP CHILDREN AWAY FROM THE LOWER OVEN WHEN HOT. FAILURE TO DO SO CAN RESULT IN BURNS.**

**Storage in or on appliance—flammable materials should not be stored in an oven, near surface units or in the storage drawer, warmer drawer or lower oven.** This includes paper, plastic and cloth items, such as cookbooks, plasticware and towels, as well as flammable liquids. Do not store explosives, such as aerosol cans, on or near the range.

#### CAUTION

Always use oven mitts when removing food from the Bake-n-Warm™ oven. The drawer rack, drawer compartment, cookware and plates may be hot.

**FOOD POISONING HAZARD. Do not let food sit for more than one hour before or after cooking. Doing so can result in food poisoning or sickness.**

Should an oven fire occur, close the drawer and turn the Bake-n-Warm™ oven OFF. If the fire continues, use a fire extinguisher. **DO NOT** put water or flour on the fire. Flour may be explosive.



Fig. 1

### Using the oven or keep warm features

- **When placing food in the Bake-n-Warm oven always use a baking sheet or pan with 4 raised sides to prevent food from sliding off.**
- To minimize sliding of bake ware, open and close the drawer gently making sure the drawer latches when closed.
- During cooking/warming, limit the number of times the drawer is opened. This will minimize heat loss. Repeated opening of the drawer during while cooking may increase cooking times and produce uneven cooking results. The cook time for the lower oven feature may vary slightly from the upper oven times.
- For best results with the lower oven, pastries, casseroles with crumb toppings and bakery type items should be cooked in the larger upper oven.
- The maximum height of foods and utensils that may be used in the Bake-n-Warm™ oven is 4". The maximum width is 15". **Pay close attention to foods that have potential to rise beyond the recommended 4" maximum height.**
- Use pans in the drawer large enough to hold food **and** any juices that may result from the cooking process.
- The drawer rack must always be in place when cooking or warming foods in the drawer. Be sure that the rack is placed with the down turned sides into the drawer. This will provide some air space between the drawer and the food (See Figs. 1 & 2). Do not put food or utensils directly on the oven drawer bottom.
- **Do not use plastic wrap to cover food. Plastic may melt onto the drawer or surrounding areas and be very difficult to clean.** Use a lid or aluminum foil instead. Use only utensils and cookware in the oven drawer that are recommended for oven use in the upper oven.

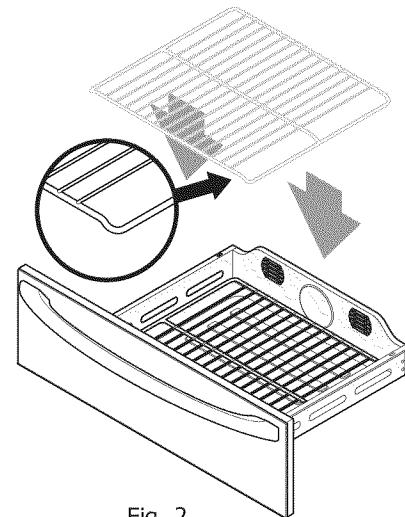

Fig. 2

## SETTING LOWER OVEN DRAWER

### IMPORTANT

**DO NOT LINE THE OVEN DRAWER WITH FOIL OR COVER THE OVEN RACK WITH FOIL.** This may result in damage to your lower oven.

### Setting the lower oven feature of the Bake-n-Warm™ oven:

1. Push in and turn the Bake-n-Warm™ oven control knob clockwise to the desired temperature setting (See Fig. 1). A beep will sound indicating the oven is ON.
2. For best results always preheat the oven drawer before adding food. An empty oven drawer will preheat in approximately 15 minutes.
3. The indicator light above the control knob will remain ON constantly through the preheat and cooking process.
4. When the preheat beep sounds, open the Bake-n-Warm™ drawer completely. Place the food on the drawer rack using oven mitts (See previous page - Fig. 1).
5. Gently close the drawer. Be sure the magnetic system latches.
6. When done cooking, turn the Bake-n Warm™ oven control knob to the OFF position. Remove prepared food from the drawer.

Please note the lower oven may be programmed for any temperature from 170°F to 450°F (77°C to 232°C).

### Setting the keep warm drawer feature of the Bake-n-Warm™ oven:

1. Push in and turn the Bake-n-Warm™ oven control knob counterclockwise to the desired keep warm drawer setting. A beep will sound indicating the drawer is ON. Note: The temperatures are approximate, and are designated by **HI** (high) and **LO** (low). Use the recommended keep warm drawer food settings for the type of food placed in the drawer (See Figs. 1 & 3)
2. For best results, preheat the oven drawer before adding food. An empty oven drawer will preheat in approximately 15 minutes.
3. The indicator light above the control knob will remain ON constantly through the preheat and warming process.
4. Place the food on the oven drawer rack using oven mitts (See Fig. 2 on previous page).
5. Gently close the drawer. Be sure the magnetic system latches.
6. When the food is ready to serve, turn the Bake-n Warm™ oven control knob to the OFF position. Remove prepared food from the oven drawer.

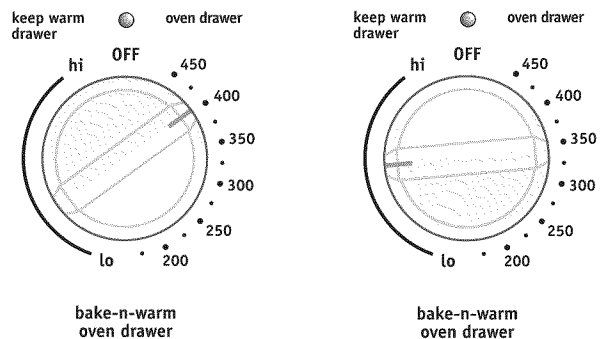

Fig. 1

Fig. 2

### Keep warm drawer temperature selection

Recommended keep warm drawer food settings are shown in Fig. 3. If a particular food is not listed, start with a medium setting. If more crispness is desired, remove the lid or aluminum foil from the food. Most foods can be kept at serving temperatures on a medium setting. When a combination of foods are to be kept warm (for example a meat with 2 vegetables and rolls) use the **hi** (high) setting.

#### Keep warm drawer recommended food settings table

Food Item	Setting
Bacon, hamburger patties, poultry, pork chops, fried foods & pizza.	<b>hi</b>
Gravies, vegetables, roasts (beef, pork & lamb), casseroles, biscuits, rolls (hard), pasteries & eggs.	medium
Rolls (soft) & empty dinner plates	<b>lo</b>

Fig. 3

### NOTES

The Bake-n-Warm™ oven will automatically shut-off after 6 hours of continuous use.

The drawer will not operate when the upper oven is set for self-cleaning or the oven lockout feature is active. If the Bake-n-Warm™ oven is ON and a self-clean or oven lockout feature request is attempted, the oven control will deny the request with a triple beep.

### Bake-n-Warm™ oven light operation:

The Bake-n-Warm™ oven light operates with the upper oven light and automatically turns ON when the upper oven door is opened. If equipped, the Bake-n-Warm™ oven light may also be manually operated by pressing  key pad.



## Self-cleaning

A self-cleaning oven cleans itself with high temperatures (well above normal cooking temperatures) which eliminate soils completely or reduces them to a fine powdered ash you can wipe away with a damp cloth.

Your oven allows you to set 3 different self-cleaning cycle durations. A 3-hour cleaning time is best used for normal cleaning; 2-hour time for light soils and a 4-hour time option for heavier burnt-on soils.

### ➔ IMPORTANT

#### Adhere to the following self-clean precautions:

- **DO NOT** use oven cleaners or oven protective coatings in or around any part of the oven interior.
- **DO NOT** clean the oven door gasket. The woven material of the oven door gasket is essential for a good seal. Care should be taken not to rub, damage or remove the gasket.
- **DO NOT** use any cleaning materials on the oven door gasket. Doing so could cause damage (See Fig. 1).
- **Remove the broiler pan and insert, all utensils and ANY ALUMINUM FOIL. These items cannot withstand high cleaning temperatures and will melt.**
- **Completely remove ALL OVEN RACKS and ANY ACCESSORIES. If the oven racks are not removed they will lose their special coating properties and no longer slide in and out of the oven cavity effortlessly.**
- **Remove any excessive spills.** Any spills on the oven bottom should be wiped-up and removed **before starting** the self-cleaning cycle. To clean, use hot, soapy water and a cloth. Large spills can cause heavy smoke or fire when subjected to high temperatures. **DO NOT** allow food spills with a high sugar or acid content (such as milk, tomatoes, sauerkraut, fruit juices or pie filling) to remain on the surface as they may leave a dull spot even after cleaning.
- Clean any soil from the oven frame, the door liner outside the oven door gasket and the small area at the front center of the oven bottom. These areas heat sufficiently to burn soil on. Clean with soap and water. These areas are shown in white (See Fig. 1).

### ⚠ CAUTION

During the self-cleaning cycle, the outside of the range can become very hot to the touch. **DO NOT** leave small children unattended near the appliance.

The health of some birds is extremely sensitive to the fumes given off during the self-cleaning cycle of any range. Move birds to another well-ventilated room.

**DO NOT** force the oven door open. This can damage the automatic door locking system. Use caution when opening the door after the self-cleaning cycle is completed. The oven may still be **VERY HOT**.

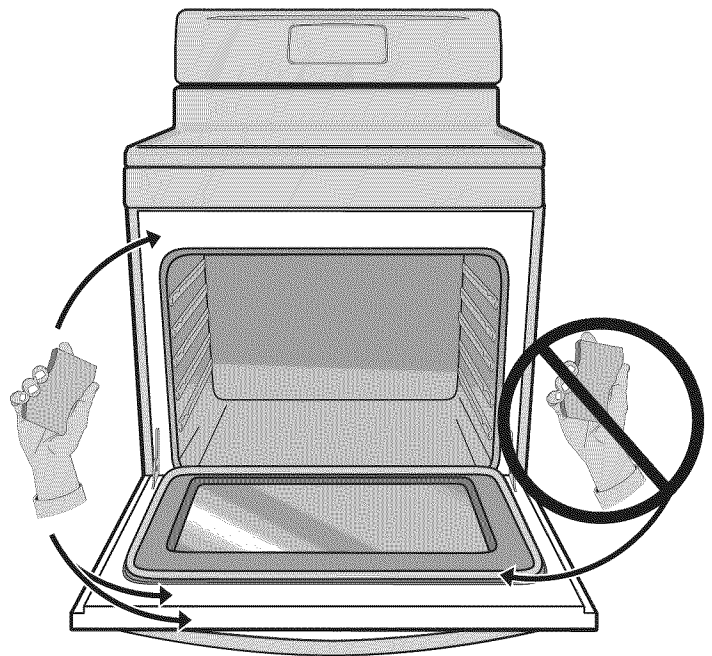

Fig. 1

## SELF-CLEANING

### Setting a self-clean cycle or a delayed start self-clean cycle

**Examples: To start an immediate self-cleaning cycle and/or how to add a delay start time of 9:00 o'clock and shut-off self-clean automatically:**

- | Step   | Press       |
|--|-------------|
| 1. Be sure the control is set with the correct time of day, <b>ALL</b> the oven racks are removed and the oven door is closed.                         |             |
| <b>Go to step 5</b> if you wish to start the self-clean immediately.   |             |
| <b>Finish steps 2 thru 6</b> if setting a delay start self-clean.  |             |
| 2. Press <b>delay start</b> .  | delay start |
| 3. Enter <b>9 0 0</b> .  | 9 0 0       |
| 4. Press <b>start</b> .  | start       |
| 5. Press <b>self clean</b> once for a 3-hour clean time, press self clean twice for 4-hour clean and press 3 times for a 2-hour self-clean cycle time. | self clean  |
| 6. Press <b>start</b> .  | start       |

### IMPORTANT

As soon as the controls are set, the motor driven door lock will begin to close automatically. "door Loc" will appear in the display (See Fig. 1). **DO NOT** open the oven door while "door Loc" is on (allow 15 seconds for the oven door to completely lock).

Once the door has locked "CLn" will appear in the display indicating the oven will begin the self-clean process (Fig. 2).



door Loc

Fig. 1



CLn

Fig. 2

### When the self-clean cycle has completed:

1. The time of day and "Hot" will appear in the display window (See Fig.3).
2. Once the oven has cooled down for about 1 hour and "Hot" is no longer displayed the "door OPn" message should appear (Fig. 4). When this message turns off the oven door may be opened. Use **caution** and avoid possible burns when opening the door after the self-cleaning cycle has completed. The oven may still be **VERY HOT**.



Hot

Fig. 3



door OPn

Fig. 4

### If it becomes necessary to stop a self-clean cycle once it has been activated:

1. Press **cancel**.
2. If the self-clean cycle has heated the oven to a high temperature, allow enough time for the oven to cool and for the "door OPn" message to appear (Fig. 4). When this message turns off the oven door may be opened.
3. Restart the self-clean cycle once all conditions have been corrected.

### CAUTION

To avoid possible burns use care when opening the oven door after the self-cleaning cycle. **Stand to the side of the oven** when opening the door to allow hot air or steam to escape.

**DO NOT** force the oven door open. This can damage the automatic door locking system. Use caution and avoid possible burns when opening the door after the self-cleaning cycle has completed. The oven may still be **VERY HOT**.

### NOTES

Whenever the self-clean feature is active you may check the amount of time remaining in the self-clean cycle by pressing the **self clean** pad once. The oven door will be locked until the range has cooled sufficiently. You will need to allow about **1 additional hour** to the time displayed before you can open the oven door.

When the oven is cool, wipe away any residue or powdered ash with a damp cloth or paper towel.

## Cleaning recommendation table

Surface type	Recommendation
<ul style="list-style-type: none"> <li>• <b>Aluminum (trim pieces) &amp; vinyl</b></li> <li>• <b>Painted and plastic control knobs</b></li> <li>• <b>Painted body parts</b></li> <li>• <b>Painted decorative trim</b></li> </ul>	<p>Use hot, soapy water and a cloth. Dry with a clean cloth.</p> <p><i>For general cleaning, use hot, soapy water and a cloth. For more difficult soils and built-up grease, apply a liquid detergent directly onto the soil. Leave on soil for 30 to 60 minutes. Rinse with a damp cloth and dry. <b>Do not</b> use abrasive cleaners on any of these materials; they can scratch. To remove control knobs, turn to the OFF position; grasp firmly and pull straight off the shaft. To replace knobs after cleaning, line up the flat sides of both the knob and the shaft; then push the knob into place.</i></p>
<ul style="list-style-type: none"> <li>• <b>Chrome control panel</b> (some models)</li> <li>• <b>Decorative trim</b> (some models)</li> </ul>	<p><i>Before cleaning the control panel, turn all controls to OFF and remove the control knobs. To remove, pull each knob straight off the shaft. Clean using hot, soapy water and a dishcloth. Rinse with a clean water using a dishcloth. Be sure to squeeze excess water from the cloth before wiping the panel; especially when wiping around the controls. Excess water in or around the controls may cause damage to the appliance. To replace knobs after cleaning, line up the flat sides of both the knob and the shaft; then push the knob into place.</i></p>
<ul style="list-style-type: none"> <li>• <b>Easy Care™ Stainless Steel</b> (some models)</li> </ul>	<p>If your range finish is <b>Easy Care™ Stainless Steel</b> (some models), clean the stainless with warm soapy water using a clean sponge or cloth. Rinse with clean water and dry with a soft clean cloth. <b>DO NOT</b> use <b>ANY</b> store bought cleaners like Stainless Steel cleaners or any other types of cleaners containing any abrasive, chlorides, chlorines or ammonia. It is recommended to use mild dish soap and water or a 50/50 solution of water and vinegar.</p>
<ul style="list-style-type: none"> <li>• <b>Porcelain enamel broiler pan and broiler pan insert</b> (if equipped)</li> <li>• <b>Door liner &amp; body parts</b></li> <li>• <b>Lower oven</b> (see lower oven cleaning tips provided later in the Care &amp; Cleaning section)</li> </ul>	<p>Gentle scouring with a soapy scouring pad will remove most spots. Rinse with a 1:1 solution of clear water and ammonia. <i>If necessary</i>, cover difficult spots with an ammonia-soaked paper towel for 30 to 40 minutes. Rinse with clean water and a damp cloth, and then scrub with a soap-filled scouring pad. Rinse and wipe dry with a clean cloth. Remove all cleaners or the porcelain may become damaged during future heating. <b>Do not</b> use oven cleaners on cooktop or lower oven.</p>
<ul style="list-style-type: none"> <li>• <b>Oven racks</b></li> </ul>	<p><b>Oven racks must be removed from oven before starting self-clean cycle.</b> Clean by using a mild, abrasive cleaner following manufacturer's instructions. Rinse with clean water and dry.</p>
<ul style="list-style-type: none"> <li>• <b>Oven door</b></li> </ul>	<p>Use soap &amp; water to thoroughly clean the top, sides and front of the oven door. Rinse well. You may use a glass cleaner on the outside glass of the oven door. <b>Do not</b> immerse the door in water. <b>Do not spray or allow water or the glass cleaner to enter the door vents.</b> Do not use oven cleaners, cleaning powders or any harsh abrasive cleaning materials on the outside of the oven door. <b>Do not</b> clean the oven door gasket. On self-cleaning models the oven door gasket is made of a woven material which is essential for a good seal. Care should be taken not to rub, damage or remove this gasket.</p>
<ul style="list-style-type: none"> <li>• <b>Cooktop surface areas, surface burner heads, caps &amp; burner grates</b></li> </ul>	<p>See Cleaning the cooktop and surface burners instructions provided in the following <b>Care &amp; Cleaning</b> section.</p>

## CARE & CLEANING

### Cleaning tips for the Bake-n-Warm™ oven

For easier clean-up, the Bake-n-Warm™ oven drawer should be cleaned as soon as the oven cools down. Routinely clean to minimize build-up of spatter and food leftovers. When cooking foods that spatter, cover the food with heat-proof lid or foil. Use a mild detergent and water to clean the oven drawer and sides. For stubborn soils use a nonabrasive cleaning pad to remove soils. **DO NOT** use oven cleaners when cleaning the Bake-n-Warm™ oven.



### CAUTION

Be sure the range is unplugged and all parts are COOL before replacing oven light. Wear a leather-faced glove for protection against possible broken glass.

### To remove the Bake-n-Warm™ oven drawer & replace the lower oven light:

1. Before drawer removal, be sure to turn OFF the Bake-n-Warm™ oven and let the drawer area cool completely.
2. Pull the drawer away from the oven. Using a phillips-head screwdriver remove the 2 drawer screws from the insides of the front oven drawer compartment (Fig. 1).
3. With one hand hold the drawer front in place. Use your other hand to pull the glide away from the oven (See Fig. 2) until the glide hook disengages (See Fig. 3).
4. Repeat from step 3 above for other side of the drawer.
5. With BOTH glide hooks disengaged, carefully lift the drawer up and away from the oven. Push both drawer glides into lower oven cavity.
6. Replace the lower oven light with a 40 Watt appliance light bulb (Refer to Fig.5).



Fig. 1

### To replace the Bake-n-Warm™ oven drawer:

1. Pull both drawer glides and fully extend outward from lower oven cavity.
2. Carefully rest the drawer on top of both glides.
3. Adjust the drawer position on top of the rails until both of the drawer side slots are correctly engaged with the glide hooks (See Fig. 4).
4. Pull the drawer forward to line up the drawer with both screw holes in glides. Using a phillips-head screwdriver replace the 2 screws removed from the inner drawer sides.
5. Replace drawer rack and close lower oven drawer.

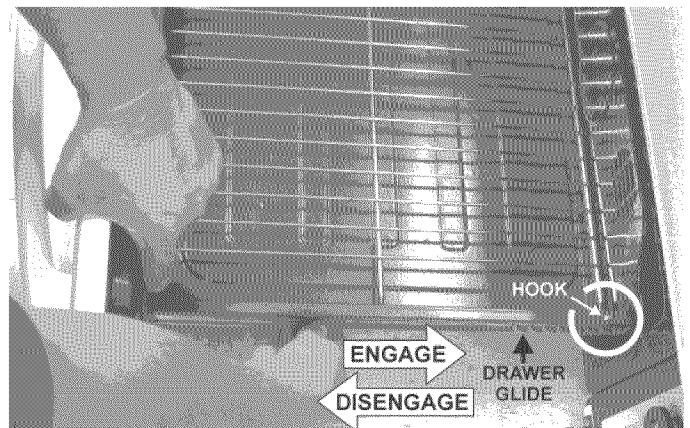
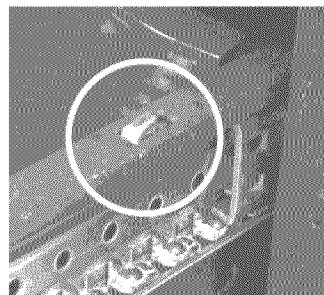
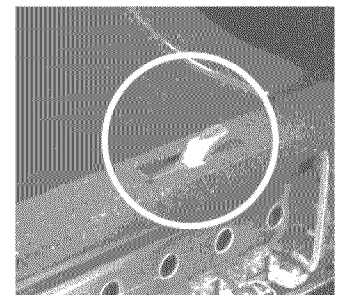

Fig. 2



Glide Hook Disengaged

Fig. 3



Glide Hook Engaged

Fig. 4

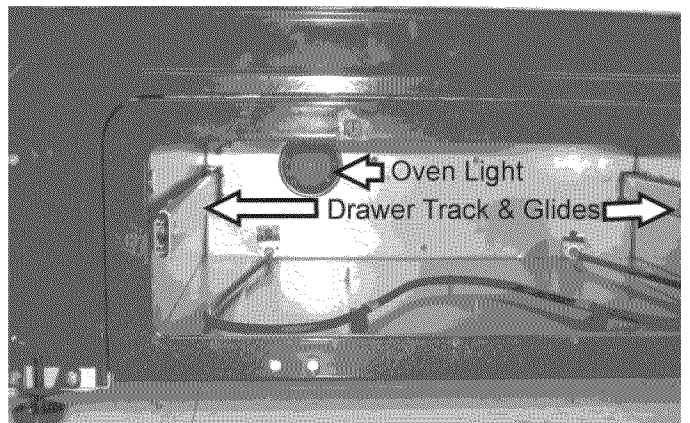

Fig. 5

### Cleaning the cooktop and surface burners

#### **CAUTION**

To avoid possible burns use care when cleaning the cooktop. **DO NOT** attempt to clean the cooktop whenever the cooktop or burner heads are still hot.

To avoid possible burns **DO NOT** attempt any of the cleaning instructions provided below before turning OFF all of the surface burners and allow them to cool.

The cooktop and surface burners are designed to make cleaning easier. Since cooktop surface burners are sealed, cleanups are easy when spillovers are cleaned up immediately. Routinely clean the cooktop. Wipe with a clean, damp cloth and wipe dry to avoid scratches. The contoured well areas and burner drip pans (some models) should be frequently cleaned also.

Keeping the burner head ports and slots clean will prevent improper ignition and an uneven flame. Refer to the following sections for further instructions.

#### **To clean the burner head ignition ports**

Each burner head has a small ignition port located as illustrated. Should you experience ignition problems it may be that this port hole is partially blocked with soil. With the burner head in place, use a small wire gauge needle or the end of a paper clip to clear the ignition port.

#### **To clean the surface burner heads**

For proper gas flow it may be necessary to clean the burner head and slots. To clean, first use a clean DAMP cloth to soak up any spills. Remove any food from between the burner slots using a small non-abrasive brush like a toothbrush and afterwards wipe up using a damp cloth. For stubborn soils located in the slots, use a small-gauge wire or needle to clean.

#### **To clean the recessed and contoured well areas of the cooktop**

If a spill occurs on or in the recessed or contoured areas, blot up spill with an absorbent cloth. Rinse with a clean, damp cloth and wipe dry.

#### **To clean the burner grates, burner caps & burner drip pans (some models)**

Use a soap-filled scouring pad or a mild abrasive cleanser to clean the burner grates, burner caps and surface burner drip pans (if equipped).

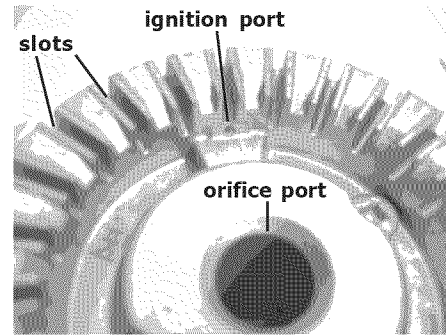

Fig. 1 - Cooktop burner head

#### **IMPORTANT**

The surface burner heads are secured to the cooktop and must be cleaned in place on the cooktop. For proper flow of gas and ignition of the burner — **DO NOT allow spills, food, cleaning agents or any other material to enter the gas orifice holder opening.** Always keep the surface burner cap and surface burner head in place whenever a surface burner is in use.

### Replacing the oven light

The light bulb is located at the rear of the oven and is covered with a glass shield held by a wire holder. The glass shield must be in place whenever the oven is in use.

#### **To replace the oven light bulb:**

1. Turn electrical power off at the main source or unplug the range.
2. Press wire holder to one side to release the glass shield that covers the light bulb.
3. Replace bulb with a new 40 watt appliance bulb.
4. Replace glass shield over bulb and snap wire holder back into place.
5. Turn power back on again at the main source (or plug the appliance back in).
6. The clock will then need to be reset. To reset, see "Setting the clock" in this Use & Care Guide.

#### **CAUTION**

Be sure the range is unplugged and all parts are COOL before replacing oven light. Wear a leather-faced glove for protection against possible broken glass.

## CARE & CLEANING

### Removing and replacing the lift-off oven door

#### CAUTION

The door is heavy. For safe, temporary storage, lay the door flat with the inside of the door facing down.

#### To remove oven door:

1. Open oven door completely (horizontal with floor - See Fig. 1).
2. Pull the door hinge locks on both left and right door hinges down from the oven frame completely towards the oven door (See Fig. 2). A tool such as a small flat-blade screwdriver may be required.
3. Firmly grasp both sides of oven door along the door sides (Do not use the oven door handle - See Fig. 3).
4. Close the door to the broil stop position (the oven door will stop into this position just before fully closing).
5. With the oven door in the broil stop position, lift the oven door hinge arms over the roller pins located on each side of the oven frame (See Fig. 4).

#### To replace oven door:

1. Firmly grasp both sides of oven door along the door sides (Do not use the oven door handle - See Fig. 3).
2. Holding the oven door at the same angle as the removal position, seat the hook of the hinge arm over the roller pins located on each side of the oven door frame (See Fig. 4). The hook of the hinge arms must be fully seated onto the roller pins.
3. Fully open the oven door (horizontal with floor - See Fig. 1).
4. Push the door hinge locks up towards and into the oven frame on both left and right oven door hinges (See Fig. 2) to the locked position.
5. Close the oven door.

#### Special door care instructions - Most oven doors contain glass that can break.

#### Read the following recommendations:

1. Do not close the oven door until all the oven racks are fully in place.
2. Do not hit the glass with pots, pans, or any other object.
3. Scratching, hitting, jarring or stressing the glass may weaken its structure causing an increased risk of breakage at a later time.

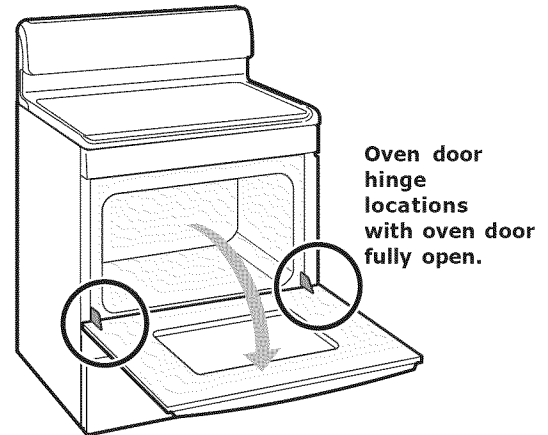

Fig. 1

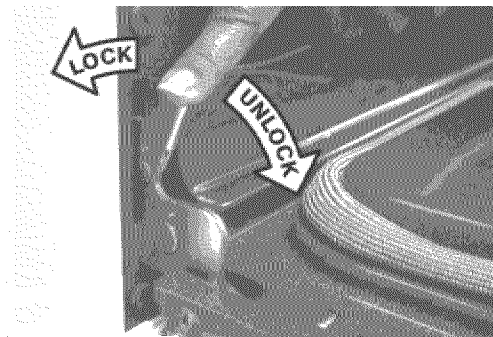

Fig. 2

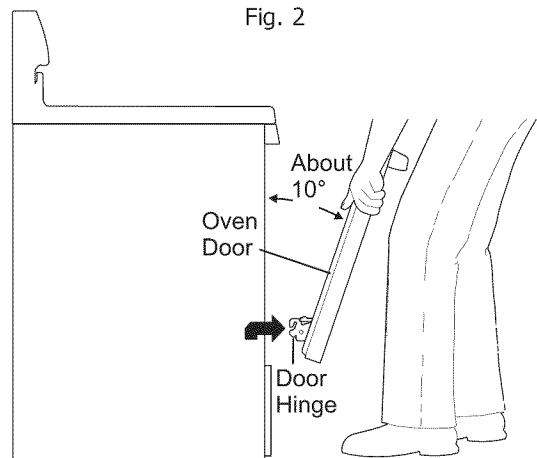

Fig. 3

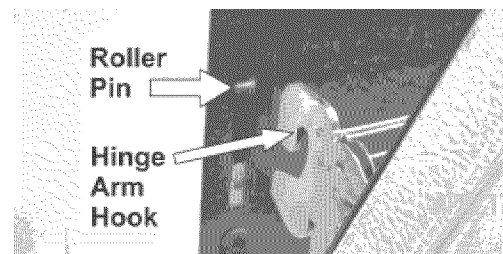

Fig. 4

Problem	Solution
Poor baking results.	<ul style="list-style-type: none"> <li>• Many factors affect baking results. Make sure the proper oven rack position is used. Center food in the oven and space pans to allow air to circulate. Allow the oven to preheat to the set temperature before placing food in the oven. Try adjusting the recipe's recommended temperature or baking time. If you feel the oven is too hot or cool, see "Adjusting Oven Temperature" section in this Use &amp; Care Guide.</li> </ul>
Entire appliance does not operate.	<ul style="list-style-type: none"> <li>• The time of day is not set. The time of day <b>must</b> first be set in order to operate the oven. See "Setting the clock" in the <b>Setting oven controls</b> section.</li> <li>• Make sure cord/plug is plugged correctly into outlet.</li> <li>• Service wiring is not complete. Contact your dealer, installing agent or authorized service agent.</li> <li>• Electrical power outage. Check house lights to be sure. Call your local electric company for service.</li> </ul>
Oven portion of appliance does not operate.	<ul style="list-style-type: none"> <li>• Be sure the oven controls are set properly for the desired cooking feature. See <b>Setting Oven Controls</b> in this manual or see "Entire appliance does not operate" in this checklist.</li> </ul>
Surface burners do not ignite.	<ul style="list-style-type: none"> <li>• Surface control knob was not completely turned to LITE. Push in &amp; turn the surface control knob to LITE until burner ignites and then turn control knob to desired flame size.</li> <li>• Burner ports are clogged. With the burner OFF, use a small-gauge wire or needle to burner head slots and ignition ports. See "Cleaning the cooktop and surface burners" in the <b>Care &amp; Cleaning</b> section for additional cleaning instructions.</li> <li>• Range power cord is disconnected from outlet (electric ignition models only). Be sure power cord is securely plugged into the power outlet.</li> <li>• Electrical power outage (electric ignition models only). Burners can be lit manually. See section on <b>Setting Surface Controls</b>.</li> </ul>
Surface burner flame only part way around burner cap.	<ul style="list-style-type: none"> <li>• Burner slots or ports are clogged. With the surface burner OFF, clean ports with a small-gauge wire or needle.</li> <li>• Moisture is present after cleaning. Lightly fan the flame &amp; allow burner to operate until flame is full. Dry the surface burners thoroughly following the instructions under "Cleaning the cooktop and surface burners" provided in the <b>Care &amp; Cleaning</b> section.</li> </ul>
Surface burner flame is orange.	<ul style="list-style-type: none"> <li>• Dust particles in main gas line. Allow the burner to operate a few minutes until flame turns blue. In coastal areas, a slightly orange flame is unavoidable due to salt air.</li> </ul>
Self-cleaning cycle does not work.	<ul style="list-style-type: none"> <li>• Oven control not set properly. Follow instructions under <b>Self-cleaning</b>.</li> <li>• Self-Cleaning cycle was interrupted. Follow steps under "Stopping or Interrupting a Self-cleaning cycle" under <b>Self-cleaning</b>.</li> </ul>



## BEFORE YOU CALL • Solutions to common problems

Problem	Solution
Soil not completely removed after self-cleaning cycle.	<ul style="list-style-type: none"><li>• Failure to clean bottom, front top of oven, frame of oven or door area outside oven seal. These areas are not in the self-cleaning area, but get hot enough to burn on residue. Clean these areas before the self-cleaning cycle is started. Burned-on residue can be cleaned with a stiff nylon brush and water or a nylon scrubber. Be careful not to damage the oven gasket.</li></ul>
Oven smokes excessively during broiling.	<ul style="list-style-type: none"><li>• Incorrect setting. Follow broiling instructions in <b>Setting Oven Controls</b>.</li><li>• Make sure oven door closed.</li><li>• Meat too close to upper burner. Reposition the broil rack to provide proper clearance between the meat &amp; the burner. Preheat the oven.</li><li>• Meat not properly prepared. Remove excess fat from meat. Cut remaining fatty edges to prevent curling, but do not cut into lean.</li><li>• Broiler pan and insert wrong side up and grease not draining. Always place grid on the broiler pan with ribs up &amp; slots down to allow grease to drip into pan (some models).</li><li>• Grease has built up on oven surfaces. Regular cleaning is necessary when broiling frequently. Old grease or food spatters cause excessive smoking.</li></ul>
Flames inside oven or smoking from oven vent.	<ul style="list-style-type: none"><li>• Excessive spillovers in oven. For example this will happen for pie spillovers or large amounts of grease left on the oven bottom. Wipe up excessive spillovers before starting oven. If flames or excessive smoke are present see "Broiling" in the <b>Setting Oven Controls</b> section.</li></ul>
Oven control panel beeps & displays any F code error (for example F10).	<ul style="list-style-type: none"><li>• Oven control has detected a fault or error condition. Press <b>CANCEL</b> to clear the display &amp; stop beeping. Try the bake or broil feature again. If the F code error repeats, remove power from appliance, wait 5 minutes and then <b>repower</b> appliance and set clock for the time of day. Try the bake or broil feature again. If the fault recurs, record fault and call for service.</li></ul>
Oven light does not work.	<ul style="list-style-type: none"><li>• Be sure the light is secure in the socket. Also see "Changing &amp; replacing the oven light" section.</li></ul>
Appliance is not level.	<ul style="list-style-type: none"><li>• Be sure floor is level, strong &amp; stable enough to adequately support range.</li><li>• If floor is sagging or sloping, contact a carpenter to correct the situation.</li><li>• Poor installation. Place oven rack in center of oven. Place a level on the oven rack. Adjust leveling legs at base of appliance until the rack is level.</li><li>• Kitchen cabinet alignment may make range appear not level. Be sure cabinets are square &amp; have sufficient room for appliance clearance.</li></ul>
Cannot move appliance easily. Appliance must be accessible for service.	<ul style="list-style-type: none"><li>• Cabinets not square or are built in too tightly. Contact builder or installer to make appliance accessible.</li><li>• Carpet interferes with appliance. Provide sufficient space so appliance can be lifted over carpet.</li></ul>



## NOTES

## MAJOR APPLIANCE WARRANTY

Your appliance is covered by a one year limited warranty. For one year from your original date of purchase, Electrolux will pay all costs for repairing or replacing any parts of this appliance that prove to be defective in materials or workmanship when such appliance is installed, used and maintained in accordance with the provided instructions.

Exclusions This warranty does not cover the following :

1. Products with original serial numbers that have been removed, altered or cannot be readily determined.
2. Product that has been transferred from its original owner to another party or removed outside the USA or Canada.
3. Rust on the interior or exterior of the unit.
4. Products purchased "as-is" are not covered by this warranty.
5. Food loss due to any refrigerator or freezer failures.
6. Products used in a commercial setting.
7. Service calls which do not involve malfunction or defects in materials or workmanship, or for appliances not in ordinary household use or used other than in accordance with the provided instructions.
8. Service calls to correct the installation of your appliance or to instruct you how to use your appliance.
9. Expenses for making the appliance accessible for servicing, such as removal of trim, cupboards, shelves, etc., which are not a part of the appliance when it is shipped from the factory.
10. Service calls to repair or replace appliance light bulbs, air filters, water filters, other consumables, or knobs, handles, or other cosmetic parts.
11. Surcharges including, but not limited to, any after hour, weekend, or holiday service calls, tolls, ferry trip charges, or mileage expense for service calls to remote areas, including the state of Alaska.
12. Damages to the finish of appliance or home incurred during installation, including but not limited to floors, cabinets, walls, etc.
13. Damages caused by: services performed by unauthorized service companies; use of parts other than genuine Electrolux parts or parts obtained from persons other than authorized service companies; or external causes such as abuse, misuse, inadequate power supply, accidents, fires, or acts of God.

### DISCLAIMER OF IMPLIED WARRANTIES; LIMITATION OF REMEDIES

CUSTOMER'S SOLE AND EXCLUSIVE REMEDY UNDER THIS LIMITED WARRANTY SHALL BE PRODUCT REPAIR OR REPLACEMENT AS PROVIDED HEREIN. CLAIMS BASED ON IMPLIED WARRANTIES, INCLUDING WARRANTIES OF MERCHANTABILITY OR FITNESS FOR A PARTICULAR PURPOSE, ARE LIMITED TO ONE YEAR OR THE SHORTEST PERIOD ALLOWED BY LAW, BUT NOT LESS THAN ONE YEAR. ELECTROLUX SHALL NOT BE LIABLE FOR CONSEQUENTIAL OR INCIDENTAL DAMAGES SUCH AS PROPERTY DAMAGE AND INCIDENTAL EXPENSES RESULTING FROM ANY BREACH OF THIS WRITTEN LIMITED WARRANTY OR ANY IMPLIED WARRANTY. SOME STATES AND PROVINCES DO NOT ALLOW THE EXCLUSION OR LIMITATION OF INCIDENTAL OR CONSEQUENTIAL DAMAGES, OR LIMITATIONS ON THE DURATION OF IMPLIED WARRANTIES, SO THESE LIMITATIONS OR EXCLUSIONS MAY NOT APPLY TO YOU. THIS WRITTEN WARRANTY GIVES YOU SPECIFIC LEGAL RIGHTS. YOU MAY ALSO HAVE OTHER RIGHTS THAT VARY FROM STATE TO STATE.

If You Need Service Keep your receipt, delivery slip, or some other appropriate payment record to establish the warranty period should service be required. If service is performed, it is in your best interest to obtain and keep all receipts. Service under this warranty must be obtained by contacting Electrolux at the addresses or phone numbers below.

This warranty only applies in the USA and Canada. In the USA, your appliance is warranted by Electrolux Major Appliances North America, a division of Electrolux Home Products, Inc. In Canada, your appliance is warranted by Electrolux Canada Corp. Electrolux authorizes no person to change or add to any obligations under this warranty. Obligations for service and parts under this warranty must be performed by Electrolux or an authorized service company. Product features or specifications as described or illustrated are subject to change without notice.

**USA**  
**1.800.944.9044**  
Electrolux Major Appliances  
North America  
P.O. Box 212378  
Augusta, GA 30907



**Canada**  
**1.800.265.8352**  
Electrolux Canada Corp.  
5855 Terry Fox Way  
Mississauga, Ontario, Canada  
L5V 3E4