

---

# MICROWAVE HOOD COMBINATION

## Use & Care Guide

For questions about features, operation/performance parts, accessories or service, call: **1-800-253-1301**.  
or visit our website at...  
[www.whirlpool.com](http://www.whirlpool.com)

---

Table of Contents ..... 2

---

**Model MH1140XM**

---

# TABLE OF CONTENTS

<b>MICROWAVE OVEN SAFETY</b> .....	<b>3</b>
Electrical Requirements .....	5
<b>PARTS AND FEATURES</b> .....	<b>5</b>
Turntable .....	5
<b>MICROWAVE OVEN CONTROL</b> .....	<b>6</b>
Display .....	6
Number Codes .....	6
Start .....	6
Cancel•Off .....	6
Add Minute .....	6
Clock .....	6
Tones .....	7
Timer .....	7
Child Lock .....	7
Vent Fan .....	7
Cooktop Light.....	7
Demo Mode.....	7
<b>MICROWAVE OVEN USE</b> .....	<b>8</b>
Food Characteristics .....	8
Cooking Guidelines .....	8
Cookware and Dinnerware .....	8
Aluminum Foil and Metal .....	9
Cooking Power.....	9
Cooking .....	10
Cooking in Stages .....	10
Popcorn .....	10
Baked Potato .....	10
Pizza .....	11
Preset Cooking.....	11
Reheating .....	11
Defrosting .....	12
<b>MICROWAVE OVEN CARE</b> .....	<b>12</b>
General Cleaning.....	12
Replacing Filters.....	13
Replacing Cooktop Light .....	13
Replacing Microwave Oven Light.....	14
<b>TROUBLESHOOTING</b> .....	<b>14</b>
<b>ASSISTANCE OR SERVICE</b> .....	<b>15</b>
Replacement Parts.....	15
<b>WARRANTY</b> .....	<b>16</b>



# MICROWAVE OVEN SAFETY

## Your safety and the safety of others are very important.

We have provided many important safety messages in this manual and on your appliance. Always read and obey all safety messages.



This is the safety alert symbol.

This symbol alerts you to potential hazards that can kill or hurt you and others.

All safety messages will follow the safety alert symbol and either the word "DANGER" or "WARNING." These words mean:

**! DANGER**

**You can be killed or seriously injured if you don't immediately follow instructions.**

**! WARNING**

**You can be killed or seriously injured if you don't follow instructions.**

All safety messages will tell you what the potential hazard is, tell you how to reduce the chance of injury, and tell you what can happen if the instructions are not followed.

## IMPORTANT SAFETY INSTRUCTIONS

When using electrical appliances basic safety precautions should be followed, including the following:

**WARNING:** To reduce the risk of burns, electric shock, fire, injury to persons, or exposure to excessive microwave energy:

- Read all instructions before using the microwave oven.
- Read and follow the specific "PRECAUTIONS TO AVOID POSSIBLE EXPOSURE TO EXCESSIVE MICROWAVE ENERGY" found in this section.
- The microwave oven must be grounded. Connect only to properly grounded outlet. See "GROUNDING INSTRUCTIONS" found in this section and in the provided Installation Instructions.
- Install or locate the microwave oven only in accordance with the provided Installation Instructions.
- Some products such as whole eggs in the shell and sealed containers – for example, closed glass jars – are able to explode and should not be heated in the microwave oven.
- Use the microwave oven only for its intended use as described in this manual. Do not use corrosive chemicals or vapors in the microwave oven. This type of oven is specifically designed to heat, cook, or dry food. It is not designed for industrial or laboratory use.
- As with any appliance, close supervision is necessary when used by children.
- Do not operate the microwave oven if it has a damaged cord or plug, if it is not working properly, or if it has been damaged or dropped.
- The microwave oven should be serviced only by qualified service personnel. Call an authorized service company for examination, repair, or adjustment.
- See door surface cleaning instructions in the "Microwave Oven Care" section.
- To reduce the risk of fire in the oven cavity:
  - Do not overcook food. Carefully attend the microwave oven when paper, plastic, or other combustible materials are placed inside the oven to facilitate cooking.
  - Remove wire twist-ties from paper or plastic bags before placing bags in oven.
  - If materials inside the oven ignite, keep oven door closed, turn oven off, and disconnect the power cord, or shut off power at the fuse or circuit breaker panel.
  - Do not use the cavity for storage purposes. Do not leave paper products, cooking utensils, or food in the cavity when not in use.

**SAVE THESE INSTRUCTIONS**

## IMPORTANT SAFETY INSTRUCTIONS

- Liquids, such as water, coffee, or tea are able to be overheated beyond the boiling point without appearing to be boiling. Visible bubbling or boiling when the container is removed from the microwave oven is not always present. **THIS COULD RESULT IN VERY HOT LIQUIDS SUDDENLY BOILING OVER WHEN THE CONTAINER IS DISTURBED OR A SPOON OR OTHER UTENSIL IS INSERTED INTO THE LIQUID.**  
To reduce the risk of injury to persons:
  - Do not overheat the liquid.
  - Stir the liquid both before and halfway through heating it.
  - Do not use straight-sided containers with narrow necks.
  - After heating, allow the container to stand in the microwave oven for a short time before removing the container.
  - Use extreme care when inserting a spoon or other utensil into the container.
- Suitable for use above both gas and electric cooking equipment.
- Intended to be used above ranges with maximum width of 36 inches.
- Clean Ventilating Hoods Frequently - Grease should not be allowed to accumulate on hood or filter.
- Oversized foods or oversized metal utensils should not be inserted in the microwave oven as they may create a fire or risk of electric shock.
- Do not clean with metal scouring pads. Pieces can burn off the pad and touch electrical parts involving a risk of electric shock.
- Do not use paper products when appliance is operated in the “PAN BROWN” mode (on models with this feature).
- Do not store any materials, other than manufacturer’s recommended accessories, in this oven when not in use.
- Do not store anything directly on top of the microwave oven when the microwave oven is in operation.
- When flaming foods under the hood, turn the fan on.
- Use care when cleaning the vent-hood filter. Corrosive cleaning agents, such as lye-based oven cleaners, may damage the filter.
- Do not cover or block any openings on the microwave oven.
- Do not store this microwave oven outdoors. Do not use the microwave oven near water - for example, near a kitchen sink, in a wet basement, or near a swimming pool, or similar locations.
- Do not immerse cord or plug in water.
- Keep cord away from heated surfaces.
- Do not let cord hang over edge of table or counter.
- Do not mount over a sink.
- Do not cover racks or any other part of the oven with metal foil. This will cause overheating of the oven.

## SAVE THESE INSTRUCTIONS

## PRECAUTIONS TO AVOID POSSIBLE EXPOSURE TO EXCESSIVE MICROWAVE ENERGY

- (a) Do not attempt to operate this oven with the door open since open-door operation can result in harmful exposure to microwave energy. It is important not to defeat or tamper with the safety interlocks.
- (b) Do not place any object between the oven front face and the door or allow soil or cleaner residue to accumulate on sealing surfaces.
- (c) Do not operate the oven if it is damaged. It is particularly important that the oven door close properly and that there is no damage to the:
  - (1) Door (bent),
  - (2) Hinges and latches (broken or loosened),
  - (3) Door seals and sealing surfaces.
- (d) The oven should not be adjusted or repaired by anyone except properly qualified service personnel.

## Electrical Requirements

### **⚠ WARNING**



#### **Electrical Shock Hazard**

**Plug into a grounded 3 prong outlet.**

**Do not remove ground prong.**

**Do not use an adapter.**

**Do not use an extension cord.**

**Failure to follow these instructions can result in death, fire, or electrical shock.**

Observe all governing codes and ordinances. A 120 Volt, 60 Hz, AC only, 15- or 20-amp fused electrical supply is required. (A time-delay fuse or circuit breaker is recommended.) It is recommended that a separate circuit serving only this appliance be provided.

### **GROUNDING INSTRUCTIONS**

#### ■ **For all cord connected appliances:**

The microwave oven must be grounded. In the event of an electrical short circuit, grounding reduces the risk of electric shock by providing an escape wire for the electric current. The microwave oven is equipped with a cord having a grounding wire with a grounding plug. The plug must be plugged into an outlet that is properly installed and grounded.

**WARNING:** Improper use of the grounding plug can result in a risk of electric shock. Consult a qualified electrician or serviceman if the grounding instructions are not completely understood, or if doubt exists as to whether the microwave oven is properly grounded.

Do not use an extension cord. If the power supply cord is too short, have a qualified electrician or serviceman install an outlet near the microwave oven.

#### ■ **For a permanently connected appliance:**

This appliance must be connected to a grounded, metallic, permanent wiring system, or an equipment grounding conductor should be run with the circuit conductors and connected to the equipment grounding terminal or lead on the appliance.

### **SAVE THESE INSTRUCTIONS**

This device complies with Part 18 of the FCC Rules.

## **PARTS AND FEATURES**

This manual may cover several different models. The model you have purchased may have some or all of the features shown here. The appearance of your particular model may differ slightly from the illustrations in this manual.

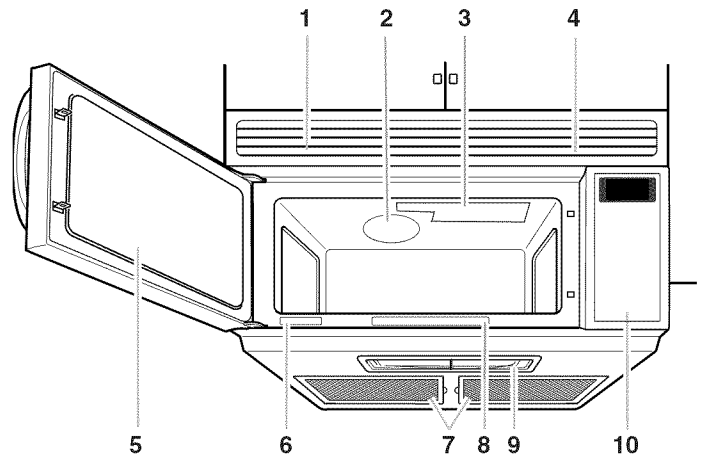

1. Charcoal Filter (behind Vent Grille)
2. Microwave Inlet Cover
3. Microwave Oven Light
4. Vent Grille
5. Metal Shielded Window
6. Model and Serial Number Plate

7. Grease Filters (shipped in oven cavity)
8. Cooking Guide Label
9. Cooktop Light
10. Control Panel

**Parts and Features not shown**  
Turntable

### **Turntable**

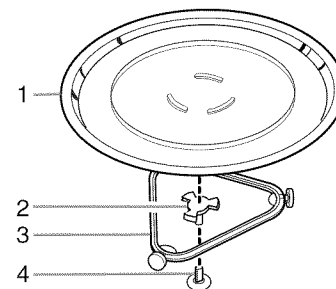

1. Turntable
2. Hub
3. Support
4. Shaft

The turntable can rotate in either direction to help cook food more evenly. Do not operate the oven without the turntable in place. See "Assistance or Service" to reorder any of the parts.

#### **To Install:**

1. Remove tape from the hub.
2. Place the support on the oven cavity bottom.
3. Place the turntable on the support.

Fit the raised, curved lines in the center of the turntable bottom between the three spokes of the hub. The rollers on the support should fit inside the turntable bottom ridge.

# MICROWAVE OVEN CONTROL

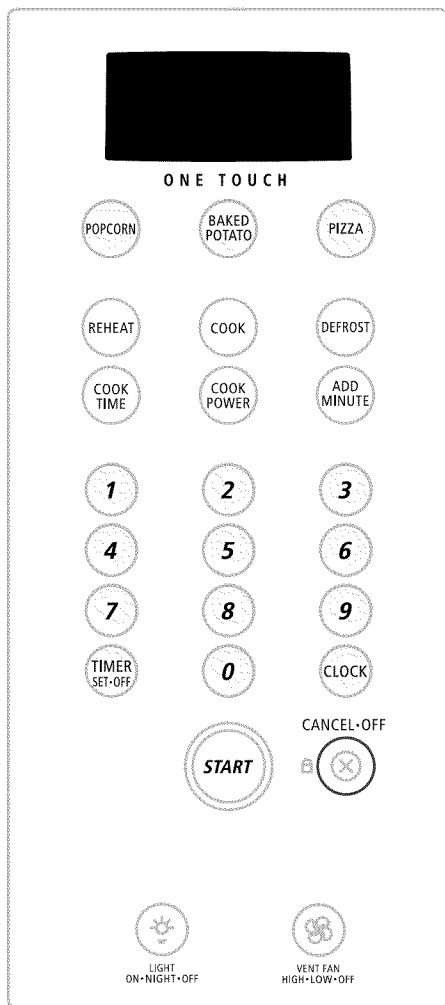

## Display

When power is first supplied to the microwave oven, a “:” will blink on the display. Touch CANCEL•OFF to stop the blinking. If the “:” blinks on the display at any other time, a power failure has occurred. Touch CANCEL•OFF and reset the clock if needed.

If “RETRY” blinks on the display for 1 second, an invalid value has been entered. Retry your entry.

When the microwave oven is in use, the display shows cooking power, quantities, weights and/or prompts. When the microwave oven is not in use, the display shows the time of day or Timer countdown.

## Number Codes

The microwave oven is preset with shortcut number codes. A number code includes one or more of the following: cooking power, cook time and food quantity or weight. See the charts in the “Cooking” and/or “Reheating” sections for additional information.

## Start

The START pad begins any function. If not touched within 5 seconds after touching a pad, “START?” will appear on the display as a reminder. If not touched within 1 minute after touching a pad, the display will return to the time of day mode and the programmed function will be canceled.

If cooking is interrupted, touching START will resume the preset cycle.

## Cancel•Off

The CANCEL•OFF pad stops most functions except for the Timer, Control Lock and Demo Mode.

The microwave oven will also turn off when the door is opened. Close the door and touch START to resume the cycle.

## Add Minute

Cook time may be added in 1-minute increments, up to 99 minutes, by touching ADD MINUTE.

Touching ADD MINUTE during a cook cycle will add 1 minute of cook time at the current cook power.

Touching ADD MINUTE when the microwave oven is not in use, or after a cook cycle has ended, will start the microwave oven for 1 minute of cook time at 100% cook power.

## Clock

This is a 12-hour clock and does not show a.m. or p.m.

### To Set:

The microwave oven and timer must be off.

1. Touch CLOCK.
2. Touch the number pads to set the time of day.
3. Touch CLOCK or START.

### To Remove:

1. Touch CLOCK.
2. Touch 0.
3. Touch CLOCK.

The time will disappear and “:” will appear on the display.

---

## Tones

Tones are audible signals, indicating the following:

### One tone

- Valid entry (short tone)
- End of Timer countdown (long tone) (on some models)

### Two tones

- End of stage in multistage cooking
- Reminder, repeat each minute after the end-of-cycle tones
- Child Lock active
- Hidden feature has been entered or exited

### Three tones

- Invalid entry

### Four tones

- End of cycle

**To Turn Off/On Valid Entry Tones:** Touch and hold the number pad “1” for 5 seconds until 2 tones sound. Repeat to turn tones back on.

**To Turn Off/On All Tones:** Touch and hold the number pad “2” for 5 seconds until 2 tones sound. Repeat to turn tones back on.

---

## Timer

The Timer can be set in minutes and seconds, up to 99 minutes 99 seconds and counts down the set time. The Timer does not start or stop the microwave oven.

When the Timer is in use, the microwave oven can also operate. To see the countdown for 5 seconds when the microwave oven is in use, touch **TIMER SET•OFF**.

### To Set:

1. Touch **TIMER SET•OFF**.

If no action is taken after 1 minute, the display will return to the time of day mode.

2. Touch the number pads to set the length of time.
3. Touch **TIMER SET•OFF** or **START**.

If not touched within 5 seconds, “START?” will appear on the display. If not touched within 1 minute, the display will return to the time of day mode and the programmed function will be canceled.

When the set time ends, “END” will appear on the display and 1 tone will sound.

4. Touch **TIMER SET•OFF** at any time to cancel the Timer.

The length of time can be changed during the countdown by repeating the above steps.

---

---

## Child Lock

The Child Lock shuts down the control panel pads to prevent unintended use of the microwave oven.

When the control is locked, only the Vent Fan and Light pads will function.

**To Lock/Unlock Control:** The microwave oven and Timer must be off. Touch and hold **CANCEL•OFF** for 5 seconds until 2 tones sound and a lock icon appears on the display. Repeat to unlock and remove the lock icon from display.

---

## Vent Fan

The vent fan has 2 speeds: high and low.

To protect the microwave oven, if the temperature from the range or cooktop below the microwave oven gets too hot, the vent fan will automatically turn on. It may stay on for up to 1 hour to cool the microwave oven. When this occurs, the Vent Fan pad will not function.

**To Turn Vent Fan On/Off:** Touch **VENT FAN HIGH/LOW/OFF** pad once for HIGH, twice for LOW or 3 times for OFF.

---

## Cooktop Light

The cooktop light has 3 settings: on, night and off.

**To Turn On/Night/Off:** Touch **LIGHT ON•NIGHT•OFF** repeatedly to cycle through settings.

---

## Demo Mode

The Demo Mode is ideal for learning how to use the microwave oven. When set, functions can be entered without actually turning on the magnetron. The microwave oven light will come on, the fan will run and, if on, the turntable will rotate.

**To Turn On/Off:** The microwave oven and Timer must be off. Touch and hold **TIMER SET•OFF** for 5 seconds until 2 tones sound and “d” appears on the display. Repeat to turn off and remove “d” from the display.

---

---

# MICROWAVE OVEN USE

A magnetron in the oven produces microwaves which reflect off the metal floor, walls and ceiling and pass through the turntable and appropriate cookware to the food. Microwaves are attracted to and absorbed by fat, sugar and water molecules in the food, causing them to move, producing friction and heat which cooks the food.

- Never lean on or allow children to swing on the oven door.
- Do not operate microwave oven when it is empty.
- The turntable must be in place and correct side up when oven is in use. Do not use if turntable is chipped or broken. See "Assistance or Service" section to reorder.
- Baby bottles and baby food jars should not be heated in the oven.
- Clothes, flowers, fruit, herbs, wood, gourds, paper, including brown paper bags and newspaper should not be dried in the oven.
- Do not use the microwave oven for canning, sterilizing or deep frying. The oven cannot maintain appropriate temperatures.
- Paraffin wax will not melt in the oven because it does not absorb microwaves.
- Use oven mitts or pot holders when removing containers from oven.
- Do not overcook potatoes. At the end of the recommended cook time, potatoes should be slightly firm. Let potatoes stand for 5 minutes. They will finish cooking while standing.
- Do not cook or reheat whole eggs inside the shell. Steam buildup in whole eggs may cause them to burst. Cover poached eggs and allow a standing time.

---

## Food Characteristics

When microwave cooking, the amount, size and shape, starting temperature, composition and density of the food affect cooking results.

### Amount of Food

The more food heated at once, the longer the cook time. Check for doneness and add small increments of time if necessary.

### Size and Shape

Smaller pieces of food will cook more quickly than larger pieces, and uniformly shaped foods cook more evenly than irregularly shaped food.

### Starting Temperature

Room temperature foods will heat faster than refrigerated foods, and refrigerated foods will heat faster than frozen foods.

### Composition and Density

Foods high in fat and sugar will reach a higher temperature and heat faster than other foods. Heavy, dense foods, such as meat and potatoes, require a longer cook time than the same size of a light, porous food, such as cake.

---

## Cooking Guidelines

### Covering

Covering food helps retain moisture, shorten cook time and reduce spattering. Use the lid supplied with cookware. If a lid is not available, wax paper, paper towels or plastic wrap approved for microwave ovens may be used. Plastic wrap should be turned back at one corner to provide an opening to vent steam.

### Stirring and Turning

Stirring and turning redistributes heat evenly to avoid overcooking the outer edges of food. Stir from outside to center. If possible, turn food over from bottom to top.

### Arranging

If heating irregularly shaped or different sized foods, the thinner parts and smaller sizes should be arranged toward the center. If cooking several items of the same size and shape, place them in a ring pattern, leaving the center of the ring empty.

### Piercing

Before heating, use a fork or small knife to pierce or prick foods that have a skin or membrane, such as potatoes, egg yolks, chicken livers, hot dogs, and sausage. Prick in several places to allow steam to vent.

### Shielding

Use small, flat pieces of aluminum foil to shield the thin pieces of irregularly shaped foods, bones and foods such as chicken wings, leg tips and fish tail. See "Aluminum Foil and Metal" first.

### Standing Time

Food will continue to cook by the natural conduction of heat even after the microwave cycle ends. The length of standing time depends on the volume and density of the food.

---

## Cookware and Dinnerware

Cookware and dinnerware must fit on the turntable. Always use oven mitts or pot holders when handling because any dish may become hot from heat transferred from the food. Do not use cookware and dinnerware with gold or silver trim. Use the following chart as a guide, then test before using.

MATERIAL	RECOMMENDATIONS
Aluminum Foil, Metal	See "Aluminum Foil and Metal" section.
Browning Dish	Bottom must be at least $\frac{3}{16}$ in. (5 mm) above the turntable. Follow manufacturer's recommendations.
Ceramic Glass, Glass	Acceptable for use.
China, Earthenware	Follow manufacturer's recommendations.
Melamine	Follow manufacturer's recommendations.
Paper Towels, Dinnerware, Napkins	Use nonrecycled and those approved by the manufacturer for microwave oven use.



MATERIAL	RECOMMENDATIONS
Plastic Wraps, Bags, Covers, Dinnerware, Containers	Use those approved by the manufacturer for microwave oven use.
Pottery and Clay	Follow manufacturer's recommendations.
Styrofoam*	Do not use in oven.
Straw, Wicker, Wooden Containers	Do not use in oven.
Wax Paper	Acceptable for use.

#### To Test Cookware or Dinnerware for Microwave Use:

- Put cookware or dinnerware in oven with 1 cup (250 mL) of water beside it.
- Cook at 100% cooking power for 1 minute.

Do not use cookware or dinnerware if it becomes hot and the water stays cool.

### Aluminum Foil and Metal

Always use oven mitts or pot holders when removing dishes from the microwave oven.

Aluminum foil and some metal can be used in the oven. If not used properly, arcing (a blue flash of light) can occur and cause damage to the oven.

#### OK for Use

Racks and bakeware supplied with the oven (if supplied), aluminum foil for shielding, and approved meat thermometers may be used with the following guidelines:

- Never allow aluminum foil or metal to touch the inside cavity walls, ceiling or floor.
- Always use the turntable.
- Never allow contact with another metal object during cooking.

#### Do Not Use

Metal cookware and bakeware, gold, silver, pewter, non-approved meat thermometers, skewers, twist ties, foil liners such as sandwich wrappers, staples and objects with gold or silver trim or a metallic glaze should not be used in the oven.

### Cooking Power

Many recipes for microwave cooking specify which cooking power to use by percent, name or number. For example, 70%=7=Medium-High.

Use the following chart as a general guide for the suggested cooking power of specific foods.

PERCENT/ NAME	NUMBER	USE
100%, High (default setting)	10	Quick heating convenience foods and foods with high water content, such as soups, beverages and most vegetables.
90%	9	Cooking small tender pieces of meat, ground meat, poultry pieces and fish fillets. Heating cream soups.
80%	8	Heating rice, pasta or casseroles. Cooking and heating foods that need a cook power lower than high. For example, whole fish and meat loaf.
70%, Medium-High	7	Reheating a single serving of food.
60%	6	Cooking sensitive foods such as cheese and egg dishes, pudding and custards. Cooking nonstirtable casseroles, such as lasagna.
50%, Medium	5	Cooking ham, whole poultry and pot roasts. Simmering stews.
40%	4	Melting chocolate. Heating bread, rolls and pastries.
30%, Medium-Low, Defrost	3	Defrosting bread, fish, meats, poultry and precooked foods.
20%	2	Softening butter, cheese, and ice cream.
10%, Low	1	Taking chill out of fruit.

---

## Cooking

### To Use:

1. Touch COOK TIME.  
Touch number pads to enter cooking time.
2. Touch COOK POWER.  
Touch number pads to enter power level, if other than 100%.
3. Touch START.  
The display will count down the cook time.  
  
When the cycle ends, "END" will appear in the display, 4 end-of-cycle tones will sound, and then reminder tones will sound every minute.
4. Touch CANCEL•OFF or open the door to clear the display and/or stop reminder tones.

The cook time and power may be changed after touching START without interrupting cooking.

**To Change Cook Time:** Touch COOK TIME. The countdown will freeze for a few seconds. Enter the new cook time and touch START or wait a few seconds for the countdown to resume.

**To Change Cook Power:** Touch COOK POWER repeatedly to scroll through the cook power levels. Touch START.

---

## Cooking in Stages

The microwave oven can be set to cook at different cooking powers for various lengths of time, up to 3 stages.

### To Cook in Stages:

1. Touch COOK TIME.
2. Touch number pads to enter length of time to cook during the 1st stage.
3. Touch COOK POWER.
4. Touch the number pad(s) using the Cooking Power chart to set the cooking power for the 1st stage.
5. Repeat steps 1-4 for the 2nd and 3rd stages.
6. Touch START.

The display will count down each of the cook times. The numbers "1," "2" and "3" will appear on the display during their respective stages.

When the cycle ends, "END" will appear in the display, 4 end-of-cycle tones will sound, and then reminder tones will sound every minute.

7. Touch CANCEL•OFF or open the door to clear the display and/or stop reminder tones.

The cook time and cook power of the cycling stage can be changed after touching START without interrupting cooking.

**To Change Cook Time:** Touch COOK TIME. The countdown will freeze for a few seconds. Enter the new cook time and touch START or wait a few seconds for the countdown to resume.

**To Change Cook Power:** Touch COOK POWER repeatedly to scroll through the cook power levels. Touch START.

---

## Popcorn

- Do not use regular paper bags or glassware.
  - Pop only one package of popcorn at a time.
  - Follow manufacturer's instructions when using a microwave popcorn popper.
  - Listen for popping to slow to 1 pop every 1 or 2 seconds, then stop the cycle. Do not repop unpopped kernels.
  - Use fresh bags of popcorn for optimal results.
  - Cooking results may vary by brand and fat content.
- Popping time has been preset based on commercially packaged microwave popcorn.

### To Use POPCORN:

1. Touch POPCORN.  
Display will show setting for 3.5 oz. (99 g) bag.
2. Touch POPCORN a second time for 3.0 oz. (85 g) bag, and a third time for 1.75 oz. (50 g) bag.  
The microwave oven will start 5 seconds after selecting the appropriate bag size. The display will count down the popping time.

If more or less time is required, touch COOK POWER before the oven starts cooking.

When the popcorn cycle ends, "END" will appear in the display, 4 end-of-cycle tones will sound, and then reminder tones will sound every minute.

3. Touch CANCEL•OFF or open the door to clear the display and/or stop reminder tones.
- 

## Baked Potato

One or more 10 oz (283 g) potatoes can be baked automatically in the microwave oven by using the Baked Potato function.

### To Bake Potatoes:

1. Touch BAKED POTATO.
2. Touch the number pads to enter the number of potatoes to bake.
3. Touch START

or

The microwave oven will start 3 seconds after the appropriate number of potatoes is selected.

If more or less time is required, touch COOK POWER before the oven starts cooking.

The display will count down the cook time.

When the cycle ends, "END" will appear in the display, 4 end-of-cycle tones will sound, and then reminder tones will sound every minute.

4. Touch CANCEL•OFF or open the door to clear the display and/or stop reminder tones.

---

## Pizza

Up to 3 pizza slices may be heated in the microwave oven by using the Pizza function.

### To Use Pizza:

1. Touch PIZZA.  
The display will show the setting for heating 1 slice.
2. Touch PIZZA a second time to heat 2 slices, or a third time to heat 3 slices.  
The microwave oven will start 5 seconds after the appropriate number of slices to be heated is selected. The display will count down the cook time.  
If more or less time is required, touch COOK POWER before the oven starts cooking.  
When the cycle ends, "END" will appear in the display, 4 end-of-cycle tones will sound, and then reminder tones will sound every minute.
3. Touch CANCEL•OFF or open the door to clear the display and/or stop reminder tones.

---

## Preset Cooking

Times and cooking power have been preset for certain microwavable foods. Use the following chart as a guide.

FOOD	PAD	QUANTITY
Rice	1	.5-2 cups (125-500 mL)
Fresh Vegetables	2	1-4 cups (250 mL-1 L)
Frozen Vegetables	3	1-4 cups (250 mL-1 L)
Canned Vegetables	4	1-4 cups (250 mL-1 L)
Bacon*	5	1-6 slices, average thickness
Frozen Entrée	6	10 oz or 20 oz (283 g or 567 g)

\*Differences in the amount of fat, meat, thickness, and curing process affect results. Average is 16 slices per pound.

### To Use Preset Cooking:

1. Touch COOK.
2. Touch number pad from chart  
or  
Touch COOK repeatedly to scroll through foods.
3. Touch number pads to enter quantity.  
Doneness may be adjusted at this time by touching COOK POWER.
4. Touch START.  
The display will count down the cook time.  
When the cycle ends, "END" will appear in the display, 4 end-of-cycle tones will sound, and then reminder tones will sound every minute.
5. Touch CANCEL•OFF or open the door to clear the display and/or stop reminder tones.

---

## Reheating

Times and cooking power have been preset for reheating specific food types. Use the following chart as a guide.

FOOD	PAD	QUANTITY
Soup/Sauce	1	1-4 cups (250 mL-1 L)
Casserole	2	1-4 cups (250 mL-1 L)
Baked Goods	3	1-6 pieces
Dinner Plate	4	1 serving

### To Use Reheat:

1. Touch REHEAT.
2. Touch number pads to select type of food from chart  
or  
Touch REHEAT repeatedly to scroll through foods.
3. Touch number pads to enter quantity.  
Doneness may be adjusted at this time by touching COOK POWER.
4. Touch START.  
The display will count down the reheat time.  
When the cycle ends, "END" will appear in the display, 4 end-of-cycle tones will sound, and then reminder tones will sound every minute.
5. Touch CANCEL•OFF or open the door to clear the display and/or stop reminder tones.

---

## Defrosting

The Auto Defrost feature can be used or the microwave oven can be manually set to defrost.

- Food should be 0°F (-18°C) or colder at defrosting for optimal results.
- Unwrap foods and remove lids (from fruit juice) before defrosting.
- Shallow packages will defrost more quickly than deep blocks.
- Separate food pieces as soon as possible during or at the end of cycle for more even defrosting.
- Use small pieces of aluminum foil to shield parts of food such as chicken wings, leg tips and fish tails. See “Aluminum Foil and Metal” first.

The Auto Defrost system has 3 categories: Meat, Poultry and Fish. It should not be used for food left outside the freezer more than 20 minutes and frozen ready-made food. Use the following chart as a guide.

---

### MEAT

<i>Beef:</i> ground, steaks, roast, stew	The narrow or fatty areas of irregular shaped cuts should be shielded with foil before defrosting.
<i>Lamb:</i> stew and chops	
<i>Pork:</i> chops, ribs, roasts, sausage	Do not defrost less than ¼ lb (113 g) or two 4 oz (113 g) patties. Place all meats in microwavable baking dish.

---

### POULTRY

<i>Chicken:</i> whole and cut up	Place in microwavable baking dish, chicken breast-side up.
<i>Cornish hens</i>	
<i>Turkey:</i> breast	Remove giblets from whole chicken.

---

### FISH

<i>Fillets, Steaks, Whole, Shellfish</i>	Place in microwavable baking dish.
------------------------------------------	------------------------------------

---

### To Use Auto Defrost:

1. Touch DEFROST.
2. Touch the number pad 1 for Meat, 2 for Poultry or 3 for Fish or  
Touch DEFROST repeatedly to scroll through foods.
3. Touch the number pads to enter the weight.  
Meats and Poultry can be set from .1 to 6.6 lb (45 g to 3 kg).  
Fish can be set from .1 to 4.4 lb (45 g to 2 kg).  
Doneness may be adjusted at this time by touching COOK POWER.
4. Touch START.  
The display will count down the defrost time.  
When the cycle ends, “END” will appear in the display, 4 end-of-cycle tones will sound, and then reminder tones will sound every minute.
5. Touch CANCEL•OFF or open the door to clear the display and/or stop reminder tones.

### To Defrost Manually:

1. Touch COOK TIME.
2. Touch the number pads to set a length of time to defrost.
3. Touch COOK POWER.
4. Touch number pad 3.
5. Touch START.  
The display will count down the defrost time.  
When the cycle ends, “END” will appear in the display, 4 end-of-cycle tones will sound, and then reminder tones will sound every minute.
6. Touch CANCEL•OFF or open the door to clear the display and/or stop reminder tones.

---

## MICROWAVE OVEN CARE

### General Cleaning

**IMPORTANT:** Before cleaning, make sure all controls are off and the oven is cool. Always follow label instructions on cleaning products.

Soap, water and a soft cloth or sponge are suggested first unless otherwise noted.

---

### GREASE FILTERS

Do not operate the microwave oven without the grease filters in place.

Soak grease filters in hot water and mild detergent. Scrub and swish to remove embedded dirt. Rinse well and shake dry.

- Do not use ammonia or oven cleaner.
- Do not place in dishwasher.

---

## OVEN CAVITY

---

Do not use soap-filled scouring pads, abrasive cleaners, steel-wool pads, gritty washcloths or some recycled paper towels. Damage may occur.

The area where the oven door and frame touch when closed should be kept clean.

### Average soil

- Mild, nonabrasive soaps and detergents:

Rinse with clean water and dry with soft, lint-free cloth.

### Heavy soil

- Mild, nonabrasive soaps and detergents:

Heat 1 cup (250 mL) of water for 2 to 5 minutes in oven. Steam will soften soil. Rinse with clean water and dry with soft, lint-free cloth.

### Odors

- Lemon juice or vinegar:

Heat 1 cup (250 mL) of water with 1 tbsp (15 mL) of either lemon juice or vinegar for 2 to 5 minutes in oven.

---

## OVEN DOOR EXTERIOR

---

- Glass cleaner and paper towels or nonabrasive plastic scrubbing pad:

Apply glass cleaner to soft cloth or sponge, not directly on panel.

---

## TURNTABLE

---

Replace turntable immediately after cleaning. Do not operate the microwave oven without the turntable in place.

- Mild cleanser and scouring pad
- Dishwasher

---

## Replacing Filters

The grease filters should be removed and cleaned at least once a month. Do not operate the microwave oven or exhaust fan without the grease filters in place. The charcoal filters cannot be washed and should be replaced every 6 to 12 months. See "General Cleaning" for cleaning instructions. See "Assistance or Service" to reorder filters.

### To Remove and Replace Grease Filters:

1. Unplug microwave oven or disconnect power.
2. Remove each grease filter by sliding filter to the end. Pull tab down until the filter drops out.

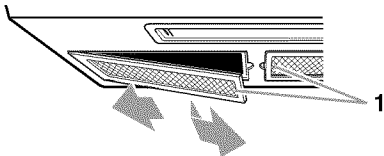

1. Tabs

3. Replace grease filter by inserting one end of the filter into the outer end of the frame. Swing the other end up and slide into position.
4. Plug in microwave oven or reconnect power.

### To Remove and Replace Charcoal Filter:

1. Unplug microwave oven or disconnect power.
2. Remove the 2 mounting screws located above the cover. Then loosen the 2 inner screws.

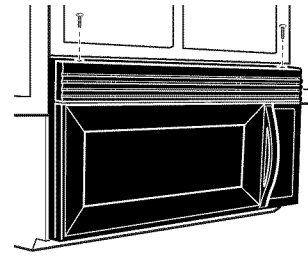

3. Tilt vent grille forward and lift to remove.
4. Slide filter back slightly, lift front end, and pull filter out.

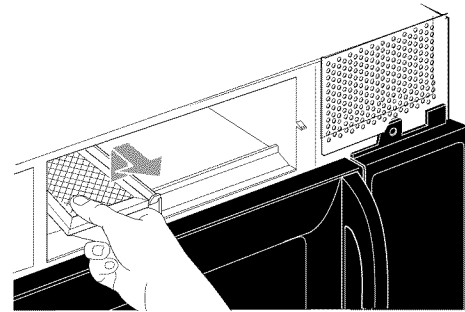

5. Install new charcoal filter.
6. Replace vent grille and mounting screws.
7. Plug in microwave oven or reconnect power.

---

## Replacing Cooktop Light

The cooktop light is a candelabra base 30-watt bulb. See "Assistance or Service" section to reorder.

### To Replace:

1. Unplug microwave oven or disconnect power.
2. Remove the bulb cover mounting screw.

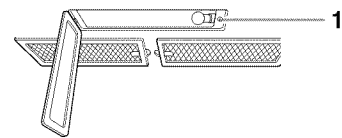

1. Mounting screw

3. Replace light. Close bulb cover. Replace mounting screw.
4. Plug in microwave oven or reconnect power.

---

## Replacing Microwave Oven Light

The microwave oven light is a candelabra base 30-watt bulb. It will automatically come on when the door is opened and when the microwave oven is operating. See "Assistance or Service" section to reorder.

### To Replace:

1. Unplug microwave oven or disconnect power.
2. Remove the 2 outer vent grille mounting screws located above the cover.

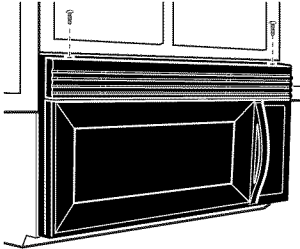

3. Tip the grille forward, then lift out to remove.

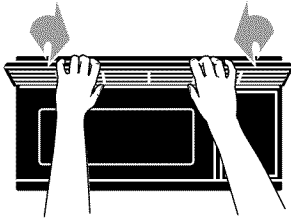

4. Lift up the bulb cover.

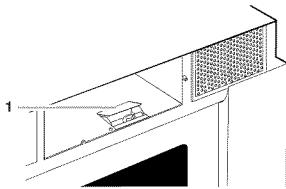

1. Bulb cover

5. Replace light. Close bulb cover.
6. Reattach vent grille. Replace the mounting screws.

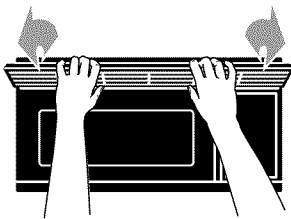

7. Plug in microwave oven or reconnect power.

---

## TROUBLESHOOTING

Try the solutions suggested here first in order to avoid the cost of an unnecessary service call.

---

### Nothing will operate

- **Has a household fuse blown or has the circuit breaker tripped?**  
Replace the fuse or reset the circuit.
- **Is the appliance wired properly?**  
See Installation Instructions.

---

### Oven will not operate

- **Is the door completely closed?**  
Firmly close door.
- **Is a spacer (on some models) attached to the inside of the door?**  
Remove spacer, then firmly close door.
- **Is the electronic oven control set correctly?**  
See "Microwave Oven Control" section.
- **On some models, is the Child Lock set?**  
See "Child Lock" section.
- **Is the magnetron working properly?**  
Try to heat 1 cup (250 mL) of cold water for 2 minutes at 100% cooking power. If water does not heat, call for service. See "Assistance or Service" section.

---

### Oven makes humming noise

- This is normal and occurs when the power supply switches the magnetron on and off.

---

### Oven door looks wavy

- This is normal and will not affect performance.

---

### Turntable will not operate

- **Is the turntable properly in place?**  
Make sure turntable is correct-side up and is sitting securely on the turntable support.
- **Is the turntable support operating properly?**  
Remove turntable. Remove and replace turntable support. Replace turntable. Place 1 cup (250 mL) of water on the turntable, then restart oven. If it still is not working, call for service. See "Assistance or Service" section. Do not operate the oven without turntable and turntable support working properly.

---

### Turntable rotates both directions

- This is normal and depends on motor rotation at beginning of cycle.

---

## Display shows messages

---

- **Is the display showing “:”?**  
There has been a power failure or the clock time has been turned off. See “Display” section to clear display. See “Clock” section to reset the clock or to turn it on.
- **Is the display showing a letter followed by a number?**  
See “Display” section to clear. If it reappears, call for service. See “Assistance or Service” section.

---

## Display shows time countdown, but is not operating

---

- **Is the Timer in use?**  
See “Timer” section.
- **On some models, is the Demo Mode in use?**  
See “Demo Mode” section.

---

## Tones are not sounding

---

- **Are tones turned off?**  
See “Tones” section.

---

## Steam is coming from the vent grille

---

- Some steam is normal.

---

## Fan running slower than usual

---

- **Has the oven has been stored in a cold area?**  
The fan will run slower until the oven warms up to normal room temperature.

---

## Fan running during cooking

---

- This is normal. Fan comes on at low speed to cool the oven.

---

## Cooking times seem too long

---

- **Is the cooking power set properly?**  
See “Cooking Power” section.
- **Are large amounts of food being heated?**  
Larger amounts of food need longer cooking times.
- **Is the incoming voltage less than specified in “Microwave Oven Safety?”**  
Have a qualified electrician check the electrical system in the home.

---

## Radio or TV Interference

---

- **Is the microwave oven plugged into the same outlet?**  
Try a different outlet.
- **Is the radio or TV receiver near the microwave oven?**  
Move the receiver away from the microwave oven, or adjust the radio or TV antenna.
- **Are the microwave oven door and sealing surfaces clean?**  
Make sure these areas are clean.

---

# ASSISTANCE OR SERVICE

Before calling for assistance or service, please check “Troubleshooting.” It may save you the cost of a service call. If you still need help, follow the instructions below.

When calling, please know the purchase date and the complete model and serial number of your appliance. This information will help us to better respond to your request.

---

## If you need replacement parts

If you need to order replacement parts, we recommend that you only use FSP® replacement parts. FSP® replacement parts will fit right and work right because they are made with the same precision used to build every new WHIRLPOOL® appliance.

To locate FSP® replacement parts in your area, call our Customer Interaction Center telephone number or your nearest Whirlpool designated service center.

---

## In the U.S.A.

Call the Whirlpool Customer Interaction Center toll free: **1-800-253-1301**.

### Our consultants provide assistance with:

- Features and specifications on our full line of appliances.
- Installation information.
- Use and maintenance procedures.
- Accessory and repair parts sales.
- Specialized customer assistance (Spanish speaking, hearing impaired, limited vision, etc.).
- Referrals to local dealers, repair parts distributors, and service companies. Whirlpool designated service technicians are trained to fulfill the product warranty and provide after-warranty service, anywhere in the United States.

To locate the Whirlpool designated service company in your area, you can also look in your telephone directory Yellow Pages.

### For further assistance

If you need further assistance, you can write to Whirlpool Corporation with any questions or concerns at:

Whirlpool Brand Home Appliances  
Customer Interaction Center  
553 Benson Road  
Benton Harbor, MI 49022-2692

Please include a daytime phone number in your correspondence.

---

## Replacement Parts

Turntable  
Part No. 4393799

Turntable Support and Rollers  
Part No. 8184102

Turntable Hub  
Part No. 8183949

Grease Filters  
Part No. 4393790

Charcoal Filters  
Part No. 8184958

Cooktop & Microwave  
Light Bulb  
Part No. 4393681

---

# WHIRLPOOL® MICROWAVE HOOD COMBINATION WARRANTY

---

## ONE-YEAR FULL WARRANTY

For one year from the date of purchase, when this appliance is operated and maintained according to instructions attached to or furnished with the product, Whirlpool Corporation will pay for FSP® replacement parts and repair labor to correct defects in materials or workmanship. Service must be provided by a Whirlpool designated service company.

---

## SECOND THROUGH FIFTH YEAR LIMITED WARRANTY ON MAGNETRON TUBE

In the second through fifth years from the date of purchase, when this appliance is operated and maintained according to instructions attached to or furnished with the product, Whirlpool Corporation will pay for FSP® replacement parts for the microwave magnetron tube if defective in materials or workmanship.

---

### Whirlpool Corporation will not pay for:

1. Service calls to correct the installation of your appliance, to instruct you how to use your appliance, to replace house fuses or correct house wiring, or to replace owner-accessible light bulbs and filters.
  2. Repairs when your appliance is used in other than normal, single-family household use.
  3. Pickup and delivery. Your appliance is designed to be repaired in the home.
  4. Damage resulting from accident, alteration, misuse, abuse, fire, flood, improper installation, acts of God or use of products not approved by Whirlpool Corporation.
  5. Repairs to parts or systems resulting from unauthorized modifications made to the appliance.
  6. Replacement parts or repair labor costs for units operated outside the United States.
  7. Any labor costs during the limited warranty period.
- 

### WHIRLPOOL CORPORATION SHALL NOT BE LIABLE FOR INCIDENTAL OR CONSEQUENTIAL DAMAGES.

Some states do not allow the exclusion or limitation of incidental or consequential damages, so this exclusion or limitation may not apply to you. This warranty gives you specific legal rights and you may also have other rights which may vary from state to state.

**Outside the 50 United States, this warranty does not apply. Contact your authorized Whirlpool dealer to determine if another warranty applies.**

If you need service, first see the "Troubleshooting" section of this book. After checking "Troubleshooting," additional help can be found by checking the "Assistance or Service" section or by calling the Whirlpool Customer Interaction Center, **1-800-253-1301** (toll-free), from anywhere in the U.S.A.

5/00

---

**Keep this book and your sales slip together for future reference. You must provide proof of purchase or installation date for in-warranty service.**

Write down the following information about your appliance to better help you obtain assistance or service if you ever need it. You will need to know your complete model number and serial number. You can find this information on the model and serial number label/plate, located on your appliance as shown in the "Parts and Features" section.

Dealer name \_\_\_\_\_

Address \_\_\_\_\_

Phone number \_\_\_\_\_

Model number \_\_\_\_\_

Serial number \_\_\_\_\_

Purchase date \_\_\_\_\_

