

APG3075

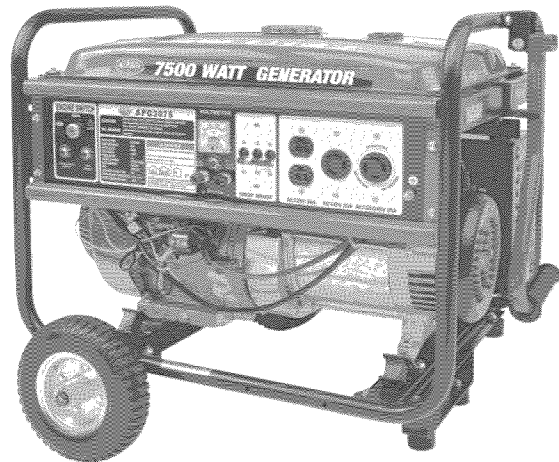

Owner's Manual 7500 W Generator



Warning To Reduce The Risk Of Injury, User Must
Read And Understand Instruction Manual.

HAVE QUESTIONS OR NEED SERVICE
DO NOT RETURN TO STORE!
Canada: 866-882-8088
USA: 888.896.6881



www.allpoweramerica.com

7500W Generator

Table of Contents

Topic	Page
Limited Warranty	3
Safety Guidelines	5
General Precautions	6
Battery	15
Assembly	16
Operation	19
Inspection, Cleaning and Maintenance	25
Installation	26
Compliance	28
Specifications	29
General Parts Listing	30



WARNING! READ AND UNDERSTAND ALL SAFETY PRECAUTIONS IN THIS MANUAL BEFORE OPERATING. FAILURE TO COMPLY WITH INSTRUCTIONS IN THIS MANUAL COULD RESULT IN PERSONAL INJURY, PROPERTY DAMAGE, AND/ OR VOIDING OF YOUR WARRANTY. ALL POWER AMERICA WILL NOT BE LIABLE FOR ANY DAMAGE BECAUSE OF FAILURE TO FOLLOW THESE INSTRUCTIONS.

Owner's Manual

Limited Warranty

All-Power America warrants to the original purchaser who uses the product in a consumer application (personal, residential or household usage) that all products covered under this warranty are free from defects in material and workmanship for one year from the date of purchase. All products covered by this limited warranty which are used in commercial applications (i.e. income producing) are warranted to be free of defects in material and workmanship for 90 days from the date of original purchase. Products covered under this warranty include air compressors, air tools, service parts, pressure washers and generators.

All-Power America will repair or replace, at All-Power America's sole option, products or components which have failed within the warranty period. Service will be scheduled according to the normal work flow and business hours at the service center location, and the availability of replacement parts. All decisions of All-Power America with regard to this limited warranty shall be final.

This warranty gives you specific legal rights, and you may also have other rights which vary from state to state.

RESPONSIBILITY OF ORIGINAL PURCHASER (initial User):

To process a warranty claim on this product, DO NOT return item to the retailer. The product must be evaluated by an Authorized Warranty Service Center. For the location of the nearest Authorized Warranty Service Center contact the retailer or place of purchase.

Retain original cash register sales receipt as proof of purchase for warranty to work.

Use reasonable care in the operation and maintenance of the product as described in the Owner's Manual(s).

Deliver or ship the product to the Authorized Warranty Service Center. Freight costs, if any must be paid by the purchaser.

If the purchaser does not receive satisfactory results from the Authorized Warranty Service Center, the purchaser should contact All-Power America.

7500W Generator

Limited Warranty (cont'd)

THIS WARRANTY DOES NOT COVER:

- Merchandise sold as reconditioned, used as rental equipment, or floor or display models.
- Merchandise that has become damaged or inoperative because of ordinary wear, misuse, cold, heat, rain, excessive humidity, freeze damage, use of improper chemicals, negligence, accident, failure to operate the product in accordance with the instructions provided in the Owner's Manual(s) supplied with the product, improper maintenance, the use of accessories or attachments not recommended by All-Power America, or unauthorized repair or alterations.
- Repair and transportation costs of merchandise determine not to be defective.
- Costs associated with assembly, required oil, adjustments or other installation and start-up costs.
- Expendable parts or accessories supplied with the product which are expected to become inoperative or unusable after a reasonable period of use.
- Merchandise sold by All-Power America which has been manufactured by and identified as the product of another company, such as gasoline engines. The product manufacturer's warranty, if any, will apply.
- ANY INCIDENTAL, INDIRECT OR CONSEQUENTIAL LOSS, DAMAGE, OR EXPENSE THAT MAY RESULT FROM ANY DEFECTS, FAILURE OR MALFUNCTION OF THE PRODUCT IS NOT COVERED BY THIS WARRANTY. Some states do not allow the exclusion, so it may not apply to you.
- IMPLIED WARRANTIES, INCLUDING THOSE OF MERCHANTABILITY OR FITNESS FOR A PARTICULAR PURPOSE, ARE LIMITED TO ONE YEAR FROM THE DATE OF ORIGINAL PURCHASE. Some states do not allow limitations on how long an implied warranty lasts, so the above limitations may not apply to you.

Owner's Manual

Safety Guidelines - Definitions

This manual contains important information that you need to know and understand in order to protect YOUR SAFETY and to PREVENT EQUIPMENT PROBLEMS. The following symbols help you recognize this information. Please read the manual and pay attention to these sections.

Save These Important Safety Instructions!

Read and understand all of these safety instructions. Be sure to retain them for future use.



WARNING! WARNINGS INDICATE A CERTAINTY OR STRONG POSSIBILITY OF PERSONAL INJURY OR DEATH IF INSTRUCTIONS ARE NOT FOLLOWED.



CAUTION: CAUTIONS INDICATE A POSSIBILITY OF EQUIPMENT DAMAGE IF INSTRUCTIONS ARE NOT FOLLOWED.



NOTE: NOTES GIVE HELPFUL INFORMATION



WARNING! IMPROPER OPERATION OR MAINTENANCE OF THIS PRODUCT COULD RESULT IN SERIOUS INJURY AND PROPERTY DAMAGE. READ AND UNDERSTAND ALL WARNINGS AND OPERATING INSTRUCTIONS BEFORE USING THIS EQUIPMENT. WHEN USING AIR TOOLS, BASIC SAFETY PRECAUTIONS SHOULD ALWAYS BE FOLLOWED TO REDUCE THE RISK OF PERSONAL INJURY.

7500W Generator

General Precautions



WARNING! FAILURE TO FOLLOW THESE INSTRUCTIONS CAN RESULT IN SEVERE INJURY OR DEATH.



DANGER Carbon Monoxide

Using a generator indoors WILL KILL YOU IN MINUTES.



Carbon Monoxide

Generator exhaust contains high levels of carbon monoxide (CO), a poisonous gas you cannot see or smell. If you can smell the generator exhaust, you are breathing CO. But even if you cannot smell the exhaust, you could be breathing CO.

- NEVER use a generator inside homes, garages, crawlspaces, or other partly enclosed areas. Deadly levels of carbon monoxide can build up in these areas. Using a fan or opening windows and doors does NOT supply enough fresh air.
- ONLY use a generator outdoors and far away from open windows, doors, and vents. These openings can pull in generator exhaust.

Even when you use a generator correctly, CO may leak into the home. ALWAYS use a battery-powered or battery-backup CO alarm in the home.

If you start to feel sick, dizzy, or weak after the generator has been running, move to fresh air RIGHT AWAY. See a doctor. You could have carbon monoxide poisoning.

Gasoline and Oil



This product requires oil and fuel. Attempting to start the engine without oil will ruin the engine and void the warranty. Work in well ventilated area. Keep cigarettes, flames or sparks away from the work area or where gasoline is stored.



WARNING! GASOLINE IS EXTREMELY FLAMMABLE AND IS EXPLOSIVE UNDER CERTAIN CONDITIONS. KEEP OUT OF REACH OF CHILDREN.

- Gasoline fuel and fumes are flammable and potentially explosive. Use proper fuel storage and handling procedures. Always have multiple ABC class fire extinguishers nearby.
- Keep the generator and surrounding area clean at all times.
- Fuel or oil spills must be cleaned up immediately. Dispose of fluids and cleaning materials as per any local, state, or federal codes and regulations. Store oily rags in a covered metal container.
- Never store fuel or other flammable materials near the generator.

Owner's Manual

General Precautions (cont'd)

Gasoline and Oil (cont'd)

- Do not smoke, or allow sparks, flames or other sources of ignition around the engine and fuel tank. Fuel vapors are explosive.
- Keep grounded conductive objects, such as tools, away from exposed, live electrical parts and connections to avoid sparking or arcing. These events could ignite fumes or vapors.
- Do not refill the fuel tank while the engine is running or while the engine is still hot. Do not operate the generator with known leaks in the fuel system
- Excessive buildup of unburned fuel gases in the exhaust system can create a potentially explosive condition. This buildup can occur after repeated failed start attempts, valve testing, or hot engine shutdown. If this occurs, open exhaust system drain plugs, if equipped, and allow the gases to dissipate before attempting to restart the generator.
- Use only engine manufacturer recommended fuel and oil.

Hot Components



WARNING! ENGINE AND EXHAUST SYSTEM PARTS BECOME VERY HOT AND REMAIN HOT FOR SOME TIME AFTER THE ENGINE IS RUN. WEAR INSULATED GLOVES OR WAIT UNTIL THE ENGINE AND EXHAUST SYSTEM HAVE COOLED BEFORE HANDLING THESE PARTS.

7500W Generator

General Precautions (cont'd)

Work Area

- Keep your work area clean and well lit. Cluttered benches and dark areas invite accidents.
- Do not operate power tools in explosive atmospheres, such as in the presence of flammable liquids, gases, or dust. Generators create sparks which may ignite the dust or fumes.
- Keep bystanders, children, and visitors away while operating a generator. Provide barriers or shields as needed.

Electrical Safety

- Grounded tools must be plugged into an outlet properly installed and grounded in accordance with all codes and ordinances. Never remove the grounding prong or modify the plug in any way. Do not use any adapter plugs. 
- Grounding provides a low-resistance path to carry electricity away from the user in the event of an electrical malfunction.
- Double insulated tools are equipped with a polarized plug where one blade is wider than the other. This plug fits in a polarized outlet only one way. If the plug does not fit fully in the outlet, reverse the plug. If it still does not fit, contact a qualified electrician to install a polarized outlet. Do not change the plug in any way. Double insulation eliminates the need for the three-wire grounded power cord and grounded power supply system.
- Avoid body contact with grounded surfaces such as pipes, radiators, ranges, and refrigerators. There is an increased risk of electric shock if your body is grounded.
- Do not expose generator to rain or wet conditions. Water entering a generator will increase the risk of electric shock.
- Do not abuse the power cord. Keep power cords away from heat, oil, sharp edges, or moving parts. Replace damaged power cords immediately. Damaged power cords increase the risk of electric shock.
- When operating a power tool outside, use an outdoor extension cord marked "W-A" or "W". These extension cords are rated for outdoor use, and reduce the risk of electric shock.

Owner's Manual

General Precautions (cont'd)

Electrical Safety (cont'd)

- All connections and conduits from the generator to the load must only be installed by trained and licensed electricians, and in compliance with all relevant local, state, and federal electrical codes and standards, and other regulations where applicable.
- The generator must be earth-grounded for fixed installations in accordance with all relevant electrical codes and standards before operation.
- Do not attempt to connect or disconnect load connections while standing in water, or on wet or soggy ground.
- Do not touch electrically energized parts of the generator and interconnecting cables or conductors with any part of the body, or with any non-insulated conductive object.
- Connect the generator only to a load or electrical system (110/120 volt) that is compatible with the electrical characteristics and rated capacities of the generator.
- Before servicing equipment powered by the generator, disconnect the equipment from its power input.
- Keep all electrical equipment clean and dry. Replace any wiring where the insulation is cracked, cut abraded or otherwise degraded. Replace terminals that are worn, discolored, or corroded. Keep terminals clean and tight.
- Insulate all connections and disconnected wires.
- Guard against electric shock. Prevent body contact with grounded surfaces such as pipes, radiators, ranges, and refrigerator enclosures.

Personal Safety

- Stay alert. Watch what you are doing, and use common sense when operating a generator. Do not use generator while tired or under the influence of drugs, alcohol, or medication. A moment of inattention while operating generators may result in serious personal injury.
- Dress properly. Do not wear loose clothing or jewelry. Contain long hair. Keep your hair, clothing, and gloves away from moving parts. Loose clothes, jewelry, or long hair can be caught in moving parts.

7500W Generator

General Precautions (cont'd)

Personal Safety (cont'd)

- Avoid accidental starting. Make sure the power switch is in its "OFF" position, and disconnect the spark plug wire when not in use.
- Remove adjusting keys or wrenches before turning the generator on. A wrench or a key that is left attached to a rotating part of the generator may result in personal injury.
- Do not overreach. Keep proper footing and balance at all times.
- Use safety equipment. Always wear eye protection. Wear ANSI approved safety impact eye goggles. Dust mask, non-skid safety shoes, hard hat, or hearing protection must be used for appropriate conditions.
- Do not force the generator. Use the correct generator for your application. The correct generator will do the job better and safer at the rate for which it is designed.
- Do not use the generator if the power switch does not turn it on or off. Any generator that cannot be controlled with the power switch is dangerous and must be replaced.

Generator Use and Care

Make sure the power switch is in its "OFF" position and disconnect the spark plug wire before making any adjustment, changing accessories, or storing the generator. Such preventive safety measures reduce the risk of starting the generator accidentally.

Store idle generators out of reach of children and other untrained persons. Generators are dangerous in the hands of untrained users.

Maintain generators with care. Do not use damaged generator. Tag damaged generators "Do not use" until repaired.

Check for misalignment or binding of moving parts, breakage of parts, and any other condition that may affect the generator's operation. If damaged, have the generator serviced before using. Many accidents are caused by poorly maintained generators.

Use only accessories that are recommended by the manufacturer for your model. Accessories that may be suitable for one generator may become hazardous when used on another generator.

Owner's Manual

General Precautions (cont'd)

Servicing

Maintain labels and name plates on the generator and engine. These carry important information. If unreadable or missing, contact All Power America immediately for a replacement.

Generator service must be performed only qualified repair personnel. Service or maintenance performed by unqualified personnel could result in a risk of injury.

When servicing a generator, use only identical replacement parts. Follow all appropriate instructions in this manual. Use of unauthorized parts or failure to follow maintenance instructions may create a risk of electric shock or injury.

Heart Pacemakers



WARNING! PEOPLE WITH PACEMAKERS SHOULD CONSULT THEIR PHYSICIAN(S) BEFORE USING THIS PRODUCT. ELECTROMAGNETIC FIELDS IN CLOSE PROXIMITY TO A HEART PACEMAKER COULD CAUSE INTERFERENCE TO OR FAILURE OF THE PACEMAKER.

Installation

- Ensure installation meets all applicable safety, and local and national electrical codes. Have installation performed by a qualified, licensed electrician and building contractor.
- All electrical work, including the earth-ground connection, should be completed by a licensed electrician.
- Any separate fuel storage or generator supply facility must be built or installed in full compliance with all relevant local, state, and federal regulations.

7500W Generator

General Precautions (cont'd)

Installation (cont'd)

- If the generator is installed outdoors, it must be weatherproofed and should be soundproofed. It should not be run outdoors without protection to the generator and wiring conduit.
- The generator weighs 195 lbs. Two or more people should assist when moving or lifting this product. Never lift the generator using the engine or alternator lifting lugs. Connect lifting equipment to the frame of the generator
- Before lifting the generator, ensure the lift rigging and supporting structure are in good condition, and are rated to lift such a load.
- Keep all personnel away from the suspended generator during relocating.
- The supporting floor/ground surface should be level and strong enough to safely hold the weight of the generator. If the floor/grounded surface is not level, strong cross members should be placed under the full length of the generator frame at its low side.
- For trailer installation, the generator should be mounted on the center point of the trailer, over the wheels. The trailer must be capable of supporting the weight of the generator and all contents (tools, etc.)
- Install sound-and weather-proofing only when it is not raining or snowing to avoid trapping moisture within the generator's area.

Mechanical

- Always make sure the power switch is in its "OFF" position. Disconnect the spark plug wire, and allow the engine to completely cool before carrying out maintenance.
- Check for damaged parts. Before using the generator, any part that appears damaged should be carefully checked to determine that it will operate properly and perform its intended function. Check for alignment and binding of moving parts, any broken parts or mounting fixtures, and any other condition that may affect proper operation technician.
- The generator is designed with guards for protection from moving parts. In any case, care must still be taken to protect personnel and equipment from other mechanical hazards when working around the generator.

Owner's Manual

General Precautions (cont'd)

Mechanical (cont'd)

- Do not operate the generator with safety guards removed. While the generator is running, do not attempt to reach around the safety guard for maintenance or any other reason.
- Keep hands, arms, long hair, loose clothing, and jewelry away from moving parts. Be aware that when engine parts are moving fast they cannot be seen clearly.
- Keep access doors on enclosures closed and locked when access is not required.
- When working on or around the generator always wear protective clothing including ANSI approved safety gloves, safety eye goggles, and safety hat.
- Do not alter or adjust any part of the generator that is assembled and supplied by the manufacturer.
- Always follow and complete scheduled engine and generator maintenance.

Chemicals

- Avoid contact with hot fuel, oil, exhaust fumes, and hot solid surfaces.
- Avoid body contact with fuels, oils, and lubricants used in the generator. If swallowed, seek medical treatment immediately. Do not induce vomiting if fuel is swallowed. For skin contact, immediately wash with soap and water. For eye contact, immediately flush eyes with clean water and seek medical attention.

Noise

- Prolonged exposure to noise levels above 85 DBA is hazardous to hearing. Always wear ANSI approved ear protection when operating or working around the generator when it is running.

7500W Generator

General Precautions (cont'd)

Extension Cord

If an extension cord (not included) is used, make sure to use only UL approved cords having the correct gauge and length according to the following table:

	Nameplate Amps (@ full load)		Cord Lengths	
	0'-50'	50'-100'	100'-150'	150'-200'
0 - 5	16 AWG	16 AWG	12 AWG	12 AWG
5.1 - 8	16 AWG	14 AWG	10 AWG	-
8.1 - 12	14 AWG	12 AWG	-	-

Owner's Manual

Battery

To start generator with electric start you will need a battery (not included). You can use a 12v lawn tractor battery with the following specifications: The dimensions are Wx7.5" Dx5" Hx7" (including terminals). A rated cranking amperage of 200. Terminals are regular, not reversed. Note: Using a battery not designed for this unit may void warranty. Also this generator can also be started with the pull start.

Photos below demonstrate battery plate attachment.

1) Bolt on plate with M6X40 bolts as shown below.

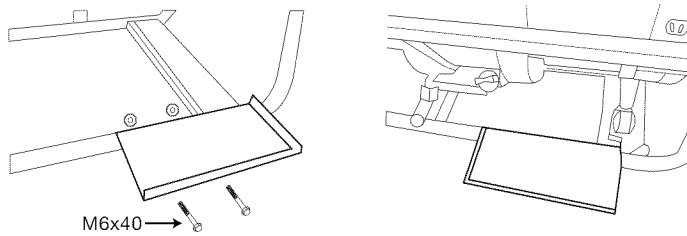

2) Put the battery on the frame, have the battery assembled with the provided accessories as shown.

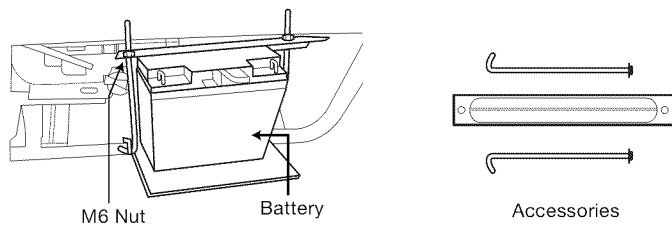

7500W Generator

Assembly

Unpacking

1. Remove the generator and loose parts box from the carton.
2. Compare the loose parts with the inventory list below.

Loose Parts (Wheel kit and handle)

Check all loose parts against the following list. Contact your dealer toll free at 888.896.6881 if any of the loose parts shown are not included with your generator

Hardware Check:

Your Hardware Kit should include:

- 1) 1 Handle with bolt and bracket
- 2) 1 Handle Retainer Bracket with Bolt
- 3) 6 (six) 8mm bolts, (6mm x 1.0) thread
- 4) 6 (six) 10mm Nuts (6mm x 1.0) thread
- 5) 2 (two) rubber bushings with 2 nuts
- 6) 1 (one) axle shaft
- 7) 2 (two) washers
- 8) 2 (two) cotter pins
- 9) 4 (four) leg bolts and nuts
- 10) 1 (one) generator leg
- 11) 2 (two) wheels (not shown)

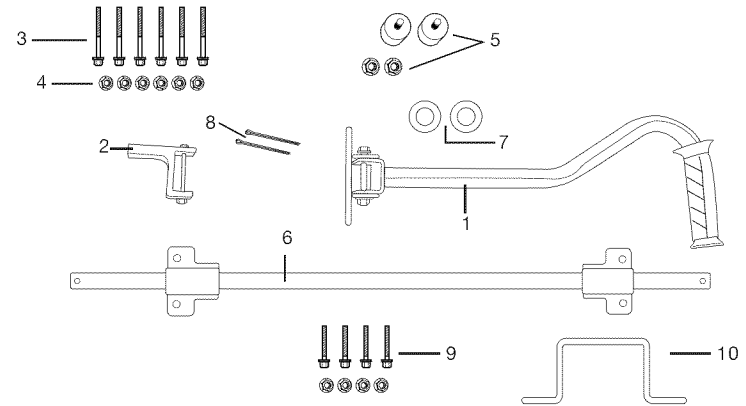

Owner's Manual

Assembly

Handle Installation.

Start by installing the handle on the frame with two 8mm bolts. Then install the handle retainer as shown.

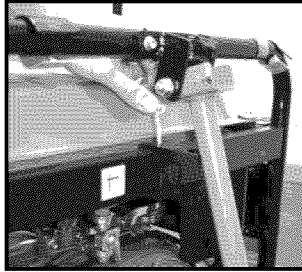

Floor Mount Installation

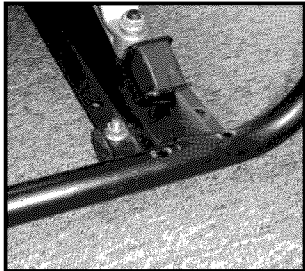

This generator has an option of not using the mobility kit. If this is desired, just install the 4 rubber mounts on the frame as shown. (this is why there are 6 mounts). If you want to use the mobility kit, save the 4 mounts in a safe place, and continue to the "mobility kit installation." section.

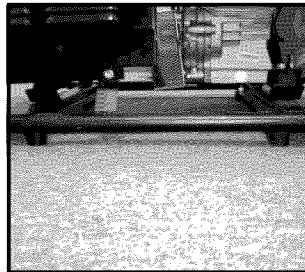

Here is a picture of the floor mounts installed.

7500W Generator

Assembly

Wheel Kit Installation

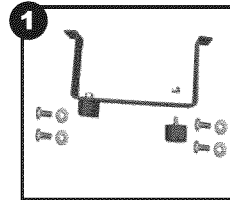

Start by installing the rubber floor mounts onto the support leg as shown.
Note: The leg should be installed on the same side as the pull handle.

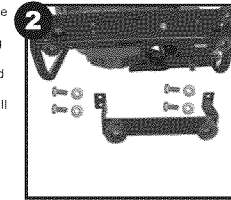

Here is the hardware required to install the support leg. Place a block of wood under the generator so that you don't have to hold it up while trying to install the leg.
Place the support leg under the frame. Push the bolt thru the frame and thru the leg. Thread a nut onto the bolt. Tighten with a wrench.

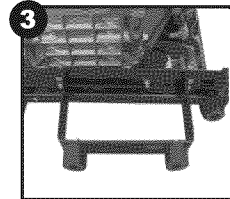

This is what the leg looks like when it is installed.

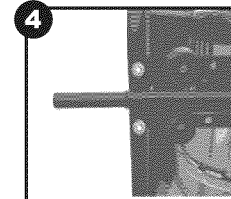

The wheels should be installed on the side opposite to the handle. Place a block of wood under the generator so that you don't have to hold it up while trying to install the axle. Push the two axle mount brackets onto each side of the axle. Place the axle under the unit. Thread two bolts thru the tubular frame and thru the axle mounting plates. Thread a nut onto the bolt and tighten.

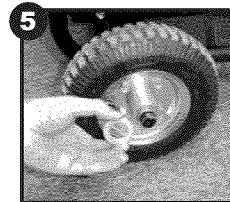

Slide the wheels onto the axle. Place a washer over the wheel.

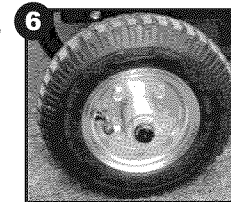

Push the cotter pin thru the axle and bend it backwards as shown.

Your generator is now mobile. Enjoy!

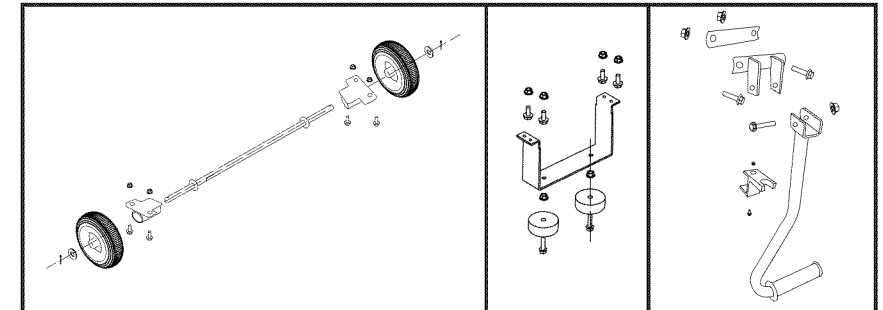

Owner's Manual

Operation

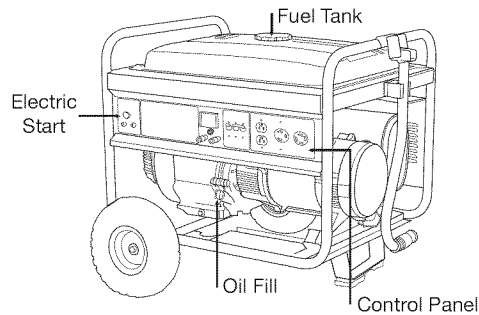

NOTE: THE PARTS LISTED ABOVE ARE HELPFUL FOR LOCATING THE CONTROLS MENTIONED BELOW.



CAUTION: Prior To First Using The Generator, The Engine Must Be Filled With A High Quality SAE 10w-30 Grade Engine Oil. To Do So Unscrew And Remove The Engine's Oil Dipstick Located At The Bottom Of The Engine Crankcase. Fill The Engine's Crankcase Until The Oil Level Is Level With The Upper Marked Line On The Dipstick. Then, Screw The Dipstick Back Into The Oil Fill Hole.

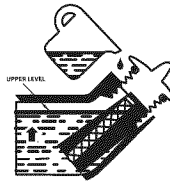

ENGINE OIL RECOMMENDATIONS

Oil is a major factor affecting performance and service life. Use 4-stroke automotive detergent oil. SAE 10W 30 is recommended for general use. Other viscosities shown in the chart may be used when the average temperature in your area is within the recommended range.

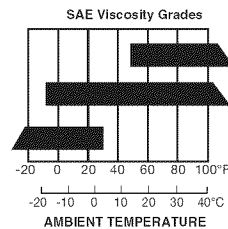

Before Starting the Generator

1. Check that the engine power switch is in its "OFF" position (see diagram on next page).
2. Before the first use, remove the fuel tank cap and fill the fuel tank with unleaded gasoline. When fueling, be sure that the fuel strainer is in place. Replace the fuel tank cap. Thereafter, check the engine's fuel gauge for the amount of unleaded gasoline in the fuel tank. If necessary, refill the fuel tank with unleaded gasoline. The generator must be turned off and cooled down before refilling the fuel tank.

7500W Generator

Operation (cont'd)

Starting

1. Turn the engine switch to the ON position.
The engine switch enables and disables the ignition system.
OFF: To stop the engine
RUN: To run the engine

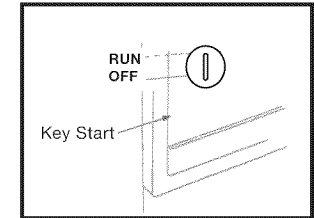

2. The fuel valve is located between the fuel tank and the carburetor. When the valve lever is in the ON position, fuel is allowed to flow from the fuel tank to the carburetor. Be sure to return the fuel valve lever to the OFF position after stopping the engine.

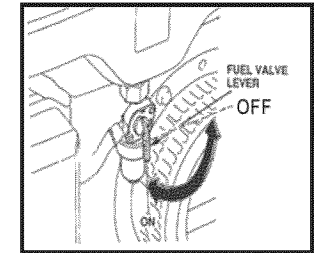

3. To start a cold engine, move the choke lever to the CLOSED position. To restart a warm engine, leave the choke lever in the OPEN position.

The choke lever opens and closes the choke valve in the carburetor.

The CLOSED position enriches the fuel mixture from starting a cold engine.

The OPEN position provides the correct fuel mixture for operation after starting, and for restarting a warm engine.

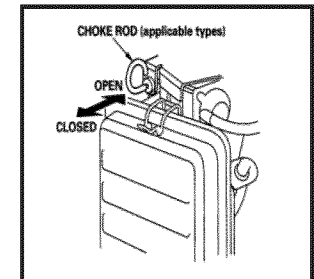

Owner's Manual

Operation (cont'd)

Starting

- Operate the Recoil Starter: Turn the key to the "Run" position. Pull the starter grip lightly until you feel resistance, then pull briskly. Return the starter grip gently. Pulling the starter grip operates the recoil starter to crank the engine.

ELECTRIC START. For Electric Start just turn the key to start.
NOTE: Make sure the adequate battery is installed correctly. (see battery installation for details)

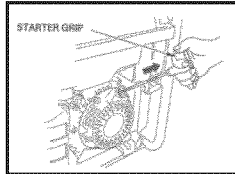

- If the choke lever has been moved to the CLOSED position to start the engine, gradually move it to the OPEN position as the engine warms up.

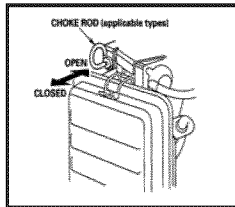

Stopping Engine

- Turn the engine switch to the OFF position.

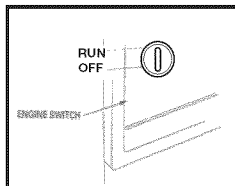

- Turn the fuel valve lever to the OFF position.

When the engine is not in use, leave the fuel valve lever in the OFF position to prevent carburetor flooding and to reduce the possibility of fuel leakage.

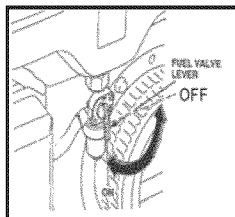

7500W Generator

Operation (cont'd)

Powering 120 Volt AC Tools And Equipment:

- Prior to powering tools and equipment, make sure the generator's rated voltage, and amperage capacity (120V AC) is adequate to supply all electrical loads that the unit will power. If powering exceeds the generator's capacity, it may be necessary to group one or more of the tools and/or equipment for connection to a separate generator.



CAUTION: ATTEMPTING TO POWER SENSITIVE ELECTRONIC EQUIPMENT WITHOUT THE USE OF AN APPROVED LINE CONDITIONER MAY CAUSE DAMAGE TO THE EQUIPMENT. ALL-POWER IS NOT RESPONSIBLE FOR ANY DIRECT OR INDIRECT DAMAGE CAUSED BY FAILURE TO USE AN APPROVED LINE CONDITIONER.

- Once the generator is running, simply connect the power cords of 120 volt AC powered tools and equipment into the 120 volt AC dual outlets.



NOTE: THE GENERATOR FEATURES AN AC NON-FUSE CIRCUIT BREAKER TO PROTECT THE AC CIRCUIT IN CASE OF AN OVERLOAD. SHOULD AN OVERLOAD OCCUR, THE BREAKER WILL "TRIP" TO ITS "OFF" POSITION, IN THIS CASE, REFER TO ABOVE IN THIS POSITION. THEN, RESET THE CIRCUITRY SYSTEM BY TURNING THE CIRCUIT BREAKER TO ITS "ON" POSITION.

- Disconnect all electrical powered tools and equipment from the generator's 120 volt AC dual outlets.
- After the engine and generator have completely cooled, store generator in a safe, clean, dry location (if not already installed).

Owner's Manual

Operation (cont'd)

Powering 12 Volt DC tools and Equipment:

1. Prior to powering tools and equipment, make sure the generator's rated voltage, and amperage capacity (12V DC) is adequate to supply all electrical loads that the unit will power. If powering exceeds the generator's capacity, it may be necessary to group one or more of the tools and/or equipment for connection to a separate generator.
2. Connect the power cord of a 12V DC powered tool or equipment to the DC Terminals.



CAUTION: MAKE SURE TO CONNECT THE POSITIVE (+) LEAD OF THE POWER CORD TO THE POSITIVE (+) TERMINAL ON THE GENERATOR, AND CONNECT THE NEGATIVE (-) LEAD OF THE POWER CORD TO THE NEGATIVE (-) TERMINAL ON THE GENERATOR.

3. Start and run the engine as described above
4. When finished using the generator, turn the engine power switch to its "OFF" position. Turn the fuel valve to its "OFF" position.
5. Disconnect the electrical powered tools' power cord from the generator's DC terminals.
6. After the engine and generator have completely cooled, store the generator in a safe, clean, dry location (if not already installed in one).

NOTE: The 12V DC is only used for charging batteries.

7500W Generator

Operation (cont'd)

Spark Plug Service

In order to service the spark plug, you will need a spark plug wrench (commercially available). Recommended spark plugs: NHSP LD F7TC. To ensure proper engine operation, the spark plug must be properly gapped and free of deposits.

1. Remove the spark plug cap.
2. Use a spark plug wrench to remove the spark plug.
3. Visually inspect the spark plug. Discard it if the insulator is cracked or chipped. Clean the spark plug with a wire brush if it is to be reused.
4. Measure the plug gap with a feeler gauge.
5. Check that the spark plug washer is in good condition.
6. After the spark plug is seated, tighten with a spark plug in by hand to prevent cross-threading.
7. After the spark plug is seated, tighten with a spark plug wrench to compress the washer.



NOTE: THE SPARK PLUG MUST BE SECURELY TIGHTENED. AN IMPROPERLY TIGHTENED SPARK PLUG CAN BECOME VERY HOT AND COULD DAMAGE THE ENGINE. NEVER USE SPARK PLUGS WHICH HAVE AN IMPROPER HEAT RANGE. USE ONLY RECOMMENDED SPARK PLUS OR EQUIVALENT.

Owner's Manual

Inspection, Cleaning, and Maintenance



WARNING! ALWAYS MAKE SURE THE ENGINE POWER SWITCH IS IN ITS "OFF" POSITION. DISCONNECT THE SPARK PLUG WIRE FROM THE ENGINE. AND ALLOW SUFFICIENT TIME FOR THE ENGINE AND GENERATOR TO COMPLETELY COOL BEFORE PERFORMING ANY INSPECTIONS, MAINTENANCE, OR CLEANING.

- Before each use, inspect the generator. Check for:
 - Loose screws
 - Misaligned or binding moving parts
 - Cracked or broken parts
 - Damaged electrical wiring
 - Any other condition that may affect safe operation.
- If an engine problem occurs, have it checked by a qualified service technician before further use. Do not use damaged equipment.
- Before each use, make sure the engine's oil and gas levels are adequate. If necessary, fill the crankcase until the oil level is even with the oil fill hole and/or fill the fuel tank.
- Before each use, remove all debris with a soft brush, rag, or vacuum.
- Lubricate all moving parts using a premium quality, lightweight machine oil.
- Oil has to be drained after the first 20 hours of use. This is the break in period. Then after every 50 hours of use, drain the old engine oil and replace with a high quality SAE 10W-30 grade engine oil.
- Every 300 hours of use, have a qualified, certified technician perform thorough maintenance on the generator and engine.
- For long term storage, either drain fuel into suitable container or add a fuel preservative/stabilizer (not included) to prevent fuel breakdown.

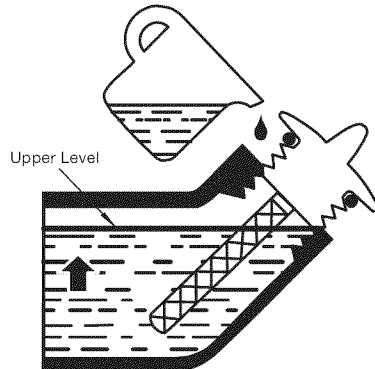

7500W Generator

Installation



NOTE: PRIOR TO POWERING TOOLS AND EQUIPMENT MAKE SURE THE GENERATOR'S RATED VOLTAGE, WATTAGE AND AMPERAGE CAPACITY IS ADEQUATE TO SUPPLY ALL ELECTRICAL LOADS THAT THE UNIT WILL POWER. IF POWERING EXCEEDS THE GENERATOR'S CAPACITY, IT MAY BE NECESSARY TO GROUP ONE OR MORE OF THE TOOLS AND/OR EQUIPMENT FOR CONNECTION TO A SEPERATE GENERATOR.

Electrical and other permits may be required for the installation of emergency power systems. Investigate your local building and electrical codes before installing this unit. Installation must be completed by licensed contractors.



WARNING! THE GENERATOR WEIGHS APPROXIMATELY 195 POUNDS. USE CARE AND THE PROPER LIFTING OR HOISTING EQUIPMENT WHEN MOVING IT TO THE INSTALLATION LOCATION. ALWAYS CONNECT HOIST LINES TO THE FRAME OF THE GENERATOR.

General Location

- Make sure to locate and install the generator outdoors where cooling air is readily available.
- Install the generator so that the air inlets and outlets are not blocked by obstructions such as bushes, trees, or snow drifts. Locating it in the path of heavy winds or snowdrifts may require the placement of a barrier for protection. In normal weather conditions, the air vent should face the prevailing wind direction.
- Install the generator on a concrete slab or other area where rain drainage or flood waters can not reach it.
- Generator placement should allow four feet of access to all sides for maintenance.
- Place the generator as close as possible to the electrical tools and equipment being powered to reduce the length of extension cords.

Owner's Manual

Installation (cont'd)

Supporting and Mounting

Mount the generator on a concrete slab capable of supporting the weight of the generator. The slab must extend on all sides beyond the frame by at least one foot. Contact a cement contractor for slab specifications if necessary. Attach the frame to the concrete slab using 3/8" diameter expansion anchor bolts (not supplied).

Grounding



NOTE: IT IS RECOMMENDED THAT ONLY A TRAINED AND LICENSED ELECTRICIAN PERFORM THIS PROCEDURE

Connect a #6 AWG grounding wire (not included) from the ground connector on the generator power panel (picture below) to a grounding rod (picture below). It must be driven at least 24" deep into the earth (Soil). The grounding rod must be an earth-driven copper or brass (electrode) which can adequately ground the generator.

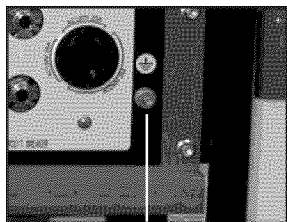

Ground Connector

Brass Rod (electrode)

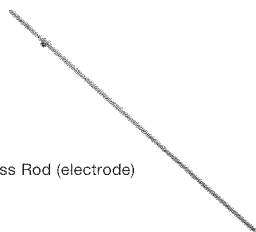

7500W Generator

Compliance

UNITED STATES ENVIRONMENTAL PROTECTION AGENCY,
WASHINGTON, DC 20460

2009 Model Year Certificate of Conformity

- **Manufacturer:** Jiangsu Jiandong Group Co. Ltd.
- **Certificate Number:** JDG-NRSI-09-01
- **Effective Date:** 1/6/2009
- **Date Issued:** 1/6/2009

Merrylin Zaw-Mon, Director, Compliance and Innovation Strategies Division, Office of Transportation and Air Quality.

Pursuant to Section 213 of Clean Air Act (42 U.S.C. section 7547) and 40 CFR 90 and 40 CFR 60 (stationary only and combined stationary and mobile), and subject to the terms and conditions prescribed in those provisions, this certificate of conformity is hereby issued for the following small non-road engine family, more fully described in the documentation required by 40 CFR 90 and produced in the stated model year.

This certificate of conformity covers only those new small non-road engines which conform in all material respects to the design specifications described in the documentation required by 40 CFR 90 and which are produced during the model year stated on this certificate. This certificate of conformity does not cover small non-road engines imported prior to the effective date of the certificate. SMALL NON-ROAD ENGINE FAMILY: 9JDGS.3892GA

This certificate of conformity is conditional upon compliance of said manufacturer with the averaging, banking, and trading provisions of 40 CFR Part 90, Subpart C both during and after model year production. Failure to comply with these provisions may render this certificate void ab initio. The HC + NOX family emission limit (FEL) is: g/k W-hr.

It is a term of this certificate that the manufacturer shall consent to all inspections described in 40 CFR 90.126 and 90.506 and authorized in a warrant or court order. Failure to comply with the requirements of such a warrant or court order may lead to revocation or suspension of this certificate for reasons specified in 40 CFR Part 90. It is also a term of this certificate that this certificate may be revoked or suspended or rendered void ab initio for other reasons specified in 40 CFR Part 90.

This certificate does not cover small non-road engines sold, offered for sale, or introduced, or delivered for introduction, into commerce in the U.S. prior to the effective date of the certificate.