





LCD TV



USER'S MANUAL

Model: 32LE30Q
UM No.: N0332B0300

	<p>CAUTION</p> <p>RISK OF ELECTRIC SHOCK</p> <p>DO NOT OPEN</p>	
<p>CAUTION: To reduce the risk of electric shock, do not remove cover or back. No user- serviceable parts inside. Refer Servicing to qualified service personnel.</p>		



The lightning flash with arrowhead symbol, within an equilateral triangle is intended to alert the user to the presence of uninsulated dangerous voltage within the product enclosure that may be of sufficient magnitude to constitute a risk of electric shock.

CAUTION: Changes or modifications not expressly approved by the party responsible for compliance with the FCC Rules could void the users' authority to operate this equipment.



The exclamation point within an equilateral triangle is intended to alert the user to the presence of important operating and maintenance (servicing) instructions in the literature accompanying the TV.

CAUTION: The TV shall not be exposed to dripping or splashing. No objects filled with liquids, such as vases, shall be placed on the TV.



WARNING: TO PREVENT FIRE OR SHOCK HAZARD, DO NOT EXPOSE THIS APPLIANCE TO RAIN OR MOISTURE.

CAUTION: Do Not Place This TV on an unstable cart, stand, or table. The TV may fall, causing serious injury to a child or adult, and serious damage to the TV. Use only with a cart or stand recommended by the manufacturer, or sold with the TV.

CAUTION: Installation on concrete wall has passed UL safety test.

WARNING: TO REDUCE THE RISK OF FIRE OR ELECTRIC SHOCK, DO NOT EXPOSE THIS APPLIANCE TO RAIN OR MOISTURE. DANGEROUS HIGH VOLTAGES ARE PRESENT INSIDE THE ENCLOSURE. DO NOT OPEN THE CABINET. REFER SERVICING TO QUALIFIED PERSONNEL ONLY.

WARNING: THE APPARATUS SHALL NOT BE EXPOSED TO DRIPPING OR SPLASHING AND THAT NO OBJECTS FILLED WITH LIQUIDS, SUCH AS VASES SHALL BE PLACED ON THE APPARATUS.

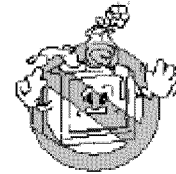

CAUTION: TO PREVENT ELECTRIC SHOCK, MATCH WIDE BLADE OF PLUG TO WIDE SLOT IN OUTLET.

CAUTION: THESE SERVICING INSTRUCTIONS ARE FOR USE BY QUALIFIED SERVICE PERSONNEL ONLY.

TO REDUCE THE RISK OF ELECTRIC SHOCK, DO NOT PERFORM ANY SERVICING ACTIVITIES, BUT CALL QUALIFIED ELECTRICIAN PERSONNEL.

CAUTION: DANGER OF EXPLOSION IF BATTERY IS INCORRECTLY REPLACED, REPLACE ONLY WITH THE SAME OF EQUIVALENT TYPE.

IMPORTANT SAFETY INSTRUCTIONS

1. **READ THESE INSTRUCTIONS.**

2. **KEEP THESE INSTRUCTIONS.**

3. **HEED ALL WARNINGS.**

4. **FOLLOW ALL INSTRUCTIONS.**

5. **DO NOT USE THIS APPARATUS NEAR WATER.**

Do not use this TV near water. For example, do not use near a bathtub, washbowl, kitchen sink or laundry tub, in a wet basement, or near a swimming pool, and the like. The TV set shall not be exposed to dripping or splashing. No objects filled with liquids, such as vases, shall be placed on the TV set.

6. **CLEAN ONLY WITH DRY CLOTH.**

Unplug the TV from the wall outlet before cleaning. Do not use liquid cleaners or aerosol cleaners. Use a damp cloth for cleaning.

7. **DO NOT BLOCK ANY VENTILATION OPENINGS. INSTALL IN ACCORDANCE WITH THE MANUFACTURER'S INSTRUCTIONS.**

Slots and openings in the cabinet back or bottom are provided for ventilation, to ensure reliable operation of the TV and to protect it from overheating. These openings must not be blocked or covered. The openings should never be blocked by placing the TV on a bed, sofa, rug, or other similar surface. This TV should never be placed near or over a radiator or heat resource. This TV should not be placed in a built-in installation such as a bookcase or rack unless proper ventilation is provided or the manufacturer's instructions have been adhered to.

8. **DO NOT INSTALL NEAR ANY HEAT SOURCES SUCH AS RADIATORS, HEAT REGISTERS, STOVES, OR OTHER APPARATUS (INCLUDE AMPLIFIERS) THAT PRODUCE HEAT.**

9. **DO NOT DEFEAT THE PURPOSE OF THE POLARIZED OR GROUNDING-TYPE PLUG. A POLARIZED PLUG HAS TWO BLADES WITH ONE WIDER THAN THE OTHER. A GROUNDING TYPE PLUG HAS TWO BLADES AND A THIRD GROUNDING PRONG. THE WIDE BLADE OR THE THIRD PRONG IS PROVIDED FOR YOUR SAFETY. IF THE PROVIDED PLUG DOES NOT FIT INTO YOUR OUTLET, CONSULT AN ELECTRICIAN FOR REPLACEMENT OF THE OBSOLETE OUTLET.**

10. **PROTECT THE POWER CORD FROM BEING WALKED ON OR PINCHED PARTICULARLY AT PLUGS, CONVENIENCE RECEPTACLES, AND THE POINT WHERE THEY EXIT FROM THE APPARATUS.**

11. **ONLY USE ATTACHMENTS/ACCESSORIES SPECIFIED BY THE MANUFACTURER.**

12. **USE ONLY WITH CART, STAND, TRIPOD, BRACKET, OR TABLE SPECIFIED BY THE MANUFACTURER, OR SOLD WITH THE APPARATUS. WHEN A CART IS USED, USE CAUTION WHEN MOVING THE CART/ APPARATUS COMBINATION TO AVOID INJURY FROM TIP-OVER.**



Do not place this TV on an unstable cart, stand, tripod, bracket, or table. The TV may fall, causing serious injury to someone, and serious damage to the appliance. A TV and cart combination should be moved with care. Quick stops, excessive force, and uneven surfaces may cause the TV and cart combination to overturn.

13. **UNPLUG THIS APPARATUS DURING LIGHTNING STORMS OR WHEN UNUSED FOR LONG PERIODS OF TIME.**

For added Protection for this TV receiver during a lightning storm, or when it is left unattended and unused for long period of time, unplug it from the wall outlet and disconnect the antenna or cable system. This will prevent damage to the TV due to Lightning and power line surges.

14. **REFER ALL SERVICING TO QUALIFIED SERVICE PERSONNEL. SERVICING IS REQUIRED WHEN THE APPARATUS HAS BEEN DAMAGED IN ANY WAY, SUCH AS POWER-SUPPLY CORD OR PLUG IS DAMAGED, LIQUID HAS BEEN SPILLED OR OBJECTS HAVE FALLEN INTO THE APPARATUS, THE APPARATUS HAS BEEN EXPOSED TO RAIN OR MOISTURE, DOES NOT OPERATE NORMALLY, OR HAS BEEN DROPPED.**

Note: All figures in the manual are for reference only, please refer to the actual units to determine their appearance.

CLEANING AND MAINTENANCE

The front of the display panel has been specially treated. Wipe the panel surface gently using only a cleaning cloth or a soft, lint-free cloth.

If the surface is particularly dirty, soak a soft, lint-free cloth in a weak detergent solution and then remove excess liquid. Use this cloth to wipe the surface of the display panel, and then wipe it with a dry cloth, of the same type, until the surface is dry.

Do not scratch or hit the surface of the panel with fingernails or other hard objects. Furthermore, avoid contact with volatile substances such as insect sprays, solvents and thinner; otherwise, the quality of the surface may be adversely affected.

Please read all the safety and operating instructions carefully before begin.

Table of contents

TABLE OF CONTENTS

CAUTION AND WARNING.....	1
IMPORTANT SAFETY INSTRUCTIONS.....	3
CLEANING AND MAINTENANCE.....	4
SAFETY PRECAUTIONS.....	6
INSTALLATION.....	7
Preparation for using your new TV	8
FRONT PANEL.....	8
REAR PANEL.....	9
CONNECTIONS AND EXTERNAL INPUT SETTINGS.....	10
Using the Remote control.....	11
LEARNING ABOUT REMOTE CONTROL.....	11
REMOTE CONTROL INSTRUCTIONS.....	12
Basic operation.....	13
TURNING ON AND OFF THE TV.....	13
CHOOSING TV CHANNEL.....	13
SELECTING INPUT SOURCE.....	14
VOLUME ADJUSTMENT.....	14
Setup menu operation.....	15
ADJUST THE OSD SCREEN.....	15
SELECT ON SCREEN LANGUAGE.....	16
PICTURE MENU OPTIONS	16
AUDIO MENU OPTIONS.....	17
SETUP MENU OPTIONS.....	18
FEATURE MENU OPTIONS.....	20
VGA MENU OPTIONS.....	25
YPBPR MENU OPTIONS.....	26
HDMI MENU OPTIONS.....	27
APPENDIX	28
Troubleshooting.....	28
Removing TV Stand.....	31
Wall Mounting Unit Specification.....	32
Universal Remote Control Code List	33
TV Specification.....	34

Safety Precautions

SAFETY PRECAUTIONS

WARNING

KEEP UNNEEDED SMALL PARTS AND OTHER OBJECTS OUT OF THE REACH OF SMALL CHILDREN. THESE OBJECTS CAN BE ACCIDENTALLY SWALLOWED. ALSO, BE CAREFUL ABOUT PACKAGING MATERIALS AND PLASTIC SHEETS.

Set up

Do not place the TV set on sloped or unstable surfaces.

Do not place any objects on top of the TV set. If water spills onto the TV set or foreign objects get inside it, short-circuiting may occur which could result in fire or electric shock. If any foreign objects get inside the TV set, please consult an Authorized Service Center.

Do not cover the ventilation holes. Doing so may cause the TV set overheated and can cause fire or damage to the TV set.

Avoid installing this product near electronic equipment that is readily affected by electromagnetic waves.

It may cause interference in image, sound, etc. In particular, keep video equipment away from this product.

AC Power Supply Cord

Securely insert the power cord plug as far as it will go. If the plug is not fully inserted, heat may be generated which could cause fire. If the plug is damaged or the wall socket plate is loose, they should not be used.

Do not handle the power cord plug with wet hands. Doing so may cause electric shocks.

Do not do anything that might damage the power cable. When disconnecting the power cable, hold the plug, not the cable.

Do not make any modifications to, place heavy objects on, place near hot objects, heat, bend, twist or forcefully pull the power cable. Doing so may cause damage to the power cable which can cause fire or electric shock. If damage to the cable is suspected, have it repaired at an Authorized Service Center.

If the TV set will not be used for a long period of time, unplug the power cord from the wall outlet.

If Problems Occur During Use

If a problem occurs (such as no picture or no sound), or if smoke or an abnormal odor is detected from the TV set, unplug the power cord immediately. Continued use of the TV under these conditions might cause fire or permanent damage to the unit. Have the TV evaluated at an Authorized Service Center. Service to the TV by any unauthorized personnel is strongly discouraged due to its high voltage dangerous nature. If water or foreign objects get inside the TV set, if the TV set is dropped, or if the cabinet becomes damaged, disconnect the power cord plug immediately. Contact an Authorized Service Center for any repairs that need to be made.

Safety Precautions

When using the TV set

Do not bring your hands, face or objects close to the ventilation holes of the TV set. Top of the TV set is usually very hot due to the high temperature of exhaust air being released through the Ventilation holes. Burns or personal injuries can happen if any body parts are brought too close. Placing any object near the top of the TV could also result in heat damage to the object as well as to the TV if its ventilation holes are blocked.

Be sure to disconnect all cables before moving the TV set. Moving the TV with its cables attached might damage the cables which, in turn, can cause fire or electric shock.

Disconnect the power plug from the wall outlet as a safety precaution before carrying out any cleaning. electric shocks can result if this is not done.

Clean the power cable regularly to prevent it from becoming dusty. Built-up dust on the power cord plug can increase humidity which might damage the insulation and cause fire. Unplug the cord from the wall outlet and clean it with a dry cloth.

This TV set radiates infrared rays; therefore, it may affect other infrared communication equipment. Install your infrared sensor in a place away from direct or reflected light from your TV set.

INSTALLATION

Selecting a location for the TV

1. Place the TV on the floor or on a sturdy platform in a location where light does not directly hit the screen.
2. Place the TV far enough from the walls to allow proper ventilation. Inadequate ventilation may cause overheating, which may damage the TV.

Optional External Equipment

Before you purchase any cables, be sure you know what type of output and input connectors your various components require. Also determine the length of cable you will need. For more information regarding cables, please refer to the Quick Start Guide.

Preparation for using your new TV – Front Panel

FRONT PANEL

Familiarizing Yourself with the Main Hardware

(The picture of the product may vary depending on the model)

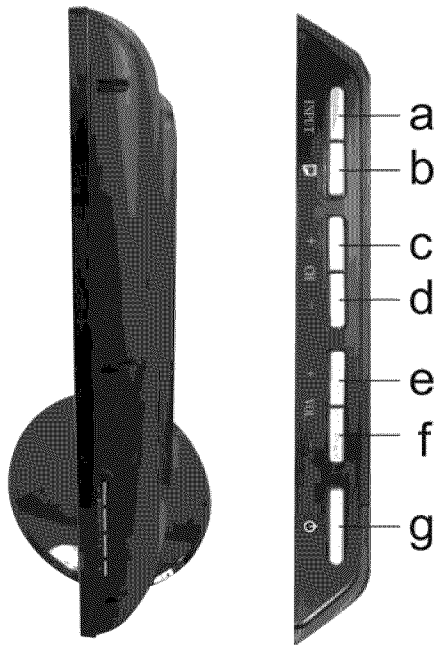

- a. Select signal input.
(It changes to "ENTER" function when main menu displays)
- b. Main Menu display and menu selection
- c. Channel up
- d. Channel down
- e. Volume up
- f. Volume down
- g. ON/OFF button

Preparation for using your new TV – Rear Panel

REAR PANEL

Rear panel

(The picture of the product may vary depending on the model)

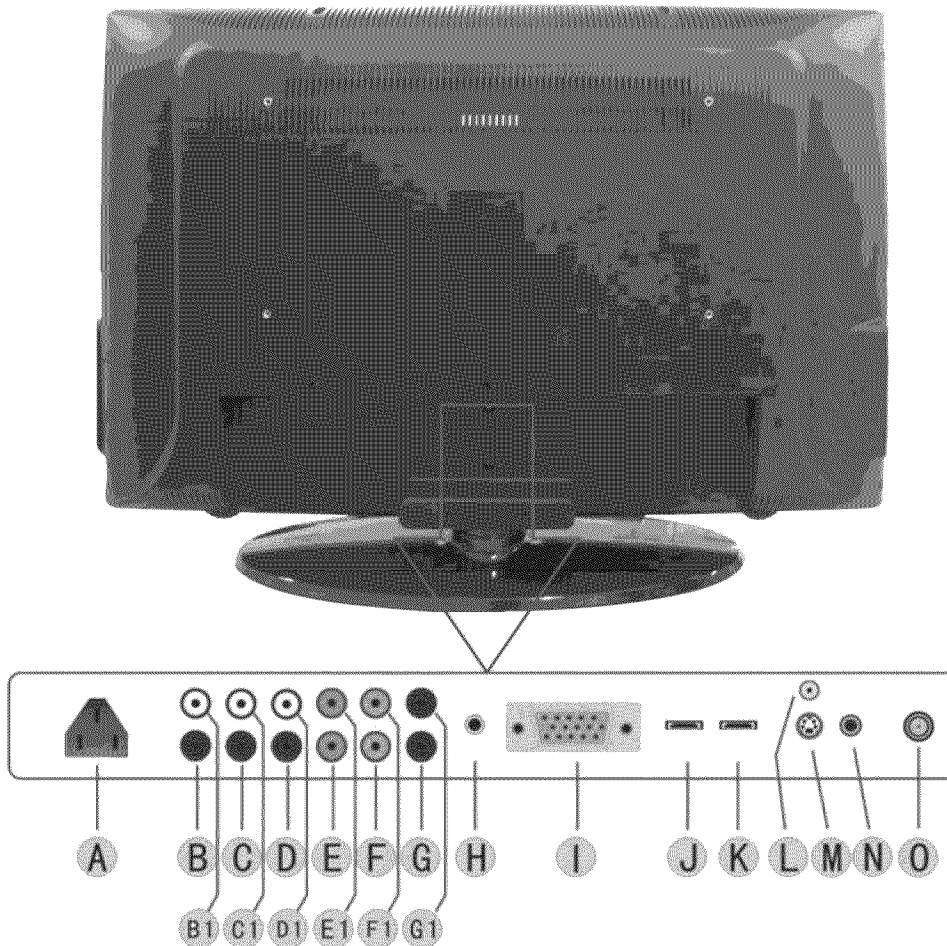

HDMI Input

- Input1 : J
- Input2 : K

Component Input 1

- Video : E1, F1, G1
- Audio : B, B1

Component Input 2

- Video : E, F, G
- Audio : C, C1

Composite Input

- Video : L
- Audio : D, D1

S-Video Input

- Video : M
- Audio : D, D1

VGA input

- Video : I
- Audio : H (3.5mm plug)

Others

- Power Input: A
- COAX Digital Out: N
- External Antenna: O

Preparation for using your new TV – Connections

CONNECTIONS AND EXTERNAL INPUT SETTINGS

1. Checking Items before Connecting

Please check the list below before connecting the product to other devices.

< Check items before connecting. >

Check the instruction manual when connecting external devices. External products sometimes have different buttons and locations.

- A. Do not connect the power unless every connection is well connected. The product may be damaged if turned on while still in the process of being connected.
- B. Connect the left (white) and right (red) cables correctly to the sound cable.
- C. Check the terminals to connect the product to on the rear panel.

2. Connecting an Antenna

There are internal and external types of antenna.

< Connecting an Antenna >

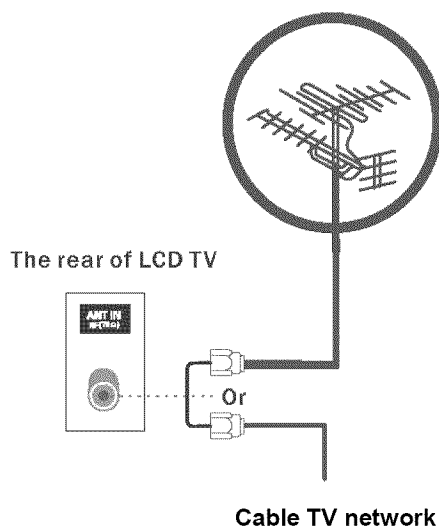

- A. Use a coaxial cable to connect the rear panel of the TV's [AIR] or [CABLE] terminals and the wall mount or external antenna.
- B. When an Air signal is required, connect to the [AIR] terminal. If a Cable signal is required, connect to the [CABLE] terminal. If both Air and Cable are available, and then connect both [AIR] and [CABLE] terminals.
- C. Connect the TV power cord when connecting everything else.

CAUTION

Avoid bending the copper tip at the center of the coaxial cable.

Using the remote control – Learning about remote control

LEARNING ABOUT REMOTE CONTROL

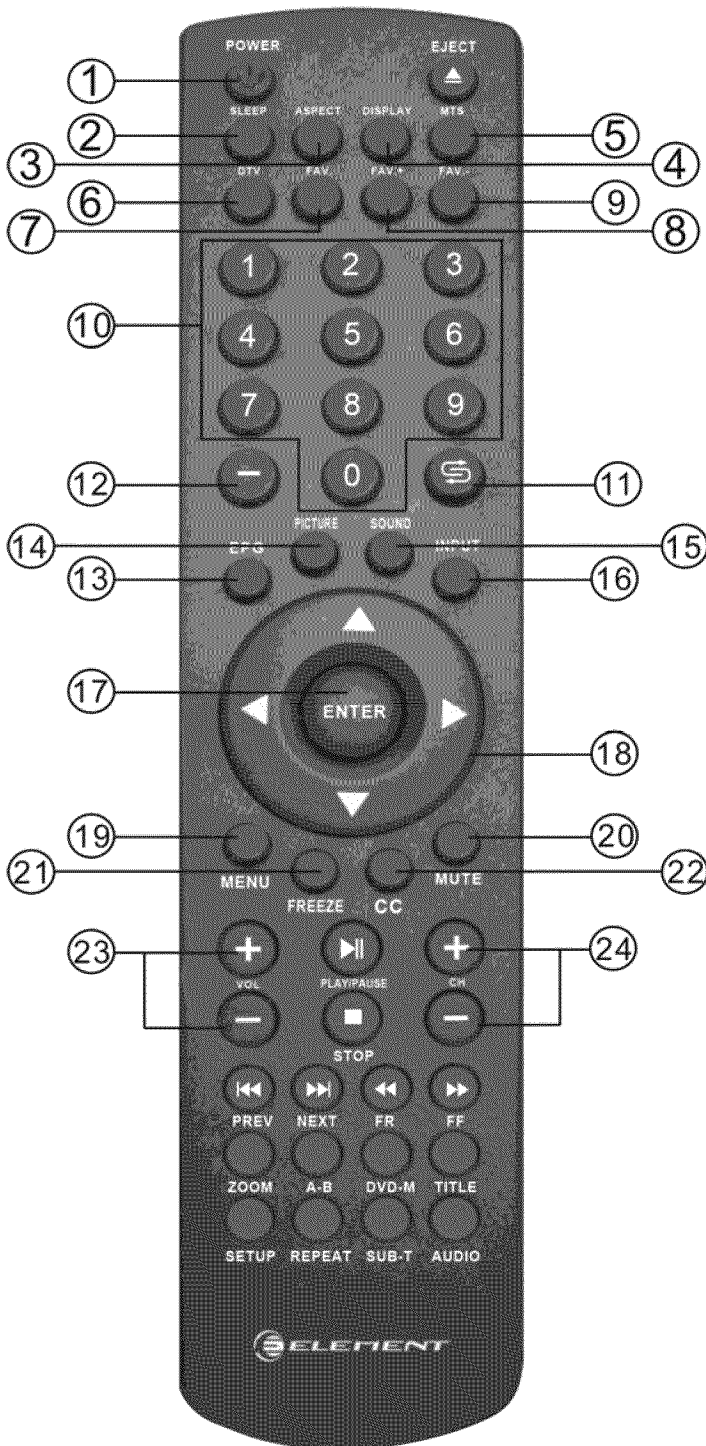

1. POWER: Power on/off.
2. SLEEP: Press to select a preset time interval to automatically shut the TV.
3. ASPECT: Press to adjust the screen size.
4. DISPLAY: Press to Check your current mode.
5. MTS: Press to select your favorite language in digital broadcasting.
6. DTV: Press to change between Analog TV and Digital TV.
7. FAV: Add/delete the current channel to your favorite channel.
8. FAV.+ : Press to view the next favorite channel.
9. FAV.- : Press to view the previous favorite channel.
10. Numeric Buttons: Press to change the channel directly using the numeric buttons.
11. RECALL: Press to switch between the current channel and the last channel.
12. -: When selecting a digital broadcast channel, press the number, followed by “-” button, followed by sub channel number.
13. EPG: One of signal channel EPG or Multi channel EPG.
14. PICTURE: Press to change to a preset picture mode.
15. SOUND: Press to change to a preset sound mode.
16. INPUT: Press to Display a menu of all available input sources, Also used to confirm your choice in the on-screen menu.
17. ENTER: Enter and confirm button.
18. UP/DOWN LEFT/RIGHT: The direction keys.
19. MENU: Press to display main menu.
20. MUTE: Press to temporarily switch the sound off.
21. FREEZE: Press to freeze the current picture.
22. CC: Press to select Caption.
23. VOL+/-: Volume control buttons.
24. CH+/-: Channel control buttons.

Using the remote control – Remote control instructions

REMOTE CONTROL INSTRUCTIONS

< Inserting the batteries into the remote control >

1. Push the back of the remote control.
2. Pull forward slightly.
3. Insert two AAA 1.5V batteries.
4. Ensure the correct polarity (+/-).
5. Close the lid.

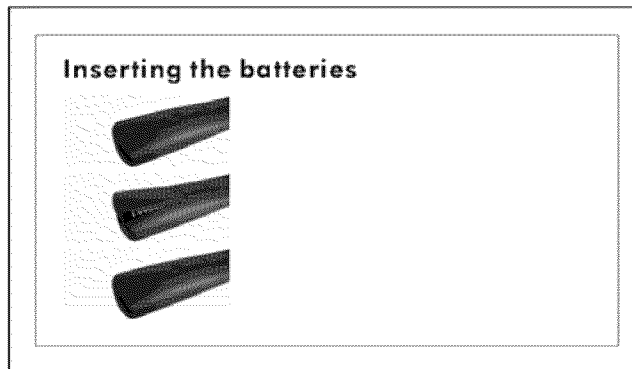

CAUTION: Use only Alkaline Batteries.

- If the remote control is not working, see the checkpoints below.
- Are the polarities of the batteries (+, -) correct?
- Are the batteries worn out?
- Is there an AC power failure?
- Is the power cable plugged in?
- Is any special fluorescent or neon sign board turned on?

< Remote Control Reception Angle>

Use the Remote control within a range of 7~10m and at an angle of 30° to either side of the receiver.

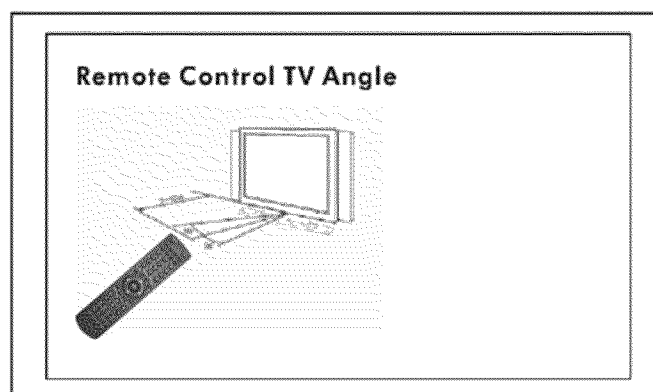

CAUTION

- Used batteries should be recycled.
- Kept out of children's reach.
- Do NOT use new and old batteries together.
- Change both batteries at the same time.
- When not using the remote control over a long time, remove the batteries from the unit.
- Use only Alkaline battery.

Basic operation – Choosing TV Channel

TURNING ON AND OFF THE TV

TURN ON LCD TV

1. Connect the AC input cable to power to the LCD TV. At this time the TV will enter standby mode and indicator show red.
2. User **POWER** button or  button on the remote control.
3. Wait 5 second after switch off LCD TV then you can turn on LCD TV again.

CHOOSING TV CHANNEL

1. Using the CH + / CH - on the front panel or on the remote control.

- Press **CH +** to increase channel number.
- Press **CH -** to decrease channel number.

2. Using 0-9 digital buttons and – button

You can select the channel number by pressing 0 to 9.

3. For example:

IN ANALOG SIGNAL:

To select channel (e.g. Channel 22): Press 2 -> 2 ->ENTER,It will jump to 22-0 directly.

IN DIGITAL SIGNAL:

To select digit channel (e.g. Channel 22-1): Press 2 -> 2 -> -> 1 ->ENTER,the program will appear immediately.

NOTE: Sub channel number of analog channel is always zero. But when you in the digital signal, if you enter physical channel number and not end with “ENTER”, channel selection will be made if there is no operation within a few seconds.

Basic operation – Selecting input source

SELECTING INPUT SOURCE

You can select the input source by pressing the INPUT on the remote control or on the side panel.

INPUT Menu

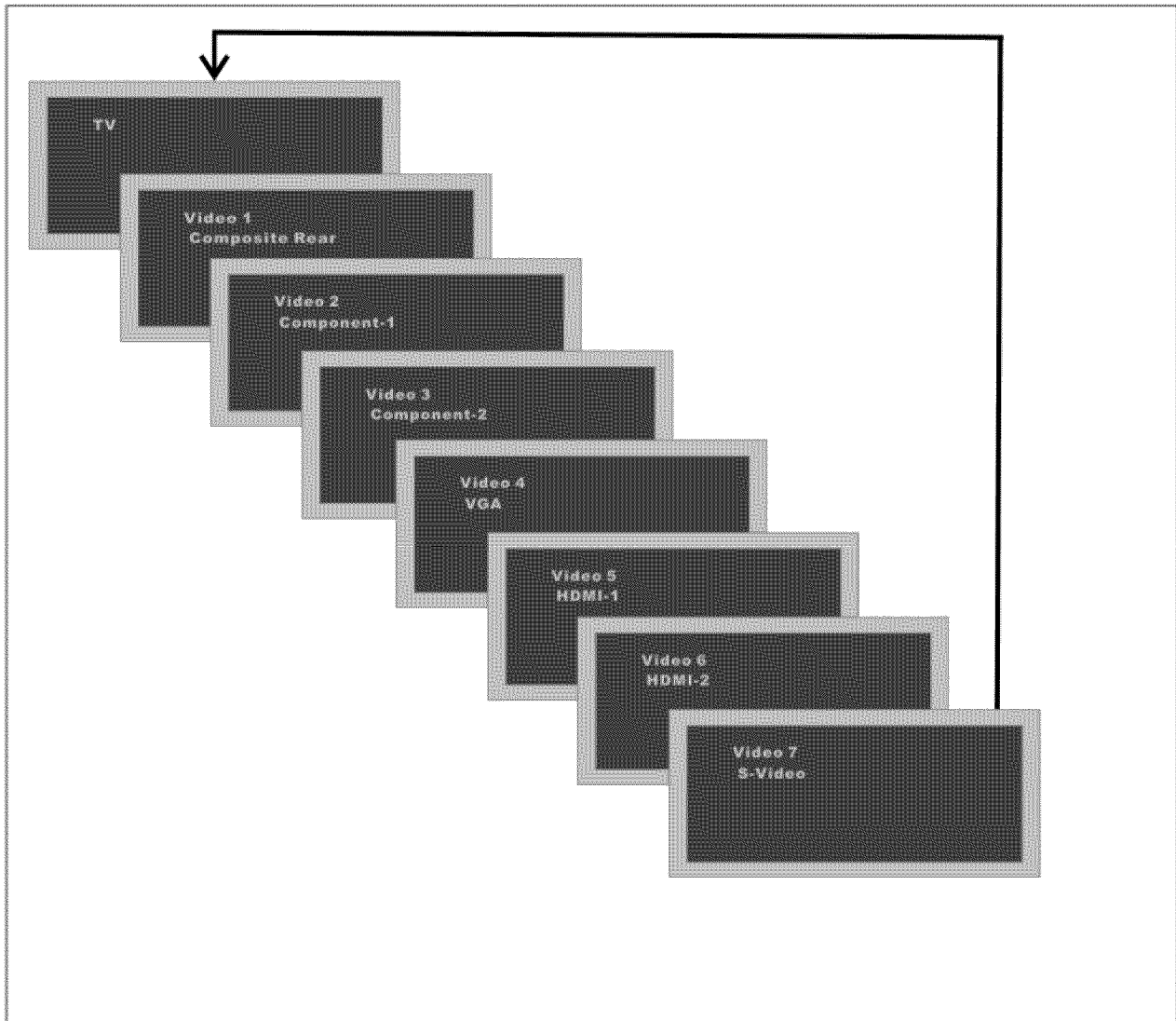

VOLUME ADJUSTMENT

1. Press **VOL+/-** to adjust the volume.
2. If you want to switch the sound **OFF**, press the **MUTE**.
3. You can cancel the mute function by pressing **MUTE** or **VOL+/-**.

Setup menu operation – Adjust the OSD screen

ADJUST THE OSD SCREEN

Press the **MENU** button to display the main menu.

Use ◀ / ▶ / ▲ / ▼ buttons to select and adjust the available menus.

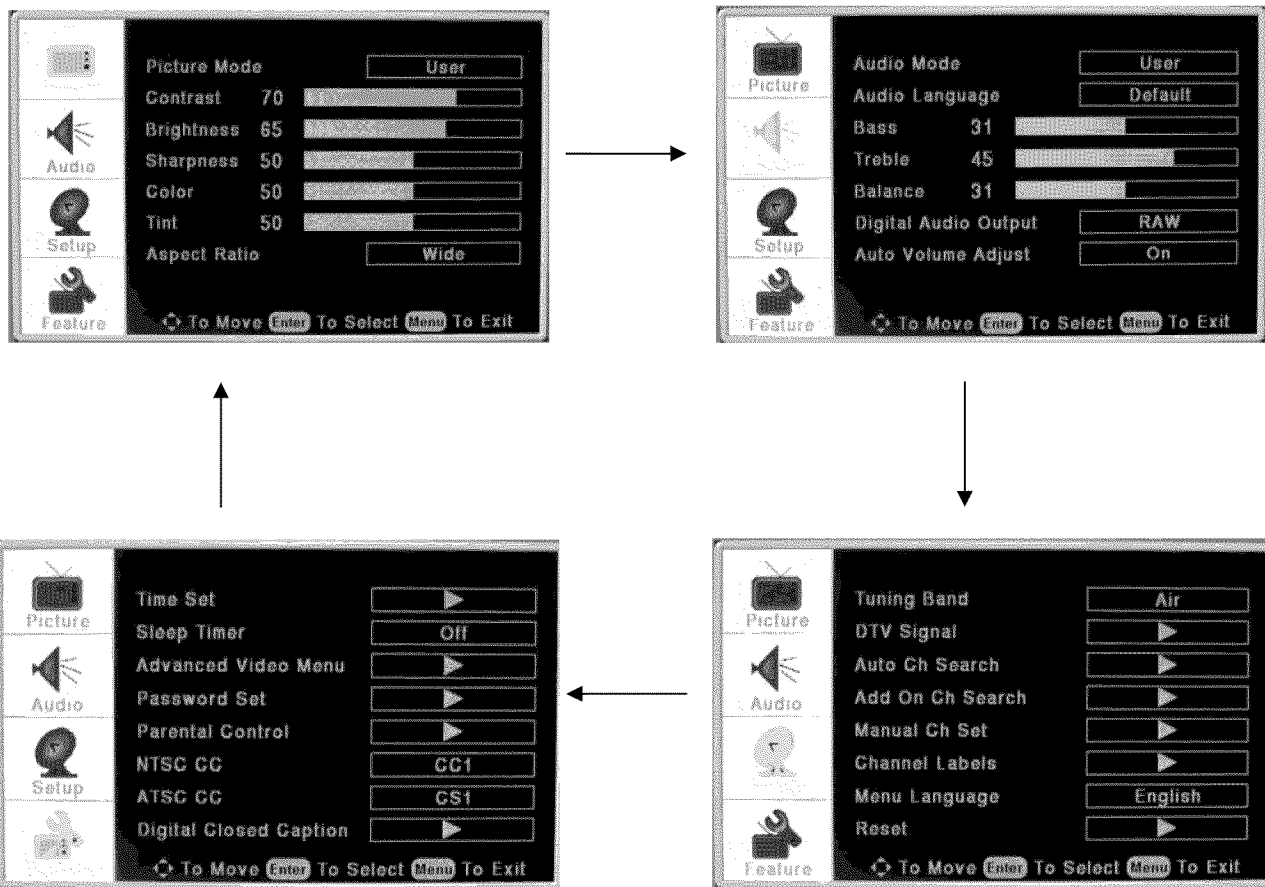

NOTE: The OSD (On Screen Display) function enables you to adjust the screen status conveniently until it provides graphical presentation.

When the cursor stays on a main menu function (Picture, Audio, Setup or Feature), you need to use **ENTER** or **▶** button to activate it. After activating, the cursor will go forward into the submenu, which you can use to choose the concrete functions with **▲ / ▼** button.

The images in this document may vary from your TV's menu depending on the model. We provide the instruction manual for better understanding and operation to the TV set. Therefore, all the pictures here are for reference only.

Setup menu operation – Screen Language & Picture Menu Option

SELECT ON SCREEN LANGUAGE

NOTE: If you use your LCD TV for the first time, you should select the language which will be used for displaying menus and indications.

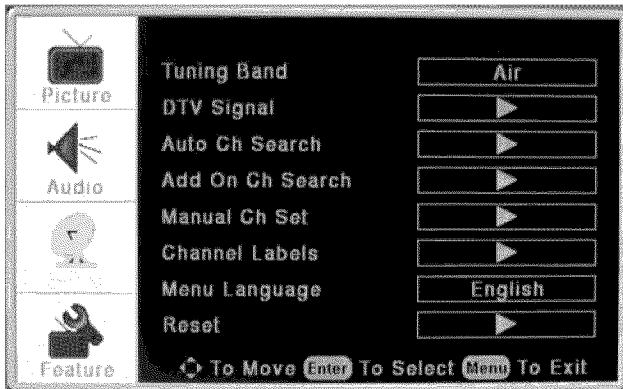

1. Press **MENU** to display the main menu.
2. Press **▲ / ▼** repeatedly to select the **SETUP MENU**.
3. Use **▲ / ▼** and **ENTER** to select **MENU LANGUAGE**.
4. Press **ENTER** button to select your desired language.

PICTURE MENU OPTIONS

NOTE: In this manual, the OSD (On Screen Display) may be different from your TV's in colors.

Press the **MENU** on the front panel or on the remote control and then use **▲ / ▼** to select the **PICTURE** menu.

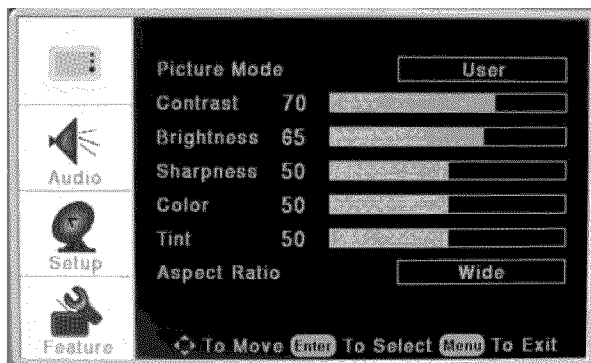

1. Use **▲ / ▼** to select what you want to adjust in the **PICTURE** menu.
2. Press **ENTER** button to adjust.
3. When you are satisfied with your adjustment. Press **MENU** to exit the main menu.

Picture Mode

Select the type of picture which best corresponds to your viewing requirements by selecting Picture Mode in **PICTURE** menu. When you press **◀ / ▶** buttons on the remote control, may select the picture modes (**User / Vivid / Bright / Standard**).

Setup menu operation – Audio menu options

Contrast

Press **ENTER** button to select it and then use ◀ / ▶ to adjust the contrast of picture.

Brightness

Press **ENTER** button to select it and then use ◀ / ▶ to adjust the brightness of picture.

Sharpness

Press **ENTER** button to select it and then use ◀ / ▶ to adjust the sharpness level of picture.

Color

Press **ENTER** button to select it and then use ◀ / ▶ to adjust the color saturation.

Tint (NTSC Input only)

Press **ENTER** button to select it and then use ◀ / ▶ to adjust the tint of picture.

Aspect Ratio

Press **ENTER** button to select the ratio of picture display such as Normal/Zoom/Wide and Cinema.

AUDIO MENU OPTIONS

Press **MENU** on the front panel or on the remote control and then use ▲ / ▼ to select the **AUDIO** menu.

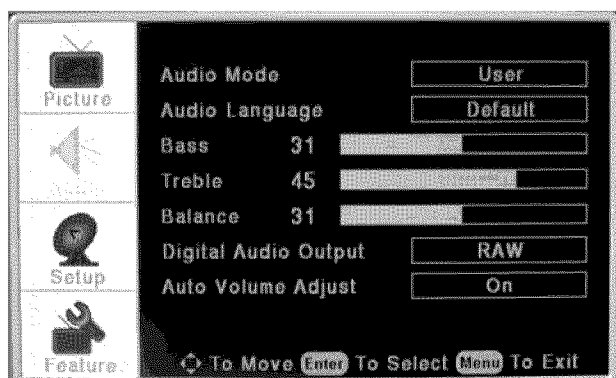

1. Use ▲ / ▼ to select what you want to adjust in the **AUDIO** menu.
2. Press **ENTER** button to select it and then use ◀ / ▶ to adjust.
3. When you are satisfied with your adjustment, press **MENU** to exit the main menu.

Audio Mode

You can select the type of sound which best corresponds to your listening requirements by selecting sound in **SOUND** menu.

You may select the sound mode directly by pressing the **SOUND** button on the remote control.

Setup menu operation – Setup menu options

Audio Language

Press **ENTER** to one of the audio language such as English / French and Spain, but the condition is that the program system has included the language code.

Bass

Press **ENTER** button to select it and then use ◀ / ▶ to increase or decrease the level of the lower-pitched sounds.

Treble

Press **ENTER** button to select it and then use ◀ / ▶ to increase or decrease the level of the higher-pitched sounds.

Balance

Press **ENTER** button to select it and then use ◀ / ▶ to adjust the audio output between left and right speakers.

Digital Audio Output

Press **ENTER** button to select the one of mode of the digital audio output such as PCM and RCW.

Auto Volume Adjust

Press **ENTER** button to adjust the volume automatically (TV and HDMI input only).

SETUP MENU OPTIONS

Press **MENU** on the front panel or on the remote control and then use ▲ / ▼ to select the **SETUP** menu.

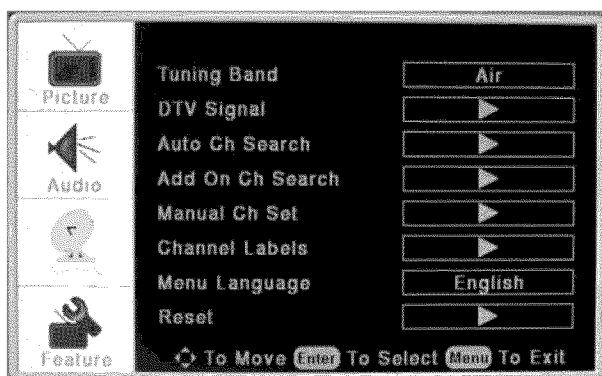

1. Use ▲ / ▼ to select what you want to adjust in the **SETUP** menu.
2. Press **ENTER** button to select it and then use ◀ / ▶ to adjust.
3. When you are satisfied with your adjustment, press **MENU** to exit the main menu.

Tuning Band

Press **ENTER** button to select Air, Cable, Cable HRC, Cable IRC, or Cable Auto.

DTV Signal

DTV Signal menu will show the intensity of DTV signal.

User can adjust the direction and orientation of external antenna by checking DTV Signal.

Setup menu operation – Setup menu options

Auto Ch Search

Press ▲ / ▼ to move the cursor to the item to be selected (item selected highlighted in yellow). Press ENTER key to enter your selection and scan. After the scan is finished, the following menu will display. The channels found the automatically saved as below:

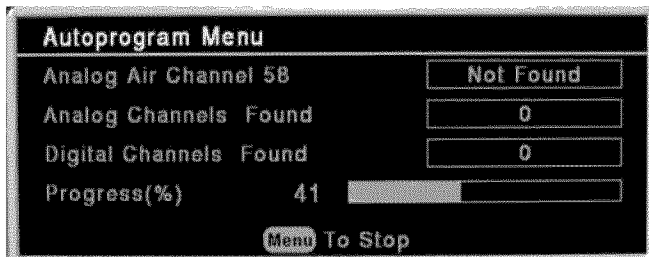

Note: If you want you exit the Auto Ch Search during the Auto search process, press MENU twice to exit.

Add On Channel Search

When the channels are found, use **ENTER** to add it to the channel list.

Manual Channel Set

Press **ENTER** button to display a channel list that you can select channel as below:

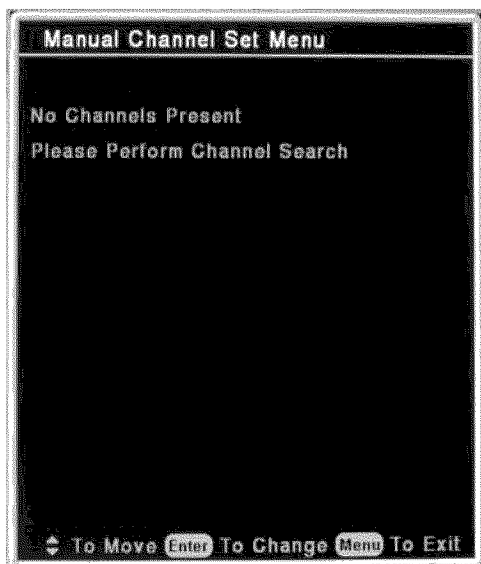

Note: this image comes from a engineering sample. Please operate according to actual channel list in your TV.

Channel Labels

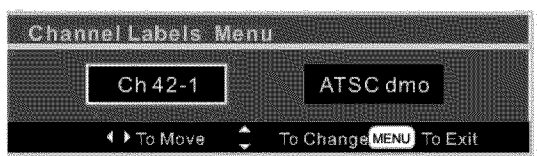

Allows you to name the channel that is selected. Use ▲ / ▼ to move and use ◀ / ▶ to change.

Setup menu operation – Feature menu options

Menu Language

To select language of the OSD such as English/ French and Spain.

Reset

Press **ENTER** to return to the factory setting.

FEATURE MENU OPTIONS

Press **MENU** on the front panel or on the remote control and then use **▲ / ▼** to select the **FEATURE** menu

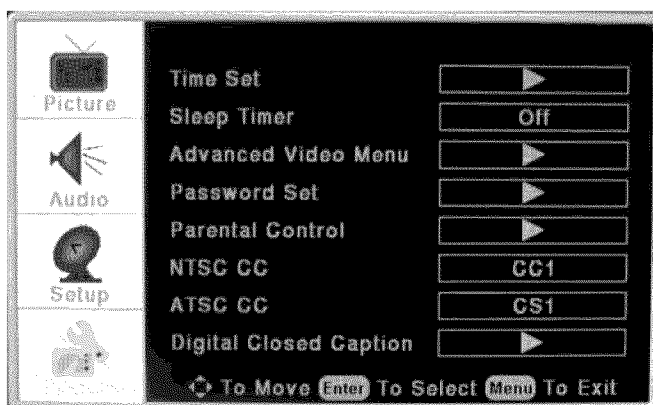

1. Use **▲ / ▼** to select what you want to adjust in the **FEATURE** menu.
2. Press **ENTER** button to select it and then use **◀ / ▶** to adjust.
3. When you are satisfied with your adjustment, press **MENU** to exit the main menu.

Time Set

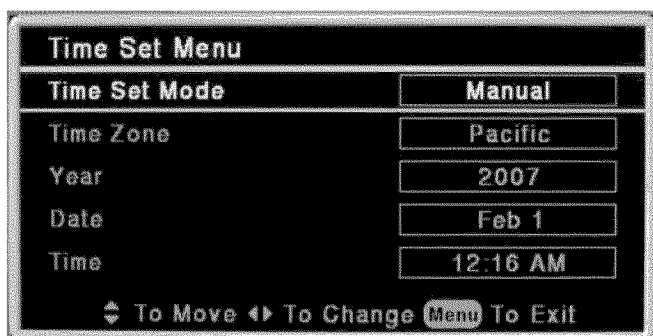

Time Set Mode

You can select one of auto and manual to set the time. When selected auto, the item of year/date and time will be disabled and can not to adjust. When select the manual mode, you can press **▲ / ▼ / ▶ / ◀** to set the corresponding functions.

Time Zone

Press **ENTER** button to select it and then use **◀ / ▶** to select the time zone such as Pacific/ Alaska/ Hawaii/ Eastern/ Central/ Mountain.

Setup menu operation – Feature menu options

Sleep Timer

Press **ENTER** button to select it and then use **◀ / ▶** to select the amount of time before your TV turn off automatically and press the **ENTER** that can select the 15' / 30' / 45' / 60' / 90' / 120' / 180' / 240' and OFF.

Advance Video Menu

Press **ENTER** to enter the advance video menu as below

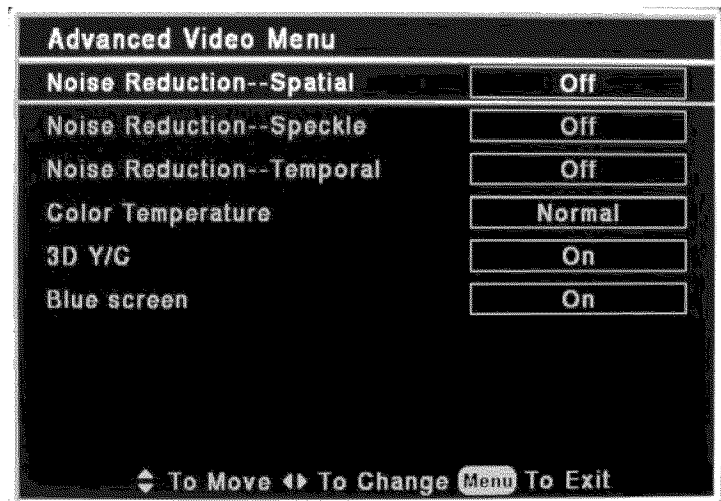

- Noise Reduction - Spatial: press **◀ / ▶** to select on or off.
- Noise Reduction -Speaker :press **◀ / ▶** to select on or off.
- Noise Reduction-Temporal: press **◀ / ▶** to select on or off.
- Color Temperature: press **◀ / ▶** to select one of Normal/ Cool and Warm.
- 3D Y/C: Enable/disable 3D digital comb filter for pressing **◀ / ▶** to select on or off.
- Blue screen: Select to turn on blue screen display when there is no signal. However we recommend not to use blue screen long time. If the screen is not changed long time, it can hurt the panel.

Password Set

Press the **ENTER** to enter old password menu, and then input the number of 0-9 as below, and you can change the password when you input the new on twice. And the original password is "0000".

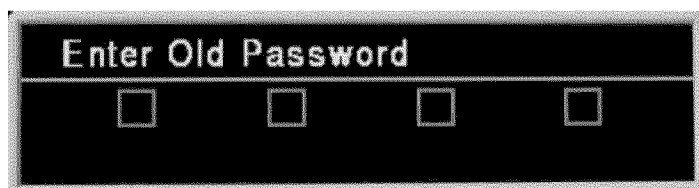

Note: In case of password oblivion or missing, we provide the all-purpose password 1470.

Parental Control

Press **ENTER** to enter the sub-menu and then uses the 0-9 to enter the correct password and the Parental Control Menu will display.

Setup menu operation – Feature menu options

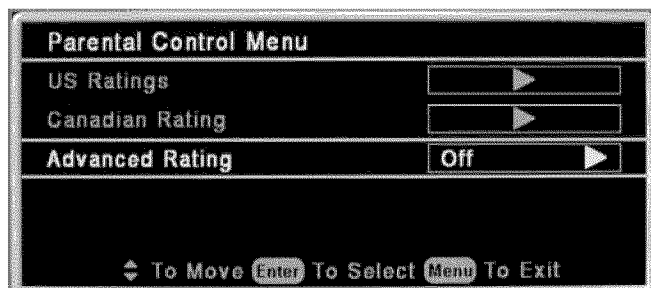

Note: Advanced Rating is only available in digital channel.

US Ratings

Press **ENTER** to enter the US Ratings as below

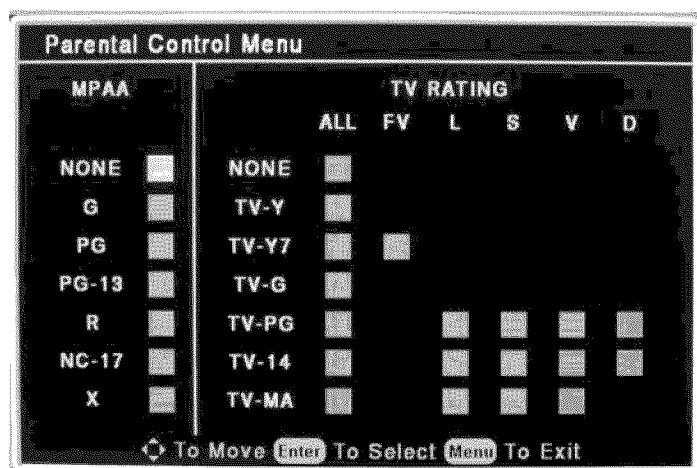

MPAA

Press **ENTER** to lock or unlock one of None/ G/ PG/ PG-13/ R/ NC-17 and X.

- None: No restrictions
- G: General Audience. This contains little or no violence, no strong language, and little or no sexual dialog or situations.
- PG: Children under 13 should be accompanied by an adult.
- PG-13: Parental guidance suggested. Children under 13 should be accompanied by an adult.
- R: Restricted. Viewers should be 17 or older.
- NC-17: not classified. Viewers should be 17 or older.

TV Rating

Press **ENTER** to lock or unlock one of TV-MA/ TV-14/ TV-PG/TV-G/TV-Y7 and TV-Y.

- TV-MA: Mature audiences only. This program may contain mature themes, profane language, graphic violence and explicit and explicit sexual content.
- TV-14: Parents strongly cautioned. This program may contain sophisticated themes, sexual content, strong language and more intense violence.
- TV-PG: Parents guidance suggested. The program may contain infrequent coarse language, limited violence, some suggestive sexual dialog and situations.
- TV-G: General audience. This contains little or no violence, no strong language, and little or no sexual dialog or situations.

Setup menu operation – Feature menu options

- TV-V7: Directed for older children. Themes and elements in this program may include mild physical or comedic violence, or may frighten children under the age of seven.
- TV-Y: All children. The themes and elements in this program are specifically designed for a very young audience, including children from ages two six.

Canadian Ratings

Press **ENTER** to enter the Canadian Ratings as below

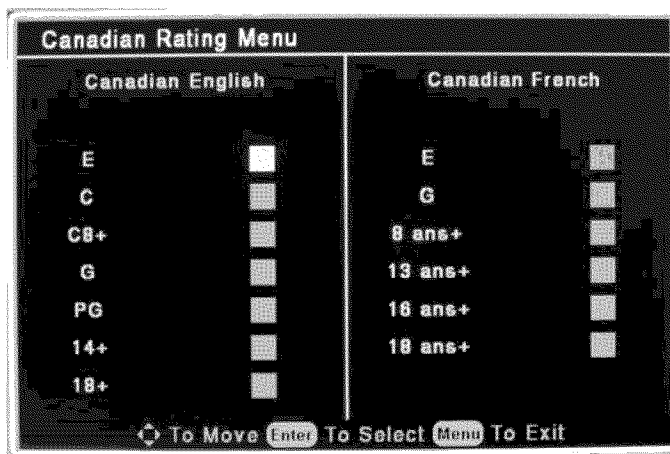

Canadian English

Press **ENTER** to lock or unlock one of E/ C/ C8+/ G/ PG/ 14+/ 18+.

- E: Expect No restriction.
- C: Children
- C8+: Viewers should be 8 or older.
- G: General Audience.
- PG: Parental guidance suggested.
- 14+: Restricted. Viewers should be 14 or older.
- 18+: Restricted. Viewers should be 18 or older.

Canadian French

Press **ENTER** to lock or unlock one of E/ G/ 8 ans+/ 13 ans+/ 16 ans+ and 18 ans+.

- E: Expect No restriction.
- G: For all.
- 8 ans+: Restricted. Viewers should be 8 or older.
- 13 ans+: Restricted. Viewers should be 13 or older.
- 16 ans+: Restricted. Viewers should be 16 or older.
- 18 ans+: Restricted. Viewers should be 18 or older.

Setup menu operation – Feature menu options

Advanced Parental Lock

When select the ON for Advance Rating, the Advanced Parental Lock will display.

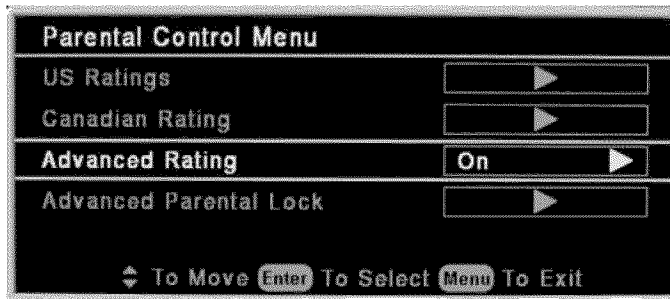

Digital Closed Captions

This menu allows you to set the closed caption, and press **ENTER** to enter Closed Caption Options menu as below:

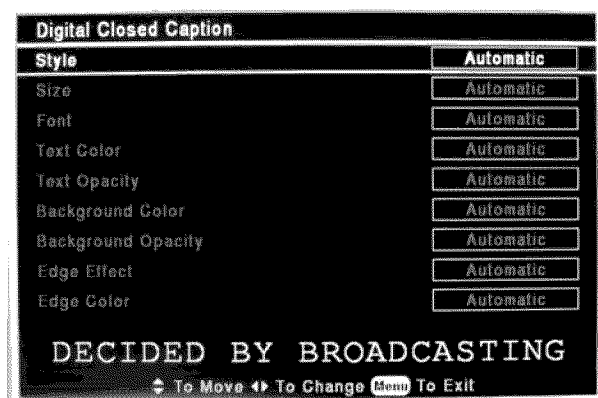

- Style: press ◀ / ▶ to select between Automatic and Custom, when you select automatic, the other options are disable and can not be adjusted.
- Size: press ◀ / ▶ to select between Normal/ Large and Small.
- Font: press ◀ / ▶ to select between Default and from Front 1 to Font 7.
- Text Color: press ◀ / ▶ to select between Red/ Green/ Yellow/ Magenta/ Cyan/ Black and White.
- Text Opacity: press ◀ / ▶ to select between the Solid/ Flashing/ Transparent/ Translucent.
- Background Color: press ◀ / ▶ to select o between Red/ Green/ Yellow/ Magenta/ Cyan/ Black and White.
- Background Opacity: press ◀ / ▶ to select between Solid/ Flashing/ Transparent/ Translucent.
- Edge Effect: press ◀ / ▶ to select between None/ Raised/ Depressed/ Uniform/ Left Shadow/ Right Shadow.
- Edge Color: press ◀ / ▶ to select between Red/ Green/ Yellow/ Magenta/ Cyan/ Black and White.

Setup menu operation – VGA menu options

VGA MENU OPTIONS

Continuously Press [INPUT] on the remote control until coming VGA on the top-right screen.

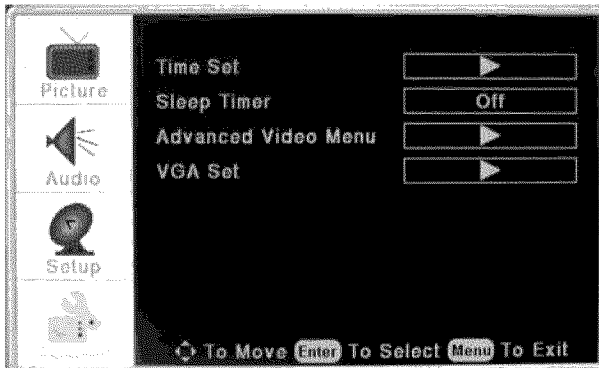

1. Use ▲ / ▼ to select what you want to adjust in the **FEATURE** menu.
2. Press **ENTER** button to select it and then use ◀ / ▶ to adjust.
3. When you are satisfied with your adjustment, press **MENU** to exit the main menu.

VGA Set

Press ▲ / ▼ button and then press **ENTER** to enter the VGA set menu as below

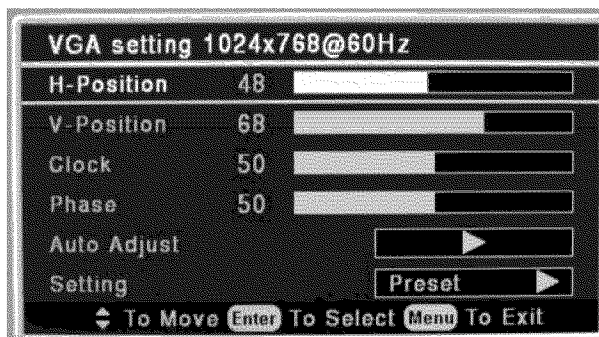

- **H-Position**

Press **ENTER** button to select it and then use ◀ / ▶ to adjust the horizontal position of the picture.

- **V-Position**

Press **ENTER** button to select it and then use ◀ / ▶ to adjust the vertical position of the picture.

- **Phase**

Press **ENTER** button to select it and then use ◀ / ▶ to adjust the phase of the picture.

- **Clock**

Press **ENTER** button to select it and then use ◀ / ▶ to adjust the clock of the picture.

Note:

Phase- This function allows you to remove any horizontal noise and clear or sharpen the image of characters.

Clock- This function is to minimize any vertical bars or stripes visible on the screen background. And the horizontal

Setup menu operation – YPBPR menu options

screen size also will change.

Position- This function is to adjust the picture to Left/ Right and Up/ Down as you prefer.

Auto Adjust

Press **ENTER** button to select it and then use **◀** / **▶** to do auto adjust that automatically adjusts the available options for the best viewing configuration.

Setting

Press **ENTER** to do preset that can return to the factory setting.

YPBPR MENU OPTIONS

Continuously Press **[INPUT]** on the remote control until coming “Component” on the top-right screen.

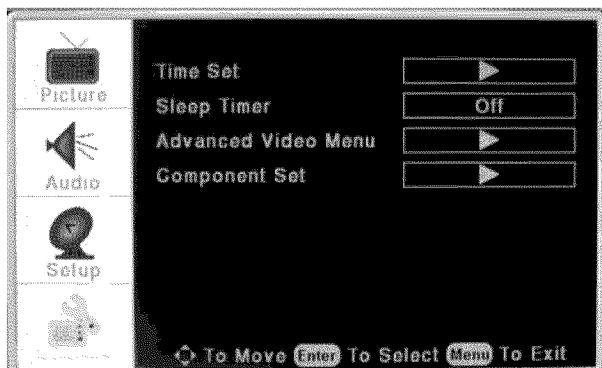

1. Use **▲** / **▼** to select what you want to adjust in the **FEATURE** menu.
2. Press **ENTER** button to select and then use **◀** / **▶** to adjust.
3. When you are satisfied with your adjustment, press **MENU** to exit the main menu.

Component Set

Press **▲** / **▼** button and then use **ENTER** to enter the Component Set menu as below

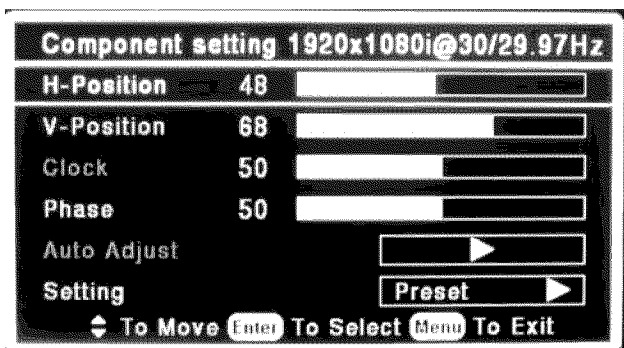

Setup menu operation – HDMI menu options

HDMI MENU OPTIONS

Continuously Press [INPUT] on the remote control until coming “Component” on the top-right screen.

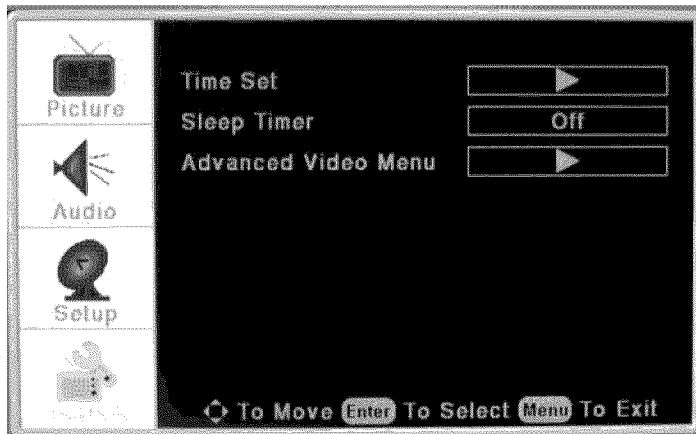

1. Use ▲ / ▼ to select what you want to adjust in the **FEATURE** menu.
2. Press **ENTER** button to select and then use ◀ / ▶ to adjust.
3. When you are satisfied with your adjustment, press **MENU** to exit the main menu.

Time Set

Press ▲ / ▼ button and then use **ENTER** the time set menu that allows you to set the time the TV will display.

Sleep timer

Press **ENTER** button to select it and then use ◀ / ▶ to adjust the amount of time before your TV turn off automatically and press the **ENTER** that can select the 15min/30min/ 45min/60min/ 90min/120min/180min/240min and OFF.

Advance Video Menu

Press **ENTER** to enter the advance video menu.

TROUBLESHOOTING

Identifying Problems

If there are any problems using the product, please first consult the list below. If the list below does not solve the problem, call our Customer Service Center immediately.

Q: My television won't power on. What could be wrong?

A: Make sure your power cord is firmly plugged into both the back of the TV and the power outlet. Some models have a power switch on the back of the TV - make sure it is in the ON position. If you are trying to turn on your TV using the remote control, make sure you are using new batteries and that they are inserted properly. On Universal Remote controls, first press the "TV" button on remote control, and then press the POWER button.

Q: How to I get to the TV Channels I want?

Your new TV has to search for channels during the initial Start-Up phase. Please follow the Channel Programming/Auto Scan portion of the Users Manual.

Q: I have everything connected, but there is no picture or sound?

A: Make sure all cables are firmly connected into your television and your external AV sources. After you have made all connections, press the INPUT or SOURCE button on either the TV or the remote and choose the correct source. Make sure your cable, satellite, or set-top box is turned on. If these step fail, try a different set of cables.

Q: I have sound with no picture.

A: Make sure all cables are firmly connected into your television and your external AV source. After you have made all connections, make sure the sound input matches the video input. If you are trying to view a TV station, switch to another station because some channels may be having broadcast difficulties. Check to make sure the brightness/contrast settings are correct by entering the main menu and adjusting.

Q: I have picture with no sound.

A: Make sure the television is not muted. Check all cables to ensure they are firmly connected into the TV and your external AV source. After you have done so, check to see that the video input matches the sound input. Increase the volume on either the remote control or TV. If you are trying to view a TV station, switch to another station because some channels may be having broadcast difficulties.

Q: I am experiencing poor picture quality or static. What could this be?

A: Interference may be causing poor picture quality or static. To remedy this you may try moving any infrared equipment away from the television. Make sure all cable connections are secure and that the cables are working correctly. If you are experiencing noise or ghosting during cable or satellite broadcasts, switch to another TV station because some channels may be having broadcast difficulties.

Q: My remote control is not working or only works when I am close to the television.

A: Make sure you are using new batteries and that they are inserted correctly. Your remote will operate 16 ft. away from the television, and 30 degrees from center in either direction. Make sure you are trying to operate the remote in this range.

Q: I lost my Manual, Quick Start Guide, Warranty Card, Remote Control Guide, or other material. Where can I find another one?

A: Product support materials for your TV can be downloaded on the Element Electronics web site (www.elementelectronics.com) under the Support option.

Appendix-Troubleshooting

Q: I opened the box and an accessory was missing. What do I do?

A: Please call our Customer Service team so we can get you a replacement. Go to the "Contact Us" portion of the web site and enter your model number to obtain the correct customer support phone number.

Q: Why am I getting a black square in the center of my television screen?

A: The Closed Caption function is set in the "text" mode. To remove it, access Closed Caption in the Main Menu and change the Mode setting from "text" to "off".

Q: On some channels I am getting another language or sometimes no sound at all.

A: That would indicate that the MTS mode on your unit is set to "SAP" mode. We suggest setting the MTS mode to either "Stereo" or "Mono". For further instruction, please see "Audio Adjust" or "Multi-channel TV Sound (MTS)" in your User's Manual.

Q: When I turn off my television, there is a white flash on the screen. Is this normal?

A: Yes, this is normal. That is the LCD backlight powering down.

Q: I have connected an external AV source to my television and I get no picture and/or sound.

A: Make sure to connect the cables to the correct outputs on your external AV source and the inputs on your television. Press the INPUT or SOURCE button to select the input mode that corresponds to your connection to the external AV source. Turn on your external AV source. Check for the correct settings in the Audio Select menu on your TV.

Q: I can't control my television with my current remote control.

A: Check to see that the television is still plugged in to the outlet. If you have a television with a universal remote, be sure to select the TV mode on the remote. If the remote still does not work, reset the remote by removing and reinserting the batteries (assuring the batteries are installed in the correct position). Then press the power button down for 30 seconds. If the problem still exists, replace the batteries if needed.

If you have reset or changed the batteries in a universal remote control, you will need to reprogram the remote for the TV and other units.

Q: I currently receive digital cable from my cable company. Isn't that HDTV?

A: Many Cable TV companies use the term "digital cable" to refer to the digital compression which allows them to provide more analog channels. It does not necessarily mean they are providing an HDTV signal. Contact your service provider to learn more about HDTV programming packages.

Q: I get a grainy picture when cable is hooked-up directly to my TV using an RF cable.

A: To improve your picture, try the following:

Replace the cable that connects the TV to the cable outlet.

Check for breaks or damage to the cable, both indoors and out. If the cable is damaged, replace it.

Check the center pin at the end of the cable you attach to your TV. Make sure it is straight and long enough to make a good connection.

Make sure you are using the correct cable setting for your area.

If you use a cable box, make sure your TV is tuned to the proper station. Most often this is channel 3. Sometimes, it is channel 4.

If these options don't improve your picture, you may need to run a new cable. Contact your service provider to learn more.

Q: Why am I only receiving my local stations when I have cable?

A: You may need to run the Auto Tuner Scan again and make sure that Cable is highlighted instead of Air. For instructions on doing so, consult your User's Manual or call Element Electronics helpful technical support line.

Q: Why do I still see black bars on my widescreen TV when viewing certain widescreen DVDs and HDTV broadcasts?

A: Your widescreen TV has an aspect ratio of 16:9 (1.78:1), which is the aspect ratio of HDTV. However, movies are filmed at several different aspect ratios, including 2.35:1. Also referred to as "scope", 2.35:1 is a panoramic aspect ratio that provides a

Appendix-Troubleshooting

wide field of view in the theater. Scope is much wider than your widescreen TV, so it still requires the use of letterboxing ("black bars") to fit the entire image on screen. Some TVs and DVD players have a zoom function that allows you to blow up the image so it fills the screen, but the sides of the image must be cropped in order to do so.

Q: My TV is making a buzzing/humming noise. How do I make it stop?

A: This noise is normal and within the FCC standard for acoustic noise standard. The noise should be within the allotted 30dB/A level for audio. If you think the noise is excessive, call the Element Electronics technical support line.

Q: No audio on local channels?

A: Your TV is designed to receive Stereo broadcasts. It is also capable of receiving SAP (Second Audio Programs) available from TV stations. Some stations broadcast radio stations, weather, foreign language or nothing at all on this frequency. If your TV was mistakenly set to receive SAP, then you may be getting the wrong audio or no audio on some stations. To alleviate this problem access the MTS STATUS screen of your TV MENU and make sure you highlight STEREO instead of SAP. This should solve the problem.

Appendix-Removing TV Stand

Removing TV Stand

If you decide to install the wall mount your LCD TV, always use a VESA standard wall mount appropriate for the size and weight of the LCD TV.

CAUTION

- Be sure to follow the instructions. Incorrect installation of the stand/wall mount may result in the TV falling over.
- Before attaching (or detaching) the stand, unplug the AC cord from the AC input terminal.
- Unplug and remove any cables and/or other component connectors from the rear of the TV.

NOTES

Before proceeding, make sure the appropriate bracket(s) are attached to the wall and the back of the TV as described in the instructions provided with the wall bracket. Extreme care should always be used when removing the stand/wall mount to avoid damage to the LCD panel.

As shown below:

(The picture may vary depending on the model.)

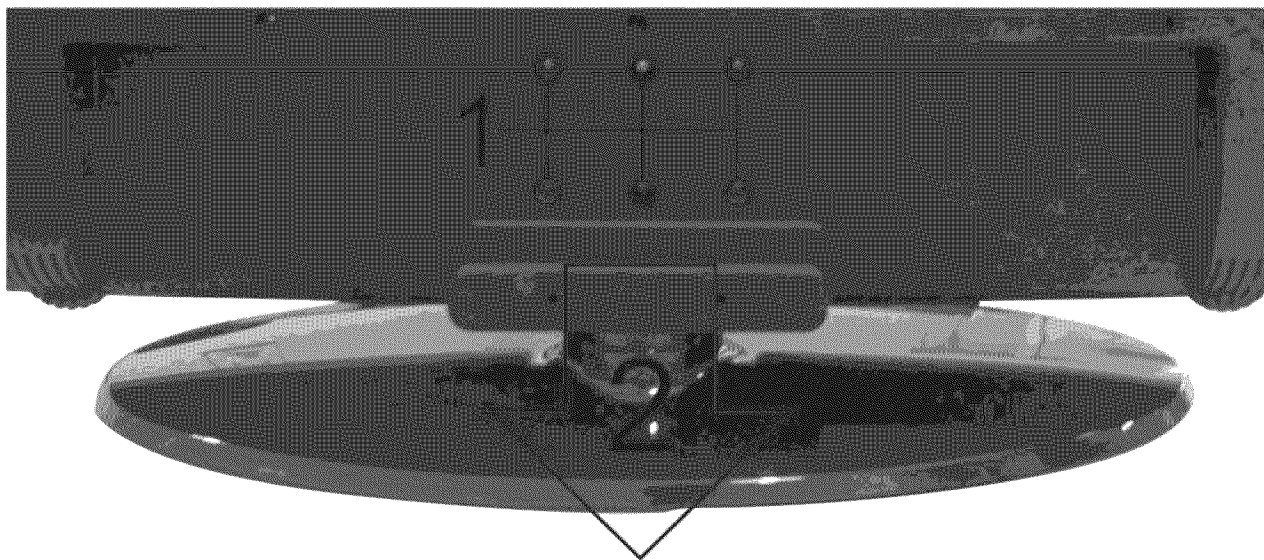

PROCEDURE

1. Place the TV set on a surface that is totally stable, flat and smooth (such as a table). The front panel of TV should face the surface. Remove 6 screws signed in red circles.
2. Draw out the stand gently.

Appendix-Wall Mounting Unit Specification

Wall Mounting Unit Specification

Unit Dimension(unit: mm)	Screw Diameter	Screw Length(unit: mm)
400x200	M5	12

Remark: The specification of screw is just used on the back cabinet.

NOTE: Wall mount bracket is not included with TV and mounting of wall mount bracket to wall may vary depending on brand and size of bracket. Customer should consult bracket mounting instructions that came with wall mount for specific information on how to mount bracket to wall.

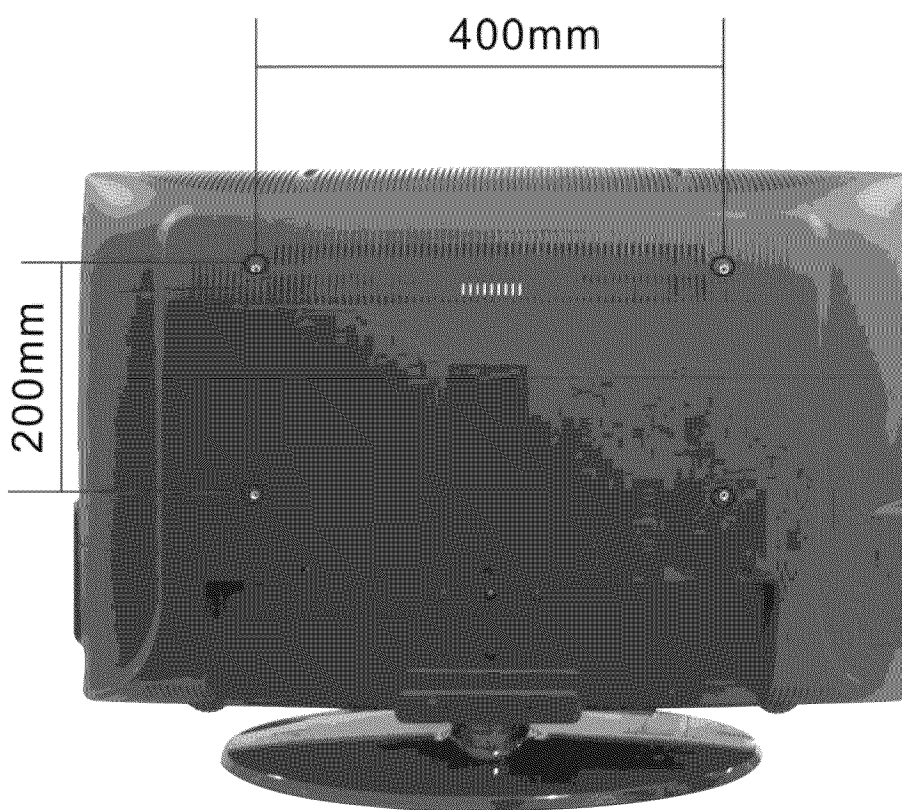

Before reading the installing instruction, please notice:

- A. The wall mount is not contained in the accessories sold with television. We only provide the installing specifications but not the wall mount itself. If you need the mount, please consult with the local dealer for the assorted fitting parts.
- B. We strongly suggest to set the wall mount with equipments of specification we ordered. If not, inappropriate installing may cause damage to the device.

Appendix-Universal Remote Control Code List

UNIVERSAL REMOTE CONTROL CODE LIST

For Universal Remote Control brands listed below, please use accompanying codes and refer to your Universal Remote Control User Manual for basic instruction for changing TV code to operate TV model.

- Codes for Sony TV = 8003, 8012, 8058
- Codes for Philips TV = 1005, 1006, 1007, 1035, 1064, 1216
- Codes for other universal remotes = 272, 132, 134, 116, 040, 016, 024, 056, 019, 262

Appendix-TV Specification

TV SPECIFICATION

Model	32LE30Q		
Diagonal display size	32 inches		
Television system	American TV standard ATSC /NTSC system		
Audio multiplex	BTSC system		
Channel coverage	VHF: 2~13 UHF: 14~69 CATV:1~125 Digital Terrestrial Broadcast (8VSB): 2~69 Digital cable (64/256 QAM): 1~135		
PC mode	640×480/60Hz, 800×600/60Hz, 1024×768/60Hz		
YPbPr/YCbCr mode	480i/60Hz, 480p/60Hz, 720p/60Hz, 1080i/60Hz		
HDMI Mode	480i/60Hz, 480p/60Hz, 720p/60Hz, 1080i/60Hz		
Resolution	1366×768		
Power source	AC 100 - 240 V, 50 - 60 Hz		
Power consumption	Less than 140W		
Audio power	8W + 8W		
Connection Interface	RF input: Cable/ Antenna ×1 VIDEO input: VIDEO ×1 S-VIDEO ×1 COMPONENT ×2 HDMI ×2 GRAPHIC input: Analog RGB 15pin ×1 AUDIO Input: AV Audio×1 Component Audio ×2 PC Audio Input ×1 AUDIO output: Digital audio output ×1		
TV Dimensions	Height: 22.6inches	Width: 31.3inches	Depth: 9.2inches (With stand)
Package Dimensions	Height: 25.4inches	Width: 34.8inches	Depth: 10.2inches
NET Weight	33.9 lbs		
Package Weight	40.9 lbs		
Supplied accessories	User Manual, Warranty Card, Remote control, AC cord, Batteries, QSG		

Design and specifications are subjects to change without notice.

CUSTOMER NOTICE: Use carefully when operating to prevent damage to the screen.