

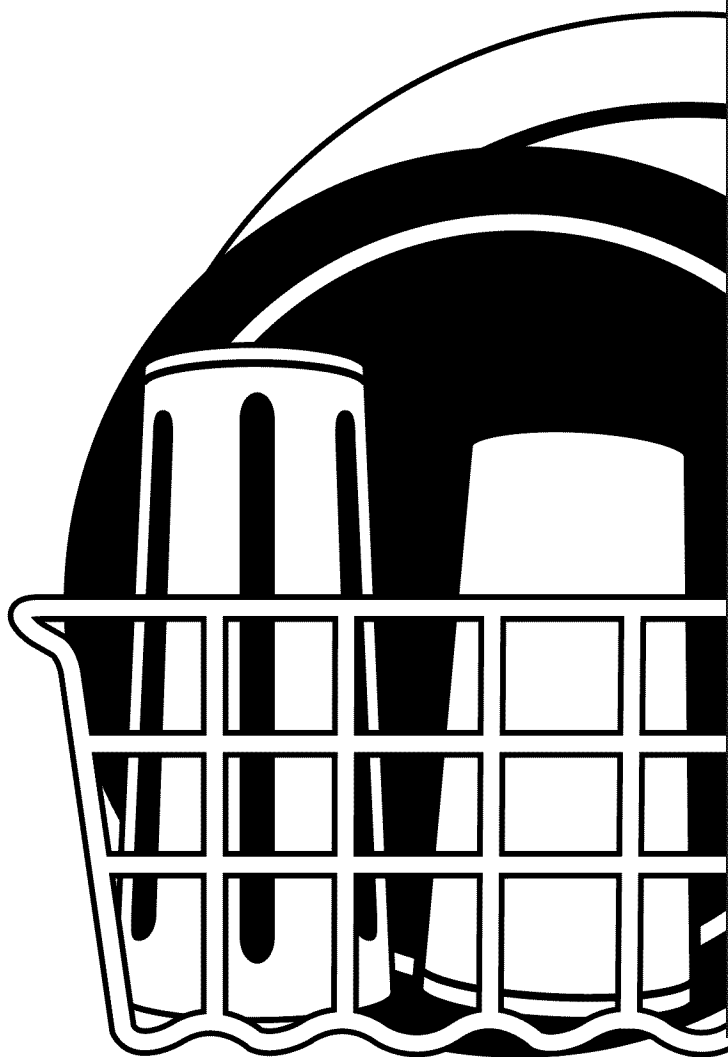

Use And Care

G U I D E



A Note to You.....	2
Dishwasher Safety.....	3
Parts and Features.....	4
Starting Your Dishwasher.....	5
Loading Your Dishwasher.....	7
Using the Dispensers.....	11
Setting the Controls.....	13
Selecting a wash cycle.....	13
Using Cancel/Drain.....	15
Selecting cycle options.....	15
Changing a cycle or option.....	16
Adding items during a cycle.....	16
Using Delay Hours.....	17
Understanding the status indicators.....	18
Washing Special Items.....	19
Caring for Your Dishwasher.....	20
Saving Energy.....	22
Solving Common Dishwashing Problems.....	23
Troubleshooting.....	26
Requesting Assistance or Service.....	27
Warranty.....	32

DISHWASHER MODEL SERIES 980

A Note to You

Thank you for buying a WHIRLPOOL® appliance.

The Whirlpool Brand is committed to designing quality products that consistently perform for you to make your life easier. To ensure you enjoy years of trouble-free operation, we developed this Use and Care Guide. It contains valuable information about how to operate and maintain your appliance properly and safely. Please read it carefully.

Also, please complete and mail the Ownership Registration Card provided with your appliance. This card helps us notify you about any new information on your appliance.

Please record your model's information.

Whenever you call to request service for your appliance, you need to know your complete model number and serial number. You can find this information on the model and serial number label (see the "Parts and Features" section).

Please also record the purchase date of your appliance and your dealer's name, address, and telephone number.

Model Number _____

Serial Number _____

Purchase Date _____

Dealer Name _____

Dealer Address _____

Dealer Phone _____

Keep this book and the sales slip together in a safe place for future reference.

**Our Consumer Assistance
Center number is toll free.**

1-800-253-1301

In Canada, for assistance or service, see the "Requesting Assistance or Service" section.

To find detailed product information, the location of the nearest Whirlpool dealer or designated servicer, to purchase an accessory item, or register your appliance on-line, please visit our Web site at www.whirlpool.com

In Canada visit our Web site at www.whirlpool.com/canada

Help us help you

Please:

- Have your dishwasher installed by a qualified installer.
- Install where dishwasher is protected from the elements.
- Install and level dishwasher on a floor that will hold the weight, and in an area suitable for its size and use.
- Properly connect dishwasher to electricity, water, and drain.*
- Remove all shipping plugs from hoses and connectors (such as the cap on the drain outlet) before installing.*
- Remove all hang tags and temporary labels.
- Make sure dishwasher is not used by anyone unable to operate it properly.
- Properly maintain dishwasher. See the "Caring for Your Dishwasher" section.

* See Installation Instructions for complete information.

Dishwasher Safety

Your safety and the safety of others is very important.

We have provided many important safety messages in this manual and on your appliance. Always read and obey all safety messages.



This is the safety alert symbol.

This symbol alerts you to hazards that can kill or hurt you and others.

All safety messages will be preceded by the safety alert symbol and the word "DANGER" or "WARNING." These words mean:

⚠ DANGER

You will be killed or seriously injured if you don't follow instructions.

⚠ WARNING

You can be killed or seriously injured if you don't follow instructions.

All safety messages will identify the hazard, tell you how to reduce the chance of injury, and tell you what can happen if the instructions are not followed.

IMPORTANT SAFETY INSTRUCTIONS

WARNING: When using the dishwasher, follow basic precautions, including the following:

- Read all instructions before using the dishwasher.
- Use the dishwasher only for its intended function.
- Use only detergents or rinse agents recommended for use in a dishwasher and keep them out of the reach of children.
- When loading items to be washed:
 - 1) Locate sharp items so that they are not likely to damage the door seal; and
 - 2) Load sharp knives with the handles up to reduce the risk of cut-type injuries.
- Do not wash plastic items unless they are marked "dishwasher safe" or the equivalent. For plastic items not so marked, check the manufacturer's recommendations.
- Do not touch the heating element during or immediately after use.
- Do not operate the dishwasher unless all enclosure panels are properly in place.
- Do not tamper with controls.
- Do not abuse, sit on, or stand on the door or dish racks of the dishwasher.
- To reduce the risk of injury, do not allow children to play in or on the dishwasher.
- Under certain conditions, hydrogen gas may be produced in a hot water system that has not been used for two weeks or more. HYDROGEN GAS IS EXPLOSIVE. If the hot water system has not been used for such a period, before using the dishwasher turn on all hot water faucets and let the water flow from each for several minutes. This will release any accumulated hydrogen gas. As the gas is flammable, do not smoke or use an open flame during this time.
- Remove the door to the washing compartment when removing an old dishwasher from service or discarding it.

SAVE THESE INSTRUCTIONS

Parts and Features

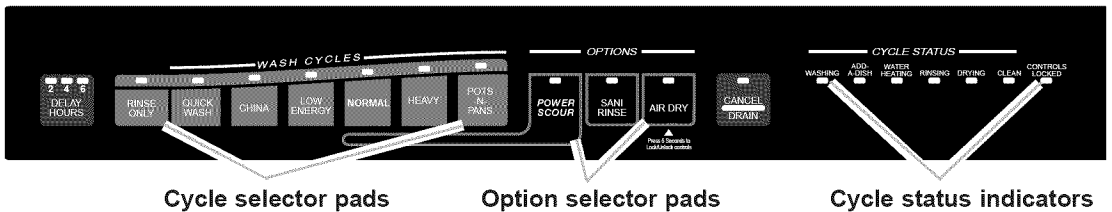
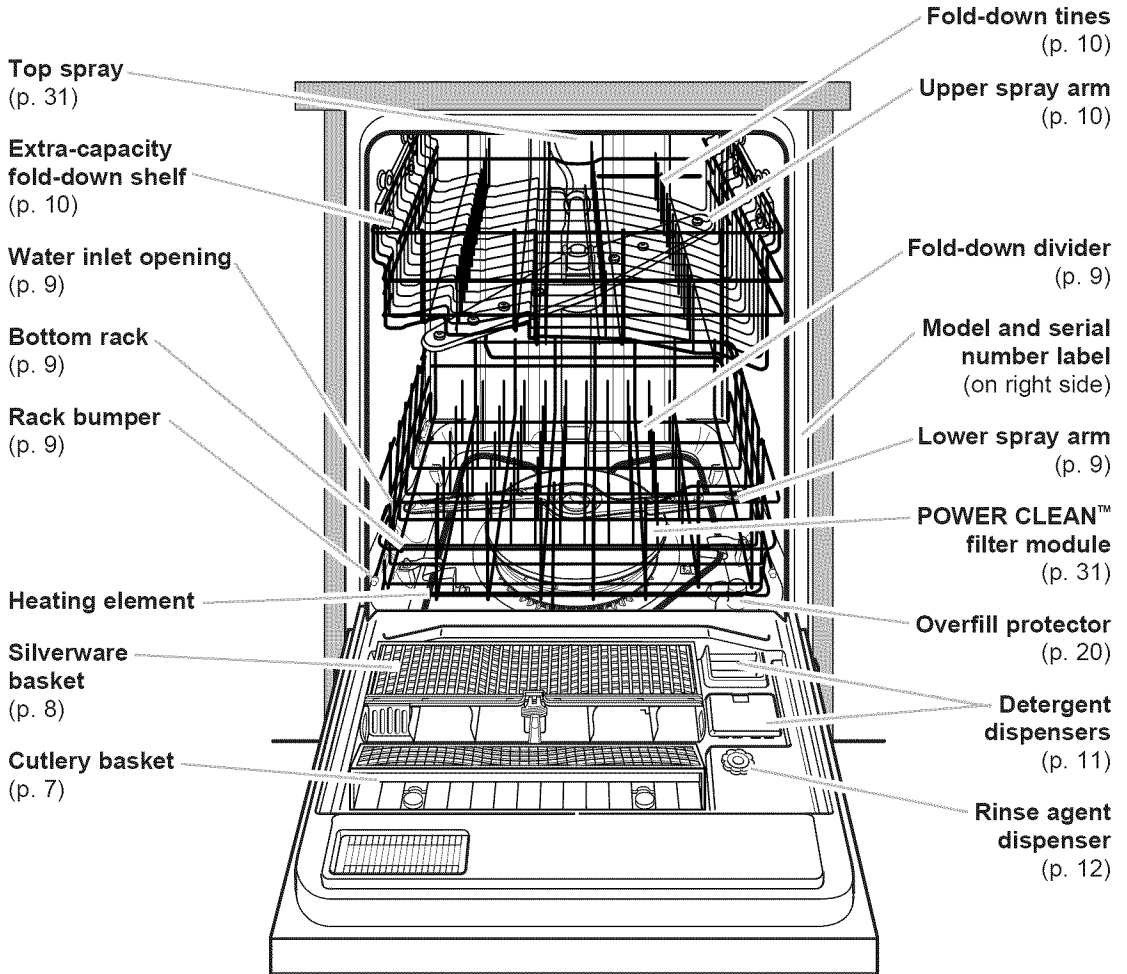

Starting Your Dishwasher

⚠️ WARNING



Tip Over Hazard

Do not use dishwasher until completely installed.

Do not push down on open door.

Doing so can result in serious injury or cuts.

⚠️ WARNING



Electrical Shock Hazard

Electrically ground dishwasher.

Connect ground wire to green ground connector in terminal box.

Do not use an extension cord.

Failure to follow these instructions can result in death, fire, or electrical shock.

GROUNDING INSTRUCTIONS

- **For a grounded, cord connected dishwasher:**

The dishwasher must be grounded. In the event of a malfunction or breakdown, grounding will reduce the risk of electric shock by providing a path of least resistance for electric current. The dishwasher is equipped with a cord having an equipment-grounding conductor and a grounding plug. The plug must be plugged into an appropriate outlet that is installed and grounded in accordance with all local codes and ordinances.

WARNING: Improper connection of the equipment-grounding conductor can result in a risk of electric shock.

Check with a qualified electrician or service representative if you are in doubt whether the dishwasher is properly grounded. Do not modify the plug provided with the dishwasher; if it will not fit the outlet, have a proper outlet installed by a qualified electrician.

- **For a permanently connected dishwasher:**

The dishwasher must be connected to a grounded metal, permanent wiring system, or an equipment-grounding conductor must be run with the circuit conductors and connected to the equipment-grounding terminal or lead on the dishwasher.

SAVE THESE INSTRUCTIONS

Starting a wash cycle

1. Load the dishwasher. See the "Loading Your Dishwasher" section.



2. Spin the spray arms. They should turn freely.

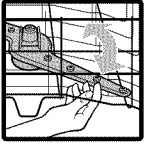

3. Add detergent. See the "Using the Dispensers" section.



4. Add rinse agent, if needed.



5. Close door firmly until it latches.

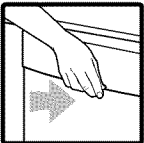

6. Run hot water at the sink nearest the dishwasher until water is hot. Turn off water.

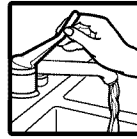

7. Press a Cycle. If desired, press one or more Options. The dishwasher starts filling once you press a Cycle unless you select the delay wash cycle. You can press Options as the machine is filling.



The indicator glows when a cycle or an option is selected.

Stopping the dishwasher

You can stop your dishwasher anytime during a cycle. All you have to do is:

- Open the door slightly. Wait for any filling or spraying action to stop before opening the door all the way. Close the door to continue the cycle.

OR

- Press Cancel/Drain. Once pressed, a 2-minute drain starts.

Loading Your Dishwasher

Preparing to load the dishwasher

- To save water and energy, do not rinse dishes before putting them into the dishwasher.
- Remove large pieces of food, bones, and other hard items. The POWER CLEAN™ filter module removes food particles from the water. The module contains a chopping device which reduces the size of food items.
NOTE: If hard items such as fruit seeds, nuts, and egg shells enter the POWER CLEAN filter module, you might hear chopping, grinding, crunching, or buzzing sounds. Those sounds are normal when hard items enter the module. **Do not** let metallic items (such as pot handle screws) get into the POWER CLEAN filter module. Damage can occur.
- Foods like eggs, rice, pasta, and cooked cereals may be hard to remove if left to dry over a period of time. Run a Rinse Only cycle to keep dishes moist if you do not plan to wash them soon.
- Load dishes so soiled surfaces face the rotating spray arm.
- Load dishes so they are not stacked or overlapping. It is important for the water spray to reach all soiled surfaces for best washing. For best drying, water must be able to drain from all surfaces.

Loading for quiet operation

- Secure lightweight load items in the racks.
- Pot lids and handles, pizza pans, cookie sheets, etc. should not touch interior walls or interfere with the spray arm's rotation.
- Load dishes so they do not touch one another.

NOTE: Keep sink drain plugs inserted during dishwasher operation to prevent noise transfer through drains.

Loading the cutlery basket

Use the cutlery basket to hold long items. Always unload or remove the cutlery basket before unloading the racks to avoid spilling water on the cutlery.

IMPORTANT: Remove the basket and tip the contents onto a cutting board to unload. This helps avoid accidents with sharp points and edges.

To remove the cutlery basket:

1. Grasp the basket on both sides and slide it toward the top of the door.
2. Lift the basket off the holding buttons.

To replace the cutlery basket:

1. Set the basket on the holding buttons.
2. Slide the basket toward the bottom of the door until it locks into place.

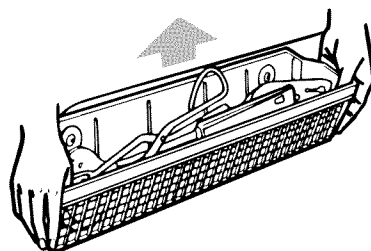

Loading the silverware basket

- Load the silverware basket while it is in the door or take the basket out for loading on a counter or table.

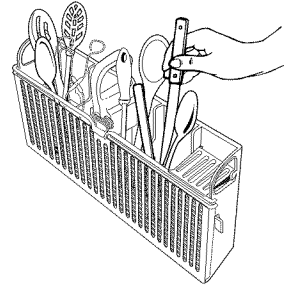

- Mix items in each section of the basket with some pointing up and some down to avoid nesting. Spray cannot reach nested items. Load spoons with baked on food pointing up.

IMPORTANT: Always load sharp items (knives, skewers, forks, etc.) pointing down.

- Put small items (baby bottle caps, jar lids, etc.) in the section with the lid.
- You can also remove the basket for easy unloading. Always unload or remove the basket before unloading the racks to avoid spilling water on the silverware.

NOTE: The basket may be hung on the door or on the bottom rack. It can also be placed inside the bottom rack.

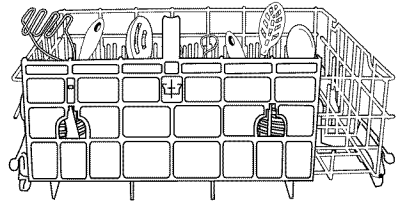
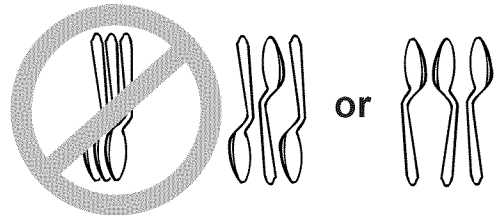

To remove the basket:

1. Grab the basket by the handle and slide it toward the top of the door.
2. Lift the basket off the holding buttons.

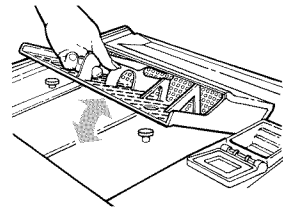

To replace the basket:

1. Set the basket on the holding buttons.
2. Slide the basket towards the bottom of the door until it locks in place.

To open the basket:

- Unhook the latch as shown.

NOTE: Be sure the cover is completely latched before pulling out the bottom rack and before closing the dishwasher door.

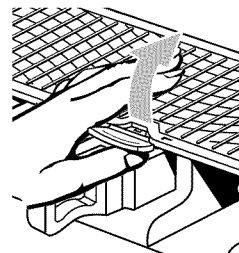

Loading the bottom rack

Load items with cooked-on or dried-on food in the bottom rack, with soiled surfaces facing inward to the spray.

Mixed load

- Load plates, soup bowls, etc., between prongs and facing inward to the spray.
- Make sure pot handles and other items do not stop rotation of the spray arm. Spray arm must move freely.
- Load heavily soiled cookware face down in rack.
- Do not stack or overlap dishes. Water spray must reach all soiled surfaces for best results.

Utensil load

- Load cookie sheets, cake pans, and other large items at sides and back. Loading such items in front may keep water spray from reaching detergent dispenser and silverware basket.

NOTES:

- Do not load glasses, cups, or plastic items in the bottom rack.
- Do not load items between the bottom rack and the dishwasher tub. This can block the water inlet opening.
- If you have removed the bottom rack for unloading or cleaning, replace it with bumpers in front.

Fold-down dividers

Fold-down dividers at the back of the rack can be lowered to make room for deep bowls, roasters, and other large items.

12 place setting load

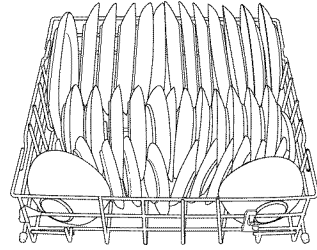

Mixed load

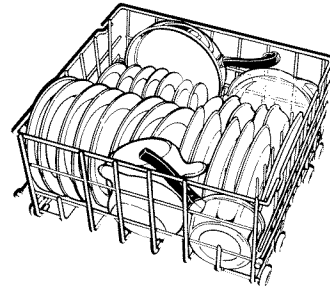

Utensil load

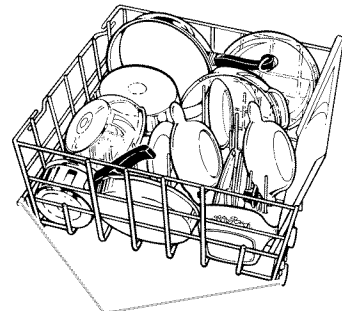

Bumpers must face dishwasher door

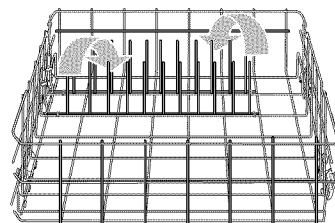

Loading the top rack

The top rack is designed for cups, glasses, and smaller items.

Cup and glass load

- Load so open ends face down for cleaning and draining.
- Load glasses in top rack only – bottom rack is not designed for glasses. Damage can occur.
- Place items in the rows **between** prongs. Placing them over the prongs can lead to breakage.
- Secure lightweight items.
- China, crystal, and other delicate items must not touch each other during dishwasher operation. Damage can occur.

Mixed load

- Small bowls, pans, and other utensils can be placed in the top rack.
- Load plastic items in the top rack only. Plastic items can melt in the bottom rack.
- Wash only plastic items marked “dishwasher safe.”
- Load plastic items so the force of the spray does not move them during the cycle.

Fold-down tines

Fold down tines in the top rack to accommodate larger items.

Extra-capacity fold-down shelves

Fold down the extra shelves on the top rack to hold items such as cups, juice glasses and cereal bowls.

12 place setting

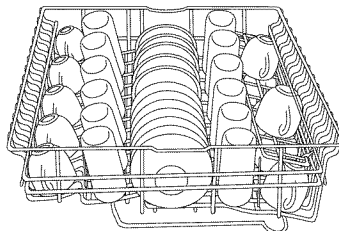

Cup and glass load

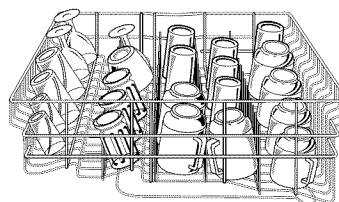

Mixed load

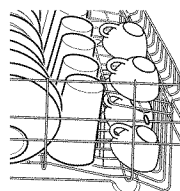
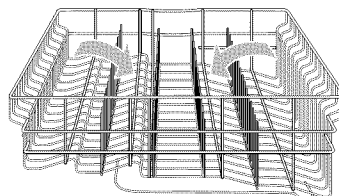
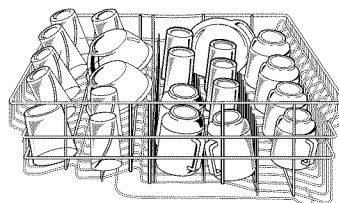

Using the Dispensers

Using the detergent dispenser

- Use **automatic dishwashing detergent only**. Other detergents are too mild and much too sudsy.
- Add detergent just before starting cycle.
- Store tightly closed detergent in a cool, dry place. **Fresh automatic dishwasher detergent results in better cleaning.**

Filling the detergent dispenser

The detergent dispenser has one section with a cover and one without. Push the cover down firmly until it latches. Detergent in the open section falls into the dishwasher when closing the door. The covered section opens automatically for the main wash. It is normal for the cover to open partially when dispensing detergent.

NOTE: Use both sections for cycles with two washes. Use only the covered section for cycles with one wash. See the cycles chart for more details.

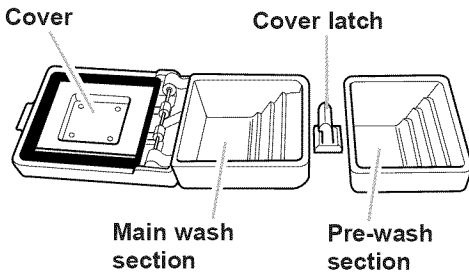

How much detergent to use

- The amount of detergent to use depends on the hardness of your water and the type of detergent. If you use too little, dishes won't be clean. If you use too much in soft water, glassware will etch.
- Find out your water's hardness by asking your local water department, water softener company, or county extension agent.

Water Hardness	Amount of Detergent
Soft to Medium Hard Water 0 to 6 grains per gallon	For normal loads: <ul style="list-style-type: none">• Partially fill the Main Wash section (2 tablespoons or 30 grams)• Fill the Pre-Wash section (2 tablespoons or 30 grams) NOTE: Add only 1 tablespoon or 15 grams of detergent to both sections if dishes are prerinse or water is very soft. For baked on soil loads: <ul style="list-style-type: none">• Fill the Main Wash section (2 tablespoons or 30 grams)• Fill the Pre-Wash section (2 tablespoons or 30 grams) For heavily soiled loads: <ul style="list-style-type: none">• Fill the Main Wash section (3 tablespoons or 45 grams)• Fill the Pre-Wash section (3 tablespoons or 45 grams)
Medium to Hard Water 7 to 12 grains per gallon	For normal and heavily soiled loads: <ul style="list-style-type: none">• Fill the Main Wash section (3 tablespoons or 45 grams)• Fill the Pre-Wash section (3 tablespoons or 45 grams)

NOTE: Fill amounts shown are for standard powdered detergent. Amounts may vary if you use liquid or concentrated powdered detergent. Follow instructions on the package when using liquid dishwasher detergent or concentrated powdered detergent.

Using the rinse agent dispenser

Keep the rinse agent dispenser filled with a liquid rinse agent. **A rinse agent greatly improves dish drying by helping water flow off during the last rinse.** A rinse agent also keeps water from forming droplets and drying as spots or streaks. A small amount of rinse agent automatically releases into the rinse water during the final rinse of each cycle. **For best drying results, check dispenser periodically to see if it needs filling.**

To check dispenser:

- Check center of Fill Indicator Cap. Clear means it needs filling.
- OR**
- Remove Fill Indicator Cap. An “E” is visible when dispenser is empty.



Cap center clear
when empty

OR

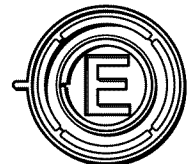

“E” visible
when empty

To fill dispenser:

The rinse agent dispenser holds 6 ounces (175 mL). Under normal conditions, this lasts about 3 months.

1. Open dishwasher door completely.
2. Remove Fill Indicator Cap.
3. Add rinse agent. Fill to smallest opening in lower part of dispenser only. Overfilling may cause rinse agent to leak out. This will not harm the dishwasher, but could cause oversudsing.
4. Clean up any spilled rinse agent with a damp cloth.
5. Replace Fill Indicator Cap. Keep it closed tightly.

NOTE: You do not have to wait until the dispenser is empty before refilling, but do not overfill it. Your dishwasher is designed to use a liquid rinse agent. You do not need to use a solid or bar-type rinse agent.

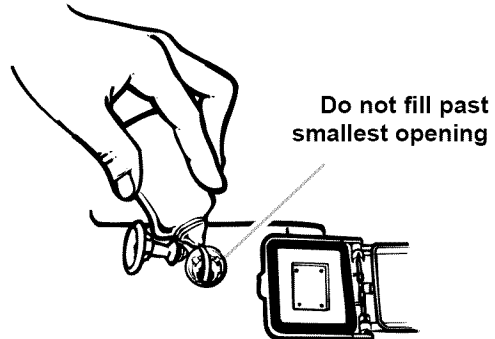

Keep dispenser filled for best drying results

Setting the Controls





Selecting a wash cycle

Press a Cycle. The dishwasher starts filling once you press a Cycle, unless you select the delay wash. You can press Options as the machine is filling.

Your electronic dishwasher senses the soil level on your dishes. Soil level determines

the length of some cycles, the amount of heat added to a wash or rinse, and the number of washes and rinses in a cycle.



Cycle time depends upon the soil on the dishes, and water usage may be higher for large amounts of soil.

CYCLE	A “•” shows what each cycle includes								WATER USE (gal)	CYCLE TIME (min)
	SOIL LEVEL	PRE-WASH	RINSE	MAIN WASH	RINSE	PURGE†	FINAL RINSE	DRY		
RINSE ONLY  For rinsing a few items to be washed one or more days later. Do not use detergent.	HEAVY		•		•				4.3	14
	LIGHT				•				2.2	10
QUICK WASH  A single wash for quick cleaning. Use covered detergent dispenser.	HEAVY		•	•		•	• 140°F (60°C)		6.9	30*
	LIGHT			•		•	• 140°F (60°C)		4.8	26*
CHINA  Light wash and a gentle dry for china and crystal. Use covered detergent dispenser.	HEAVY		•	•	•		• 130°F (54°C)	•	8.6	74*
	LIGHT			•	•		• 130°F (54°C)	•	6.5	64*
LOW ENERGY  Single wash for prerinse or lightly soiled loads. Use covered detergent dispenser.	HEAVY		•	• 140°F (60°C)	•		• 140°F (60°C)	•	8.6	78*
	LIGHT			•	•		• 140°F (60°C)	•	6.5	68*

* Cycle time includes dry time and may be longer depending on the temperature of water entering the dishwasher. The cooler the water, the longer the cycle time. If the water is already hot enough, the cycle times will be as shown.

† A small amount of water runs through the pump to remove soil particles.

SETTING THE CONTROLS

CYCLE	A "•" shows what each cycle includes								WATER USE (gal)	CYCLE TIME (min)
	SOIL LEVEL	PRE-WASH	RINSE	MAIN WASH	RINSE	PURGE†	FINAL RINSE	DRY		
NORMAL  Double wash for normal, everyday soiled loads. (The Energy Guide label is based on this cycle.) Use both detergent dispensers.	HEAVY	•	•	• 140°F (60°C)	•		• 140°F (60°C)	•	10.8	90*
	MEDIUM	•		• 140°F (60°C)	•		• 140°F (60°C)	•	8.6	86*
	LIGHT	•		•		•	• 140°F (60°C)	•	6.9	72*
HEAVY  Double wash for cleaning heavily soiled loads. Use both detergent dispensers.	HEAVY	•	•	• 140°F (60°C)	•		• 140°F (60°C)	•	10.8	92*
	MEDIUM		•	• 135°F (57°C)	• 140°F (60°C)	•	• 140°F (60°C)	•	10.8	92*
	LIGHT	• 135°F (57°C)		• 140°F (60°C)	•		• 140°F (60°C)	•	8.6	82*
POTS-N-PANS  An extended double wash for maximum cleaning of heavily-soiled dishes, pots and pans. Use both detergent dispensers.	HEAVY	•	•	• 140°F (60°C)	•		• 140°F (60°C)	•	10.8	97*
	MEDIUM	•	•	• 135°F (57°C)	• 140°F (60°C)	•	• 140°F (60°C)	•	10.8	97*
	LIGHT	• 135°F (57°C)		• 140°F (60°C)	•		• 140°F (60°C)	•	8.6	87*

* Cycle time includes dry time and may be longer depending on the temperature of water entering the dishwasher. The cooler the water, the longer the cycle time. If the water is already hot enough, the cycle times will be as shown.

† A small amount of water runs through the pump to remove soil particles.

Using Cancel/Drain

Press Cancel/Drain to cancel a cycle or clear option selections.



To cancel a cycle:

- Press Cancel/Drain while the dishwasher is running to start a 2-minute drain. It will take a few seconds for the drain to start. If desired, select a new cycle. (See the “Changing a cycle or option” section.)

- You can press Cancel/Drain again to stop the drain immediately. Remember to drain the dishwasher again before starting a new cycle.

NOTE: A small amount of water remaining in the dishwasher is normal.

To clear the indicators:

Press Cancel/Drain before starting the dishwasher to clear all cycle and option selections.

Selecting cycle options

You can press an Option after the dishwasher starts as long as the cycle is not past the point that the option is used. For example, you can press Air Dry any time before the Drying indicator glows.

After a wash cycle, the dishwasher remembers the options used and uses the same options in the next wash cycle unless new options are selected or the Cancel/Drain pad is pressed.

POWER SCOUR™ feature

When POWER SCOUR is selected the dishwasher adds heat and water during several portions of the Normal, Heavy, and Pots-N-Pans cycles. The extra heat and water improve washing results. The cycle will be longer when you select the POWER SCOUR feature. The Pots-N-Pans cycle, with POWER SCOUR is recommended for baked-on soil.



SANI RINSE™ option

Selecting the SANI RINSE option raises the water temperature in the final rinse to 155°F (68°C).

SANI RINSE is an option with the Pots-N-Pans, Heavy, Normal and Low Energy cycles. Depending on the incoming temperature of your water, cycle times might be longer when you select SANI RINSE.

NOTE: SANI RINSE raises the temperature of the final rinse to 155°F (68°C), and maintains that temperature 9 minutes. This high temperature rinse sanitizes your dishes and glassware.

Air Dry

When Air Dry is selected, the air in the dishwasher is not heated during the “dry” portion of a cycle. Using Air Dry helps save energy, but dishes take longer to dry and some spotting can occur. Some items (such as plastics) may need towel drying. For best drying, use a liquid rinse agent.

NOTE: The dishwasher automatically heats the air in the dishwasher during the “dry” portion of the cycle unless you select Air Dry.



Changing a cycle or option

During the first minute of a cycle

1. Press new Cycle and/or Options.
2. Check the detergent dispensers. They must be filled properly for the new cycle.

After the first minute of a cycle

1. Press Cancel/Drain. A 2-minute drain cycle starts. Wait for drain cycle to finish.
2. Press a new Cycle pad.
3. If desired, press one or more Option pad(s).
4. Check the detergent dispensers. They must be filled properly for the new cycle.

Adding items during a cycle

You can add items to the dishwasher load anytime the Add-A-Dish indicator is on.



1. Lift up the door latch to stop the cycle. Wait for spraying action to stop before opening the door.
2. Open the door and add the item.
3. Close the door, but **do not** latch it. Wait 30 seconds for the air in the dishwasher to warm up. Doing so reduces the amount of moisture in the vent when restarting a cycle.
4. Close the door firmly until it latches. The dishwasher resumes the cycle.

Using Delay Hours

Use a delayed start to run the dishwasher during off-peak hours to reduce energy usage or to reduce daytime heat buildup in your home.

1. Close door firmly until it latches.

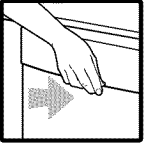

2. Press the Delay Hours pad once for a 2-hour delay start, twice for 4 hours, or three times for 6 hours. The indicator will glow.



3. Press a Cycle. The Delay Start countdown begins when you press the Cycle pad. If you don't press a Cycle pad within 30 seconds, the Delay Hours indicator turns off.



4. If desired, press one or more Option pads.



The Delay Hours indicator stays on until the wash cycle begins.

To cancel delay and start the dishwasher:

1. Press Delay Hours until the 6 glows.
2. Press Delay Hours one more time. The delayed cycle starts.



To cancel delay and cycle:

1. Press Cancel/Drain. The Delay Hours indicator will turn off.
2. Press new Cycle and Option pads.



NOTE: You can add items to the load anytime during the delay countdown. After adding items, close the door firmly until it latches. The delay countdown will not continue if the door is not latched.

Understanding the status indicators

Washing

The Washing indicator glows at the start of the first fill of any cycle (except Rinse Only) and remains on until the end of the main wash.



Add-A-Dish

The Add-A-Dish indicator glows as soon as the dishwasher starts and keeps glowing until the main wash portion of the cycle begins. You can add an additional item while the indicator is on.



Water Heating

The Water Heating indicator glows whenever water is heated during a cycle.



Rinsing

The Rinsing indicator glows during the last two rinses of all cycles.



Drying

The Drying indicator glows during the drying portion of each cycle – even if you select Air Dry. It turns off at the end of the cycle. If dishes are not as dry as you expected when using Air Dry, either allow longer drying times (overnight) or do not use Air Dry.



Clean

The Clean indicator glows at the end of a cycle to show that the load is clean. All other indicators turn off. The Clean indicator glows until you open the door or press Cancel/Drain or any other control pad.



Controls Locked

The Controls Locked feature lets you lock the control pads. **When the controls are locked, you cannot start the dishwasher.**



To lock controls:

- Press and hold Air Dry (about 5 seconds) until the Controls Locked indicator glows.



To unlock controls:

- Press and hold Air Dry (about 5 seconds) until the Controls Locked indicator turns off.

Washing Special Items

Material	DISHWASHER Safe?	Exceptions/Special Information
Aluminum	Yes	High water temperature and detergents can pit finish of anodized aluminum.
Bottles and Cans	No	Wash bottles and cans by hand. Labels attached with glue can loosen in your dishwasher. Loose labels and glue can clog spray arm or the pump and will reduce washing performance.
Cast Iron	No	Seasoning will be removed and iron will rust.
China/ Stoneware	Yes	Always check manufacturer's recommendations before washing. Antique, hand-painted, or over-the-glaze patterns may fade. Gold leaf can discolor or fade.
Crystal	Yes	Always check manufacturer's recommendations before washing. Some types of leaded crystal can etch with repeated washings.
Gold	No	Gold-colored flatware will discolor.
Glass	Yes	Milk glass will yellow with repeated dishwasher washing.
Hollow-Handle Knives	No	Handles of some knives are attached to the blade with adhesives which may loosen if washed in the dishwasher.
Pewter	No	High water temperatures and detergent can discolor or pit finish.
Disposable Plastics	No	Cannot withstand high water temperatures and detergents.
Plastics	Yes	Always check manufacturer's recommendations before washing. Plastics vary in their capacity to withstand high water temperatures and detergents. Load plastics in top rack only.
Stainless Steel	Yes	Run the Rinse Only cycle if not washing immediately. Prolonged contact with food containing salt, vinegar, milk products, or fruit juice can damage finish.
Sterling Silver or Silver Plate	Yes	Run the Rinse Only cycle if not washing immediately. Prolonged contact with food containing salt, acid, or sulfide (eggs, mayonnaise, and seafood) can damage finish.
Tin	No	Can rust.
Wooden Ware	No	Always check manufacturer's recommendations before washing. Untreated wood can warp, crack, or lose its finish.

Caring for Your Dishwasher

Cleaning the exterior

In most cases, regular use of a soft, damp cloth or sponge and a mild detergent is all that is necessary to keep the outside of your dishwasher nice looking and clean.



Cleaning the interior

Hard water minerals may cause a white film to build up on the inside surfaces, especially just beneath the door area.

To clean interior:

- Apply powdered dishwasher detergent to a damp sponge to make a paste.

OR

- Use liquid automatic dishwasher detergent and clean with damp sponge.

Do not clean the dishwasher interior until it has cooled.

Wear rubber gloves. **Do not** use any type of cleanser other than dishwasher detergent because it can cause foaming or sudsing.

NOTE: See “Removing spots and film” in the “Solving Common Dishwashing Problems” section to clean your dishwasher with white vinegar. Remember, this procedure is intended for occasional use only. Vinegar is an acid. Excessive use can damage your dishwasher.

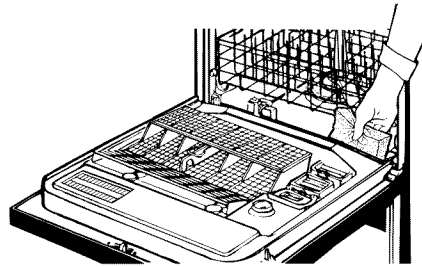

Overfill protector

The overfill protector (in the front right corner of the dishwasher tub) keeps the dishwasher from overflowing. It must be in place for the dishwasher to operate.

Check under the float for objects that may keep the protector from moving up or down.

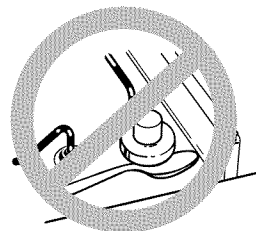

Storing your dishwasher

Storing for the summer

Protect your dishwasher during the summer months by turning off the water supply and power supply to the dishwasher.

Moving or winterizing your dishwasher

Protect your dishwasher and home against water damage due to freezing water lines. If your dishwasher is left in a seasonal dwelling or could be exposed to near freezing temperatures, have a qualified person do the following:

1. Disconnect power or unplug dishwasher.
2. Turn off water supply to the dishwasher.
3. Remove the 4 screws on the lower access panel and remove the lower access panel.

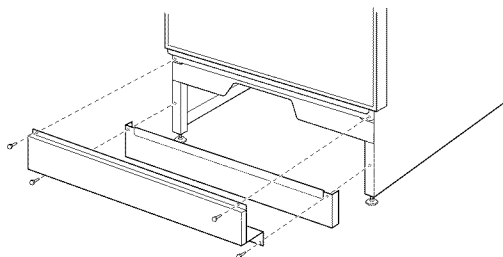

4. Place a shallow pan under the water supply valve. Then, use a wrench to disconnect the water inlet from the water supply valve. Separate the water inlet from the water supply valve and drain water into the pan.
5. Remove the spring clamp from the water outlet and separate from the water supply valve; drain water into pan.

6. Reconnect both water inlet and water outlet to the water supply valve.

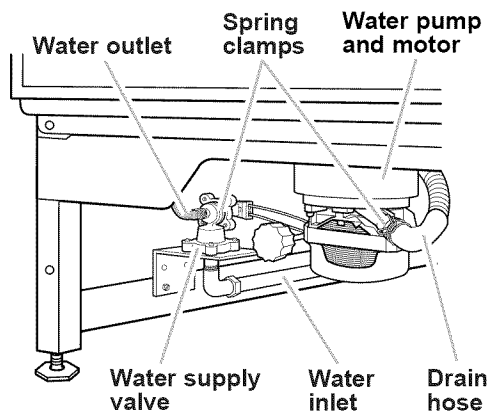

7. Empty the pan and reposition it under the water pump.
8. Remove the clamp and disconnect the drain hose from the water pump; drain water into pan.
9. Reconnect drain hose to the water pump, being sure to position the clamp over the connection.
10. Replace the lower access panel.

NOTE: If your dishwasher is connected to a garbage disposal, do not run water into the sink after winterizing. This could cause water to refill the drain hose on your dishwasher.

Reconnecting your dishwasher after storage

1. Remove the 4 screws on the lower access panel and remove lower access panel.
2. Turn on the water supply to dishwasher.
3. Reconnect power or plug in dishwasher.
4. Run dishwasher through a complete cycle and check for leaks.
5. Replace lower access panel.

Saving Energy

- Wash full loads. Running a half-filled dishwasher uses the same amount of electricity and hot water as a fully loaded machine.
- Load correctly for best washing results. Incorrect loading may cause poor washing and the need to rewash all or part of load.
- Do not prerinse normally soiled dishes. Select the correct cycle for the load and use the recommended amount of detergent.

Cycle and option tips

- Use the Low Energy cycle whenever possible. The cycle uses less hot water and energy than the Normal Wash cycle.
- Use the Delay Hours feature to run your dishwasher during off-peak hours. Local utilities recommend avoiding heavy usage of energy at certain times of day.
- Use the Air Dry option whenever possible. Allow longer drying times (overnight). Use a rinse agent to improve drying.
- Do not use the POWER SCOUR™ feature or SANI RINSE™ option if it is not needed.
- Loads may not wash or dry as well if the water temperature is too low. For best dishwashing results, water must be at least 120°F (49°C) as it enters the dishwasher.

To check water temperature:

1. Run the hot water at the faucet closest to your dishwasher. Let the water run for at least 1 minute.

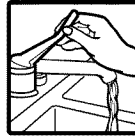

2. Hold a candy or meat thermometer in the running stream of water. If the water temperature at the faucet is below 120°F (49°C), have a qualified person raise the water heater's thermostat setting.

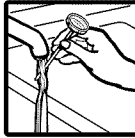

Solving Common Dishwashing Problems

Following is a convenient checklist for handling minor performance problems. Go over this list before calling for service. If you are unable to solve your dishwasher's problem, turn to the "Troubleshooting" section for service information.

Solution chart

Problem	Cause	Solution
Food soil left on dishes	Improper loading	Follow loading instructions.
	Water temperature too low	If needed, turn home water heater up to ensure water entering dishwasher is 120°F (49°C) minimum. See the "Saving Energy" section.
	Use of incorrect, too little, or ineffective detergent	Use recommended dishwasher detergents only. See the "Using the Dispensers" section. Never use less than 1 tablespoon per load. Detergent must be fresh to be effective. Always store detergent tightly closed in a cool, dry place.
	Detergent cakes in dispenser	Use fresh detergent only. Do not allow detergent to sit for several hours in a wet dispenser. Check dispenser for caked detergent. Clean dispenser when caked detergent is present.
	Insufficient fill due to low water pressure	Home water pressure should be 20 to 120 pounds per square inch (psi) (138 to 828 kPa) for proper dishwasher fill. A booster pump on the water supply may be necessary if pressure is too low.
	Slowdown of wash arm due to high suds	Never use soap or laundry detergents. Use recommended dishwasher detergents only.
Spotting and filming	Hard water or high mineral content in water	Use rinse agent to help prevent spotting and filming. See the "Using the Dispensers" section. To remove hard water film, see "Removing spots and film" at the end of this section.
	Water temperature too low	If needed, turn home water heater up to ensure water entering dishwasher is 120°F (49°C) minimum.
	Use of incorrect detergents	Use recommended dishwasher detergents only.

SOLVING COMMON DISHWASHING PROBLEMS

Problem	Cause	Solution
Spotting and filming (continued)	Incorrect amount of detergent	Follow recommendations for amount. Heavy soil and/or hard water generally require extra detergent.
	Use of ineffective detergents	Use fresh detergent. Store detergent tightly closed in a cool, dry place. Discard lumpy detergent.
	Insufficient fill due to low water pressure	Home water pressure should be 20 to 120 psi (138 to 828 kPa) for proper dishwasher fill. A booster pump on the water supply may be necessary if pressure is too low.
Dishes do not dry completely	Dishes do not drain properly	Dishes must have proper water drainage. Do not overload. See the "Loading Your Dishwasher" section. Use a liquid rinse agent to speed draining.
	Plastics	Some plastics, due to material, may need to be towel dried.
Silica film or etching (silica film is a milky, rainbow colored deposit; etching is a cloudy film)	Water chemical reaction with certain types of glassware – usually caused by some combination of soft or softened water, alkaline washing solutions, insufficient rinsing, overloading the dishwasher, and heat of drying.	It may not be possible to prevent problem, except by hand washing. To slow this process, use a minimum amount of detergent but not less than 1 tablespoon per load. Use a liquid rinse agent and underload the dishwasher to allow thorough rinsing. Silica film and etching are permanent and cannot be removed. Use the Air Dry option.
Black or gray marks on dishes	Aluminum items touching dishes	Load aluminum items so that they will not rub against dishes during washing. Do not wash throwaway aluminum items in the dishwasher because they may break down and cause marking. Remove aluminum markings by using a mild abrasive cleanser.
White spots on cookware with non-stick finish	Seasoning removed by dishwasher detergents	Reseason cookware after dishwasher washing.

Problem	Cause	Solution
Brown stains on dishes and dishwasher interior	High iron content in water supply	Remove by washing dishes (after food soil has been removed) with 1 teaspoon to 1 tablespoon of citric acid crystals added to covered section of detergent dispenser. Do not use detergent. Follow with a light wash cycle and detergent. If treatment is needed more often than every other month, we recommend installation of an iron removal unit.
Orange stains on dishwasher interior	Large amounts of tomato-based foods on dishes placed in the dishwasher	Stains will not affect dishwasher performance and can gradually fade over time. Regular use of Rinse Only reduces the chance of staining. If air in the dishwasher is heated during the "dry" portion of the cycle, stains may fade slower than if the Air Dry option is selected.
Odor in the dishwasher	Dishes only washed every 2-3 days	Run a Rinse Only cycle at least once or twice a day until a full load is accumulated.
Chipping of dishes	Improper loading	Load dishes and glasses so they are stable and do not strike together from washing action. Moving racks in and out slowly will also minimize chipping. NOTE: Some types of china and glassware are too delicate for automatic dishwashing and should be hand washed; for example: antiques, feather-edged crystal, and similar items.

Removing spots and film

Keep the rinse agent dispenser filled with a liquid rinse agent. A rinse agent prevents water from forming droplets and drying as spots or streaks.



To remove spots and film on dishes and glasses, or hard water film/lime buildup on the interior of the dishwasher, you may use white vinegar with the following procedure:

1. Load clean dishes and glasses in dishwasher. Do not load silverware or other metals in the dishwasher.

2. Put 2 cups of household vinegar (in a glass or dishwasher safe measuring cup) standing upright in the bottom rack.

3. Close and latch the door.

4. Select the Normal wash cycle and Air Dry option. Do not use detergent. Allow the dishwasher to complete the entire cycle.

NOTE: This cleaning procedure is intended for occasional use only. Vinegar is an acid. Excessive use may damage your dishwasher.

Troubleshooting

Before calling for assistance please check the chart below for problems you can fix. It could save you the cost of a service call.

Dishwasher problems

PROBLEM	CHECK THE FOLLOWING
Dishwasher does not run or stops during a cycle	<p>Is the door tightly closed and securely latched?</p> <p>Has the cycle been set correctly? See the "Setting the Controls" section.</p> <p>Has a household fuse blown or circuit breaker tripped?</p> <p>If the motor stopped because of an overload, it will automatically reset itself within a few minutes. If it does not start, call for service.</p> <p>Is the water supply turned on?</p>
Dishwasher runs too long	<p>Cycle times depend on the temperature of the water entering the dishwasher. Cooler water results in longer cycle times.</p> <p>Undercounter dishwashers require adequate enclosure for proper operation. See Installation Instructions for complete information.</p>
Dishwasher will not fill	<p>Is the overflow protector stuck in "up" position? Overflow protector should move up and down freely. Press down to release. See the "Caring for Your Dishwasher" section.</p>
Water remains in dishwasher	<p>Allow cycle to finish. A small amount of water remaining is normal.</p> <p>Check the drain air gap (if installed). If it is clogged, follow the manufacturer's cleaning instructions.</p>
Detergent remains in covered section of dispenser	<p>Has the cycle completed?</p> <p>Is the detergent fresh and dry without lumps? See the "Using the Dispensers" section.</p> <p>Is the bottom rack in backwards? The rack bumpers must face the dishwasher door.</p>
Dishes not as dry as you expected	<p>Is the rinse agent dispenser empty? Using a rinse agent greatly improves drying. See the "Using the Dispensers" section.</p> <p>Do not use Air Dry option on the next load. See the "Setting the Controls" section.</p>
Grinding, grating, crunching, or buzzing sounds	<p>Has a hard object entered the POWER CLEAN™ filter module? The sound should stop when the object is ground up.</p>
White residue appears on front of access panel	<p>Is too much detergent being used? See the "Using the Dispensers" section.</p> <p>Some liquid detergents develop excess foam and residue on panel. Try a different brand to reduce foaming and eliminate buildup.</p>
Dishwasher will not close	<p>Is the bottom rack in backwards? The rack bumpers must face the dishwasher door.</p>

Requesting Assistance or Service

Before calling for assistance or service, please check the "Troubleshooting" section. It may save you the cost of a service call. If you still need help, follow the instructions below.

If you need assistance or service in the U.S.A.:

1. If you need assistance* ...

Call the Whirlpool Consumer Assistance Center telephone number. Dial toll-free from anywhere in the U.S.A.:



1-800-253-1301

and talk with one of our trained consultants. The consultant can instruct you in how to obtain satisfactory operation from your appliance or, if service is necessary, recommend a qualified service company in your area.

If you prefer, write to:

Whirlpool Brand Home Appliances
Consumer Assistance Center
c/o Correspondence Dept.
2000 North M-63
Benton Harbor, MI 49022-2692

Please include a daytime phone number in your correspondence.

2. If you need service* ...



Whirlpool has a nationwide network of Whirlpool designated service companies. Whirlpool designated service technicians are

trained to fulfill the product warranty and provide after-warranty service, anywhere in the United States. To locate the Whirlpool designated service company in your area, call our Consumer Assistance Center telephone number (see Step 1) or look in your telephone directory Yellow Pages.

3. If you need FSP® replacement parts ...

FSP is a registered trademark of Whirlpool Corporation for quality parts. Look for this symbol of quality whenever you need a replacement part for your WHIRLPOOL® appliance. FSP replacement parts will fit right and work right, because they are made to the same exacting specifications used to build every new WHIRLPOOL appliance.

To locate FSP replacement parts in your area, refer to Step 2 or call the Whirlpool Consumer Assistance Center number in Step 1.

* When asking for help or service: Please provide a detailed description of the problem, your appliance's complete model and serial numbers, and the purchase date. (See the "A Note to You" section.) This information will help us respond properly to your request.

If you need assistance or service in Canada

1. If the problem is not due to one of the items listed in "Troubleshooting"* ...

Contact the dealer from whom you purchased your appliance, or call the Inglis Limited Consumer Assistance Center toll free, **8:30 a.m. – 6 p.m. (EST)**, at **1-800-461-5681**.



2. If you need service* ...

Contact your nearest Inglis Limited Appliance Service branch or designated servicing outlet. Call **1-800-807-6777**.

* When asking for help or service: Please provide a detailed description of the problem, your appliance's complete model and serial numbers, and the purchase date. (See the "A Note to You" section.) This information will help us respond properly to your request.

For further assistance

If you need further assistance, you can write to Inglis Limited with any questions or concerns at:

Consumer Relations Department
Inglis Limited
1901 Minnesota Court
Mississauga, Ontario L5N 3A7

Please include a daytime phone number in your correspondence.

POWER CLEAN™ filter module washing system parts covered by your warranty

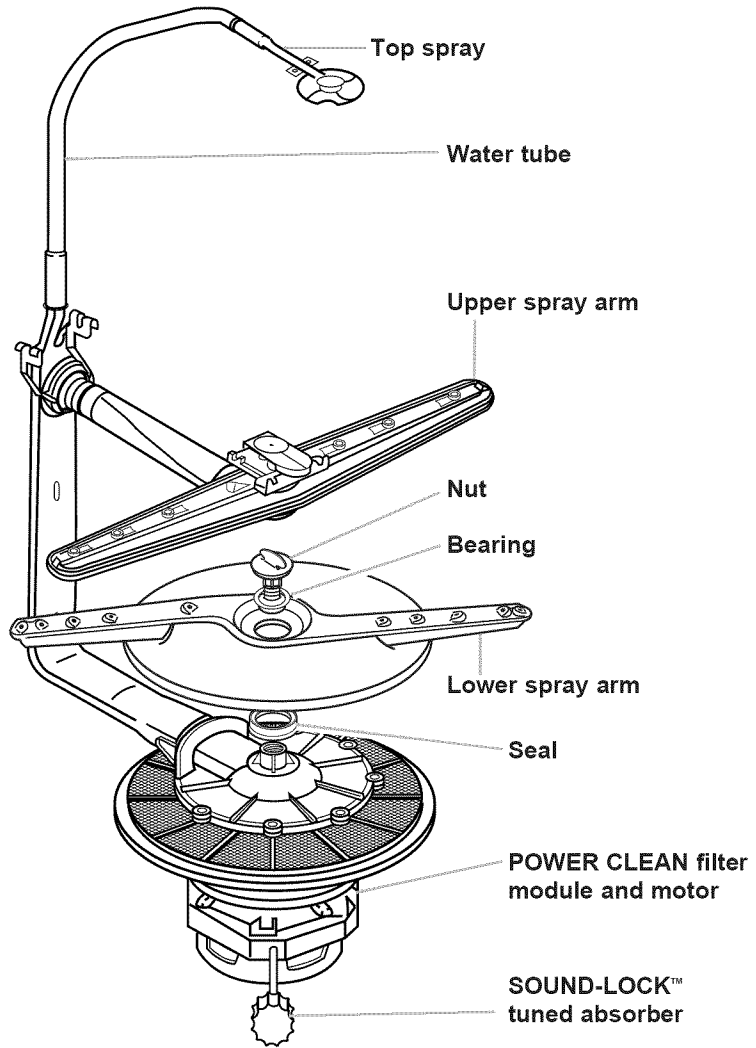

WHIRLPOOL® Dishwasher Warranty

LENGTH OF WARRANTY	WHIRLPOOL WILL PAY FOR
FULL ONE-YEAR WARRANTY FROM DATE OF PURCHASE	FSP® replacement parts and repair labor to correct defects in materials or workmanship. Service must be provided by a Whirlpool designated service company.
LIMITED ONE-YEAR WARRANTY SECOND YEAR FROM DATE OF PURCHASE	FSP replacement parts for any part of the POWER CLEAN™ filter module washing system if defective in materials or workmanship. These parts are shown on page 31 of this book.
LIMITED FOUR-YEAR WARRANTY SECOND THROUGH FIFTH YEAR FROM DATE OF PURCHASE	FSP replacement parts for Electronic Control System if defective in materials or workmanship. For models with dishracks that are nylon-coated, FSP replacement parts for the top and/or bottom dishracks if they rust due to defective materials or workmanship.
FULL TWENTY-YEAR WARRANTY FROM DATE OF PURCHASE	FSP replacement parts and repair labor for the DURAPERM™ tub and/or inner door should they fail to contain water due to defective materials or workmanship. Service must be provided by a Whirlpool designated service company.
WHIRLPOOL WILL NOT PAY FOR	
<p>A. Service calls to:</p> <ol style="list-style-type: none"> 1. Correct the installation of the dishwasher. 2. Instruct you how to use the dishwasher. 3. Replace house fuses or correct house wiring or plumbing. <p>B. Repairs when dishwasher is used in other than normal, single-family household use.</p> <p>C. Pickup and delivery. This product is designed to be repaired in the home.</p> <p>D. Damage to dishwasher caused by accident, misuse, fire, flood, acts of God, or use of products not approved by Whirlpool.</p> <p>E. Any labor costs during limited warranties.</p> <p>F. Repairs to parts or systems resulting from unauthorized modifications made to the appliance.</p> <p>G. In Canada, travel or transportation expenses for customers who reside in remote areas.</p>	

11/98

WHIRLPOOL CORPORATION AND INGLIS LIMITED SHALL NOT BE LIABLE FOR INCIDENTAL OR CONSEQUENTIAL DAMAGES.

Some states and provinces do not allow the exclusion or limitation of incidental or consequential damages, so this exclusion or limitation may not apply to you. This warranty gives you specific legal rights, and you may also have other rights which vary from state to state or province to province.

Outside the United States and Canada, a different warranty may apply. For details, please contact your authorized Whirlpool dealer.

If you need service, first see the "Troubleshooting" section of this book. After checking "Troubleshooting," additional help is available by calling our Consumer Assistance Center telephone number, **1-800-253-1301**, from anywhere in the U.S.A. In Canada, you may call Inglis Limited, **1-800-807-6777**.

8051557