



**Contact SAMSUNG WORLDWIDE**

If you have any questions or comments relating to Samsung products, please contact the SAMSUNG customer care center.

**Comuníquese con SAMSUNG WORLDWIDE**

Si desea formular alguna pregunta o comentario en relación con los productos de Samsung, comuníquese con el centro de atención al cliente de SAMSUNG.

Country	Customer Care Center ☎	Web Site	Address
CANADA	1-800-SAMSUNG(726-7864)	www.samsung.com/ca	Samsung Electronics Canada Inc., Customer Service 55 Standish Court Mississauga, Ontario L5R 4B2 Canada
			Samsung Electronique Canada Inc., Service à la Clientèle 55 Standish Court Mississauga, Ontario L5R 4B2 Canada
U.S.A	1-800-SAMSUNG(726-7864)	www.samsung.com/us	Samsung Electronics America, Inc. 105 Challenger Road Ridgefield Park, NJ 07660-0511

SERIES **7**  
750

LCD TV  
user manual



BN68-02111B-00

imagine the possibilities

Thank you for purchasing this Samsung product. To receive more complete service, please register your product at

[www.samsung.com/register](http://www.samsung.com/register)

Model \_\_\_\_\_ Serial No. \_\_\_\_\_



## ❑ Important Warranty Information Regarding Television Format Viewing

- ☑ See the warranty card for more information on warranty terms.

Wide screen format LCD Displays (16:9, the aspect ratio of the screen width to height) are primarily designed to view wide screen format full-motion video. The images displayed on them should primarily be in the wide screen 16:9 ratio format, or expanded to fill the screen if your model offers this feature and the images are constantly moving. Displaying stationary graphics and images on screen, such as the dark sidebars on nonexpanded standard format television video and programming, should be limited to no more than 5% of the total television viewing per week.

Additionally, viewing other stationary images and text such as stock market reports, video game displays, station logos, web sites or computer graphics and patterns, should be limited as described above for all televisions. Displaying stationary images that exceed the above guidelines can cause uneven aging of LCD Displays that leave subtle, but permanent burned-in ghost images in the LCD picture. To avoid this, vary the programming and images, and primarily display full screen moving images, not stationary patterns or dark bars.

On LCD models that offer picture sizing features, use these controls to view different formats as a full screen picture.

Be careful in the selection and duration of television formats used for viewing. Uneven LCD aging as a result of format selection and use, as well as burned-in images, are not covered by your Samsung limited warranty.

### ● U.S.A Only

The product unit accompanying this user manual is licensed under certain intellectual property rights of certain third parties. In particular, this product is licensed under the following US patents: 5,991,715, 5,740,317, 4,972,484, 5,214,678, 5,323,396, 5,539,829, 5,606,618, 5,530,655, 5,777,992, 6,289,308, 5,610,985, 5,481,643, 5,544,247, 5,960,037, 6,023,490, 5,878,080, and under US Published Patent Application No. 2001-44713-A1.

This license is limited to private non-commercial use by end-user consumers for licensed contents. No rights are granted for commercial use. The license does not cover any product unit other than this product unit and the license does not extend to any unlicensed product unit or process conforming to ISO/IEC 11172-3 or ISO/IEC 13818-3 used or sold in combination with this product unit. The license only covers the use of this product unit to encode and/or decode audio files conforming to the ISO/IEC 11172-3 or ISO/IEC 13818-3. No rights are granted under this license for product features or functions that do not conform to the ISO/IEC 11172-3 or ISO/IEC 13818-3.

### ● Other countries

The product unit accompanying this user manual is licensed under certain intellectual property rights of certain third parties. This license is limited to private non-commercial use by end-user consumers for licensed contents. No rights are granted for commercial use. The license does not cover any product unit other than this product unit and the license does not extend to any unlicensed product unit or process conforming to ISO/IEC 11172-3 or ISO/IEC 13818-3 used or sold in combination with this product unit. The license only covers the use of this product unit to encode and/or decode audio files conforming to the ISO/IEC 11172-3 or ISO/IEC 13818-3. No rights are granted under this license for product features or functions that do not conform to the ISO/IEC 11172-3 or ISO/IEC 13818-3.

### ● SAMSUNG ELECTRONICS NORTH AMERICAN LIMITED WARRANTY STATEMENT

Subject to the requirements, conditions, exclusions and limitations of the original Limited Warranty supplied with Samsung Electronics (SAMSUNG) products, and the requirements, conditions, exclusions and limitations contained herein, SAMSUNG will additionally provide Warranty Repair Service in the United States on SAMSUNG products purchased in Canada, and in Canada on SAMSUNG products purchased in the United States, for the warranty period originally specified, and to the Original Purchaser only.

The above described warranty repairs must be performed by a SAMSUNG Authorized Service Center. Along with this Statement, the Original Limited Warranty Statement and a dated Bill of Sale as Proof of Purchase must be presented to the Service Center. Transportation to and from the Service Center is the responsibility of the purchaser.

Conditions covered are limited only to manufacturing defects in material or workmanship, and only those encountered in normal use of the product.

Excluded, but not limited to, are any originally specified provisions for, in-home or on-site services, minimum or maximum repair times, exchanges or replacements, accessories, options, upgrades, or consumables.

For the location of a SAMSUNG Authorized Service Center, please call toll-free:

☑ **In the United States : 1-800-SAMSUNG (1-800-726-7864)**

☑ **In Canada : 1-800-SAMSUNG**

## ❑ Precautions When Displaying a Still Image

A still image may cause permanent damage to the TV screen

- Do not display a still image on the LCD panel for more than 2 hours as it can cause screen image retention. This image retention is also known as screen burn. To avoid such image retention, reduce the degree of brightness and contrast of the screen when displaying a still image.
-  Watching the LCD TV in 4:3 format for a long period of time may leave traces of borders displayed on the left, right and center of the screen caused by the difference of light emission on the screen. Playing a DVD or a game console may cause a similar effect to the screen. Damages caused by the above effect are not covered by the Warranty.
- Displaying still images from Video games and PC for longer than a certain period of time may produce partial after-images. To prevent this effect, reduce the 'brightness' and 'contrast' when displaying still images.

# CONTENTS

## Setting up Your TV

■ List of Features .....	2
■ Accessories .....	2
■ Viewing the Control Panel .....	3
■ Viewing the Remote Control .....	4
■ Installing Batteries in the Remote Control .....	5
■ Viewing the menus .....	5
■ Plug & Play Feature .....	7

## Connections

■ Connecting VHF and UHF Antennas .....	8
■ Connecting Cable TV .....	9
■ Viewing the Connection Panel .....	10

## CHANNEL

■ Channel Menu .....	13
■ Managing Channels .....	14

## PICTURE

■ Configuring the Picture Menu .....	16
■ Viewing Picture-in-Picture .....	20
■ Using Your TV as a Computer (PC) Display .....	21
■ Setting up the TV with your PC .....	22

## SOUND

■ Configuring the Sound Menu .....	23
------------------------------------	----

## SETUP

■ Configuring the Setup Menu .....	25
■ Setting the Time .....	28
■ Network Connection .....	30
■ Setting the Network .....	33

## INPUT / SUPPORT

■ Input Menu .....	36
■ Support Menu .....	36

## Media Play (USB & DLNA)

■ Connecting a USB Device .....	39
■ Media Play Function .....	40
■ Sorting the Photo List .....	42
■ Photo List Option Menu .....	43
■ Viewing a Photo or Slide Show .....	44
■ Slide Show Option Menu .....	45
■ Sorting the Music List .....	47
■ Music List Option Menu .....	48
■ Playing Music .....	49
■ Music Play option Menu .....	50
■ Sorting the Movie List .....	50
■ Movie List Option Menu .....	51
■ Playing a Movie File .....	51

■ Movie Play Option Menu .....	54
■ Using the Setup Menu .....	55

## Media Play-DLNA

■ Setting the DLNA Network .....	56
■ Installing the DLNA Application .....	57
■ Using the DLNA Application .....	58
■ Using the DLNA Function .....	60

## ANYNET+

■ Connecting Anynet+ Devices .....	61
■ Setting Up Anynet+ .....	62
■ Switching between Anynet+ Devices .....	62
■ Recording .....	63
■ Listening through a Receiver (Home Theater) .....	63
■ Troubleshooting for Anynet+ .....	64

## Content Library

■ Using the Content Library .....	65
■ Using the TV Memory Contents .....	66
■ Using the Content Management .....	67

## Internet@TV

■ Getting Started with Internet@TV .....	68
■ Editing Snippets in the Dock .....	71
■ Using the Profile Widget .....	71
■ Using the Yahoo!® Widget Gallery .....	73
■ Using the Yahoo!® Weather Widget .....	74
■ Using the Yahoo!® News Widget .....	74
■ Using the Yahoo!® Flickr Widget .....	75
■ Using the Yahoo!® Finance Widget .....	76
■ Troubleshooting for internet@TV .....	76
■ Help Website .....	76

## Home Network Center

■ Home Network Center .....	77
■ Setting Up the Home Network Center .....	78
■ Using the Message Function .....	79
■ Using the Media Function .....	80

## RECOMMENDATIONS

■ Troubleshooting .....	81
■ Installing the Stand .....	82
■ Disconnecting the Stand .....	82
■ Assembling the Cables .....	83
■ Wall Mount Kit Specifications (VESA) .....	83
■ Anti-Theft Kensington Lock .....	84
■ Securing the Installation Space .....	84
■ Securing the TV to a Wall or Cabinet .....	85
■ Specifications .....	86
■ Dimensions .....	88

## License



TruSurround HD, SRS and  symbol are trademarks of SRS Labs, Inc. TruSurround HD technology is incorporated under license from SRS Labs, Inc.



Manufactured under license from Dolby Laboratories. Dolby and the double-D symbol are trademarks of Dolby Laboratories.



DivX® Certified to play DivX® video, including premium content.

## Symbol



# SETTING UP YOUR TV

To use your TV, you first have to set it up to suit your environment.

- ☑ Figures and illustrations in this User Manual are provided for reference only and may differ from actual product appearance. Product design and specifications may be changed without notice in order to enhance product performance.

## List of Features

- Adjustable picture settings that can be stored in the TV's memory.
- Automatic timer to turn the TV on and off.
- A special sleep timer.
- Excellent Digital Interface & Networking : With a built-in HD digital tuner, nonsubscription HD broadcasts can be viewed with no Cable Box/Satellite receiver (Set-Top Box) needed.
- HDMI/DVI connection of your PC to this TV.
- Excellent Picture Quality
- SRS TruSurround HD provides a virtual surround system.
- **Media Play:** Allows you to play music files, pictures, and movies saved on a USB or DLNA device.
- **Internet@TV:** You can use various internet services and view useful information and entertaining content.
- **Home Network Center:** Allows you to configure a mobile message server or a DLNA media render.

## Accessories

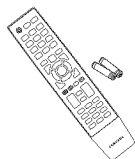

Remote Control (BN59-00851A)  
& Batteries (AAA x 2)



Program CD  
(BN59-00726D)



Cover-Bottom  
(LN40B750: BN63-05385A)  
(LN46B750: BN63-05254A)  
(LN52B750: BN63-05314A)



Warranty Card /  
Safety Guide



(M4xL16)

Stand Screw (X4)  
(6002-001294)



Power Cord  
(3903-000144)



TV-Holder & Screw (X1)  
(BN96-10788A)  
(Depending on the model)



Cleaning Cloth  
(BN63-01798B)



Holder-Wire Cable  
(BN61-05596A)  
(Depending on the model)

- ☑ Please make sure the following items are included with your LCD TV. If any items are missing, contact your dealer.
- ☑ The items color and shape may vary depending on the model.



## Viewing the Control Panel

- ⑧ The product color and shape may vary depending on the model.
- ⑧ The front panel buttons can be activated by touching them with your finger.

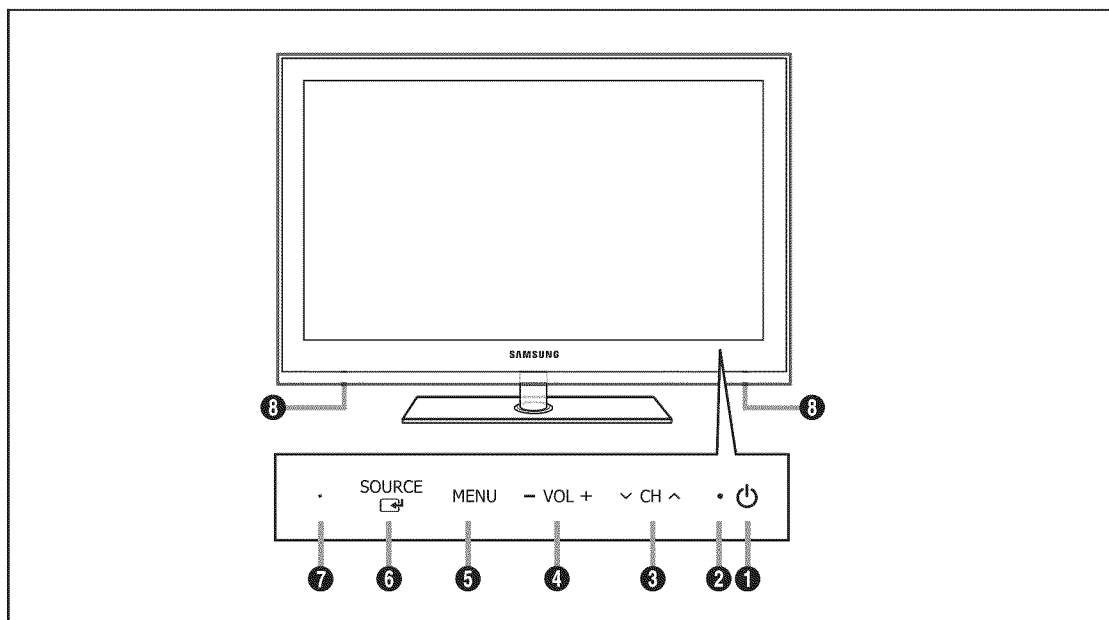

- ① **POWER** (⏻): Press to turn the TV on and off.
- ② **POWER INDICATOR**: Blinks and turns off when the power is on and lights up in stand-by mode.
- ③ **∇ CH ▲**: Press to change channels. In the on-screen menu, use the ∇ CH ▲ buttons as you would use the ▼ and ▲ buttons on the remote control.
- ④ **— VOL +**: Press to increase or decrease the volume. In the on-screen menu, use the — VOL + buttons as you would use the ◀ and ▶ buttons on the remote control.
- ⑤ **MENU**: Press to see an on-screen menu of your TV's features.
- ⑥ **SOURCE** (↔): Toggles between all the available input sources. In the on-screen menu, use this button as you use the ENTER (↵) button on the remote control.
- ⑦ **REMOTE CONTROL SENSOR**: Aim the remote control towards this spot on the TV.
- ⑧ **SPEAKERS**

## Viewing the Remote Control

- ① You can use the remote control up to a distance of about 23 feet from the TV.
- ② The performance of the remote control may be affected by bright light.
- ③ The product color and shape may vary depending on the model.

- ① **POWER** : Turns the TV on and off.
- ② **TV** : Selects the TV mode directly.
- ③ **NUMERIC BUTTONS** : Press to change the channel.
- ④ **[ ]** : Press to select additional channels (digital) being broadcast by the same station. For example, to select channel '54-3', press '54', then press '[ ]' and '3'.
- ⑤ **CH LIST** : Used to display Channel Lists on the screen.
- ⑥ **TOOLS** : Use to quickly select frequently used functions.
- ⑦ **INTERNET@** : Press to use various internet services to view useful information and entertaining content.
- ⑧ **COLOR BUTTONS** : Use these buttons in the **Channel list**, **Internet@TV**, **Media Play** menu, etc.
- ⑨ **SOURCE** : Press to display and select the available video sources.
- ⑩ **- VOL +** : Press to increase or decrease the volume.
- ⑪ **CONTENT** : This function enables you to view the **Content Library**.
- ⑫ **MEDIA.P** : Allows you to play music files, pictures, and movies.
- ⑬ **INFO** : Press to display information on the TV screen.
- ⑭ Use these buttons in the **Media Play** and **Anynet+** modes. ( [ ] : This remote can be used to control recording on Samsung recorders with the **Anynet+** feature)

- ⑮ **ON/OFF [ ]** : Pressing the **ON/OFF [ ]** light button toggles between on and off. When the remote control is on, and a button is pressed on the remote control, the remote control buttons will be lit for a moment. (Using the remote control with the **ON/OFF [ ]** light button set to On will reduce the battery usage time.)
- ⑯ **PRE-CH** : Enables you to return to the previous channel you were watching.
- ⑰ **MENU** : Displays the main on-screen menu.
- ⑱ **FAV.CH** : Press to switch to your favorite channels.
- ⑲ **RETURN** : Returns to the previous menu.
- ⑳ **UP ▲ / DOWN ▼ / LEFT ◀ / RIGHT ▶ / ENTER [ ]** : Use to select on-screen menu items and change menu values.
- ㉑ **EXIT** : Press to exit the menu.
- ㉒ **▼ CH ▲** : Press to change channels.
- ㉓ **MUTE [ ]** : Press to temporarily cut off the sound.
- ㉔ **P.SIZE** : Picture size selection.
- ㉕ **MTS** : Press to choose stereo, mono or Separate Audio Program (SAP broadcast).
- ㉖ **CC** : Controls the caption decoder.

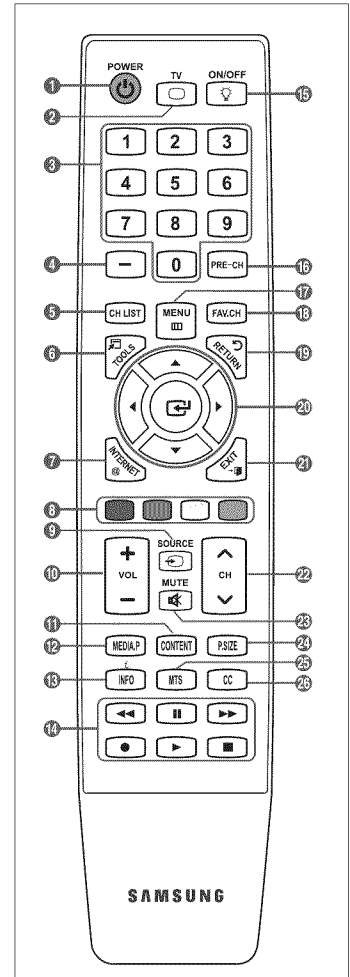

## Installing Batteries in the Remote Control

1. Lift the cover at the back of the remote control upward as shown in the figure.
2. Install two AAA size batteries.
  - ☑ Make sure to match the '+' and '-' ends of the batteries with the diagram inside the compartment.
3. Replace the cover.
  - ☑ Remove the batteries and store them in a cool, dry place if you won't be using the remote control for a long time. (Assuming typical TV usage, the batteries should last for about one year.)
  - ☑ If the remote control doesn't work, check the following:
    - Is the TV power on?
    - Are the plus and minus ends of the batteries reversed?
    - Are the batteries drained?
    - Is there a power outage or is the power cord unplugged?
    - Is there a special fluorescent light or neon sign nearby?

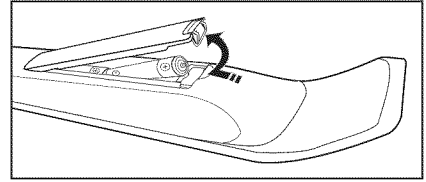

## Viewing the menus

Before using the TV, follow the steps below to learn how to navigate the menu in order to select and adjust different functions.

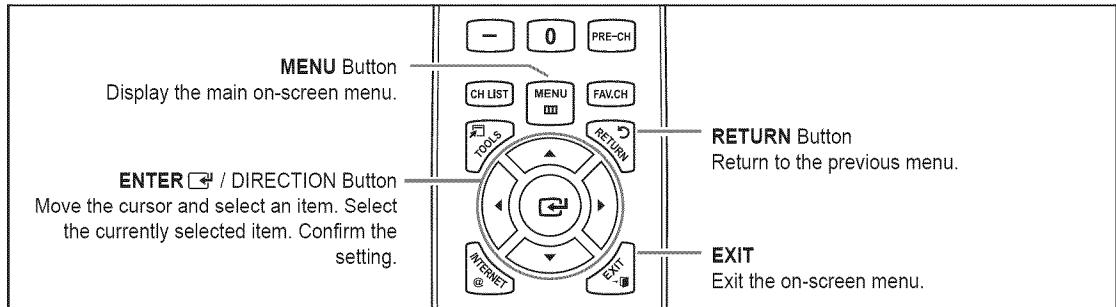

### □ Operation the OSD (On Screen Display)

The access step may differ depending on the selected menu.

1. Press the **MENU** button.
2. The main menu appears on the screen. The menu's left side has icons : **Picture, Sound, Channel, Setup, Input, Application, Support**.
3. Press the **▲** or **▼** button to select one of the icons.

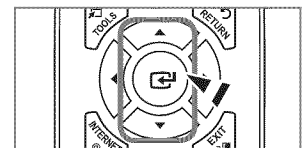
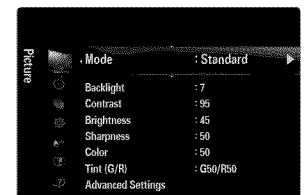
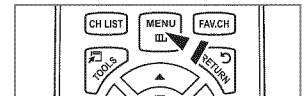

4. Then press the **ENTER**  button to access the icon's sub-menu.

5. Press the **▲** or **▼** button to select the icon's submenu.

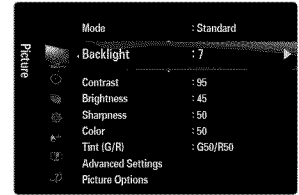

6. Press the **◀** or **▶** button to decrease or increase the value of a particular item. The adjustment OSD may differ depending on the selected menu.







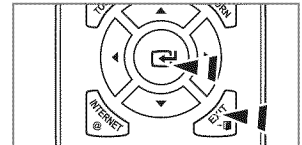

Help icon

7. Press the **ENTER**  button to complete the configuration. Press the **EXIT** button to exit.





## Plug & Play Feature

When the TV is initially powered on, basic settings proceed automatically and subsequently.

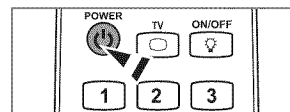
- Press the **POWER**  button on the remote control.
  - You can also use the **POWER**  button on the TV.
  - The message **Select Language of the OSD**, is displayed.
- Press the **ENTER**  button. Press the **▲** or **▼** button to select the language, then press the **ENTER**  button. The message **Select 'Home Use' when installing this TV in your home**, is displayed.
- Press the **◀** or **▶** button to select **Store Demo** or **Home Use**, then press the **ENTER**  button. The message **Select the Antenna source to memorize**, is displayed.
  - We recommend setting the TV to **Home Use** mode for the best picture in your home environment.
  - Store Demo** mode is only intended for use in retail environments.
  - If the unit is accidentally set to **Store Demo** mode and you want to return to **Home Use** (Standard): Press the volume button on the TV. When the volume OSD is displayed, press and hold the **MENU** button on the TV for 5 seconds.
- Press the **▲** or **▼** button to memorize the channels of the selected connection. Press the **ENTER**  button to select **Start**.
  - Air**: Air antenna signal. / **Cable**: Cable antenna signal. / **Auto**: Air and Cable antenna signals.
  - In Cable mode, you can select the correct signal source among **STD**, **HRC**, and **IRC** by pressing the **▲**, **▼**, **◀** or **▶** button, then press the **ENTER**  button. If you have Digital cable, select the cable system signal source for both Analog and Digital. Contact your local cable company to identify the type of cable system that exists in your particular area.
- Press the **ENTER**  button to select **Start**. The TV will begin memorizing all of the available channels.
  - To stop the search before it has finished, press the **ENTER**  button with **Stop** selected.
  - After all the available channels are stored, it starts to remove scrambled channels. The Auto program menu then reappears. Press the **ENTER**  button when channel memorization is complete. The message **Set the Clock Mode**, is displayed.
- Press the **ENTER**  button. Press the **▲** or **▼** button to select **Auto**, then Press the **ENTER**  button. The message **Set to daylight saving time**, is displayed. If you select **Manual**, **Set current date and time**, is displayed.
- Press the **▲** or **▼** button to select **Off**, **On** or **Auto**, then press the **ENTER**  button.
- Press the **▲** or **▼** button to highlight the time zone for your local area. Press the **ENTER**  button. If you have received a digital signal, the time will be set automatically. If not, refer to the 'Setting the Time' instructions to set the clock. (see pages 28~29)
- The description for the connection method providing the best HD screen quality is displayed. Check the description and press the **ENTER**  button.
- Press the **◀** or **▶** button to select **See Product Guide** or **Watch TV**. Press the **ENTER**  button.
  - See Product Guide**: You are moved to the **Product Guide** where you can view the introduction to the main functions of your new HDTV.
  - Watch TV**: You can watch the memorized channels.



### If you want to reset this feature...

- Press the **MENU** button to display the menu. Press the **▲** or **▼** button to select **Setup**, then press the **ENTER**  button.
- Press the **ENTER**  button again to select **Plug & Play**.
  - The **Plug & Play** feature is only available in the TV mode.





# CONNECTIONS

## Connecting VHF and UHF Antennas

If your antenna has a set of leads that look like the diagram to the right, see 'Antennas with 300  $\Omega$  Flat Twin Leads' below.

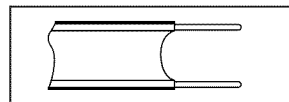

If your antenna has one lead that looks like the diagram to the right, see 'Antennas with 75  $\Omega$  Round Leads'.

If you have two antennas, see 'Separate VHF and UHF Antennas'.

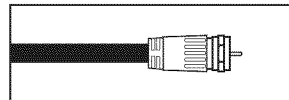

### Antennas with 300 $\Omega$ Flat Twin Leads

If you are using an off-air antenna (such as a roof antenna or 'rabbit ears') that has 300 $\Omega$  twin flat leads, follow the directions below.

1. Place the wires from the twin leads under the screws on a 300-75  $\Omega$  adaptor (not supplied). Use a screwdriver to tighten the screws.
2. Plug the adaptor into the **ANT IN** terminal on the back of the TV.

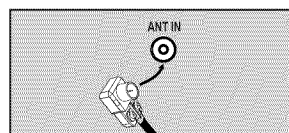
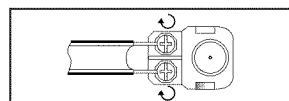

### Antennas with 75 $\Omega$ Round Leads

Plug the antenna lead into the **ANT IN** terminal on the back of the TV.



### Separate VHF and UHF Antennas

If you have two separate antennas for your TV (one VHF and one UHF), you must combine the two antenna signals before connecting the antennas to the TV. This procedure requires an optional combiner-adaptor (available at most electronics shops).

1. Connect both antenna leads to the combiner.
2. Plug the combiner into the **ANT IN** terminal on the bottom of the rear panel.

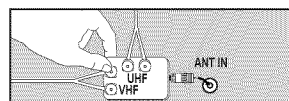
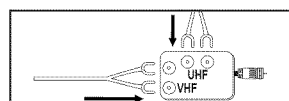

## Connecting Cable TV

To connect to a cable TV system, follow the instructions below.

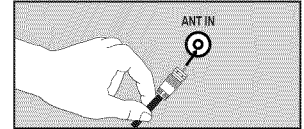

### Cable without a Cable Box

Plug the incoming cable into the **ANT IN** terminal on the back of the TV.

- ☑ Because this TV is cable-ready, you do not need a cable box to view unscrambled cable channels.

### Connecting to a Cable Box that Descrambles All Channels

1. Find the cable that is connected to the **ANT OUT** terminal on your cable box.

- ☑ This terminal might be labeled 'ANT OUT', 'VHF OUT' or simply, 'OUT'.

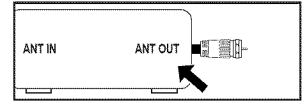

2. Connect the other end of this cable to the **ANT IN** terminal on the back of the TV.

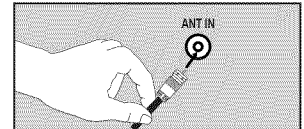

### Connecting to a Cable Box that Descrambles Some Channels

If your cable box descrambles only some channels (such as premium channels), follow the instructions below. You will need a two-way splitter, an RF (A/B) switch and four lengths of RF cable. (These items are available at most electronics stores.)

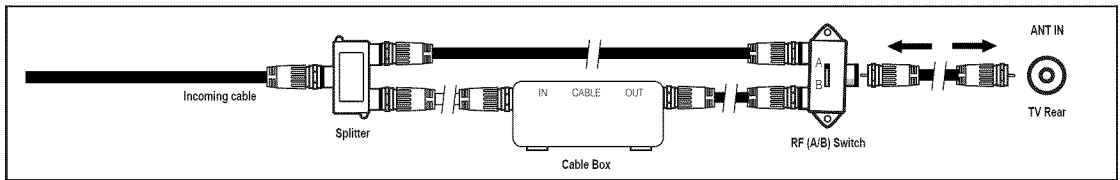

1. Find and disconnect the cable that is connected to the **ANT IN** terminal on your cable box.
  - ☑ This terminal might be labeled 'ANT IN', 'VHF IN' or simply, 'IN'.
2. Connect this cable to a two-way splitter.
3. Connect an RF cable between the **OUTPUT** terminal on the splitter and the **IN** terminal on the cable box.
4. Connect an RF cable between the **ANT OUT** terminal on the cable box and the **B-IN** terminal on the RF (A/B) switch.
5. Connect another cable between the other **OUT** terminal on the splitter and the **A-IN** terminal on the RF (A/B) switch.
6. Connect the last RF cable between the **OUT** terminal on the RF (A/B) switch and the **ANT IN** terminal on the rear of the TV.

After you have made this connection, set the A/B switch to the 'A' position for normal viewing. Set the A/B switch to the 'B' position to view scrambled channels. (When you set the A/B switch to 'B', you will need to tune your TV to the cable box's output channel, which is usually channel 3 or 4.)

## Viewing the Connection Panel

 The product color and shape may vary depending on the model.

### Rear Panel

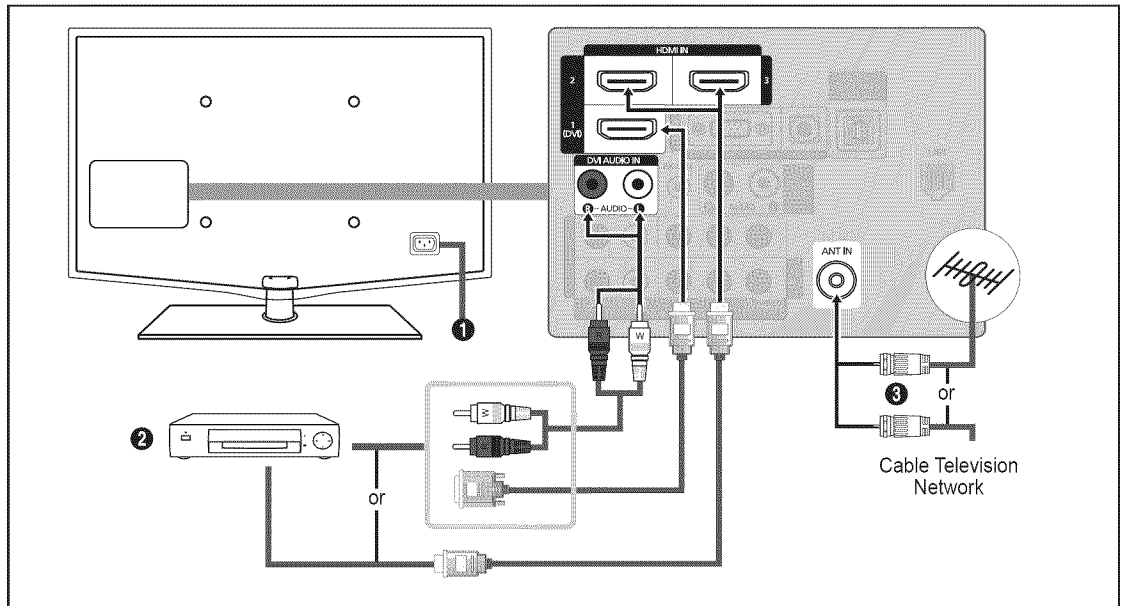

#### 1 POWER INPUT

Connects the supplied power cord.

 The location of the **POWER INPUT** may be different depending on its model.

#### 2 HDMI IN 1 (DVI), 2, 3 / DVI AUDIO IN [R-AUDIO-L]

Connects to the HDMI jack of a device with an HDMI output.

 No sound connection is needed for an HDMI to HDMI connection.

 What is HDMI?

- HDMI (High-Definition Multimedia Interface), is an interface that enables the transmission of digital audio and video signals using a single cable.
- The difference between HDMI and DVI is that the HDMI device is smaller in size and has the HDCP (High Bandwidth Digital Copy Protection) coding feature installed.

 The TV may not output sound and pictures may be displayed with abnormal color when DVD / Blu-ray player / Cable Box / Satellite receiver (Set-Top Box) supporting HDMI versions older than 1.3 are connected. When connecting an older HDMI cable and there is no sound, connect the HDMI cable to the **HDMI IN 1 (DVI)** jack and the audio cables to the **DVI AUDIO IN [R-AUDIO-L]** jacks on the back of the TV. If this happens, contact the company that provided the DVD / Blu-ray player / Cable Box / Satellite receiver (Set-Top Box) to confirm the HDMI version, then request an upgrade.

 HDMI cables that are not 1.3 may cause annoying flicker or no screen display.

 Use the **HDMI IN 1 (DVI)** jack for DVI connection to an external device. Use a DVI to HDMI cable or DVI-HDMI adapter (DVI to HDMI) for video connection and the **DVI AUDIO IN [R-AUDIO-L]** jacks for audio. When using an HDMI / DVI cable connection, you must use the **HDMI IN 1 (DVI)** jack.

#### 3 ANT IN

Connects to an antenna or cable TV system.

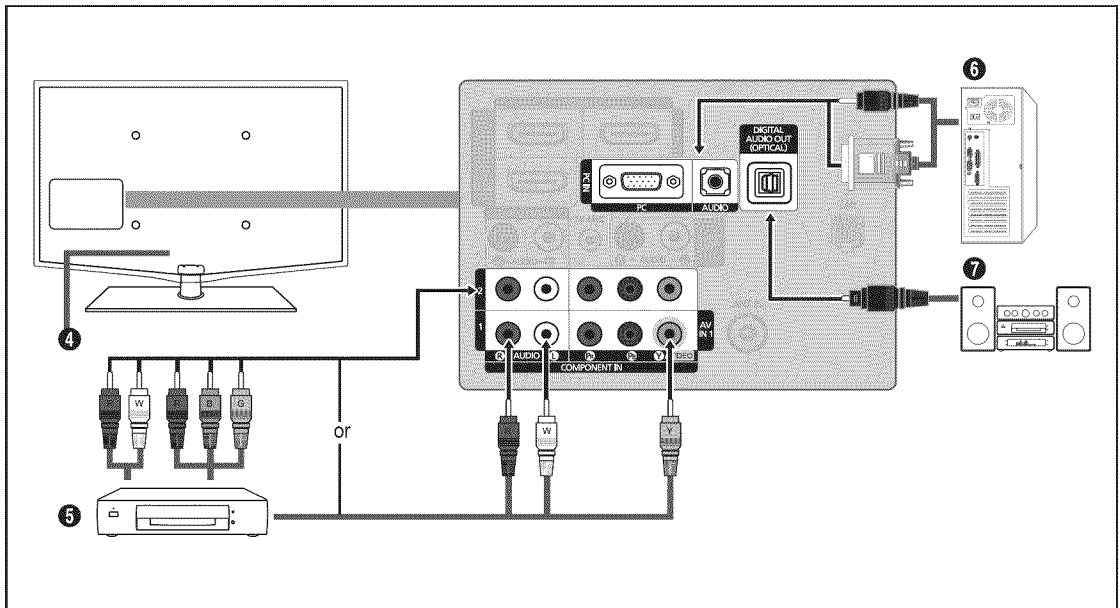

#### 4 KENSINGTON LOCK

The Kensington Lock (optional) is a device used to physically fix the system when used in a public place. If you want to use a locking device, contact the dealer where you purchased the TV.

The location of the Kensington Lock may be different depending on its model.

#### 5 COMPONENT IN 1, 2 / AV IN 1

Connects Component video / audio.

The **COMPONENT IN 1** jack is also used as the **AV IN 1** jack.

Connect the video cable to the **COMPONENT IN 1 [Y/VIDEO]** jack and the audio cable to the **COMPONENT IN 1 [R-AUDIO-L]** jacks.

If you have a 'mono' (non-stereo) VCR, use a Y-connector (not supplied) to connect to the right and left audio input jacks of the TV. Alternatively, connect the cable to the 'R' jack. If your VCR is stereo, you must connect two cables.

When connecting to **AV IN 1**, the color of the **AV IN 1 [Y/VIDEO]** jack (Green) does not match the color of the video cable (Yellow).

#### 6 PC IN [PC] / [AUDIO]

Connects to the video and audio output jacks on your PC.

If your PC supports an HDMI connection, you can connect this to the **HDMI IN 1(DVI), 2, 3** or **4** terminal.

If your PC supports a DVI connection, you can connect this to the **HDMI IN 1(DVI) / DVI AUDIO IN [R-AUDIO-L]** terminal.

#### 7 DIGITAL AUDIO OUT (OPTICAL)

Connects to a Digital Audio component such as a Home theater receiver.

When a Digital Audio System is connected to the **DIGITAL AUDIO OUT (OPTICAL)** jack: Decrease the volume of the TV and adjust the volume level with the system's volume control.

5.1CH audio is possible when the TV is connected to an external device supporting 5.1CH.

When the Home Theater receiver is set to On, you can hear sound output from the TV's Optical jack. When the TV is displaying a DTV(air) signal, the TV will send out 5.1 channel sound to the Home theater receiver. When the source is a digital component such as a DVD / Blu-ray player / Cable Box / Satellite receiver (Set-Top Box) and is connected to the TV via HDMI, only 2 channel sound will be heard from the Home Theater receiver. If you want to hear 5.1 channel audio, connect the digital audio out jack on DVD / Blu-ray player / Cable Box / Satellite receiver (Set-Top Box) directly to an Amplifier or Home Theater, not the TV.

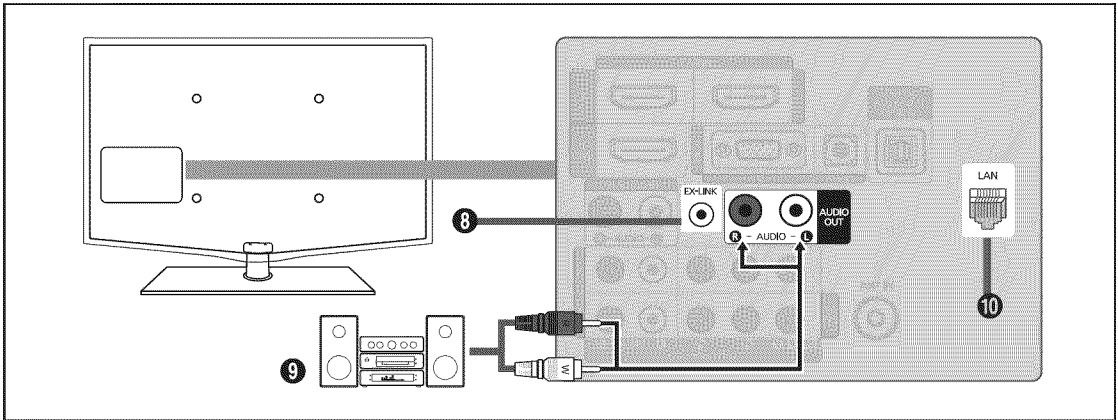

- 8 EX-LINK**  
Connector for service only.
- 9 AUDIO OUT**  
Connects to the audio input jacks on your Amplifier/Home theater.  
 When an audio amplifier is connected to the **AUDIO OUT [R-AUDIO-L]** jacks: Decrease the volume of the TV and adjust the volume level with the Amplifier's volume control.
- 10 LAN**  
Connect a LAN cable to this port to connect to the Network.

**Side Panel**

For devices frequently connected/disconnected from your TV, it is convenient to use the jacks on the side of your TV (e.g. Camcorder).

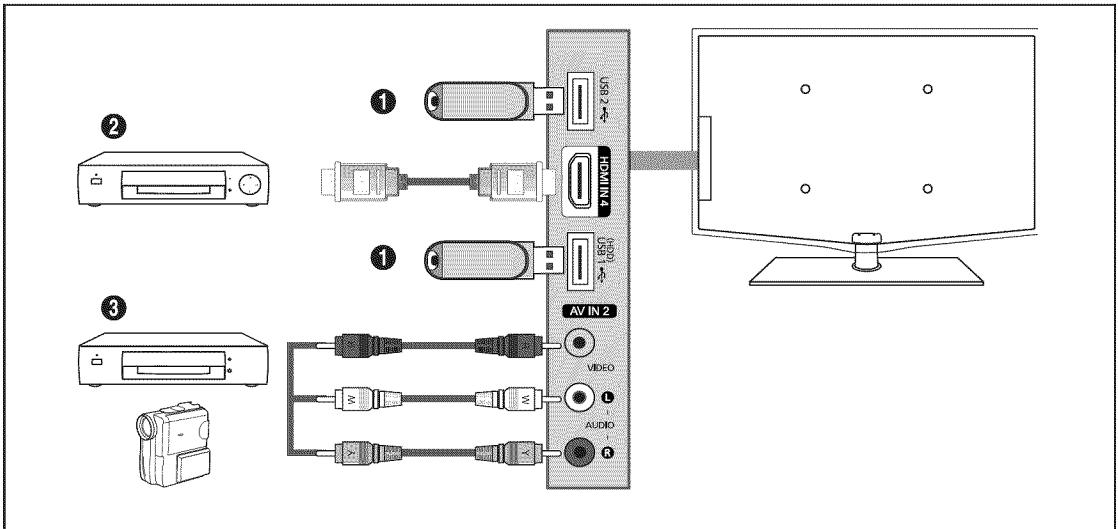

- 1 USB1(HDD) / USB2**  
Connector for software upgrades and Media Play, etc. You can connect to Samsung's network wirelessly using the 'Samsung Wireless LAN Adapter' (Sold separately).  
 For USB HDD, use the **USB1(HDD)** port.
- 2 HDMI IN 4**  
Connect to the HDMI jack of a device with HDMI output.
- 3 AV IN 2 [VIDEO] / [R-AUDIO-L]**  
Video and audio inputs for external devices, such as a camcorder or VCR.



# CHANNEL

You can configure various settings for your TV channels with features such as Auto Program, Favorite Channels, and Signal Strength.

## Channel Menu

### ❑ Antenna → Air / Cable

Before your television can begin memorizing the available channels, you must specify the type of signal source that is connected to the TV (i.e. an Air or a Cable system).

- ✎ Press the **TOOLS** button to display the **Tools** menu. You can also set the Antenna by selecting **Tools** → **Switch to Cable** (or **Switch to Air**).

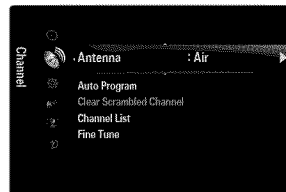

### ❑ Auto Program

- ☰ **Air: Air antenna signal. / Cable: Cable antenna signal. / Auto: Air and Cable antenna signals**

- ✎ When selecting the Cable TV system: Selects the cable system. **STD**, **HRC** and **IRC** identify various types of cable TV systems. Contact your local cable company to identify the type of cable system that exists in your particular area. At this point the signal source has been selected.
- ✎ After all the available channels are stored, it starts to remove scrambled channels (Removing scrambled channel). The Auto program menu then reappears.
- ✎ If you want to stop Auto Programming, press the **ENTER** button. The **Stop Auto Program?** message will be displayed. Select **Yes** by pressing the ◀ or ▶ button, then press the **ENTER** button.

### ❑ Clear Scrambled Channel (digital channels only)

This function is used to filter out scrambled channels after **Auto Program** is completed. This process may take up to 20~30 minutes.

- ✎ To stop searching scrambled channels: Press the **ENTER** button to select **Stop**. Press the ◀ button to select **Yes**, then press the **ENTER** button.
- ✎ This function is only available in **Cable** mode.

### ❑ Channel List

For detailed procedures on using the **Channel List**, refer to the 'Managing Channels' instructions. (see pages 14~15)

- 📄 You can select these options by simply pressing the **CH LIST** button on the remote control.

### ❑ Fine Tune (analog channels only)

Use fine tuning to manually adjust a particular channel for optimal reception.

- ✎ If you do not store the fine-tuned channel in memory, adjustments are not saved.
- ✎ \*\* will appear next to the name of fine-tuned channels.
- ✎ To reset the fine tuning setting, press the ▼ button to select **Reset**, then press the **ENTER** button.

## Managing Channels

Using this menu, you can add / delete or set favorite channels and use the program guide for digital broadcasts.

### All Channels

Shows all currently available channels.

### Added Channels

Shows all added channels.



### Favorite

Shows all favorite channels.

 To select the favorite channels you have set up, press the **FAV.CH** button on the remote control.

### Programmed

Shows all current reserved programs.

 Select a channel in the **All Channels**, **Added Channels** or **Favorite** screen by pressing the **▲ / ▼** buttons, and pressing the **ENTER**  button. Then you can watch the selected channel.

 Using the color buttons with the Channel List

- Red (**Antenna**): Switches to **Air** or **Cable**.
- Green (**Zoom**): Enlarges or shrinks a channel number.
- Yellow (**Select**): Selects multiple channel lists. You can perform the add/delete or add to Favorite/delete from Favorite function for multiple channels at the same time. Select the required channels and press the yellow button to set all the selected channels at the same time. The **✓** mark appears to the left of the selected channels.
- **TOOLS (Tools)**: Displays the **Add (or Delete)**, **Add to Favorite (or Delete from Favorite)**, **Timer Viewing**, **Channel Name Edit**, **Select All (or Deselect All)** and **Auto Program** menus (The Options menus may differ depending on the situation.)

 Channel Status Display Icons

**✓** : A channel selected by pressing the yellow button.

 : A program currently being broadcast.

 : A channel set as a Favorite.

 : A reserved program.



### Channel List Option Menu (in All Channels / Added Channels / Favorite)

 Press the **TOOLS** button to use the option menu.

 Option menu items may differ depending on the channel status.

### Add / Delete

You can delete or add a channel to display the channels you want.

 All deleted channels will be shown on the **All Channels** menu.

 A gray-colored channel indicates the channel has been deleted.

 The **Add** menu only appears for deleted channels.

 You can also delete a channel from the **Added Channels** or **Favorite** menu in the same manner.



### ■ Add to Favorite / Delete from Favorite

You can set channels you watch frequently as Favorite.

✎ Press the **TOOLS** button to display the **Tools** menu. You can also set the add to (or delete from) Favorites by selecting **Tools** → **Add to Favorite** (or **Delete from Favorite**).

✎ The '♥' symbol will be displayed and the channel will be set as a favorite.

✎ All favorite channels will be shown on **Favorite** menu.

### ■ Timer Viewing

If you reserve a program you want to watch, the channel is automatically switched to the reserved channel in the Channel List; even when you are watching another channel. To reserve a program, set the current time first.

✎ Only memorized channels can be reserved.

✎ You can set the channel, day, month, year, hour and minute directly by pressing the number buttons on the remote control.

✎ Reserving a program will be shown in the **Programmed** menu.

✎ Digital Program Guide and Viewing Reservation

When a digital channel is selected, and you press the ► button, the Program Guide for the channel appears. You can reserve a program according to the procedures described above.

### ■ Channel Name Edit (analog channels only)

Channels can be labeled so that their call letters appear whenever the channel is selected.

✎ The names of digital broadcasting channels are automatically assigned and cannot be labeled.

### ■ Select All / Deselect All

● **Select All**: You can select all the channels in the channel list.

● **Deselect All**: You can deselect all the selected channels.

✎ You can only select **Deselect All** when there is a selected channel.

### ■ Auto Program

✎ For detailed procedures on using the **Auto Program**, refer to the 'Channel Menu' instructions. (see page 13)

## Channel List Option Menu (in Programmed)

You can view, modify or delete a reservation.

✎ Press the **TOOLS** button to use the option menu.

### ■ Change Info

Select to change a viewing reservation.

### ■ Cancel Schedules

Select to cancel a viewing reservation.

### ■ Information

Select to view a viewing reservation.

(You can also change the reservation information.)

### ■ Select All

Select all reserved programs.

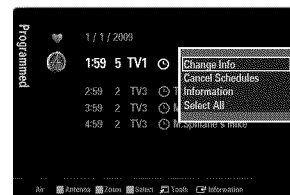

# PICTURE

You can configure various picture options such as the picture mode, aspect ratio, and color to suit your personal preferences.

## Configuring the Picture Menu

### □ Mode

You can select the type of picture which best corresponds to your viewing requirements.

✎ Press the **TOOLS** button to display the **Tools** menu. You can also set the picture mode by selecting **Tools** → **Picture Mode**.

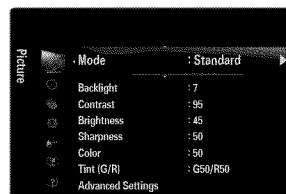

### ▣ Dynamic

Selects the picture for increased definition in a bright room.

### ▣ Standard

Selects the picture for the optimum display in a normal environment.

### ▣ Natural

Selects the picture for an optimum and eye-comfortable display.

✎ **Natural** is not available in PC mode.

### ▣ Movie

Selects the picture for viewing movies in a dark room.

### □ Backlight / Contrast / Brightness / Sharpness / Color / Tint(G/R)

Your television has several setting options that allow you to control the picture quality.

- **Backlight:** Adjusts the brightness of LCD back light.
- **Contrast:** Adjusts the contrast level of the picture.
- **Brightness:** Adjusts the brightness level of the picture
- **Sharpness:** Adjusts the edge definition of the picture.
- **Color:** Adjusts color saturation of the picture.
- **Tint(G/R):** Adjusts the color tint of the picture.

✎ When you make changes to **Backlight, Contrast, Brightness, Sharpness, Color** or **Tint(G/R)** the OSD will be adjusted accordingly.

✎ In PC mode, you can only make changes to **Backlight, Contrast** and **Brightness**.

✎ Settings can be adjusted and stored for each external device you have connected to an input of the TV.

✎ The energy consumed during use can be significantly reduced if the brightness level of the picture is lowered, which will reduce the overall running cost.



### □ Advanced Settings

Samsung's new TVs allow you to make even more precise picture settings than previous models.

✎ **Advanced Settings** is available in **Standard** or **Movie** mode.

✎ In PC mode, you can only make changes to **Dynamic Contrast, Gamma** and **White Balance** from among the **Advanced Settings** items.

### ▣ Black Tone → Off / Dark / Darker / Darkest

You can select the black level on the screen to adjust the screen depth.



### ☰ **Dynamic Contrast** → **Off / Low / Medium / High**

You can adjust the screen contrast so that the optimal contrast is provided.

### ☰ **Gamma**

You can adjust the primary color (red, green, blue) intensity.

### ☰ **Color Space**

Color space is a color matrix composed of red, green and blue colors. Select your favorite color space to experience the most natural color.

- **Auto:** Auto color space automatically adjusts to the most natural color tone based on program sources.
- **Native:** Native color space offers deep and rich color tone.
- **Custom:** Adjusts the color range to suit your preference.
  - ☑ Changing the adjustment value will refresh the adjusted screen.
  - ☑ Settings can be adjusted and stored for each external device you have connected to an input of the TV. For example, if you have a DVD player connected to HDMI 1 and it is currently selected, settings and adjustments will be saved for the DVD player.
    - **Color: Red, Green, Blue, Yellow, Cyan or Magenta**
      - ☑ **Color** is available when **Color Space** is set to **Custom**.
      - ☑ In **Color**, you can adjust the RGB values for the selected color.
      - ☑ To reset the adjusted RGB value, select **Reset**.
    - **Red:** Adjusts the red saturation level of the selected color.
    - **Green:** Adjusts the green saturation level of the selected color.
    - **Blue:** Adjusts the blue saturation level of the selected color.
    - **Reset:** Resets the color space to the default values.

### ☰ **White Balance**

You can adjust the color temperature for more natural picture colors.

- **R-Offset:** Adjusts the red color darkness.
- **G-Offset:** Adjusts the green color darkness.
- **B-Offset:** Adjusts the blue color darkness.
- **R-Gain:** Adjusts the red color brightness.
- **G-Gain:** Adjusts the green color brightness.
- **B-Gain:** Adjusts the blue color brightness.
- **Reset:** The previously adjusted white balance will be reset to the factory defaults.

### ☰ **Flesh Tone**

You can emphasize the pink 'flesh tone' in the picture.

- ☑ Changing the adjustment value will refresh the adjusted screen.

### ☰ **Edge Enhancement** → **Off / On**

You can emphasize object boundaries in the picture.

### ☰ **xvYCC** → **Off / On**

Setting the xvYCC mode to on increases detail and color space when watching movies from an external device (ie. DVD player) connected to the HDMI or Component IN jacks.

- ☑ **xvYCC** is available when the picture mode is set to **Movie**, and the external input is set to HDMI or Component mode.



□ **Picture Options**

☑ In PC mode, you can only make changes to the **Color Tone** and **Size** from among the items in **Picture Options**.

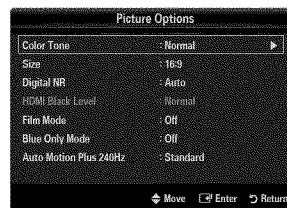

☰ **Color Tone** → **Cool / Normal / Warm1 / Warm2 / Warm3**

- ☑ **Warm1, Warm2 or Warm3** is only activated when the picture mode is **Movie**.
- ☑ Settings can be adjusted and stored for each external device you have connected to an input of the TV.

☰ **Size**

Occasionally, you may want to change the size of the image on your screen. Your TV comes with several screen size options, each designed to work best with specific types of video input. Your cable box/satellite receiver may have its own set of screen sizes as well. In general, though, you should view the TV in 16:9 mode as much as possible.

☑ Alternately, you can press the **P.SIZE** button on the remote control repeatedly to change the picture size.

- **16:9** : Sets the picture to 16:9 wide mode.
- **Zoom1**: Magnifies the size of the picture on the screen.
- **Zoom2**: Magnifies the size of the picture more than **Zoom1**.
- **Wide Fit**: Enlarges the aspect ratio of the picture to fit the entire screen.
- **4:3** : Sets the picture to 4:3 normal mode.
- **Screen Fit**: Use the function to see the full image without any cutoff when HDMI (720p/1080i/1080p), Component (1080i/1080p) or DTV (1080i) signals are input.

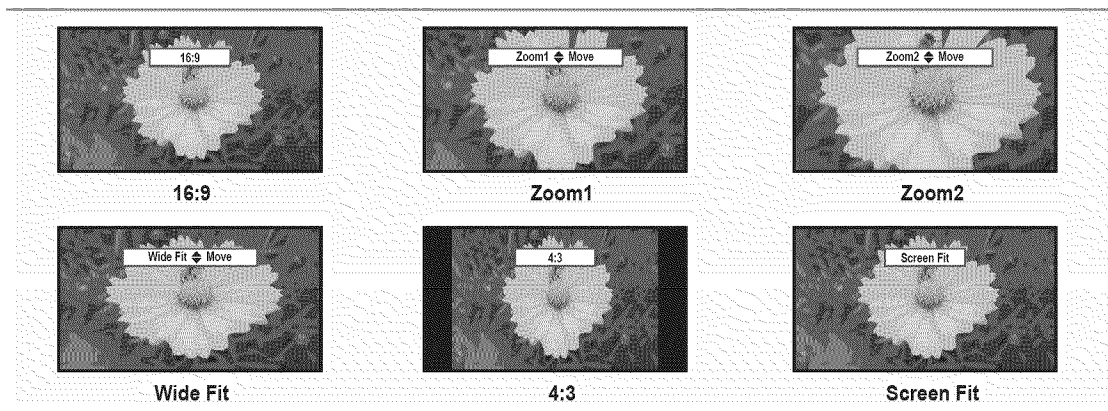

- ☑ When Double ( ) mode has been set in PIP, the Picture Size cannot be set.
- ☑ Temporary image retention may occur when viewing a static image on the set for more than two hours.
- ☑ After selecting **Zoom1**, **Zoom2** or **Wide Fit**: Press the ► button to Select **Position**, then press the **ENTER** button. Press the ▲ or ▼ button to move the picture up and down. Then press the **ENTER** button. Press the ► button to Select **Size**, then press the **ENTER** button. Press the ▲ or ▼ button to magnify or reduce the picture size in the vertical direction. Then press the **ENTER** button.
- ☑ After selecting **Screen Fit** in HDMI (1080i/1080p) or Component (1080i/1080p) mode, you made need to center the picture: Press the ◀ or ▶ button to select **Position**, then press the **ENTER** button. Press the ▲, ▼, ◀ or ▶ button to move the picture.
  - **Reset**: Press the ◀ or ▶ button to select **Reset**, then press the **ENTER** button. You can initialize the setting.
- ☑ HD (High Definition): 16:9 - 1080i/1080p (1920x1080), 720p (1280x720)
- ☑ Settings can be adjusted and stored for each external device you have connected to an input of the TV.

Input Source	Picture Size
ATV, AV, Component (480i, 480p)	16:9, Zoom1, Zoom2, 4:3
DTV(1080i), Component (1080i, 1080p), HDMI (720p, 1080i, 1080p)	16:9, 4:3, Wide Fit, Screen Fit
PC	16:9, 4:3

☰ **Digital NR** → **Off / Low / Medium / High / Auto**

If the broadcast signal received by your TV is weak, you can activate the Digital Noise Reduction feature to help reduce any static and ghosting that may appear on the screen.

☑ When the signal is weak, select one of the other options until the best picture is displayed.

☰ **HDMI Black Level** → **Normal / Low**

You can select the black level on the screen to adjust the screen depth.

☑ This function is active only when an external device is connected to the TV via HDMI. The **HDMI Black Level** function may not be compatible with all external devices.

☰ **Film Mode** → **Off / Auto1 / Auto2**

The TV can be set to automatically sense and process film signals from all sources and adjust the picture for optimum quality.

☑ **Film Mode** is supported in TV, Video, Component (480i / 1080i) and HDMI (480i / 1080i).

- **Off**: Turns the Film Mode function off.
- **Auto1**: Automatically adjusts the picture for the best quality when watching a film.
- **Auto2**: Automatically optimizes the video text on the screen (not including closed captions) when watching a film.

☰ **Blue Only Mode** → **Off / On**

This function is for AV device measurement experts. This function displays the blue signal only by removing the red and green signals from the video signal so as to provide a Blue Filter effect that is used to adjust the color and Tint of video equipment such as DVD players, Home Theaters, etc. Using this function, you can adjust the color and Tint to preferred values appropriate to the signal level of each video device using the Red / Green / Blue / Cyan / Magenta / Yellow color Bar Patterns, without using an additional Blue Filter.

☑ **Blue Only Mode** is available when the picture mode is set to **Movie** or **Standard**.

☰ **Auto Motion Plus 240Hz** → **Off / Clear / Standard / Smooth / Custom / Demo**

Removes drag from fast scenes with a lot of movement to provide a clearer picture.

☑ If you enable **Auto Motion Plus 240Hz**, noise may appear on the screen. If this occurs, set **Auto Motion Plus 240Hz** to **Off**.

- **Off**: Switches Auto Motion Plus 240Hz off.
- **Clear**: Sets Auto Motion Plus 240Hz to minimum.
- **Standard**: Sets Auto Motion Plus 240Hz to medium.
- **Smooth**: Sets Auto Motion Plus 240Hz to maximum.
- **Custom**: Adjusts the blur and judder reduction level to suit your preference.
  - **Blur Reduction**: Adjusts the blur reduction level from video sources.
  - **Judder Reduction**: Adjusts the judder reduction level from video sources when playing films.
  - **Reset**: Reset the custom settings.
- **Demo**: Displays the difference between Auto Motion Plus 240Hz on and off modes.

□ **Picture Reset** → **Reset Picture Mode / Cancel**

Resets all picture settings to the default values.

☑ **Reset Picture Mode**: Current picture values return to default settings.

## Viewing Picture-in-Picture

You can use the PIP feature to simultaneously watch the TV tuner and one external video source. This product has one built-in tuner, which does not allow PIP to function in the same mode. Please see 'PIP Settings' below for details.

Press the **TOOLS** button to display the **Tools** menu. You can also configure PIP related settings by selecting **Tools** → **PIP**.

If you select the PIP picture sound, refer to the 'Configuring the Sound Menu' instructions. (see page 24)

### PIP Settings

Main picture	Sub picture
Component 1, 2	
HDMI1/DVI, HDMI2, HDMI3, HDMI4	TV
PC	

While **V-Chip** or **Internet@TV** is in operation, the **PIP** function cannot be used.

If you turn the TV off while watching in PIP mode and turn it on again, the PIP window will disappear.

You may notice that the picture in the PIP window becomes slightly unnatural when you use the main screen to view a game or karaoke.

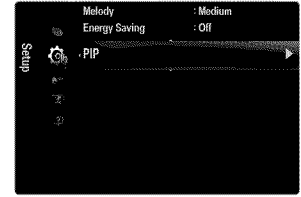

### PIP → On / Off

You can activate or deactivate the PIP function.

**Size** → [Small] / [Medium] / [Large] / [Full]

You can select a size of the PIP-picture.

**Position** → [Top Left] / [Top Right] / [Bottom Left] / [Bottom Right]

You can select a position of the PIP-picture.

In Double ([Double Left], [Double Right]) mode, **Position** cannot be selected.

**Air/Cable** → Air / Cable

Select either Air or Cable as the input source for the sub-screen.

**Channel**

You can select the channel for the sub-screen.

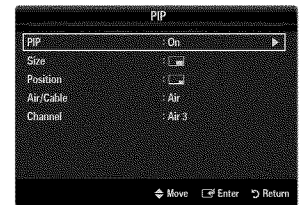

## Using Your TV as a Computer (PC) Display

### Setting Up Your PC Software (Based on Windows XP)

The Windows display-settings for a typical computer are shown below. The actual screens on your PC will probably be different, depending upon your particular version of Windows and your particular video card. However, even if your actual screens look different, the same basic set-up information will apply in almost all cases. (If not, contact your computer manufacturer or Samsung Dealer.)

1. First, click on 'Control Panel' on the Windows start menu.
2. When the control panel window appears, click on 'Appearance and Themes' and a display dialog-box will appear.
3. When the control panel window appears, click on 'Display' and a display dialogbox will appear.
4. Navigate to the 'Settings' tab on the display dialog-box.
  - The correct size setting (resolution) - Optimum: 1920 X 1080 pixels
  - If a vertical-frequency option exists on your display settings dialog box, the correct value is '60' or '60 Hz'. Otherwise, just click 'OK' and exit the dialog box.

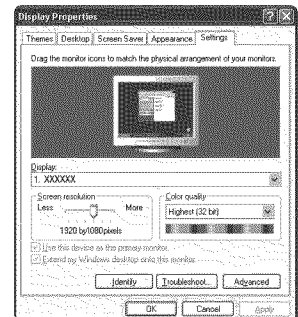

### Display Modes

If the signal from the system equals the standard signal mode, the screen is adjusted automatically. If the signal from the system doesn't equal the standard signal mode, adjust the mode by referring to your videocard user guide; otherwise there may be no video. For the display modes listed below, the screen image has been optimized during manufacturing.

#### D-Sub and HDMI/DVI Input

- ☑ When using an HDMI / DVI cable connection, you must use the **HDMI IN 1(DVI)** jack.

Mode	Resolution	Horizontal Frequency (KHz)	Vertical Frequency (Hz)	Pixel Clock Frequency (MHz)	Sync Polarity (H / V)
IBM	640 x 350	31.469	70.086	25.175	+/-
	720 x 400	31.469	70.087	28.322	-/+
MAC	640 x 480	35.000	66.667	30.240	-/-
	832 x 624	49.726	74.551	57.284	-/-
	1152 x 870	68.681	75.062	100.000	-/-
VESA CVT	720 x 576	35.910	59.950	32.750	+/-
	1152 x 864	53.783	59.959	81.750	+/-
	1280 x 720	44.772	59.855	74.500	+/-
	1280 x 720	56.456	74.777	95.750	+/-
	1280 x 960	75.231	74.857	130.000	+/-
VESA DMT	640 x 480	31.469	59.940	25.175	-/-
	640 x 480	37.861	72.809	31.500	-/-
	640 x 480	37.500	75.000	31.500	-/-
	800 x 600	37.879	60.317	40.000	+/-+
	800 x 600	48.077	72.188	50.000	+/-+
	800 x 600	46.875	75.000	49.500	+/-+
	1024 x 768	48.363	60.004	65.000	-/-
	1024 x 768	56.476	70.069	75.000	-/-
	1024 x 768	60.023	75.029	78.750	+/-+
	1152 x 864	67.500	75.000	108.000	+/-+
	1280 x 1024	63.981	60.020	108.000	+/-+
	1280 x 1024	79.976	75.025	135.000	+/-+
	1280 x 800	49.702	59.810	83.500	-/-
	1280 x 800	62.795	74.934	106.500	-/-
	1280 x 960	60.000	60.000	108.000	+/-+
	1360 x 768	47.712	60.015	85.500	+/-+
	1440 x 900	55.935	59.887	106.500	-/-
1440 x 900	70.635	74.984	136.750	-/-	
1680 x 1050	65.290	59.954	146.250	-/+	
VESA GTF	1280 x 720	52.500	70.000	89.040	+/-
	1280 x 1024	74.620	70.000	128.943	-/-
VESA DMT / DTV CEA	1920 x 1080p	67.500	60.000	148.500	+/-+

## Setting up the TV with your PC

 Preset: Press the **SOURCE** button to select PC mode.

### □ Auto Adjustment

Use the Auto Adjust function to have the TV automatically adjust the video signals it receives. The function also automatically fine-tunes the settings and adjusts the frequency values and positions.

 Press the **TOOLS** button to display the **Tools** menu. You can also set the Auto Adjustment by selecting **Tools** → **Auto Adjustment**.

 This function does not work in DVI-Digital mode.



### □ Screen

#### ☰ Coarse / Fine

The purpose of picture quality adjustment is to remove or reduce picture noise. If the noise is not removed by Fine-tuning alone, then adjust the frequency as best as possible (**Coarse**) and Fine-tune again. After the noise has been reduced, readjust the picture so that it is aligned on the center of screen.

#### ☰ PC Position

Adjust the PC's screen positioning if it does not fit the TV screen.

Press the **▲** or **▼** button to adjusting the Vertical-Position. Press the **◀** or **▶** button to adjust the Horizontal-Position.

#### ☰ Image Reset

You can replace all image settings with the factory default values.

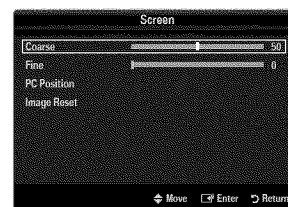



# SOUND

You can configure the sound mode, volume, multi-track sound options, etc.

## Configuring the Sound Menu

### □ Mode → Standard / Music / Movie / Clear Voice / Custom

 Press the **TOOLS** button to display the **Tools** menu. You can also set the sound mode by selecting **Tools** → **Sound Mode**.

- **Standard**: Selects the normal sound mode.
- **Music**: Emphasizes music over voices.
- **Movie**: Provides the best sound for movies.
- **Clear Voice**: Emphasizes voice over other sounds.
- **Custom**: Recalls your customized sound settings.

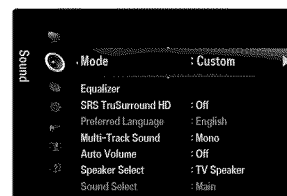

### □ Equalizer

The sound settings can be adjusted to suit your personal preference.

- **Mode**: Selects the sound mode among the predefined settings.
- **Balance L/R**: Adjusts the balance between the right and left speaker.
- **100Hz / 300Hz / 1KHz / 3KHz / 10KHz (Bandwidth Adjustment)**: To adjust the level of different bandwidth frequencies.
- **Reset**: Resets the equalizer settings to the default values.



### □ SRS TruSurround HD → Off / On

SRS TruSurround HD is a patented SRS technology that solves the problem of playing 5.1 multichannel content over two speakers. TruSurround delivers a compelling, virtual surround sound experience through any two-speaker playback system, including internal television speakers. It is fully compatible with all multichannel formats.

 Press the **TOOLS** button to display the **Tools** menu. You can also set the SRS TruSurround HD by selecting **Tools** → **SRS TS HD**.



### □ Preferred Language (digital channels only)

Digital-TV broadcasts are capable of simultaneous transmission of many audio tracks (for example, simultaneous translations of the program into foreign languages).

-  You can listen in a language other than the **Preferred Language** by pressing the **MTS** button on the remote control.
-  **Preferred Language** is available only in Digital TV mode.
-  You can only select the language from among the actual languages being broadcast.

### □ Multi-Track Sound (MTS) (analog channels only)

 Press the **MTS** button on the remote control repeatedly to select **Mono**, **Stereo** or **SAP**.

- **Mono**: Choose for channels that are broadcasting in mono or if you are having difficulty receiving a stereo signal.
- **Stereo**: Choose for channels that are broadcasting in stereo.
- **SAP**: Choose to listen to the Separate Audio Program, which is usually a foreign-language translation.
-  **Multi-Track Sound** is available only in Analog TV mode.
-  Depending on the particular program being broadcast, you can listen to **Mono**, **Stereo** or **SAP**.

❑ **Auto Volume → Off / On**

Each broadcasting station has its own signal conditions, and so it is not easy to adjust the volume every time the channel is changed. This feature lets you automatically adjust the volume of the desired channel by lowering the sound output when the modulation signal is high or by raising the sound output when the modulation signal is low.

❑ **Speaker Select**

When you watch TV with it connecting to a Home theater, turn the TV speakers off so you can listen to sound from the Home theater's (external) speakers.

- **External Speaker:** Used to listen to the sound of the External (Home Theater) Speakers.
- **TV Speaker:** Used to listen to the sound of the TV Speakers.
- ☑ The volume and **MUTE** buttons do not operate when the **Speaker Select** is set to **External Speaker**. Please set the volume on your Home theater.
- ☑ If you select **External Speaker** in the **Speaker Select** menu, the sound settings will be limited

	TV's Internal Speakers	Audio Out (Optical, L/R Out) to Sound System
	RF / AV / Component / PC / HDMI	RF / AV / Component / PC / HDMI
<b>TV Speaker</b>	Sound Output	Sound Output
<b>External Speaker</b>	Mute	Sound Output
Video No Signal	Mute	Mute

❑ **Sound Select → Main / Sub**

When the PIP feature is activated, you can listen to the sound of the sub (PIP) picture.

- ☑ You can select this option when **PIP** is set to **On**.
- ☑ Press the **TOOLS** button to display the **Tools** menu. You can also set the sound of the sub picture by selecting **Tools → PIP → Sound Select**.

❑ **Sound Reset → Reset All / Reset Sound Mode / Cancel**

You can restore the Sound settings to the factory defaults.

- ☑ **Reset Sound Mode:** Current sound values return to default settings.



# SETUP

You can set up additional functions.

## Configuring the Setup Menu

### Language

You can set the menu language.

### Time

For detailed procedures on setting up options, refer to the 'Setting the Time' instructions. (see pages 28~29)

### Game Mode → Off / On

When connecting to a game console such as PlayStation™ or Xbox™, you can enjoy a more realistic gaming experience by selecting game menu.

- ☑ Restrictions on game mode (Caution)
  - To disconnect the game console and connect another external device, set **Game Mode** to **Off** in the setup menu.
  - If you display the TV menu in **Game Mode**, the screen shakes slightly.
- ☑ **Game Mode** is not available in regular TV and PC mode.
- ☑ While PIP is in operation, the **Game Mode** function cannot be used.
- ☑ If the picture is poor when external device is connected to TV, check if **Game Mode** is **On**. Set **Game Mode** to **Off** and connect external devices.
- ☑ If **Game Mode** is **On**:
  - Picture mode is automatically changed to **Standard** and cannot be changed.
  - Sound mode is automatically changed to **Custom** and cannot be changed. Adjust the sound using the equalizer.
  - The Reset Sound function is activated. Selecting the Reset function after setting the equalizer resets the equalizer settings to the factory defaults.



### BD Wise → Off / On

Provides the optimal picture quality for SAMSUNG DVD, Blu-ray and Home Theater products which support BD Wise. You can enjoy a richer picture when using them connected to this Samsung TV.

- ☑ Connect SAMSUNG products that have BD Wise using an HDMI cable.
- ☑ When the **BD Wise** set to **On**, the picture mode is automatically changed to the optimal resolution.
- ☑ **BD Wise** is available in HDMI mode.

### Network Type / Network Setup

For detailed procedures on setting up options, refer to the 'Setting the Network' instructions. (see pages 30~35)

### V-Chip

The V-Chip feature automatically locks out programs that are deemed inappropriate for children. The user must enter a PIN (personal ID number) before any of the V-Chip restrictions are set up or changed.

- ☑ **V-Chip** function is not available in HDMI, Component or PC mode.
- ☑ The default PIN number of a new TV set is '0-0-0-0'
- ☑ **Allow all**: Press to unlock all TV ratings. / **Block all**: Press to lock all TV ratings.

### Change PIN

The Change PIN screen will appear. Choose any 4 digits for your PIN and enter them. As soon as the 4 digits are entered, the **Confirm New PIN** screen appears. Re-enter the same 4 digits. When the Confirm screen disappears, your PIN has been memorized.

- ☑ If you forget the PIN, press the remote-control buttons in the following sequence, which resets the pin to 0-0-0-0 : **POWER** (off) → **MUTE** → **8** → **2** → **4** → **POWER** (on).

### ■ V-Chip Lock → Off / On

You can block rated TV Programs.

### ■ TV Parental Guidelines

You can block TV programs depending on their rating. This function allows you to control what your children are watching.

- **TV-Y:** Young children / **TV-Y7:** Children 7 and over / **TV-G:** General audience / **TV-PG:** Parental guidance / **TV-14:** Viewers 14 and over / **TV-MA:** Mature audience

- **ALL:** Lock all TV ratings. / **FV:** Fantasy violence / **V:** Violence / **S:** Sexual situation / **L:** Adult Language / **D:** Sexually Suggestive Dialog

The V-Chip will automatically block certain categories that are more restrictive. For example, if you block **TV-Y** category, then **TV-Y7** will automatically be blocked. Similarly, if you block the **TV-G** category, then all the categories in the young adult group will be blocked (**TV-G**, **TV-PG**, **TV-14** and **TV-MA**). The sub-ratings (**D**, **L**, **S**, **V**) work together similarly.

The V-chip will automatically block certain categories that are 'More restrictive'. For example, if you block **L** sub-rating in **TV-PG**, then the **L** sub-ratings in **TV-14** and **TV-MA** will automatically be blocked.

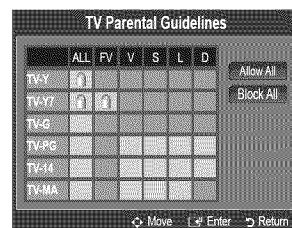

### ■ MPAA Rating

You can block movies depending on their MPAA rating. The Motion Picture Association of America(MPAA) has implemented a rating system that provides parents or guardians with advance information on which films are appropriate for children.

- **G:** General audience (no restrictions).
- **PG:** Parental guidance suggested.
- **PG-13:** Parents strongly cautioned.
- **R:** Restricted. Children under 17 should be accompanied by an adult.
- **NC-17:** No children under age 17.
- **X:** Adults only.
- **NR:** Not rated.

The V-Chip will automatically block any category that is 'More restrictive'. For example, if you block the **PG-13** category, then **R**, **NC-17** and **X** will automatically be blocked also.

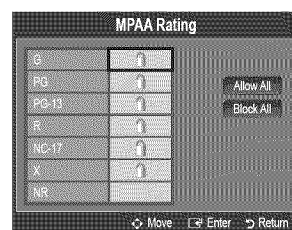

### ■ Canadian English

- **C:** Programming intended for children under age 8.
- **C8+:** Programming generally considered acceptable for children 8 years and over to watch on their own.
- **G:** General programming, suitable for all audiences.
- **PG:** Parental Guidance.
- **14+:** Programming contains themes or content which may not be suitable for viewers under the age of 14.
- **18+:** Adult programming.

The **V-Chip** will automatically block any category that is 'More restrictive'. For example, if you block **G** category, then **PG**, **14+** and **18+** will automatically be blocked also.

### ■ Canadian French

- **G:** General
- **8 ans+:** Programming generally considered acceptable for children 8 years and over to watch on their own.
- **13 ans+:** Programming may not be suitable for children under the age of 13.
- **16 ans+:** Programming is not suitable for children under the age of 16.
- **18 ans+:** Programming restricted to adults.

The **V-Chip** will automatically block any category that is 'More restrictive'. For example, if you block **8 ans+** category, then **13 ans+**, **16 ans+** and **18 ans+** will automatically be blocked also.

### Downloadable U.S. Rating

Parental restriction information can be used while watching DTV channels

- ☑ If information is not downloaded from the broadcasting station, the **Downloadable U.S. rating** menu is deactivated.
- ☑ Parental restriction information is automatically downloaded while watching DTV channels. It may take several seconds.
- ☑ The **Downloadable U.S. rating** menu is available for use after information is downloaded from the broadcasting station. However, depending on the information from the broadcasting station, it may not be available for use.
- ☑ Parental restriction levels differ depending on the broadcasting station. The default menu name and Downloadable US rating changes depending on the downloaded information.
- ☑ Even if you set the On-screen display to your desired language, the **Downloadable U.S. Rating** menu will appear in English only.
- ☑ The rating will automatically block certain categories that are more restrictive.
- ☑ The rating titles (For example: Humor Level..etc) and TV ratings (For example: DH, MH, H..etc) may differ depending on the broadcasting station.

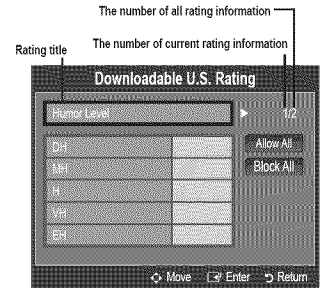

### How to Reset the TV after the V-Chip Blocks a Channel (Emergency Escape)

If the TV is tuned to a restricted channel, the V-Chip will block it. The screen will go black and the following message will appear:

1. Enter your PIN, then press the **▲** or **▼** button to temporarily disable the V-Chip Lock.
- ☑ If you forget the PIN, press the remote-control buttons in the following sequence, which resets the pin to 0-0-0-0 : **POWER** (off) → **MUTE** → **8** → **2** → **4** → **POWER** (on)

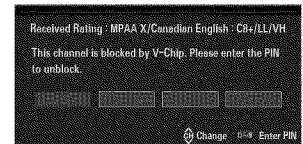

### Caption (On-Screen Text Messages)

#### Caption → Off / On

You can switch the caption function on or off. If captions are not available, they will not be displayed on the screen.

- ☑ Press the **CC** button on the remote control to turn the Caption on or off.
- ☑ The Caption feature doesn't work in Component, HDMI or PC modes.

#### Caption Mode

You can select the desired caption mode.

- ☑ The availability of captions depends on the program being broadcast.
  - **Default / CC1~CC4 / Text1~Text4** (analog channels only)
 

The Analog Caption function operates in either analog TV channel mode or when a signal is supplied from an external device to TV. (Depending on the broadcasting signal, the Analog Caption function may operate on digital channels.)
  - **Default / Service1~Service6 / CC1~CC4 / Text1~Text4** (digital channels only)
 

The Digital Captions function operates on digital channels.

    - ☑ **Service1~6** in digital caption mode may not be available depending on the broadcast.

#### Digital Caption Options (digital channels only)

- **Size**: This option consists of **Default, Small, Standard** and **Large**. The default is **Standard**.
- **Font Style**: This option consists of **Default, Style 0 ~ Style 7**. You can change the font you want. The default is **Style 0**.
- **Foreground Color**: This option consists of **Default, White, Black, Red, Green, Blue, Yellow, Magenta** and **Cyan**. You can change the color of the letter. The default is **White**.
- **Background Color**: This option consists of **Default, White, Black, Red, Green, Blue, Yellow, Magenta** and **Cyan**. You can change the background color of the caption. The default is **Black**.
- **Foreground Opacity**: This option consists of **Default, Transparent, Translucent, Solid** and **Flashing**. You can change the opacity of the letter.

- **Background Opacity:** This option consists of **Default**, **Transparent**, **Translucent**, **Solid** and **Flashing**. You can change the background opacity of the caption.
- **Return to Default:** This option sets each of **Size**, **Font Style**, **Foreground Color**, **Background Color**, **Foreground Opacity** and **Background Opacity** to its default.
- ☑ **Digital Caption Options** are available only when **Default** and **Service1 ~ Service6** can be selected in **Caption Mode**.
- ☑ The availability of captions depends on the program being broadcast.
- ☑ **Default** means to follow the standard set by the broadcaster.
- ☑ Foreground and Background cannot be set to have the same color.
- ☑ **Foreground Opacity** and **Background Opacity** cannot be both set to **Transparent**.

#### ☐ **Melody → Off / Low / Medium / High**

A melody sound can be set to come on when the TV is powered On or Off.

- ☑ The Melody does not play.
  - When no sound is output from the TV because the **MUTE** button has been pressed.
  - When no sound is output from the TV because the volume has been reduced to minimum with the **VOL –** button.
  - When the TV is turned off by Sleep Timer function.

#### ☐ **Light Effect → Off / In Standby / Watching TV / Always**

You can turn the LED on/off on the front of TV. Turn it off to save power or if the LED bothers you.

- **Off:** LED is always Off.
- **In Standby:** LED is On when TV is turned off.
- **Watching TV:** LED is On when watching TV.
- **Always:** LED is always On, regardless of TV settings.
- ☑ Set the **Light Effect** to **Off** to reduce the power consumption.
- ☑ The color of light may vary depending on the model.

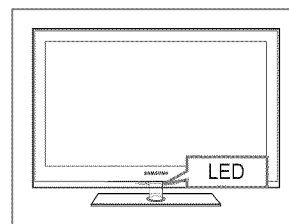

#### ☐ **Energy Saving → Off / Low / Medium / High / Auto**

This feature adjusts the brightness of the TV in order to reduce power consumption. When watching TV at night, set the **Energy Saving** mode option to **High** to reduce eye fatigue as well as power consumption.

#### ☐ **PIP**

For detailed procedures on setting up options, refer to the 'Viewing Picture-in-Picture' instructions. (see page 20)

## Setting the Time

#### ☐ **Clock**

Setting the clock is necessary in order to use the various timer features of the TV.

- ☑ The current time will appear every time you press the **INFO** button.
- ☑ If you disconnect the power cord, you have to set the clock again.



#### ☐ **Clock Mode**

You can set up the current time manually or automatically.

- **Auto:** Set the current time automatically using the time from the digital broadcast.
- **Manual:** Set the current time to a manually specified time.
- ☑ Depending on the broadcast station and signal, the auto time may not be set correctly. If this occurs, set the time manually.
- ☑ The Antenna or cable must be connected in order to set the time automatically.



#### ☐ **Clock Set**

You can set the current time manually.

- ☑ This function is only available when **Clock Mode** is set to **Manual**.
- ☑ You can set the month, day, year, hour and minute directly by pressing the number buttons on the remote control.

### ☰ Time Zone

Select your time zone.

☑ This function is only available when **Clock Mode** is set to **Auto**.

### ☰ DST (Daylight Saving Time) → Off / On / Auto

Switches the Daylight Saving Time function on or off.

☑ This function is only available when **Clock Mode** is set to **Auto**.

### □ Sleep Timer

The sleep timer automatically shuts off the TV after a preset time (30, 60, 90, 120, 150 and 180 minutes).

☑ Press the **TOOLS** button to display the **Tools** menu. You can also set the sleep timer by selecting **Tools** → **Sleep Timer**.

☑ To cancel the **Sleep Timer** function, select **Off**.

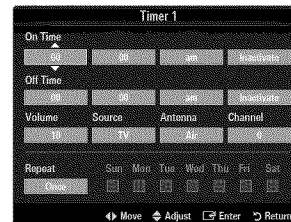

### □ Timer 1 / Timer 2 / Timer 3

Three different on / off timer settings can be made.

You must set the clock first.

#### ☰ On Time

Set the hour, minute, am/pm, and activate / inactivate.

(To activate the timer with the setting you've chosen, set to **Activate**.)

#### ☰ Off Time

Set the hour, minute, am/pm, and activate / inactivate.

(To activate the timer with the setting you've chosen, set to **Activate**.)

#### ☰ Volume

Set the desired volume level.

#### ☰ Source → TV / USB / TV Memory

You can select the **TV**, **TV Memory** or **USB** device content to be played when the TV turns on automatically. Select **TV**, **TV Memory** or **USB**. (Make sure that an USB device is connected to your TV.)

☑ When there is only one photo file in the **USB** or the **TV Memory**, the Slide Show will not play.

#### ☰ Antenna (when Source is set to TV)

Select Air or Cable.

#### ☰ Channel (when Source is set to TV)

Select the desired channel.

#### ☰ Contents (when Source is set to USB or TV Memory)

You can select a folder on the USB Device/TV Memory with music or photo files to be played when the TV turns on automatically.

☑ If the folder name is too long, the folder can not be selected.

☑ If you are using two of the same type USB device, be sure the folder names are different so the correct USB is read.

#### ☰ Repeat

Select **Once**, **Everyday**, **Mon~Fri**, **Mon~Sat**, **Sat~Sun** or **Manual**.

☑ When **Manual** is selected, press the ► button to select the desired day of the week. Press the **ENTER** button over the desired day and the ✓ mark will appear.

☑ You can set the hour, minute and channel by pressing the number buttons on the remote control.

☑ Auto Power Off

When you set the timer on, the television will eventually turn off, if no controls are operated for 3 hours after the TV was turned on by the timer. This function is only available in timer on mode and prevents overheating, which may occur if a TV is on for too long time.

## Network Connection

You can set up the Internet Protocol so that you can communicate with various connected networks.

### Network Connection - Cable

#### LAN Connection for a DHCP Environment

The procedures to set up the network using Dynamic Host Configuration Protocol (DHCP) are described below. Since an IP address, subnet mask, gateway, and DNS are automatically allocated when DHCP is selected, you do not have to enter them manually.

1. Connect the LAN port on the rear panel of the TV and the external modem with a LAN Cable.
2. Connect the Modem port on the wall and the external modem with a Modem Cable.

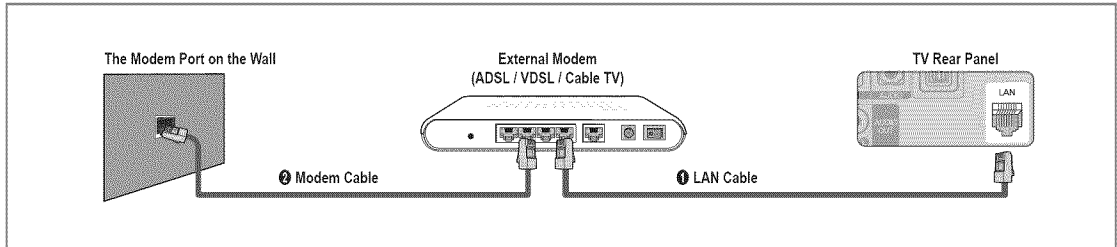

### You can connect the LAN via a Sharer (Router).

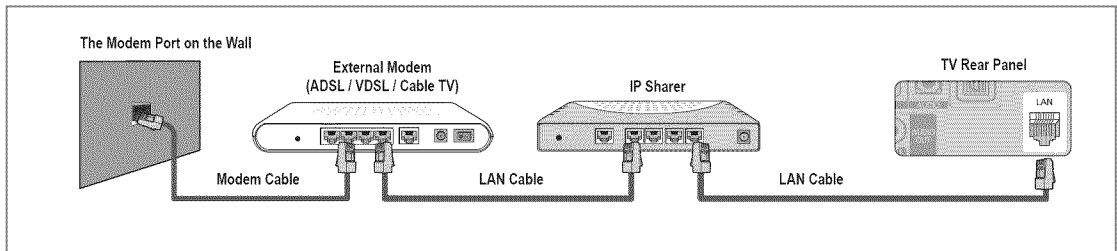

### You can connect the LAN port and the TV directly depending on your network status.

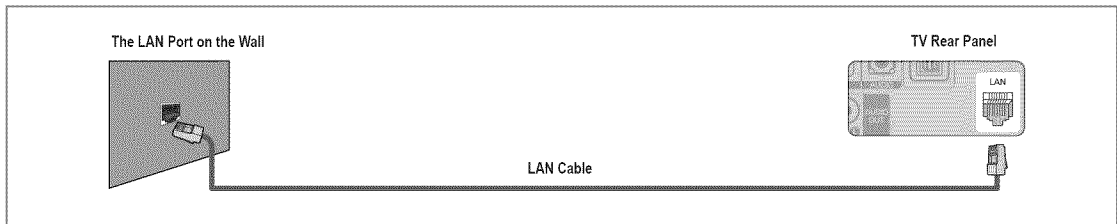

- ⓘ The terminals (the position of the port and the type) of the external device may differ depending on the manufacturer.
- ⓘ If the IP address allocation by the DHCP server has failed, turn the external modem off, turn it on again after at least 10 seconds and then try again.
- ⓘ For the connections between the external modem and the Sharer (Router), refer to the owner's manual of the corresponding product.
- ⓘ You can connect the TV to the LAN directly without connecting it through a Sharer (Router)
- ⓘ You cannot use a manual-connection-type ADSL modem because it does not support DHCP. You have to use an automatic-connection-type ADSL modem.



### LAN Connection for Static IP Environment

The procedures to set up the network using a static IP address are described below. You have to manually enter the IP address, subnet mask, gateway, and DNS that are provided by your Internet Service Provider (ISP).

1. Connect the LAN port on the rear panel of the TV and the LAN port on the wall using the LAN cable.

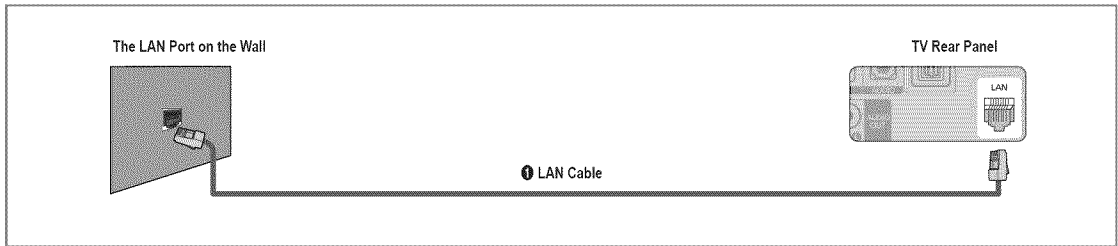

### You can connect the LAN via a Sharer (Router).

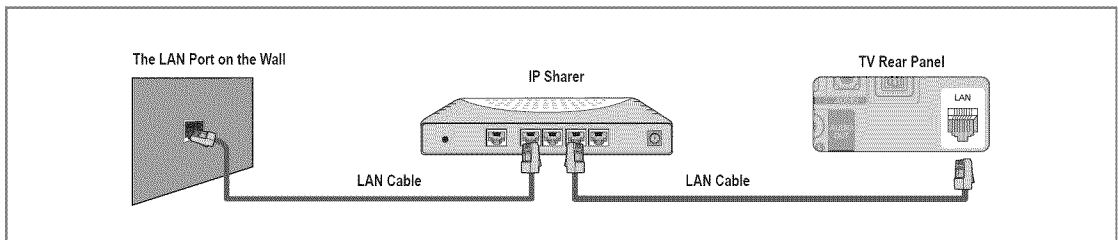

- ☒ The terminals (the position of the port and the type) of the external device may differ depending on the manufacturer.
- ☒ If you are using a static IP address, your ISP will inform you of the IP address, subnet mask, gateway, and DNS. You must enter these values to complete the network settings. If you do not know the values, ask your network administrator.
- ☒ For the information on how to configure and connect a Sharer (Router), refer to the owner's manual for the corresponding product.
- ☒ You can connect the TV to the LAN directly without connecting it through a Sharer (Router).
- ☒ If you use an IP Sharer (IP Router) that supports DHCP, you can set up the device as either DHCP or static IP.
- ☒ For the procedures to use a static IP address, ask your Internet Service Provider.

## ❑ Network Connection - Wireless

You can connect to the network wirelessly through a wireless IP sharer.

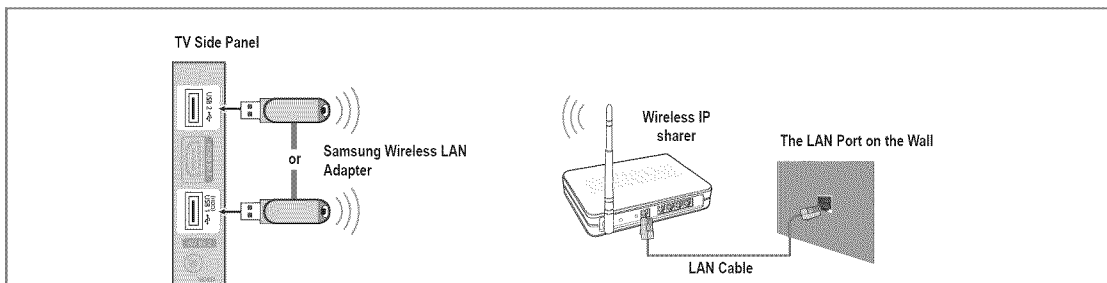

1. Connect the 'Samsung Wireless LAN Adapter' into the **USB1(HDD)** or **USB2** terminal of the TV.
  - ☑ You must use the 'Samsung Wireless LAN Adapter' (WIS09ABGN) to use a wireless network.
  - ☑ Samsung's Wireless LAN adapter is sold separately. The WIS09ABGN Wireless LAN adapter is offered by select retailers, Ecommerce sites and Samsungparts.com.
  - ☑ To use a wireless network, your TV must be connected to a wireless IP sharer. If the wireless IP sharer supports DHCP, your TV can use a DHCP or static IP address to connect to the wireless network.
  - ☑ Samsung's Wireless LAN adapter supports IEEE 802.11A, IEEE 802.11B, IEEE 802.11G, IEEE 802.11N. When you play DLNA video over IEEE 802.11B/G connection, the video may not be played smoothly.
  - ☑ If the wireless IP sharer allows you to turn the Ping connection function on/off, turn it on.
  - ☑ Select a channel for the wireless IP sharer that is not currently being used. If the channel set for the wireless IP sharer is currently being used by another device nearby, this will result in interference and communications may fail.
  - ☑ If you apply a security system other than the systems listed below, it will not work with the TV.
    - When applying the security key for the AP (wireless IP sharer), only the following is supported.
      - 1) Authentication Mode : OPEN, SHARED, WPAPSK, WPA2PSK
      - 2) Encryption Type : WEP, TKIP, AES
    - When applying the security key for the Ad-hoc mode, only the following is supported.
      - 1) Authentication Mode : SHARED, WPANONE
      - 2) Encryption Type : WEP, TKIP, AES
  - ☑ If your AP supports WPS(Wi-Fi Protected Setup), you can connect to the network via PBC (Push Button Configuration) or PIN (Personal Identification Number). WPS will automatically configure the SSID and WPA key in either mode.
  - ☑ If the device isn't certified, it may not connect to the TV via the 'Samsung Wireless LAN Adapter'.

## Setting the Network

### ❑ Network Type

Select Cable or Wireless as the method to connect to the network.

The menu is activated only if the 'Samsung Wireless LAN Adapter' is connected.

#### ☰ Cable

Connect to the network using a cable.

#### ☰ Wireless

Connect to the network wirelessly.

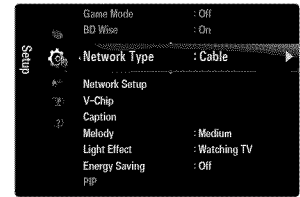

### ❑ Network Setup

#### ☰ Cable Network Setup (when Network Type is set to Cable)

Please check if the LAN cable is connected.

- **Internet Protocol Setup** → **Auto Setup / Manual Setup**

- **Network Test:** You can test or confirm the network connection status after setting up the network.

When unable to connect to a wired network

If your Internet service provider has registered the MAC address of the device used to connect to the Internet for the first time and authenticates the MAC address each time you connect to the Internet, your TV may not be able to connect to the Internet as the MAC address differs from that of the device (PC).

In this case, ask your Internet service provider about the procedures to connect devices other than your PC (such as your TV) to the Internet. If your Internet service provider requires an ID or password to connect to the Internet (network), your TV may not be able to connect to the Internet. In this case, you have to enter your ID or password when connecting to the Internet using an Internet Sharer (Router).

The internet connection may fail due to a firewall problem. In this case, contact your Internet service provider. If you cannot connect to the Internet even if you have followed the procedures of your Internet service provider, please contact Samsung Electronics at 1-800-SAMSUNG.

### Cable Network Setup-Auto Setup

If you connect the LAN cable and it supports DHCP, the Internet Protocol (IP) Settings are automatically configured.

1. Set **Network Type** to **Cable**.
2. Select **Cable Network Setup**.
3. Set **Internet Protocol Setup** to **Auto Setup**.  
 The Internet Protocol is set automatically.
4. Select **Network Test** to check the network connectivity.

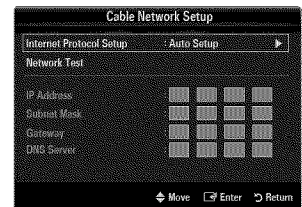

### Cable Network Setup-Manual

To connect the TV to the LAN using a static IP address, you must set up the Internet Protocol (IP).

1. Set **Network Type** to **Cable**.
2. Select **Cable Network Setup**.
3. Set **Internet Protocol Setup** to **Manual Setup**.
4. Set up **IP Address**, **Subnet Mask**, **Gateway** and **DNS Server**.  
 Press the number buttons on the remote control when you set the Network manually.
5. Select **Network Test** to check the network connectivity.

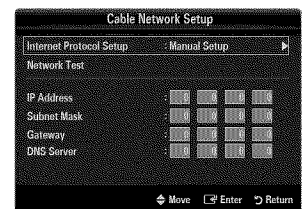

#### ☰ Wireless Network Setup

The menu is activated only if the 'Samsung Wireless LAN Adapter' is connected.

- **Internet Protocol Setup** → **Auto Setup / Manual Setup**

- **Network Test:** You can test or confirm the network connection status after setting up the network.

- ☞ When unable to connect to an AP

Your TV may fail to locate an AP that is configured as a private SSID type. In this case, please change the AP settings and try again. If your Internet service provider has registered the MAC address of the device used to connect to the Internet for the first time and authenticates the MAC address each time you connect to the Internet, your TV may not be able to connect to the Internet as the MAC address differs from that of the device (PC).

In this case, ask your Internet service provider about the procedures to connect devices other than your PC (such as your TV) to the Internet. If you cannot connect to the Internet even if you have followed the procedures of your Internet service provider, please contact a Samsung Electronics at 1-800-SAMSUNG.

- **Select a network**

- Access Point: You can select the IP sharer to use when using a wireless network.
  - ☞ If a wireless Access Point is not in the Access Point list, press the Red button.
  - ☞ When the connection is made, you will be returned to the screen automatically.
  - ☞ If you have selected an Access Point with a security authentication:
    - The Security Key input screen appears. Enter the security key and press the Blue button on the remote control.
    - ☞ If security encryption type is WEP, 0~9, A~F will be available when you input security key.



### Connecting WPS (Wi-Fi Protected Setup)

- If **Security Key** is already set: In access point list, select **WPS**.

- ☞ You can select **PBC, PIN, Security Key**.

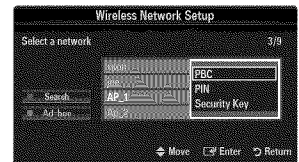

- Connecting by using **PBC**: Select a **PBC** (Push Button Configuration). Press the PBC button on the AP (access point) within 2 minutes, and wait for connection.



- Connecting by using **PIN**: Select a **PIN** (Personal Identification Number).

- ☞ The message showing the PIN Code is displayed. Input the PIN Code at AP device within 2 minutes. Select **OK** and wait for connection.

- ☞ Try again if connecting operation doesn't work

- ☞ When the connection is not established although tried again, reset the access point. Please refer to a manual of each access point.



- Connecting by using **Security Key**: When selecting **Security Key**, the input window is displayed. Input the security key and press Blue button.

- ☞ Try again if connecting operation doesn't work.



- If **Security Key** is not set: When the security setting of AP that supports WPS is NONE, you can select **PBC, PIN, None Security**. **None Security** is capable of connecting to AP directly without using WPS function.

- ☞ Process of **PBC, PIN** is same as above. Refer to if **Security Key** is already set.

- ☞ Try again if connecting operation doesn't work.

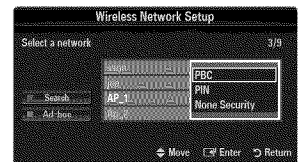

- **Ad-hoc:** You can connect to a mobile device without an access point through the 'Samsung Wireless LAN Adapter' by using a peer to peer network.

### How to connect to new Ad-hoc

1. Choose **Select a network**, then a device list is displayed.
2. While in the device list, press the Blue button on the remote or select **Ad-hoc**.
  - ☑ The message **The existing network system may have limited functionality. Do you want to change the network connection?** is displayed.
3. Input the generated **Network Name(SSID)** and **Security Key** into the device you want to connect.

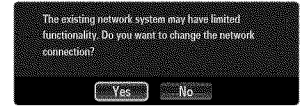

### How to connect an existing Ad-hoc device

1. Choose **Select a network**, the device list is displayed.
2. Select the device you want in the Device list.
3. If security key was applied, input the security key again.
  - ☑ If network doesn't operate normally, please check the **Network Name(SSID)** and **Security Key** again. If the **Security Key** is incorrect, it may be the reason for the malfunction.

### Wireless Network Setup-Auto Setup

If you want to connect AP, AP should support DHCP. Only devices which support Ad-hoc mode can be connected without DHCP.

1. Set **Network Type** to **Wireless**.
2. Select **Wireless Network Setup**.
3. Set **Internet Protocol Setup** to **Auto Setup**.
  - ☑ The Internet Protocol is set automatically.
4. Select a network through **Select a network**.
5. Select **Network Test** to check the network connectivity.

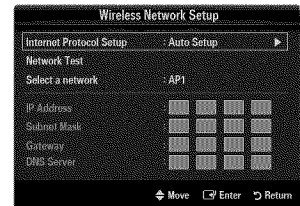

### Wireless Network Setup-Manual Setup

1. Set **Network Type** to **Wireless**.
2. Select **Wireless Network Setup**.
3. Set **Internet Protocol Setup** to **Manual Setup**.
4. Set up **IP Address**, **Subnet Mask**, **Gateway** and **DNS Server**.
  - ☑ Press the number buttons on the remote control when you set the Network manually.
5. Select a network through **Select a network**.
6. Select **Network Test** to check the network connectivity.

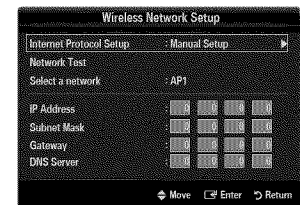

## Input Menu

### □ Source List

Use to select TV or other external input sources such as DVD / Blu-ray players / Cable Box / Satellite receivers (Set-Top Box) connected to the TV. Use to select the input source of your choice.

Press the **SOURCE** button on the remote control to view an external signal source.

### ≡ TV / AV1 / AV2 / Component1 / Component2 / PC / HDMI1/DVI / HDMI2 / HDMI3 / HDMI4 / USB

You can choose only those external devices that are connected to the TV. In the **Source List**, connected inputs will be highlighted and sorted to the top. Inputs that are not connected will be sorted to the bottom.

If USB devices are connected to the **USB1(HDD)** and **USB2** jacks, they are displayed as USB1 and USB2 in order.

PC always stays activated.

Using the color buttons on the remote with the Source list

– **Red (Refresh)**: Refreshes the connected external devices. Press this if your Source is on and connected, but does not appear in the list.

– **TOOLS (Tools)**: Displays the **Edit Name** and **Information** menus.

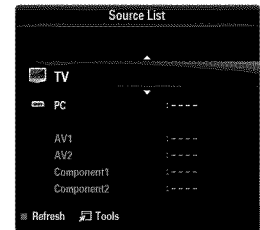

### □ Edit Name

### ≡ VCR / DVD / Cable STB / Satellite STB / PVR STB / AV Receiver / Game / Camcorder / PC / DVI / DVI PC / TV / IPTV / Blu-ray / HD DVD / DMA

Name the device connected to the input jacks to make your input source selection easier.

When a PC with a resolution of 1920 x 1080@60Hz is connected to the **HDMI IN 1(DVI)** port, you should set the **HDMI1/DVI** mode to **DVI PC** in the **Edit Name** of the **Input** mode.

## Support Menu

### □ Legal Notice

View the Legal Notice and General Disclaimer regarding Third Party Contents and Service.

The General Disclaimer may differ depending on the country.

### □ Product Guide

The Product Guide gives you information on the most important features of this TV. The descriptions provided by this function are in English and French only.

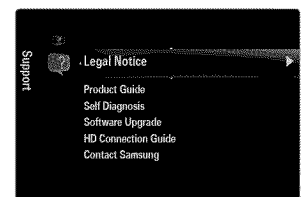
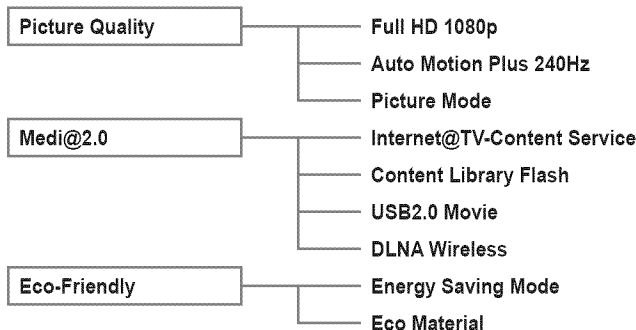

## Using the Remote Control Buttons in the Product Guide Menu

Button	Operations
Yellow Button	Shows the contents of the <b>Product Guide</b> sequentially. (Auto Play)
◀/▶	Move the cursor and select an item.
<b>ENTER</b> 	Select the currently selected item.
<b>RETURN</b>	Return to the previous menu.
<b>EXIT</b>	Stop the current function and return to the <b>Product Guide</b> main menu.

### ❑ Self Diagnosis

#### ☰ Picture Test

If you think you have a picture problem, perform the picture test. Check the color pattern on the screen to see if the problem still exists.

- **Yes:** If the test pattern does not appear or there is noise in the test pattern, select **Yes**. There may be a problem with the TV. Contact Samsung's call center for assistance.
- **No:** If the test pattern is properly displayed, select **No**. There may be a problem with your external equipment. Please check your connections. If the problem still persists, refer to the external device's user manual.

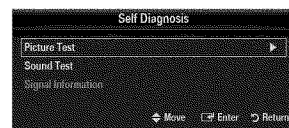

#### ☰ Sound Test

If you think you have a sound problem, please perform the sound test. You can check the sound by playing a built-in melody sound through the TV.

- ☑ If you hear no sound from the TV's speakers, before performing the sound test, make sure **Speaker Select** is set to **TV speaker** in the Sound menu.
- ☑ The melody will be heard during the test even if **Speaker Select** is set to **External Speaker** or the sound is muted by pressing the **MUTE** button.
- **Yes:** If during the sound test you can hear sound only from one speaker or not at all, select **Yes**. There may be a problem with the TV. Contact Samsung's call center for assistance.
- **No:** If you can hear sound from the speakers, select **No**. There may be a problem with your external equipment. Please check your connections. If the problem still persists, refer to the external device's user manual.

#### ☰ Signal Strength (digital channels only)

Unlike analog channels, which can vary in reception quality from 'snowy' to clear, digital (HDTV) channels have either perfect reception quality or you will not receive them at all. So, unlike analog channels, you cannot fine tune a digital channel. You can, however, adjust your antenna to improve the reception of available digital channels.

- ☑ If the signal strength meter indicates that the signal is weak, physically adjust your antenna to increase the signal strength. Continue to adjust the antenna until you find the best position with the strongest signal.

## ❑ Software Upgrade

Samsung may offer upgrades for the TV's firmware in the future. These upgrades can be performed via the TV when it is connected to the Internet, or by downloading the new firmware from [samsung.com](http://samsung.com) to a USB memory device.

- 🔗 **Current Version** is the software already installed in the TV.
- 🔗 **Alternative Software** (Backup) shows the previous version that will be replaced.
- 🔗 Software is represented as 'Year/Month/Day\_Version'. The more recent the date, the newer the software version. Installing the latest version is recommended.

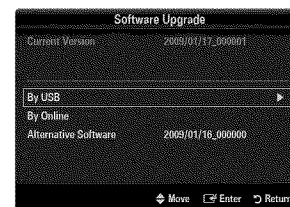
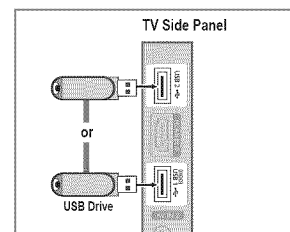

### ☰ By USB

Insert a USB drive containing the firmware upgrade downloaded from [samsung.com](http://samsung.com) into the TV. Please be careful to not disconnect the power or remove the USB drive while upgrades are being applied. The TV will turn off and turn on automatically after completing the firmware upgrade. Please check the firmware version after the upgrades are complete (the new version will have a higher number than the older version).

When software is upgraded, video and audio settings you have made will return to their default (factory) settings. We recommend you write down your settings so that you can easily reset them after the upgrade.

### ☰ By Online

Upgrades the software using the Internet.

- 🔗 First, configure your network. For detailed procedures on using the Network Setup, refer to the 'Setting the Network' instructions. (see pages 30~35)
- 🔗 If the internet connection doesn't operate properly, connection can be broken. please retry downloading. If the problem still happens, download by USB and upgrade.

### ☰ Alternative Software (Backup)

If there is an issue with the new firmware and it is affecting operation, you can change the software to the previous version.

- 🔗 If software was changed, existing software is displayed.
- 🔗 You can change current software to alternative software by '**Alternative Software**'.

## ❑ HD Connection Guide

This menu presents the connection method that provides the optimal quality for the HDTV. Refer to this information when connecting external devices to the TV.

## ❑ Contact Samsung

View this information when your TV does not work properly or when you want to upgrade the software. You can view the information regarding the call center, product and software file download method.





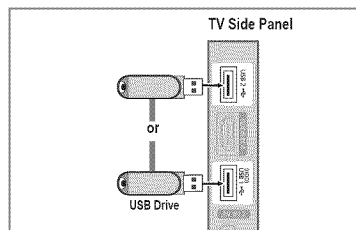

# MEDIA PLAY (USB & DLNA)

## Connecting a USB Device

1. Press the **POWER** button to turn the TV on.
2. Connect a USB device containing photo, music and/or movie files to the **USB1(HDD)** or **USB2** jack on the side of the TV.
3. When the **Application** selection screen is displayed, press the **ENTER**  button to select **Media Play (USB & DLNA)**.
  - ⓧ MTP (Media Transfer Protocol) is not supported.
  - ⓧ The file system supports FAT16, FAT32 and NTFS.
  - ⓧ Certain types of USB Digital camera and audio devices may not be compatible with this TV.
  - ⓧ **Media Play** only supports USB Mass Storage Class devices (MSC). MSC is a Mass Storage Class Bulk-Only Transport device. Examples of MSC are Thumb drives, Flash Card Readers and USB HDD (USB HUB are not supported.).
  - ⓧ Please connect directly to the USB port of your TV. If you are using a separate cable connection, there may be a USB compatibility problem.
  - ⓧ Before connecting your device to the TV, please back up your files to prevent them from damage or loss of data. SAMSUNG is not responsible for any data file damage or data loss.
  - ⓧ Connect a USB HDD to the dedicated **USB1(HDD)** port. Warning: Do not exceed 1.5 amperes.
  - ⓧ Do not disconnect the USB device while it is loading.
  - ⓧ MSC supports MP3, JPEG and movie files, while a PTP device supports JPEG files only.
  - ⓧ The higher the resolution of the image, the longer it takes to display on the screen.
  - ⓧ The maximum supported JPEG resolution is 15360X8640 pixels.
  - ⓧ For unsupported or corrupted files, the 'Not Supported File Format' message is displayed.
  - ⓧ If sort key is set to Basic View, up to 1000 files can be displayed in each folder. The other sort key can display up to 10000 files.
  - ⓧ MP3 files with DRM that have been downloaded from a non-free site cannot be played. Digital Rights Management (DRM) is a technology that supports the creation of content, the distribution and management of the content in an integrated and comprehensive way, including the protection of the rights and interests of the content providers, the prevention of the illegal copying of contents, as well as managing billings and settlements.
  - ⓧ When moving to a photo, loading may take a few seconds. At this point, the loading icon will appear at the screen.
  - ⓧ If more than 2 PTP devices are connected, you can only use one at a time.
  - ⓧ If more than one MSC device is connected, some of them may not be recognized. If a device requires high power (more than 500mA or 5V), the USB device may not be supported.
  - ⓧ If an over-power (Fail add new device USB1/USB2 Power Overload) warning message is displayed while you are connecting or using a USB device, the device may not be recognized or may malfunction.



## Using the Remote Control Button in Media Play Menu

Button	Operations
▲/▼/◀/▶	Move the cursor and select an item.
ENTER 	Select the currently selected item. While playing a slide show, movie, or music file: - Pressing the <b>ENTER</b>  button during play pauses the play. - Pressing the <b>ENTER</b>  button during pause resumes the play.
	Play or pause the Slide Show, music or movie.
RETURN	Return to the previous menu.
TOOLS	Run various functions from the Photo, Music and Movie menus.
	Stop the current slide show, Music or Movie file.
◀◀/▶▶	Jump to previous group/Jump to next group.
INFO	Show file information.
MEDIA.P	Exit <b>Media Play</b> mode.
▼ CH ▲, EXIT, TV	Stop <b>Media Play</b> mode and Returns to TV mode.

## Media Play Function

This function enables you to view and listen to photo, music and/or movie files saved on a USB Mass Storage Class (MSC) device.

### Entering the Media Play (USB & DLNA) Menu

1. Press the **MENU** button. Press the ▲ or ▼ button to select **Application**, then press the **ENTER**  button.

2. Press the ▲ or ▼ button to select **Media Play (USB & DLNA)**, then press the **ENTER**  button.

 The **Media Play (USB & DLNA)** menu is displayed.



3. Press the **MEDIA.P** button on the remote control to display the **Media Play** menu.

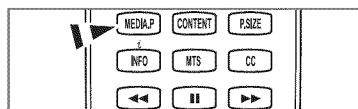

4. Press the **SOURCE** button on the remote control to view the source list. Then Press the ▲ or ▼ button to select **USB**.

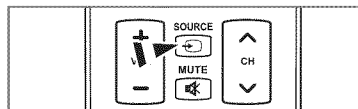

3. Press the Red button, then press the ▲ or ▼ button to select the TV memory or USB Memory. Press the **ENTER**  button.

 This function differs depending on the TV Memory / USB Memory Device / DLNA device.

 The selected USB device name appears at the bottom left of the screen.

4. Press the ◀ or ▶ button to select an icon (**Photo, Music, Movie, Setup**), then press the **ENTER**  button.

 To exit **Media Play** mode, press the **MEDIA.P** button on the remote control.

## Removing a USB Memory Device Safely

You can remove the device safely from the TV.

1. Press the **TOOLS** button in the Media Play file list screen, or while a Slide Show, music or movie is being played.
2. Press the **▲** or **▼** button to select **Safe Remove**, then press the **ENTER**  button.
3. Remove the USB device from the TV.

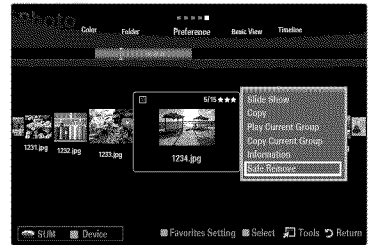

## Screen Display

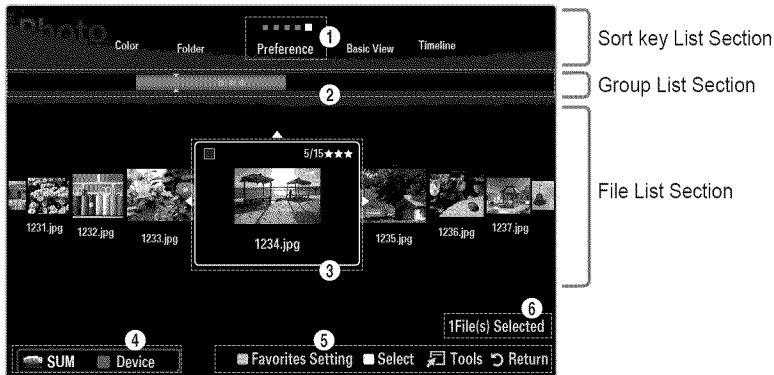







Move to either 'Sort key List Section', 'Group List Section' or 'File List Section' using the Up and Down buttons. After selecting a section, press the **◀** or **▶** buttons to select an item.

- 1 Current Sort key: This field shows the current standard for sorting files. Press the **◀** or **▶** button to change the standard for sorting files.
- 2 View Groups: Shows the detailed groups of the files sorted according to the selected Sort key. The sort group where the currently selected file is contained is highlighted.
- 3 Currently selected file: The selected file is the file you can now control. Photo and movie files are displayed as thumbnail images.
- 4 Current Device: Shows the currently selected device name. Press the Red button to select a device.
  - Red (**Device**) button: Selects a connected device.
- 5 Help Items
  - Green (**Favorites Setting**) button: Changes the Favorites Setting for the selected file. Press this button repeatedly until the desired value appears.
  - Yellow (**Select**) button: Selects file from the file list. Selected files are marked with a symbol . Press the Yellow button again to cancel a file selection.
  - **TOOLS (Tools)** button: Displays the option menus. (The option menu changes according to the current status.)
- 6 Item Selection Information: Shows the number of files that are selected by pressing the Yellow button.

## Sorting the Photo List

You can sort photos in the Photo List by a particular standard.

1. Press the **MEDIA.P** button.
2. Press the ◀ or ▶ button to select **Photo**, then press the **ENTER**  button.
3. Press the ▲ button to move to the Sort key Section.
4. Press the ◀ or ▶ button to select a sorting standard. (**Basic View**, **Timeline**, **Color**, **Folder**, **Preference**)
  -  The photos are sorted according to the newly selected sorting standard.
5. Press the ▼ button to move to the File List Section. Press the ▶ (Play)/ **ENTER**  button to start the Slide Show in the order you selected.
  -  To move to the previous/next group, press the ◀◀ (REW) or ▶▶ (FF) button.
  -  Photo information is automatically set. The Color information extracted from a photo file may be different from your expectations. You can change the Color and preference.
  -  PTP does not support folder sort mode.

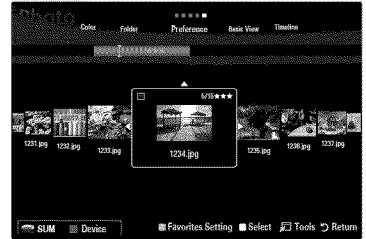

### **Basic View**

Shows the folders on the USB memory device. If you select a folder and press the **ENTER**  button, only the photo files contained in the selected folder are displayed.

 When sorted according to the **Basic View**, you cannot set Favorite files.

### **Timeline**

Sorts photos by date. It sorts by year and month from the earliest photo.

### **Color** → **Red / Yellow / Green / Blue / Magenta / Black / Gray / Unclassified**

Sorts photos by Color. You can change the photo Color information.

 You should set the **Use Color View** to on in the **Setup** menu before sorting photos by Color.

### **Folder**

Sorts photos by folder. If there are many folders in USB, the photos files are shown in order in each folder. The photo file in the Root folder is shown first and the others are shown in alphabetical order by name.

### **Preference** → ☆☆☆ / ☆☆☆ / ☆☆☆ / ☆☆☆

Sorts photos by preference (Favorite). You can change the photo preferences.



 Changing the Favorites Setting

Select the desired photo in the File List Section, then press the Green button repeatedly until the desired setting appears.

 Up to 3 stars can be selected.

 The stars are for grouping purposes only. For example, the 3 star setting does not have any priority over the one star setting.

## Photo List Option Menu

1. Press the **MEDIA.P** button.
2. Press the ◀ or ▶ button to select **Photo**, then press the **ENTER**  button.
3. Press the ◀ or ▶ button to select the desired photo file.
  -  **Selecting Multiple Photos**
    - Press the ◀ or ▶ button to select the desired photo file. Then press the Yellow button.
    - Repeat the above operation to select multiple photo files.
    - The mark ✓ appears to the selected photo file.
4. Press the **TOOLS** button.
  -  The option menu changes according to the current status.

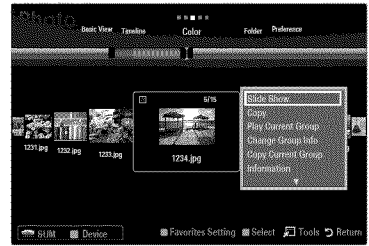



### Slide Show

Using this menu, you can play a SlideShow using the photo files on the USB memory device.



### Copy / Copy Current Group / Copy the selected file (When multiple files are selected)

Select a photo you want to copy. (Alternatively, select multiple files by pressing the Yellow button.) Press the **TOOLS** button to select **Copy** (or **Copy Current Group / Copy the selected file**). The files on the USB device are saved to the TV memory.

-  You can only copy the files saved on the USB device.
-  When the TV memory is full, files cannot be copied.

### Delete / Delete All / Delete Selected File (When multiple files are selected)

Select a photo to delete. (Alternatively, select multiple files by pressing the Yellow button.) Press the **TOOLS** button to select **Delete** (or **Delete All / Delete Selected File**). The files are deleted.



-  You can only delete the files saved in the TV memory.
-  You cannot recover a deleted file.

### Play Current Group

Using this menu, you can play a SlideShow using only the photo files in the currently selected sorting group.

### Change Group Info (When the Sort key is the Color)

You can change a selected photo file's (or group of files) Color information in order to move it from one Color group to another.

-  This does not change the actual Color of the photo.
-  The group information of the current file is updated and the photos are moved to the new Color group.
-  To change the information of multiple files, select the files you want by pressing the Yellow button.



### Deselect All (When at least one file is selected)

You can deselect all files.

-  The ✓ mark indicating the corresponding file is selected is hidden.

### Information

The photo file information including the name, the size, the resolution, the date modified and the path is displayed.

-  You can view the information of photo files during a SlideShow using the same procedures.
-  Press the **INFO** button to viewing the information.

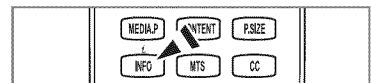

### Safe Remove

You can remove the device safely from the TV.

## Viewing a Photo or Slide Show

### Viewing a Slide Show

1. Press the ▼ button to select the File List Section.
2. Press the **TOOLS** button.
3. Press the ▲ or ▼ button to select **Slide Show**, then press the **ENTER** button.
  - ☑ All files in the File List Section will be used for the Slide Show.

- ☑ During the slide show, files are displayed in order from the currently shown file.
- ☑ The Slide Show progresses in the order sorted in the File List Section.
- ☑ Music files can be automatically played during the Slide Show if the **Background Music** is set to **On**.
- ☑ While a photo list is displayed, press the ▶(Play)/**ENTER** button on the remote control to start slide show.

#### ☑ SlideShow Control Buttons

Button	Operations
<b>ENTER</b> button	Play/Pause the Slide Show.
▶	Play the Slide Show.
⏸	Pause the Slide Show.
■	Exit Slide Show and return to the photo list.
⏮/⏭	Change the SlideShow playing speed.
<b>TOOLS</b>	Run various functions from the Photo menus.

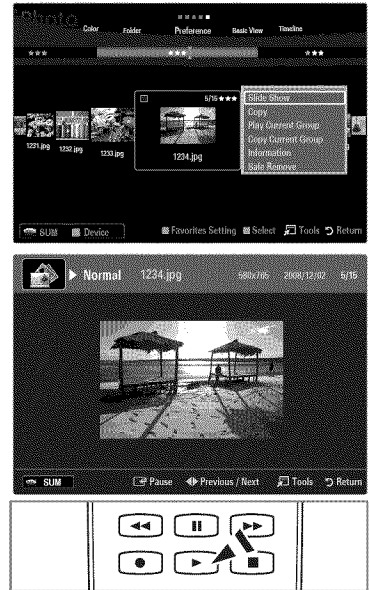

### Playing current group

1. Press the ▲ button to move to the Sort key Section.
2. Press the ◀ or ▶ button to select a sorting standard.
3. Press the ▼ button to move to the Group List Section.
4. Select a group using the ◀ and ▶ buttons.
5. Press the ▶ (Play) button. A slideshow begins with the files of the selected group.

#### ● Alternatively

1. Select a Sort key and then in the File List Section, select the photos contained in the desired group.
  - ☑ To move to the previous/next group, press the ⏮ (REW) or ⏭ (FF) button.
2. Press the **TOOLS** button.
3. Press the ▲ or ▼ button to select **Play Current Group**, then press the **ENTER** button.
  - ☑ Only the photos in the sorting group including the selected files will be used for the Slide Show.



## To perform a Slide Show with only the selected files

1. Press the ▼ button to select the File List Section.
2. Press the ◀ or ▶ button to select the desired photo in the File List Section.
3. Press the Yellow button.
4. Repeat the above operation to select multiple photos.
  - ☑ The ✓ mark appears to the left of the selected photo.
  - ☑ If you select one file, the Slide Show will not be performed.
  - ☑ To deselect all selected files, press the **TOOLS** button and select **Deselect All**.
5. Press the ▶ (Play)/ENTER button.
  - ☑ The selected files will be used for the Slide Show.

### • Alternatively

1. In the File List Section, press the Yellow button to select the desired photos.
2. Press the **TOOLS** button.
3. Press the ▲ or ▼ button to select **Slide Show**, then press the ENTER button.
  - ☑ The selected files will be used for the Slide Show.

## Slide Show Option Menu

1. During a slide show (or when viewing a photo), press the **TOOLS** button to set the option.
2. Press the ▲ or ▼ button to select the desired option, then press the ENTER button.

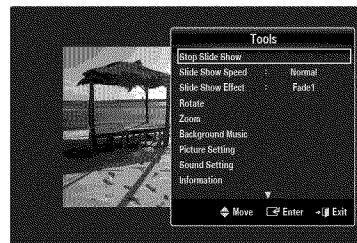

### □ Stop Slide Show / Start Slide Show

You can start or stop a SlideShow.

### □ Slide Show Speed → Slow / Normal / Fast

You can select the slide show speed.

- ☑ This function is available only during a slide show.
- ☑ You can also change the speed of the Slide Show by pressing the ◀ (REW) or ▶ (FF) button during the Slide Show.

### □ Slide Show Effect

You can select the screen transition effect used in the slideshow.

### ☰ None / Fade1 / Fade2 / Blind / Spiral / Checker / Linear / Stairs / Wipe / Random

- ☑ This function is available only during a slide show.

### □ Rotate

You can rotate photos saved on a USB memory device.

- ☑ Whenever you press the ◀ button, it rotates by 270°, 180°, 90°, and 0°.
- ☑ Whenever you press the ▶ button, it rotates by 90°, 180°, 270°, and 0°.
- ☑ The rotated file is not saved.

## □ Zoom

You can magnify photos saved on a USB memory device. (x1 → x2 → x4)

- ☑ To move the enlarged photo image, press the **ENTER**  button, then press the **▲/▼/◀/▶** buttons. Note that when the enlarged picture is smaller than the original screen size, the location change function doesn't work.
- ☑ The enlarged file is not saved.

## □ Background Music

You can select background music when watching a Slide Show.

- ☑ To use this feature, there must be music and photo files stored on the USB device.
- ☑ Loading music files is needed to change BGM mode. Play music files in music category to load.

### ☰ Background Music → Off / On

- **Off**: Background music is not played.
- **On**: When the background music is available, if you select **On**, the music is played back.

### ☰ BGM Mode → Mood / Selected File / Shuffle

You can select a mode to use for the background music.

### ☰ BGM Mood → Energetic / Rhythmical / Sad / Exciting / Calm / Unclassified

Music with the mood you selected is set as the background music.

- ☑ If you set **BGM Mode** to **Mood**, you can select a mood.

### ☰ Select Music File (0 File(s) Selected)

Only the selected music file is set as the background music.

- ☑ If you set **BGM Mode** to **Selected File**, you can select a music file.

## □ Picture Setting / Sound Setting

You can select the picture and sound settings.

## □ Information

The photo file information is displayed.







## □ Safe Remove

You can remove the device safely from the TV.



## Sorting the Music List

You can sort music files in the Music List by a particular standard.

1. Press the **MEDIA.P** button.
2. Press the ◀ or ▶ button to select **Music**, then press the **ENTER**  button.
3. Press the ▲ button to move to the Sort key Section.
4. Press the ◀ or ▶ button to select a sorting standard. (**Basic View**, **Title**, **Artist**, **Mood**, **Genre**, **Folder**, **Preference**)
  -  The Music files are sorted according to the newly selected sorting standard.
5. Press the ▼ button to move to the File List Section. Press the ▶ (Play)/ **ENTER**  button to start playing music in the order selected by the user.
  -  To move to the previous/next group, press the ◀◀ (REW) or ▶▶ (FF) button.
  -  Music information is automatically set. The mood information extracted from a music file may differ from the expectations of the user. You can change the mood and preference.
  -  If there is no title information for a music file, the filename is displayed.
  -  If no information is available for the Artist, Album, Year, or Genre the corresponding item is displayed as blank.

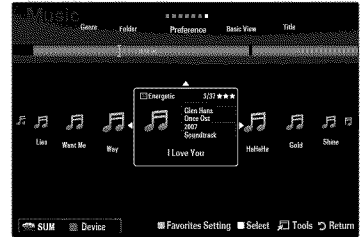

### **Basic View**

Shows the folders of the USB memory device. If you select a folder and press the **ENTER**  button, only the music files contained in the selected folder are displayed.

 When sorted according to the **Basic View**, you cannot set Favorite files.

### **Title**

Sorts the music titles in symbol/number/alphabet/special order, and shows the music file.

### **Artist**

Sorts the music file by artist in symbol/number/alphabet/special order.

### **Mood** → **Energetic / Rhythmical / Sad / Exciting / Calm / Unclassified**

Sorts music files by the mood. You can change the music mood information.

### **Genre**



Sorts music files by the genre.

### **Folder**

Sorts music files by the folder. If there are many folders in USB, the files are shown in order in each folder. The music file in the Root folder is shown first and the others are shown in alphabetical order by name.

### **Preference** → ☆☆☆ / ☆☆☆ / ☆☆☆ / ☆☆☆

Sorts music files by preference (Favorite). You can change the music files preferences.

-  Changing the Favorites Setting  
Select the desired music file in the File List Section, then press the Green button repeatedly until the desired setting appears.
-  Up to 3 stars can be selected.
-  The stars are for grouping purposes only. For example, the 3 star setting does not have any priority over the one star setting.

## Music List Option Menu

1. Press the **MEDIA.P** button.
2. Press the ◀ or ▶ button to select **Music**, then press the **ENTER** button.
3. Press the ◀ or ▶ button to select the desired Music file.
  - ☑ **Selecting Multiple Music Files**
    - Press the ◀ or ▶ button to select the desired music file. Then press the Yellow button.
    - Repeat the above operation to select multiple music files.
    - The mark ✓ appears to the selected music file.
4. Press the **TOOLS** button.
  - ☑ The option menu changes according to the current status.

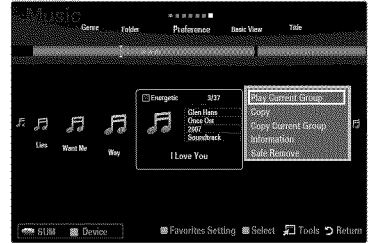

### ☐ **Play Current Group**

Using this menu, you can only play music files in the currently selected sorting group.

### ☐ **Copy / Copy Current Group / Copy the selected file (When multiple files are selected)**

Select the music to copy. (Alternatively, select multiple files by pressing the Yellow button.) Press the **TOOLS** button to select **Copy** (or **Copy Current Group / Copy the selected file**). The files on the USB device are saved to the TV memory.

- ☑ You can only copy the files saved on the USB device.
- ☑ When the TV memory is full, files cannot be copied.

### ☐ **Delete / Delete All / Delete Selected File (When multiple files are selected)**

Select the file to delete. (Alternatively, select multiple files by pressing the Yellow button.) Press the **TOOLS** button to select **Delete** (or **Delete All / Delete Selected File**). The files are deleted.

- ☑ You can only delete the files saved in the TV memory.
- ☑ You cannot recover a deleted file.

### ☐ **Change Group Info (When the Sort key is Mood)**

You can change the mood information of music files.

The group information of the current file is updated and the file is moved to the new group.

- ☑ To change the information of multiple files, select files by pressing the Yellow button.

### ☐ **Deselect All (When at least one file is selected)**

You can deselect all files.

- ☑ The ✓ mark indicating the corresponding file is selected is hidden.

### ☐ **Information**

The music file information including the name, the size, the date modified and the path is displayed.

- ☑ You can view the music file information during **Play Current Group** using the same procedures.
- ☑ Press the **INFO** button to viewing the information.

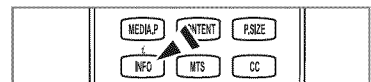







### ☐ **Safe Remove**

You can remove the device safely from the TV.

## Playing Music

### Playing a music file

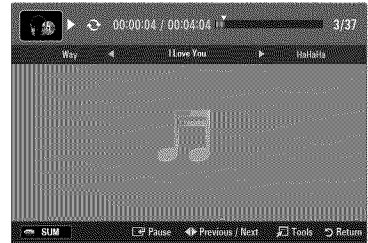

1. Press the **▼** button to select the File List Section.
2. Press the **◀** or **▶** button to select a music file to be played.
3. Press the **▶** (Play)/**ENTER**  button.
  -  This menu only shows files with the MP3 file extension. Files with other file extensions are not displayed, even if they are saved on the same USB device.
  -  The selected file is displayed at the top with its playing time.
  -  To adjust the music volume, press the volume button on the remote control. To mute the sound, press the **MUTE** button on the remote control.
  -  If the sound is odd when playing MP3 files, adjust the **Equalizer** and **SRS TruSurround HD** in the Sound menu. (An over-modulated MP3 file may cause a sound problem.)
  -  The playing duration of a music file may be displayed as '00:00:00' if its playing time information is not found at the start of the file.
  -  **◀◀** (REW) or **▶▶** (FF) buttons do not function during play.







#### Music Play Control Buttons

Button	Operations
<b>ENTER</b> 	Play/Pause the music file.
<b>▶</b>	Play the music file
<b>⏸</b>	Pause the music file
<b>■</b>	Exit play mode and return to the music list.
<b>TOOLS</b>	Run various functions from the Music menus.





#### Music function information icon

	When all music files in the folder (or the selected file) are repeated. <b>Repeat Mode is On.</b>
	When all music files in the folder (or the selected file) are played once. <b>Repeat Mode is Off.</b>

### Playing the music group

1. Press the **▲** button to move to the Sort key Section.
  2. Press the **◀** or **▶** button to select a sorting standard.
  3. Press the **▼** or **ENTER**  button to move to the Group List Section.
  4. Press the **▶** (Play) button. The files of the selected group will start playing.
- **Alternatively**
    1. Select a sort key and then in the File List Section, select the files contained in the desired group.
      -  To move to the previous/next group, press the **◀◀** (REW) or **▶▶** (FF) button.
    2. Press the **TOOLS** button.
    3. Press the **▲** or **▼** button to select **Play Current Group**, then press the **ENTER**  button.
      -  The music files in the sorting group including the selected file are played.

### Playing the selected music files

1. Press the **▼** button to select the File List Section.
2. Press the **◀** or **▶** button to select the desired music file.
3. Press the Yellow button.
4. Repeat the above operation to select multiple music files.
  -  The **✓** appears to the left of the selected music file.
  -  To deselect all selected files, press the **TOOLS** button and select **Deselect All**.
5. Press the **▶** (Play)/**ENTER**  button.
  -  The selected files will be played.

## Music Play option Menu









### Music Play Option Menu

- Repeat Mode** → On / Off  
You can play music files repeatedly.
- Picture Setting / Sound Setting**  
You can configure the picture and sound settings.
- Information**  
The music file information is displayed.
- Safe Remove**  
You can remove the device safely from the TV.



### Sorting the Movie List

You can sort movies in the Movie List by a particular standard.

1. Press the **MEDIA.P** button.
  2. Press the ◀ or ▶ button to select **Movie**, then press the **ENTER**  button.
  3. Press the ▲ button to move to the Sort key Section.
  4. Press the ◀ or ▶ button to select a sorting standard. (**Basic View, Timeline, Title, Folder, Preference**)
    -  The movie files are sorted according to the newly selected sorting standard.
  5. Press the ▶ (Play)/**ENTER**  button to play the movie in the order selected.
    -  Movie information is automatically set. You can change the preference.
- Basic View**  
Shows the folders of the USB memory device. If you select a folder and press the **ENTER**  button, only the movie files contained in the selected folder are displayed.
    -  When sorted according to the **Basic View**, you cannot set Favorite files.
  - Timeline**  
Sorts movies by date. It sorts by year and month from the earliest movie.
  - Title**  
Sorts and displays the movie titles in symbol/number/alphabet/special order.
  - Folder**  
If there are many folders in USB, the movies files are shown in order in each folder. The movie file in the Root folder is shown first and the others are shown in alphabetical order by name.
  - Preference** → ☆☆☆ / ☆☆☆ / ☆☆☆ / ☆☆☆  
Sorts movies by preference. (Favorite) You can change the movie preferences.
    -  Changing the Favorites Setting  
Select the desired movie file in the File List Section, then press the Green button repeatedly until the desired setting appears.
    -  Up to 3 stars can be selected.
    -  The stars are for grouping purposes only. For example, the 3 star setting does not have any priority over the one star setting.

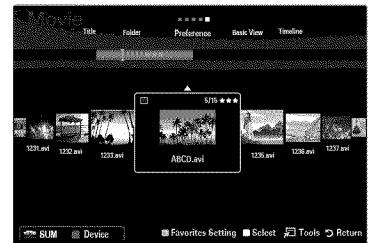

## Movie List Option Menu

1. Press the **MEDIA.P** button.
2. Press the ◀ or ▶ button to select **Movie**, then press the **ENTER** button.
3. Press the ◀ or ▶ button to select the desired Movie file.
  - Selecting Multiple Movie Files**
    - Press the ◀ or ▶ button to select the desired movie file. Then press the Yellow button.
    - Repeat the above operation to select multiple movie files.
    - The mark ✓ appears to the selected movie file.
4. Press the **TOOLS** button.
  - The option menu changes according to the current status.

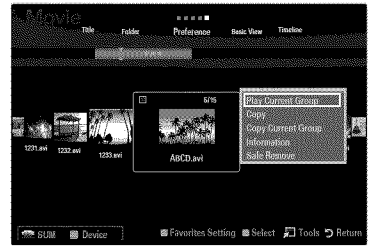

### **Play Current Group**

Using this menu, you can only play movie files in the currently selected sorting group.

### **Copy / Copy Current Group / Copy the selected file (When multiple files are selected)**

Select the movie to copy. (Alternatively, select multiple files by pressing the Yellow button.) Press the **TOOLS** button to select **Copy** (or **Copy Current Group / Copy the selected file**). The files on the USB device are saved to the TV memory.

- You can only copy the files saved on the USB device.
- When the TV memory is full, files cannot be copied.

### **Delete / Delete All / Delete Selected File (When multiple files are selected)**

Select the file to delete. (Alternatively, select multiple files by pressing the Yellow button.) Press the **TOOLS** button to select **Delete** (or **Delete All / Delete Selected File**). The files are deleted.

- You can only delete the files saved in the TV memory.
- You cannot recover a deleted file.

### **Deselect All (When at least one file is selected)**

You can deselect all files.

- The ✓ mark indicating the corresponding file is selected is hidden.

### **Information**

The movie file information including the name, the size, the date modified and the path is displayed.

- Press the **INFO** button to viewing the information.

### **Safe Remove**

You can remove the device safely from the TV.

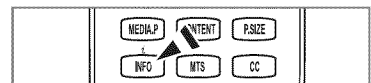

## Playing a Movie File

### Playing a movie file

1. Press the ▼ button to select the File List Section.
2. Pressing the ◀ or ▶ button to select a movie file to be played.
3. Press the ▶ (Play)/**ENTER** button.
  - The selected file is played.
  - The selected file is displayed at the top with its playing time.
  - The playing duration of a movie file may be displayed as '00:00:00' if its playing time information is not found at the start of the file.
  - You can watch exciting gaming multimedia files, but the gaming function is not supported.









☑ **Supported Subtitle Formats**

Name	File extension	Format
MPEG-4 time-based text	.txt	XML
SAMI	.smi	HTML
SubRip	.srt	string-based
SubViewer	.sub	string-based
Micro DVD	.sub or .txt	string-based







☑ **Supported Movie Formats**

File extension	Container	Video Decoder	Audio codec	Resolution
*.avi	AVI	Divx 3.11 / 4.x / 5.1 / 6.0	MP3 AC3 LPCM ADPCM	720x576
		XviD		1920x1080
		H.264 BP / MP / HP		1920x1080
		MPEG4 SP / ASP		1920x1080
		Motion JPEG		800x600
*.mkv	MKV	Divx 3.11 / 4.x / 5.1 / 6.0	MP3 AC3 LPCM ADPCM	720x576
		XviD		1920x1080
		H.264 BP / MP / HP		1920x1080
		MPEG4 SP / ASP		1920x1080
		Motion JPEG		800x600
*.asf	ASF	Divx 3.11 / 4.x / 5.1 / 6.0	MP3 AC3 LPCM ADPCM WMA	720x576
		XviD		1920x1080
		H.264 BP / MP / HP		1920x1080
		MPEG4 SP / ASP		1920x1080
		Motion JPEG		800x600
*.wmv	ASF	VC1	WMA	1920x1080
*.mp4	MP4 (SMP4)	H.264 BP / MP / HP	MP3 ADPCM AAC	1920x1080
		MPEG4 SP / ASP		1920x1080
		XVID		1920x1080
*.3gp	3GPP	H.264 BP / MP / HP	ADPCM AAC	1920x1080
		MPEG4 SP / ASP		1920x1080
*.vro	VRO VOB	MPEG2	AC3 MPEG LPCM	1920x1080
		MPEG1		1920x1080
*.mpg *.mpeg	PS	MPEG1	AC3 MPEG PCM	1920x1080
		MPEG2		1920x1080
*.ts *.tp *.trp	TS	MPEG2	AAC MP3	1920x1080
		H.264		1920x1080
		VC1		1920x1080







## Video Play Control Buttons

Button	Operations
<b>ENTER</b> 	Play/Pause the movie file
	Play the movie file
	Pause the movie file
<b>TOOLS</b>	Run various functions from the Movie menus.
	Exit play mode and return to the movie list.
	Skip forwards or backwards through the movie file.
	Move to the first/last of the file.
	Play the file at double speed. This function may not be supported depending on the movie file.









### Playing the movie group

1. Press the  button to move to the Sort key Section.
2. Press the  or  button to select a sorting standard.
3. Press the  or **ENTER**  button to move to the Group List Section.
4. Press the  (Play) button. Only the files of the selected group will start playing.

#### • **Alternatively**







1. Select a Sort key and then in the File List Section, select the files contained in the desired group.
  -  To move to the previous/next group, press the  (REW) or  (FF) button.
2. Press the **TOOLS** button.
3. Press the  or  button to select **Play Current Group**, then press the **ENTER**  button.
  -  The movie files in the sorting group including the selected file are played.

### Playing the selected movie files

1. Press the  button to select the File List Section.
2. Press the  or  button to select the desired movie file.
3. Press the Yellow button.
  -  The  mark appears to the left of the selected movie file.
  -  To deselect all selected files, press the **TOOLS** button and select **Deselect All**.
4. Repeat the above operation to select multiple movie files.
5. Press the  (Play)/**ENTER**  button.
  -  Only the selected file is played.

### Playing movie continuously (Resume Play)

If you exit the playing movie function, the movie can be played later from the point where it was stopped.

1. Select the movie file you want to play continuously by pressing the  or  button to select it from the File List Section.
2. Press the  (Play)/**ENTER**  button.
3. Select **Play Continuously** (Resume Play) by pressing the Blue button.
  -  The Movie will begin to play from where it was stopped.
  -  If **Continuous Movie Play Help** function is set **On** in the **Setup** menu, a pop-up message will appear when you resume play a movie file.

## Movie Play Option Menu

### Movie Play Option Menu

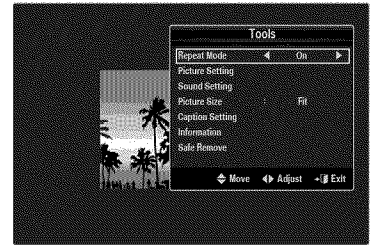

- ❑ **Repeat Mode → On / Off**  
You can play movie files repeatedly.
- ❑ **Picture Setting / Sound Setting**  
You can configure the picture and sound settings.
- ❑ **Picture Size**
  - ☰ **Fit**  
Play video at the TV screen size.
  - ☰ **Original**  
Play video at the original size.
- ❑ **Caption Setting**  
You can set the captions for the movie.
  - ☰ **Caption → On / Off**  
You can turn the captions for the movie on or off.
  - ☰ **Caption Size → Small / Standard / Large**  
You can change the font size of the captions.
  - ☰ **Caption Sync**  
You can adjust the caption sync.
  - ☰ **Caption Sync Reset**  
You can reset the adjusted caption sync.
- ❑ **Information**  
The movie file information is displayed.
- ❑ **Safe Remove**  
You can remove the device safely from the TV.





## Using the Setup Menu

Setup displays the user settings of the **Media Play** menu.

1. Press the **MEDIA.P** button.
2. Press the ◀ or ▶ button to select **Setup**, then press the **ENTER**  button.
3. Press the ▲ or ▼ button to select the desired option.
4. Press the ◀ or ▶ button to select the desired option.  
 To exit **Media Play** mode, press the **MEDIA.P** button on the remote control.

### ■ **Use Color View → On / Off**

You can select sorting photos by Color. If this option is set to On, the loading time may be increased to collect Color information from the photos.

### ■ **Continuous Movie Play Help → On / Off**

Select to display the help pop-up message for continuous movie playback.

### ■ **Get DivX® VOD registration code**

Shows the registration code authorized for the TV. If you connect to the DivX web site and register the registration code with a personal account, you can download the VOD registration file.

If you play the VOD registration using Media Play, the registration is completed.

 For more information on DivX® VOD, visit [www.DivX.com](http://www.DivX.com).

### ■ **Get DivX® VOD deactivation code**

When DivX® VOD is not registered, the registration deactivation code is displayed.

If you execute this function when DivX® VOD is registered, the current DivX® VOD registration is deactivated.

### ■ **Screen Saver Run Time → 4 hours / 8 hours / 10 hours**

Select to set the waiting time before the screen saver appears.

### ■ **Information**

Select to viewing the information of the connected device.

### ■ **Safe Remove**

You can remove the device safely from the TV.

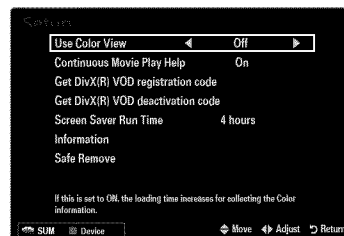

# MEDIA PLAY-DLNA

## Setting the DLNA Network

DLNA allows you to watch pictures, musics and videos saved on your PC or on your TV through a network connection in Media Play mode. This removes the need to copy them to a USB storage device and then connect the device to your TV. To use DLNA, the TV must be connected to the network and the DLNA application must be installed on your PC.

### Network Connection Diagram-Cable

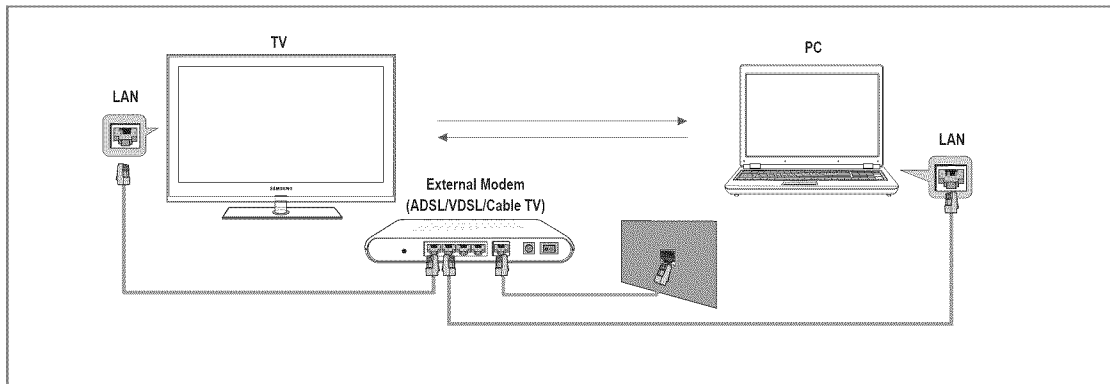

### Network Connection Diagram-Wireless

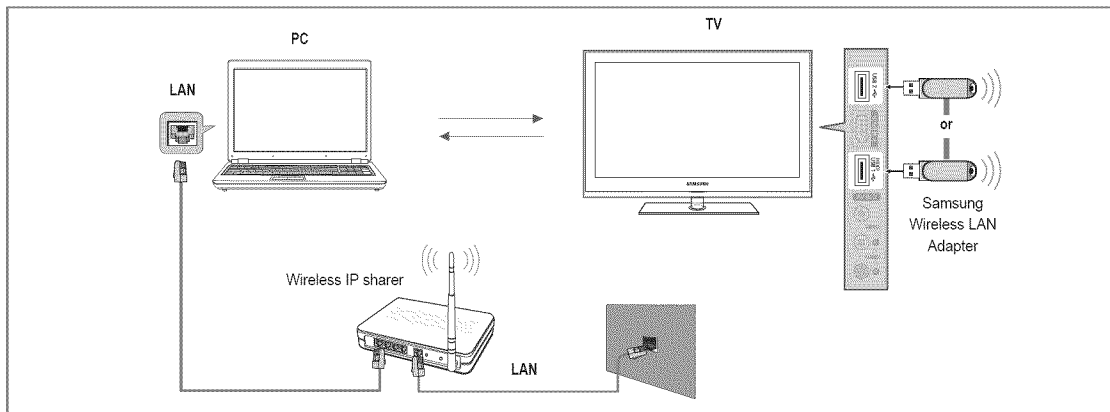

1. For more information on how to configure your network, refer to 'Setting the Network'. (see pages 30~35)
  - ☑ You are recommended to locate both TV and PC in same subnet. The first 3 parts of the subnet address of the TV and the PC IP addresses should be the same and only the last part (the host address) should be changed. (e.g. IP Address: 123.456.789.\*\*)
2. Connect the PC to which the **Samsung PC Share Manager** program will be installed and the external modem using a LAN cable.
  - ☑ You can connect the TV to the PC directly without connecting it through a Sharer (Router).

## Installing the DLNA Application

To play content on the PC on the TV, you have to first install the application. To use the DLNA function smoothly, use the program in the CD-ROM supplied with the TV or use the Samsung PC Share Manager program corresponding to the TV model that can be downloaded from the Samsung web site.

### System Requirements

1. Insert the Program CD supplied with this TV into your PC.
2. 30MB of free hard disk space is needed for the program installation.
  - ☞ If you share files, up to 30MB of hard disk drive space is required for each 100 files.
  - ☞ If you cancel file sharing, the hard disk drive space used for the thumbnail information is also freed.

### Supported Formats

- Image: JPEG/ Audio: MP3/ Video: AVI, MKV, ASF, MP4, 3GPP, PS, TS container. For detailed supported video formats, refer to the 'Playing a Movie File' instructions. (see page 52)

### Install the application



1. Run the Setup.exe file on the Program CD supplied with the product.
  - ☞ Alternatively, you can download the file from [www.samsung.com](http://www.samsung.com).
2. Install the SAMSUNG PC Share Manager as shown in the figures.
3. When the installation is complete, the PC Share Manager icon appears on your Desktop.
  - ☞ Double-click the icon to run the program.

## Using the DLNA Application

### The Program Screen Layout

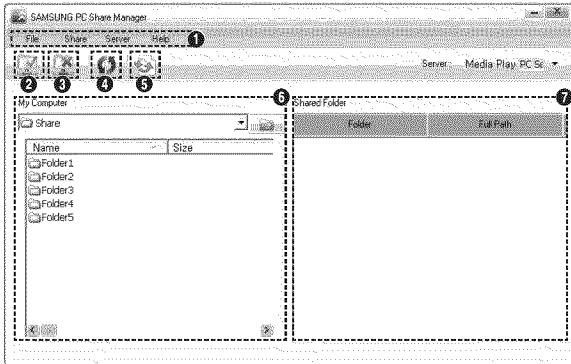

1. Menus: The following application menus are provided : **File**, **Share**, **Server**, and **Help**.
2. Click to share the selected PC server folder.
3. Click to cancel sharing.
4. Click to refresh the PC folder and files.
5. Click to synchronize the share status.
6. The folders and files of the PC to be shared are listed.
7. Folders shared by the user are listed.

#### □ File

##### ▣ Property

Shows information on the selected file or folder.

- Method 1: Select a file or folder and select the **File** menu and then select the **Property** sub-menu.
- Method 2: Select a file or folder, right-click over the selected file or folder and then select **Property** from the pop-up menu.

<Method 1>

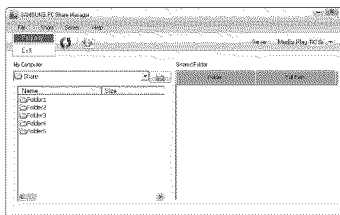

<Method 2>

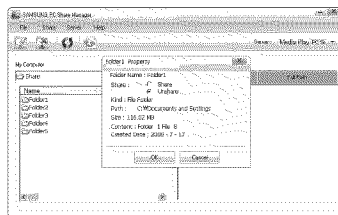

##### ▣ Exit

Exits the DLNA application.

If you select **Exit** without applying the changes after changing the shared status, a message will appear asking if you want to apply the changed settings to the PC. Select **Yes** to apply the changes and exit the application.

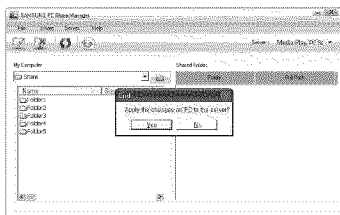

## □ Share

### ■ Sharing a Folder

You can share a folder from your PC to the TV. The maximum number of folders that can be shared is 32.

☑ Your PC will operate as a server to the TV.

- Method 1: Select a folder in **My Computer**, select the **Share** menu and then select the **Share Folder** sub-menu.
- Method 2: Select a folder in **My Computer**, right-click over the selected folder and then select **Share Folder** from the popup menu.
- Method 3: Locate the mouse pointer over a folder in the **My Computer** folder list in the left pane and drag&drop the folder into the Shared Folders pane. If a message appears asking you to confirm the shared folder, select **Yes**.

<Method 1>

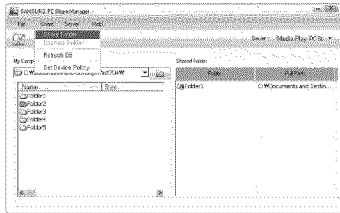

<Method 2>

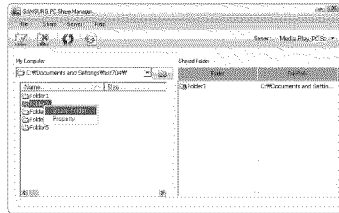

<Method 3>

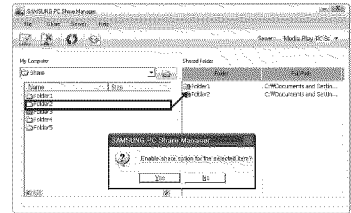

### ■ Cancelling a Shared Folder

You can cancel a shared folder on your PC. Select a folder from the **Shared Folder** pane and select **Unshare Folder**.

- Method 1: Select a folder from the **Shared Folder** pane, select the **Share** menu and then select **Unshare Folder**.
- Method 2: Select a folder from the **Shared Folder** pane, right-click over the selected folder and then select **Unshare Folder** from the pop-up menu.
- Method 3: Locate the mouse pointer over a folder in the **Shared Folder** pane and drag&drop the folder into the **My Computer** pane. If a message appears asking you to confirm the cancellation, select **Yes**.

<Method 1>

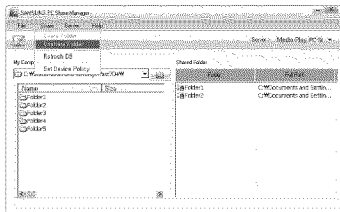

<Method 2>

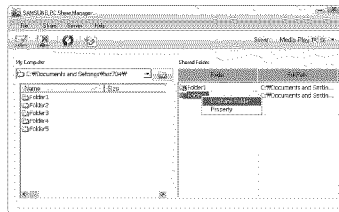

<Method 3>

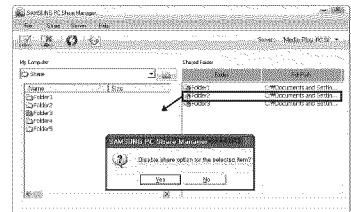

### ■ Applying the Current Settings

Perform this when synchronization is necessary due to a new shared folder or cancelling a shared folder. The **Set Changed State** menu applies changes to shared folders to the data saved with the PC share Program.

Since applying changes to the internal data is a time-consuming process, this function enables users to apply changes to the data only when required.

Until the **Set Changed State** menu is selected, the changed state of the shared folder is not applied to the server.

Changes to the shared folders are not applied to your PC until you select the **Set Changed State** menu.

- Method 1: Select the **Share** menu and select the Refresh DB sub-menu.
- Method 2: Click the **Set Changed State** icon.

<Method 1>

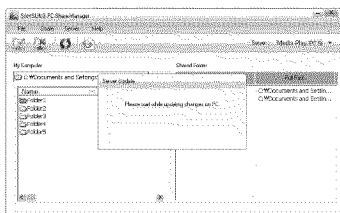

<Method 2>

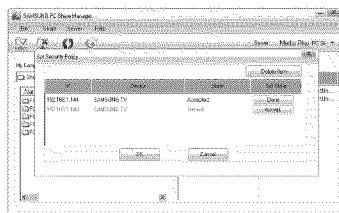

### ☰ **Setting the Access Permission**

To enable the TV to find your PC, the TV must be set to **Set Device Policy** in the Access Permission Settings window. In addition, the PC server and the TV must be on the same subnet.

- Method: Select the **Share** menu and select **Set Device Policy**. Rejected items are represented in gray. You can change the access permissions by using the Allow **Accept / Deny** button. To delete an item, select the item and select **Delete Item**.

### □ **Server**

#### ☰ **Server**

You can run or stop using your PC as a server.

#### ☰ **Run DLNA Digital Media Server when Windows Starts**

You can determine whether to start the PC server automatically when Windows starts.

#### ☰ **Change server name**

You can rename the PC server. Enter a new name and click **OK**. The new name will appear at the top right of the window and will appear on the TV.

### □ **Help**

#### ☰ **Version**

The program version information message box appears.

## Using the DLNA Function

---

### Using the DLNA Menu

DLNA (Digital Living Network Alliance) enables content saved on a DLNA server (usually your PC) connected to your TV or over a network to be played. Media Play enables playing content saved on a USB memory device connected to the TV, while DLNA enables playing content saved on a DLNA server (your PC) connected to your TV or over the network. The procedures to use the content are the same as those for **Media Play (USB & DLNA)**.

- ☑ If you install the PC share manager program supplied with the TV onto a PC, you can have the PC perform the role of a DLNA server over the network.
  - ☑ For detailed procedures on using the DLNA menu, refer to the 'Media Play' instructions. (see pages 39~55)
1. Press the **MEDIA.P** button on the remote control to display the **DLNA** menu.
  2. Press the ◀ or ▶ button to select an icon (**Photo, Music, Movie, Setup**), then press the **ENTER**  button.
    - ☑ To exit **DLNA** mode, press the **MEDIA.P** button on the remote control.
    - ☑ DLNA does not support the following functions.
      - The Background Music and Background Music Setting functions.
      - Sorting files by preference in the Photo, Music, and Movie folders.
      - The Change Group Info function.
      - The Copy / Delete function.
      - The Safe Remove function.
      - The REW/FF (◀◀/▶▶) key functions while a movie is playing.
      - Playing Movie Continuously (Resume Play) function.
    - ☑ The Skip function may not work with some container such as asf and mkv.
    - ☑ The Divx DRM, Multi-audio, embedded caption does not supported.
    - ☑ Samsung PC Share manager should be permitted by the firewall program on your PC.
    - ☑ The Skip (◀/▶ keys) or Pause function may not work while a movie is playing for the DLNA of other manufacturers, depending on the corresponding content information.
    - ☑ The playing time may not be displayed while a movie is playing.

## Connecting Anynet+ Devices

### What is Anynet+?

Anynet+ is a function that enables you to control all connected Samsung devices that support Anynet+ with your Samsung TV's remote. The Anynet+ system can be used only with Samsung devices that have the Anynet+ feature. To be sure your Samsung device has this feature, check if there is an Anynet+ logo on it.

### To connect to a TV

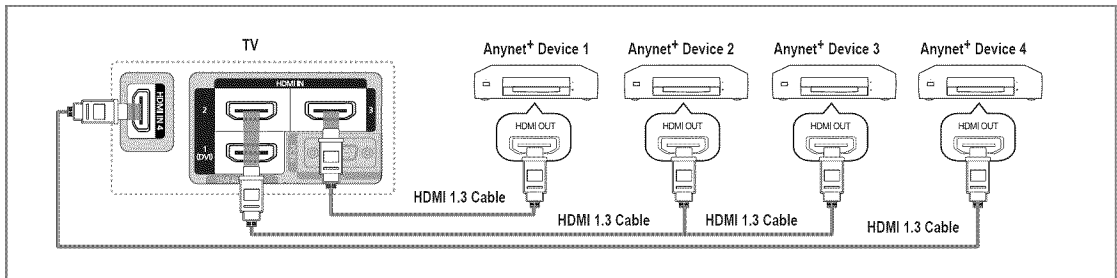

1. Connect the **HDMI IN (1(DVI), 2, 3 or 4)** jack on the TV and the **HDMI OUT** jack of the corresponding Anynet+ device using an **HDMI** cable.

### To connect to Home Theater

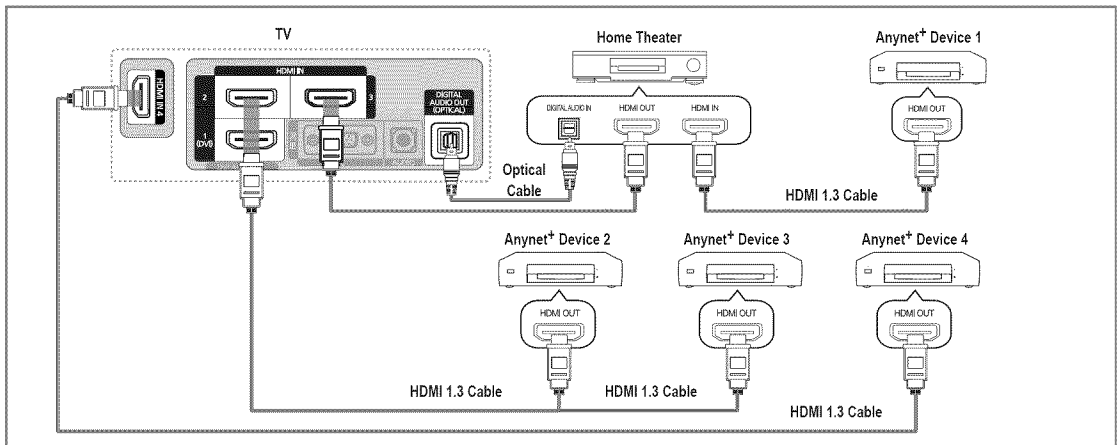

1. Connect the **HDMI IN (1(DVI), 2, 3 or 4)** jack on the TV and the **HDMI OUT** jack of the corresponding Anynet+ device using an **HDMI** cable.
2. Connect the **HDMI IN** jack of the home theater and the **HDMI OUT** jack of the corresponding Anynet+ device using an **HDMI** cable.
  - ☑ Connect the **Optical** cable between the **DIGITAL AUDIO OUT (OPTICAL)** jack on your TV and the **Digital Audio Input** on the Home Theater.
  - ☑ When following the connection above, the **Optical** jack only outputs 2 channel audio. You will only hear sound from the Home Theater's Front Left and Right speakers and the subwoofer. If you want to hear 5.1 channel audio, connect the **DIGITAL AUDIO OUT (OPTICAL)** jack on the DVD / Satellite Box (ie Anynet Device 1 or 2) directly to the Amplifier or Home Theater, not the TV.
  - ☑ Connect only one Home Theater.
  - ☑ You can connect an Anynet+ device using the **HDMI 1.3** cable. Some **HDMI** cables may not support Anynet+ functions.
  - ☑ Anynet+ works when the AV device supporting Anynet+ is in the **Standby** or **On** status.
  - ☑ Anynet+ supports up to 12 AV devices in total. Note that you can connect up to 3 devices of the same type.

## Setting Up Anynet+

- Press the **TOOLS** button to display the **Tools** menu. You can also display Anynet+ menu by selecting **Tools** → **Anynet+ (HDMI-CEC)**.

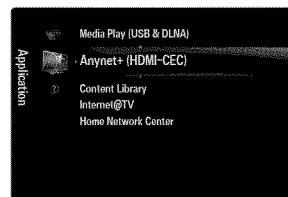

### Setup

#### Anynet+ (HDMI-CEC) → Off / On

To use the Anynet+ Function, **Anynet+ (HDMI-CEC)** must be set to **On**.

- When the **Anynet+ (HDMI-CEC)** function is disabled, all the Anynet+ related operations are deactivated.

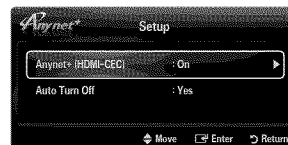

#### Auto Turn Off → No / Yes

Setting an Anynet+ Device to turn Off automatically when the TV is turned Off.

- The active source on the TV remote must be set to TV to use the Anynet+ function.
- If you set **Auto Turn Off** to **Yes**, connected external devices are also turned off when the TV is turned off. If an external device is still recording, it may or may not turn off.

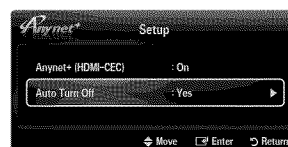

## Switching between Anynet+ Devices

- Press the **TOOLS** button. Press the **ENTER** button to select **Anynet+ (HDMI-CEC)**.
- Press the **▲** or **▼** button to select **Device List**, then press the **ENTER** button.
  - Anynet+ devices connected to the TV are listed.
  - If you cannot find a device you want, press the red button to scan for devices.
- Press the **▲** or **▼** button to select a particular device and press the **ENTER** button. It is switched to the selected device.
  - Only when you set **Anynet+ (HDMI-CEC)** to **On** in the **Application** menu, the **Device List** menu appears.
  - Switching to the selected devices may take up to 2 minutes. You cannot cancel the operation during the switching operation.
  - The time required to scan for devices is determined by the number of connected devices.
  - When the device scan is complete, the number of devices found are not displayed.
  - Although the TV automatically searches the device list when the TV is turned on via the power button, devices connected to the TV may not always be automatically displayed in the device list. Press the red button to search for the connected device.
  - If you have selected external input mode by pressing the **SOURCE** button, you cannot use the Anynet+ function. Make sure to switch to an Anynet+ device by using the **Device List**.



## Anynet+ Menu

The Anynet+ menu changes depending on the type and status of the Anynet+ devices connected to the TV.

Anynet+ Menu	Description
<b>View TV</b>	Anynet+ mode changes to TV broadcast mode.
<b>Device List</b>	Shows the Anynet+ device list.
(device_name) <b>MENU</b>	Shows the connected device menus. E.g. If a DVD recorder is connected, the disc menu of the DVD recorder will appear.
(device_name) <b>INFO</b>	Shows the play menu of the connected device. E.g. If a DVD recorder is connected, the play menu of the DVD recorder will appear.
<b>Recording:</b> (*recorder)	Starts recording immediately using the recorder. (This is only available for devices that support the recording function.)
<b>Stop Recording:</b> (*recorder)	Stops recording.
<b>Receiver</b>	Sound is played through the receiver.

- If more than one recording device is connected, they are displayed as (\*recorder) and if only one recording device is connected, it will be represented as (\*device\_name).







## TV Remote Control Buttons Available in Anynet+ Mode

Device Type	Operating Status	Available Buttons
Anynet+ Device	After switching to the device, when the menu of the corresponding device is displayed on the screen.	Numeric buttons ▲/▼/◀/▶/ ENTER  buttons Color buttons / EXIT button
	After switching to the device, while playing a file	◀◀ (Backward search) / ▶▶ (Forward search) / ■ (Stop) / ▶ (Play) / ⏸ (Pause)
Device with built-in Tuner	After switching to the device, when you are watching a TV program	▼ CH ▲ button
Audio Device	When Receiver is activated	–VOL+ / MUTE button

- ☑ The Anynet+ function only works when the active source on the TV remote control is set to TV.
- ☑ The  button works only while in the recordable state.
- ☑ You cannot control Anynet+ devices using the buttons on the TV. You can control Anynet+ devices only using the TV remote control.
- ☑ The TV remote control may not work under certain conditions. If this occurs, reselect the Anynet+ device.
- ☑ The Anynet+ functions do not operate with other manufacturers' products.
- ☑ The ◀◀, ▶▶ operations may differ depending on the device.

## Recording

You can make a recording of a TV program using a Samsung recorder.

- Press the **TOOLS** button. Press the **ENTER**  button to select **Anynet+ (HDMI-CEC)**.
- Press the ▲ or ▼ button to select **Recording Immediately** and press the **ENTER**  button. Recording begins.
  - ☑ When there is more than one recording device
    - When multiple recording devices are connected, the recording devices are listed. Press the ▲ or ▼ button to select a recording device and press the **ENTER**  button. Recording begins.
  - ☑ When the recording device is not displayed select **Device List** and press the Red button to search devices
- Press the **EXIT** button to exit.
  - ☑ You can record the source streams by selecting **Recording:** (device\_name).
  - ☑ Pressing the  button will record whatever you are currently watching. If you are watching video from another device, the video from the device is recorded.
  - ☑ Before recording, check whether the antenna jack is properly connected to the recording device. To properly connect an antenna to a recording device, refer to the recording device's users manual.



## Listening through a Receiver (Home Theater)

You can listen to sound through a receiver instead of the TV speaker.

- Press the **TOOLS** button. Press the **ENTER**  button to select **Anynet+ (HDMI-CEC)**.
- Press the ▲ or ▼ button to select **Receiver**. Press the ◀ or ▶ button to select **On** or **Off**.
- Press the **EXIT** button to exit.
  - ☑ If your receiver supports audio only, it may not appear in the device list.
  - ☑ The receiver will work when you have properly connected the optical in jack of the receiver to the **DIGITAL AUDIO OUT (OPTICAL)** jack of the TV.
  - ☑ When the receiver (home theater) is set to On, you can hear sound output from the TV's Optical jack. When the TV is displaying a DTV(air) signal, the TV will send out 5.1 channel sound to the Home Theater receiver. When the source is a digital component such as a DVD and is connected to the TV via HDMI, only 2 channel sound will be heard from the Home Theater receiver.
  - ☑ If there is a power interruption to the TV when the **Receiver** is set to **On** (by disconnecting the power cord or a power failure), the **Speaker Select** may be set to **External Speaker** when you turn the TV on again.



## Troubleshooting for Anynet+

Problem	Possible Solution
Anynet+ does not work.	<ul style="list-style-type: none"> <li>● Check if the device is an Anynet+ device. The Anynet+ system supports Anynet+ devices only.</li> <li>● Connect only one receiver (home theater).</li> <li>● Check if the Anynet+ device power cord is properly connected.</li> <li>● Check the Anynet+ device's Video/Audio/HDMI 1.3 cable connections.</li> <li>● Check whether Anynet+ (HDMI-CEC) is set to On in the Anynet+ setup menu.</li> <li>● Check whether the TV remote control is in TV mode.</li> <li>● Check whether it is Anynet+ exclusive remote control.</li> <li>● Anynet+ doesn't work in certain situations. (Searching channels, Operating <b>Media Play, Plug &amp; Play</b>, etc.)</li> <li>● When connecting or removing the HDMI 1.3 cable, please make sure to search devices again or turn your TV off and on again.</li> <li>● Check if the Anynet+ Function of Anynet+ device is set on.</li> </ul>
I want to start Anynet+.	<ul style="list-style-type: none"> <li>● Check if the Anynet+ device is properly connected to the TV and check if the <b>Anynet+ (HDMI-CEC)</b> is set to <b>On</b> in the <b>Anynet+ Setup</b> menu.</li> <li>● Press the TV button on the TV remote control to switch to TV. Then press the <b>TOOLS</b> button to show the Anynet+ menu and select a menu you want.</li> </ul>
I want to exit Anynet+.	<ul style="list-style-type: none"> <li>● Select <b>View TV</b> in the Anynet+ menu.</li> <li>● Press the <b>SOURCE</b> button on the TV remote control and select a device other than Anynet+ devices.</li> <li>● Press <b>∨ CH ∧</b>, <b>CH LIST</b>, <b>PRE-CH</b>, and <b>FAV.CH</b> to change the TV mode. (Note that the channel button operates only when a tuner-embedded Anynet+ device is not connected.)</li> </ul>
The message 'Connecting to Anynet+ device...' appears on the screen.	<ul style="list-style-type: none"> <li>● You cannot use the remote control when you are configuring Anynet+ or switching to a view mode.</li> <li>● Use the remote control when the Anynet+ setting or switching to view mode is complete.</li> </ul>
The Anynet+ device does not play.	<ul style="list-style-type: none"> <li>● You cannot use the play function when Plug &amp; Play is in progress.</li> </ul>
The connected device is not displayed.	<ul style="list-style-type: none"> <li>● Check whether or not the device supports Anynet+ functions.</li> <li>● Check whether or not the HDMI 1.3 cable is properly connected.</li> <li>● Check whether <b>Anynet+ (HDMI-CEC)</b> is set to <b>On</b> in the Anynet+ setup menu.</li> <li>● Search Anynet+ devices again.</li> <li>● You can connect an Anynet+ device using the HDMI 1.3 cable only. Some HDMI cables may not support Anynet+ functions.</li> <li>● If it is terminated by an abnormal situation such as disconnecting the HDMI cable or power cord or a power failure, please repeat the device scan.</li> </ul>
The TV program cannot be recorded.	<ul style="list-style-type: none"> <li>● Check whether the antenna jack on the recording device is properly connected.</li> </ul>
The TV sound is not output through the receiver.	<ul style="list-style-type: none"> <li>● Connect the optical cable between TV and the receiver.</li> </ul>

# CONTENT LIBRARY

## Using the Content Library

The Content Library allows you to enjoy various content on your TV. You can use the default content stored in the TV memory or you can enjoy new content using a USB device or via the Internet.

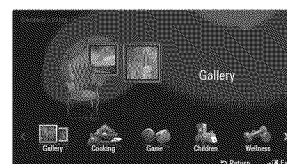
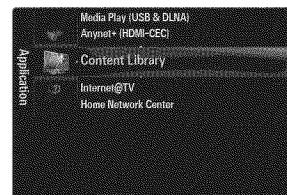

### Using the Content Library Menu

1. Press the **MENU** button. Press the **▲** or **▼** button to select **Application**, then press the **ENTER** button.
2. Press the **▲** or **▼** button to select **Content Library**, then press the **ENTER** button.  
 The **Content Library** main menu is displayed.
3. Press the **◀** or **▶** button to select an icon (**Gallery, Cooking, Game, Children, Wellness, Others, Content Management**), then press the **ENTER** button.

### Using the Remote Control Button in Content Library Menu

Button	Operations
<b>▲/▼/◀/▶</b>	Move the cursor and select an item.
<b>ENTER</b>	Select the currently selected item.
<b>RETURN</b>	Return to the previous menu.
<b>EXIT</b>	Stop the current function and return to the <b>Content Library</b> main menu.
<b>▼ CH ▲</b>	Stop <b>Content Library</b> mode and Returns to TV mode.
Color button	Keys that provide functions are described on the corresponding page.
<b>- VOL + / MUTE</b>	You can control the volume of the played content.

CONTENT LIBRARY CONTAINS TEXT, GRAPHICS, IMAGES, MULTIMEDIA, AND OTHER MATERIALS FOR INFORMATIONAL AND PROMOTIONAL PURPOSES ONLY. MATERIALS IN CONTENT LIBRARY HAS BEEN MODIFIED AND KEEPS BEING REVISED AND UPDATED. THE MATERIALS IN THE CONTENT LIBRARY MAY NOT BE SUITABLE FOR ALL AUDIENCES.

INFORMATION IN THE CONTENT LIBRARY IS PROVIDED 'AS IS.' ALTHOUGH THE INFORMATION PROVIDED TO YOU IN THE CONTENT LIBRARY IS OBTAINED OR COMPLIED FROM SOURCES WE BELIEVE TO BE RELIABLE, SAMSUNG CANNOT AND DOES NOT GUARANTEE THE ACCURACY, VALIDITY, TIMELINESS OR COMPLETENESS OF ANY INFORMATION OR DATA MADE AVAILABLE TO YOU FOR ANY PARTICULAR PURPOSE. UNDER NO CIRCUMSTANCES, INCLUDING NEGLIGENCE, SHALL SAMSUNG BE HELD LIABLE, WHETHER IN CONTRACT OR TORT, FOR ANY DIRECT, INDIRECT, INCIDENTAL, SPECIAL OR CONSEQUENTIAL DAMAGES, ATTORNEY FEES, EXPENSES, OR ANY OTHER DAMAGES WHATSOEVER ARISING OUT OF, OR IN CONNECTION WITH, ANY INFORMATION CONTAINED IN, OR THE USE OF, THE CONTENT LIBRARY, EVEN IF ADVISED OF THE POSSIBILITY OF SUCH DAMAGES.

## Using the TV Memory Contents



You can use enjoy content stored in the TV memory. You can add/delete content to/from the TV memory. To add/delete content, select **Content Management**.

☑ To return to **Content Library** main menu, press the **EXIT** button.

### ☐ Gallery

This function plays a SlideShow with high resolution images and background music and produces various atmospheres. Using the Gallery function of the TV, you can change your home atmosphere.

☑ The copyrights of the **Gallery** contents and all issues related to them are reserved by **TimeSpace, Inc.**

☑ Press the **ENTER**  button to pause the SlideShow, and also press the **ENTER**  button to resume the SlideShow.

☑ Press the **INFO** button to display information on the selected photo. (This is not displayed if the photo has no information.)

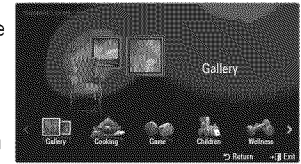

### ☐ Cooking

You can view various recipes and then easily follow them step by step. Enjoy these contents which will give you great ideas for meals.

☑ The recipes introduced in the **Cooking** contents on the Samsung TV are based on recipes published by **Anness Publishing**.

☑ The copyrights of the **Cooking** contents and all issues related to them are reserved by Practical Pictures.

### ☐ Game

This category provides entertainment games for the whole family.

☑ For the buttons used in the games, refer to the directions on the screen.

#### ☑ Color Buttons for Games

Button	Operations
Red	Press to move to the game home screen
Green	Press to pause the game
Yellow	Option Key
Blue	Press to exit the game

### ☐ Children

This is educational and interactive content that children can watch repeatedly.

☑ The copyrights of the **Children** contents and issues related to them reserved by **UpToTen**.

### ☐ Wellness

This is beneficial health management content that provides stretching and massage exercises that can be enjoyed by the whole family.

### ☐ Others

The default content is not saved in the TV memory.

☑ You can copy new content to the TV memory using the **Content Management** screen.

## Using the Content Management

### Content Management

You can add or delete contents using the **Content Management**.

- You can select multiple content items by selecting content items repeatedly and pressing the Yellow button.

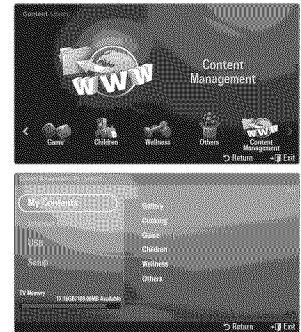

### My Contents

You can check the content saved in the TV memory for each subitem of the Content Library.

- Select a content item and press the **ENTER** button. You can play or delete the selected content item.

### Internet Download

If your TV connect to the internet via a LAN cable, you can directly download the contents provided by Samsung Electronics.

- Select a content item and press the **ENTER** button. You can play the selected content item or copy it to the TV memory.

### USB

You can check the content saved on the USB device for each subitem of the **Content Library**.

- Select a content item and press the **ENTER** button. You can play the selected content item or copy it to the TV memory.
  - Content Library** only supports USB Mass Storage Class devices (MSC). MSC is a Mass Storage Class Bulk-Only Transport device. Examples of MSC are Thumb drives and Flash Card Readers.
  - Playing a game using an external USB memory device will allow you to save your game (depending on the game). Take care as removing the USB memory device while saving data to the USB memory device may cause the data to be lost.
  - Downloading New Contents

New content other than the built-in content will be provided via the Samsung.com website free of charge. When you download the paid contents, you need UDN number to download contents. Check the UDN number before downloading a new content item.

    - Downloading Content
      1. Visit the [www.samsung.com](http://www.samsung.com) website.
      2. Select a content item in the Contents Download page.
      3. Download the contents onto the USB memory device.
      4. Go to **Content Library** main menu by pressing **CONTENT** button or choosing **Content Library** (Menu → **Application** → **Content Library**).
      5. Plug the USB memory into USB port on the side of the TV.
      6. You can see the content sub item which you downloaded.
      7. Select a content item and press the **ENTER** button.
      8. You can play the selected content item or copy it to the TV memory.

### Setup

- **Screen Saver Run Time**: Select to set the waiting time before the screen saver appears.
- **Save UDN**: Saves the UDN number to a USB device.
- An NTFS format USB storage device does not support saving UDN. We recommend using a FAT format USB storage device.

# INTERNET@TV

You can enjoy the best of the Internet in perfect harmony with the simplicity and reliability of your television.

If you have some problems while using a widget service, please contact the content provider. In the widget, press the green button to get contact information or refer to help website for the widget provider information.

In some regions, only English may be supported for services.

## Getting Started with Internet@TV

**Internet@TV** provides an integrated Internet and television experience powered by the Yahoo!® Widget Engine. You can monitor financial stocks, share photos with friends and family, and track news and weather all through the **Internet@TV** service on your television.

You may experience slow operation or hesitation when using this function due to network conditions.

When running **Internet@TV** for the first time, the basic settings proceed automatically.

The first step is to set up your network. For more information on how to configure your network, refer to 'Setting the Network' (see pages 30~35)

After your network is operational, the Internet@TV software guides you through a step-by-step setup wizard.

### What is a Widget?

A TV Widget is a small web application that allows you to easily access your favorite site using the remote control. You can enjoy various types of information, such as the latest news, weather information, and stock information, etc. on your TV along with your friends or family members.

Some widgets may not be supported depending on the regulations of the corresponding country.

Some widgets will only support limited services depending on the regulations of the corresponding country.

The color buttons may work differently depending on the widget.

The operation may not be smooth depending on the network condition.

The Snippet is a symbol of Widget.

### What is a Snippet?

A snippet shows a part of the Widget contents such as weather and stock information that the user wants to view.

The snippets are automatically updated in real time.

It may take a few seconds to load the snippet.

1. Press the **MENU** button. Press the **▲** or **▼** button to select Application, then press the **ENTER**  button.

2. Press the **▲** or **▼** button to select **Internet@TV**, then press the **ENTER**  button.

**Internet@TV** starts.

Press the **INTERNET@** button on the remote control to display the **Internet@TV** menu.

3. The **General Disclaimer** is displayed on the screen. Select **I accept** or **I do not accept**.

For more information on the **General Disclaimer**, refer to the '**Legal Notice**'. (see page 36)

4. The 'welcome screen' is the starting point of the **Internet@TV** guided setup.

If you select **Exit Setup**, this step is resumed when you press the **INTERNET@** button.

Select **Let's get started!**

5. Choosing your location allows TV Widgets to use localized content.

Select your country from the list provided.

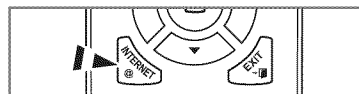

6. Accepting the Yahoo!® TV Widget Engine Privacy Policy is required to use Internet@TV.
  - ☑ Select **OK, I Accept**.
7. Accepting the Yahoo!® TV Widget System Terms of Service is required to use Internet@TV.
  - ☑ Select **OK, I Accept**.
8. Enter your name to setup your profile. Each profile has its own list of widgets. You can create a profile for each person who uses **Internet@TV**.
  - ☑ Enter your name and select **Save this name**.
  - ☑ For more information, refer to 'Using the Profile Widget'. (see page 71)
9. **Internet@TV** tests the network connection.
  - ☑ If the test fails, configure your network again.
  - ☑ For more information, refer to 'Setting the Network'. (see pages 30~35)
10. The guided setup is complete. A tutorial on how to use **Internet@TV** is next.
  - ☑ Select **Continue** to view the tutorial.
  - ☑ Select **Exit setup** to start using Internet@TV now.
  - ☑ To run the tutorial again, select **Profile Widget** → **System Setting** → **Repeat Tutorial**.
11. Press the **INTERNET@** button on the remote control to display the **Internet@TV** user interface.

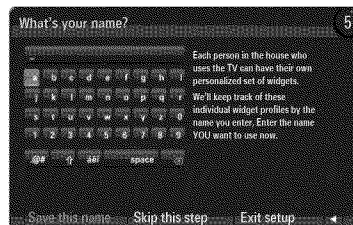





## □ Screen display

### ☰ Dock mode

- 1 A welcome banner is shown with your profile name in the top right corner.
  - ☑ This banner disappears after a short delay.
- 2 The banner highlights two remote control shortcuts.
  - ☑ If you press the blue button (**Viewport**) on your remote control, the display is toggled between 'Viewport mode' and 'Overlay mode'. In Viewport mode, the TV or video plays in a scaled-down area with graphics outside. In overlay mode, the graphics are displayed on top of the TV or video.
  - ☑ If you press the yellow button (**Edit Snippet**) on your remote control, a help window is displayed and the snippet with focus can be edited.
- 3 Press the **INTERNET@** button on the remote control to begin.
  - ☑ The horizontal list at the bottom of your TV screen is called 'the dock'.
  - ☑ The items in the list are called 'snippets'.
  - ☑ A snippet is a shortcut which launches a TV Widget.
  - ☑ A TV Widget is an Internet application designed to run on your TV.
  - ☑ Move between snippets by pressing the ◀ or ▶ buttons on the remote control.
  - ☑ Focus is located in the left most region (highlighted in blue).
  - ☑ The dock slides snippets under that focal point.
  - ☑ Launch a TV Widget by pressing the **ENTER** [ ] button on the remote control when its snippet is in focus.
  - ☑ When you add snippets, they form a stack which you can navigate by pressing the ▲ or ▼ buttons.
  - ☑ Two special TV Widgets appear in the dock: the **Profile Widget** and the **Gallery Widget**. These cannot be deleted.
  - ☑ The dock will slide off screen after a timeout period.



## ☰ Sidebar mode

- ❶ Focus on a snippet and press the **ENTER**  button to launch the TV Widget sidebar. The TV Widget logo and Home  are at the top of the sidebar.
- ❷ Current menu is displayed under the TV Widget logo.
  - 📄 To return to a previous screen, select it and press the **ENTER**  button.
  - 📄 You can also press the **RETURN** button on the remote control.
- ❸ Current selection is always highlighted in blue and is activated when you press the **ENTER**  button.
- ❹ When there is a lot of data, a page control is used.
  - 📄 Current page and total pages are displayed.
  - 📄 Move between pages by pressing **◀** or **▶** buttons.
- ❺ The bottom toolbar includes color buttons that correspond to the red, green, yellow and blue buttons on the remote control.
  - Red button: Close the widget.
  - Green button: Change the widget's setting.
  - Yellow button: Manage your snippets.
  - Blue button: Size video to fit, or make it full screen.
  - 📄 Some buttons may not be available depending on widget.

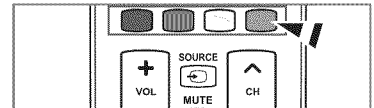
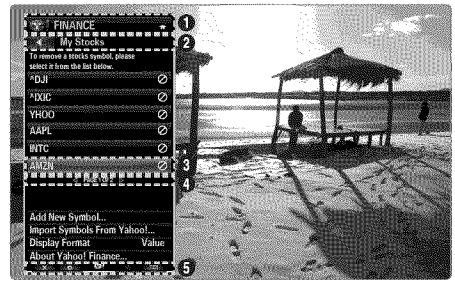

All content and services accessible through this device belong to third parties and are protected by copyright, patent, trademark and/or other intellectual property laws. Such content and services are provided solely for your personal noncommercial use. You may not use any content or services in a manner that has not been authorized by the content owner or service provider. Without limiting the foregoing, unless expressly authorized by the applicable content owner or service provider, you may not modify, copy, republish, upload, post, transmit, translate, sell, create derivative works, exploit, or distribute in any manner or medium any content or services displayed through this device.

YOU EXPRESSLY ACKNOWLEDGE AND AGREE THAT USE OF THE DEVICE IS AT YOUR SOLE RISK AND THAT THE ENTIRE RISK AS TO SATISFACTORY QUALITY, PERFORMANCE AND ACCURACY IS WITH YOU. THE DEVICE AND ALL THIRD PARTY CONTENT AND SERVICES ARE PROVIDED "AS IS" WITHOUT WARRANTY OF ANY KIND, EITHER EXPRESS OR IMPLIED. SAMSUNG EXPRESSLY DISCLAIMS ALL WARRANTIES AND CONDITIONS WITH RESPECT TO THE DEVICE AND ANY CONTENT AND SERVICES, EITHER EXPRESS OR IMPLIED, INCLUDING BUT NOT LIMITED TO, WARRANTIES OF MERCHANTABILITY, OF SATISFACTORY QUALITY, FITNESS FOR A PARTICULAR PURPOSE, OF ACCURACY, OF QUIET ENJOYMENT, AND NON-INFRINGEMENT OF THIRD PARTY RIGHTS. SAMSUNG DOES NOT GUARANTEE THE ACCURACY, VALIDITY, TIMELINESS, LEGALITY, OR COMPLETENESS OF ANY CONTENT OR SERVICE MADE AVAILABLE THROUGH THIS DEVICE AND DOES NOT WARRANT THAT THE DEVICE, CONTENT OR SERVICES WILL MEET YOUR REQUIREMENTS, OR THAT OPERATION OF THE DEVICE OR SERVICES WILL BE UNINTERRUPTED OR ERROR-FREE. UNDER NO CIRCUMSTANCES, INCLUDING NEGLIGENCE, SHALL SAMSUNG BE LIABLE, WHETHER IN CONTRACT OR TORT, FOR ANY DIRECT, INDIRECT, INCIDENTAL, SPECIAL OR CONSEQUENTIAL DAMAGES, ATTORNEY FEES, EXPENSES, OR ANY OTHER DAMAGES ARISING OUT OF, OR IN CONNECTION WITH, ANY INFORMATION CONTAINED IN, OR AS A RESULT OF THE USE OF THE DEVICE, OR ANY CONTENT OR SERVICE ACCESSED BY YOU OR ANY THIRD PARTY, EVEN IF ADVISED OF THE POSSIBILITY OF SUCH DAMAGES.

Third party services may be changed, suspended, removed, terminated or interrupted, or access may be disabled at any time, without notice, and Samsung makes no representation or warranty that any content or service will remain available for any period of time. Content and services are transmitted by third parties by means of networks and transmission facilities over which Samsung has no control. Without limiting the generality of this disclaimer, Samsung expressly disclaims any responsibility or liability for any change, interruption, disabling, removal of or suspension of any content or service made available through this device. Samsung may impose limits on the use of or access to certain services or content, in any case and without notice or liability.

Samsung is neither responsible nor liable for customer service related to the content and services. Any question or request for service relating to the content or services should be made directly to the respective content and service providers.



## Editing Snippets in the Dock

1. Edit a snippet by focusing on it in the dock and pressing the yellow button.
2. The snippet moves to the Second position and its tile slides up to show the following help text:
  - Delete (red button): Remove this TV Widget.
    - Deleted widgets can be re-installed using the **Widget Gallery**.
  - Move (blue button): Re-order the snippet. Press the ◀ or ▶ button to scroll. Press the yellow button to drop into the new position.
  - Done (yellow button): Exit the **Edit Snippet** menu.

## Using the Profile Widget

The Profile Widget configures your user profile.

You can set up multiple profiles, and each profile maintains its own list of widgets.

The **Switch Profile** menu allows you to switch to a different user profile.

- At least two profiles must be registered. If you want to add a profile, refer to '**Administrative Controls**'. (see page 72)

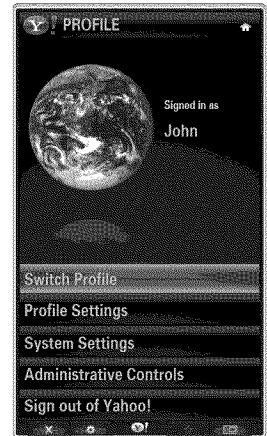

The **Profile Settings** menu allows you to customize and protect your profile.

- User profiles can be customized with a unique **Name** and an **Avatar** (a picture used to represent your profile).
- Your profile's **Name** and **Avatar** are displayed in the profile snippet in the dock.
- Profiles can be protected by **Create Profile PIN**.
- When setting the PIN for the first time, you can set a Security Question.

The Profile Settings menu can limit access to widgets.

- If you forget your **Profile PIN** you can answer a **Security Question** that is associated with your profile.
- A profile that has the Limit Profile indicator turned on will not allow new widgets to be installed.
- The Owner PIN must be set to use this function. To set the Owner PIN, refer to '**Administrative Controls**'. (see page 72)

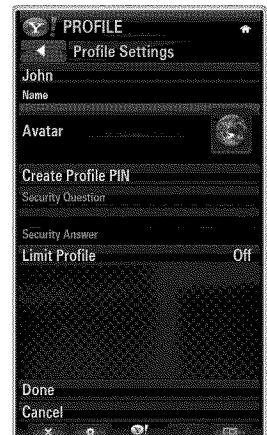

The **System Settings** menu allows you to:

- Change your **Location** and set your **Zip Code** (US only) to tailor the content to your region.
- **Repeat Tutorial** that was shown during guided setup.
- **Restore Factory Settings** to delete all widget configurations and information..

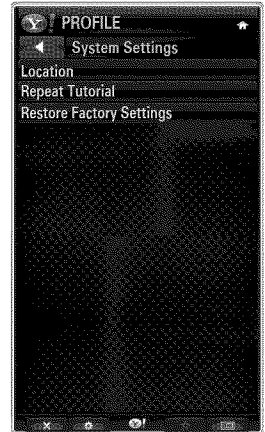

In the **Administrative Controls** menu you can:

- Set the **Screen Saver** timeout to avoid screen burn in.
- **Create Owner PIN** and set a **Security Question** to control other profiles.
- Create a new Profile which can be configured with a different set of widgets.
- Delete an existing profile.

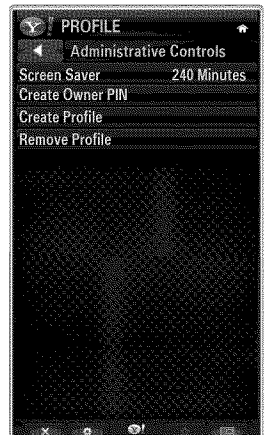

From the Profile Widget you can **Sign in to Yahoo!**® using your Yahoo! ID.

- If you have a Yahoo! ID, you can access your personalized content using the Yahoo!® TV Widgets.
- All Yahoo!® TV Widgets that are installed are automatically signed-in with your profile's Yahoo! ID.
- If you have no Yahoo! account, visit [www.yahoo.com](http://www.yahoo.com) and create an account.
- You may fail to log in with an ID created on the Yahoo website in a country that does not support Internet@TV.

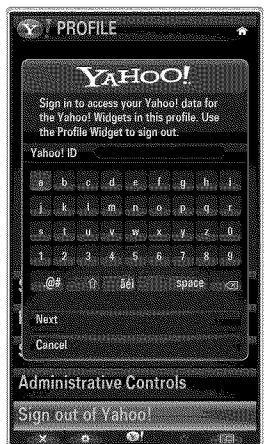

#### □ About Profile widget

Press the green button.

You can view a brief description of the **Profile Widget**, **Copyright Policy**, **Terms of Service**, and **Privacy Policy**.

## Using the Yahoo!® Widget Gallery

Use the Yahoo!® Widget Gallery to add more widgets to your TV.

View available TV Widgets in the following categories:

- **Latest Widgets:** Displays recently updated widgets.
  - **Yahoo!® Widgets:** Displays widgets provided by Yahoo!®.
  - **Samsung Widgets:** Displays widgets provided by Samsung.
  - **More Categories:** Displays all widgets by category.
- ☑ To install a widget, navigate to the detail screen and select **Add Widget to My Profile** and press the **ENTER**  button. The widget is installed and becomes available in the dock.

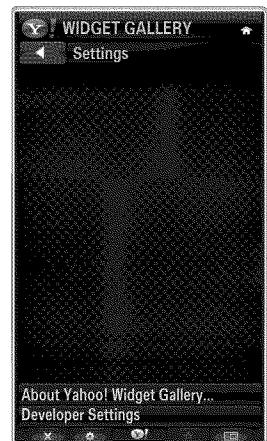
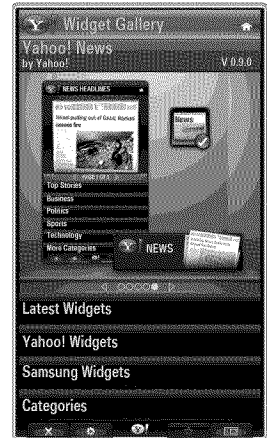

### ☐ Widget Gallery Settings

Press the Green button.

### ☰ About Yahoo! Widget Gallery

You can view brief information for the **Widget Gallery**, **Copyright Policy**, **Terms of Service**, and **Privacy Policy**.

### ☰ In the Developer Settings menu You can make your own widget.



For more information on creating your own widget, visit our developer site at <http://connectedtv.yahoo.com/>

## Using the Yahoo!® Weather Widget

The Yahoo!® Weather Widget provides updates on your local and favorite weather locations. This content dynamically changes with weather conditions.

- Press the green button on the remote control to display the Yahoo!® Weather Widget **Settings** menu.
- From the **Settings** menu you can add or remove a city for which you want to view weather information.

From the **Settings** menu:

- **Add New City** by entering the name of the city. Once the search results are displayed, select the city you want and press the **ENTER**  button.
- **Delete City** by selecting the city you want to delete from the city list. Press the **ENTER**  button and confirm the deletion.
- Changing the Temperature Indication Mode  
You can change the temperature indication mode to **Imperial** or **Metric**. For example, **Imperial** will show temperatures in Fahrenheit and **Metric** in Celsius.



### Create a snippet for a favorite city

- Select the city from the Yahoo!® Weather Widget's home page and view the detailed weather information.
- Press the yellow button.
- Select the **Add Snippet** menu and press **ENTER**  to add the city as a snippet.

### Delete a snippet for a city

- Launch the snippet.
- Press the yellow button.
- Select the Delete Snippet menu and press **ENTER**  to remove the snippet.

## Using the Yahoo!® News Widget

The Yahoo!® News Widget provides the latest headline news for business, entertainment, politics, sports, top stories, and many other categories.

- Select a category, select a headline within the category, and view a dynamically updated news summary.





## Using the Yahoo!® Flickr Widget

The **Flickr** Widget can provide you access to your favorite photos from friends and family while watching TV. Share your photos with your family on your big screen TV through a slideshow.

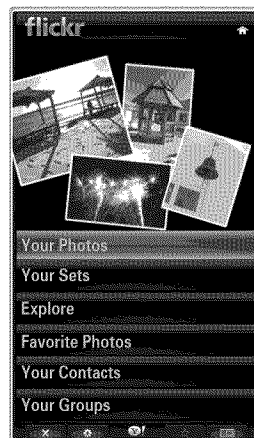

- Personalize the **Flickr** Widget by logging in with your Yahoo! ID.
- For detailed procedures on log in, refer to the 'Using the Profile Widget' instructions. (see page 72)
- For more information on **Flickr**, visit <http://www.flickr.com>.
- ☑ **Your Photos** shows photos you have registered with **Flickr** website.



### ☰ To view Flickr photos in a slideshow:

- Select a thumbnail of a photo and press the **ENTER**  button to view the photo's details.
- Select **Start Slideshow** and press the **ENTER**  button.

### ☰ To control the slideshow display:

- Press the **ENTER**  button during a slideshow.
- The thumbnails of photos are displayed on the bottom of the screen.
  - ☑ When the slideshow control is displayed, you can Pause, Play and Stop the slideshow.
  - ☑ If you select the menu and press **ENTER** , you can view information for the selected photo.
- The **Your Sets** menu allows you to view photos you have classified in Flickr.
- The **Explore** menu allows you to explore photos featured by the Flickr website. You can view the photos updated daily.
- The **Mark as Favorite** or **Remove From Favorite** menu moves photos to your Favorite Photos set or removes photos from it.
- The **Favorite Photos** menu allows you to see the photos you have classified as favorites.
- The **Your Contacts** menu allows you to see updates from family and friends.



The **Your Groups** menu allows you to select your favorite groups from the Flickr website to share and enjoy photos with the Flickr community of users.

To configure the Yahoo!® Flickr Widget Settings press the green button on the remote control.



- The **Time Per Slide** menu controls the speed of the slideshow.
- The **Repeat** menu will restart the slideshow at the beginning after the last photo is shown.

## Using the Yahoo!® Finance Widget

View stock information and the latest stock news with the Yahoo!® Finance Widget.

Press the green button to set up your stocks.

Use the **Add New Symbol** menu to enter the name of a new stock.

- Select the stock you want to add from the search results and select the Add Symbol menu and press the **ENTER**  button.
  - ② The selected stock is added to the **My Stocks** list.
- Use the **Import Symbols From Yahoo!®** menu to retrieve your Yahoo!® Finance portfolio.
  - The **Merge Symbols** menu merges the symbols in the Yahoo!® Finance Widget with the symbols from your portfolio.
  - The **Replace Symbols** menu deletes the symbols in the Yahoo!® Finance Widget and replaces them with the symbols from your portfolio.
- Use the **Display Format** menu to change the stock-price fluctuation transition to **Value** or **Percentage**.
- Create a snippet for a favorite stock.
  - Select the stock symbol from the Yahoo!® Finance Widget's home page and view the detailed finance information.
  - Press the yellow button.
  - Select the **Add Snippet** menu and press **ENTER**  to add the stock as a snippet.
- **Delete** a snippet
  - Launch the snippet from the dock
  - Press the yellow button.
  - Select the **Delete Snippet** menu and press **ENTER**  to remove the snippet.

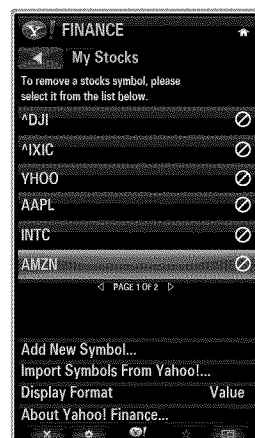

## Troubleshooting for internet@TV

Problem	Possible Solution
Some widget services do not work.	Check with that service provider. In the widget, press the green button and get contact information or refer to help website for widget service provider information. Refer to Help website page.
Some widget contents only have English. How can I change the language?	Widget content language may be different from the widget user interface language. It depends on the service provider.
After factory reset, the Yahoo Widget service doesn't work and a warning message is displayed.	After factory reset, turn your TV on and off. Then restart Internet@TV.
At the Flickr widget, I logged in my account. But, I can't view my picture.	Visit the Yahoo Web site, and activate your Flickr account at your Yahoo! ID.
At the Profile widget, I changed the location, but the previous setting still remains.	Turn your TV off and on, then access Internet@TV again. Now, you can enjoy widget services in the changed location.

## Help Website

Country	Website
USA	www.samsung.com → consumer products → Television → medi@2.0 → Internet@TV
Canada	www.samsung.com → consumer products → TV → medi@2.0 → Internet@TV
	www.samsung.com → produits grand public → téléviseurs → medi@2.0 → Internet@TV
Mexico	www.samsung.com → productos de consumo → televisores → medi@2.0 → Internet@TV

② The location of Internet@TV on the website may vary by country and/or change in the future.

# HOME NETWORK CENTER

The Home Network Center allows your mobile phone to communicate with your TV.

## Home Network Center

### About the Home Network Center

The **Home Network Center** connects the TV and mobile phones through a network. You can view call arrivals, text message contents, and schedules set on the mobile phone on the TV using the **Home Network Center**. In addition, you can play the media contents saved on the mobile phones such as videos, photos and music by controlling them onto the TV via the network.

- ☑ If the device supports DLNA DMC (Digital Media Controller) function, Home Network Center function is available.
- ☑ The Samsung SCH-i910 mobile phone supports the Home Network Center. Other models will be added in the future. The mobile device may need additional software installation. For details, refer to each user's guide.

### Connecting to the Home Network Center

For more information about the network settings, refer to 'Configuring the Network'. (see pages 30~35)

#### ● Connecting through a Wi-Fi Ad-hoc Network

1. Connect the 'Samsung Wireless LAN Adapter' to the **USB1(HDD)** or **USB2** port of the TV.

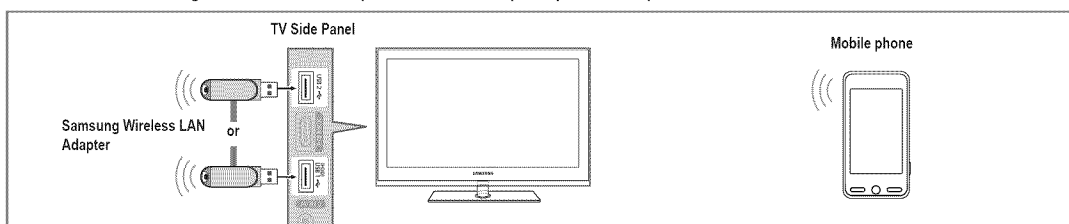

2. For more information on how to configure Ad-hoc network, refer to 'Setting the Network'. (see page 35)
  - ☑ For information on configuring the mobile phone's network settings, refer to the mobile phone manual.
3. Set up the IP address, SSID and password for the mobile phone in the Ad-hoc Settings of the mobile phone using the **Network Name (SSID)** and **Security Key** (password) displayed on the TV.

#### ● Connecting through a wired/wireless IP sharer

1. Connect the LAN port of the TV and the Wired/Wireless IP sharer using the LAN cable or connect the **USB1(HDD)** or **USB2** port of the TV and the 'Samsung Wireless LAN Adapter'.

- ☑ For the procedures to set up the wired/wireless sharer and the mobile phone, refer to the manual of the corresponding device.

### Using the LAN cable

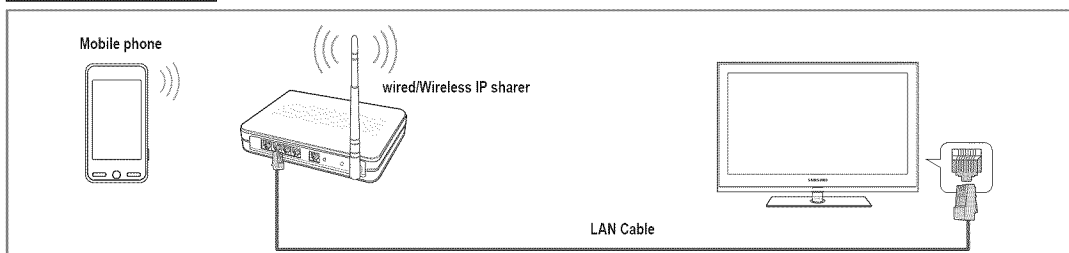

### Using the Samsung Wireless LAN Adapter

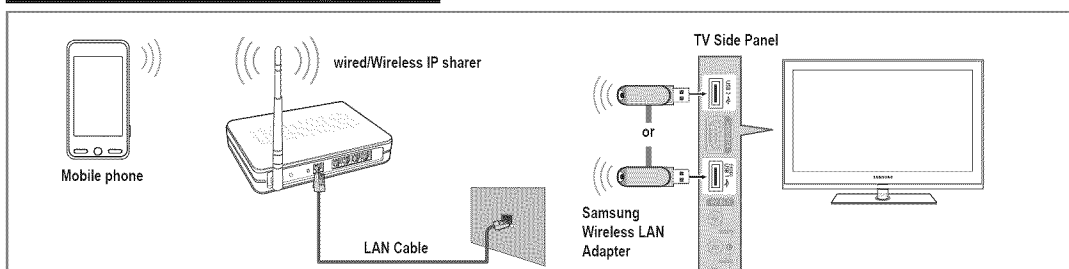

## Setting Up the Home Network Center

### Message

Shows a list of mobile phones which have been set up with this TV to use the message function (the call arrivals, text message contents and schedules set on the mobile phone).

#### Allowed

Allows the mobile phone.

#### Denied

Blocks the mobile phone.

#### Delete

Deletes the mobile phone from the list.

- This function just deletes the name from the list. If the deleted mobile device turns on or tries to connect to the TV, it may be shown on the list.

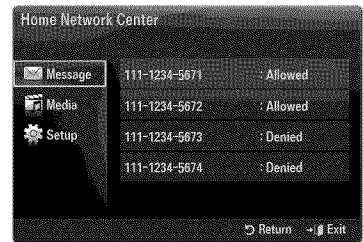

### Media

Shows a list of mobile phones which is available to control media contents (videos, photos, music) from the phone.

- Besides mobile phone, other mobile devices that support **DLNA DMC** are available.

#### Allowed

Allows the mobile phone.

#### Denied

Blocks the mobile phone.

#### Delete

Deletes the mobile phone from the list.

- This function just deletes the corresponding name on the list. If the deleted mobile device turns on or tries to connect to the TV, it may be shown on the list.

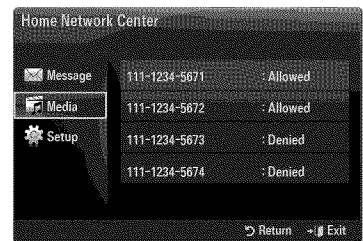

### Setup

#### Message → On / Off

You can determine whether to use the message function (the call arrivals, text message contents, and schedules set on the mobile phone).

#### Media → On / Off

You can select whether to use the Media function that plays the contents (videos, photos, music) from the mobile phone.

#### TV name

You can set the TV name so as to find it easily on the mobile device.

- If you selects **User Input**, you can type the TV name by **OSK(On Screen Keyboard)**.

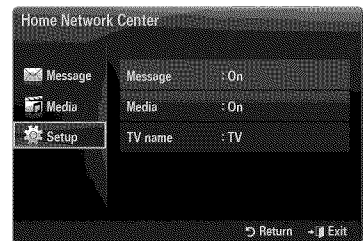



## Using the Message Function

Using this function, you can view the call arrivals, text message contents and schedules set on the mobile phone through the alarm window while watching TV.

- ✔ To disable this **Message** alarm window, set **Message** to **Off** in **Setup** of the **Home Network Center**.
- ✔ The alarm window appears for 20 seconds. If no key is pressed or if **Cancel** is selected, it appears up to three times at 5 minute intervals.
- ✔ If **OK** is selected, or if **OK** is not selected while the message is displayed three times, the message will be deleted. The message is not deleted from the mobile phone.
- ✔ The simple alarm window can be displayed, while using some applications such as Media Play, Contents Library, etc. In this case, to view the contents of the message, switch to TV viewing mode.
- ✔ When the message of an unknown mobile phone is displayed, select the mobile phone in the **Message** item of the **Home Network Center** and select **Denied** to block the phone.



### Message View

If a new text message (SMS) arrives while you are watching TV, the alarm window appears. If you click the **OK** button, the contents of the message are displayed.

- If you select the **OK** button, the contents of the message are displayed.
- If you select the **Cancel** button, the alarm window appears up to three times at 5 minute intervals.
- ✔ You can configure the viewing settings for the text message (SMS) contents on the mobile phone. For the procedures, refer to the mobile phone manual.
- ✔ Some special characters may be displayed as blank or broken characters.

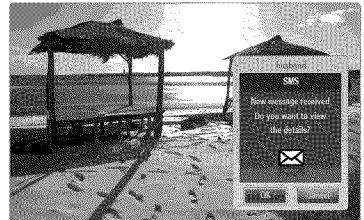

### Call Arrival Alarm

If a call arrives while you are watching TV, the alarm window appears.

- If you select the **OK** button, the call arrival alarm is confirmed and the alarm window is closed.
- If you select the **Cancel** button, the alarm window appears up to three times at 5 minute intervals.

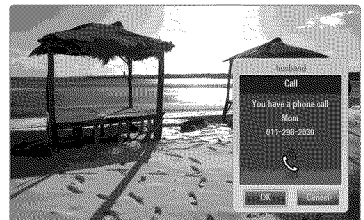

### Schedule Alarm

While you are watching TV, the alarm window appears to display the registered schedule.

- If you select the **OK** button, you can view the contents of the schedule registered on the mobile phone.
- If you select the **Cancel** button, the alarm window appears up to three times at 5 minute intervals.
- ✔ You can configure the viewing settings for the schedule contents on the mobile phone. For the procedures, refer to the mobile phone manual.
- ✔ Some special characters may be displayed as blank or broken characters.

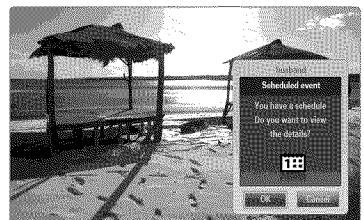

## Using the Media Function

An alarm window appears informing the user that the media contents (videos, photos, music) sent from the mobile phone will be displayed on the TV.



The contents are played automatically 3 seconds after the alarm window appears.

If you press the **RETURN** or **EXIT** button when the alarm window appears, the **Media Contents** are not played.

- ☑ To turn off the media contents transmission from the mobile phone, set **Media to Off** in **Setup** of the **Home Network Center**.
- ☑ The contents may not be played on the TV depending on their resolution and format.



### Media play control buttons

Button	Operations
◀/▶	Move the cursor and select an item. While playing a movie file: skip forwards or backwards through the movie file.
ENTER 	Pressing the <b>ENTER</b>  button during play pauses the play. Pressing the <b>ENTER</b>  button during pause resumes the play.
RETURN	Return to the previous menu.
TOOLS	Run various functions from the Photo, Music and Movie menus.
INFO	Show file information.
EXIT	Stop <b>Media Play</b> mode and Returns to TV mode.



- ☑ The **ENTER**  and **◀/▶** buttons may not work depending on the type of media content.
- ☑ Using the mobile device, you can control playing media. For details, refer to each user's guide.

# RECOMMENDATIONS

## Troubleshooting

If the TV seems to have a problem, first try this list of possible problems and solutions. If none of these troubleshooting tips apply, call Samsung customer service at 1-800-SAMSUNG.

Problem	Possible Solution
Poor picture.	Try another channel. / Adjust the antenna. / Check all wire connections.
Poor sound quality.	Try another channel. / Adjust the antenna.
No picture or sound.	Try another channel. / Press the <b>SOURCE</b> button. Make sure the TV is plugged in. / Check the antenna connections.
No sound or sound is too low at maximum volume.	First, check the volume of units connected to your TV (digital broadcasting receiver, DVD, cable broadcasting receiver, VCR, etc.). Then, adjust the TV volume accordingly.
Picture rolls vertically.	Check all wire connections.
There is a problem with the picture	Run the Picture test in the Self diagnostic menu.
There is a problem with the sound	Run the Sound test in the Self diagnostic menu.
The TV operates erratically.	Unplug the TV for 30 seconds, then try operating it again.
The TV won't turn on.	Make sure the wall outlet is working.
Remote control malfunctions.	Replace the remote control batteries. Clean the upper edge of the remote control (transmission window). Check the battery terminals.
'Check signal cable' message.	Ensure that the signal cable is firmly connected to the PC source.
'Not Supported Mode' message.	Check the maximum resolution and connected device's Video frequency. Compare these values with the data in the Display Modes.
Digital broadcasting screen problem.	Please check the digital signal strength and input antenna.
The image is too light or too dark.	Adjust the Brightness and Contrast. / Adjust the Fine tuning.
Black bars on the screen.	Make sure the broadcast you're receiving is High Definition (HD). HD channels sometimes broadcast Standard Definition (SD) programming, which can cause black bars. Set your cable/satellite box to stretch or widescreen mode to eliminate the bars.
Picture has a Red/Green or Pink tint.	Make sure the Component cables are connected to the correct jacks.
Closed Captioning not working.	If you are using a Cable/Satellite box, you must set Closed Captioning on the box, not your TV.
Snowy picture.	Your cable box may need a firmware upgrade. Please contact your Cable company.
Ghosting on picture.	This is sometimes caused by compatibility issues with your cable box. Try connecting Component cables instead.
Horizontal bars appear to flicker, jitter or shimmer on the image.	Adjust the Coarse tuning and then adjust the Fine tuning.
Vertical bars appear to flicker, jitter or shimmer on the image.	Adjust the Coarse tuning and then adjust the Fine tuning.
Screen is black and power indicator light blinks steadily.	On your computer check: Power, Signal Cable. The TV is using its power management system. Move the computer's mouse or press any key on the keyboard.

Problem	Possible Solution
Image is not stable and may appear to vibrate when you have a computer connected to the PC input.	If the setting is not correct, use your computer utility program to change the display settings. Your TV supports multiscan display functions within the following frequency domain: - Horizontal frequency (KHz): 30~60 - Vertical frequency (Hz): 60~75 - PC Maximum refresh rate (at 60 Hz): 1920 x 1080
Image is not centered on the screen.	Adjust the horizontal and vertical position. The screen position must be adjusted on the output source (i.e. STB) with a digital signal.
The picture appears distorted in the corner of the screen.	If <b>Screen Fit</b> is selected with some external devices, the picture may appear distorted in the corner of the screen. This symptom is caused by the external devices, not TV.
The 'Resets all settings to the default values.' message appears.	This appears when you press and hold the <b>EXIT</b> button for a while. The product settings are reset to the factory defaults.

- ☞ This TFT LCD panel uses a panel consisting of sub pixels (6 220 800) which require sophisticated technology to produce. However, there may be few bright or dark pixels on the screen. These pixels will have no impact on the performance of the product.

## Installing the Stand

- Attach your LCD TV to the stand.
  - ☞ Two or more people should carry the TV.
  - ☞ Make sure to distinguish between the front and back of the stand when attaching it.
  - ☞ To make sure the TV is installed on the stand at a proper level, do not apply excess downward pressure to the upper left or right sides of the TV.
- Fasten screws at position ① and then fasten screws at position ②.
  - ☞ Stand the product up and fasten the screws. If you fasten the screws with the LCD TV placed down, it may lean to one side.

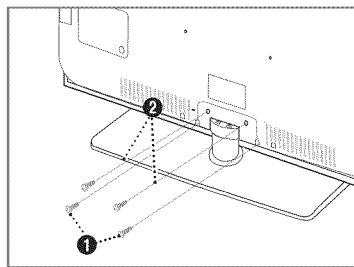

## Disconnecting the Stand

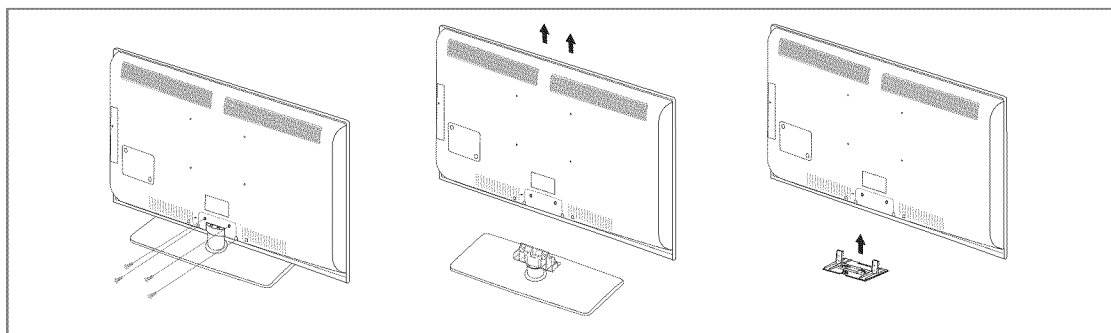

- Remove screws from the back of the TV.
- Separate the stand from the TV.
  - ☞ Two or more people should carry the TV.
- Cover the bottom hole with the cover.

## Assembling the Cables

Enclose the cables in the Holder-Wire Cable so that the cables are not visible through the transparent stand.

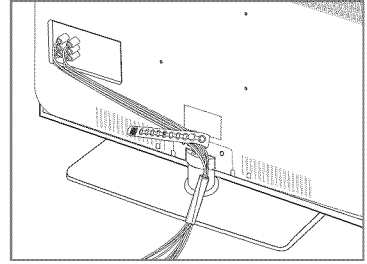

## Wall Mount Kit Specifications (VESA)

Install your wall mount on a solid wall perpendicular to the floor. When attaching to other building materials, please contact your nearest dealer. If installed on a ceiling or slanted wall, it may fall and result in severe personal injury.

- ☑ Standard dimensions for wall mount kits are shown in the table above.
- ☑ When purchasing our wall mount kit, a detailed installation manual and all parts necessary for assembly are provided.
- ☑ Do not use screws longer than the standard dimension, as they may cause damage to the inside of the TV set.
- ☑ For wall mounts that do not comply with the VESA standard screw specifications, the length of the screws may differ depending on their specifications.
- ☑ Do not use screws that do not comply with the VESA standard screw specifications.
- ☑ Do not fasten the screws too strongly, this may damage the product or cause the product to fall, leading to personal injury. Samsung is not liable for these kinds of accidents.
- ☑ Samsung is not liable for product damage or personal injury when a non-VESA or non-specified wall mount is used or the consumer fails to follow the product installation instructions.
- ☑ Our 57" and 63" models do not comply with VESA Specifications. Therefore, you should use our dedicated wall mount kit for this model.
- ☑ Do not exceed 15 degrees tilt when mounting this TV.

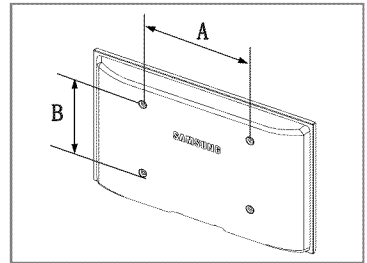

Product Family	inches	VESA Spec. (A * B)	Standard Screw	Quantity
LCD-TV	19~22	100 X 100	M4	4
	23~29	200 X 100		
	30~40	200 X 200	M6	
	46~55	400 X 400	M8	
	57~70	800 X 400		
	80~	1400 X 800		
PDP-TV	42~50	400 X 400	M8	4
	58~63	600 X 400		
	70~	800 X 400		
	80~	1400 X 800		
LFD	30~39	200 X 200	M6	4
	40~52	400 X 400	M8	
	55~70	800 X 400		
	70~	1400 X 800		



Do not install your Wall Mount Kit while your TV is turned on. It may result in personal injury due to electric shock.

## Anti-Theft Kensington Lock

The Kensington Lock is a device used to physically fix the system when using it in a public place. The appearance and locking method may differ from the illustration depending on the manufacturer.

Refer to the manual provided with the Kensington Lock for proper use.

- ☑ The locking device has to be purchased separately.
  - ☑ The location of the Kensington Lock may depend on its model.
1. Insert the locking device into the Kensington slot on the LCD TV (❶) and turn it in the locking direction (❷).
  2. Connect the Kensington Lock cable (❸).
  3. Fix the Kensington Lock to a desk or a heavy stationary object.

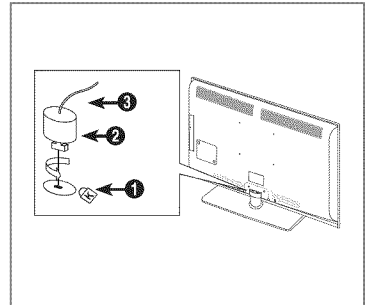

## Securing the Installation Space

Keep the required distances between the product and other objects (e.g. walls) to ensure proper ventilation.

Failing to do so may result in fire or a problem with the product due to an increase in the internal temperature of the product.

Install the product so the required distances shown in the figure are kept.

- ☑ When using a stand or wall-mount, use parts provided by Samsung Electronics only.
  - If you use parts provided by another manufacturer, it may result in a problem with the product or an injury due to the product falling.
  - If you use parts provided by another manufacturer, it may result in a problem with the product or fire due to an increase in the internal temperature of the product due to poor ventilation.
- ☑ The appearance may differ depending on the product.

### When installing the product with a stand

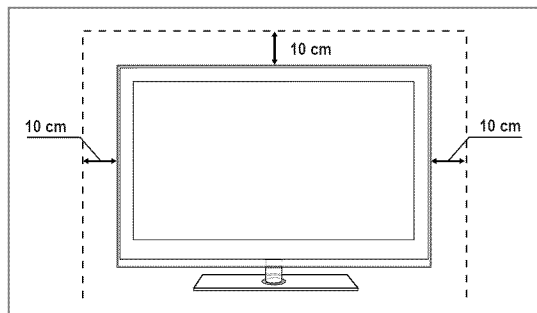

### When installing the product with a wall-mount

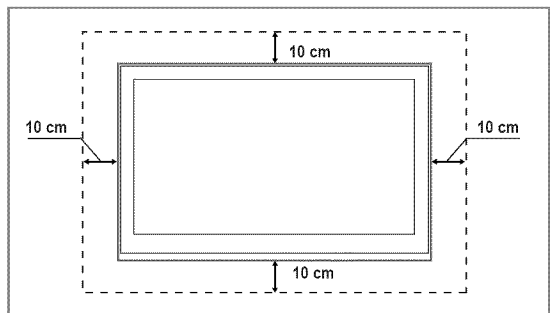

## Securing the TV to a Wall or Cabinet



**Caution:** Pulling, pushing, or climbing on the TV may cause the TV to fall. In particular, ensure your children do not hang over or destabilize the TV; doing so may cause the TV to tip over, causing serious injuries or death. Follow all safety precautions provided on the included Safety Flyer. For added stability, install the anti-fall device for safety purposes, as follows.

### Components (Depending on the model):

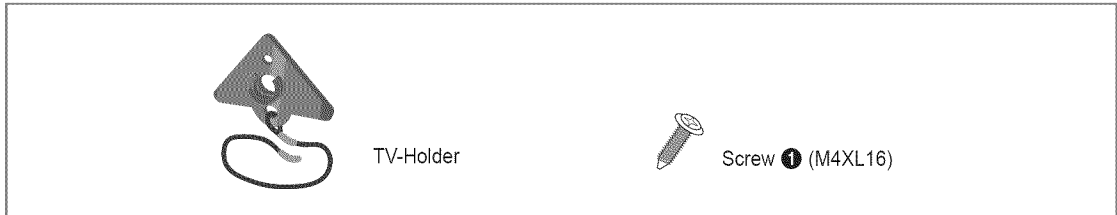

### To prevent the TV from falling:

1. Attach the TV-Holder to the TV by fastening the screws ① (M4XL16) into the holes in the center of the TV.
  - ☑ Make sure to only use the supplied screws.

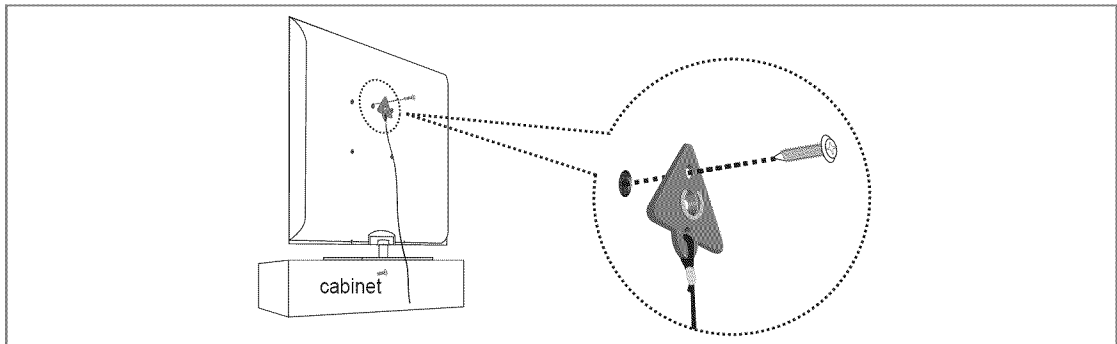

2. Firmly fasten the screws to the wall or cabinet where the TV is to be installed. Tie the TV-Holder attached to the TV and the screws fastened on the wall or cabinet so that the TV is fixed.
  - ☑ Purchase the screws to be used on the wall or cabinet separately.
  - ☑ Install the TV close to the wall so that it does not fall.
  - ☑ When attaching the TV to the wall, tie the cord level with the ground or slanted downwards for safety purposes.
  - ☑ Confirm that the cord or link does not come loose.
  - ☑ Before moving the TV, separate the connected cord first.

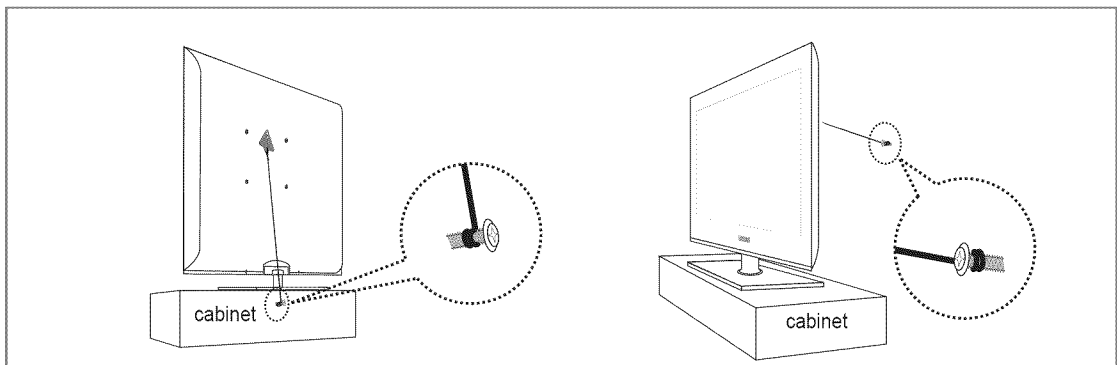

3. Verify all connections are properly secured. Periodically check connections for any sign of fatigue or failure. If you have any doubt about the security of your connections, contact a professional installer.

## Specifications

<b>Model Name</b>	<b>LN40B750</b>
<b>Screen Size</b> (Diagonal)	40 inches (40.0 inches measured diagonally)
<b>PC Resolution</b> (Optimum)	1920 x 1080 @ 60 Hz
<b>Sound</b> (Output)	10W x 2
<b>Dimensions (WxDxH)</b> Body With stand	38.7 x 3.1 x 24.8 (inch) / 984.0 x 78.6 x 629.2 (mm) 38.7 x 10.0 x 27.2 (inch) / 984.0 x 255.0 x 691.5 (mm)
<b>Weight</b> Without Stand With Stand	32.6 lbs / 14.8 Kg 41.2 lbs / 18.7 Kg
<b>Environmental Considerations</b> Operating Temperature Operating Humidity Storage Temperature Storage Humidity	10°C to 40°C (50°F to 104°F) 10% to 80%, non-condensing -20°C to 45°C (-4°F to 113°F) 5% to 95%, non-condensing
<b>Stand Swivel</b> (Left / Right)	-20° ~ 20°

<b>Model Name</b>	<b>LN46B750</b>
<b>Screen Size</b> (Diagonal)	46 inches (46.0 inches measured diagonally)
<b>PC Resolution</b> (Optimum)	1920 x 1080 @ 60 Hz
<b>Sound</b> (Output)	10W x 2
<b>Dimensions (WxDxH)</b> Body With stand	43.9 x 3.1 x 27.7 (inch) / 1115.0 x 78.6 x 702.5 (mm) 43.9 x 10.8 x 30.3 (inch) / 1115.0 x 275.0 x 769.5 (mm)
<b>Weight</b> Without Stand With Stand	41.7 lbs / 18.9 Kg 52.7 lbs / 23.9 Kg
<b>Environmental Considerations</b> Operating Temperature Operating Humidity Storage Temperature Storage Humidity	10°C to 40°C (50°F to 104°F) 10% to 80%, non-condensing -20°C to 45°C (-4°F to 113°F) 5% to 95%, non-condensing
<b>Stand Swivel</b> (Left / Right)	-20° ~ 20°



<b>Model Name</b>	<b>LN62B750</b>
<b>Screen Size</b> (Diagonal)	52 inches (52.0 inches measured diagonally)
<b>PC Resolution</b> (Optimum)	1920 x 1080 @ 60 Hz
<b>Sound</b> (Output)	10W x 2
<b>Dimensions (WxDxH)</b> Body With stand	49.5 x 3.1 x 31.3 (inch) / 1258.0 x 79.9 x 795.1 (mm) 49.5 x 12.0 x 33.8 (inch) / 1258.0 x 305.0 x 858.5 (mm)
<b>Weight</b> Without Stand With Stand	64.8 lbs / 26.1 Kg 76.5 lbs / 31.0 Kg
<b>Environmental Considerations</b> Operating Temperature Operating Humidity Storage Temperature Storage Humidity	10°C to 40°C (50°F to 104°F) 10% to 80%, non-condensing -20°C to 45°C (-4°F to 113°F) 5% to 95%, non-condensing
<b>Stand Swivel</b> (Left / Right)	-20° ~ 20°

- ☑ Design and specifications are subject to change without prior notice.
- ☑ This device is a Class B digital apparatus.
- ☑ For the power supply and Power Consumption, refer to the label attached to the product.

## Dimensions

**LN40B750**

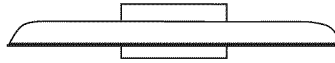

**TOP VIEW**

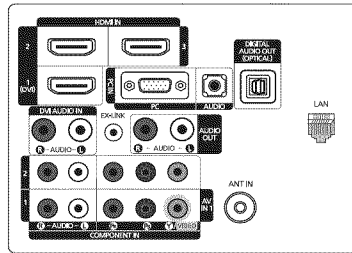

**JACK PANEL DETAIL 5.2"H X 6.6"W**

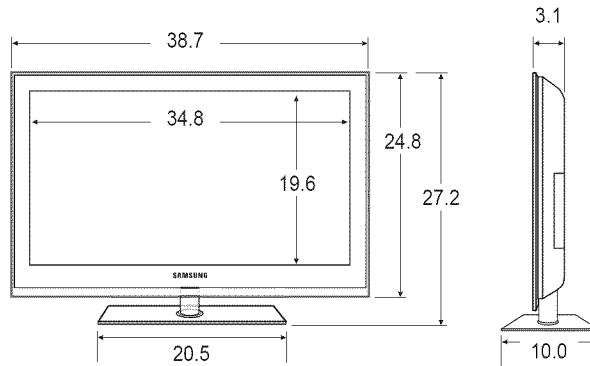

**FRONT VIEW / SIDE VIEW**

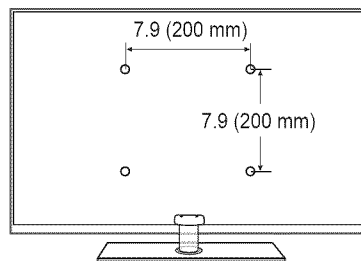

**REAR VIEW**

NOTE: All drawings are not necessarily to scale. Some dimensions are subject to change without prior notice. Refer to the dimensions prior to performing installation of your TV. Not responsible for typographical or printed errors.

© 2009 Samsung Electronics America, Inc



TOP VIEW

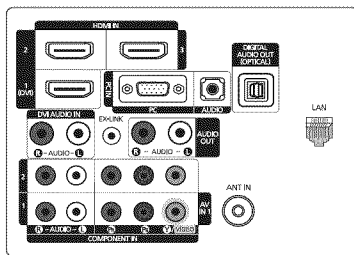

JACK PANEL DETAIL 5.2"H X 6.6"W

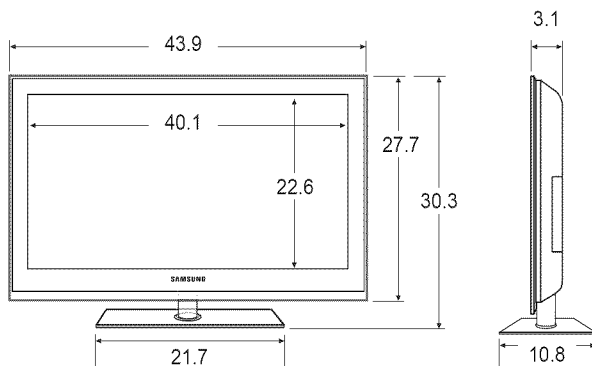

FRONT VIEW / SIDE VIEW

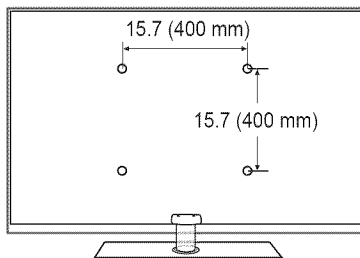

REAR VIEW

NOTE: All drawings are not necessarily to scale. Some dimensions are subject to change without prior notice. Refer to the dimensions prior to performing installation of your TV. Not responsible for typographical or printed errors.

© 2009 Samsung Electronics America, Inc



TOP VIEW

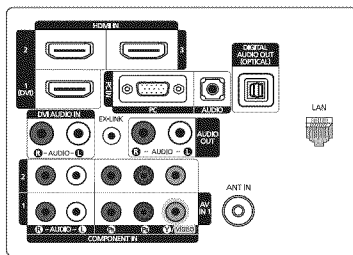

JACK PANEL DETAIL 5.2"H X 6.6"W

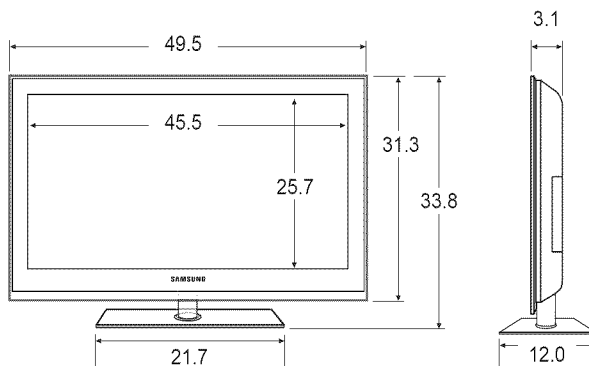

FRONT VIEW / SIDE VIEW

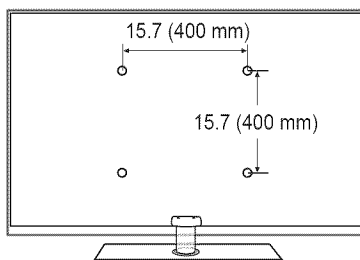

REAR VIEW

NOTE: All drawings are not necessarily to scale. Some dimensions are subject to change without prior notice. Refer to the dimensions prior to performing installation of your TV. Not responsible for typographical or printed errors.

© 2009 Samsung Electronics America, Inc

- This product uses parts of the software from the Independent JPEG Group.
- This product uses parts of the software owned by the Freetype Project ([www.freetype.org](http://www.freetype.org)).
- This product uses some software programs which are distributed under the GPL/LGPL license. Accordingly, the following GPL and LGPL software source codes that have been used in this product can be provided after asking to [vdswmanager@samsung.com](mailto:vdswmanager@samsung.com).  
 GPL software: Linux Kernel, Busybox, Binutils  
 LGPL software: Glibc, ffmpeg, smpeg, libgphoto, libusb, SDL

## GNU GENERAL PUBLIC LICENSE

---

Version 3, 29 June 2007

Copyright (C) 2007 Free Software Foundation, Inc. <<http://fsf.org/>>

Everyone is permitted to copy and distribute verbatim copies of this license document, but changing it is not allowed.

### Preamble

The GNU General Public License is a free, copyleft license for software and other kinds of works.

The licenses for most software and other practical works are designed to take away your freedom to share and change the works. By contrast, the GNU General Public License is intended to guarantee your freedom to share and change all versions of a program--to make sure it remains free software for all its users. We, the Free Software Foundation, use the GNU General Public License for most of our software; it applies also to any other work released this way by its authors. You can apply it to your programs, too.

When we speak of free software, we are referring to freedom, not price. Our General Public Licenses are designed to make sure that you have the freedom to distribute copies of free software (and charge for them if you wish), that you receive source code or can get it if you want it, that you can change the software or use pieces of it in new free programs, and that you know you can do these things.

To protect your rights, we need to prevent others from denying you these rights or asking you to surrender the rights. Therefore, you have certain responsibilities if you distribute copies of the software, or if you modify it: responsibilities to respect the freedom of others.

For example, if you distribute copies of such a program, whether gratis or for a fee, you must pass on to the recipients the same freedoms that you received. You must make sure that they, too, receive or can get the source code. And you must show them these terms so they know their rights.

Developers that use the GNU GPL protect your rights with two steps: (1) assert copyright on the software, and (2) offer you this License giving you legal permission to copy, distribute and/or modify it.

For the developers' and authors' protection, the GPL clearly explains that there is no warranty for this free software. For both users' and authors' sake, the GPL requires that modified versions be marked as changed, so that their problems will not be attributed erroneously to authors of previous versions.

Some devices are designed to deny users access to install or run modified versions of the software inside them, although the manufacturer can do so. This is fundamentally incompatible with the aim of protecting users' freedom to change the software. The systematic pattern of such abuse occurs in the area of products for individuals to use, which is precisely where it is most unacceptable. Therefore, we have designed this version of the GPL to prohibit the practice for those products. If such problems arise substantially in other domains, we stand ready to extend this provision to those domains in future versions of the GPL, as needed to protect the freedom of users.

Finally, every program is threatened constantly by software patents. States should not allow patents to restrict development and use of software on general-purpose computers, but in those that do, we wish to avoid the special danger that patents applied to a free program could make it effectively proprietary. To prevent this, the GPL assures that patents cannot be used to render the program non-free.

The precise terms and conditions for copying, distribution and modification follow.

### TERMS AND CONDITIONS

#### 0. Definitions.

"This License" refers to version 3 of the GNU General Public License.

"Copyright" also means copyright-like laws that apply to other kinds of works, such as semiconductor masks.

"The Program" refers to any copyrightable work licensed under this License. Each licensee is addressed as "you". "Licensees" and "recipients" may be individuals or organizations.

To "modify" a work means to copy from or adapt all or part of the work in a fashion requiring copyright permission, other than the making of an exact copy. The resulting work is called a "modified version" of the earlier work or a work "based on" the earlier work.

A "covered work" means either the unmodified Program or a work based on the Program.

To "propagate" a work means to do anything with it that, without permission, would make you directly or secondarily liable for infringement under applicable copyright law, except executing it on a computer or modifying a private copy. Propagation includes copying, distribution (with or without modification), making available to the public, and in some countries other activities as well.

To “convey” a work means any kind of propagation that enables other parties to make or receive copies. Mere interaction with a user through a computer network, with no transfer of a copy, is not conveying.

An interactive user interface displays “Appropriate Legal Notices” to the extent that it includes a convenient and prominently visible feature that (1) displays an appropriate copyright notice, and (2) tells the user that there is no warranty for the work (except to the extent that warranties are provided), that licensees may convey the work under this License, and how to view a copy of this License. If the interface presents a list of user commands or options, such as a menu, a prominent item in the list meets this criterion.

#### 1. Source Code.

The “source code” for a work means the preferred form of the work for making modifications to it. “Object code” means any non-source form of a work.

A “Standard Interface” means an interface that either is an official standard defined by a recognized standards body, or, in the case of interfaces specified for a particular programming language, one that is widely used among developers working in that language.

The “System Libraries” of an executable work include anything, other than the work as a whole, that (a) is included in the normal form of packaging a Major Component, but which is not part of that Major Component, and (b) serves only to enable use of the work with that Major Component, or to implement a Standard Interface for which an implementation is available to the public in source code form. A “Major Component”, in this context, means a major essential component (kernel, window system, and so on) of the specific operating system (if any) on which the executable work runs, or a compiler used to produce the work, or an object code interpreter used to run it.

The “Corresponding Source” for a work in object code form means all the source code needed to generate, install, and (for an executable work) run the object code and to modify the work, including scripts to control those activities. However, it does not include the work’s System Libraries, or general-purpose tools or generally available free programs which are used unmodified in performing those activities but which are not part of the work. For example, Corresponding Source includes interface definition files associated with source files for the work, and the source code for shared libraries and dynamically linked subprograms that the work is specifically designed to require, such as by intimate data communication or control flow between those subprograms and other parts of the work.

The Corresponding Source need not include anything that users can regenerate automatically from other parts of the Corresponding Source.

The Corresponding Source for a work in source code form is that same work.

#### 2. Basic Permissions.

All rights granted under this License are granted for the term of copyright on the Program, and are irrevocable provided the stated conditions are met. This License explicitly affirms your unlimited permission to run the unmodified Program. The output from running a covered work is covered by this License only if the output, given its content, constitutes a covered work.

This License acknowledges your rights of fair use or other equivalent, as provided by copyright law. You may make, run and propagate covered works that you do not convey, without conditions so long as your license otherwise remains in force. You may convey covered works to others for the sole purpose of having them make modifications exclusively for you, or provide you with facilities for running those works, provided that you comply with the terms of this License in conveying all material for which you do not control copyright. Those thus making or running the covered works for you must do so exclusively on your behalf, under your direction and control, on terms that prohibit them from making any copies of your copyrighted material outside their relationship with you.

Conveying under any other circumstances is permitted solely under the conditions stated below. Sublicensing is not allowed; section 10 makes it unnecessary.

#### 3. Protecting Users’ Legal Rights From Anti-Circumvention Law.

No covered work shall be deemed part of an effective technological measure under any applicable law fulfilling obligations under article 11 of the WIPO copyright treaty adopted on 20 December 1996, or similar laws prohibiting or restricting circumvention of such measures.

When you convey a covered work, you waive any legal power to forbid circumvention of technological measures to the extent such circumvention is effected by exercising rights under this License with respect to the covered work, and you disclaim any intention to limit operation or modification of the work as a means of enforcing, against the work’s users, your or third parties’ legal rights to forbid circumvention of technological measures.

#### 4. Conveying Verbatim Copies.

You may convey verbatim copies of the Program’s source code as you receive it, in any medium, provided that you conspicuously and appropriately publish on each copy an appropriate copyright notice; keep intact all notices stating that this License and any non-permissive terms added in accord with section 7 apply to the code; keep intact all notices of the absence of any warranty; and give all recipients a copy of this License along with the Program.

You may charge any price or no price for each copy that you convey, and you may offer support or warranty protection for a fee.

#### 5. Conveying Modified Source Versions.

You may convey a work based on the Program, or the modifications to produce it from the Program, in the form of source code under the terms of section 4, provided that you also meet all of these conditions:

- a) The work must carry prominent notices stating that you modified it, and giving a relevant date.
- b) The work must carry prominent notices stating that it is released under this License and any conditions added under section 7. This requirement modifies the requirement in section 4 to “keep intact all notices”.

- c) You must license the entire work, as a whole, under this License to anyone who comes into possession of a copy. This License will therefore apply, along with any applicable section 7 additional terms, to the whole of the work, and all its parts, regardless of how they are packaged. This License gives no permission to license the work in any other way, but it does not invalidate such permission if you have separately received it.
- d) If the work has interactive user interfaces, each must display Appropriate Legal Notices; however, if the Program has interactive interfaces that do not display Appropriate Legal Notices, your work need not make them do so.

A compilation of a covered work with other separate and independent works, which are not by their nature extensions of the covered work, and which are not combined with it such as to form a larger program, in or on a volume of a storage or distribution medium, is called an “aggregate” if the compilation and its resulting copyright are not used to limit the access or legal rights of the compilation’s users beyond what the individual works permit. Inclusion of a covered work in an aggregate does not cause this License to apply to the other parts of the aggregate.

## 6. Conveying Non-Source Forms.

You may convey a covered work in object code form under the terms of sections 4 and 5, provided that you also convey the machine-readable Corresponding Source under the terms of this License, in one of these ways:

- a) Convey the object code in, or embodied in, a physical product (including a physical distribution medium), accompanied by the Corresponding Source fixed on a durable physical medium customarily used for software interchange.
- b) Convey the object code in, or embodied in, a physical product (including a physical distribution medium), accompanied by a written offer, valid for at least three years and valid for as long as you offer spare parts or customer support for that product model, to give anyone who possesses the object code either (1) a copy of the Corresponding Source for all the software in the product that is covered by this License, on a durable physical medium customarily used for software interchange, for a price no more than your reasonable cost of physically performing this conveying of source, or (2) access to copy the Corresponding Source from a network server at no charge.
- c) Convey individual copies of the object code with a copy of the written offer to provide the Corresponding Source. This alternative is allowed only occasionally and noncommercially, and only if you received the object code with such an offer, in accord with subsection 6b.
- d) Convey the object code by offering access from a designated place (gratis or for a charge), and offer equivalent access to the Corresponding Source in the same way through the same place at no further charge. You need not require recipients to copy the Corresponding Source along with the object code. If the place to copy the object code is a network server, the Corresponding Source may be on a different server (operated by you or a third party) that supports equivalent copying facilities, provided you maintain clear directions next to the object code saying where to find the Corresponding Source. Regardless of what server hosts the Corresponding Source, you remain obligated to ensure that it is available for as long as needed to satisfy these requirements.
- e) Convey the object code using peer-to-peer transmission, provided you inform other peers where the object code and Corresponding Source of the work are being offered to the general public at no charge under subsection 6d. A separable portion of the object code, whose source code is excluded from the Corresponding Source as a System Library, need not be included in conveying the object code work.

A “User Product” is either (1) a “consumer product”, which means any tangible personal property which is normally used for personal, family, or household purposes, or (2) anything designed or sold for incorporation into a dwelling. In determining whether a product is a consumer product, doubtful cases shall be resolved in favor of coverage. For a particular product received by a particular user, “normally used” refers to a typical or common use of that class of product, regardless of the status of the particular user or of the way in which the particular user actually uses, or expects or is expected to use, the product. A product is a consumer product regardless of whether the product has substantial commercial, industrial or non-consumer uses, unless such uses represent the only significant mode of use of the product.

“Installation Information” for a User Product means any methods, procedures, authorization keys, or other information required to install and execute modified versions of a covered work in that User Product from a modified version of its Corresponding Source. The information must suffice to ensure that the continued functioning of the modified object code is in no case prevented or interfered with solely because modification has been made.

If you convey an object code work under this section in, or with, or specifically for use in, a User Product, and the conveying occurs as part of a transaction in which the right of possession and use of the User Product is transferred to the recipient in perpetuity or for a fixed term (regardless of how the transaction is characterized), the Corresponding Source conveyed under this section must be accompanied by the Installation Information. But this requirement does not apply if neither you nor any third party retains the ability to install modified object code on the User Product (for example, the work has been installed in ROM).

The requirement to provide Installation Information does not include a requirement to continue to provide support service, warranty, or updates for a work that has been modified or installed by the recipient, or for the User Product in which it has been modified or installed. Access to a network may be denied when the modification itself materially and adversely affects the operation of the network or violates the rules and protocols for communication across the network.

Corresponding Source conveyed, and Installation Information provided, in accord with this section must be in a format that is publicly documented (and with an implementation available to the public in source code form), and must require no special password or key for unpacking, reading or copying.

## 7. Additional Terms.

“Additional permissions” are terms that supplement the terms of this License by making exceptions from one or more of its conditions. Additional permissions that are applicable to the entire Program shall be treated as though they were included in this License, to the extent that they are valid under applicable law. If additional permissions apply only to part of the Program, that part may be used separately under those permissions, but the entire Program remains governed by this License without regard to the additional permissions.

When you convey a copy of a covered work, you may at your option remove any additional permissions from that copy, or from any part of it. (Additional permissions may be written to require their own removal in certain cases when you modify the work.) You may place additional permissions on material, added by you to a covered work, for which you have or can give appropriate copyright permission.

Notwithstanding any other provision of this License, for material you add to a covered work, you may (if authorized by the copyright holders of that material) supplement the terms of this License with terms:

- a) Disclaiming warranty or limiting liability differently from the terms of sections 15 and 16 of this License; or
- b) Requiring preservation of specified reasonable legal notices or author attributions in that material or in the Appropriate Legal Notices displayed by works containing it; or
- c) Prohibiting misrepresentation of the origin of that material, or requiring that modified versions of such material be marked in reasonable ways as different from the original version; or
- d) Limiting the use for publicity purposes of names of licensors or authors of the material; or
- e) Declining to grant rights under trademark law for use of some trade names, trademarks, or service marks; or
- f) Requiring indemnification of licensors and authors of that material by anyone who conveys the material (or modified versions of it) with contractual assumptions of liability to the recipient, for any liability that these contractual assumptions directly impose on those licensors and authors.

All other non-permissive additional terms are considered “further restrictions” within the meaning of section 10. If the Program as you received it, or any part of it, contains a notice stating that it is governed by this License along with a term that is a further restriction, you may remove that term. If a license document contains a further restriction but permits relicensing or conveying under this License, you may add to a covered work material governed by the terms of that license document, provided that the further restriction does not survive such relicensing or conveying.

If you add terms to a covered work in accord with this section, you must place, in the relevant source files, a statement of the additional terms that apply to those files, or a notice indicating where to find the applicable terms.

Additional terms, permissive or non-permissive, may be stated in the form of a separately written license, or stated as exceptions; the above requirements apply either way.

#### 8. Termination.

You may not propagate or modify a covered work except as expressly provided under this License. Any attempt otherwise to propagate or modify it is void, and will automatically terminate your rights under this License (including any patent licenses granted under the third paragraph of section 11).

However, if you cease all violation of this License, then your license from a particular copyright holder is reinstated (a) provisionally, unless and until the copyright holder explicitly and finally terminates your license, and (b) permanently, if the copyright holder fails to notify you of the violation by some reasonable means prior to 60 days after the cessation.

Moreover, your license from a particular copyright holder is reinstated permanently if the copyright holder notifies you of the violation by some reasonable means, this is the first time you have received notice of violation of this License (for any work) from that copyright holder, and you cure the violation prior to 30 days after your receipt of the notice.

Termination of your rights under this section does not terminate the licenses of parties who have received copies or rights from you under this License. If your rights have been terminated and not permanently reinstated, you do not qualify to receive new licenses for the same material under section 10.

#### 9. Acceptance Not Required for Having Copies.

You are not required to accept this License in order to receive or run a copy of the Program. Ancillary propagation of a covered work occurring solely as a consequence of using peer-to-peer transmission to receive a copy likewise does not require acceptance. However, nothing other than this License grants you permission to propagate or modify any covered work. These actions infringe copyright if you do not accept this License. Therefore, by modifying or propagating a covered work, you indicate your acceptance of this License to do so.

#### 10. Automatic Licensing of Downstream Recipients.

Each time you convey a covered work, the recipient automatically receives a license from the original licensors, to run, modify and propagate that work, subject to this License. You are not responsible for enforcing compliance by third parties with this License.

An “entity transaction” is a transaction transferring control of an organization, or substantially all assets of one, or subdividing an organization, or merging organizations. If propagation of a covered work results from an entity transaction, each party to that transaction who receives a copy of the work also receives whatever licenses to the work the party's predecessor in interest had or could give under the previous paragraph, plus a right to possession of the Corresponding Source of the work from the predecessor in interest, if the predecessor has it or can get it with reasonable efforts.

You may not impose any further restrictions on the exercise of the rights granted or affirmed under this License. For example, you may not impose a license fee, royalty, or other charge for exercise of rights granted under this License, and you may not initiate litigation (including a cross-claim or counterclaim in a lawsuit) alleging that any patent claim is infringed by making, using, selling, offering for sale, or importing the Program or any portion of it.

#### 11. Patents.

A “contributor” is a copyright holder who authorizes use under this License of the Program or a work on which the Program is based. The work thus licensed is called the contributor's “contributor version”.

A contributor's “essential patent claims” are all patent claims owned or controlled by the contributor, whether already acquired or hereafter acquired, that would be infringed by some manner, permitted by this License, of making, using, or selling its contributor version, but do not include claims that would be infringed only as a consequence of further modification of the contributor version. For purposes of this definition, “control” includes the right to grant patent sublicenses in a manner consistent with the requirements of this License.



Each contributor grants you a non-exclusive, worldwide, royalty-free patent license under the contributor's essential patent claims, to make, use, sell, offer for sale, import and otherwise run, modify and propagate the contents of its contributor version. In the following three paragraphs, a "patent license" is any express agreement or commitment, however denominated, not to enforce a patent (such as an express permission to practice a patent or covenant not to sue for patent infringement). To "grant" such a patent license to a party means to make such an agreement or commitment not to enforce a patent against the party.

If you convey a covered work, knowingly relying on a patent license, and the Corresponding Source of the work is not available for anyone to copy, free of charge and under the terms of this License, through a publicly available network server or other readily accessible means, then you must either (1) cause the Corresponding Source to be so available, or (2) arrange to deprive yourself of the benefit of the patent license for this particular work, or (3) arrange, in a manner consistent with the requirements of this License, to extend the patent license to downstream recipients. "Knowingly relying" means you have actual knowledge that, but for the patent license, your conveying the covered work in a country, or your recipient's use of the covered work in a country, would infringe one or more identifiable patents in that country that you have reason to believe are valid.

If, pursuant to or in connection with a single transaction or arrangement, you convey, or propagate by procuring conveyance of, a covered work, and grant a patent license to some of the parties receiving the covered work authorizing them to use, propagate, modify or convey a specific copy of the covered work, then the patent license you grant is automatically extended to all recipients of the covered work and works based on it.

A patent license is "discriminatory" if it does not include within the scope of its coverage, prohibits the exercise of, or is conditioned on the non-exercise of one or more of the rights that are specifically granted under this License. You may not convey a covered work if you are a party to an arrangement with a third party that is in the business of distributing software, under which you make payment to the third party based on the extent of your activity of conveying the work, and under which the third party grants, to any of the parties who would receive the covered work from you, a discriminatory patent license (a) in connection with copies of the covered work conveyed by you (or copies made from those copies), or (b) primarily for and in connection with specific products or compilations that contain the covered work, unless you entered into that arrangement, or that patent license was granted, prior to 28 March 2007.

Nothing in this License shall be construed as excluding or limiting any implied license or other defenses to infringement that may otherwise be available to you under applicable patent law.

#### **12. No Surrender of Others' Freedom.**

If conditions are imposed on you (whether by court order, agreement or otherwise) that contradict the conditions of this License, they do not excuse you from the conditions of this License. If you cannot convey a covered work so as to satisfy simultaneously your obligations under this License and any other pertinent obligations, then as a consequence you may not convey it at all. For example, if you agree to terms that obligate you to collect a royalty for further conveying from those to whom you convey the Program, the only way you could satisfy both those terms and this License would be to refrain entirely from conveying the Program.

#### **13. Use with the GNU Affero General Public License.**

Notwithstanding any other provision of this License, you have permission to link or combine any covered work with a work licensed under version 3 of the GNU Affero General Public License into a single combined work, and to convey the resulting work. The terms of this License will continue to apply to the part which is the covered work, but the special requirements of the GNU Affero General Public License, section 13, concerning interaction through a network will apply to the combination as such.

#### **14. Revised Versions of this License.**

The Free Software Foundation may publish revised and/or new versions of the GNU General Public License from time to time. Such new versions will be similar in spirit to the present version, but may differ in detail to address new problems or concerns.

Each version is given a distinguishing version number. If the Program specifies that a certain numbered version of the GNU General Public License "or any later version" applies to it, you have the option of following the terms and conditions either of that numbered version or of any later version published by the Free Software Foundation. If the Program does not specify a version number of the GNU General Public License, you may choose any version ever published by the Free Software Foundation.

If the Program specifies that a proxy can decide which future versions of the GNU General Public License can be used, that proxy's public statement of acceptance of a version permanently authorizes you to choose that version for the Program.

Later license versions may give you additional or different permissions. However, no additional obligations are imposed on any author or copyright holder as a result of your choosing to follow a later version.

#### **15. Disclaimer of Warranty.**

THERE IS NO WARRANTY FOR THE PROGRAM, TO THE EXTENT PERMITTED BY APPLICABLE LAW. EXCEPT WHEN OTHERWISE STATED IN WRITING THE COPYRIGHT HOLDERS AND/OR OTHER PARTIES PROVIDE THE PROGRAM "AS IS" WITHOUT WARRANTY OF ANY KIND, EITHER EXPRESSED OR IMPLIED, INCLUDING, BUT NOT LIMITED TO, THE IMPLIED WARRANTIES OF MERCHANTABILITY AND FITNESS FOR A PARTICULAR PURPOSE. THE ENTIRE RISK AS TO THE QUALITY AND PERFORMANCE OF THE PROGRAM IS WITH YOU. SHOULD THE PROGRAM PROVE DEFECTIVE, YOU ASSUME THE COST OF ALL NECESSARY SERVICING, REPAIR OR CORRECTION.

#### **16. Limitation of Liability.**

IN NO EVENT UNLESS REQUIRED BY APPLICABLE LAW OR AGREED TO IN WRITING WILL ANY COPYRIGHT HOLDER, OR ANY OTHER PARTY WHO MODIFIES AND/OR CONVEYS THE PROGRAM AS PERMITTED ABOVE, BE LIABLE TO YOU FOR DAMAGES, INCLUDING ANY GENERAL, SPECIAL, INCIDENTAL OR CONSEQUENTIAL DAMAGES ARISING OUT OF THE USE OR INABILITY TO USE THE PROGRAM (INCLUDING BUT NOT LIMITED TO LOSS OF DATA OR DATA BEING RENDERED INACCURATE OR LOSSES SUSTAINED BY YOU OR THIRD PARTIES OR A FAILURE OF THE PROGRAM TO OPERATE WITH ANY OTHER PROGRAMS), EVEN IF SUCH HOLDER OR OTHER PARTY HAS BEEN ADVISED OF THE POSSIBILITY OF SUCH DAMAGES.

## 17. Interpretation of Sections 15 and 16.

If the disclaimer of warranty and limitation of liability provided above cannot be given local legal effect according to their terms, reviewing courts shall apply local law that most closely approximates an absolute waiver of all civil liability in connection with the Program, unless a warranty or assumption of liability accompanies a copy of the Program in return for a fee.

## END OF TERMS AND CONDITIONS

---

### How to Apply These Terms to Your New Programs

If you develop a new program, and you want it to be of the greatest possible use to the public, the best way to achieve this is to make it free software which everyone can redistribute and change under these terms.

To do so, attach the following notices to the program. It is safest to attach them to the start of each source file to most effectively state the exclusion of warranty; and each file should have at least the "copyright" line and a pointer to where the full notice is found.

<one line to give the program's name and a brief idea of what it does.> Copyright (C) <year> <name of author>

This program is free software: you can redistribute it and/or modify it under the terms of the GNU General Public License as published by the Free Software Foundation, either version 3 of the License, or (at your option) any later version.

This program is distributed in the hope that it will be useful, but WITHOUT ANY WARRANTY; without even the implied warranty of MERCHANTABILITY or FITNESS FOR A PARTICULAR PURPOSE. See the GNU General Public License for more details.

You should have received a copy of the GNU General Public License along with this program. If not, see <<http://www.gnu.org/licenses/>>.

Also add information on how to contact you by electronic and paper mail.

If the program does terminal interaction, make it output a short notice like this when it starts in an interactive mode:

<program> Copyright (C) <year> <name of author> This program comes with ABSOLUTELY NO WARRANTY; for details type `show w'. This is free software, and you are welcome to redistribute it under certain conditions; type `show c' for details.

The hypothetical commands `show w' and `show c' should show the appropriate parts of the General Public License. Of course, your program's commands might be different; for a GUI interface, you would use an "about box".

You should also get your employer (if you work as a programmer) or school, if any, to sign a "copyright disclaimer" for the program, if necessary.

For more information on this, and how to apply and follow the GNU GPL, see <<http://www.gnu.org/licenses/>>.

The GNU General Public License does not permit incorporating your program into proprietary programs. If your program is a subroutine library, you may consider it more useful to permit linking proprietary applications with the library. If this is what you want to do, use the GNU Lesser General Public License instead of this License. But first, please read <<http://www.gnu.org/philosophy/why-not-lgpl.html>>.

# GNU Lesser General Public License (LGPL)

---

Version 3, 29 June 2007

Copyright (C) 2007 Free Software Foundation, Inc. <<http://fsf.org/>>

Everyone is permitted to copy and distribute verbatim copies of this license document, but changing it is not allowed.

## Preamble

The GNU General Public License is a free, copyleft license for software and other kinds of works.

The licenses for most software and other practical works are designed to take away your freedom to share and change the works. By contrast, the GNU General Public License is intended to guarantee your freedom to share and change all versions of a program--to make sure it remains free software for all its users. We, the Free Software Foundation, use the GNU General Public License for most of our software; it applies also to any other work released this way by its authors. You can apply it to your programs, too.

When we speak of free software, we are referring to freedom, not price. Our General Public Licenses are designed to make sure that you have the freedom to distribute copies of free software (and charge for them if you wish), that you receive source code or can get it if you want it, that you can change the software or use pieces of it in new free programs, and that you know you can do these things.

To protect your rights, we need to prevent others from denying you these rights or asking you to surrender the rights. Therefore, you have certain responsibilities if you distribute copies of the software, or if you modify it: responsibilities to respect the freedom of others.

For example, if you distribute copies of such a program, whether gratis or for a fee, you must pass on to the recipients the same freedoms that you received. You must make sure that they, too, receive or can get the source code. And you must show them these terms so they know their rights.

Developers that use the GNU GPL protect your rights with two steps: (1) assert copyright on the software, and (2) offer you this License giving you legal permission to copy, distribute and/or modify it.

For the developers' and authors' protection, the GPL clearly explains that there is no warranty for this free software. For both users' and authors' sake, the GPL requires that modified versions be marked as changed, so that their problems will not be attributed erroneously to authors of previous versions.

Some devices are designed to deny users access to install or run modified versions of the software inside them, although the manufacturer can do so. This is fundamentally incompatible with the aim of protecting users' freedom to change the software. The systematic pattern of such abuse occurs in the area of products for individuals to use, which is precisely where it is most unacceptable. Therefore, we have designed this version of the GPL to prohibit the practice for those products. If such problems arise substantially in other domains, we stand ready to extend this provision to those domains in future versions of the GPL, as needed to protect the freedom of users.

Finally, every program is threatened constantly by software patents. States should not allow patents to restrict development and use of software on general-purpose computers, but in those that do, we wish to avoid the special danger that patents applied to a free program could make it effectively proprietary. To prevent this, the GPL assures that patents cannot be used to render the program non-free.

The precise terms and conditions for copying, distribution and modification follow.

## TERMS AND CONDITIONS

### 0. Definitions.

"This License" refers to version 3 of the GNU General Public License.

"Copyright" also means copyright-like laws that apply to other kinds of works, such as semiconductor masks.

"The Program" refers to any copyrightable work licensed under this License. Each licensee is addressed as "you". "Licensees" and "recipients" may be individuals or organizations.

To "modify" a work means to copy from or adapt all or part of the work in a fashion requiring copyright permission, other than the making of an exact copy. The resulting work is called a "modified version" of the earlier work or a work "based on" the earlier work.

A "covered work" means either the unmodified Program or a work based on the Program.

To "propagate" a work means to do anything with it that, without permission, would make you directly or secondarily liable for infringement under applicable copyright law, except executing it on a computer or modifying a private copy. Propagation includes copying, distribution (with or without modification), making available to the public, and in some countries other activities as well.

To "convey" a work means any kind of propagation that enables other parties to make or receive copies. Mere interaction with a user through a computer network, with no transfer of a copy, is not conveying.

An interactive user interface displays "Appropriate Legal Notices" to the extent that it includes a convenient and prominently visible feature that (1) displays an appropriate copyright notice, and (2) tells the user that there is no warranty for the work (except to the extent that warranties are provided), that licensees may convey the work under this License, and how to view a copy of this License. If the interface presents a list of user commands or options, such as a menu, a prominent item in the list meets this criterion.

## 1. Source Code.

The "source code" for a work means the preferred form of the work for making modifications to it. "Object code" means any non-source form of a work.

A "Standard Interface" means an interface that either is an official standard defined by a recognized standards body, or, in the case of interfaces specified for a particular programming language, one that is widely used among developers working in that language.

The "System Libraries" of an executable work include anything, other than the work as a whole, that (a) is included in the normal form of packaging a Major Component, but which is not part of that Major Component, and (b) serves only to enable use of the work with that Major Component, or to implement a Standard Interface for which an implementation is available to the public in source code form. A "Major Component", in this context, means a major essential component (kernel, window system, and so on) of the specific operating system (if any) on which the executable work runs, or a compiler used to produce the work, or an object code interpreter used to run it.

The "Corresponding Source" for a work in object code form means all the source code needed to generate, install, and (for an executable work) run the object code and to modify the work, including scripts to control those activities. However, it does not include the work's System Libraries, or general-purpose tools or generally available free programs which are used unmodified in performing those activities but which are not part of the work. For example, Corresponding Source includes interface definition files associated with source files for the work, and the source code for shared libraries and dynamically linked subprograms that the work is specifically designed to require, such as by intimate data communication or control flow between those subprograms and other parts of the work.

The Corresponding Source need not include anything that users can regenerate automatically from other parts of the Corresponding Source.

The Corresponding Source for a work in source code form is that same work.

## 2. Basic Permissions.

All rights granted under this License are granted for the term of copyright on the Program, and are irrevocable provided the stated conditions are met. This License explicitly affirms your unlimited permission to run the unmodified Program. The output from running a covered work is covered by this License only if the output, given its content, constitutes a covered work.

This License acknowledges your rights of fair use or other equivalent, as provided by copyright law. You may make, run and propagate covered works that you do not convey, without conditions so long as your license otherwise remains in force. You may convey covered works to others for the sole purpose of having them make modifications exclusively for you, or provide you with facilities for running those works, provided that you comply with the terms of this License in conveying all material for which you do not control copyright. Those thus making or running the covered works for you must do so exclusively on your behalf, under your direction and control, on terms that prohibit them from making any copies of your copyrighted material outside their relationship with you.

Conveying under any other circumstances is permitted solely under the conditions stated below. Sublicensing is not allowed; section 10 makes it unnecessary.

## 3. Protecting Users' Legal Rights From Anti-Circumvention Law.

No covered work shall be deemed part of an effective technological measure under any applicable law fulfilling obligations under article 11 of the WIPO copyright treaty adopted on 20 December 1996, or similar laws prohibiting or restricting circumvention of such measures.

When you convey a covered work, you waive any legal power to forbid circumvention of technological measures to the extent such circumvention is effected by exercising rights under this License with respect to the covered work, and you disclaim any intention to limit operation or modification of the work as a means of enforcing, against the work's users, your or third parties' legal rights to forbid circumvention of technological measures.

## 4. Conveying Verbatim Copies.

You may convey verbatim copies of the Program's source code as you receive it, in any medium, provided that you conspicuously and appropriately publish on each copy an appropriate copyright notice; keep intact all notices stating that this License and any non-permissive terms added in accord with section 7 apply to the code; keep intact all notices of the absence of any warranty; and give all recipients a copy of this License along with the Program.

You may charge any price or no price for each copy that you convey, and you may offer support or warranty protection for a fee.

## 5. Conveying Modified Source Versions.

You may convey a work based on the Program, or the modifications to produce it from the Program, in the form of source code under the terms of section 4, provided that you also meet all of these conditions:

- a) The work must carry prominent notices stating that you modified it, and giving a relevant date.
- b) The work must carry prominent notices stating that it is released under this License and any conditions added under section 7. This requirement modifies the requirement in section 4 to "keep intact all notices".
- c) You must license the entire work, as a whole, under this License to anyone who comes into possession of a copy. This License will therefore apply, along with any applicable section 7 additional terms, to the whole of the work, and all its parts, regardless of how they are packaged. This License gives no permission to license the work in any other way, but it does not invalidate such permission if you have separately received it.
- d) If the work has interactive user interfaces, each must display Appropriate Legal Notices; however, if the Program has interactive interfaces that do not display Appropriate Legal Notices, your work need not make them do so.

A compilation of a covered work with other separate and independent works, which are not by their nature extensions of the covered work, and which are not combined with it such as to form a larger program, in or on a volume of a storage or distribution medium, is called an "aggregate" if the compilation and its resulting copyright are not used to limit the access or legal rights of the compilation's users beyond what the individual works permit. Inclusion of a covered work in an aggregate does not cause this License to apply to the other parts of the aggregate.

## 6. Conveying Non-Source Forms.

You may convey a covered work in object code form under the terms of sections 4 and 5, provided that you also convey the machine-readable Corresponding Source under the terms of this License, in one of these ways:

- a) Convey the object code in, or embodied in, a physical product (including a physical distribution medium), accompanied by the Corresponding Source fixed on a durable physical medium customarily used for software interchange.
- b) Convey the object code in, or embodied in, a physical product (including a physical distribution medium), accompanied by a written offer, valid for at least three years and valid for as long as you offer spare parts or customer support for that product model, to give anyone who possesses the object code either (1) a copy of the Corresponding Source for all the software in the product that is covered by this License, on a durable physical medium customarily used for software interchange, for a price no more than your reasonable cost of physically performing this conveying of source, or (2) access to copy the Corresponding Source from a network server at no charge.
- c) Convey individual copies of the object code with a copy of the written offer to provide the Corresponding Source. This alternative is allowed only occasionally and noncommercially, and only if you received the object code with such an offer, in accord with subsection 6b.
- d) Convey the object code by offering access from a designated place (gratis or for a charge), and offer equivalent access to the Corresponding Source in the same way through the same place at no further charge. You need not require recipients to copy the Corresponding Source along with the object code. If the place to copy the object code is a network server, the Corresponding Source may be on a different server (operated by you or a third party) that supports equivalent copying facilities, provided you maintain clear directions next to the object code saying where to find the Corresponding Source. Regardless of what server hosts the Corresponding Source, you remain obligated to ensure that it is available for as long as needed to satisfy these requirements.
- e) Convey the object code using peer-to-peer transmission, provided you inform other peers where the object code and Corresponding Source of the work are being offered to the general public at no charge under subsection 6d. A separable portion of the object code, whose source code is excluded from the Corresponding Source as a System Library, need not be included in conveying the object code work.

A "User Product" is either (1) a "consumer product", which means any tangible personal property which is normally used for personal, family, or household purposes, or (2) anything designed or sold for incorporation into a dwelling. In determining whether a product is a consumer product, doubtful cases shall be resolved in favor of coverage. For a particular product received by a particular user, "normally used" refers to a typical or common use of that class of product, regardless of the status of the particular user or of the way in which the particular user actually uses, or expects or is expected to use, the product. A product is a consumer product regardless of whether the product has substantial commercial, industrial or non-consumer uses, unless such uses represent the only significant mode of use of the product.

"Installation Information" for a User Product means any methods, procedures, authorization keys, or other information required to install and execute modified versions of a covered work in that User Product from a modified version of its Corresponding Source. The information must suffice to ensure that the continued functioning of the modified object code is in no case prevented or interfered with solely because modification has been made.

If you convey an object code work under this section in, or with, or specifically for use in, a User Product, and the conveying occurs as part of a transaction in which the right of possession and use of the User Product is transferred to the recipient in perpetuity or for a fixed term (regardless of how the transaction is characterized), the Corresponding Source conveyed under this section must be accompanied by the Installation Information. But this requirement does not apply if neither you nor any third party retains the ability to install modified object code on the User Product (for example, the work has been installed in ROM).

The requirement to provide Installation Information does not include a requirement to continue to provide support service, warranty, or updates for a work that has been modified or installed by the recipient, or for the User Product in which it has been modified or installed. Access to a network may be denied when the modification itself materially and adversely affects the operation of the network or violates the rules and protocols for communication across the network.

Corresponding Source conveyed, and Installation Information provided, in accord with this section must be in a format that is publicly documented (and with an implementation available to the public in source code form), and must require no special password or key for unpacking, reading or copying.

## 7. Additional Terms.

"Additional permissions" are terms that supplement the terms of this License by making exceptions from one or more of its conditions. Additional permissions that are applicable to the entire Program shall be treated as though they were included in this License, to the extent that they are valid under applicable law. If additional permissions apply only to part of the Program, that part may be used separately under those permissions, but the entire Program remains governed by this License without regard to the additional permissions.

When you convey a copy of a covered work, you may at your option remove any additional permissions from that copy, or from any part of it. (Additional permissions may be written to require their own removal in certain cases when you modify the work.) You may place additional permissions on material, added by you to a covered work, for which you have or can give appropriate copyright permission.

Notwithstanding any other provision of this License, for material you add to a covered work, you may (if authorized by the copyright holders of that material) supplement the terms of this License with terms:

- a) Disclaiming warranty or limiting liability differently from the terms of sections 15 and 16 of this License; or
- b) Requiring preservation of specified reasonable legal notices or author attributions in that material or in the Appropriate Legal Notices displayed by works containing it; or
- c) Prohibiting misrepresentation of the origin of that material, or requiring that modified versions of such material be marked in reasonable ways as different from the original version; or
- d) Limiting the use for publicity purposes of names of licensors or authors of the material; or
- e) Declining to grant rights under trademark law for use of some trade names, trademarks, or service marks; or
- f) Requiring indemnification of licensors and authors of that material by anyone who conveys the material (or modified versions of it) with contractual assumptions of liability to the recipient, for any liability that these contractual assumptions directly impose on those licensors and authors.

All other non-permissive additional terms are considered “further restrictions” within the meaning of section 10. If the Program as you received it, or any part of it, contains a notice stating that it is governed by this License along with a term that is a further restriction, you may remove that term. If a license document contains a further restriction but permits relicensing or conveying under this License, you may add to a covered work material governed by the terms of that license document, provided that the further restriction does not survive such relicensing or conveying.

If you add terms to a covered work in accord with this section, you must place, in the relevant source files, a statement of the additional terms that apply to those files, or a notice indicating where to find the applicable terms.

Additional terms, permissive or non-permissive, may be stated in the form of a separately written license, or stated as exceptions; the above requirements apply either way.

#### 8. Termination.

You may not propagate or modify a covered work except as expressly provided under this License. Any attempt otherwise to propagate or modify it is void, and will automatically terminate your rights under this License (including any patent licenses granted under the third paragraph of section 11).

However, if you cease all violation of this License, then your license from a particular copyright holder is reinstated (a) provisionally, unless and until the copyright holder explicitly and finally terminates your license, and (b) permanently, if the copyright holder fails to notify you of the violation by some reasonable means prior to 60 days after the cessation.

Moreover, your license from a particular copyright holder is reinstated permanently if the copyright holder notifies you of the violation by some reasonable means, this is the first time you have received notice of violation of this License (for any work) from that copyright holder, and you cure the violation prior to 30 days after your receipt of the notice.

Termination of your rights under this section does not terminate the licenses of parties who have received copies or rights from you under this License. If your rights have been terminated and not permanently reinstated, you do not qualify to receive new licenses for the same material under section 10.

#### 9. Acceptance Not Required for Having Copies.

You are not required to accept this License in order to receive or run a copy of the Program. Ancillary propagation of a covered work occurring solely as a consequence of using peer-to-peer transmission to receive a copy likewise does not require acceptance. However, nothing other than this License grants you permission to propagate or modify any covered work. These actions infringe copyright if you do not accept this License. Therefore, by modifying or propagating a covered work, you indicate your acceptance of this License to do so.

#### 10. Automatic Licensing of Downstream Recipients.

Each time you convey a covered work, the recipient automatically receives a license from the original licensors, to run, modify and propagate that work, subject to this License. You are not responsible for enforcing compliance by third parties with this License.

An “entity transaction” is a transaction transferring control of an organization, or substantially all assets of one, or subdividing an organization, or merging organizations. If propagation of a covered work results from an entity transaction, each party to that transaction who receives a copy of the work also receives whatever licenses to the work the party’s predecessor in interest had or could give under the previous paragraph, plus a right to possession of the Corresponding Source of the work from the predecessor in interest, if the predecessor has it or can get it with reasonable efforts.

You may not impose any further restrictions on the exercise of the rights granted or affirmed under this License. For example, you may not impose a license fee, royalty, or other charge for exercise of rights granted under this License, and you may not initiate litigation (including a cross-claim or counterclaim in a lawsuit) alleging that any patent claim is infringed by making, using, selling, offering for sale, or importing the Program or any portion of it.

#### 11. Patents.

A “contributor” is a copyright holder who authorizes use under this License of the Program or a work on which the Program is based. The work thus licensed is called the contributor’s “contributor version”.

A contributor’s “essential patent claims” are all patent claims owned or controlled by the contributor, whether already acquired or hereafter acquired, that would be infringed by some manner, permitted by this License, of making, using, or selling its contributor version, but do not include claims that would be infringed only as a consequence of further modification of the contributor version. For purposes of this definition, “control” includes the right to grant patent sublicenses in a manner consistent with the requirements of this License.

Each contributor grants you a non-exclusive, worldwide, royalty-free patent license under the contributor’s essential patent claims, to make, use, sell, offer for sale, import and otherwise run, modify and propagate the contents of its contributor version. In the following three paragraphs, a “patent license” is any express agreement or commitment, however denominated, not to enforce a patent (such as an express permission to practice a patent or covenant not to sue for patent infringement). To “grant” such a patent license to a party means to make such an agreement or commitment not to enforce a patent against the party.

If you convey a covered work, knowingly relying on a patent license, and the Corresponding Source of the work is not available for anyone to copy, free of charge and under the terms of this License, through a publicly available network server or other readily accessible means, then you must either (1) cause the Corresponding Source to be so available, or (2) arrange to deprive yourself of the benefit of the patent license for this particular work, or (3) arrange, in a manner consistent with the requirements of this License, to extend the patent license to downstream recipients. "Knowingly relying" means you have actual knowledge that, but for the patent license, your conveying the covered work in a country, or your recipient's use of the covered work in a country, would infringe one or more identifiable patents in that country that you have reason to believe are valid.

If, pursuant to or in connection with a single transaction or arrangement, you convey, or propagate by procuring conveyance of, a covered work, and grant a patent license to some of the parties receiving the covered work authorizing them to use, propagate, modify or convey a specific copy of the covered work, then the patent license you grant is automatically extended to all recipients of the covered work and works based on it.

A patent license is "discriminatory" if it does not include within the scope of its coverage, prohibits the exercise of, or is conditioned on the non-exercise of one or more of the rights that are specifically granted under this License. You may not convey a covered work if you are a party to an arrangement with a third party that is in the business of distributing software, under which you make payment to the third party based on the extent of your activity of conveying the work, and under which the third party grants, to any of the parties who would receive the covered work from you, a discriminatory patent license (a) in connection with copies of the covered work conveyed by you (or copies made from those copies), or (b) primarily for and in connection with specific products or compilations that contain the covered work, unless you entered into that arrangement, or that patent license was granted, prior to 28 March 2007.

Nothing in this License shall be construed as excluding or limiting any implied license or other defenses to infringement that may otherwise be available to you under applicable patent law.

**12. No Surrender of Others' Freedom.**

If conditions are imposed on you (whether by court order, agreement or otherwise) that contradict the conditions of this License, they do not excuse you from the conditions of this License. If you cannot convey a covered work so as to satisfy simultaneously your obligations under this License and any other pertinent obligations, then as a consequence you may not convey it at all. For example, if you agree to terms that obligate you to collect a royalty for further conveying from those to whom you convey the Program, the only way you could satisfy both those terms and this License would be to refrain entirely from conveying the Program.

**13. Use with the GNU Affero General Public License.**

Notwithstanding any other provision of this License, you have permission to link or combine any covered work with a work licensed under version 3 of the GNU Affero General Public License into a single combined work, and to convey the resulting work. The terms of this License will continue to apply to the part which is the covered work, but the special requirements of the GNU Affero General Public License, section 13, concerning interaction through a network will apply to the combination as such.

**14. Revised Versions of this License.**

The Free Software Foundation may publish revised and/or new versions of the GNU General Public License from time to time. Such new versions will be similar in spirit to the present version, but may differ in detail to address new problems or concerns. Each version is given a distinguishing version number. If the Program specifies that a certain numbered version of the GNU General Public License "or any later version" applies to it, you have the option of following the terms and conditions either of that numbered version or of any later version published by the Free Software Foundation. If the Program does not specify a version number of the GNU General Public License, you may choose any version ever published by the Free Software Foundation.

If the Program specifies that a proxy can decide which future versions of the GNU General Public License can be used, that proxy's public statement of acceptance of a version permanently authorizes you to choose that version for the Program.

Later license versions may give you additional or different permissions. However, no additional obligations are imposed on any author or copyright holder as a result of your choosing to follow a later version.

**15. Disclaimer of Warranty.**

THERE IS NO WARRANTY FOR THE PROGRAM, TO THE EXTENT PERMITTED BY APPLICABLE LAW. EXCEPT WHEN OTHERWISE STATED IN WRITING THE COPYRIGHT HOLDERS AND/OR OTHER PARTIES PROVIDE THE PROGRAM "AS IS" WITHOUT WARRANTY OF ANY KIND, EITHER EXPRESSED OR IMPLIED, INCLUDING, BUT NOT LIMITED TO, THE IMPLIED WARRANTIES OF MERCHANTABILITY AND FITNESS FOR A PARTICULAR PURPOSE. THE ENTIRE RISK AS TO THE QUALITY AND PERFORMANCE OF THE PROGRAM IS WITH YOU. SHOULD THE PROGRAM PROVE DEFECTIVE, YOU ASSUME THE COST OF ALL NECESSARY SERVICING, REPAIR OR CORRECTION.

**16. Limitation of Liability.**

IN NO EVENT UNLESS REQUIRED BY APPLICABLE LAW OR AGREED TO IN WRITING WILL ANY COPYRIGHT HOLDER, OR ANY OTHER PARTY WHO MODIFIES AND/OR CONVEYS THE PROGRAM AS PERMITTED ABOVE, BE LIABLE TO YOU FOR DAMAGES, INCLUDING ANY GENERAL, SPECIAL, INCIDENTAL OR CONSEQUENTIAL DAMAGES ARISING OUT OF THE USE OR INABILITY TO USE THE PROGRAM (INCLUDING BUT NOT LIMITED TO LOSS OF DATA OR DATA BEING RENDERED INACCURATE OR LOSSES SUSTAINED BY YOU OR THIRD PARTIES OR A FAILURE OF THE PROGRAM TO OPERATE WITH ANY OTHER PROGRAMS), EVEN IF SUCH HOLDER OR OTHER PARTY HAS BEEN ADVISED OF THE POSSIBILITY OF SUCH DAMAGES.

**17. Interpretation of Sections 15 and 16.**

If the disclaimer of warranty and limitation of liability provided above cannot be given local legal effect according to their terms, reviewing courts shall apply local law that most closely approximates an absolute waiver of all civil liability in connection with the Program, unless a warranty or assumption of liability accompanies a copy of the Program in return for a fee.

## END OF TERMS AND CONDITIONS

---

### How to Apply These Terms to Your New Programs

If you develop a new program, and you want it to be of the greatest possible use to the public, the best way to achieve this is to make it free software which everyone can redistribute and change under these terms.

To do so, attach the following notices to the program. It is safest to attach them to the start of each source file to most effectively state the exclusion of warranty; and each file should have at least the "copyright" line and a pointer to where the full notice is found.

<one line to give the program's name and a brief idea of what it does.> Copyright (C) <year> <name of author>

This program is free software: you can redistribute it and/or modify it under the terms of the GNU General Public License as published by the Free Software Foundation, either version 3 of the License, or (at your option) any later version.

This program is distributed in the hope that it will be useful, but WITHOUT ANY WARRANTY; without even the implied warranty of MERCHANTABILITY or FITNESS FOR A PARTICULAR PURPOSE. See the GNU General Public License for more details.

You should have received a copy of the GNU General Public License along with this program. If not, see <<http://www.gnu.org/licenses/>>.

Also add information on how to contact you by electronic and paper mail.

If the program does terminal interaction, make it output a short notice like this when it starts in an interactive mode:

<program> Copyright (C) <year> <name of author> This program comes with ABSOLUTELY NO WARRANTY; for details type `show w'. This is free software, and you are welcome to redistribute it under certain conditions; type `show c' for details.

The hypothetical commands `show w' and `show c' should show the appropriate parts of the General Public License. Of course, your program's commands might be different; for a GUI interface, you would use an "about box".

You should also get your employer (if you work as a programmer) or school, if any, to sign a "copyright disclaimer" for the program, if necessary.

For more information on this, and how to apply and follow the GNU GPL, see <<http://www.gnu.org/licenses/>>.

The GNU General Public License does not permit incorporating your program into proprietary programs. If your program is a subroutine library, you may consider it more useful to permit linking proprietary applications with the library. If this is what you want to do, use the GNU Lesser General Public License instead of this License. But first, please read <<http://www.gnu.org/philosophy/why-not-lgpl.html>>.



## LICENSE ISSUES

---

The OpenSSL toolkit stays under a dual license, i.e. both the conditions of the OpenSSL License and the original SSLeay license apply to the toolkit. See below for the actual license texts. Actually both licenses are BSD-style Open Source licenses. In case of any license issues related to OpenSSL please contact [openssl-core@openssl.org](mailto:openssl-core@openssl.org).

### OpenSSL License

Copyright (c) 1998-2007 The OpenSSL Project. All rights reserved.

Redistribution and use in source and binary forms, with or without modification, are permitted provided that the following conditions are met:

1. Redistributions of source code must retain the above copyright notice, this list of conditions and the following disclaimer.
2. Redistributions in binary form must reproduce the above copyright notice, this list of conditions and the following disclaimer in the documentation and/or other materials provided with the distribution.
3. All advertising materials mentioning features or use of this software must display the following acknowledgment: "This product includes software developed by the OpenSSL Project for use in the OpenSSL Toolkit. (<http://www.openssl.org/>)"
4. The names "OpenSSL Toolkit" and "OpenSSL Project" must not be used to endorse or promote products derived from this software without prior written permission. For written permission, please contact [openssl-core@openssl.org](mailto:openssl-core@openssl.org).
5. Products derived from this software may not be called "OpenSSL" nor may "OpenSSL" appear in their names without prior written permission of the OpenSSL Project.
6. Redistributions of any form whatsoever must retain the following acknowledgment: "This product includes software developed by the OpenSSL Project for use in the OpenSSL Toolkit (<http://www.openssl.org/>)"

THIS SOFTWARE IS PROVIDED BY THE OpenSSL PROJECT "AS IS" AND ANY EXPRESSED OR IMPLIED WARRANTIES, INCLUDING, BUT NOT LIMITED TO, THE IMPLIED WARRANTIES OF MERCHANTABILITY AND FITNESS FOR A PARTICULAR PURPOSE ARE DISCLAIMED. IN NO EVENT SHALL THE OpenSSL PROJECT OR ITS CONTRIBUTORS BE LIABLE FOR ANY DIRECT, INDIRECT, INCIDENTAL, SPECIAL, EXEMPLARY, OR CONSEQUENTIAL DAMAGES (INCLUDING, BUT NOT LIMITED TO, PROCUREMENT OF SUBSTITUTE GOODS OR SERVICES; LOSS OF USE, DATA, OR PROFITS; OR BUSINESS INTERRUPTION) HOWEVER CAUSED AND ON ANY THEORY OF LIABILITY, WHETHER IN CONTRACT, STRICT LIABILITY, OR TORT (INCLUDING NEGLIGENCE OR OTHERWISE) ARISING IN ANY WAY OUT OF THE USE OF THIS SOFTWARE, EVEN IF ADVISED OF THE POSSIBILITY OF SUCH DAMAGE.

This product includes cryptographic software written by Eric Young ([ey@cryptsoft.com](mailto:ey@cryptsoft.com)). This product includes software written by Tim Hudson ([tjh@cryptsoft.com](mailto:tjh@cryptsoft.com)).

### Original SSLeay License

Copyright (C) 1995-1998 Eric Young ([ey@cryptsoft.com](mailto:ey@cryptsoft.com)) All rights reserved.

This package is an SSL implementation written by Eric Young ([ey@cryptsoft.com](mailto:ey@cryptsoft.com)). The implementation was written so as to conform with Netscapes SSL.

This library is free for commercial and non-commercial use as long as the following conditions are adhered to. The following conditions apply to all code found in this distribution, be it the RC4, RSA, lhash, DES, etc., code; not just the SSL code. The SSL documentation included with this distribution is covered by the same copyright terms except that the holder is Tim Hudson ([tjh@cryptsoft.com](mailto:tjh@cryptsoft.com)).

Copyright remains Eric Young's, and as such any Copyright notices in the code are not to be removed. If this package is used in a product, Eric Young should be given attribution as the author of the parts of the library used. This can be in the form of a textual message at program startup or in documentation (online or textual) provided with the package.

Redistribution and use in source and binary forms, with or without modification, are permitted provided that the following conditions are met:

1. Redistributions of source code must retain the copyright notice, this list of conditions and the following disclaimer.
2. Redistributions in binary form must reproduce the above copyright notice, this list of conditions and the following disclaimer in the documentation and/or other materials provided with the distribution.
3. All advertising materials mentioning features or use of this software must display the following acknowledgement: "This product includes cryptographic software written by Eric Young ([ey@cryptsoft.com](mailto:ey@cryptsoft.com))" The word 'cryptographic' can be left out if the routines from the library being used are not cryptographic related :-).
4. If you include any Windows specific code (or a derivative thereof) from the apps directory (application code) you must include an acknowledgement: "This product includes software written by Tim Hudson ([tjh@cryptsoft.com](mailto:tjh@cryptsoft.com))"

THIS SOFTWARE IS PROVIDED BY ERIC YOUNG "AS IS" AND ANY EXPRESS OR IMPLIED WARRANTIES, INCLUDING, BUT NOT LIMITED TO, THE IMPLIED WARRANTIES OF MERCHANTABILITY AND FITNESS FOR A PARTICULAR PURPOSE ARE DISCLAIMED. IN NO EVENT SHALL THE AUTHOR OR CONTRIBUTORS BE LIABLE FOR ANY DIRECT, INDIRECT, INCIDENTAL, SPECIAL, EXEMPLARY, OR CONSEQUENTIAL DAMAGES (INCLUDING, BUT NOT LIMITED TO, PROCUREMENT OF SUBSTITUTE GOODS OR SERVICES; LOSS OF USE, DATA, OR PROFITS; OR BUSINESS INTERRUPTION) HOWEVER CAUSED AND ON ANY THEORY OF LIABILITY, WHETHER IN CONTRACT, STRICT LIABILITY, OR TORT (INCLUDING NEGLIGENCE OR OTHERWISE) ARISING IN ANY WAY OUT OF THE USE OF THIS SOFTWARE, EVEN IF ADVISED OF THE POSSIBILITY OF SUCH DAMAGE.

The licence and distribution terms for any publically available version or derivative of this code cannot be changed. i.e. this code cannot simply be copied and put under another distribution licence [including the GNU Public Licence.]