



Use and Care Guide

Built-In Electric Oven



Safety instructions3, 4



Operating Instructions, Tips

| | |
|----------------------------------|-----------------------------|
| Aluminum Foil | 4, 12, 15, 17 |
| Features | 5 |
| Baking | 10-12 |
| Broiling, Broiling Guide | 17, 18 |
| Clock and Timers | 6, 7 |
| Control Panel | 6 |
| Fan..... | 8, 10, 12, 13, 15, 17,20,21 |
| Light; Bulb Replacement..... | 8, 23 |
| Preheating | 10 |
| Roasting, Roasting Guide..... | 15, 16 |
| Timed Baking | 12, 13 |
| Self-Cleaning Instructions | 19-22 |



Care and Cleaning.....23, 24

| | |
|----------------------------------|--------|
| Broiler Pan and Rack | 23 |
| Lift-Off Oven Door | 24 |
| Self-Cleaning Instructions | 19 -22 |
| Shelves | 23 |



Problem Solver.....25, 26

| | |
|--|----|
| Thermostat Adjustment- | |
| <i>Do It Yourself</i> | 14 |
| More questions ?...call | |
| <i>GE Answer Center</i> ™ 800.626.2000 | |



Consumer Services27

| | |
|--|------------|
| Appliance Registration | 2 |
| Important Phone Numbers | 27 |
| Model and Serial Number Location | 2 |
| Removal of Packaging Tape..... | 2 |
| Warranty | Back Cover |



HELP US HELP YOU...

Before using your oven, read this guide carefully.

It is **intended** to help you operate and maintain your new oven properly.

Keep it handy for answers to your questions.

If you don't understand something or need more help, call:

GE Answer Center™

800.626.2000

24 hours a day, 7 days a week

How to Remove Packaging Tape

To assure no damage is done to the finish of the product, the safest way to remove packaging tape adhesive on new appliances is an application of a household liquid **dishwashing** detergent, mineral oil or cooking oil. Apply with a soft cloth and allow to soak. Wipe dry and then apply an appliance polish to thoroughly clean and protect the surface.

NOTE: The plastic tape must be removed from the chrome trim on the oven parts. It cannot be removed if it is baked on.

Write down the model and serial numbers.

You'll find them on a label on the front of the oven behind the oven door.

These numbers are also on the Consumer Product Ownership Registration Card that came with your oven. Before sending in this card, please write these numbers here:

Model Number

Serial Number

Use these numbers in any correspondence or service calls concerning your oven.

Save time and money. Before you request service...

Check the Problem Solver in the back of this guide. It lists causes of minor operating problems that you can correct yourself.

IF YOU NEED SERVICE...

To obtain service, see the Consumer Services page in the back of this guide.

We're proud of our service and want you to be pleased. If for some reason you are not happy with the service you receive, here are three steps to follow for further help.

FIRST, contact the people who serviced your appliance. Explain why you are not pleased. In most cases, this will solve the problem.

NEXT, if you are still not pleased, write all the details—including your phone number—to:

Manager, Consumer Relations
GE Appliances
Appliance Park
Louisville, KY 40225

FINALLY, if your problem is still not resolved, write:

Major Appliance Consumer Action Panel
20 North Wacker Drive
Chicago, IL 60606

IMPORTANT SAFETY INSTRUCTIONS

Read all instructions before using this appliance.



IMPORTANT SAFETY NOTICE

- The California Safe Drinking Water and Toxic Enforcement Act requires the Governor of California to publish a list of substances known to the state to cause birth defects or other reproductive harm, and requires businesses to warn customers of potential exposure to such substances.
- The fiberglass insulation in self-cleaning ovens gives off a very small amount of carbon monoxide during the cleaning cycle. Exposure can be minimized by venting with an open window or using a ventilation fan or hood.

When using electrical appliances, basic safety precautions **should** be followed, including the following:

- Use this appliance only for its intended use as described in this guide.
- Have the installer show you the location of the circuit breaker or fuse. Mark it for easy reference.
- Be sure your appliance is properly installed and grounded by a qualified technician in accordance with the provided Installation Instructions.
- Do not attempt to repair or replace any part of your oven unless it is specifically recommended in this guide. All other servicing should be referred to a qualified technician.
- Before performing any service, **DISCONNECT THE OVEN POWER SUPPLY AT THE HOUSEHOLD DISTRIBUTION PANEL BY REMOVING THE FUSE OR SWITCHING OFF THE CIRCUIT BREAKER.**
- Do not **leave** children alone—Children should not be left alone or unattended in an area where appliance is in use. They should never be allowed to sit or stand on any part of the appliance.
- Do not allow anyone to climb, stand or hang on the door. They could damage the oven or cause severe personal injury.
- **CAUTION: ITEMS OF INTEREST TO CHILDREN SHOULD NOT BE STORED IN CABINETS ABOVE AN OVEN. CHILDREN CLIMBING ON THE OVEN TO REACH ITEMS COULD BE SERIOUSLY INJURED.**
- Do not store flammable materials in an oven.
- **Teach** children not to play with the controls or any other part of the oven.

- Never **leave** the oven door open when you are not watching the oven.
- Always keep combustibile wall covering, curtains or drapes a safe distance from your oven.
- Never wear loose-fitting or hanging garments while using the appliance. Be careful when reaching for items stored in cabinets over the oven. Flammable material could be ignited if brought in contact with hot heating elements and may cause severe burns.
- **DO NOT STORE OR USE COMBUSTIBLE MATERIALS, GASOLINE OR OTHER FLAMMABLE VAPORS AND LIQUIDS IN THE VICINITY OF THIS OR ANY OTHER APPLIANCE.**



- Use only dry pot holders—Moist or damp pot holders on hot surfaces may result in burns from steam. Do not let pot holders touch hot heating elements. Do not use a towel or other bulky cloth. Such cloths can catch fire on a hot heating element.
- **Always** keep dish towels, dish cloths, pot holders and other linens a safe distance from your oven.
- Always keep wooden and plastic utensils and canned food a safe distance away from your oven.
- For your safety, never use your appliance for warming or heating the room.



- Do not let cooking grease or other flammable materials accumulate in or near the oven.
- Be sure the oven is securely installed in a cabinet that is **firmly** attached to the house structure. Never allow anyone to climb, sit or stand on the oven door.



- Do not use water on grease fires. Smother fire or flame or use a multi-purpose dry chemical or foam-type fire extinguisher.

Flame in the oven can be smothered completely by closing the oven door and turning the oven off or by using a multi-purpose dry chemical or foam-type fire extinguisher.

(continued next page)



IMPORTANT SAFETY INSTRUCTIONS

(continued)

- **Do not touch the heating elements or the interior surface of the oven.** These surfaces may be hot enough to burn even though they are dark in color. During and after use, do not touch, or let clothing or other flammable materials contact any interior area of the oven; allow sufficient time for cooling, first.

Potentially hot surfaces include the oven vent openings and surfaces near the openings, crevices around the oven door, the edges of the door window and metal trim parts above the door.

Remember: The inside surface of the oven may be hot when the door is opened.

- When cooking pork, follow the directions exactly and always cook the meat to an internal temperature of at least 170°F. This assures that, in the remote possibility that trichina may be present in the meat, it will be killed and the meat will be safe to eat.

Oven

- Stand away from the oven when opening the oven door. Hot air or steam which escapes can cause burns to hands, face and/or eyes.
- Do not heat unopened food containers. Pressure could build up and the container could burst, causing an injury.
- Keep the oven vent duct unobstructed.
- Keep the oven free from grease buildup.
- Place the oven shelf in the desired position while the oven is cool. If the shelves must be handled when hot, do not let the pot holder contact the heating elements in the oven.
- Never leave the oven door open when you are not watching the oven.
- Pulling out the shelf to the shelf stop is a convenience in lifting heavy foods. It is also a precaution against burns from touching the hot surfaces of the door or the oven walls.
- When using cooking or roasting bags in the oven, follow the manufacturer's directions.
- Do not use your oven to dry newspapers. If overheated, they can catch fire.

- Do not leave paper products, cooking utensils or food in the oven when not in use.
- Do not use oven for storage area. Items stored in an oven can ignite.
- After broiling, always take the broiler pan out of the oven and clean it. Leftover grease in the broiler pan can catch fire next time you use the pan.
- Never leave jars or cans of fat dripping on or near your oven,

Self-Cleaning Oven

- Do not **clean** the door gasket. The door gasket is essential for a good seal. Care should be taken not to rub, damage or move the gasket.
- Do not use oven cleaners. No commercial oven cleaner or oven liner protective coating of any kind should be used in or around any part of the oven. Residue from oven cleaners will damage the inside of the oven when the self-clean cycle is used.
- Clean only parts listed in this Use and Care Guide.
- Before self-cleaning the oven, remove the broiler pan and other cookware.
- Do not use aluminum foil to line oven bottoms, except as suggested in guide. Improper installation of these liners may result in a risk of electric shock or fire.
- Be sure to wipe up excess spillage before starting the self-cleaning operation.
- If the self-cleaning mode malfunctions, turn the oven off and disconnect the power supply. Have it serviced by a qualified technician.

SAVE THESE INSTRUCTIONS

FEATURES OF YOUR OVEN

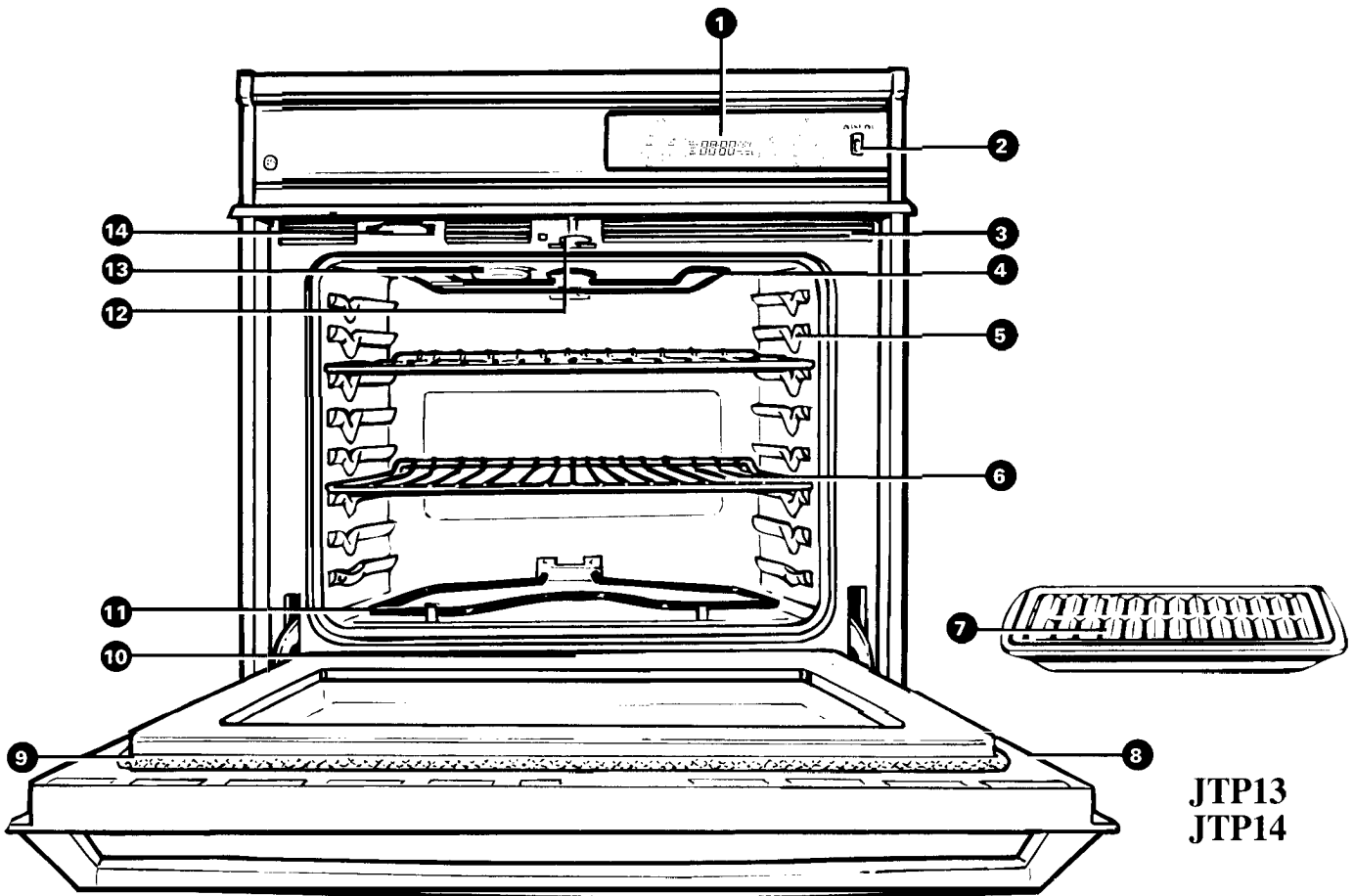

JTP13
JTP14

| Feature Index | Explained on page |
|---|-------------------|
| 1 Oven Control, Clock and Timer | 7 |
| 2 Oven Light Switch Lets you turn interior oven light on and off. | 8 |
| 3 Oven Vent Grille | 19 |
| 4 Broil Element | 3, 4, 17, 19, 24 |
| 5 Oven Shelf Supports Shelf positions for cooking are suggested in the Baking, Broiling and Roasting sections. | 9 |
| 6 Oven Shelves with Stop-Locks | 9, 10, 23 |
| 7 Broiler Pan and Rack Do not clean in self-cleaning oven. | 17, 23 |

| Feature Index | Explained on page |
|--|-------------------|
| 8 Lift-Off Oven Door with Broil Stop position Easily removed for oven cleaning. | 24 |
| 9 oven Door Gasket | 4, 19, 24 |
| 10 Model and Serial Numbers | 2 |
| 11 Bake Element May be lifted gently for wiping oven floor. | 3, 4, 19, 24 |
| 12 Automatic Oven Door Latch | 19-21 |
| 13 Oven Interior Light | 8, 23 |
| 14 oven Vent | 4 |



FEATURES OF YOUR OVEN CONTROL

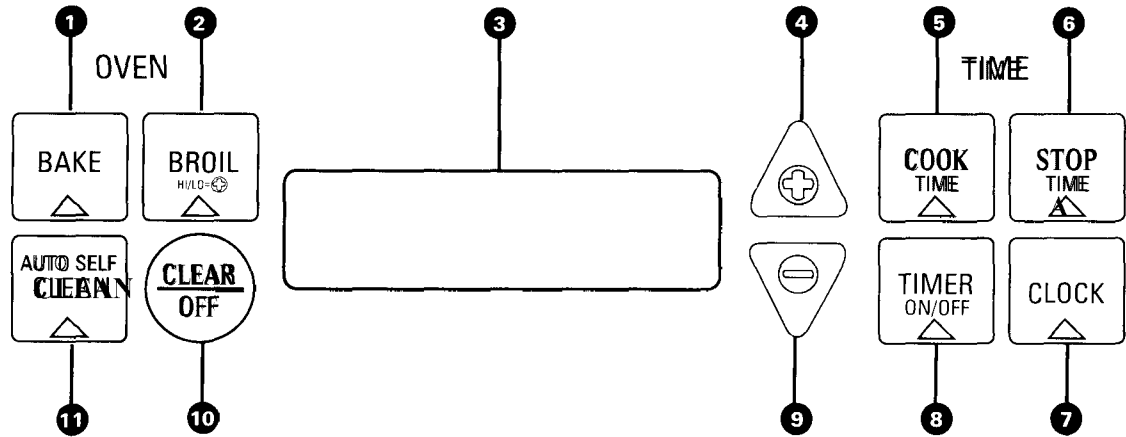

- 1. BAKE.** Press this pad to select the bake function.
- 2. BROIL.** Press this pad to select the broil function.
- 3. DISPLAY.** Shows the operations you have selected, the time of day and the cooking or cleaning status.
- 4. INCREASE.** Short taps to this pad increase the time or temperature by small amounts. Press and hold the pad to increase the time or temperature by larger amounts.
- 5. COOK TIME.** Press this pad for Timed Bake operations.
- 6. STOP TIME.** Use this pad along with the COOK TIME or AUTO SELF CLEAN pad to set the oven to stop automatically at a time you select.
- 7. CLOCK.** To set clock, first press the CLOCK pad. Then press the INCREASE or DECREASE pad to change the time of day.
- 8. TIMER ON/OFF.** Press this pad to select the timer function.
To set timer, first press the TIMER ON/OFF pad. Then press the INCREASE or DECREASE pad to change the time.
To cancel the timer, press and hold the TIMER ON/OFF pad, until the word "TIMER" disappears from the display.

- 9. DECREASE.** Short taps to this pad decrease the time or temperature by small amounts. Press and hold the pad to decrease the time or temperature by larger amounts.
- 10. CLEAR/OFF.** Press this pad to cancel all oven operations except clock and timer.
- 11. AUTO SELF CLEAN.** Press this pad to select self-cleaning function. See the Operating the Self-Cleaning Oven section.

If "F-and a number" flash in the display and the oven control signals this indicates function error code. Press the CLEAR/OFF pad. Allow the oven to cool for one hour. Put the oven back into operation. If function error code repeats, disconnect the power to the oven and call for service.

OVEN CONTROL, CLOCK AND TIMER



Lock

The clock must be set for the automatic oven timing functions to work properly. The time of day cannot be changed during a Timed Bake or Self-Cleaning cycle.

To Set the Clock



1. Press the CLOCK pad.

2. Press the INCREASE or DECREASE pad to set the time of day.

3. Press the CLOCK pad to start.

Timer

The timer does not control oven operations. The maximum setting on the timer is 9 hours and 55 minutes.

To Set the Timer



1. Press the TIMER ON/OFF pad.

Then it will display minutes and seconds until 10 minutes is reached.

After 10 minutes, it will display minutes only until 59 minutes is reached.

After 59 minutes, it will display hours and minutes ("HR" now appears in the display) until the maximum time of 9 hours and 55 minutes is reached.

2. Press the INCREASE or DECREASE pad to set the amount of time on the timer.

The timer will start automatically within a few seconds of releasing the INCREASE or DECREASE pad.

The timer, as you are setting it, will display seconds until 1 minute is reached.

To Reset the Timer

If "TIMER" is displayed, press the INCREASE or DECREASE pad until the desired time is reached.

If "TIMER" is not displayed, press the TIMER ON/OFF pad first, then follow the instructions above to set the timer.

To Cancel the Timer

Press and hold the TIMER ON/OFF pad until the word "TIMER" disappears from the display.

End of Cycle Tones

The end of cycle tone is 3 short beeps followed by 1 beep that repeats every 6 seconds until you press any operation. If you would like to eliminate the **repeating** beeps, press and hold the CLEAR/OFF pad for 10 seconds.

To return the signal that beeps every 6 seconds, press and hold the CLEAR/OFF pad for 10 seconds.

Display Messages

If "**door**" appears on the display, the door is not closed. If "LOCK" appears in the display, the oven door is in the locked position. BAKE, BROIL and COOK TIME cannot be set if the door is in the locked position.

Power Outage

After a power outage, when power is restored, the display will flash and the time shown will no longer be correct—for example, after a 5-minute power interruption the clock will be 5 minutes slow. The display flashes until the clock is reset. All other functions that were in operation when the power went out will have to be programmed again.



USING YOUR OVEN

Before Using Your Oven

1. Look at the controls. Be sure you understand how to set them properly. Read over the directions for the Oven Controls so you understand how to use them.
2. Check the oven interior. Look at the shelves. Take a practice run at removing and replacing them properly, to give sure, sturdy support.
3. Read over the information and tips that follow.
4. Keep this guide handy so you can refer to it, especially during the first weeks of using your new oven.

NOTE:

- A fan may automatically turn on and off to cool internal parts. This is normal, and the fan may continue to run even after the oven is turned off.
- You may notice a “burning” or “oily” smell the first few times you turn your oven on. This is normal in a new oven and will disappear in a short time. To speed the process, set a self-clean cycle for a minimum of 3 hours. See the Self-Cleaning Oven section.

Oven Light

The light comes on when the oven door is opened or when the control panel light switch is turned on.

Oven Vent

When the oven is on, heated air moves through a vent above the door or between door and air grille.

The vent area could get hot during oven use.

The vent is needed for proper air flow in the oven and good baking results. Do not block this vent.



Shelf Locks

The shelves are designed with stop-locks so when placed correctly on the shelf supports, they will stop before coming completely out of the oven, and will not tilt when you are removing food from them or placing food on them.

When placing cookware on a shelf, pull the shelf out to the bump on the shelf support. Place the cookware on the shelf, then slide the shelf back into the oven. This will eliminate reaching into the hot oven.

To remove a shelf from the oven, pull it toward you, tilt the front end upward and pull the shelf out. Be sure the shelf is cool before touching it.

To replace, place the shelf on the shelf support with the stop-locks (curved extension of shelf) facing up and toward the rear of the oven. Tilt up the front and push the shelf toward the back of the oven until it goes past the bump on the shelf support. Then lower the front of the shelf and push it all the way back.

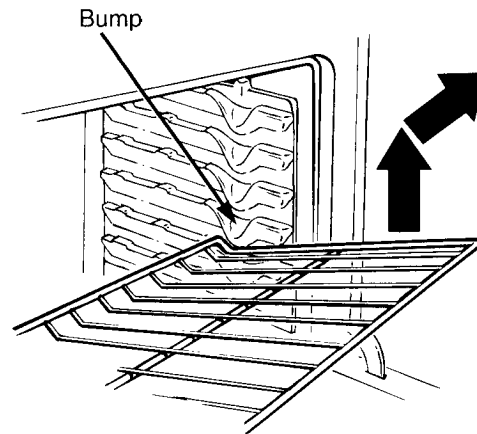

Shelf Positions

The oven has six shelf supports identified in this illustration as A (bottom), B, C, D, E and F (top).

Shelf positions for cooking are suggested in the Baking, Roasting and Broiling sections.

NOTE: The highest position (above F) is only a support. It is not intended to be used as a shelf position in these models that do not have the convection feature.

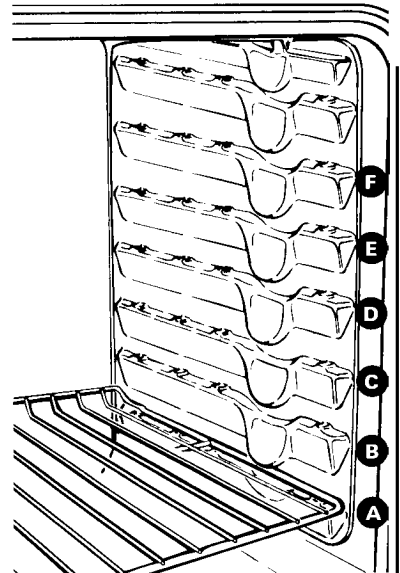



BAKING

Your oven temperature is controlled very accurately using an oven control system. We recommend that you operate the oven for a number of weeks using the time given on recipes as a guide to become familiar with your new oven's performance. If you think an adjustment is necessary, see the Adjust the Oven Thermostat section. It gives easy *Do It Yourself* instructions on how to adjust the thermostat.

NOTE: When the oven gets hot, the top and outside surfaces of the oven get hot too.

How to Set Your Oven for Baking

To avoid possible burns, place shelves in the correct position before you turn the oven on.

1. Press the BAKE pad.
2. Press the INCREASE or DECREASE pad until the desired temperature is displayed.

The oven will start automatically. The word "ON" and "1000" will be displayed. As the oven heats up, the display will show the changing temperature. When the oven reaches the temperature you set, a tone will sound.

3. Press the CLEAR/OFF pad when baking is finished and then remove the food from the oven.

NOTE: A fan may automatically turn on and off to cool internal parts. This is normal, and the fan may continue to run after the oven is turned off.

To change the oven temperature during BAKE cycle, press the BAKE pad and then the INCREASE or DECREASE pad to get the new temperature.

Oven Shelves

Arrange the oven shelf or shelves in the desired locations while the oven is cool. The correct shelf position depends on the kind of food and the browning desired. As a general rule, place most foods in the middle of the oven, on either shelf positions C or D. See the chart for suggested shelf positions.

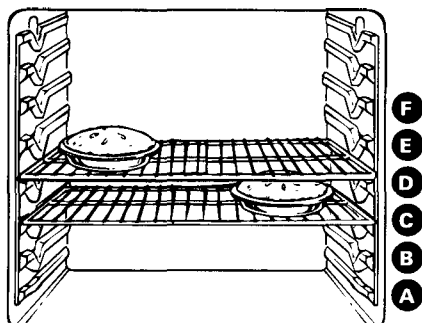

NOTE: To bake 4 layers of cake at one time, position 2 layers on shelf B and 2 layers on shelf D with the pans staggered so that one is not directly above the other.

| Type of Food | Shelf Position |
|----------------------|----------------|
| Angel food cake | B |
| Biscuits or muffins | C or D |
| Cookies or cupcakes | C or D |
| Brownies | C or D |
| Layer cakes | C or D |
| Bundt or pound cakes | B |
| Pies or pie shells | C or D |
| Frozen pies | B |
| Casseroles | C or D |
| Roasting | A or B |

Preheating

Preheat the oven if the recipe calls for it. Preheat means bringing the oven up to the specified temperature before putting the food in the oven. To preheat, set the oven at the correct temperature—selecting a higher temperature does not shorten preheat time.

Preheating is necessary for good results when baking cakes, cookies, pastry and breads. For most casseroles and roasts, preheating is not necessary. For ovens without a preheat indicator light or tone, preheat 10 minutes. After the oven is preheated, place the food in the oven as quickly as possible to prevent heat from escaping.

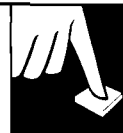

Baking Pans

Use the proper baking pan. The type of finish on the pan determines the amount of browning that will occur.

- Dark, rough or dull pans absorb heat resulting in a browner, crisper crust. Use this type for pies.
- Shiny, bright and smooth pans reflect heat, resulting in a lighter, more delicate browning. Cakes and cookies require this type of pan.
- Glass baking dishes absorb heat. When baking in glass baking dishes reduce the temperature by 25°F.

Pan Placement

For even cooking and proper browning, there must be enough room for air circulation in the oven. Baking results will be better if baking pans are centered as much as possible rather than being placed to the front or to the back of the oven.

Pans should not touch each other or the walls of the oven. Allow 1 - to 1½-inch space between pans as well as from the back of the oven, the door and the sides. If you use two shelves, stagger the pans so one is not directly above the other.

Baking Guides

When using prepared baking mixes, follow package recipe or instructions for the best baking results.

Cookies

When baking cookies, flat cookie sheets (without sides) produce better-looking cookies. Cookies baked in a jelly roll pan (short sides all around) may have darker edges and pale or light browning may occur.

Do not use a cookie sheet so large that it touches the walls or the door of the oven. Never entirely cover a shelf with a large cookie sheet.

For best results, use only one cookie sheet in the oven at a time.

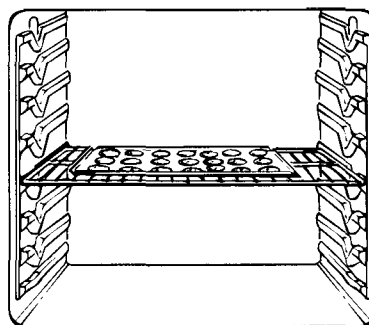

Pies

For best results, bake pies in dark, rough or dull pans to produce a browner, crisper crust. Frozen pies in foil pans should be placed on an aluminum cookie sheet for baking since the shiny foil pan reflects heat away from the pie crust; the cookie sheet helps retain it.

Cakes

When baking cakes, warped or bent pans will cause uneven baking results and poorly shaped products. A cake baked in a pan larger than the recipe recommends will usually be crisper, thinner and drier than it should be. If baked in a pan smaller than recommended, it may be undercooked and batter may overflow. Check the recipe to make sure the pan size used is the one recommended.

(continued next page)



BAKING

(continued)

Aluminum Foil

Never entirely cover a shelf with aluminum foil. This will disturb the heat circulation and result in poor baking. A smaller sheet of foil may be used to catch a spillover by placing it on a lower shelf several inches below the food.

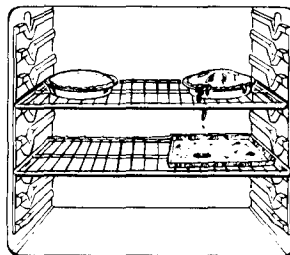

Don't Peek

Set the timer for the estimated cooking time and do not open the door to look at your food. Most recipes provide minimum and maximum baking times such as 'bake 30-40 minutes.'

DO NOT open the door to check until the minimum time. Opening the oven door frequently during cooking allows heat to escape and makes baking times longer. Your baking results may also be affected

TIMED BAKING

How to Time Bake

The oven control allows you to turn the oven on or off automatically at specific times that you set.

NOTE: Before beginning make sure the clock shows the correct time of day.

To set the clock, first press the CLOCK pad. Press the INCREASE or DECREASE pad until the correct time of day is displayed. Press the CLOCK pad to start.

How to Set Immediate Start and Automatic Stop

To avoid possible burns, place the shelves in the correct position before you turn the oven on.

The oven will turn on immediately and cook for a selected length of time. At the end of Cook Time, the oven will turn off automatically.



1. Press the COOK TIME pad.

NOTE: If your recipe requires preheating, you may need to add additional time to the length of the Cook Time.

2. Press the INCREASE pad until the desired length of baking time appears in the display.



3. Press the BAKE pad.

4. Press the INCREASE or DECREASE pad until the desired temperature is displayed. An attention tone will sound if step 3 is not done.

The oven will start automatically. The word "ON" and "1000" will be displayed. The Cook Time will begin to count down. As the oven heats up, the display will show the changing temperature. When the oven reaches the temperature you set, a tone will sound. The oven will continue to cook for the programmed amount of time, then shut off automatically.

5. Press the CLEAR/OFF pad to clear the display if necessary. Remove the food from the oven. Remember, even though the oven shuts off automatically, foods continue cooking after the controls are off.

NOTE:

- **Foods** that spoil easily, such as milk, eggs, fish, stuffings, poultry and pork, should not be allowed to sit for more than one hour before or after cooking. Room temperature promotes the growth of harmful bacteria. Be sure that the oven light is off because heat from the bulb will speed harmful bacteria growth.
- A fan may automatically turn on and off to cool internal parts. This is normal, and the fan may continue to run after the oven is turned off.

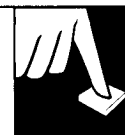

How to Set Delay Start and Automatic Stop

Quick Reminder:

1. Press the COOK TIME pad.
2. Press the INCREASE or DECREASE pad to set the Cooking Time.
3. Press the STOP TIME pad.
4. Press the INCREASE or DECREASE pad to set the Stop Time.
5. Press the BAKE pad.
6. Press the INCREASE or DECREASE pad until the desired temperature appears in the display.

To avoid possible burns, place the shelves in the correct position before you turn the oven on.

You can set the oven control to delay-start the oven, cook for a specific length of time and then turn off automatically.

For example: Let's say it's 2:00 and dinner time is shortly after 7:00. The recipe suggests 3 hours baking time at 325°F. Here's how:



1. Press the COOK TIME pad.

NOTE: If your recipe requires preheating, you may need to add additional time to the Cook Time.



2. For 3 hours of cooking time, press the INCREASE pad until "3:00" appears in the display.



3. Press the STOP TIME pad.

The display prompts you to set the Stop Time. It also shows you the earliest Stop Time you can set. In this example, the time of day is 2:00 and the Cook Time is 3 hours. Adding 3 hours to the time of day equals 5:00.



4. Change the Stop Time from 5:00 to 7:00 by pressing the INCREASE pad until "7:00" appears in the display.



5. Press the BAKE pad.



6. Press the INCREASE or DECREASE pad until "325.0" is displayed.

At 4:00, the oven will turn on automatically. The word "ON" and "100°" will be displayed. The Cook Time will begin to count down. As the oven heats up, the display will show the changing temperature. The oven will continue to cook for the programmed 3 hours and shut off automatically at 7:00.

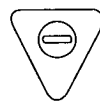

7. Press the CLEAR/OFF pad to clear the display if necessary. Remove the food from the oven. Remember, even though the oven shuts off automatically, foods continue cooking after the controls are off.

NOTE:

- The low temperature zone of this oven (between 150°F. and 200°F.) is available to keep hot cooked foods warm. Food kept in the oven longer than two hours at these low temperatures may spoil.
- Foods that spoil easily, such as milk, eggs, fish, stuffings, poultry and pork, should not be allowed to sit for more than one hour before or after cooking. Room temperature promotes the growth of harmful bacteria. Be sure the oven light is off because heat from the bulb will speed harmful bacteria growth.
- A fan may automatically turn on and off to cool internal parts. This is normal, and the fan may continue to run after the oven is turned off.







ADJUST THE OVEN THERMOSTAT— *DO IT YOURSELF!*

You may find that your new oven cooks differently than the one it replaced. We recommend that you use your new oven for a few weeks to become more familiar with it, following the times given in your recipes as a guide.

If you think your new oven is too hot or too cool, you can adjust the thermostat yourself. If you think it is too hot, adjust the thermostat to make it cooler. If you think it is too cool, adjust the thermostat to make it hotter.

We do not recommend the use of inexpensive thermometers, such as those found in grocery stores, to check the temperature setting of your new oven. These thermometers may vary 20–40 degrees.

To Adjust the Thermostat:

1. Press the BAKE pad.

2. Select an oven temperature between 500°F. and 550°F.
3. Immediately, before ON is displayed, press and hold the BAKE pad for about four seconds. The display will change to the oven adjustment display.

4. The oven temperature can be adjusted up to (+) 35°F. hotter or (-) 35°F. cooler. Use the INCREASE or DECREASE pad to select the desired change in the display.
5. When you have made the adjustment, press the CLEAR/OFF pad to go back to the time of day display. Use your oven as you would normally.

NOTE: This adjustment will not affect the broiling or self-cleaning temperatures. It will be retained in memory after a power failure,

ROASTING



Roasting is cooking by dry heat. Tender meat or poultry can be roasted uncovered in your oven. Roasting temperatures, which should be low and steady, keep spattering to a minimum.

Roasting is really a baking procedure used for meats. Therefore, oven controls are set for Baking or Timed Baking. (You may hear a slight clicking sound, indicating the oven is working properly.) Timed Baking will turn the oven on and off automatically.

Most meats continue to cook slightly while standing, after being removed from the oven. Standing time recommended for roasts is 10 to 20 minutes. This allows roasts to firm up and makes them easier to carve. Internal temperature will rise about 5° to 10°F.; to compensate for temperature rise, if desired, remove the roast from oven sooner (at 5° to 10°F. less than the temperature in the Roasting Guide).

Remember that food will continue to cook in the hot oven and therefore should be removed when the desired internal temperature has been reached.

1. Place the shelf in A or B position. No preheating is necessary.

2. Check the weight of the meat. Place the meat fat-side-up, or poultry breast-side-up, on roasting rack in a shallow pan. The melting fat will baste the meat. Select a pan as close to the size of the meat as possible. (The broiler pan with rack is a good pan for this.)

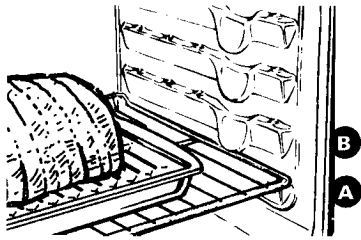

NOTE: A fan may automatically turn on and off to cool internal parts. This is normal, and the fan may continue to run after the oven is turned off.

3. Press the BAKE pad.



4. Press the INCREASE or DECREASE pad until the desired temperature is displayed.

The oven will start automatically. The word "ON" and "100°" will be displayed. As the oven heats up, the display will show the changing temperature. When the oven reaches the temperature you set, a tone will sound.

5. Press the CLEAR/OFF pad when roasting is finished and then remove the food from the oven.

To change the oven temperature during the roasting cycle, press the BAKE pad and then the INCREASE or DECREASE pad to get the new temperature.

Use of Aluminum Foil

You can use aluminum foil to line the broiler pan. This makes clean-up easier when using the pan for marinating, cooking with fruits, cooking heavily cured meats or basting food during cooking. Press the foil tightly around the inside of the pan.

(continued next page)

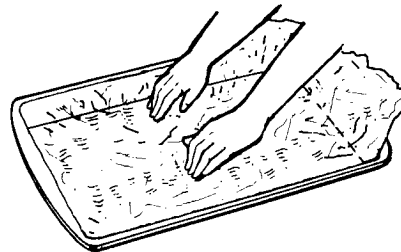



ROASTING

(continued)

Questions and Answers

Q. Is it necessary to check for doneness with a meat thermometer?

A. Checking the finished internal temperature at the completion of cooking time is recommended. Temperatures are shown in the Roasting Guide. For roasts over 8 pounds, check with thermometer at half-hour intervals after half the cooking time has passed.

Q. Why is my roast crumbling when I try to carve it?

A. Roasts are easier to slice if allowed to cool 10 to 20 minutes after removing them from the oven. Be sure to cut across the grain of the meat.

Q. Do I need to preheat my oven each time I cook a roast or poultry?

A. It is not necessary to preheat your oven.

Q. When buying a roast, are there any special tips that would help me cook it more evenly?

A. Yes. Buy a roast as even in thickness as possible, or buy rolled roasts.

Q. Can I seal the sides of my foil "tent" when roasting a turkey?

A. Sealing the foil will steam the meat. Leaving it unsealed allows the air to circulate and brown the meat.

ROASTING GUIDE

Frozen Roasts

Frozen roasts of beef, pork, lamb, etc., can be started without thawing, but allow 10 to 25 minutes per pound additional time (10 minutes per pound for roasts under 5 pounds, more time for larger roasts).

Make sure poultry is thawed before roasting. **Unthawed** poultry often does not cook evenly. Some commercial frozen poultry can be cooked successfully without thawing. Follow the directions given on the package label.

| Type | Oven Temperature | Doneness | Approximate Roasting Time in Minutes per Pound | | Internal Temperature °F. |
|--|------------------|--------------------------------|--|-------------------------|---------------------------------------|
| Meat | | | 3 to 5 lbs. | 6 to 8 lbs. | |
| Tender cuts; rib, high quality sirloin tip, rump or top round* | 325° | Rare: Medium: Well Done: | 24-33 35-39 40-45 | 18-22 22-29 30-35 | 140°† 160° 170° |
| Lamb leg or bone-in shoulder* | 325° | Rare: Medium: Well Done: | 21-25 25-30 30-35 | 20-23 24-28 28-33 | 140°† 160° 170° |
| Veal shoulder, leg or loin* | 325° | Well Done: | 35-45 | 30-40 | 170° |
| Pork loin, rib or shoulder* | 325° | Well Done: | 35-45 | 30-40 | 170° |
| Ham, precooked | 325° | To Warm: | 17-20 minutes per pound (any weight) | | 140° |
| Poultry | | | 3 to 5 lbs. | Over 5 lbs. | |
| Chicken or Duck | 325° | Well Done: | 35-40 | 30-35 | In breast 170° In thigh 180° |
| Turkey | 325° | Well Done: | 10 to 15 lbs. 18-25 | Over 15 lbs. 15-20 | In thigh: 185°-190° |
| Turkey Breast | 325° | Well Done: | 3 to 3½ lbs. 30-40 | 5½ to 9 lbs. 15-22 | 170° |

*For boneless rolled roasts over 6 inches thick, add 5 to 10 minutes per pound to times given above.

†The U. S. Department of Agriculture says "Rare beef is popular, but you should know that cooking it to only 140°F. means some food poisoning organisms may survive." (Source: Safe Food Book, Your Kitchen Guide, USDA Rev. June 1985.)

BROILING



Broiling is cooking food by intense radiant heat from the upper broil element in the oven. Most fish and tender cuts of meat can be broiled. Follow these directions to keep spattering and smoking to a minimum.

Turn the food only once during broiling. Time the foods for the first side according to the Broiling Guide. Turn the food, then use the times given for the second side as a guide to the preferred doneness.

1. If the meat has fat or gristle around the edge, cut vertical slashes through both about 2 inches apart. If desired, the fat may be trimmed, leaving a layer about 1/8 inch thick.
2. Place the meat on the broiler rack in the broiler pan. Always use the rack so the fat drips into the broiler pan; otherwise the juices may become hot enough to catch on fire.
3. Position a shelf on recommended shelf position as suggested in the Broiling Guide. Most broiling is done on E position, **but if your oven is connected to 208 volts, you may wish to use a higher position.**
4. **Leave the door open to the broil stop position.** The door stays open by itself, yet the proper temperature is maintained in the oven.

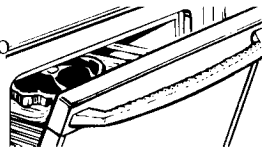

NOTE: A fan may automatically turn on and off to cool internal parts. This is normal, and the fan may continue to run after the oven is turned off.



5. Press the BROIL pad.

6. Press the INCREASE pad once for HI Broil or press the DECREASE pad once for LO Broil. To change from HI Broil to LO Broil, press the BROIL pad then press the DECREASE pad once.
7. When broiling is finished press the CLEAR/OFF pad. Serve the food immediately and leave the pan outside the oven to cool during the meal for easiest cleaning.

Use of Aluminum Foil

You can use aluminum foil to line your broiler pan and broiler rack. However, you must mold the foil tightly to the rack and cut slits in it just like the rack.

Without the slits, the foil will prevent fat and meat juices from draining to the broiler pan. The juices could become hot enough to catch on fire. If you do not cut the slits, you are frying, not broiling.

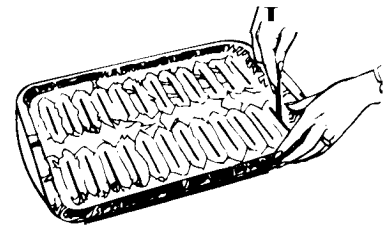

Questions and Answers

Q. Why are my meats not turning out as brown as they should?

A. In some areas, the power (voltage) to the oven may be low. In these cases, preheat the broil element for 1 () minutes before placing the broiler pan with food in the oven. Check to see if you are using the recommended shelf position. Broil for longest period of time indicated in the Broiling Guide. Turn the food only once during broiling. You may need to move the food to a higher shelf position.

Q. Should I salt the meat before broiling?

A. No. Salt draws out the juices and allows them to evaporate. Always salt after cooking. Turn the meat with tongs: piercing the meat with a fork also allows juices to escape. When broiling poultry or fish, brush each side often with butter.

Q. When broiling, is it necessary to always use a rack in the pan?

A. Yes. Using the rack suspends the meat over the pan. As the meat cooks, the juices fall into the pan, thus keeping meat drier. Juices are protected by the rack and stay cooler, thus preventing excessive spatter and smoking.

Q. Do I need to grease my broiler rack to prevent meat from sticking?

A. No. The broiler rack is designed to reflect broiler heat, thus keeping the surface cool enough to prevent meat from sticking to the surface. However, spraying the broiler rack lightly with a vegetable cooking spray before cooking will make clean-up easier.

(continued next page)



BROILING GUIDE

- Always use the broiler pan and rack that comes with your oven. It is designed to minimize smoking and spattering by trapping the juices in the shielded lower part of the pan.
- **The oven door should be open to the broil stop position.**
- For steaks and chops, slash fat evenly around the outside edges of the meat. To slash, cut crosswise through the outer fat surface just to the edge of the meat. Use tongs to turn the meat over to prevent piercing the meat and losing the juices.
- If desired, marinate meats or chicken before broiling, or brush with barbecue sauce last 5 to 10 minutes only.
- **When arranging food on the pan, do not let fatty edge hang over the sides.** These could soil the oven bottom.
- The broiler does not need to be preheated. However, for very thin foods, or to increase browning, preheat if desired.
- Frozen steaks can be broiled by positioning the oven shelf at next lowest shelf position and increasing cooking time given in this guide 1 ½ times per side.
- Use LO Broil to cook foods such as poultry or thick pork chops thoroughly without over-browning them.
- **If your oven is connected to 208 volts,** rare steaks may be broiled by preheating the broiler and positioning the oven shelf one position higher.

| Food | Quantity and/or Thickness | Shelf Position | First Side Time, Minute! | Second Side Time, Minutes | Comments |
|---|--|----------------|--------------------------|---------------------------|---|
| Ground Beef Well Done | 1 lb. (4 patties), 1/2 to 3/4 inch thick | E | 10 | 7 | Space evenly. |
| | 4 lbs. (16 patties) | E | 10 | 9 | |
| Beef Steaks | 3/4 to 1 inch thick (1 to 1½ lbs.) | Rare | 8 | 6 | Steaks less than 3/4 inch thick are difficult to cook rare. |
| | | Medium | 10 | 8 | |
| | | Well Done | 12 | 10 | |
| Rare | 1½ inch thick (2 to 2½ lbs.) | Medium | 10 | 8 | Slash fat. |
| | | Well Done | 15 | 14-16 | |
| | | | 25 | 2&25 | |
| Chicken | 1 whole (2 to 2½ lbs.), split lengthwise | C | 25 | 10 | Brush each side with melted butter. Broil skin-side-down first. |
| | Breast | C | 25 | 15 | |
| Bakery Products Bread (Toast) or English Muffins | 2 to 4 slices 2 (split) | F | 3 | 1 | Space evenly. Place English muffins cut-side-up and brush with butter, if desired. |
| | | F | 3-4 | | |
| Lobster Tails | 2-4 (6 to 8 oz. each) | C | 13-16 | Do not turn over. | Cut through back of shell. Spread open. Brush with melted butter before broiling and after half of broiling time. |
| Fish | 1-lb. fillets 1/4 to 1/2 inch thick | E | 5 | 5 | Handle and turn very carefully. Brush with lemon butter before and during cooking , if desired. |
| Ham Slices (precooked) | 1/2 inch thick | D | 6 | 6 | |
| | 1 inch thick | D | 8 | 8 | |
| Pork Chops Well Done | 2 (1/2 inch thick) | E | 10 | 10 | Slash fat. |
| | 2 (1 inch thick), about 1 lb. " | D | 15 | 15 | |
| Lamb Chops Medium Well Done Medium Well Done | 2(1 inch thick), about 10 to 12 oz. | E | 10 | 9 | Slash fat. |
| | | E | 12 | 10 | |
| | 2 (1 ½ inch thick), about 1 lb. | E | 14 | 12 | |
| | | E | 17 | 12-14 | |

OPERATING THE SELF-CLEANING OVEN

Normal Cleaning Time: 3 hours



Before a Clean Cycle

The oven must be completely cool in order to set the self-clean cycle.

We recommend venting with an open window or using a ventilation fan or hood during the first self-clean cycle.

1. Remove the broiler pan, broiler rack, all cookware and any aluminum foil from the oven—they can't withstand the high cleaning temperatures.

NOTE: The oven shelves may be cleaned in the self-cleaning oven. However, they will darken, lose their luster and become hard to slide.

2. Wipe up any spillovers, residue or ash. Gently lift the bake element to wipe up the oven floor. Both the bake and broil elements are cleaned in the self-clean cycle. If you use soap to wipe up any excess, rinse thoroughly to prevent staining during the clean cycle.

3. Clean spatters or soil on the oven front frame and the oven door **outside the gasket with a dampened cloth.** The oven front frame and the oven door **outside the gasket do not get cleaned by the self-clean cycle.** On these areas, use detergent and hot water or a soap-filled steel wool pad. Rinse well with a vinegar and water solution. This will help prevent a brown residue from forming when the oven is heated. Buff these areas with a dry cloth. **Do not clean the gasket.**

Clean the outside front of the oven door with soap and water. Also use soap and water to clean under the oven vent grille. **Do not use abrasives or oven cleaners.**

Make sure the oven light bulb cover is in place.

Do not rub or clean the door gasket—the fiberglass material of the gasket has an extremely low resistance to abrasion. An intact and well-fitting oven door gasket is essential for energy-efficient oven operation and good baking results. If you notice the gasket becoming worn, frayed or damaged in any way or if it has become displaced on the door, you should have it replaced.

Do not let water run down through openings in the top of the door.

4. Close the oven door and make sure the oven light is off. If the oven light is not turned off, the life of the bulb will be shortened or it may burn out immediately. The door latches automatically after the clean cycle is set.

Do not use commercial oven cleaners or oven protectors in or near the self-cleaning oven. A combination of any of these products plus the high clean-cycle temperature may damage the porcelain finish of the oven.

(continued next page)

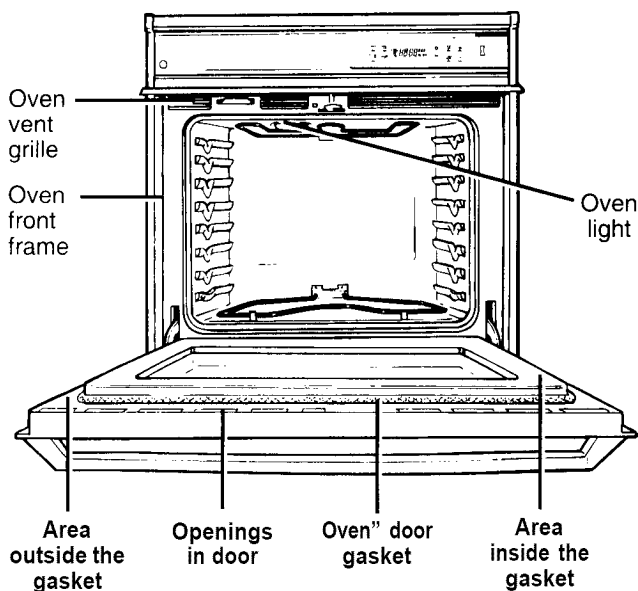



OPERATING THE SELF-CLEANING OVEN

(continued)

How to Set Oven for Cleaning

Quick Reminder:

1. Press the AUTO SELF CLEAN pad.
2. Press the INCREASE or DECREASE pad until the desired Clean Time appears.

If the oven is too hot and you start to set a clean cycle, the word "OFF" will appear in the display. Allow additional time for cooling before you try to set the cycle.

1. Follow the directions in the Before a Clean Cycle section.



2. After closing the door, press the AUTO SELF CLEAN pad.



3. Press the INCREASE or DECREASE pad until the desired Clean Time is displayed. Clean Time is normally 3 hours. You can change the Clean Time to any time between 2 and 4 hours, depending on the amount of soil in your oven.

The self-clean cycle will automatically begin after "CLEAN" is displayed and the time for the clean cycle is set. The words "ON" and "LOCK" will appear in the display when the door automatically locks. It will not be possible to open the oven door until the temperature drops below the lock temperature and the LOCK light goes off.

4. When the LOCK light is off, open the door.

NOTE:



- You can find out when the clean cycle will be finished by pressing the STOP TIME pad.
- The word "door" will be displayed, the word "LOCK" will flash and oven control will signal if you set the clean cycle and forget to close the oven door.
- A fan may automatically turn on and off to cool internal parts. This is normal, and the fan may continue to run after the oven is turned off.

To Stop a Clean Cycle



1. Press the CLEAR/OFF pad.

2. When the LOCK light goes off and the oven has cooled below the locking temperature, open the door.



After Self-Cleaning

You may notice some white ash in the oven. Just wipe it up with a damp cloth after the oven cools.

If white spots remain, remove them with a soap-filled steel wool pad. Be sure to rinse thoroughly with a vinegar and water mixture. These deposits are usually a salt residue that cannot be removed by the clean cycle.

If the oven is not clean after one clean cycle, repeat the cycle.

NOTE:

- No functions can be programmed before the door automatically unlocks.
- If the shelves have become hard to slide, wipe the shelf supports with cooking oil.

How to Set Delay Start of Cleaning

Quick Reminder:

1. Press the AUTO SELF CLEAN pad.
2. Press the INCREASE or DECREASE pad until the desired Clean Time appears.
3. Press the STOP TIME pad.
4. Press the INCREASE pad until the desired Stop Time appears in the display.

Delay Start is setting the oven timer to start the clean cycle automatically at a later time than the present time of day.

NOTE: Before beginning, make sure the oven clock shows the correct time of day.

1. Follow the directions in the Before a Clean Cycle section.



2. After closing the door, press the AUTO SELF CLEAN pad.



3. Press the INCREASE or DECREASE pad to enter the Clean Time.



4. Press the STOP TIME pad. "STOP TIME" and the earliest Stop Time you can set will appear in the display.

The earliest Stop Time will be the Clean Time selected plus the time of day. **For example:** If the Clean Time is three hours and the time of day is 6:00, the Stop Time that appears in the display will be 9:00.



5. Press the INCREASE pad to change the Stop Time to a later time of day if desired. **For example:** If you set Stop Time at 11:00, oven will start clean cycle at 8:00 and end at 11:00. The door latches automatically.

The self-clean cycle will automatically begin after "CLEAN" is displayed and the time for the clean cycle is set. The words "ON" and "LOCK" will appear in the display when the door automatically locks. It will not be possible to open the oven door until the temperature drops below the lock temperature and the LOCK light goes off.

6. When the LOCK light is off, open the door.

NOTE:



- During a delayed self-clean operation you can find out when the oven is set to turn on by pressing and holding the AUTO SELF CLEAN pad for 3 seconds.

- A fan may automatically turn on and off to cool internal parts. This is normal, and the fan may continue to run after the oven is turned off.

(continued next page)



OPERATING THE SELF-CLEANING OVEN

(continued)

Questions and Answers

- Q. If my oven clock is not set to the correct time of day, can I still self-clean my oven?**
- A. If the clock is not set to the correct time of day you will not be able to set a delay clean to end at a specific time.**
- Q. Can I use commercial oven cleaners on any part of my self-cleaning oven?**
- A. No cleaners or coatings should be used around any part of this oven. If you do use them and do not thoroughly rinse the oven with water, wiping it absolutely clean afterward, the residue can scar the oven surface and damage metal parts the next time the oven is automatically cleaned.**
- Q. What should I do if excessive smoking occurs during cleaning?**
- A. This is caused by excessive soil. Turn the oven off. Open the windows to rid the room of smoke. Wait until the oven has cooled and the word "LOCK" is off in the display. Wipe up the excess soil and reset the clean cycle.**
- Q. Is the "crackling" or "popping" sound I hear during cleaning normal?**
- A. Yes.** This is the sound of the metal heating and cooling during both the cooking and cleaning functions.
- Q. Should there be any odor during the cleaning?**
- A. Yes,** there will be an odor during the first few cleanings. Failure to wipe out excessive soil might also cause a strong **odor when cleaning.**
- Q. What causes the hair-like lines on the enameled surface of my oven?**
- A.** This is a normal condition, resulting from heating and cooling during cleaning. These lines do not affect how your oven performs.
- Q. Why do I have ash left in my oven after cleaning?**
- A.** Some types of soil will leave a deposit which is ash. It can be removed with a damp sponge or cloth.
- Q. My oven shelves do not slide easily. What is the matter?**
- A.** After many cleanings, the oven shelves will lose their luster and become hard to slide. To make the shelves slide more easily, wipe the shelf supports with cooking oil.
- Q. My oven shelves have become gray after the self-clean cycle. Is this normal?**
- A. Yes.** After the self-clean cycle, the shelves will lose some luster and discolor to a deep gray color.

CARE AND CLEANING



Proper care and cleaning are important so your oven will give you efficient and **satisfactory** service. Follow these directions carefully in caring for your oven to assure safe and proper maintenance.

BE SURE ELECTRICAL POWER IS OFF BEFORE CLEANING ANY PART OF THE OVEN.

Oven Shelves

Clean the shelves with an abrasive cleanser or steel wool.



After cleaning, rinse the shelves with clean water and dry with a clean cloth.

NOTE: The oven shelves may also be cleaned in the self-cleaning oven, however, the shelves will darken in color, lose their luster and become hard to slide if cleaned during the self-cleaning cycle. Wipe the shelf supports with cooking oil after self-cleaning to make shelves slide more easily.

Broiler Pan and Rack

After broiling, remove the broiler pan from the oven. Remove the rack from the pan. Carefully pour out grease from the pan into a proper container. Wash and rinse the broiler pan and rack in hot water with a soap-filled or plastic scouring pad.



If food has burned on, sprinkle the rack with detergent while hot and cover with wet paper towels or a dishcloth. Soaking the pan will remove burned on foods.

The broiler pan and rack may be cleaned with a commercial oven cleaner.

Both the broiler pan and rack can also be cleaned in the dishwasher.

Do not clean the broiler pan or rack in the self-cleaning oven.

Do not store a soiled broiler pan and rack anywhere in the oven.

Oven Light Bulb

NOTE: The glass cover should be removed only when cold. Wearing latex gloves may offer a better grip.

The light bulb is located on the top of the oven. Before replacing the bulb, disconnect electrical power to the oven at the main fuse or circuit breaker panel. Let the bulb cool completely before removing it. For your safety, do not touch a hot bulb with a damp cloth. If you do, the bulb will break.

To remove:

Turn to remove the cover, then remove the bulb.

To replace:

Put in a new 40-watt appliance bulb.

NOTE:

- A 40-watt appliance bulb is smaller than a standard 40-watt household bulb.
- Install and tighten the cover,
- Reconnect electrical power to the oven.

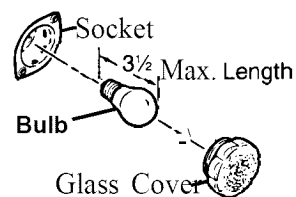

Control Panel

It's a good idea to wipe the control panel after each use. Clean with mild soap and water or vinegar and water, rinse with clean water and polish dry with a soft cloth.

Do not use abrasive cleansers, strong liquid cleansers, plastic scouring pads or oven cleansers on the control panel—they will damage the finish. A 50/50 solution of vinegar and hot water solution works well.

(continued next page)

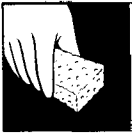

CARE AND CLEANING

(continued)

Lift-Off Oven Door

The oven door is removable, but it is heavy. You may need help removing and replacing the door. Do not lift the door by the handle. This can cause the glass to break or can cause damage to the door.

To remove the door, open it a few inches to the special stop position that will hold the door open. Grasp firmly on each side and lift the door straight up and off the hinges.

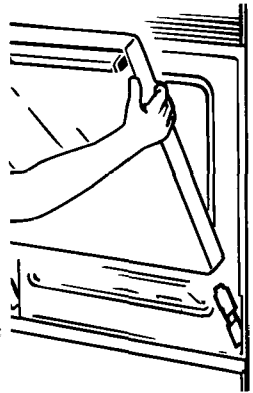

NOTE:

- Be careful not to place hands between the hinge and the oven door frame.
- While working in the oven area, cover the hinges with towels or empty paper towel rolls to prevent pinched fingers.

To replace the door, make sure the hinges are in the special stop position. Position the slots in the bottom of the door squarely over the hinges. Then lower the door slowly and evenly over both hinges at the same time. If hinges snap back towards the oven frame, pull them back out.

TO CLEAN THE DOOR:

Inside of the door:

- Because the area inside the gasket is cleaned during the self clean cycle, you do not need to clean this by hand. Any soap left on the liner causes additional stains when the oven is heated.
- The area outside the gasket can be cleaned with a scouring pad.
- Do not rub or clean the door gasket—the fiberglass material of the gasket has an extremely low resistance to abrasion. An intact and well-fitting oven door gasket is essential for energy-efficient oven operation and good baking results. If you notice the gasket becoming worn, frayed or damaged in any way or if it has become displaced on the door, you should have it replaced.

NOTE: The gasket is designed with a gap at the bottom to allow for proper air circulation.

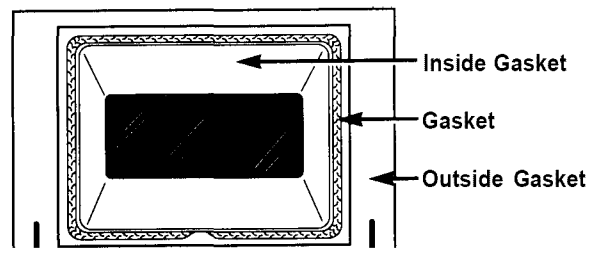

Outside of the door:

- Use soap and water to thoroughly clean the top, sides and front of the oven door. Rinse well. You may also use a glass cleaner to clean the glass on the outside of the door.

Oven Heating Elements

Do not clean the bake element or the broil element. Any soil will burn off when the elements are heated.

The bake element can be lifted gently to clean the oven floor. If spillovers, residue or ash accumulate around the bake element gently wipe around the element with warm water.

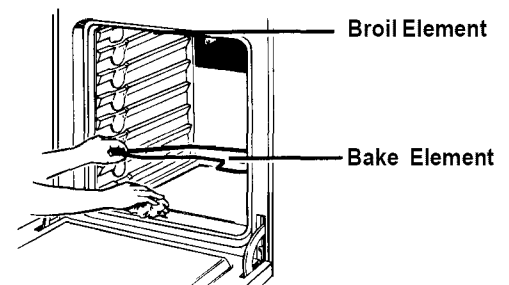

QUESTIONS? USE THIS PROBLEM SOLVER



| PROBLEM | POSSIBLE CAUSE |
|--|---|
| "F-AND A NUMBER" FLASH IN THE DISPLAY | <ul style="list-style-type: none"> • This is function error code. Press the CLEAR/OFF pad. Allow the oven to cool one hour. Place the oven back into operation. If function error occurs again, disconnect power to the oven and call for service. |
| OVEN WILL NOT WORK | <ul style="list-style-type: none"> • The circuit breaker in your house has been tripped, or a fuse has been blown. • The oven controls are not properly set. |
| OVEN LIGHT DOES NOT WORK | <ul style="list-style-type: none"> • The light bulb is loose or defective. Tighten or replace. • The switch operating the oven light is broken. Call for service. |
| FOOD DOES NOT BROIL PROPERLY | <ul style="list-style-type: none"> • Oven controls not set properly. See the Broiling section. • Door not left open to the broil stop position as recommended. • Improper shelf position being used. See the Broiling Guide. • Food is being cooked on a hot pan. • Cookware is not suitable for broiling. • Low voltage. See the Broiling section. • Aluminum foil used on the broiler pan and rack has not been fitted properly and slit as recommended. |
| FOOD DOES NOT ROAST OR BAKE PROPERLY | <ul style="list-style-type: none"> • Oven controls not set properly. See the Baking or Roasting section. • Shelf position is incorrect. See the Roasting or Baking section. • Incorrect cookware or cookware of improper size is being used. • Oven thermostat needs adjustment. See the Adjust the Oven Thermostat—<i>Do It Yourself</i> section. |
| OVEN WILL NOT SELF-CLEAN | <ul style="list-style-type: none"> • Oven temperature is too high to set self-clean operation. Allow the oven to cool to room temperature and reset the controls. |
| DOOR WILL NOT OPEN AFTER SELF-CLEAN CYCLE | <ul style="list-style-type: none"> • When the temperature has fallen below the locking temperature door can be opened. |
| CONTROL SIGNALS AFTER ENTERING COOK TIME OR STOP TIME | <ul style="list-style-type: none"> • This is reminding you to enter a bake temperature. |
| OVEN TEMPERATURE TOO HOT OR TOO COLD | <ul style="list-style-type: none"> • Oven thermostat needs adjustment. See the Adjust the Oven Thermostat—<i>Do It Yourself</i> section. |
| "BURNING" OR "OILY" ODOR EMITTING FROM OVEN WHEN TURNED ON | <ul style="list-style-type: none"> • This is normal in a new oven and will disappear in time. To speed the process, set a self-clean cycle for a minimum of 3 hours. See the Operating the Self-Cleaning Oven section. |
| STRONG ODOR | <ul style="list-style-type: none"> • An odor from the insulation around the inside of the oven is normal for the first few times the oven is used. This is temporary. |

(continued next page)



THE PROBLEM SOLVER

(continued)

| PROBLEM | POSSIBLE CAUSE |
|-------------------------------------|---|
| OVEN NOT CLEAN AFTER CLEAN CYCLE | <ul style="list-style-type: none">•Oven controls not set properly. See the Operating the Self-Cleaning Oven section.•Heavily soiled ovens require 3½-to 4-hour Clean Time.•Heavy spillovers should be cleaned up before starting clean cycle. |
| “door” APPEARS IN THE DISPLAY | <ul style="list-style-type: none">•Oven door not closed after self-clean cycle is selected.•Door is still locked and you are trying to enter an oven cooking operation. |
| FAN NOISE | <ul style="list-style-type: none">•A fan may turn on and off to cool internal parts. This is normal and the fan may continue to run even after the oven is turned off. |

If you need more help...
call, toll free:
GE Answer Center®
800.626.2000
consumer information service

We'll Be There

With the purchase of your new GE appliance, receive the assurance that if you ever need information or assistance from GE, we'll be there. All you have to do is call—toll-free!

In-Home Repair Service ***800-GE-CARES (800-432-2737)***

A GE consumer service professional will provide expert repair service, scheduled at a time that's convenient for you. Many GE Consumer Service company-operated locations offer you service today or tomorrow, or at your convenience (7:00 a.m. to 7:00 p.m. weekdays, 9:00 a.m. to 2:00 p.m. Saturdays). Our factory-trained technicians know your appliance inside and out—so most repairs can be handled in just 1 visit.

GE Answer Center® ***800.626.2000***

Whatever your question about any GE major appliance, GE Answer Center® information service is available to help. Your call—and your question—will be answered promptly and courteously. And you can call any time. GE Answer Center® service is open 24 hours a day, 7 days a week.

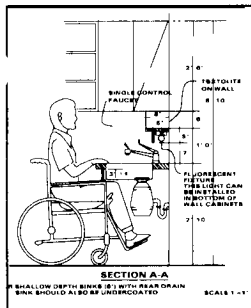

For Customers With Special Needs...

Upon request, GE will provide Braille controls for a variety of GE appliances, and a brochure to assist in planning a barrier-free kitchen for persons with limited mobility. To obtain these items, free of charge, call 800.626.2000.

Consumers with impaired hearing or speech who have access to a TDD or a conventional teletypewriter may call 800-TDD-GEAC (800-833-4322) to request information or service.

Service Contracts ***800-626-2224***

You can have the secure feeling that GE Consumer Service will still be there after your warranty expires. Purchase a GE contract while your warranty is still in effect and you'll receive a substantial discount. With a multiple-year contract, you're assured of future service at today's prices.

Parts and Accessories ***800-626-2002***

Individuals qualified to service their own appliances can have needed parts or accessories sent directly to their home. The GE parts system provides access to over 47,000 parts...and all GE Genuine Renewal Parts are fully warranted. VISA, MasterCard and Discover cards are accepted.

User maintenance instructions contained in this booklet cover procedures intended to be performed by any user. Other servicing generally should be referred to qualified service personnel. Caution must be exercised, since improper servicing may cause unsafe operation.

YOUR GE BUILT-IN OVEN WARRANTY

Staple sales slip or cancelled check here. Proof of original purchase date is needed to obtain service under warranty.

WHAT IS COVERED

FULL ONE-YEAR WARRANTY

For one year from date of original purchase, we will provide, free of charge, parts and service labor in your home to repair or replace **any part of the oven** that fails because of a manufacturing defect.

This warranty is extended to the original purchaser and any succeeding owner for products purchased for ordinary home use in the 48 mainland states, Hawaii and Washington, D.C. In Alaska the warranty is the same except that it is LIMITED because you must pay to ship the product to the service shop or for the service technician's travel costs to your home.

All warranty service will be provided by our Factory Service Centers or by our authorized Customer Care® servicers during normal working hours.

Should your appliance need service, during warranty period or beyond, call 800-GE-CARES (800-432-2737).

WHAT IS NOT COVERED

- Service trips to your home to teach you how to use the product.

Read your Use and Care material. If you then have any questions about operating the product please contact your dealer or our Consumer Affairs office at the address below, or call, toll free:

GE Answer Center®
800.626.2000
consumer information service

- Improper installation.

If you have an installation problem, contact your dealer or installer. You are responsible for providing adequate electrical, gas, exhausting and other connecting facilities as described in the Installation Instructions provided with the product.

- Replacement of house fuses or resetting of circuit breakers.
- Failure of the product if it is used for other than its intended purpose or used commercially.
- Damage to product caused by accident, fire, floods or acts of God.

WARRANTOR IS NOT RESPONSIBLE FOR CONSEQUENTIAL DAMAGES.

Some states do not allow the exclusion or limitation of incidental or consequential damages, so the above limitation or exclusion may not apply to you. This warranty gives you specific legal rights, and you may also have other rights which vary from state to state. To know what your legal rights are in your state, consult your local or state consumer affairs office or your state's Attorney General.

Warrantor: General Electric Company

**If further help is needed concerning this warranty, write:
Manager—Consumer Affairs, GE Appliances, Louisville, KY 40225**



Recycled Paper

Part No. 164 D2966P102

Pub No. 49-8582

10-94 CG

JTP1
JTP1

Printed in LaFayette, C