

Operator's Manual



18cc/1.1 cu. in. 2-Cycle **GASOLINE HEDGE TRIMMER**

Model No.

358.795690 – 18" Blade

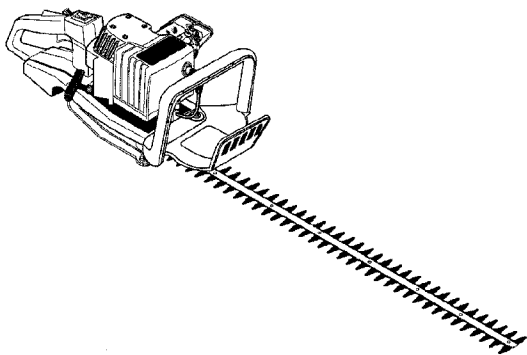

WARNING:

Read and follow all Safety Rules and Operating Instructions before first use of this product.



For answers to your questions about this product:
Call 7 am-7 pm, Mon-Sat; 10 am-7 pm, Sun

1-800-235-5878 (Hours listed are Central Time)

Sears, Roebuck and Co., Hoffman Estates, IL 60179 U.S.A.

SAFETY

ASSEMBLY

OPERATION

MAINTENANCE

PARTS LIST

ESPAÑOL

TABLE OF CONTENTS

Warranty Statement	2	Storage	9
Safety Rules	2	Troubleshooting Table	10
Assembly	4	Emissions Statement	10
Operation	5	Repair Parts List	12
Maintenance	7	Spanish	14
Service & Adjustments	8	Parts and Ordering	Back

WARRANTY STATEMENT

FULL ONE YEAR WARRANTY ON CRAFTSMAN® GAS POWERED HEDGE TRIMMER

For one (1) year from the date of purchase, when this Craftsman Gas Powered Hedge Trimmer is maintained, lubricated, and tuned up according to the operating and maintenance instructions in the operator's manual, Sears will repair, free of charge, any defects in materials or workmanship.

This warranty excludes spark plug, air filter, and the blade which are expendable parts and may become worn during normal use.

If this Hedge Trimmer is used for commercial purposes, this warranty applies for only 90 days from the date of purchase. If this Hedge Trimmer is used for rental purposes, this warranty applies for only 30 days from the date of purchase. This warranty applies only while this product is in use in the United States.

WARRANTY SERVICE IS AVAILABLE BY RETURNING THE HEDGE TRIMMER TO THE NEAREST SEARS SERVICE CENTER IN THE UNITED STATES.

This warranty gives you specific legal rights, and you may also have other rights which vary from state to state.





Sears, Roebuck and Co., Dept. 817WA, Hoffman Estates, IL 60179

SAFETY RULES

⚠ DANGER - THIS POWER TOOL CAN BE DANGEROUS! This unit can cause serious injury including amputation or blindness to the operator and others. The warnings and safety instructions in this manual must be

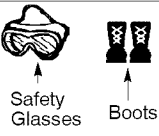
followed to provide reasonable safety and efficiency in using this unit.

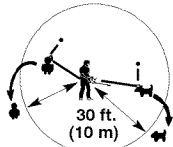
The operator is responsible for following the warnings and instructions in this manual and on the unit. Never allow children to use this tool.

 <p>Safety Glasses Boots</p>		<p>⚠ WARNING:</p> <p>Blades can throw objects violently.</p> <ul style="list-style-type: none"> • You can be blinded or injured. • Wear safety glasses.
		<p>⚠ WARNING:</p> <p>Hazard zone for thrown objects</p> <ul style="list-style-type: none"> • Blades can throw objects violently. • Others can be blinded or injured. • Keep people and animals 30 feet (10 m) away.
 <p>Blades move momentarily after the trigger is released.</p>	 <p>Allow blades to stop before removing them from the cut.</p>	<p>⚠ WARNING:</p> <p>Blades move momentarily after the trigger is released.</p> <ul style="list-style-type: none"> • The blades can seriously cut you or others. • Allow blades to stop before removing them from the cut.

⚠ WARNING: Failure to follow all Safety Rules and Precautions can result in serious injury.

KNOW YOUR UNIT

- Read your Operator's Manual carefully until you completely understand and can follow all warnings and safety rules before operating the unit.
- Restrict unit to users who understand and will follow all warnings and safety rules in this manual and on the unit.

PLAN AHEAD

- Always wear eye protection when operating, servicing, or performing maintenance on unit. Wearing eye protection will help to prevent brush or debris from being thrown or ricocheting into eyes and face which can result in blindness and/or serious injury.
- Wear hearing protection when using this unit.
- Secure hair above shoulder length. Secure or remove jewelry, loose clothing, or clothing with loosely hanging straps, ties, tassels, etc. They can be caught in moving parts.
- Do not operate unit when you are tired, ill, upset, or if you are under the influence of alcohol, drugs, or medication.
- Keep children, bystanders, and animals away from work area a minimum of 30 feet (10 m) when starting or operating unit.
- Inspect the area before starting the unit. Remove all debris and hard objects such as rocks, glass, wire, etc. that can ricochet, be thrown, or otherwise cause injury or damage during operation.

HANDLE FUEL WITH CAUTION

- Eliminate all sources of sparks or flame (including smoking, open flames, or work that can cause sparks) in the areas where fuel is mixed, poured, or stored.
- Mix and pour fuel in an outdoor area; store fuel in a cool, dry, well ventilated place; use an approved, marked container for all fuel purposes.
- Do not smoke while handling fuel or while operating the unit.
- Do not fill fuel tank while engine is running.
- Wipe up fuel spills before starting the engine.

- Move at least 10 feet (3 meters) away from fuel and fueling site before starting engine.

OPERATE YOUR UNIT SAFELY

- Inspect unit before each use for worn, loose, missing, or damaged parts. Do not use until unit is in proper working order.
- Keep outside surfaces free from oil and fuel.

⚠ DANGER: RISK OF CUT; KEEP HANDS AWAY FROM BLADE-Blade moves momentarily after the trigger is released. Do not attempt to clear away cut material when the blade is in motion. Make sure the switch is in the OFF position, the spark plug wire is disconnected, and the blade has stopped moving before removing jammed material from the cutting blade. Do not grab or hold the unit by the cutting blade.

- Never start or run engine inside a closed room or building. Breathing exhaust fumes can kill.
- Avoid dangerous environments. Do not use in unventilated areas or where explosive vapors or carbon monoxide build up could be present.
- Do not overreach or use from unstable surfaces such as ladders, trees, steep slopes, rooftops, etc. Keep firm footing and balance at all times.
- Do not raise unit above your shoulders; the cutting blade can come dangerously close to your body.
- Always keep unit in front of your body. Keep all parts of your body away from the cutting blade.
- Keep the cutting blade and air vents free from debris.
- Use only for jobs explained in this manual.

MAINTAIN YOUR UNIT PROPERLY

- Have all maintenance other than the recommended procedures described in the Operator's Manual performed by Sears Service.
- Disconnect spark plug before performing maintenance except for carburetor adjustments.
- Do not use a cutting blade that is bent, warped, cracked, broken, or damaged in any other way. Have worn or damaged parts replaced by your Sears Service Center.

- Use only recommended Craftsman cutting blades and replacement parts; use of any other parts may void your warranty and cause damage to your unit.
- Empty fuel tank before storing the unit. Use up fuel left in carburetor by starting engine and letting it run until it stops.
- Hand carry the unit with the engine stopped and the muffler and cutting blade away from your body.
- Allow engine to cool, empty the fuel tank, and secure the unit before storing or transporting it in a vehicle.
- Do not store the unit or fuel in a closed area where fuel vapors can reach sparks or an open flame from hot water heaters, electric motors or switches, furnaces, etc.
- Store the unit so the cutting blade cannot accidentally cause injury.
- Store in a dry area out of reach of children.

SPECIAL NOTICE: Your hedge trimmer is equipped with a temperature limiting muffler and spark arresting screen which meets the requirements of California Codes 4442 and 4443. All U.S. forest land and the states of California, Idaho, Maine, Minnesota, New Jersey, Oregon, and Washington require by law that many internal combustion engines be equipped with a

spark arresting screen. If you operate a hedge trimmer in a state or locale where such regulations exist, you are legally responsible for maintaining the operating condition of these parts. Failure to do so is a violation of the law. For normal homeowner use, the muffler and spark arresting screen will not require any service. After 50 hours of use, we recommend that your muffler be serviced or replaced by your Sears Service Center.

SAFETY NOTICE: Exposure to vibrations through prolonged use of gasoline powered hand tools could cause blood vessel or nerve damage in the fingers, hands, and joints of people prone to circulation disorders or abnormal swelling. Prolonged use in cold weather has been linked to blood vessel damage in otherwise healthy people. If symptoms occur such as numbness, pain, loss of strength, change in skin color or texture, or loss of feeling in the fingers, hands, or joints, discontinue the use of this tool and seek medical attention. An antivibration system does not guarantee the avoidance of these problems. Users who operate power tools on a continual and regular basis must monitor closely their physical condition and the condition of this tool.

ASSEMBLY

CARTON CONTENTS

Check carton contents against the following list.

Model 358.795690

- Hedge Trimmer
- 2-Cycle Engine Oil

NOTE: It is normal for the fuel filter to rattle in the empty fuel tank.

ASSEMBLY

No assembly is required.

OPERATION

KNOW YOUR HEDGE TRIMMER

READ THIS OPERATOR'S MANUAL AND SAFETY RULES BEFORE OPERATING YOUR UNIT. Compare the illustrations with your unit to familiarize yourself with the location of the various controls and adjustments. Save this manual for future reference.

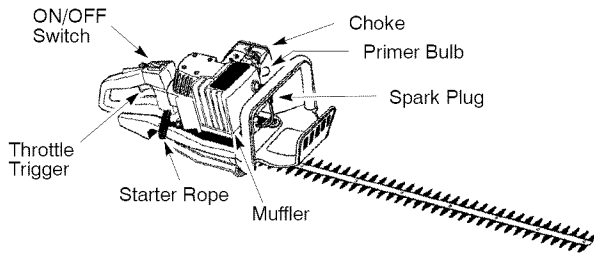

ON/STOP SWITCH

The ON/OFF SWITCH is used to stop the engine. To stop engine, move switch to OFF.

CHOKE

The CHOKE helps to supply fuel to the carburetor to aid in cold starting. Activate the choke by moving choke lever to the desired position. See STARTING YOUR ENGINE for complete starting information.

PRIMER BULB

The PRIMER BULB removes air from the carburetor and fuel lines and fills them with fuel. This allows you to start the engine with fewer pulls on the starter rope. Activate the primer bulb by pressing it and allowing it to return to its original position.

THROTTLE TRIGGER

The THROTTLE TRIGGER controls engine speed. Squeeze the trigger for full speed operation; release it for idle speed.

BEFORE STARTING ENGINE

WARNING: Be sure to read the fuel information in the safety rules before you begin. If you do not understand the safety rules, do not attempt to fuel your unit. Call 1-800-235-5878.

FUELING ENGINE

This engine is certified to operate on unleaded gasoline. Before operation, gasoline must be mixed with a good quality 2-cycle air-cooled engine oil. We recommend Craftsman brand oil. Mix gasoline and oil at a ratio of 40:1 (A 40:1 ratio is obtained by mixing 3.2 ounces of oil with 1 gallon of unleaded gasoline). DO NOT USE automotive oil or boat oil. These oils will cause engine damage. When mixing fuel, follow instructions printed on oil container. Once oil is added to gasoline, shake container momentarily to assure that the fuel is thoroughly mixed. Always

read and follow the safety rules relating to fuel before fueling your unit.

IMPORTANT

Experience indicates that alcohol blended fuels (called gasohol or using ethanol or methanol) can attract moisture which leads to separation and formation of acids during storage. Acidic gas can damage the fuel system of an engine while in storage.

To avoid engine problems, empty the fuel system before storage for 30 days or longer. Drain the gas tank, start the engine and let it run until the fuel lines and carburetor are empty. Use fresh fuel next season.

Never use engine or carburetor cleaner products in the fuel tank or permanent damage may occur.

Fuel stabilizer is an acceptable alternative in minimizing the formation of fuel gum deposits during storage.

Craftsman brand oil is already blended with fuel stabilizer. See the STORAGE section for additional information.

OPERATING POSITION

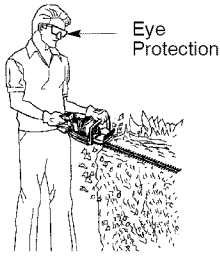

STOPPING YOUR ENGINE

- To stop engine, move switch to OFF.

BEFORE STARTING THE ENGINE

- Fuel engine. Move at least 10 feet (3 meters) away from the fueling site.
- Hold the unit on the ground in the starting position as shown. Support unit so the blade is off of the ground and away from trees, bushes, on-lookers, etc.

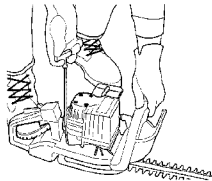

STARTING A COLD ENGINE (or a warm engine after running out of fuel)

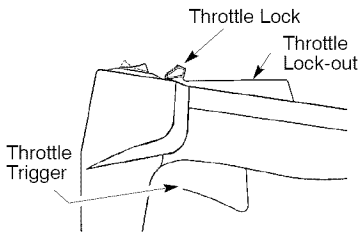

1. Engage the throttle lock as follows:
 - press the throttle lock-out
 - squeeze and hold throttle trigger
 - press and hold throttle lock
 - release the throttle trigger

Keep the throttle lock engaged until the engine runs smoothly.

2. Make sure switch is in ON position.

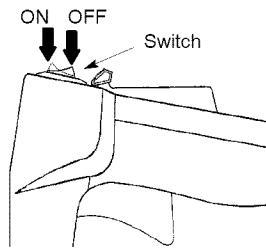

3. Slowly press the primer bulb 6 times.
4. Move the choke lever to FULL CHOKE.

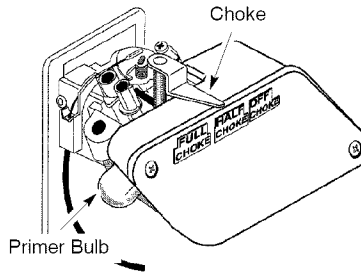

5. Pull starter rope handle sharply 6 times.

NOTE: The engine may sound as if it is trying to start before 6th pull. If so, go to the next step immediately.

6. Move the choke lever to HALF CHOKE.

7. Pull starter rope sharply until the engine runs, but no more than 6 pulls.

NOTE: If the engine has not started after 6 pulls (at HALF CHOKE), check to make sure the ON/OFF switch and the choke lever are in the proper positions. Then, move the choke lever to the FULL CHOKE position and press the primer bulb 6 times; pull the starter rope 2 more times. Move the choke lever to HALF CHOKE and pull the starter rope until the engine runs, but no more than 6 more pulls.

NOTE: If engine still has not started, it is probably flooded. Proceed to STARTING A FLOODED ENGINE.

8. Allow the engine to run 10 seconds, then move the choke lever to OFF CHOKE. Allow the unit to run for 30 more seconds at OFF CHOKE, then release the throttle lock by squeezing and releasing the trigger.

NOTE: If engine dies with the choke lever at the OFF CHOKE position, move the choke lever to HALF CHOKE and pull the rope until the engine runs.

9. To stop engine, move switch to OFF.

STARTING A WARM ENGINE

1. Make sure switch is in ON position.
2. Move the choke lever to HALF CHOKE.
3. Engage the throttle lock as directed in STARTING A COLD ENGINE. *Keep the throttle lock engaged until the engine runs smoothly.*
4. Pull starter rope sharply until engine runs, but no more than 5 pulls.
5. Allow the engine to run 10 seconds, then move the choke lever to OFF CHOKE. Release the throttle lock by squeezing and releasing the trigger.

NOTE: If engine has not started, pull starter rope 5 more pulls. If engine still does not run, it is probably flooded.

Proceed to STARTING A FLOODED ENGINE.

STARTING A FLOODED ENGINE

Flooded engines can be started by placing the switch in the ON position and the choke lever in the OFF CHOKE position; then, pull the rope to clear the engine of excess fuel.

Starting could require pulling the starter rope many times depending on how badly the unit is flooded. If the unit still doesn't start, refer to the TROUBLE-SHOOTING TABLE or call 1-800-235-5878.

MAINTENANCE

⚠ WARNING: Disconnect the spark plug before performing maintenance except for carburetor adjustments.

CUSTOMER RESPONSIBILITIES

CARE & MAINTENANCE TASK	WHEN TO PERFORM
Check for loose fasteners and parts	Before each use
Check for damaged or worn parts	Before each use
Inspect and clean unit and labels	After each use
Clean air filter	Every 5 hours of operation
Replace spark plug	Yearly
Replace fuel filter	Yearly

GENERAL RECOMMENDATIONS

The warranty on this unit does not cover items that have been subjected to operator abuse or negligence. To receive full value from the warranty, the operator must maintain unit as instructed in this manual. Various adjustments will need to be made periodically to properly maintain your unit.

CHECK FOR LOOSE FASTENERS AND PARTS

- Spark Plug Boot
- Air Filter
- Housing Screws

CHECK FOR DAMAGED OR WORN PARTS

Refer replacement of damaged/worn parts to your Sears Service Center.

- ON/OFF Switch - Ensure ON/OFF switch functions properly by moving the switch to the OFF position. Make

sure engine stops; then restart engine and continue.

- Fuel Tank - Do not use unit if fuel tank shows signs of damage or leaks.

INSPECT AND CLEAN UNIT AND LABELS

- After each use, inspect complete unit for loose or damaged parts. Clean the unit and labels using a damp cloth with a mild detergent.
- Wipe off unit with a clean dry cloth.

CLEAN AIR FILTER

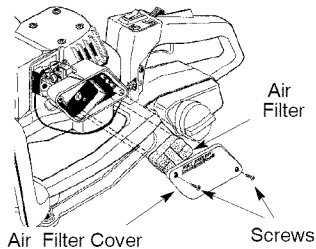

Cleaning the air filter:

A dirty air filter decreases engine performance and increases fuel consumption and harmful emissions. Always clean after every 5 hours of operation.

1. Clean the cover and the area around it to keep debris from falling into the carburetor chamber when the cover is removed.
2. Remove parts as illustrated.

NOTE: Do not clean filter in gasoline or other flammable solvent. Doing so can create a fire hazard or produce harmful evaporative emissions.

3. Wash the filter in soap and water.
4. Allow filter to dry.
5. Add a few drops of oil to the filter; squeeze filter to distribute oil.
6. Replace parts.

REPLACE SPARK PLUG

Replace spark plug each year to ensure the engine starts easier and runs better. Set spark plug gap at 0.025 in. Ignition timing is fixed, nonadjustable.

1. Twist, then pull off spark plug boot.
2. Remove spark plug from cylinder and discard.
3. Replace with Champion RCJ-8Y spark plug and tighten with a 3/4 in. socket wrench (10-12 ft.-lbs).
4. Reinstall the spark plug boot.

REPLACE FUEL FILTER

To replace fuel filter, drain unit by running it dry of fuel, then remove fuel cap and its connected retainer from tank. Pull filter from tank and remove it from the fuel line. Install new fuel filter on fuel line; reinstall parts.

SERVICE AND ADJUSTMENTS

We recommend all service and adjustments not listed in this manual be performed by your Sears Service Center.

CARBURETOR ADJUSTMENT

Carburetor adjustment is critical and if done improperly can permanently damage the engine as well as the carburetor. If you require further assistance or are unsure about performing this procedure, call our customer assistance help line at 1-800-235-5878.

Old fuel, a dirty air filter, a dirty fuel filter, or flooding may give the impression of an improperly adjusted carburetor. Check these conditions before adjusting the carburetor.

The carburetor has been carefully set at the factory. Adjustments may be necessary if you notice any of the following conditions:

- Engine will not idle. See **IDLE SPEED** and **MIXTURE** under adjusting procedure.
- Engine dies or hesitates instead of accelerating. See **ACCELERATION CHECK** under adjusting procedure.
- Loss of power. See **MIXTURE** under adjusting procedure.

ADJUSTING PROCEDURE

CAUTION: Do not force plastic limiter caps beyond the built-in stops or damage will occur.

Initial Settings

1. Turn both mixture screws (L and H) counterclockwise until they stop.
2. Turn the idle speed screw clockwise until it stops. Now turn counterclockwise 4 1/2 turns.
3. Start motor and let it run for 3 minutes, then proceed to the adjust screws according to the instructions below. If engine performance at initial settings is acceptable, no further adjustments are necessary. If engine does not start, refer to **TROUBLESHOOTING TABLE**. If still unable to remedy situation, call 1-800-235-5878.

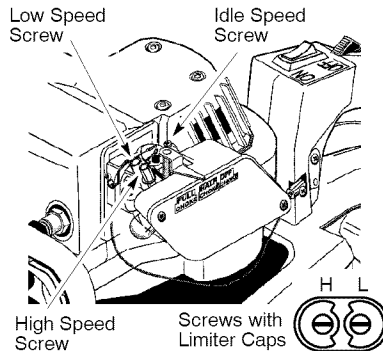

Idle Speed "IDLE"

Allow engine to idle. If the blade moves, idle speed is too fast. If the engine stalls, idle speed is too slow.

- Turn IDLE screw clockwise to increase idle speed.
- Turn IDLE screw counterclockwise to decrease idle speed.

⚠ WARNING: Recheck the idle speed after each adjustment. The blade must not move at idle speed to avoid serious injury to the operator and others.

Low Speed Mixture - L

1. Allow the engine to idle.
2. Turn low speed mixture screw (L) slowly clockwise until the speed starts to drop.
3. Turn the low speed mixture screw (L) counterclockwise until the speed increases and then starts to drop again.
4. Set the low speed mixture screw (L) at the midpoint between the two positions.

Readjust the idle speed (see IDLE SPEED ADJUSTMENT).

High Speed Mixture -H

CAUTION: Do not operate engine at full throttle for prolonged periods while mak-

ing high speed adjustments as damage to the engine can occur. Adjust the high speed screw 1/16 of a turn at a time. A 1/16 turn is about the width of the slot in the top of the screw.

1. Allow the engine to idle.
2. Squeeze the throttle trigger fully. Turn the high speed mixture screw (H) counterclockwise until it stops.
3. Turn the high speed mixture screw (H) screw the minimum amount clockwise until the engine runs smoothly.

After completing adjustments, check for acceleration and blade movement at idle. Reset if necessary.

Acceleration Check

If the engine dies or hesitates instead of accelerating, turn the low speed mixture screw (L) counterclockwise until you have smooth acceleration with no blade movement at idle.

CAUTION: If the engine does not operate according to these instructions after repeating the adjusting steps, do not use the unit. Take it to your Sears Service Center.

STORAGE

⚠ WARNING: Perform the following steps after each use:

- Allow engine to cool, and secure the unit before storing or transporting.
- Store unit and fuel in a well ventilated area where fuel vapors cannot reach sparks or open flames from water heaters, electric motors or switches, furnaces, etc.
- Store unit with all guards in place. Position unit so that any sharp object cannot accidentally cause injury.
- Store unit and fuel well out of the reach of children.

Prepare unit for storage at end of season or if it will not be used for 30 days or more.

EXTERNAL SURFACES

- If your unit is to be stored for a period of time, clean it thoroughly before storage. Store in a clean dry area.
- Lightly oil external metal surfaces, including the blade.

To oil the blade, do the following:

- Stop the engine and allow blade to come to a complete stop.

- Disconnect the spark plug wire.
- Clean all parts and check for damage. Have damaged parts repaired or replaced by your Sears Service Center.
- Apply a light machine oil along the edge of the top strap as shown.

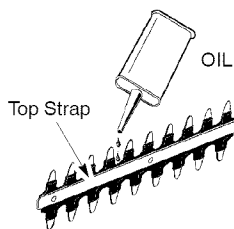

FUEL SYSTEM

Under FUELING ENGINE in the OPERATION section of this manual, see message labeled **IMPORTANT** regarding the use of gasohol in your engine. Fuel stabilizer is an acceptable alternative in minimizing the formation of fuel gum deposits during storage. Add stabilizer to gasoline in fuel tank or fuel storage container. Follow the mix instructions

found on stabilizer container. Run engine at least 5 minutes after adding stabilizer. Craftsman 40:1, 2-cycle engine oil (air cooled) is already blended with fuel stabilizer. If you do not use this Sears oil, you can add a fuel stabilizer to your fuel tank.

INTERNAL ENGINE

- Remove spark plug and pour 1 teaspoon of 40:1, 2-cycle engine oil (air cooled) through the spark plug opening. Slowly pull the starter rope 8 to 10 times to distribute oil.

TROUBLESHOOTING TABLE



WARNING: Always stop unit and disconnect spark plug before performing all of the recommended remedies below except remedies that require operation of the unit.

- Replace spark plug with new one of recommended type and heat range.
- Clean air filter.
- Check entire unit for loose screws, nuts, and bolts. Replace any damaged, broken, or worn parts.
- At the beginning of the next season, use only fresh fuel having the proper gasoline to oil ratio.

OTHER

- Do not store gasoline from one season to another.
- Replace your gasoline can if it starts to rust.

TROUBLE	CAUSE	REMEDY
Engine will not start.	<ol style="list-style-type: none"> 1. Engine flooded. 2. Fuel tank empty. 3. Spark plug not firing. 4. Fuel not reaching carburetor. <ol style="list-style-type: none"> 5. Compression low. 	<ol style="list-style-type: none"> 1. See "Starting a Flooded Engine" in Operation Section. 2. Fill tank with correct fuel mixture. 3. Install new spark plug. 4. Check for dirty fuel filter; replace. Check for kinked or split fuel line; repair or replace. 5. Contact Sears Service.
Engine will not idle properly.	<ol style="list-style-type: none"> 1. Carburetor requires adjustment. 2. Crankshaft seals worn. 3. Compression low. 	<ol style="list-style-type: none"> 1. See Service and Adjustments section. 2. Contact Sears Service. 3. Contact Sears Service.
Engine will not accelerate, lacks power, or dies under a load.	<ol style="list-style-type: none"> 1. Air filter dirty. 2. Spark plug fouled. 3. Carburetor requires adjustment. 4. Carbon build up. 5. Compression low. 	<ol style="list-style-type: none"> 1. Clean or replace air filter. 2. Clean or replace spark plug; re-gap. 3. See Service and Adjustments section. 4. Contact Sears Service. 5. Contact Sears Service.
Engine smokes excessively.	<ol style="list-style-type: none"> 1. Choke partially on. 2. Fuel mixture incorrect. <ol style="list-style-type: none"> 3. Air filter dirty. 4. Carburetor requires adjustment. 	<ol style="list-style-type: none"> 1. Adjust choke. 2. Empty fuel tank and refill with correct fuel mixture. 3. Clean or replace air filter. 4. See Service and Adjustments section.
Engine runs hot.	<ol style="list-style-type: none"> 1. Fuel mixture incorrect. 2. Spark plug incorrect. 3. Carburetor requires adjustment. 4. Carbon build up. 	<ol style="list-style-type: none"> 1. See "Fueling Engine." 2. Replace with correct spark plug. 3. See Service and Adjustments section. 4. Contact Sears Service.

If situations occur which are not covered in this manual, use care and good judgment. If you need assistance, contact your Sears Service Center or call the Customer Assistance Helpline at 1-800-235-5878.

U.S. EPA EMISSION CONTROL WARRANTY STATEMENT

YOUR WARRANTY RIGHTS AND OBLIGATIONS: The U. S. Environmental Protection Agency and Sears, Roebuck and Co., U.S.A., are pleased to explain the emissions control system warranty on your lawn and garden equipment engine. All new utility and lawn and garden equipment engines must be designed, built, and equipped to meet the stringent anti-smog standards. Sears must warrant the emission control system on your lawn and garden equipment engine for the periods of time listed below provided there has been no abuse, neglect, or improper maintenance of your lawn and garden equipment engine. Your emission control system includes parts such as the carburetor and the ignition system. Where a warrantable condition exists, Sears will repair your lawn and garden equipment engine at no cost to you. Expenses covered under warranty include diagnosis, parts and labor. **MANUFACTURER'S WARRANTY COVERAGE:** If any emissions related part on your engine (as listed under Emissions Control Warranty Parts List) is defective or a defect in the materials or workmanship of the engine causes the failure of such an emission related part, the part will be repaired or replaced by Sears. **OWNER'S WARRANTY RESPONSIBILITIES:** As the lawn and garden equipment engine owner, you are responsible for the performance of the required maintenance listed in your Owner's Manual. Sears recommends that you retain all receipts covering maintenance on your lawn and garden equipment engine, but Sears cannot deny warranty solely for the lack of receipts or for your failure to ensure the performance of all scheduled maintenance. As the lawn and garden equipment engine owner, you should be aware that Sears may deny you warranty coverage if your lawn and garden equipment engine or a part of it has failed due to abuse, neglect, improper maintenance, unapproved modifications, or the use of parts not made or approved by the original equipment manufacturer. You are responsible for presenting your lawn and garden equip-

ment engine to a Sears authorized repair center as soon as a problem exists. Warranty repairs should be completed in a reasonable amount of time, not to exceed 30 days. If you have any questions regarding your warranty rights and responsibilities, you should contact your nearest authorized service center or call Sears at 1-800-473-7247. **WARRANTY COMMENCEMENT DATE:** The warranty period begins on the date the lawn and garden equipment engine is purchased. **LENGTH OF COVERAGE:** This warranty shall be for a period of two years from the initial date of purchase. **WHAT IS COVERED: REPAIR OR REPLACEMENT OF PARTS:** Repair or replacement of any warranted part will be performed at no charge to the owner at an approved Sears servicing center. If you have any questions regarding your warranty rights and responsibilities, you should contact your nearest authorized service center or call Sears at 1-800-473-7247. **WARRANTY PERIOD:** Any warranted part which is not scheduled for replacement as required maintenance, or which is scheduled only for regular inspection to the effect of "repair or replace as necessary" shall be warranted for 2 years. Any warranted part which is scheduled for replacement as required maintenance shall be warranted for the period of time up to the first scheduled replacement point for that part. **DIAGNOSIS:** The owner shall not be charged for diagnostic labor which leads to the determination that a warranted part is defective if the diagnostic work is performed at an approved Sears servicing center. **CONSEQUENTIAL DAMAGES:** Sears may be liable for damages to other engine components caused by the failure of a warranted part still under warranty. **WHAT IS NOT COVERED:** All failures caused by abuse, neglect, or improper maintenance are not covered. **ADD-ON OR MODIFIED PARTS:** The use of add-on or modified parts can be grounds for disallowing a warranty claim. Sears is not liable to cover failures of warranted parts caused by the use of add-on or modified parts.

HOW TO FILE A CLAIM: If you have any questions regarding your warranty rights and responsibilities, you should contact your nearest authorized service center or call Sears at 1-800-473-7247. **WHERE TO GET WARRANTY SERVICE:** Warranty services or repairs shall be provided at all Sears service centers. call: 1-800-473-7247. **MAINTENANCE, REPLACEMENT AND REPAIR OF EMISSION RELATED PARTS:** Any Sears approved replacement part used

in the performance of any warranty maintenance or repair on emission related parts will be provided without charge to the owner if the part is under warranty. **EMISSION CONTROL WARRANTY PARTS LIST:** Carburetor, Ignition System; Spark Plug (covered up to maintenance schedule), Ignition Module. **MAINTENANCE STATEMENT:** The owner is responsible for the performance of all required maintenance as defined in the owner's manual.