

SERIES | 6  
6000

# LCD TV QUICK SETUP GUIDE

imagine the possibilities

Thank you for purchasing this Samsung product.  
To receive more complete service, please register  
your product at

[www.samsung.com/register](http://www.samsung.com/register)

Model \_\_\_\_\_ Serial No. \_\_\_\_\_

**SAMSUNG**

## The Supplied Accessories



Remote Control & Batteries (AAA x 2)



Warranty Card / Safety Guide

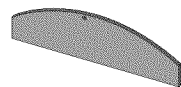

Cover-Bottom



USB (E-manual)



Cleaning Cloth



Stand Screw (M4xL10)  
UN40B6000, UN46B6000



Holder-Ring (4ea)



Holder-Wire Cable  
(Depending on the model)



TV-Holder & Screw (M8xL19)  
(Depending on the model)



Holder-Wire (3ea)



Holder-Wire stand

## Installing Batteries in the Remote Control

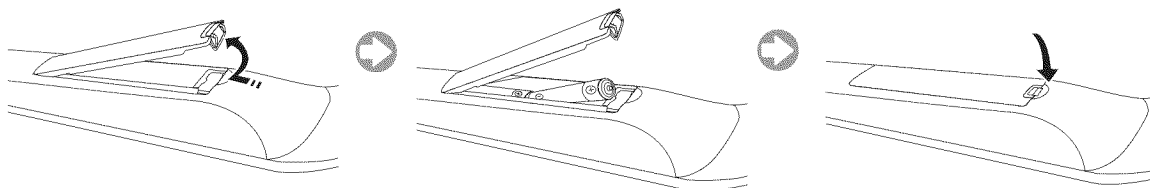

## Assembling the Cables

### □ Stand Type

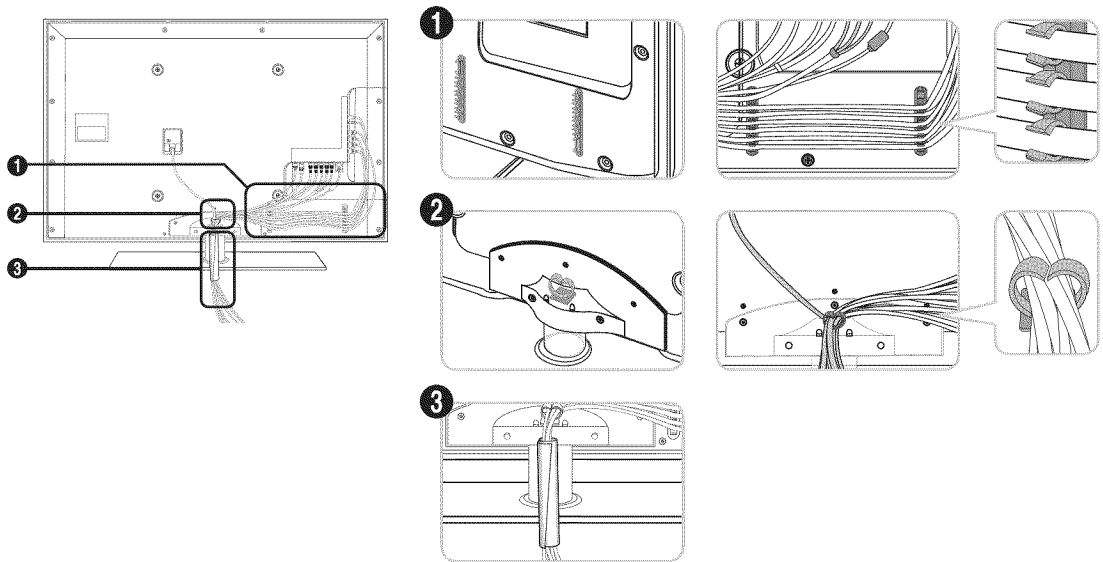

☑ Enclose the cables in the Holder-Wire Cable so that the cables are not visible through the transparent stand.

### □ Wall-Mount Type

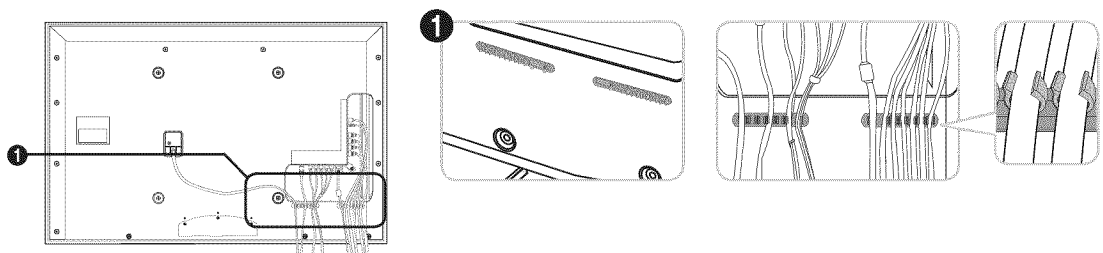

## Preparing before installing Wall-Mount

To install a wall-mount from another manufacturer, use the Holder-Ring ❶.

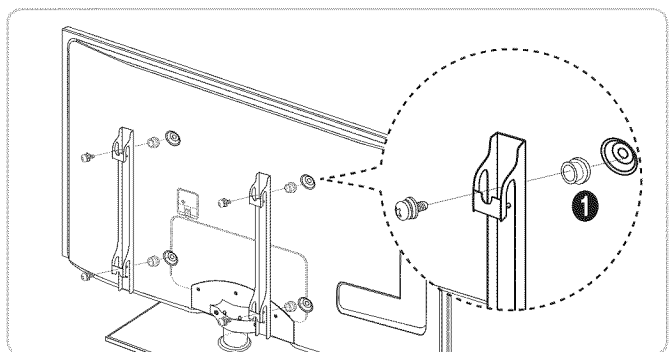

## Viewing the Menus

Before using the TV, follow the steps below to learn how to navigate the menu in order to select and adjust different functions.

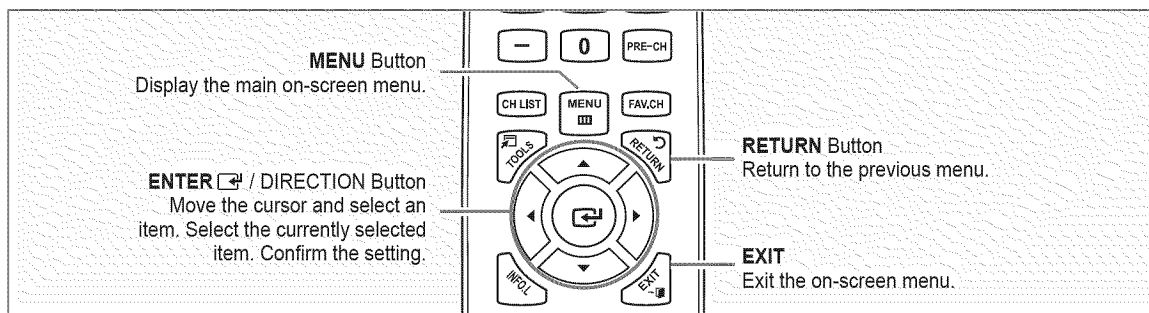

### ❑ Operation the OSD (On Screen Display)

The access step may differ depending on the selected menu.

1. Press the **MENU** button.

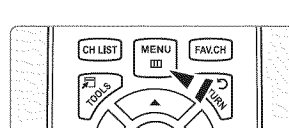

2. The main menu appears on the screen. The menu's left side has icons : **Picture, Sound, Channel, Setup, Input, Application, Support**.

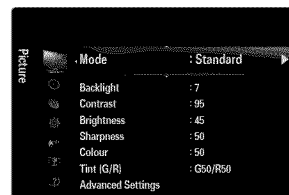

3. Press the **▲** or **▼** button to select one of the icons.
4. Then press the **ENTER ** button to access the icon's sub-menu.

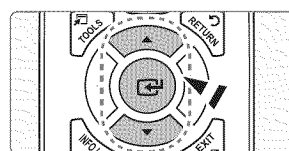

5. Press the **▲** or **▼** button to select the icon's submenu.

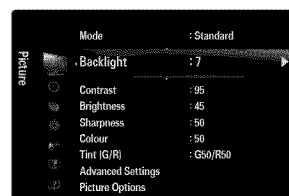

6. Press the **◀** or **▶** button to decrease or increase the value of a particular item. The adjustment OSD may differ depending on the selected menu.
7. Press the **ENTER ** button to complete the configuration.
8. Press the **EXIT** button to exit.



Help icon

## Plug & Play

When the TV is initially powered on, basic settings proceed automatically and subsequently.

- 🔍 **Preset:** Connecting the mains and antenna.

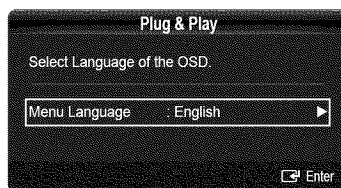
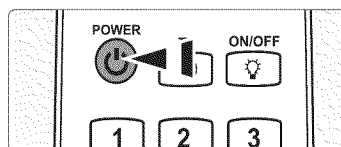
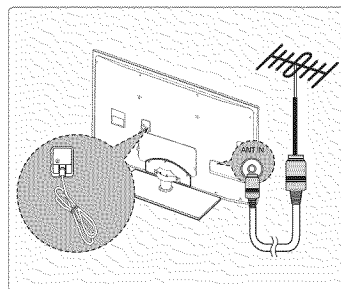

1. Press the **POWER** button on the remote control.
    - 🔍 You can also use the **POWER** button on the TV.
    - 🔍 The message **Select Language of the OSD.** is displayed.
  2. Press the **ENTER** button. Press the **▲** or **▼** button to select the language, then press the **ENTER** button. The message **Select 'Home Use' when installing this TV in your home.** is displayed.
  3. Press the **◀** or **▶** button to select **Store Demo** or **Home Use**, then press the **ENTER** button. The message **Select the Antenna source to memorize.** is displayed.
    - 🔍 We recommend setting the TV to **Home Use** mode for the best picture in your home environment.
    - 🔍 **Store Demo** mode is only intended for use in retail environments.
    - 🔍 If the unit is accidentally set to **Store Demo** mode and you want to return to **Home Use** (Standard); Press the volume button on the TV. When the volume OSD is displayed, press and hold the **MENU** button on the TV for 5 seconds.
  4. Press the **▲** or **▼** button to memorize the channels of the selected connection. Press the **ENTER** button to select **Start**.
    - 🔍 **Air:** Air antenna signal. / **Cable:** Cable antenna signal. / **Auto:** Air and Cable antenna signals.
    - 🔍 In Cable mode, you can select the correct signal source among **STD**, **HRC**, and **IRC** by pressing the **▲**, **▼**, **◀** or **▶** button, then press the **ENTER** button. If you have Digital cable, select the cable system signal source for both Analog and Digital. Contact your local cable company to identify the type of cable system that exists in your particular area.
  5. Press the **ENTER** button to select **Start**. The TV will begin memorizing all of the available channels.
    - 🔍 To stop the search before it has finished, press the **ENTER** button with **Stop** selected.
    - 🔍 After all the available channels are stored, it starts to remove scrambled channels. The Auto program menu then reappears. Press the **ENTER** button when channel memorization is complete. The message **Set the Clock Mode.** is displayed.
  6. Press the **ENTER** button. Press the **▲** or **▼** button to select **Auto**, then Press the **ENTER** button. The message **Set to daylight saving time.** is displayed. If you select **Manual**, **Set current date and time.** is displayed.
  7. Press the **▲** or **▼** button to select **Off**, **On** or **Auto**, then press the **ENTER** button.
  8. Press the **▲** or **▼** button to highlight the time zone for your local area. Press the **ENTER** button. If you have received a digital signal, the time will be set automatically. If not, refer to the 'Setting the Time' instructions to set the clock.
  9. The description for the connection method providing the best HD screen quality is displayed. Check the description and press the **ENTER** button.
  10. The message **Enjoy your TV.** is displayed. When you have finished, press the **ENTER** button.
- If you want to reset this feature...**
1. Press the **MENU** button to display the menu. Press the **▲** or **▼** button to select **Setup**, then press the **ENTER** button.
  3. Press the **ENTER** button again to select Plug & Play.
    - 🔍 The **Plug & Play** feature is only available in the TV mode.

# Installing the USB Memory Drive to view the e-manual

## □ Viewing the Menus

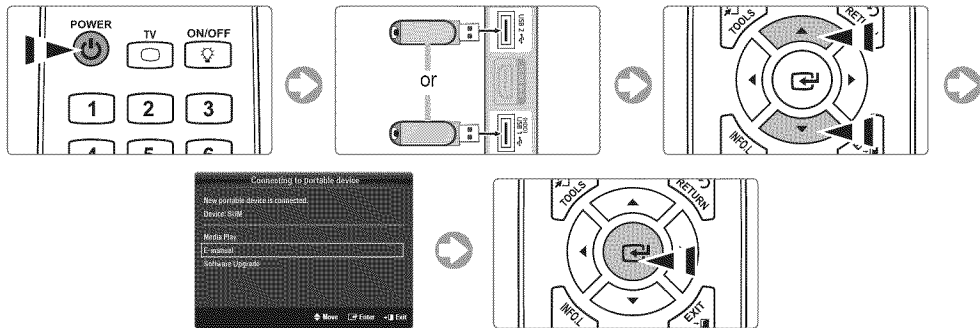

## □ Screen Display

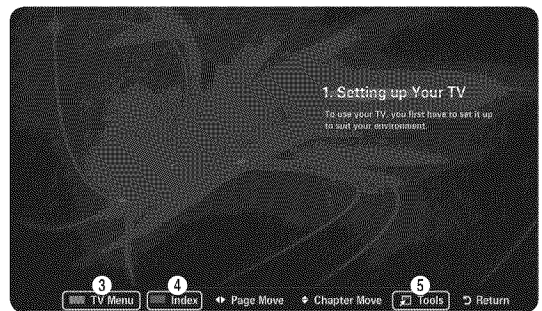
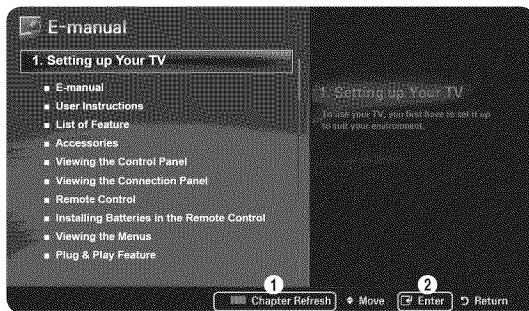

- ① Refresh the chapter window.
- ② Move to selected menu

- ③ Move to TV OSD menu
- ④ Use the index menu
- ⑤ Run various functions from the E-manual.



**Caution: using USB(E-manual)**  
Use only for E-manual  
To use for other purposes may cause malfunction.  
Recommends to rewrite below 5 times.

## Troubleshooting

Problem	Solution
When the e-manual isn't operated promptly	Check the USB connection status on TV.
When you lose the USB	Contact your local dealer
When the manual on the USB is deleted	Connect to <a href="http://www.samsung.com">www.samsung.com</a>
No sound or picture	Check that the mains lead has been connected to a wall socket. Check that you have pressed the button on your set. Check the picture contrast and brightness settings. Check the volume.
Normal picture but no sound	Check the volume. Check whether the <b>MUTE</b> button has been pressed on the remote control. Check the Speaker Select settings.

# Connecting a AV device

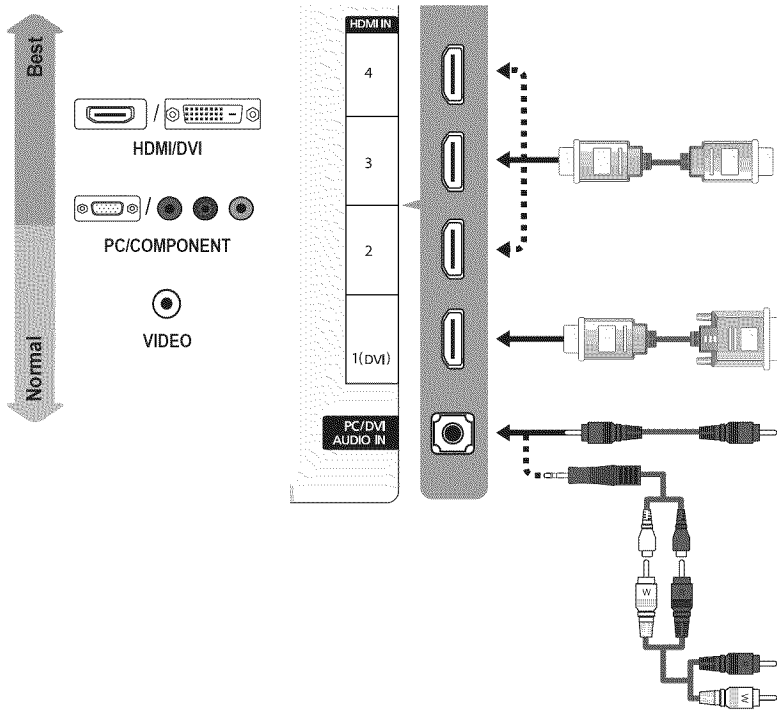

## ★ HD connection

**Using an HDMI Cable**

DVD / Blu-Ray player / HD Cable Box / HD Satellite receiver (STB)

HDMI OUT

## ★ HD connection

**Using a DVI Cable**

DVD / Blu-Ray player / Cable Box / Satellite receiver (STB)

DVI OUT AUDIO OUT

or

DVI OUT AUDIO OUT

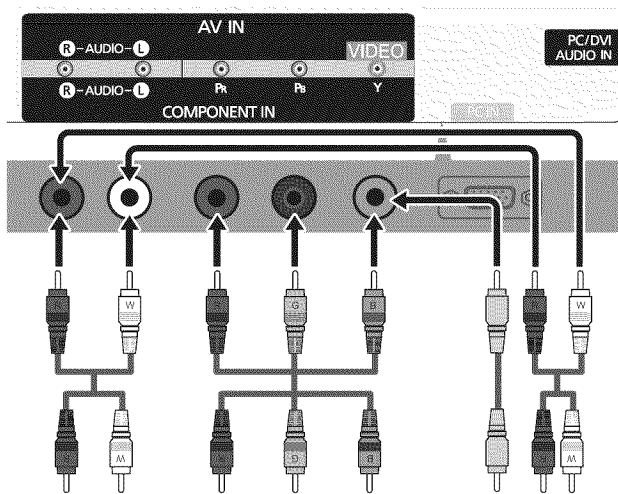

## Component connection

**Using a Component Cable**

DVD / Blu-Ray player / Cable Box / Satellite receiver

AUDIO OUT COMPONENT OUT

## Audio/Video connection

**Using an Audio/Video Cable**

VCR

VIDEO OUT AUDIO OUT

## Connecting an audio device

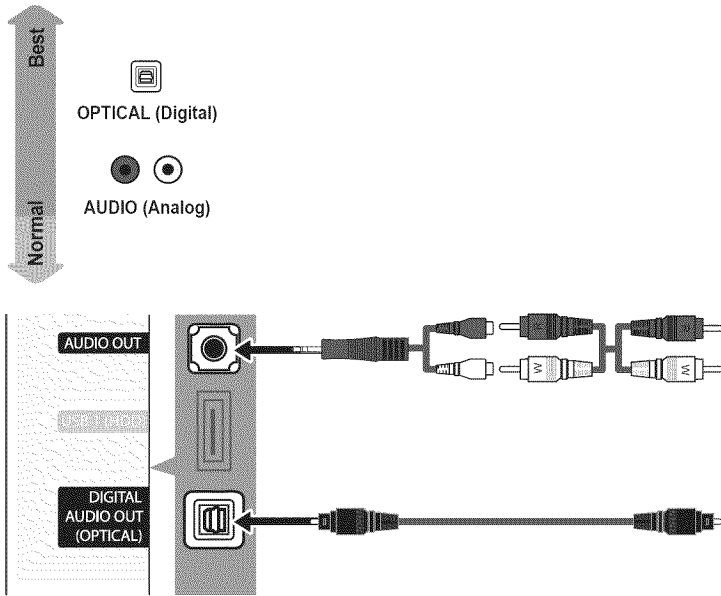

### Analog Audio connection

#### Using a Audio Cable

Amplifier / DVD Home Theater

AUDIO IN

### ★ Digital Audio connection

#### Using an Optical Cable

Digital Audio System

OPTICAL

## Connecting a PC

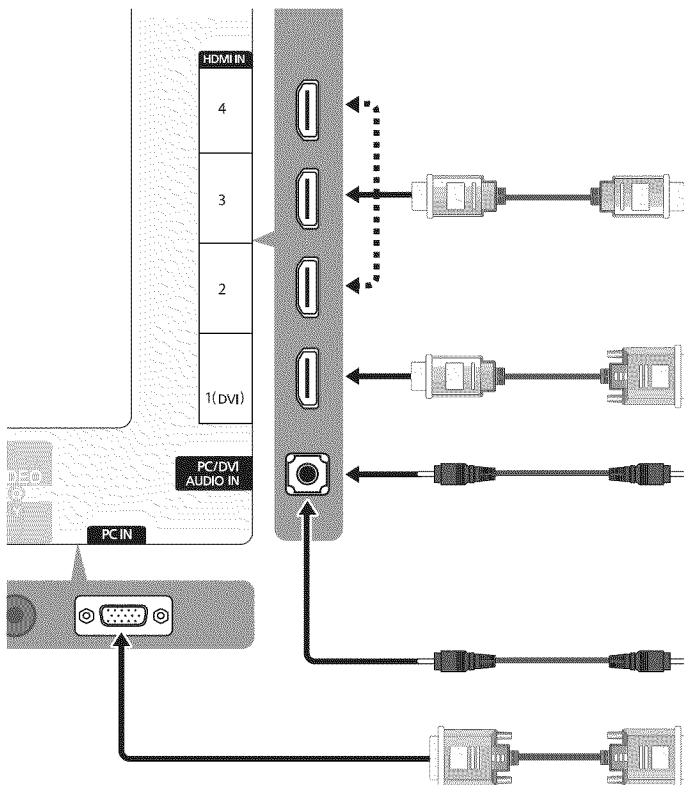

### ★ HD connection

#### Using an HDMI Cable

HDMI OUT

### ★ HD connection

#### Using an HDMI/DVI Cable

AUDIO OUT

DVI OUT

#### Using a D-Sub Cable

AUDIO OUT

PC OUT



## Accesorios incluidos



Mando a distancia y  
2 pilas AAA



Tarjeta de garantía/  
Guía de seguridad

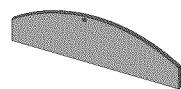

Cubierta del orificio inferior



USB (manual electrónico)



Paño de limpieza



Tornillo del soporte (M4xL10)  
UN40B6000, UN46B6000



Soporte - Anilla (4 unid.)



Soporte de cables  
(Según el modelo)



Soporte del televisor y tornillos (M8xL19)  
(Según el modelo)



Soporte de cables (3 unid.)



Soporte de cables

## Instalación de las pilas en el mando a distancia

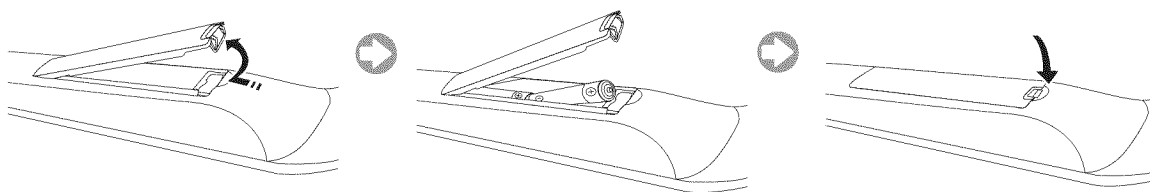

## Montaje de los cables

### ❑ Tipo soporte

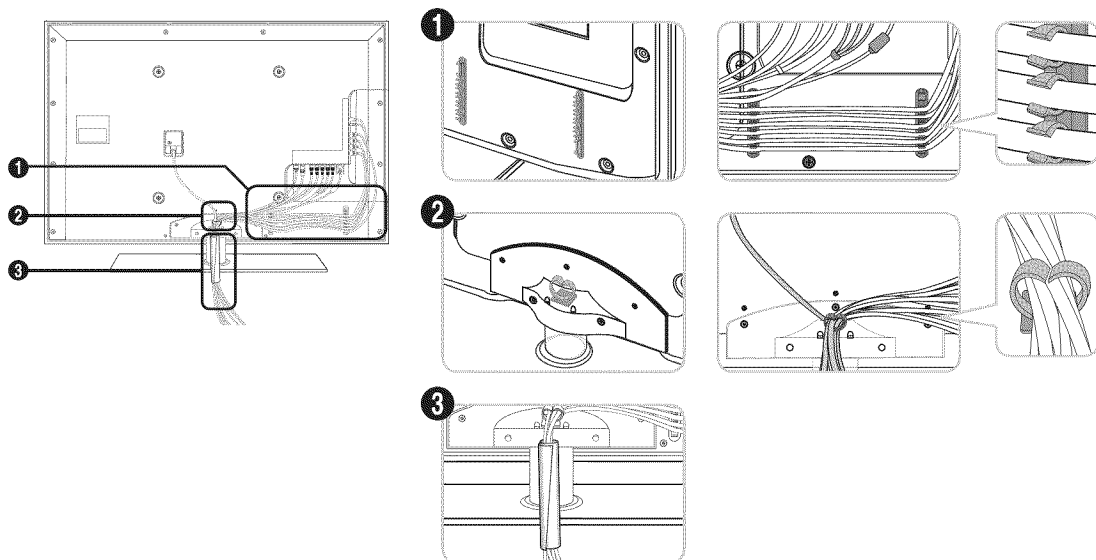

☑ Sujete los cables con el soporte de cables para que éstos no sean visibles a través del soporte transparente.

### ❑ Tipo montaje mural

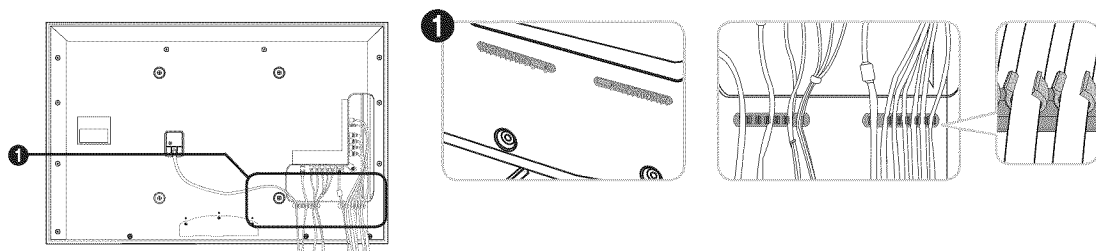

## Preparación para instalar el montaje mural

Para instalar el montaje mural de otro fabricante utilice el soporte de anilla ❶.

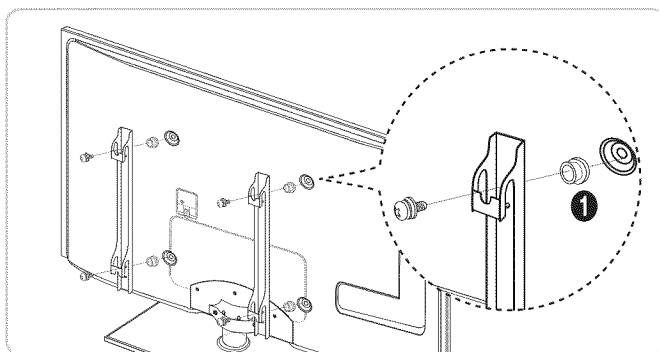

## Visualización de los menús

Antes de utilizar el televisor, siga los pasos que se explican a continuación para aprender a desplazarse por el menú a fin de seleccionar y ajustar las diferentes funciones.

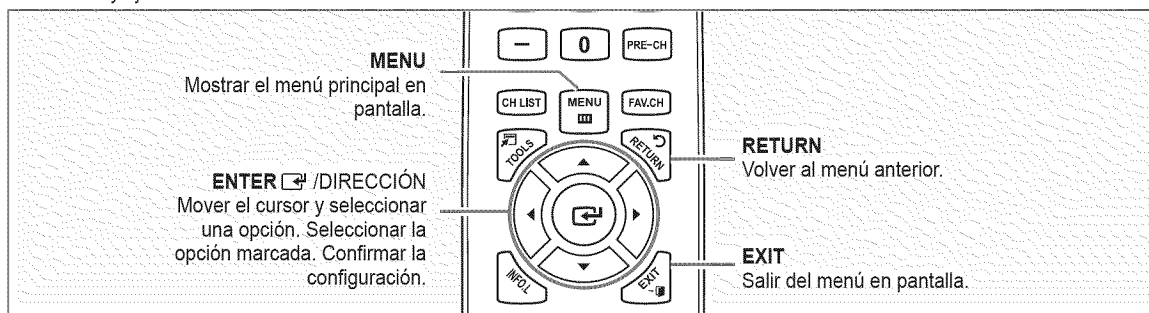

### Funcionamiento de la visualización en pantalla

El paso de acceso puede variar según el menú seleccionado.

1. Pulse el botón **MENU**.

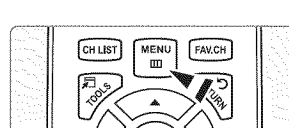

2. Se muestra el menú principal en la pantalla. En el lado izquierdo del menú hay los iconos: **Imagen**, **Sonido**, **Canal**, **Configuración**, **Entrada**, **Aplicaciones**, **Sophre técnico**.

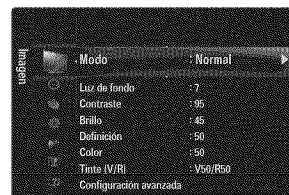

3. Pulse los botones **▲** o **▼** para seleccionar uno de los iconos.
4. Después pulse el botón **ENTER** para acceder al submenú del icono.

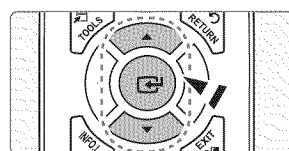

5. Pulse los botones **▲** o **▼** para seleccionar el submenú del icono.

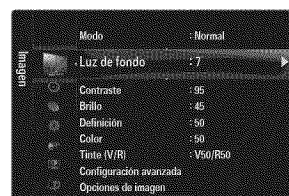

6. Pulse los botones **◀** o **▶** para aumentar o reducir el valor de una opción concreta. La visualización en pantalla del ajuste puede variar según el menú seleccionado.
7. Pulse el botón **ENTER** para completar la configuración.
8. Pulse el botón **EXIT** para salir.

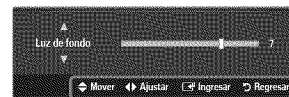

## Plug & Play

Cuando el televisor se enciende por primera vez, los valores se inician correlativamente de forma automática.

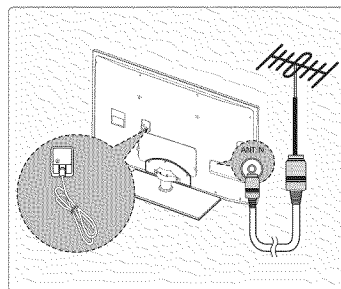

**Preparación:** Conexión del cable de alimentación y la antena.



1. Pulse el botón **POWER**  del mando a distancia.

También puede usar el botón **POWER**  del televisor.

Aparece el mensaje **Select Language of the OSD.**

2. Pulse el botón **ENTER** . Pulse el botón **▲** o **▼** para seleccionar el idioma y, a continuación, pulse el botón **ENTER** . Se muestra el mensaje **Seleccione 'Uso domiciliario' para instalar este TV en su casa.**

3. Pulse el botón **◀** o **▶** para seleccionar **Demo comercio** o **Uso domiciliario** y, a continuación, pulse el botón **ENTER** . Se muestra el mensaje **Seleccione la fuente de antena a memorizar.**

Es recomendable configurar el televisor en el modo **Uso domiciliario** para obtener la mejor imagen en un entorno doméstico.

**Demo comercio** sólo es necesario en los entornos comerciales.

Si la unidad accidentalmente se configura en el modo **Demo comercio** y se desea volver a **Uso domiciliario** (Normal): Pulse el botón del volumen del televisor. Cuando se muestra la OSD del volumen, mantenga pulsado el botón **MENU** del televisor durante 5 segundos.

4. Pulse el botón **▲** o **▼** para memorizar los canales de la conexión seleccionada. Pulse el botón **ENTER**  para seleccionar **Selección.**



**Aire:** Señal de antena aérea. / **Cable:** Señal de antena del cable. / **Auto:** Señales de antena aérea y de cable.

En el modo de cable, puede seleccionar el origen de señal correcto entre **STD**, **HRC** e **IRC** con los botones **▲**, **▼**, **◀** o **▶** y, a continuación, pulsando el botón **ENTER** . Si tiene cable digital, seleccione la fuente de la señal del sistema de cable existente en su zona.

5. Pulse el botón **ENTER**  para seleccionar **Iniciar**. El televisor empezará a memorizar todos los canales disponibles.

Para detener la búsqueda antes de que termine, pulse el botón **ENTER**  con la opción **Detener** seleccionada.

Una vez guardados todos los canales disponibles, se inicia la eliminación de los canales codificados. Vuelve a mostrarse el menú de programación automática. Pulse el botón **ENTER**  cuando se complete la memorización de canales. Aparece automáticamente el mensaje **Configure el modo de Reloj.**

6. Pulse el botón **ENTER** . Pulse el botón **▲** o **▼** para seleccionar **Auto** y, a continuación, pulse el botón **ENTER** . Se muestra el mensaje **Configurar la hora de verano.** Si Selección **Manual**, **Configurar fecha y hora actuales.**

7. Pulse el botón **▲** o **▼** para seleccionar **Apagado**, **Encendido** o **Auto** y, a continuación, pulse el botón **ENTER** .

8. Pulse el botón **▲** o **▼** para resaltar la zona horaria de su región. Pulse el botón **ENTER** . Si ha recibido una señal digital, se ajustará la hora automáticamente. Si no es así, consulte las instrucciones de 'Configuración de la hora' para configurar el reloj.

9. Se muestra la descripción del método de conexión para conseguir la mejor calidad de la pantalla HD. Compruebe la descripción y pulse el botón **ENTER** .

10. Aparece el mensaje **Disfrute de su TV**. Cuando haya terminado, pulse el botón **ENTER** .

**Si desea reiniciar esta función...**

1. Pulse el botón **MENU** para ver el menú en pantalla. Pulse el botón **▲** o **▼** para Selección **Configuración** y, a continuación, pulse el botón **ENTER** .

2. Pulse de nuevo el botón **ENTER**  para seleccionar **Plug & Play**.

La función **Plug & Play** está disponible sólo en el modo TV.

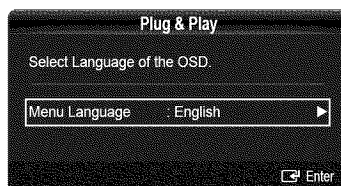
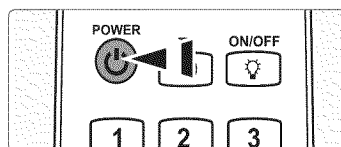

## Instalación del dispositivo de memoria USB para ver el manual electrónico

### Visualización de los menús

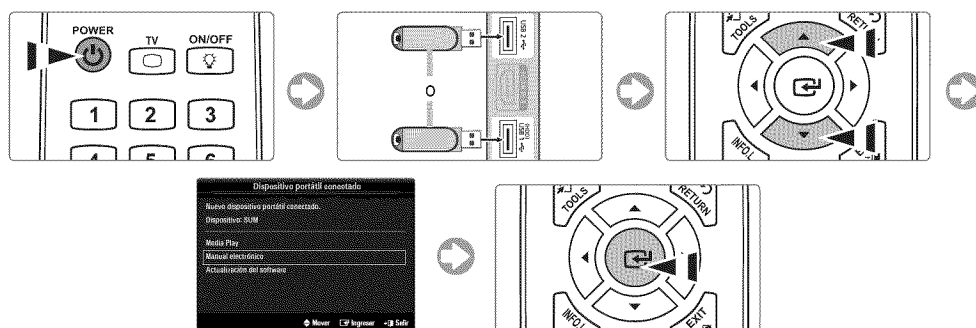

### Pantalla de visualización



- 1 Actualizar la ventana del capítulo.
- 2 Ir al menú seleccionado

- 3 Ir al menú OSD del televisor
- 4 Utilizar el menú de índice
- 5 Ejecutar varias funciones del menú del manual electrónico.



#### Precaución: Uso del USB (manual electrónico)

Utilizar sólo con el manual electrónico.  
El uso con otros propósitos puede originar un mal funcionamiento.  
Se recomienda rescribirlo menos de 5 veces.

## Solución de problemas

Problema	Solución
Cuando el manual electrónico no funciona inmediatamente	Compruebe el estado de la conexión USB del televisor.
Si no encuentra el USB	Póngase en contacto con su distribuidor local
Si se ha borrado el manual del USB	Vaya a <a href="http://www.samsung.com">www.samsung.com</a>
No hay imagen ni sonido	Compruebe que el cable de alimentación esté conectado a la red eléctrica. Compruebe que haya pulsado el botón del aparato. Compruebe los ajustes de contraste y brillo de la imagen. Compruebe el volumen.
Hay imagen pero no sonido	Compruebe el volumen. Compruebe si se ha pulsado el botón <b>MUTE</b> del mando a distancia. Compruebe la configuración de la selección del altavoz.

# Conexión de un dispositivo AV

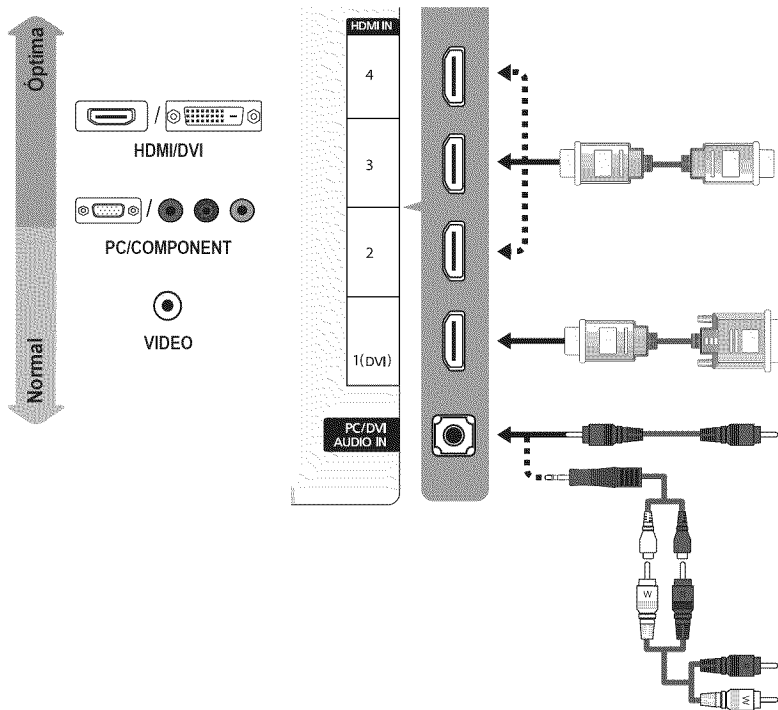

## ★ Conexión HD

### Mediante un cable HDMI

Reproductor DVD/Blu-ray o receptor por cable HD/satélite HD (decodificador)



## ★ Conexión HD

### Mediante un cable DVI

Reproductor DVD/Blu-ray o receptor por cable/satélite (decodificador)

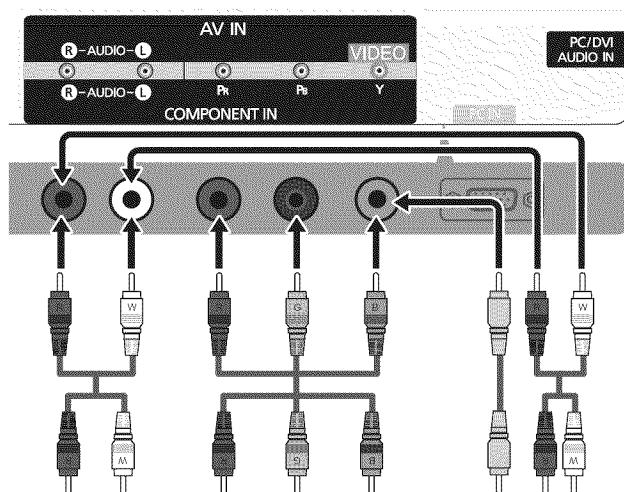
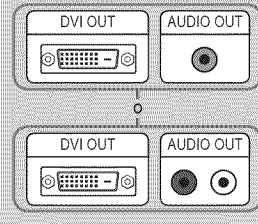

## Conexión de componentes

### Mediante un cable de componentes

Reproductor DVD/Blu-ray o receptor por cable/satélite

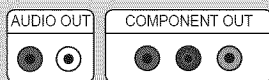

## Conexión de audio/vídeo

### Mediante un cable de audio/vídeo

Aparato de vídeo

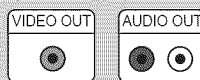

## Conexión de un dispositivo de audio

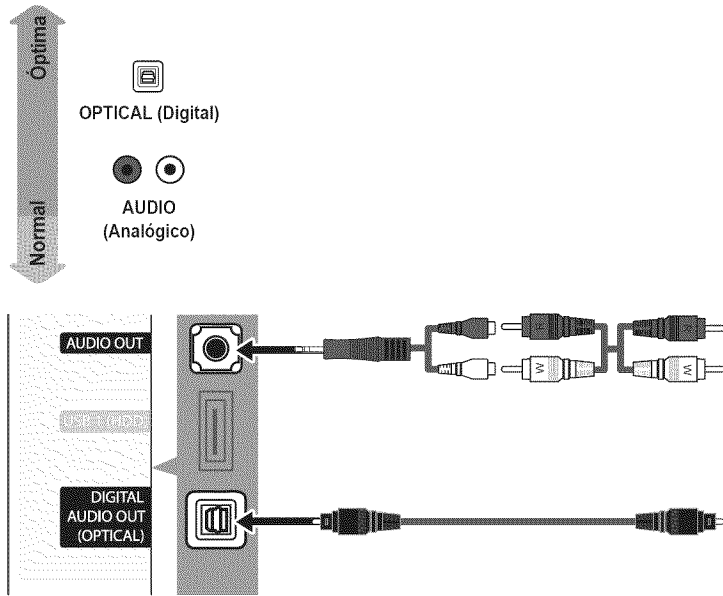

### Conexión de audio analógico

#### Mediante un cable de audio

Amplificador/  
DVD para Home Cinema

AUDIO IN

### ★ Conexión de audio digital

#### Mediante un cable óptico

Sistema de audio digital

OPTICAL

## Conexión de un PC

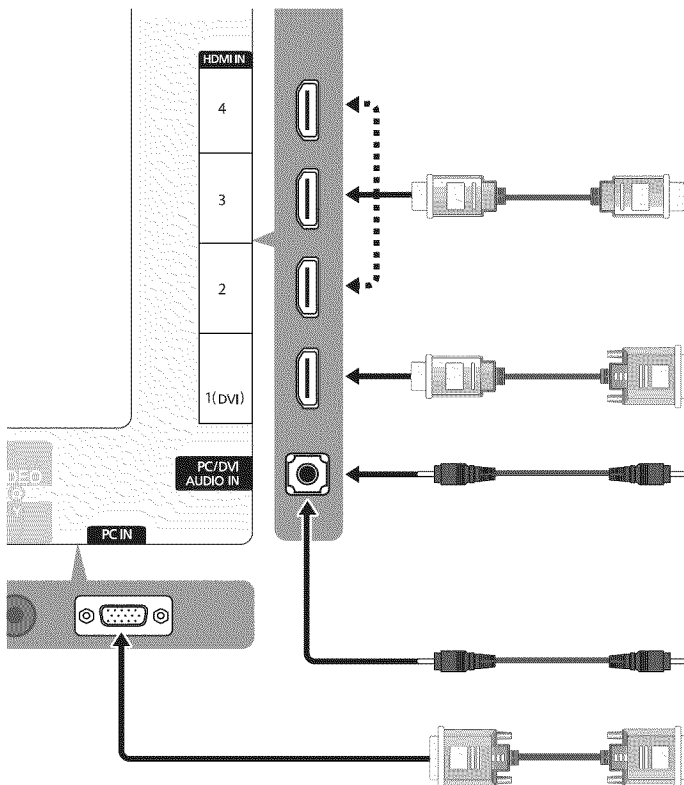

### ★ Conexión HD

#### Mediante un cable HDMI

HDMI OUT

### ★ Conexión HD

#### Mediante un cable HDMI/DVI

AUDIO OUT

DVI OUT

#### Mediante un cable D-Sub

AUDIO OUT

PC OUT

## Accessorios incluidos



Télécommande  
et piles (AAA x 2)



Carte de garantie /  
Guide de sécurité

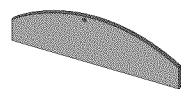

Couvre base



USB (guide électronique)



Chiffon de nettoyage



Vis de support (M4xL10)  
UN40B6000, UN46B6000



Anneau de support (4ea)



Câble porte-fil  
(Selon le modèle)



Dispositif de retenue du téléviseur et vis  
(M8xL19)  
(Según el modelo)



Porte-fil (3ea)



Support porte-fil

## Insertion des piles dans la télécommande

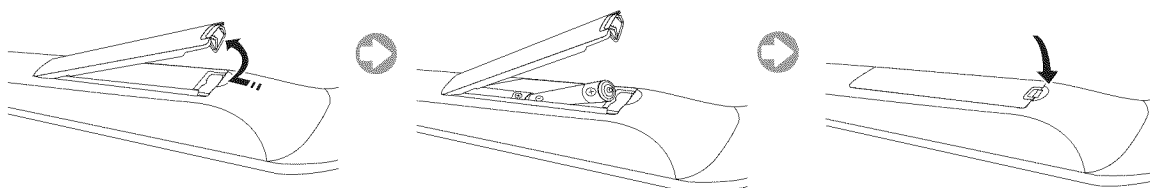



## Disposition des câbles

### ❑ Installation sur support

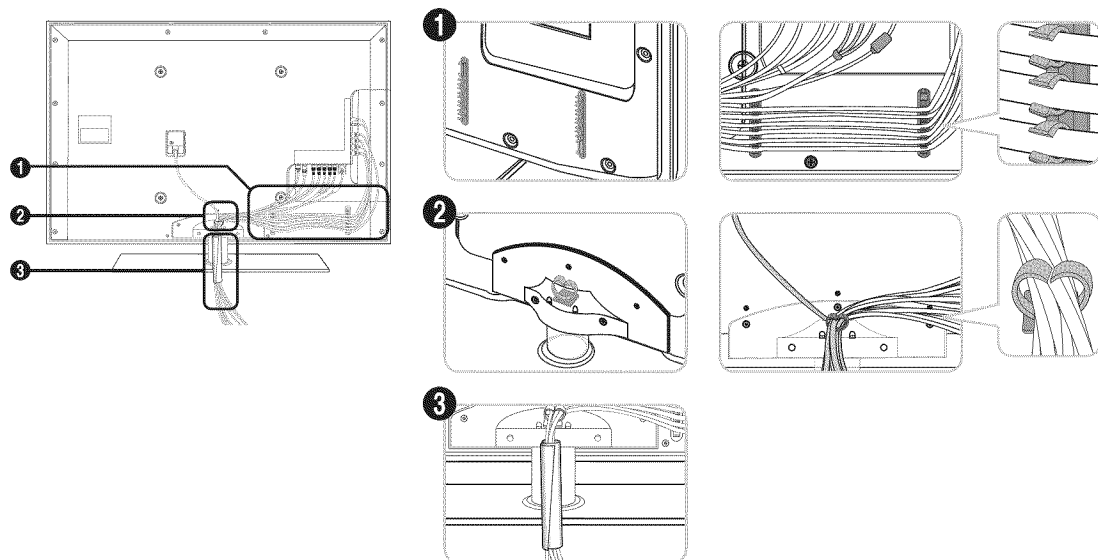

☑ Faites passer les fils dans le porte-fil afin de pas les voir à travers le support transparent.

### ❑ Fixation murale

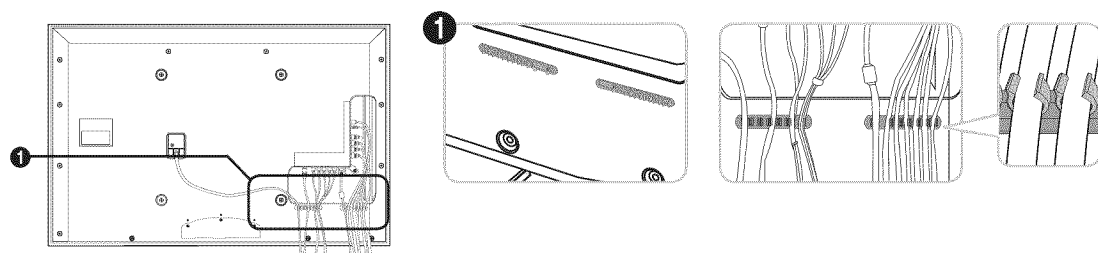

## Préparation avant l'installation de l'ensemble de fixation murale

Utilisez l'anneau de support ❶ pour installer un support mural provenant d'un autre fabricant.

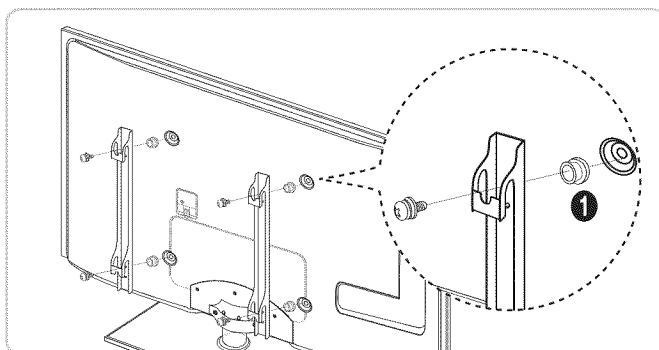

## Affichage des menus

Avant d'utiliser le téléviseur, suivez les étapes ci-dessous pour apprendre comment naviguer dans les menus, puis sélectionner et régler différentes fonctions.

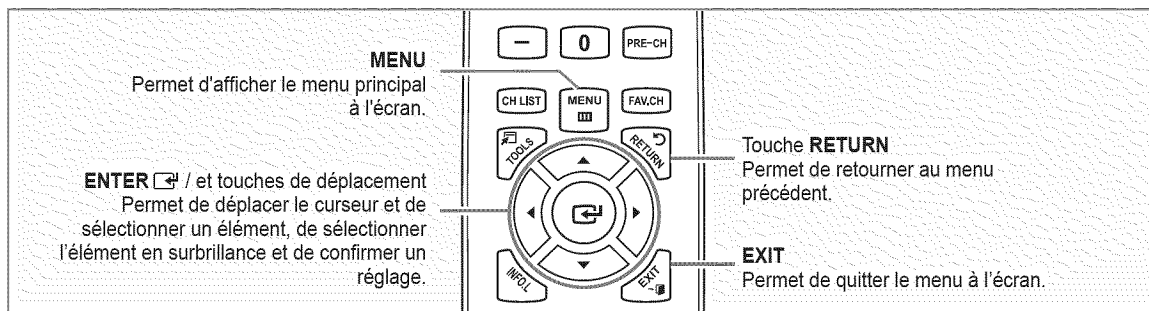

### □ Fonctionnement de l'affichage à l'écran

La méthode d'accès peut différer selon le menu sélectionné.

1. Appuyez sur la touche **MENU**.

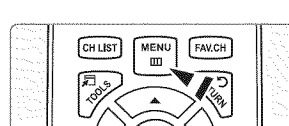

2. Le menu principal apparaît à l'écran. La partie gauche du menu comprend des icônes : **Picture, Sound, Channel, Setup, Input, Application, Support**.

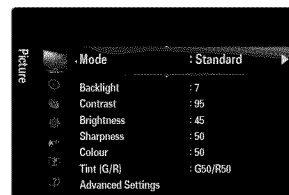

3. Appuyez sur la touche **▲** ou **▼** pour sélectionner une icône.
4. Ensuite, appuyez sur **ENTER** pour accéder au sous-menu de l'icône.

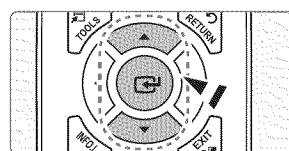

5. Appuyez sur la touche **▲** ou **▼** pour sélectionner une icône.

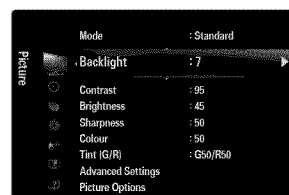

6. Appuyez sur la touche **◀** ou **▶** pour augmenter ou réduire la valeur d'un élément particulier. Le réglage des options affichées peut différer selon le menu sélectionné.
7. Appuyez sur **ENTER** pour terminer la configuration.
8. Appuyez sur la touche **EXIT** pour quitter.



↳ Icône Aide



## Plug & Play

Au moment de la mise sous tension initiale du téléviseur, les paramètres de base sont automatiquement réglés. D'autres sont réglés en cours d'utilisation.

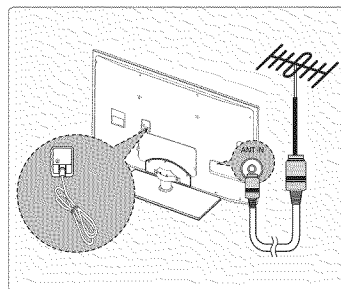

 **Préréglage** : Branchement de l'alimentation et de l'antenne.



1. Appuyez sur la touche **POWER**  de la télécommande.

 Vous pouvez également appuyer sur la touche **POWER**  du téléviseur.

 Le message **Select Language of the OSD**. s'affiche.

2. Appuyez sur **ENTER** . Appuyez sur la touche **▲** ou **▼** pour sélectionner la langue, suivie de la touche **ENTER** . Le message **Choisir « Util. à domicile » pour un téléviseur à la maison.** s'affiche.

3. Utilisez la touche **◀** ou **▶** pour choisir **Démo magasin** ou **Util. à domicile**. Appuyez ensuite sur **ENTER** . Le message **Mémoriser une source d'antenne.** s'affiche.



 Nous vous recommandons de régler le téléviseur au mode **Util. à domicile** afin d'obtenir la meilleure image possible à votre domicile.

 **Démo magasin** ne doit être utilisé qu'en magasin.



 Si l'appareil est réglé par inadvertance au mode **Démo magasin** et que vous voulez revenir au mode **Util. à domicile** (Standard) : appuyez sur la touche de volume du téléviseur. Lorsque le réglage du volume est affiché à l'écran, appuyez sur la touche **MENU** du téléviseur pendant cinq secondes.



4. Utilisez la touche **▲** ou **▼** pour mémoriser les canaux de la connexion sélectionnée. Appuyez sur **ENTER**  pour sélectionner **Démarrer**.



 **Air** : signal d'antenne de type air. / **Câble** : signal d'antenne de type câble. / **Auto** : signaux d'antenne de type « air » et « câble ».

 En mode **Câble**, vous pouvez sélectionner la source de signal appropriée parmi **STD**, **HRC** et **IRC** en appuyant sur la touche **▲**, **▼**, **◀** ou **▶**, puis sur la touche **ENTER** . Dans le cas d'un signal de câble numérique, sélectionnez la source de signal pour une diffusion analogique et numérique. Communiquez avec votre câblodistributeur local pour déterminer le type de système de câble de votre région.

5. Appuyez sur **ENTER**  pour sélectionner l'option **Démarrer**. La mémorisation des canaux disponibles commence.

 Pour arrêter la recherche avant la fin, Appuyez sur **ENTER**  lorsque l'option **Arrêt** est sélectionnée.

 Une fois tous les canaux mémorisés, le téléviseur commence à éliminer les canaux brouillés. Puis le menu **Auto program** s'affiche de nouveau. Appuyez sur **ENTER**  lorsque la mémorisation des canaux est terminée. Le message **Régler le mode horloge.** s'affiche.

6. Appuyez sur **ENTER** . Appuyez sur la touche **▲** ou **▼** pour sélectionner **Auto**, puis sur la touche **ENTER** . Le message **Régler à l'heure avancée.** s'affiche. Si vous choisissez **Manuel**, le message **Régler la date et l'heure du jour** s'affiche.

7. Appuyez sur la touche **▲** ou **▼** pour sélectionner **Off**, **On** ou **Auto**, puis sur la touche **ENTER** .

8. Appuyez sur la touche **▲** ou **▼** pour mettre en surbrillance votre fuseau horaire. Appuyez sur **ENTER** .

Si vous recevez un signal numérique, l'horloge se règle automatiquement. Dans le cas contraire, reportez-vous à la rubrique « Réglage de l'horloge » pour savoir comment régler l'horloge.

9. La description de la méthode de branchement assurant que la meilleure qualité HD s'affiche. Vérifiez la description et appuyez sur la touche **ENTER** .

10. Le message **En mode diffusion.** s'affiche. Appuyez sur la touche **ENTER**  lorsque terminé.

**Si vous souhaitez réinitialiser ce paramètre...**

1. Appuyez sur la touche **MENU** pour afficher le menu. Appuyez sur la touche **▲** ou **▼** pour sélectionner **Configuration**, puis sur **ENTER** .

2. Appuyez sur **ENTER**  de nouveau pour choisir **Prêt à l'emploi**.

 La fonction **Prêt à l'emploi** n'est accessible qu'en mode TV.

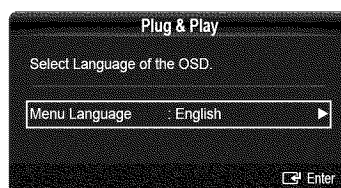
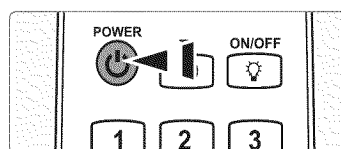

## Installation de la clé USB pour visualiser le guide électronique

### □ Affichage des menus

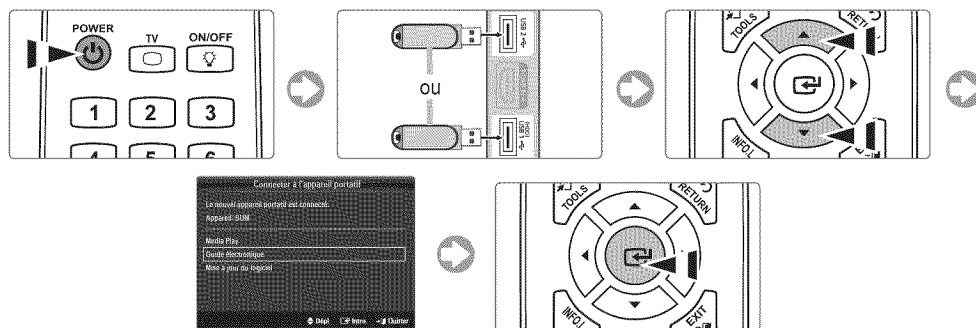

### □ Affichage à l'écran



❶ Permet de rafraîchir la fenêtre de chapitre

❷ Permet de passer au menu sélectionné

❸ Permet de passer au menu affiché à l'écran

❹ Permet d'utiliser le menu indexation

❺ Permet d'exécuter les fonctions du guide électronique



### Attention : utilisation de la clé USB (guide électronique)

N'utilisez la clé USB que pour consulter le guide électronique.

Toute autre utilisation risque de causer une défectuosité.

Il est recommandé de limiter la réécriture à cinq reprises.

## Dépannage

Problème	Solution
Si le guide électronique ne s'affiche pas immédiatement	Vérifiez l'état de la connexion USB du téléviseur.
Si vous avez perdu la clé USB	Communiquez avec votre détaillant.
Si le guide est supprimé sur la clé USB	Allez à l'adresse <a href="http://www.samsung.com">www.samsung.com</a>
Aucun son ou aucune image	Vérifiez si le cordon d'alimentation est branché à une prise murale. Vérifiez si vous avez appuyé sur la touche de mise sous tension de votre téléviseur. Vérifiez les réglages de contraste et de luminosité de l'image. Vérifiez le volume.
Image normale, mais aucun son	Vérifiez le volume. Vérifiez si vous avez appuyé sur la touche <b>MUTE</b> de la télécommande. Vérifiez les réglages de sélection des haut-parleurs.

# Connexion d'un appareil audio-vidéo

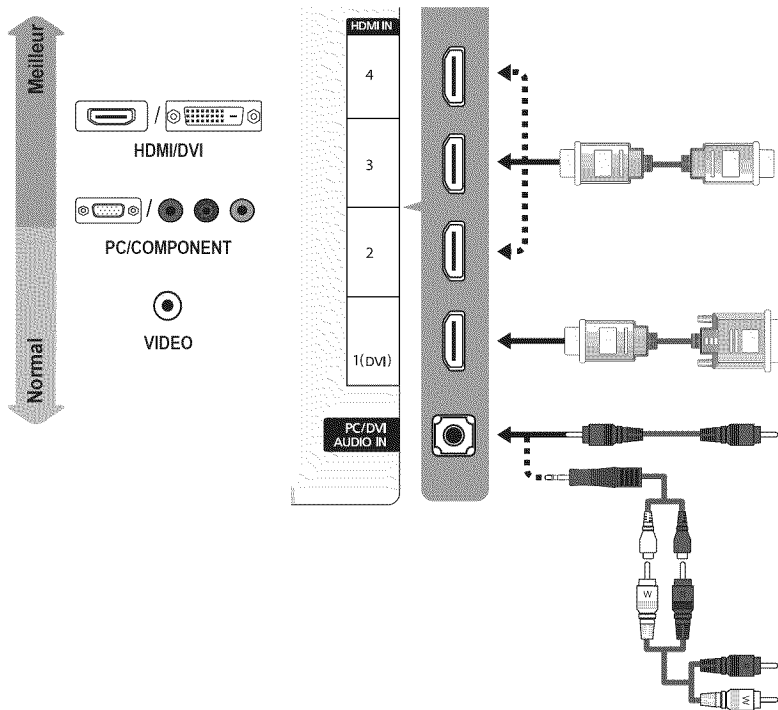

## ★ Branchement HD

### Utilisation d'un câble HDMI

DVD / Lecteur Blu-Ray / décodeur câble HD / récepteur satellite HD (boîtier externe)

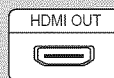

## ★ HD

### Utilisation d'un câble DVI

DVD / Lecteur Blu-Ray / décodeur câble / récepteur satellite (boîtier externe)

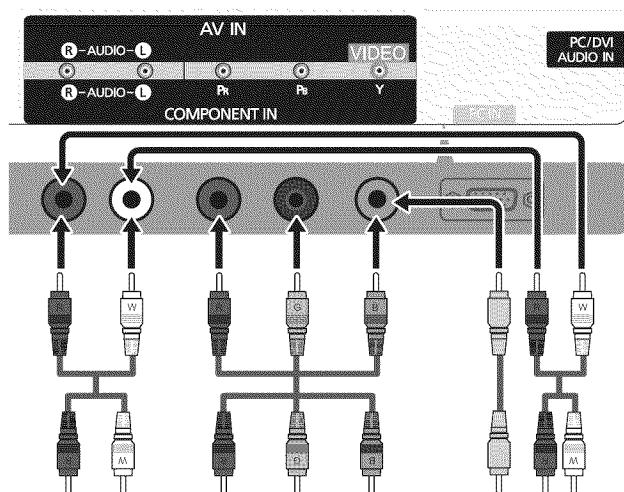
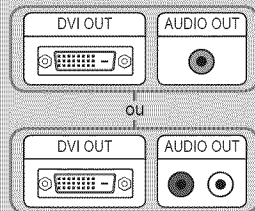

## Branchement des composantes

### Utilisation d'un câble composante

DVD / Lecteur Blu-Ray / décodeur câble / récepteur satellite

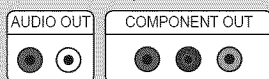

## Branchement audio-vidéo

### Utilisation d'un câble audio-vidéo

Magnétoscope

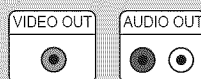

## Branchement d'un appareil audio

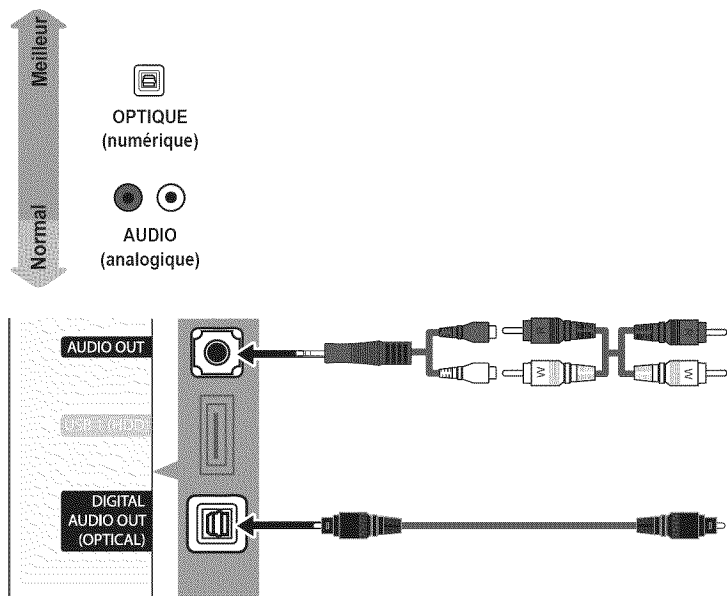

### Branchement audio analogique

#### Utilisation d'un câble audio

Amplificateur /  
home cinéma avec DVD



### ★ Branchement audio numérique

#### Utilisation d'un câble optique

Système audio numérique



## Branchement d'un PC

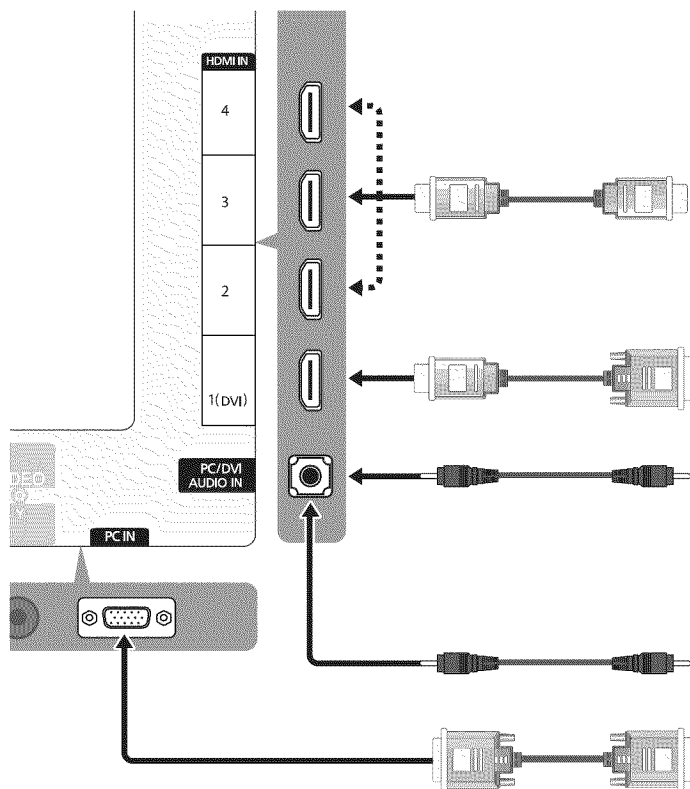

### ★ Branchement HD

#### Utilisation d'un câble HDMI



### ★ Branchement HD

#### Utilisation d'un câble HDMI/DVI

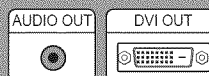

#### Utilisation d'un câble D-Sub

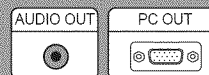

*This page is intentionally left blank*

## Contact SAMSUNG WORLDWIDE

If you have any questions or comments relating to Samsung products, please contact the SAMSUNG customer care centre.

Country	Customer Care Center ☎	Web Site	Address
CANADA	1-800-SAMSUNG(726-7864)	www.samsung.com/ca	Samsung Electronics Canada Inc., Customer Service 55 Standish Court Mississauga, Ontario L5R 4B2 Canada
			Samsung Electronique Canada Inc., Service à la Clientèle 55 Standish Court Mississauga, Ontario L5R 4B2 Canada
U.S.A	1-800-SAMSUNG(726-7864)	www.samsung.com/us	Samsung Electronics America, Inc. 105 Challenger Road Ridgefield Park, NJ 07660-0511

