



HOW TO MAKE A HOME RUN.™

Use And Care

G U I D E



A Note to You	2
Dishwasher Safety	3
Parts and Features	4
Starting Your Dishwasher	5
Loading Your Dishwasher	6
Using the Dispensers	10
Setting the Controls	12
Selecting a wash cycle	12
Using CANCEL/DRAIN	13
Selecting cycle options	13
Changing a cycle or option setting	14
Adding a dish during a cycle	14
Understanding the status indicators	15
Washing Special Items	16
Connecting a Portable Dishwasher	17
Caring for Your Dishwasher	19
Saving Energy	21
Solving Common Dishwashing Problems	22
Troubleshooting	25
Requesting Assistance or Service	26
Index	30
Warranty	32

DISHWASHER MODEL SERIES 920

PART NO. 3373752 Rev. A

1-800-253-1301

Call our Consumer Assistance Center with questions or comments.

5195

A Note to You

Thank you for buying a Whirlpool® appliance.

Because your life is getting busier and more complicated, Whirlpool dishwashers are easy to use, save time, and help you manage your home better. To ensure you enjoy years of trouble-free operation, we developed this Use and Care Guide. It contains valuable information about how to operate and maintain your appliance properly and safely. Please read it carefully.

Also, please complete and mail the Ownership Registration Card provided with your appliance. This card helps us notify you about any new information on your appliance.

Please record your model's information.

Whenever you call to request service for your appliance, you need to know your complete model number and serial number. You can find this information on the model and serial number label (see diagram on page 4 for location of label).

Please also record the purchase date of your appliance and your dealer's name, address, and telephone number.

Model Number _____

Serial Number _____

Purchase Date _____

Dealer Name _____

Dealer Address _____

Dealer Phone _____

Keep this book and the sales slip together in a safe place for future reference.

**Our Consumer Assistance Center
number is toll-free 24 hours a day.**

1-800-253-1301

Help us help you

Please:

- Have your dishwasher installed by a qualified installer.
- Install where dishwasher is protected from the elements.
- Install and level dishwasher on a floor that will hold the weight, and in an area suitable for its size and use.
- Properly connect dishwasher to electricity, water, and drain.*
- Remove all shipping plugs from hoses and connectors (such as the cap on the drain outlet) before installing.*
- Remove all hang tags and temporary labels.
- Make sure dishwasher is not used by anyone unable to operate it properly.
- Properly maintain dishwasher. See pages 19-20.

* See Installation Instructions for complete information.

Dishwasher Safety

Your safety is important to us.

This guide contains safety statements under warning symbols. Please pay special attention to these symbols and follow any instructions given. Here is a brief explanation of the use of the warning symbol.

⚠ WARNING

This symbol alerts you to such dangers as fire, electrical shock, burns, and personal injury.

IMPORTANT SAFETY INSTRUCTIONS

⚠ WARNING

To reduce the risk of fire, electrical shock, or injury when using your dishwasher, follow basic precautions including the following:

- Read all instructions before using the dishwasher.
- Use your dishwasher only for the uses described in this manual.
- **DISHWASHER MUST BE ELECTRICALLY GROUNDED.** Read the Installation Instructions for details.
- When discarding an old dishwasher, always remove the door to prevent accidental entrapment or suffocation.
- Use **ONLY** detergents and rinse agents recommended for use in a dishwasher.
- Store dishwasher detergent in a cool, dry place **WHERE CHILDREN CAN'T REACH IT.**
- When loading items to be washed:
 - Load sharp items and knives with the handles up to reduce risk of cut-type injuries.
 - Locate sharp items and knives so that they are not likely to damage the door or tub.
- **DO NOT** let children play in or on the dishwasher.
- **DO NOT** reach into the area below the bottom rack until the heating element has cooled for at least 20 minutes.
- **DO NOT** wash plastic items unless marked "Dishwasher Safe" or the equivalent. If not marked, check manufacturer's recommendations.
- **DO NOT** use your dishwasher unless all enclosure panels are properly in place.
- **DO NOT** sit on, stand on, or abuse the dishwasher door or dishracks.
- **DO NOT** tamper with controls.
- If hot water has not been used recently (usually two weeks or longer), hydrogen gases may build up in the water heater and the hot water pipes. **HYDROGEN GAS IS EXPLOSIVE.** To prevent injury or damage, before using your dishwasher, turn on all hot water faucets and allow water to run for several minutes. This will allow gases to escape. Do not smoke or use any open flame near the faucet while it is open.
- **DO NOT** store or use gasoline or other flammable vapors and liquids in the vicinity of this or any other appliance. The fumes can create a fire hazard or explosion.
- Disconnect electrical power to the dishwasher before attempting to service.

– SAVE THESE INSTRUCTIONS –

Parts and Features

Your dishwasher is illustrated below with the parts and features called out. To help you find information on specific parts or features quickly, page references are included.

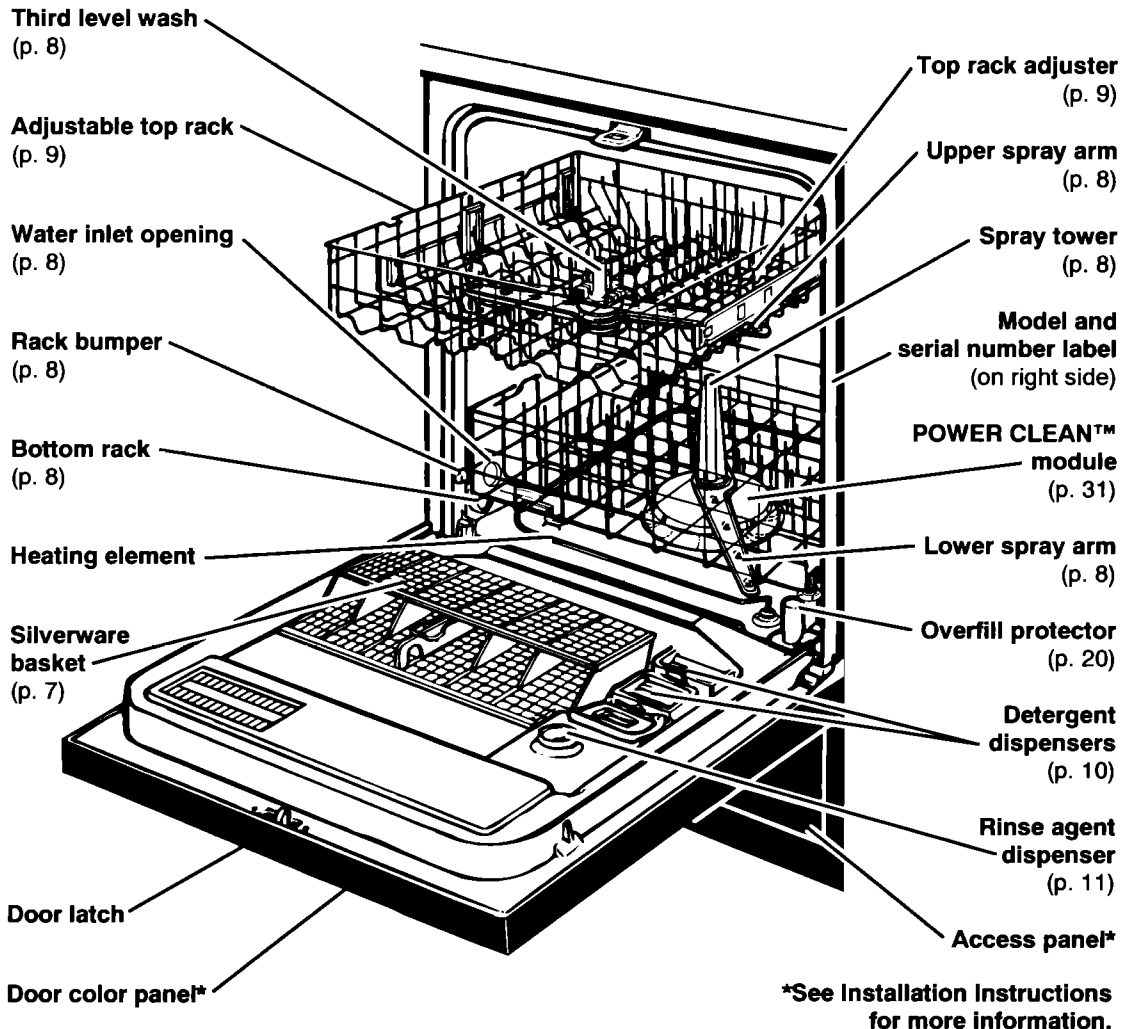

Control panel

Your dishwasher has a row of push pads to select cycles and options. You **must** select a cycle to start your dishwasher. You **may** select one or more options.

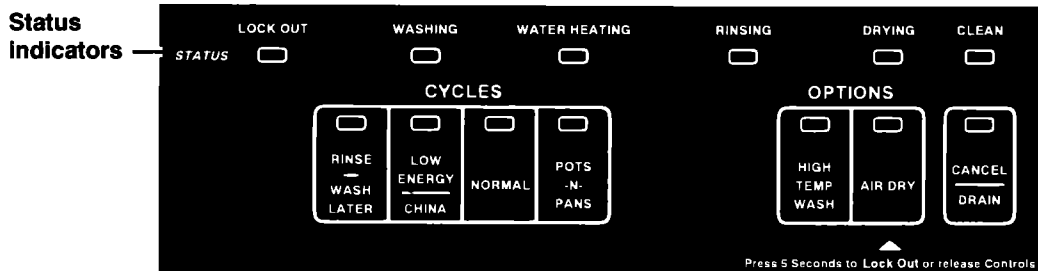

Starting Your Dishwasher

This section tells you how to start or stop your dishwasher. Refer to it for quick reference.

Starting a wash cycle

1. Load the dishwasher. See pages 6-9.



2. Spin the spray arms. They should turn freely.



3. Add detergent. See page 10.



4. Add rinse agent, if needed. See page 11.



5. Close door firmly until it latches.

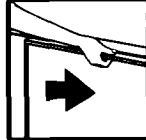

6. Run hot water at the sink nearest the dishwasher until water is hot. Turn water off. (See page 21.)

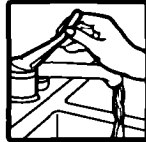

7. Press a Cycle pad. If desired, press one or more Option pads. (See pages 12-13.) The dishwasher starts filling once you press a cycle pad unless you select the delay wash cycle. You may press Option pads as the machine is filling.



The pad indicator glows red when a cycle or an option is selected.



Stopping the dishwasher

You can stop your dishwasher anytime during a cycle. All you have to do is:

- Open the door slightly. Wait for any filling or spraying action to stop before opening the door all the way. Close door to continue cycle.

OR

- Press CANCEL/DRAIN. Once pressed, a 2-minute drain starts. (See page 13.)

Loading Your Dishwasher

This section tells how to properly load your dishwasher for best washing and rinsing results.

Preparing to load the dishwasher

- To save water and energy, do not rinse dishes before putting them into the dishwasher.
- Remove large pieces of food, bones, and other hard items. The POWER CLEAN™ module removes food particles from the water. The module contains a chopping device which reduces the size of food items.
NOTE: If hard items such as fruit seeds, nuts, and egg shells enter the POWER CLEAN module, you might hear chopping, grinding, crunching, or buzzing sounds. Those sounds are normal when hard items enter the module. **Do not** let metallic items (such as pot handle screws) get into the POWER CLEAN module. Damage can occur.
- Foods like eggs, rice, pasta, and cooked cereals may be hard to remove if left to dry over a period of time. Run a RINSE/WASH LATER cycle to keep dishes moist if you do not plan to wash them soon.
- Load dishes so soiled surfaces face the rotating spray arm.
- Load dishes so they are not stacked or overlapping. It is important for the water spray to reach all soiled surfaces for best washing. For best drying, water must be able to drain from all surfaces.

Loading for quiet operation

- Secure lightweight load items in the racks.
- Pot lids and handles, pizza pans, cookie sheets, etc., should not touch interior walls, interfere with the spray arm's rotation, or cover the spray tower.
- Load dishes so they do not touch one another.

NOTE: Keep sink drain plugs inserted during dishwasher operation to prevent noise transfer through drains.

Loading the silverware basket

⚠ WARNING

Personal Injury Hazard

Load sharp items (knives, forks, skewers, etc.) with the point down.

Failure to do so could cause personal injury.

- Load the silverware basket while it is in the door or take the basket out for loading on a counter or table.
- Mix items in each section of the basket with some pointing up and some down to avoid nesting. Spray cannot reach nested items. However, always load sharp items (knives, skewers, forks, etc.) pointing down.
- Put small items (baby bottle caps, jar lids, etc.) in any section.
- You can also remove the basket for easy unloading. Always unload or remove the basket before unloading the racks to avoid spilling water on the silverware.

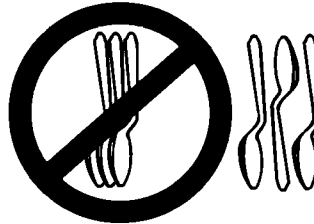
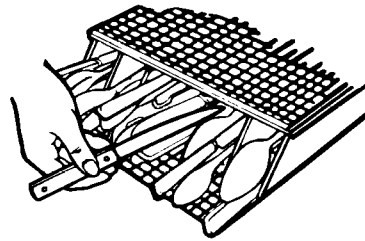

To remove the basket:

1. Grab the basket by the handle and slide it toward the top of the door.
2. Lift the basket off the holding buttons.

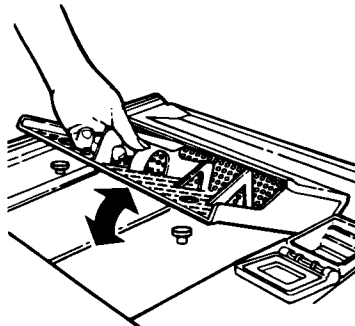

To replace the basket:

1. Set the basket on the holding buttons.
2. Slide the basket towards the bottom of the door until it locks in place.

To open the basket:

- Unhook the latch as shown.

NOTE: Be sure the cover is completely latched before pulling out the bottom rack and before closing the dishwasher door.

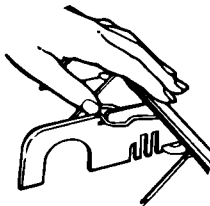

LOADING YOUR DISHWASHER

Loading the bottom rack

Load items with cooked-on or dried-on food in the bottom rack, with soiled surfaces facing inward to the spray.

Mixed load

- Load plates, soup bowls, etc., between prongs and facing inward to the spray.
- Make sure pot handles and other items do not stop rotation of the spray arms. Spray arms must move freely.
- Load items so they do not block or cover the spray tower.
- Load heavily-soiled cookware face down in the rack.
- Do not stack or overlap dishes. Water spray must reach all soiled surfaces for best results.

Utensil load

- Load cookie sheets, cake pans, and other large items at sides and back. Loading such items in front may keep water spray from reaching detergent dispenser and silverware basket.

NOTE:

- Do not load glasses, cups, or plastic items in the bottom rack.
- Do not load items between the bottom rack and the side of the dishwasher tub. This can block the water inlet opening.
- If you have removed the bottom rack for unloading or cleaning, replace it with bumpers in front.

Mixed load

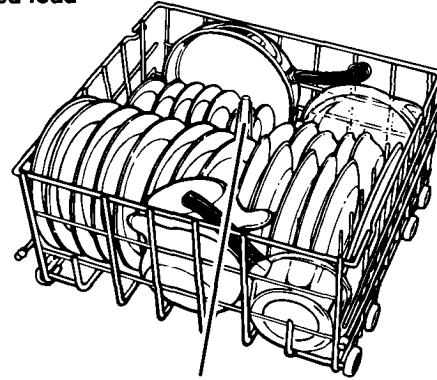

Do not cover spray tower

Utensil load



Bumpers must face dishwasher door

Loading the top rack

Load the top rack with cups, glasses, and smaller items. Do not cover the third level wash when loading the top rack.

Cup and glass load

- Load so open ends face down for cleaning and draining.
- Load glasses in top rack only – bottom rack is not designed for glasses. Damage can occur.

Cup and glass load

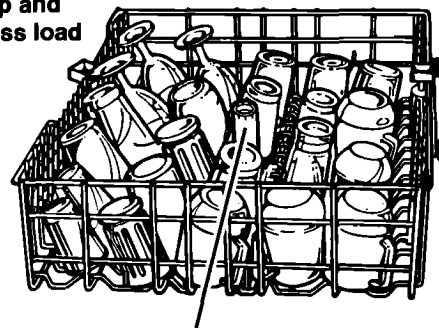

Do not cover third level wash

LOADING YOUR DISHWASHER

- Place items in the rows **between** prongs. Placing them over the prongs may lead to breakage.
- Secure lightweight items.
- China, crystal, and other delicate items must not touch each other during dishwasher operation. Damage may occur.

Mixed load

- Small bowls, pans, and other utensils can be placed in the top rack.
- Load plastic items in the top rack only. Plastic items may melt in the bottom rack.
- Wash only plastic items marked "dishwasher safe".
- Load plastic items so the force of the spray does not move them during the cycle.

Mixed load

Do not cover third level wash

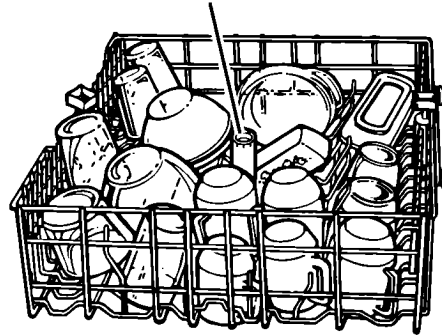

Infinite adjustable top rack (on some models)

Raise or lower the rack to fit tall items in either the top or bottom rack. The top rack does not have to be level.

- Turn the knob clockwise to raise a side of the rack.
- Turn the knob counterclockwise to lower a side of the rack.

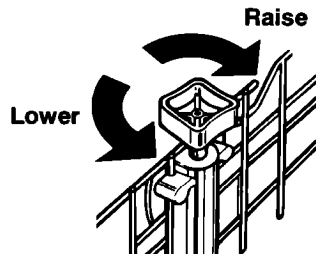

Adjustable 3-position top rack (on some models)

You can raise or lower the rack to fit tall items in either the top or bottom rack. The high and low positions are marked on the adjuster on the side facing the center of the dishwasher.

1. Hold top rack with one hand near adjuster.
2. Pull top of adjuster lever out with other hand.
3. Lift or lower rack to one of the preset positions.
4. Release adjuster lever.
5. Repeat Steps 1-4 for the three remaining adjusters as needed. The four adjusters can be raised or lowered separately or together, as desired. The top rack does not have to be level.

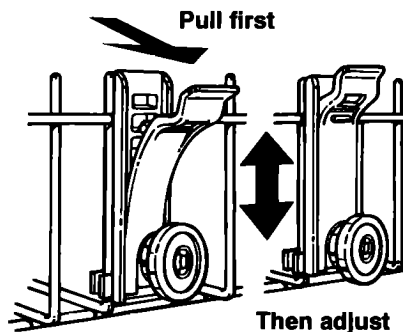

Using the Dispensers

For best washing results, review the information below. It is important to use detergents and rinse agents properly.

Using the detergent dispenser

- Use automatic dishwashing detergent **only**. Other detergents are too mild and much too sudsy.
- Add detergent just before starting cycle.
- Store tightly-closed detergent in a cool, dry place. **Fresh automatic dishwasher detergent results in better cleaning.**

Filling the detergent dispenser

The detergent dispenser has one section with a cover and one without. Push cover down firmly until it latches. Detergent in the open section falls into the dishwasher when closing the door. The covered section opens automatically for the main wash.

NOTE: It is normal for the cover to open partially when dispensing detergent.

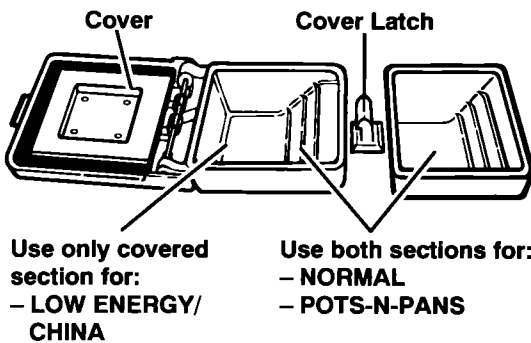

How much detergent to use

- The amount of detergent to use depends on the hardness of your water and the type of detergent. If you use too little, dishes won't be clean. If you use too much in soft water, glassware will etch.
- Different brands of dishwasher detergent have different amounts of phosphorus for softening water. If you have hard water and use low phosphorus content detergent (6.0% or less), you may need to use more detergent or use a detergent with a higher phosphorus content (8.7%).
- Find out your water's hardness by asking your local water department, water softener company, or county extension agent.

WATER TYPE	WHERE TO FILL	
Hard 8+ grains per gallon 136+ parts per million	Top of 3rd step (3 tbs)	
Medium 5-7 grains per gallon 85-119 parts per million	Top of 2nd step (2 tbs)	
Soft 0-4 grains per gallon 0-68 parts per million	Top of 1st step (1 tbs)	

Fill amounts shown are for standard powdered detergent. Amounts may vary if you use liquid or concentrated powdered detergent. Follow manufacturer's directions when using liquid dishwasher detergent or concentrated powdered detergent.

Using the rinse agent dispenser

Keep the rinse agent dispenser filled with a liquid rinse agent. **A rinse agent greatly improves dish drying by helping water flow off them during the last rinse.** A rinse agent also keeps water from forming droplets and drying as spots or streaks.

A small amount of rinse agent automatically releases into the rinse water during the final rinse of each cycle. **For best drying results, check dispenser periodically to see if it needs filling.**

To check dispenser:

- Check center of Fill Indicator Cap. Clear means it needs filling.
- OR
- Remove Fill Indicator Cap. An "E" is visible when dispenser is empty.

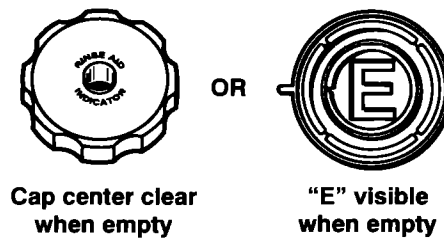

To fill dispenser:

The rinse agent dispenser holds 6 ounces (175 mL). Under normal conditions, this lasts about three months.

1. Open dishwasher door completely.
2. Remove Fill Indicator Cap.
3. Add rinse agent. Fill to smallest opening in lower part of dispenser only. Overfilling may cause rinse agent to leak out. This will not harm the dishwasher, but could cause oversudsing.
4. Clean up any spilled rinse agent with a damp cloth.
5. Replace Fill Indicator Cap. Keep it closed tightly.

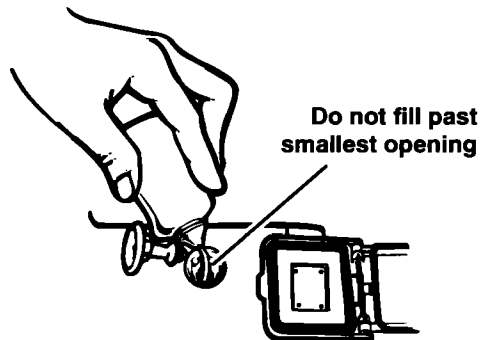

Keep dispenser filled for best drying results





NOTE: You do not have to wait until the dispenser is empty before refilling, but do not overfill it. Your dishwasher is designed to use a liquid rinse agent. You do not need to use a solid or bar-type rinse agent.

Setting the Controls

Operating your dishwasher's controls properly helps you obtain the best possible washing results. This section tells you how to select wash cycles and options.

Selecting a wash cycle

Press a Cycle pad. The dishwasher starts filling once you press a Cycle pad unless you select the delay wash cycle. You may press Option pads as the machine is filling.

CYCLE	A "•" shows what each cycle includes						CYCLE TIME (Minutes)
	WASH	RINSE	MAIN WASH	RINSE	FINAL RINSE	DRY	
RINSE/WASH LATER  For rinsing a few items to be washed one or more days later. <ul style="list-style-type: none"> • Do not use detergent. • Water is not heated during RINSE/WASH LATER. • AIR DRY is automatically selected. 				•	•		12
LOW ENERGY/CHINA  Single wash for prerinsed or lightly soiled loads. <ul style="list-style-type: none"> • Select HIGH TEMP WASH to heat water in the main wash (marked †). • The water heats to 140°F (60°C) in the final rinse (marked ††). 			•†	•	•††	•	60*
NORMAL  Double wash for normal, everyday soiled loads. (The Energy Guide label is based on this cycle.) <ul style="list-style-type: none"> • Select HIGH TEMP WASH to heat water in the main wash (marked †). • The water heats to 140°F (60°C) in the final rinse (marked ††). 	•		•†	•	•††	•	66*
POTS-N-PANS  Double wash for maximum cleaning of cooked-on or baked-on foods. <ul style="list-style-type: none"> • The water heats to 140°F (60°C) in both washes (marked †). • The water heats to 140°F (60°C) in the final rinse (marked ††). 	•†	•	•†	•	•††	•	76*

12 * Cycle time includes dry time and may be longer depending on the temperature of water entering the dishwasher. The cooler the water, the longer the cycle time. If the water is already hot enough, the cycle times will be as shown.

Using CANCEL/DRAIN

Press CANCEL/DRAIN to cancel a cycle or to clear the indicators.



To clear the indicators:

Press CANCEL/DRAIN before starting the dishwasher to clear all cycle and option selections.

To cancel a cycle:

- Press CANCEL/DRAIN while the dishwasher is running to start a 2-minute drain. It will take a few seconds for the drain to start. If desired, select a new cycle. (See "Changing a cycle or option setting" page 14.)
- You can press CANCEL/DRAIN again to stop the drain immediately. Remember to drain the dishwasher again before starting a new cycle.

NOTE: A small amount of water remaining in the dishwasher is normal.

Selecting cycle options

You can press an Option pad after the dishwasher starts as long as the cycle is not past the point that the option is used. For example, you can press AIR DRY any time before the DRYING indicator glows.

After a wash cycle, the dishwasher remembers the options used and uses the same options in the next wash cycle unless new options are selected or the CANCEL/DRAIN pad is pressed.

HIGH TEMP WASH

When HIGH TEMP WASH is selected, the dishwasher heats the water during the main wash of the LOW ENERGY/CHINA and NORMAL cycles. Heating the water helps improve washing results. The POTS-N-PANS cycle automatically uses HIGH TEMP WASH.



AIR DRY

When AIR DRY is selected, the air in the dishwasher is not heated during the "dry" portion of a cycle. Using AIR DRY helps save energy, but dishes take longer to dry and some spotting can occur. Some items (such as plastics) may need towel drying. For best drying, use a liquid rinse agent.

NOTE: The dishwasher automatically heats the air in the dishwasher during the "dry" portion of the cycle unless you select AIR DRY.



SETTING THE CONTROLS

Changing a cycle or option setting

During the first minute of a cycle

1. Press new Cycle and/or Option pads.
2. Check the detergent dispensers. They must be filled properly for the new cycle.

After the first minute of a cycle

1. Press CANCEL/DRAIN. A 2-minute drain cycle starts. Wait for drain cycle to finish.
2. Press a new Cycle pad.
3. If desired, press one or more Option pad(s).
4. Check the detergent dispensers. They must be filled properly for the new cycle.

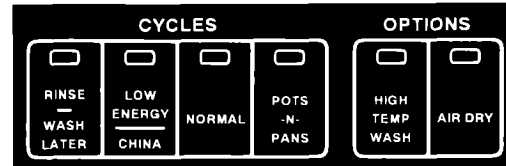

Adding a dish during a cycle

You can add an additional item to the dishwasher anytime before the main wash portion of a cycle. See chart on page 12.

1. Lift up the door latch to stop the cycle. Wait for spraying action to stop before opening the door.
2. Open the door and add the item.
3. Close the door, but **do not** latch it. Wait 30 seconds for the air in the dishwasher to warm up. Doing so reduces the amount of moisture in the vent when restarting a cycle.
4. Close the door firmly until it latches. The dishwasher resumes the cycle.

Understanding the status indicators

LOCK OUT

The LOCK OUT feature lets you lock out the function of the control pads. **When using LOCK OUT, you cannot start the dishwasher.**



To use LOCK OUT:

- Press and hold AIR DRY (about 5 seconds) until the LOCK OUT indicator glows.



To turn off LOCK OUT:

- Press and hold AIR DRY (about 5 seconds) until the LOCK OUT indicator turns off.

WASHING

The WASHING indicator glows at the start of the first fill of any cycle (except RINSE/WASH LATER) and remains on until the end of the main wash.



WATER HEATING

The WATER HEATING indicator glows whenever water is heated during a cycle.



RINSING

The RINSING indicator glows during the last two rinses of all cycles.



DRYING

The DRYING indicator glows during the drying portion of each cycle – even if you select AIR DRY. It turns off at the end of the cycle. If dishes are not as dry as you expected when using AIR DRY, either allow longer drying times (overnight) or do not use AIR DRY.



CLEAN

The CLEAN indicator glows at the end of a cycle to show that the load is clean. All other indicators turn off. The CLEAN indicator glows until you press CANCEL/DRAIN or any other control pad.



Washing Special Items

If you have any doubts about washing a particular piece of dishware, check with the manufacturer to see if it is dishwasher safe.

MATERIAL	DISHWASHER SAFE?	EXCEPTIONS/SPECIAL INFORMATION
Aluminum	Yes	High water temperature and detergents can pit finish of anodized aluminum.
Bottles and Cans	No	Wash bottles and cans by hand. Labels attached with glue can loosen in your dishwasher. Loose labels and glue can clog spray arms or the pump and will reduce washing performance.
Cast Iron	No	Seasoning will be removed and iron will rust.
China/ Stoneware	Yes	Always check manufacturer's recommendations before washing. Antique, hand-painted, or over-the-glaze patterns may fade. Gold leaf can discolor or fade.
Crystal	Yes	Always check manufacturer's recommendations before washing. Some types of leaded crystal can etch with repeated washings.
Gold	No	Gold-colored flatware will discolor.
Glass	Yes	Milk glass will yellow with repeated dishwasher washing.
Hollow-Handle Knives	No	Handles of some knives are attached to the blade with adhesives which may loosen if washed in the dishwasher.
Pewter	No	High water temperatures and detergent can discolor or pit finish.
Disposable Plastics	No	Cannot withstand high water temperatures and detergents.
Plastics	Yes	Always check manufacturer's recommendations before washing. Plastics vary in their capacity to withstand high water temperatures and detergents. Load plastics in top rack only.
Stainless Steel	Yes	Run the RINSE/WASH LATER cycle if not washing immediately. Prolonged contact with food containing salt, vinegar, milk products, or fruit juice can damage finish.
Sterling Silver or Silver Plate	Yes	Run the RINSE/WASH LATER cycle if not washing immediately. Prolonged contact with food containing salt, acid, or sulfide (eggs, mayonnaise, and seafood) can damage finish.
Tin	No	Can rust.
Wooden Ware	No	Always check manufacturer's recommendations before washing. Untreated wood can warp, crack, or lose its finish.

Connecting a Portable Dishwasher

NOTE: A special adapter must be installed on the faucet before the dishwasher can be connected. Complete instructions and the adapter are packed with your dishwasher.

When moving your dishwasher make sure the door is latched. Hold the dishwasher at the top front corners.

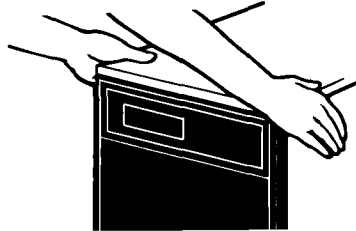

Connecting the dishwasher

1. Run water at faucet until it is **hot**. Turn water off.
2. Pull hoses out of their storage compartment on the back of the dishwasher.

NOTE: Make sure the hoses are not kinked or twisted. Kinked hoses reduce washing performance.

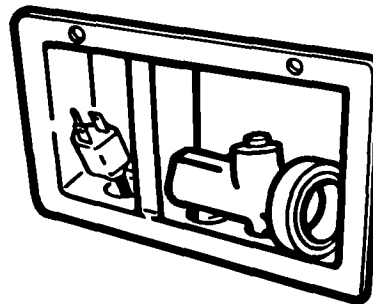

3. Pull down on the locking collar while lifting the hose connector onto the faucet adapter.
4. When the connector snaps into place, release the locking collar.
5. Turn the hot water on slowly until it is all the way on.
6. Plug in power supply cord.
7. See page 5 for instructions on how to start the dishwasher.

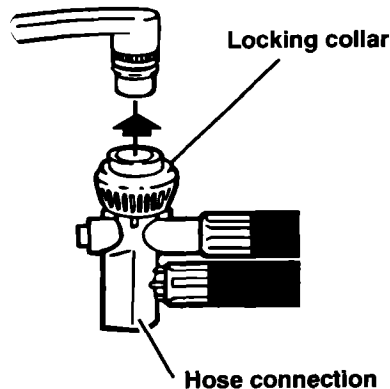

Drawing water when dishwasher is connected

You can draw water from the faucet while the dishwasher is connected. **Do not** draw water while the dishwasher is filling or while water is being pumped out. (This helps prevent a low fill when dishwasher is filling or mixing drain water with fresh water.)

- Press the red button on the hose connector to draw water from faucet. (The faucet is set on hot. Adjust faucet for the water temperature you want.)

NOTE: Turn hot water back on after you draw water from faucet. Turn off cold water.

CONNECTING A PORTABLE DISHWASHER

Disconnecting the dishwasher

1. Turn hot water off. (This can be done after the last rinse.)
2. Press the red button on the connector to release the water pressure.
3. Lift slightly on the hose connector while pulling down the locking collar. Pull down on the connector.
4. Empty any remaining water from the connector by turning the connector upside down.
5. Unplug power supply cord and return to storage compartment.
6. Return hoses to storage compartment.

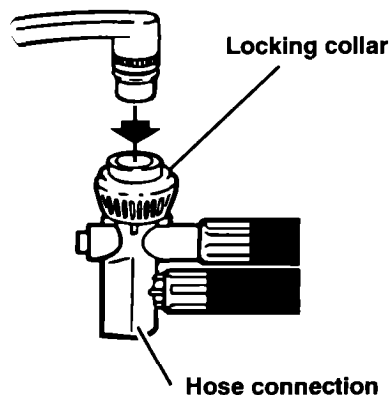

Electrical connection

A power supply of 120 volts, 60Hz AC, 15 or 20 amps, is required. For your personal safety, this appliance must be grounded. This appliance is equipped with a power supply cord having a 3-prong grounding plug. To minimize possible shock hazard it must be plugged into a mating 3-prong grounding type wall receptacle, grounded in accordance with the National Electrical Code and local codes and ordinances. If a mating wall receptacle is not available, it is the responsibility and obligation of the customer to have a properly grounded 3-prong wall receptacle installed by a qualified electrician.

3-prong ground-
ing plug

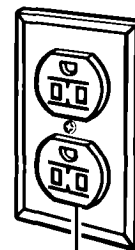
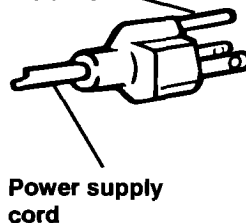

3-prong
grounding
type wall
receptacle

⚠ WARNING

Fire Hazard

An extension cord should not be used with this appliance.

Do not, under any circumstances, remove the power supply cord ground prong.

Such use may result in a fire, electrical shock, or other personal injury.

Converting a portable dishwasher to a built-in

Your Whirlpool Portable Dishwasher can be converted to a built-in (undercounter) model by using conversion kit No. 4317856. The kit

is available at your Whirlpool dealer or authorized Whirlpool service company. Instructions are included with the kit.

Caring for Your Dishwasher

Your new dishwasher is designed to give you many years of dependable service. There are a few things you can do to maintain your dishwasher properly. This section tells you how to clean and care for your dishwasher. Refer to "Solution chart" on pages 22-24 for special cleaning problems. See Installation Instructions for information on storing your dishwasher and for cleaning the drain air gap.

⚠ WARNING

Personal Injury Hazard

Before cleaning interior, wait at least 20 minutes after a cycle for the heating element to cool down.

Failure to do so could result in burns.

Caring for simulated wood top (on portable models)

The simulated wood top can be used as a utility work surface for most kitchen jobs. It is stronger and more easily cleaned than genuine wood.

The top can be used as a cutting board. Knife marks will be visible, but will not seriously damage top. Hot items from the oven can be placed on the top.

Clean top with warm, soapy water. For dried-on foods, use a scouring pad.

Cleaning the exterior

In most cases, regular use of a soft, damp cloth or sponge and a mild detergent is all that is necessary to keep the outside of your dishwasher nice looking and clean.



CARING FOR YOUR DISHWASHER

Cleaning the interior

Hard water minerals may cause a white film to build up on the inside surfaces, especially just beneath the door area. To clean interior:

- Apply powdered dishwasher detergent to a damp sponge to make a paste.

OR

- Use liquid automatic dishwasher detergent and clean with damp sponge.

Wear rubber gloves. **Do not** use any type of cleanser other than dishwasher detergent because it can cause foaming or sudsing.

NOTE: Follow the "Removing spots and film" procedure on page 24 to clean your dishwasher with white vinegar. Remember, this procedure is intended for occasional use only. Vinegar is an acid. Excessive use can damage your dishwasher.

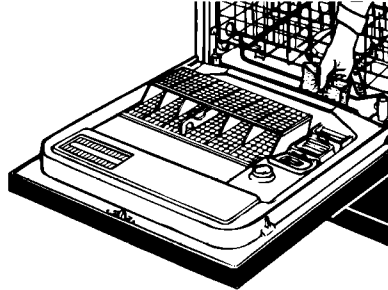

Overfill Protector

The Overfill Protector (in the front right corner of the dishwasher tub) keeps the dishwasher from overfilling. It must be in place for the dishwasher to operate.

Check under the float for objects that may keep the protector from moving up or down.



Saving Energy

Saving energy is important and helps you save money. This section gives you tips on the best ways to save energy with your dishwasher.

Loading tips

- Wash full loads. Running a half-filled dishwasher uses the same amount of electricity and hot water as a fully-loaded machine.
- Load correctly for best washing results. Incorrect loading may cause poor washing and the need to rewash all or part of load.
- Do not prerinse normally-soiled dishes. Select the correct cycle for the load and use the recommended amount of detergent.

Cycle and option tips

- Use the LOW ENERGY/CHINA cycle whenever possible. The cycle uses less hot water and energy than the NORMAL cycle.
- Run your dishwasher during off-peak hours. Local utilities recommend avoiding heavy usage of energy at certain times of day.
- Do not use the HIGH TEMP WASH option if it is not needed. When this option is off, if water entering the dishwasher is lower than 140°F (60°C), the cycle does not take additional time to heat water during the main wash. In some cases, loads may not dry as well when using the HIGH TEMP WASH option.
- Use the AIR DRY option whenever possible. Allow longer drying times (overnight). Use a rinse agent to improve drying.

NOTE: Loads may not wash or dry as well if the water temperature is too low. For best dishwashing results, water must be at least 120°F (49°C) as it enters the dishwasher.

To check water temperature:

1. Run the hot water at the faucet closest



to your dishwasher. Let the water run for at least 1 minute.

2. Hold a candy or meat thermometer in the running stream of water.

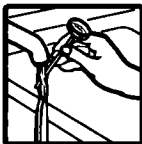

If water temperature at the faucet is below 120°F (49°C), have a qualified person raise the water heater's thermostat setting.

Solving Common Dishwashing Problems

A convenient checklist for handling minor performance problems. Go over this list before calling for service. If you are unable to solve your dishwasher's problem, turn to page 26 for service information.

Solution chart

PROBLEM	CAUSE	SOLUTION
Food soil left on dishes	Improper loading	Follow loading instructions on pages 6-9.
	Water temperature too low	Use the HIGH TEMP WASH option. If needed, turn home water heater up to ensure water entering dishwasher is 120°F (49°C) minimum. See "To check water temperature" on page 21. NOTE: In some cases, loads may not dry as well when using the HIGH TEMP WASH option.
	Use of incorrect, too little, or ineffective detergent	Use recommended dishwasher detergents only. Follow recommendations on page 10 for amounts. Never use less than one tablespoon per load. Detergent must be fresh to be effective. Always store detergent tightly closed in a cool, dry place.
	Detergent cakes in dispenser	Use fresh detergent only. Do not allow detergent to sit for several hours in a wet dispenser. Check dispenser for caked detergent. Clean dispenser when caked detergent is present.
	Insufficient fill due to low water pressure	Home water pressure should be 20 to 120 pounds per square inch (psi) for proper dishwasher fill. A booster pump on the water supply may be necessary if pressure is too low.
	Slowdown of wash arm due to high suds	Never use soap or laundry detergents. Use recommended dishwasher detergents only.
Spotting and filming	Hard water or high mineral content in water	Use rinse agent to help prevent spotting and filming. See page 11. To remove hard water film, see "Removing spots and film" on page 24.
	Water temperature too low	Use the HIGH TEMP WASH option. If needed, turn home water heater up to ensure water entering dishwasher is 120°F (49°C) minimum. See "To check water temperature" on page 21. NOTE: In some cases, loads may not dry as well when using the HIGH TEMP WASH option.
	Use of incorrect detergents	Use recommended dishwasher detergents only.

SOLVING COMMON DISHWASHING PROBLEMS

PROBLEM	CAUSE	SOLUTION
Spotting and filming (continued)	<p>Incorrect amount of detergent</p> <p>Use of ineffective detergents</p> <p>Insufficient fill due to low water pressure</p>	<p>Follow recommendations on page 10 for amount. Heavy soil and/or hard water generally require extra detergent.</p> <p>Use fresh detergent. Store detergent tightly closed in a cool, dry place. Discard lumpy detergent.</p> <p>Home water pressure should be 20 to 120 psi for proper dishwasher fill. A booster pump on the water supply may be necessary if pressure is too low.</p>
Cycle takes extremely long time	<p>Water temperature is too low</p> <p>Dishwasher is not installed properly</p>	<p>If needed, turn home water heater up to ensure water entering dishwasher is 120°F (49°C) minimum. See "To check water temperature" on page 21.</p> <p>Undercounter dishwashers require adequate enclosure for proper operation. See Installation Instructions for complete information.</p>
Dishes do not dry completely	<p>Dishes do not drain properly</p> <p>Plastics</p>	<p>Dishes must have proper water drainage. Do not overload. Follow instructions for loading dishwasher on pages 6-9. Use a liquid rinse agent to speed draining.</p> <p>Some plastics, due to material, may need to be towel dried.</p>
Silica film or etching (silica film is a white iridescent deposit; etching is a cloudy film)	<p>Water chemical reaction with certain types of glassware – usually caused by some combination of soft or softened water, alkaline washing solutions, insufficient rinsing, overloading the dishwasher, and heat of drying.</p>	<p>It may not be possible to prevent problem, except by hand washing. To slow this process, use a minimum amount of detergent but not less than one tablespoon per load. Use a liquid rinse agent and underload the dishwasher to allow thorough rinsing. Silica film and etching are permanent and cannot be removed. Use the AIR DRY option.</p>
Black or gray marks on dishes	<p>Aluminum items touching dishes</p>	<p>Load aluminum items so that they will not rub against dishes during washing. Do not wash throwaway aluminum items in the dishwasher because they may break down and cause marking. Remove aluminum markings by using a mild abrasive cleanser.</p>
White spots on cookware with non-stick finish	<p>Seasoning removed by dishwasher detergents</p>	<p>Reseason cookware after dishwasher washing.</p>

continued on next page

SOLVING COMMON DISHWASHING PROBLEMS

PROBLEM	CAUSE	SOLUTION
Brown stains on dishes and dishwasher interior	High iron content in water supply	Remove by washing dishes (after food soil has been removed) with 1 teaspoon to 1 tablespoon of citric acid crystals added to covered section of detergent dispenser. Do not use detergent. Follow with a LOW ENERGY/CHINA cycle and detergent. If treatment is needed more often than every other month, we recommend installation of an iron removal unit.
Orange stains on dishwasher interior	Large amounts of tomato-based foods on dishes placed in the dishwasher	Stains will not affect dishwasher performance and can gradually fade over time. Regular use of RINSE/WASH LATER reduces the chance of staining. If air in the dishwasher is heated during the "dry" portion of the cycle, stains may fade slower than if the AIR DRY option is selected.
Odor in the dishwasher	Dishes only washed every two to three days	Run a RINSE/WASH LATER cycle at least once or twice a day until a full load is accumulated.
Chipping of dishes	Improper loading	Load dishes and glasses so they are stable and do not strike together from washing action. Moving racks in and out slowly will also minimize chipping. NOTE: Some types of china and glassware are too delicate for automatic dishwashing and should be hand washed; for example: antiques, feather-edged crystal, and similar items.

Removing spots and film

Keep the rinse agent dispenser filled with a liquid rinse agent. A rinse agent prevents water from forming droplets and drying as spots or streaks.

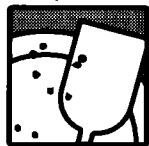

To remove spots and film on dishes and glasses, or hard water film/lime buildup on the interior of the dishwasher, you may use white vinegar with the following procedure:

1. Load clean dishes and glasses in dishwasher (see pages 6-9). Do not load silverware or other metals in the dishwasher.

2. Put 2 cups of household vinegar (in a glass or dishwasher safe measuring cup) standing upright in the bottom rack.
3. Close and latch the door.
4. Select the NORMAL cycle and AIR DRY option. Do not use detergent. Allow the dishwasher to complete the entire cycle.

NOTE: This cleaning procedure is intended for occasional use only. Vinegar is an acid. Excessive use may damage your dishwasher.

Troubleshooting

Before calling for assistance please check the chart below for problems you can fix. It could save you the cost of a service call.

Dishwasher problems

PROBLEM	CHECK THE FOLLOWING
Dishwasher does not run or stops during a cycle	<p>Is the door tightly closed and securely latched?</p> <p>Has the cycle been set correctly? See pages 5 and 12.</p> <p>Has a household fuse or circuit breaker blown or tripped?</p> <p>If the motor stopped because of an overload, it will automatically reset itself within a few minutes. If it does not start, call for service.</p> <p>Is the water supply turned on?</p> <p>Is the dishwasher wired into a live circuit with the proper voltage?</p>
Dishwasher runs too long	<p>Cycle times depend on the temperature of the water entering the dishwasher. Cooler water results in longer cycle times.</p> <p>Undercounter dishwashers require adequate enclosure for proper operation. See Installation Instructions for complete information.</p>
Dishwasher will not fill	<p>Is Overfill Protector stuck in "up" position? Overfill Protector should move up and down freely. Press down to release. See page 20.</p>
Water remains in dishwasher	<p>Allow cycle to finish. A small amount of water remaining is normal.</p> <p>Check the drain air gap (if installed). If it is clogged, follow the manufacturer's cleaning instructions.</p>
Detergent remains in covered section of dispenser	<p>Has the cycle completed?</p> <p>Is the detergent fresh and dry without lumps? See page 10.</p> <p>Is the bottom rack in backwards? The rack bumpers must face the dishwasher door.</p>
Dishes not as dry as you expected	<p>Is the rinse agent dispenser empty? Using a rinse agent greatly improves drying. See page 11.</p> <p>Do not use AIR DRY option on the next load. See page 13.</p>
Grinding, grating, crunching, or buzzing sounds	<p>Has a hard object entered the POWER CLEAN™ module?</p> <p>The sound should stop when the object is ground up.</p>
White residue appears on front of access panel	<p>Is too much detergent being used? See page 10 for recommended amounts of detergent.</p> <p>Some liquid detergents develop excess foam and residue on panel. Try a different brand to reduce foaming and eliminate buildup.</p>
Control panel does not respond when pads are pressed	<p>Is the control panel LOCK OUT feature on? See page 15.</p> <p>Is the door tightly closed and securely latched?</p>
Dishwasher drains after turning off indicators	<p>Did you accidentally press the CANCEL/DRAIN pad twice? Press CANCEL/DRAIN pad again to stop draining.</p>
Dishwasher will not close	<p>Is the bottom rack in backwards? The rack bumpers must face the dishwasher door.</p>

Requesting Assistance or Service

Before calling for assistance or service, please check "Troubleshooting" on page 25. It may save you the cost of a service call. If you still need help, follow the instructions below.

1. If you need assistance* ...

Call the Whirlpool Consumer Assistance Center telephone number. Dial toll-free from anywhere in the U.S.A.:



1-800-253-1301

and talk with one of our trained consultants. The consultant can instruct you in how to obtain satisfactory operation from your appliance or, if service is necessary, recommend a qualified service company in your area.

If you prefer, write to:

Mr. William Clark
Consumer Assistance Representative
Whirlpool Corporation
2000 North M-63
Benton Harbor, MI 49022-2692

Please include a daytime phone number in your correspondence.

2. If you need service* ...

Whirlpool has a nationwide network of authorized service companies. Whirlpool service technicians are trained to fulfill the product warranty and provide after-warranty service, anywhere in the United States. To locate the authorized Whirlpool service company in your area, call our Consumer Assistance Center telephone number (see Step 1) or look in your telephone directory Yellow Pages under:



• APPLIANCE-HOUSEHOLD-MAJOR, SERVICE & REPAIR

- See: Whirlpool Appliances or Authorized Whirlpool Service
(Example: XYZ Service Co.)

• WASHING MACHINES & DRYERS, SERVICE & REPAIR

- See: Whirlpool Appliances or Authorized Whirlpool Service
(Example: XYZ Service Co.)

3. If you need FSP® replacement parts ...

FSP is a registered trademark of Whirlpool Corporation for quality parts. Look for this symbol of quality whenever you need a replacement part for your Whirlpool® appliance. FSP replacement parts will fit right and work right, because they are made to the same exacting specifications used to build every new Whirlpool appliance.

To locate FSP replacement parts in your area, refer to Step 2 or call the Whirlpool Consumer Assistance Center number in Step 1.

4. If you are not satisfied with how the problem was solved ...

- Contact the Major Appliance Consumer Action Program (MACAP). MACAP is a group of independent consumer experts that voices consumer views at the highest levels of the major appliance industry.
- Contact MACAP only when the dealer, authorized servicer, and Whirlpool have failed to resolve your problem.

Major Appliance Consumer Action Program
20 North Wacker Drive
Chicago, IL 60606

- MACAP will in turn inform us of your action.

*When asking for help or service:

Please provide a detailed description of the problem, your appliance's complete model and serial numbers, and the purchase date. (See page 2.) This information will help us respond properly to your request.

Index

This index is alphabetical. Look for the word or phrase you are interested in, then look for the page number.

TOPIC	PAGE	TOPIC	PAGE
BOTTOM RACK	8	OPTIONS	13
CLEANING		OVERFILL PROTECTOR	20
Exterior	19	PARTS/FEATURES	4
Interior	20	RESPONSIBILITIES	
COMMON WASHING PROBLEMS		Owner	2
Solving	22-24	RINSE AGENT	
CONNECTING A PORTABLE		Using	11
DISHWASHER	17	SAFETY	3
CONVERTING TO BUILT-IN	18	SERVICE	
CYCLE		Parts	26
Canceling	13	Requesting	26
Selecting	12	SILVERWARE BASKET	7
DETERGENT		SPECIAL ITEMS	
Tips	10	Washing	16
Use chart	10	SPOTS/FILM	
DISHWASHER OPERATION		Removing	24
Adding items during cycle	14	STATUS INDICATORS	15
Changing cycle	14	TOP RACK	
Starting	5	Adjusting	9
Stopping	5	Loading	8-9
DISPENSER		TROUBLESHOOTING	25
Detergent	10	WARRANTY	32
Rinse Agent	11	WATER	
ENERGY		Checking temperature	21
Saving	21	Heating indicator	15
FEATURES/PARTS	4		
FILM/SPOTS			
Removing	24		
LOADING			
Bottom rack	8		
Preparing to load	6		
Silverware basket	7		
Top rack	8-9		

**POWER CLEAN™ washing system parts
covered by your warranty**

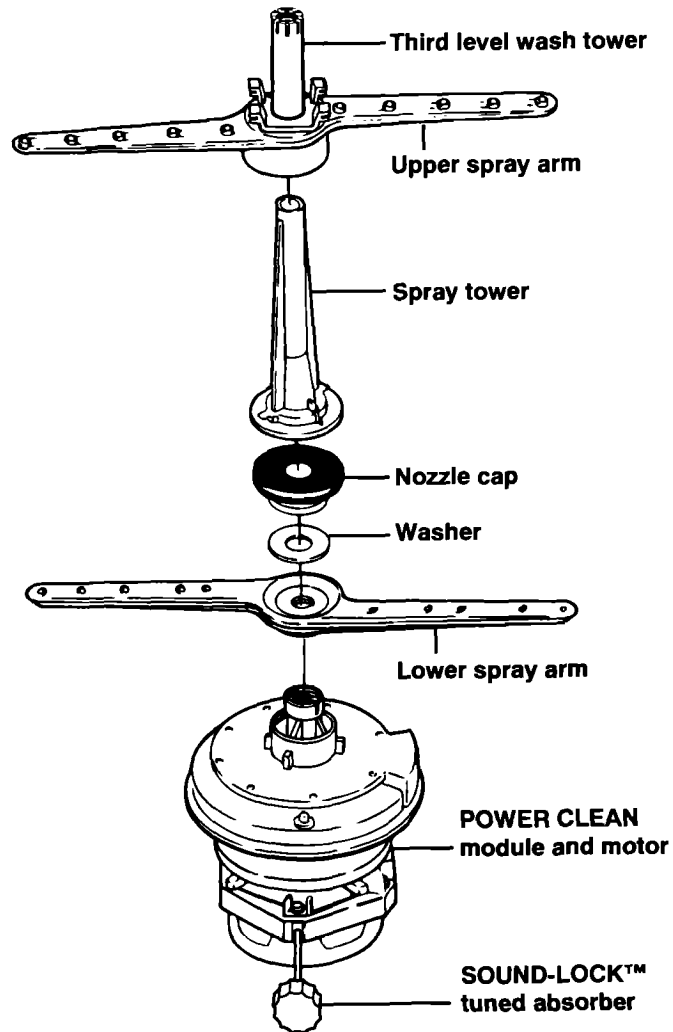

WHIRLPOOL®

Dishwasher Warranty

LENGTH OF WARRANTY	WHIRLPOOL WILL PAY FOR
FULL ONE-YEAR WARRANTY From Date of Purchase	FSP® replacement parts and repair labor to correct defects in materials or workmanship. Service must be provided by an authorized Whirlpool service company.
LIMITED ONE-YEAR WARRANTY Second Year From Date of Purchase	FSP replacement parts for any part of the POWER CLEAN™ washing system if defective in materials or workmanship. These parts are shown on page 31 of this book.
LIMITED FOUR-YEAR WARRANTY Second Through Fifth Year From Date of Purchase	FSP replacement parts for Electronic Control System if defective in materials or workmanship. For models with dishracks that are oyster-colored, FSP replacement parts for the top and/or bottom dishracks if they rust due to defective materials or workmanship.
FULL TWENTY-YEAR WARRANTY From Date of Purchase	FSP replacement parts and repair labor for the DURAPERM™ tub and/or inner door should they fail to contain water due to defective materials or workmanship. Service must be provided by an authorized Whirlpool service company.
WHIRLPOOL WILL NOT PAY FOR	
<p>A. Service calls to:</p> <ol style="list-style-type: none"> 1. Correct the installation of the dishwasher. 2. Instruct you how to use the dishwasher. 3. Replace house fuses or correct house wiring or plumbing. <p>B. Repairs when dishwasher is used in other than normal, single-family household use.</p> <p>C. Pickup and delivery. This product is designed to be repaired in the home.</p> <p>D. Damage to dishwasher caused by accident, misuse, fire, flood, acts of God, or use of products not approved by Whirlpool.</p> <p>E. Any labor costs during limited warranties.</p> <p>F. Repairs to parts or systems caused by unauthorized modifications made to the appliance.</p>	

8/94

WHIRLPOOL CORPORATION SHALL NOT BE LIABLE FOR INCIDENTAL OR CONSEQUENTIAL DAMAGES. Some states do not allow the exclusion or limitation of incidental or consequential damages, so this exclusion or limitation may not apply to you. This warranty gives you specific legal rights, and you may also have other rights which vary from state to state.

Outside the United States, a different warranty may apply. For details, please contact your authorized Whirlpool dealer.

If you need service, first see the "Requesting Assistance or Service" section of this book. After checking "Requesting Assistance or Service," additional help can be found by calling our Consumer Assistance Center telephone number, **1-800-253-1301**, from anywhere in the U.S.A.



Printed on recycled paper –
 10% post-consumer waste
 50% recovered materials

PART NO. 3373752 Rev. A

© 1995 Whirlpool Corporation

® Registered Trademark /TM Trademark of Whirlpool, U.S.A.

4/95
 Printed in U.S.A.