

Mfg DESA Pis 583
REMINGTON®

BRANCH WIZARD®
ELECTRIC PRUNING SAW
OWNER'S MANUAL



MODEL DPS-1: 111409-01

IMPORTANT: Read and understand this manual before assembling or operating this Pole Saw. Improper use of Pole Saw can cause severe injury. Keep this manual for future reference.



DO NOT RETURN PRODUCT TO STORE.

CALL 1-800-626-2237 FOR TECHNICAL ASSISTANCE

For more information, visit www.remingtonpowertools.com
This manual is your guide to safe and proper operation of the saw.

SAVE THESE INSTRUCTIONS.

Keep your purchase receipt for warranty coverage.

NO DEVUELVA EL PRODUCTO A LA TIENDA

Para más información, www.remingtonpowertools.com

PARA AYUDA TÉCNICA LLAME AL 1-800-626-2237

Este manual es su guía para utilizar esta sierra eléctrica de
manera adecuada y segura.

GUARDE ESTAS INSTRUCCIONES.

Guarde su recibo de compra para cobertura de la garantía.

NE RETOURNEZ PAS LE PRODUIT AU DÉTAILLANT

**FAITES LE 1 800 626-2237 POUR OBTENIR
DE L'ASSISTANCE TECHNIQUE**

Pour plus de détails, visitez le www.remingtonpowertools.com.
C'est un guide pour l'utilisation sécuritaire et correcte de la tronçonneuse.

CONSERVER CES DIRECTIVES

Conservez votre reçu d'achat pour obtenir le service sous garantie.

CONTENTS

IMPORTANT SAFETY INFORMATION	4
Before Operating Saw	4
While Operating Saw	4
Kickback	5
Maintenance and Storage of Chain Saw	5
POLE SAW TRIMMING PRECAUTIONS	6
UNPACKING	6
PRODUCT IDENTIFICATION	7
CHAIN SAW NAMES AND TERMS	7
ASSEMBLY	8
SAW CHAIN TENSION ADJUSTMENT	9
OPERATING CHAIN SAW	10
Extension Cords	10
Oiling Chain	10
Cutting with Pole Saw	11
Trimming a Tree (Pruning)	11
CLEANING AND MAINTENANCE	12
Care of Guide Bar	12
Sharpening Saw Chain	13
Replacing Saw Chain	14
STORAGE	14
REPLACEMENT PARTS AND ACCESSORIES	14
TECHNICAL SERVICE	14
REPAIR SERVICE	14
Warranty Service	14
Non-Warranty Service	14
WARRANTY INFORMATION	15
ILLUSTRATED PARTS BREAKDOWN	46
PARTS CENTRAL	47

ENGINE

If you have a question or problem, CALL TOLL FREE 1-800-626-2237
or visit www.remingtonpowertools.com

IMPORTANT SAFETY INFORMATION

Before operating Pole Saw, make certain you read and understand all *Important Safety Information*



WARNING: When using an electric Pole Saw, basic safety precautions should always be followed to reduce the risk of fire, electric shock, and injury to persons, including the following:

READ ALL INSTRUCTIONS.

Make sure you read and understand all instructions in *Important Safety Information*.

Improper use of this Pole Saw can cause severe injury or death from fire, electrical shock, body contact with moving chain, or falling wood.

BEFORE OPERATING SAW

1. Read and understand Pole Saw manual before operating Pole Saw.
2. Watch what you are doing. Use common sense. Do not operate Pole Saw when you are tired.
3. Use Pole Saw for cutting wood only. Do not use Pole Saw for purpose not intended. Do not use for cutting non-wood items.
4. Only well-instructed adults should operate Pole Saw. Never allow children to operate Pole Saw.
5. Use only electrical voltage noted on model plate of Pole Saw.
6. Use only extension cords marked for outdoor use. See *Operating Pole Saw* section extension cord requirements.
7. Do not operate Pole Saw
 - while under the influence of alcohol, medication, or drugs
 - in rain or in damp or wet areas
 - where highly flammable liquids or gases are present
 - if Pole Saw is damaged, adjusted wrong, or not fully and securely assembled
 - if trigger does not turn Pole Saw on and off. Chain must stop moving when you release trigger. Have faulty switch replaced by authorized service center (see *Technical Service*)
 - while in a hurry
 - while in tree or on a ladder
 - while on aerial booms, buckets or platforms
 - during high wind or storming weather
8. Wear snug-fitting clothes when operating Pole Saw. Do not wear loose clothing or jewelry. They can get caught in moving saw chain.

9. Wear the following safety gear when operating Pole Saw:
 - heavy-duty gloves (wear rubber gloves when working outdoors)
 - steel-toed safety footwear with non-skid soles
 - eye protection such as safety glasses, goggles, or face screen
 - safety hard hat
 - ear muffers or ear plugs
 - hair covering to contain long hair
 - face or dust mask (if working in dusty areas)
10. Before cutting, always provide the following:
 - clear work area
 - secure footing
 - planned retreat path from falling limbs
11. Inspect tree before trimming. Make allowance for branches to fall freely to the ground.
12. Do not use your Pole Saw to fell saplings.
13. To reduce the risk of electric shock, this Pole Saw has a polarized plug (one blade is wider than the other). This plug will fit in the polarized outlet of an extension cord only one way. If the plug does not fit fully in the outlet of your extension cord, reverse the plug. If it still does not fit, a polarized extension cord will be necessary. If the polarized plug of the extension cord does not fit fully in the outlet, reverse the plug. If it still does not fit, contact a qualified electrician to install the proper outlet. Do not change the plug in any way.

WHILE OPERATING POLE SAW

1. Stay alert. Use common sense while operating the unit.
2. Keep work area clean. Cluttered areas invite injuries.
3. Be aware of extension cord while operating Pole Saw. Be careful not to trip over cord. Keep cord away from chain and operator at all times.
4. Keep children, animals, and bystanders away from Pole Saw and extension cord. Only Pole Saw user should be in work area.
5. Do not use the Pole Saw to cut down trees.
6. Do not use near power lines. Keep at least 10 feet away from electrical lines.
7. Grip Pole Saw securely - one hand on the pole, the other on the handle.
8. Keep finger off trigger until ready to make cut.
9. Before starting Pole Saw, make sure chain is not touching anything.
10. To guard against electrical shock, avoid body contact with grounded objects such as pipes, fences, and metal posts.
11. Keep all parts of body away from chain when Pole Saw is running.

IMPORTANT SAFETY INFORMATION

12. Do not force Pole Saw while cutting. Apply light pressure. It will do the job better and safer at the rate for which it was intended.
13. When cutting a limb that is under tension, use extreme caution. Be alert for wood springing back. When wood tension is released, limb could spring back and strike operator causing severe injury or death.
14. Carry Pole Saw from one place to another
 - with unit unplugged
 - by holding pole at balance point (close to saw end)
 - with guide bar and chain to rear
15. Do not cut small brush and saplings with the Pole Saw. Slender matter may catch in the chain and be whipped toward you. This could also pull you off balance.



WARNING: This product contains chemicals known to the State of California to cause cancer or birth defects, or other reproductive harm.



WARNING: Some dust created by power sanding, sawing, grinding, drilling, and other construction activities contains chemicals known (to the state of California) to cause cancer, birth defects, or other reproductive harm. Some examples of these chemicals are:

- lead from lead-based paints
- crystalline silica from bricks and cement and other masonry products
- arsenic and chromium from chemically-treated lumber

Your risk from these exposures varies, depending on how often you do this type of work. To reduce your exposure to these chemicals: work in a well ventilated area, and work with approved safety equipment, such as those dust masks that are specially designed to filter out microscopic particles.

KICKBACK



WARNING: Kickback may occur when the nose or tip of the guide bar touches an object, or when the wood closes in and pinches the saw chain in the cut. Tip contact in some cases may cause a lightning fast reverse reaction, kicking the guide bar up and back towards the operator. Pinching the saw chain along the top of the guide bar may push the guide bar rapidly back towards the operator. Either of these reactions may cause you to lose control of the Pole Saw which could result in serious injury to user.

ENGLISH

Kickback Safety Devices On This Pole Saw

This Pole Saw has a low-kickback chain and reduced kickback guide bar. Both items reduce the chance of kickback. Kickback can still occur with this Pole Saw.

The following steps will reduce the risk of kickback:

- Use both hands - one gripping the handle and the other gripping the pole. Use firm grip. Thumbs and fingers must wrap around pole and handle.
- Keep all safety items in place on Pole Saw. Make sure they work properly.
- Do not overreach or extend arms above shoulder height.
- Keep solid footing and balance at all times.
- Never try cutting through two branches at the same time. Only cut one at a time.
- Do not bury guide bar nose or try plunge cut (boring into wood using guide bar nose).
- Watch for shifting of wood or other forces that may pinch chain.
- Use extreme caution when reentering a previous cut.
- Use low-kickback chain and guide bar supplied with the Pole Saw. Only use replacement parts listed for the Pole Saw.
- Never use dull or loose chain. Keep chain sharp with proper tension.

MAINTENANCE AND STORAGE OF POLE SAW

Unplug Pole Saw from power source and follow maintenance and storage procedures outlined in *Cleaning and Maintenance and Storage*.

IMPORTANT SAFETY INFORMATION

POLE SAW TRIMMING PRECAUTIONS

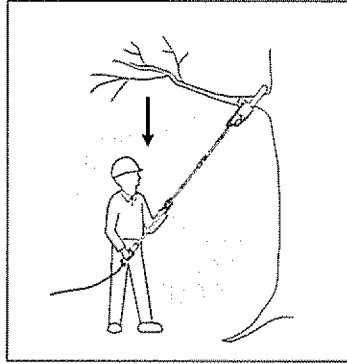

Never stand directly under the limb you are trimming. Always position yourself out of the path of falling debris.

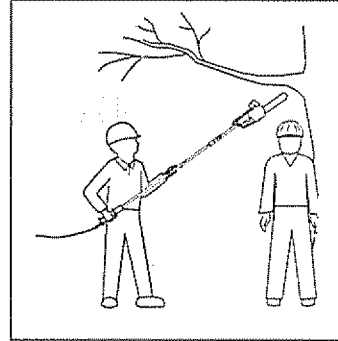

Keep other persons away from cutting end of Pole Saw and at a safe distance from work area.

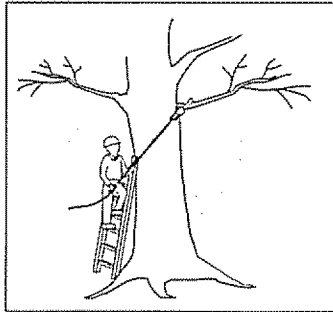

Never stand on a ladder or other type of unstable support while using the Pole Saw. Always use both hands to operate Pole Saw. Keep a firm, steady pressure on the Pole Saw while cutting but do not try to force the Pole Saw through the wood. Do not use the Pole Saw to cut limbs larger in diameter than the length of the guide bar.

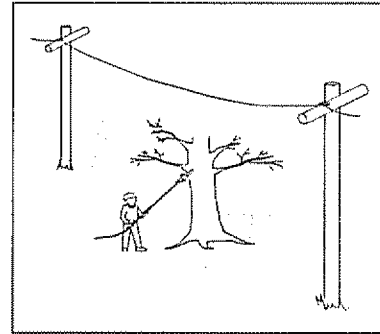

Do not use Pole Saw near cable, electric power or telephone lines. Maintain a minimum clearance of 10 feet from all power lines.

UNPACKING

1. Remove all items from carton
2. Check all items for any shipping damage. If you find any damage or if any parts are missing, promptly inform dealer where you bought the Pole Saw.

SAVE THESE INSTRUCTIONS

PRODUCT IDENTIFICATION

MODEL DPS-1: 111409-01

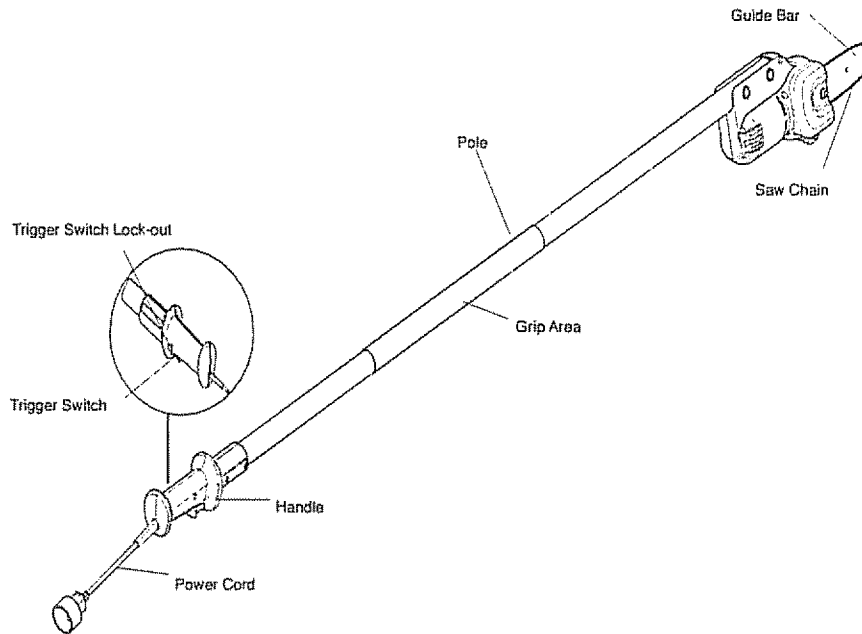

ENGLISH

CHAIN SAW NAMES AND TERMS

Guide Bar Metal bar that extends from saw body. The guide bar supports and guides chain
Kickback Quick backward and upward motion of guide bar. Kickback may occur when tip of guide bar touches an object while chain is moving. The guide bar will kick up and back towards operator.
Saw Chain (Chain) Loop of chain having cutting teeth for cutting wood. The motor drives chain. The guide bar supports chain.
Sprocket Toothed wheel that drives chain.
Switch Device that completes or interrupts electrical circuit to motor of saw.

Switch Lockout Device that reduces accidental starting of saw.
Trigger Device that turns saw on and off. Squeezing trigger turns saw on. Releasing trigger turns saw off.
Trimming (Pruning) Process of cutting limb(s) from a living tree.
Undercut An upward cut from underside of log or limb. This is done while in normal cutting position and cutting with top of guide bar.

ASSEMBLY

IMPORTANT: Read and understand this manual before assembling or operating this Pole Saw. Improper use of Pole Saw can cause severe injury. Keep this manual for future reference.

Note: Some models are pre-assembled. Assembly is not needed on these models.

See *Saw Chain Tension Adjustment*.

WARNING: Cutting edges on chain are sharp. Use protective gloves when handling chain.

IMPORTANT: Do not clamp Pole Saw in vise during assembly.

1. Lay chain out flat.
2. Loosen and remove guide bar nut, sprocket cover, and washer (see Figure 1).
3. Install guide bar onto saw body. Place center slot of guide bar onto guide bar bolt.
4. Place chain around drive sprocket, then along top groove of guide bar and around guide bar nose. **Note:** Make sure cutting edges of chain are facing the right direction. Position chain so cutting edges on top of guide bar face guide bar nose (see Figure 2 and indicator on side cover of Pole Saw).

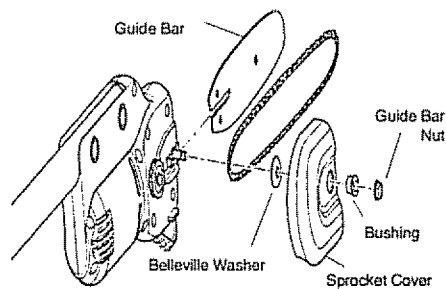

Figure 1 - Installing Guide Bar

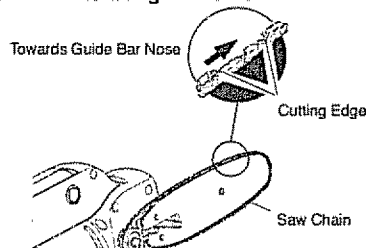

Figure 2 - Chain Position

CAUTION: Do not place chain on saw backwards. If chain is backwards, saw will vibrate badly and will not cut.

5. Place Belleville washer, sprocket cover, and guide bar nut onto Pole Saw. **IMPORTANT:** Make sure serrated edge of the Belleville washer is positioned as shown in Figure 3. The serrated edge must be in contact with the guide bar. **IMPORTANT:** Tighten guide bar nut finger tight only.
6. Adjust saw chain tension. Follow steps under *Saw Chain Tension Adjustment*.

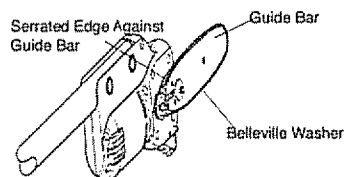

Figure 3 - Belleville Washer Assembly

SAW CHAIN TENSION ADJUSTMENT

WARNING: Unplug Pole Saw from power source before adjusting saw chain tension.

WARNING: Cutting edges on chain are sharp. Use protective gloves when handling chain.

WARNING: Maintain proper chain tension always. A loose chain will increase the risk of kickback. A loose chain may jump out of guide bar groove. This may injure operator and damage chain. A loose chain will cause chain, guide bar, and sprocket to wear rapidly.

Note: For pre-assembled models, the saw chain tension is properly set at factory. A new chain will stretch. Check new chain after first few minutes of operation. Allow chain to cool down. Follow steps below to readjust saw chain tension.

- 1 Before adjusting chain, make sure guide bar nut is only finger tight (see Figure 4)

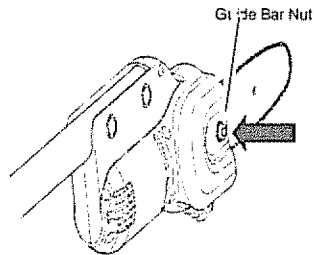

Figure 4 - Loosen Guide Bar Nut

- 2 Insert a #1 Phillips head screwdriver or smaller into the hole in the middle of the guide bar (see Figure 5). Using the screwdriver, push the guide bar away from Pole Saw motor housing to tension the chain. **Note:** There should be no gap between side links of chain and bottom of guide bar (see Figure 6)

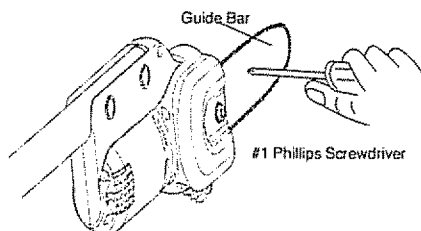

Figure 5 - Chain Tension Adjustment

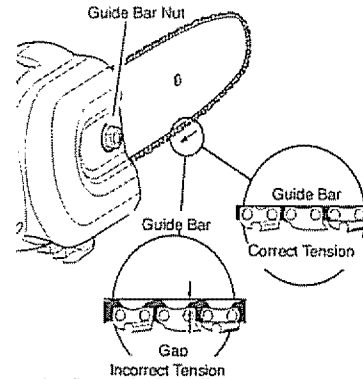

Figure 6 - Saw Chain Adjustment

- 3 After chain tension is correct, tighten guide bar nut firmly. If not, guide bar will move and loosen chain tension. This will increase the risk of kickback. This can also damage Pole Saw. **Note:** A new chain will stretch. Check new chain after first few minutes of operation. Allow chain to cool down. Readjust chain tension.

ENGLISH

OPERATING POLE SAW

⚠ WARNING: Read and understand this owner's manual before operating this Pole Saw. Make certain you read and understand all **Important Safety Information**. Improper use of this Pole Saw can cause severe injury or death from fire, electrical shock, or body contact with moving chain or falling wood.

EXTENSION CORDS

Use proper extension cords with this Pole Saw. Use only extension cords marked for outdoor use. The cord must be marked with suffix W or W-A following the cord type designation. **Example:** SJTW-A or SJTW.

Use proper sized cord with this Pole Saw. Cord must be heavy enough to carry current needed. An undersized cord will cause voltage drop at Pole Saw. Pole saw will lose power and overheat. Follow cord size requirements listed below.

Cord Length	AWG Cord Size
25 feet	16 AWG
50 feet	16 AWG
100 feet	16 AWG
150 feet	14 AWG

Keep cord away from cutting area. Make sure cord does not catch on branches or logs during cutting. Inspect cords often. Replace damaged cords.

The extension cord may come undone from the power cord during use. To avoid this, make a knot with the two cords as shown in Figure 7.

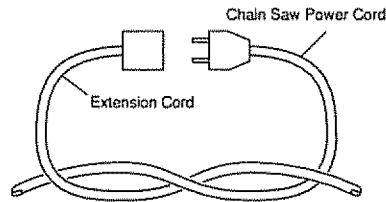

Figure 7 - Tying Extension Cord and Power Cord in Knot

OILING CHAIN

This Pole Saw requires lubrication only to prevent rust on the guide bar and saw chain. The saw chain provided is pre-lubricated at the factory. With each use of the Pole Saw apply a small amount of lubricating oil directly to the saw chain (see Figure 8). The oil will distribute itself around the chain and guide bar groove during use—preventing rust. We recommend using SAE #30 motor oil for lubrication and rust prevention.

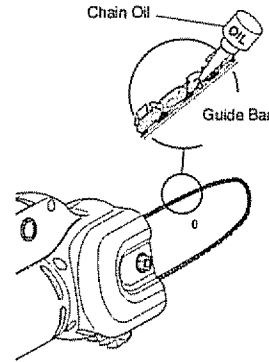

Figure 8 - Oil Chain and Guide Bar

OPERATING POLE SAW

CUTTING WITH THE POLE SAW

1. Connect Pole Saw to extension cord. Connect extension cord to power supply.
2. Use both hands to grip Pole Saw. Use only designated grip areas when operating Pole Saw (see Figure 9, page 12). Use firm grip. Thumbs and fingers must wrap around Pole Saw handle and pole.
3. Make sure your footing is firm. Keep feet apart. Divide your weight evenly on both feet.
4. When ready to make a cut, press in trigger switch lock-out and squeeze trigger switch (see Figure 10, page 12). This will turn Pole Saw on. Releasing trigger switch will turn Pole Saw off. Make sure Pole Saw is running at full speed before starting a cut.
5. When starting a cut, place moving chain against wood. Hold Pole Saw firmly in place to avoid possible bouncing or skating (sideways movement) of Pole Saw.
6. Guide Pole Saw using light pressure. Do not force Pole Saw. The motor will overload and can burn out. It will do the job better and safer at the rate for which it was intended.
7. Remove Pole Saw from a cut with Pole Saw running at full speed. Stop Pole Saw by releasing trigger. Make sure chain has stopped before setting Pole Saw down.

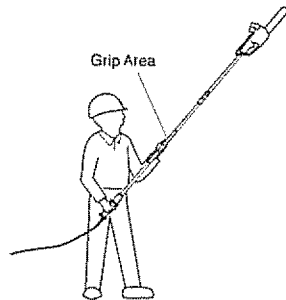

Figure 9- Designated Grip Areas

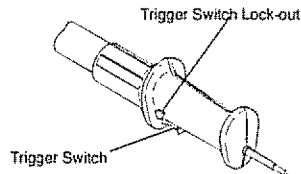

Figure 10 - Pole Saw Handle with Trigger Switch

TRIMMING A TREE (PRUNING)

WARNING: Avoid kickback. Kickback can result in severe injury or death. See Kickback to avoid risk of kickback.

WARNING: Do not operate Pole Saw while in a tree
 • on a ladder or any other unstable surface
 • in any awkward position

You may lose control of Pole Saw causing severe injury.

Trimming a tree is the process of cutting limbs from a living tree. Make sure your footing is firm. Keep feet apart. Divide your weight evenly on both feet. Follow directions below to trim a tree.

1. Make first cut six inches from tree trunk on underside of limb. Use top of guide bar to make this cut. Cut 1/3 through diameter of limb (see Figure 11).
2. Move two to four inches farther out on limb. Make second cut from above limb. Continue cut until you cut limb off.
3. Make third cut as close to tree trunk as possible on underside of limb stub. Use top of guide bar to make this cut. Cut 1/3 through diameter of stub.
4. Make fourth cut directly above third cut. Cut down to meet third cut. This will remove limb stub.

WARNING: Do not extend Pole Saw handle above shoulder height.

CAUTION: Seek professional help if facing conditions beyond your ability.

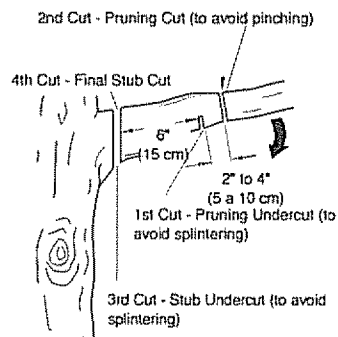

Figure 11 - Cutting A Limb

CLEANING AND MAINTENANCE

NOTICE: Below are instructions for servicing your Pole Saw. Any servicing not mentioned below should be done by an authorized service center.

WARNING: Unplug Pole Saw from power source before servicing. Severe injury or death could occur from electrical shock or body contact with moving chain.

WARNING: Cutting edges on chain are sharp. Use protective gloves when handling chain.

WARNING: When cleaning Pole Saw body:

- do not submerge Pole Saw in any liquids
- do not use products that contain ammonia, chlorine, or abrasives
- do not use chlorinated cleaning solvents, carbon tetrachloride, kerosene, or gasoline

Keep Pole Saw body clean. Use a soft cloth dampened with a mild soap and water mixture. Wipe Pole Saw body to clean.

CARE OF GUIDE BAR

Uneven bar wear causes most guide bar problems. Incorrect sharpening of chain cutter and depth gauge settings often cause this. When bar wears unevenly, it widens guide bar groove (see Figure 12). This causes chain clatter and rivet popping. Saw will not cut straight. Replace guide bar if this occurs.

Inspect guide bar before sharpening chain. A worn or damaged guide bar is unsafe. A worn or damaged guide bar will damage chain. It will also make cutting harder.

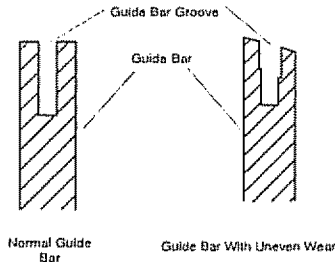

Figure 12 - Guide Bar Cross Section Showing Uneven Bar Wear

Normal Guide Bar Maintenance

1. Remove guide bar from Pole Saw.
2. Remove sawdust from guide bar groove periodically. Use putty knife or wire (see Figure 13).
3. Clean oil slots after each day of use.
4. Remove burrs from sides of guide bar. Use flat file to make side edges square.

Replace guide bar when:

- bar is bent or cracked
- inside groove of bar is badly worn

Note: When replacing guide bar, see *Replacement Parts and Accessories* for proper bar.

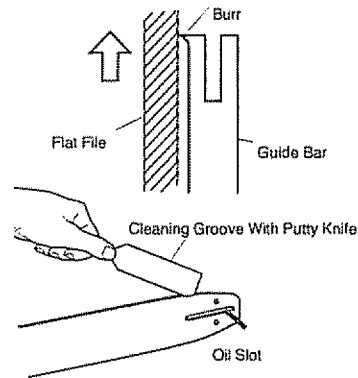

Figure 13 - Guide Bar Maintenance

CLEANING AND MAINTENANCE

SHARPENING SAW CHAIN

⚠ WARNING: Unplug Pole Saw from power source before servicing. Severe injury or death could occur from electrical shock or body contact with moving chain.

⚠ WARNING: Cutting edges on chain are sharp. Use protective gloves when handling chain.

Keep chain sharp. Your Pole Saw will cut faster and more safely. A dull chain will cause undue sprocket, guide bar, chain, and motor wear. If you must force chain into wood and cutting creates only sawdust with few large chips, chain is dull.

Items Needed to Sharpen Chain

Purchase these items from your local dealer, hardware store, or chain saw supplies outlet.

- 5/32" round file
- Depth gauge tool
- File guide
- Vise
- Medium sized flat file

Sharpening Cutters

Use file guide for 30° filing.

1. Adjust chain for proper tension (see *Saw Chain Tension Adjustment*).
2. Clamp guide bar in vise to hold Pole Saw steady. **Note:** Do not clamp chain.
3. Press 5/32" round file (attached to file guide) into groove between top plate and depth gauge on chain. File guide should rest on both top plate and depth gauge (see Figure 14). **Note:** File at midpoint of guide bar.

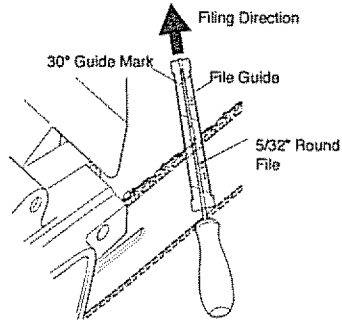

Note: This illustration shows file guide placement and filing direction for sharpening cutters on left side of chain.

Figure 14 - File and File Guide Placement On Chain

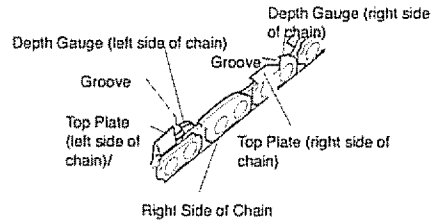

Figure 15 - Chain Part Locations

4. Hold file guide level. Make sure 30° mark on file guide is parallel to center of guide bar (see Figure 14). This will insure that you file cutters at 30° angle.
5. File from inside towards outside of cutter until sharp. Only file in this one direction (see Figure 14). **Note:** Two or three strokes with file should sharpen cutter.
6. After each cutter is sharpened, move chain forward to sharpen next cutter. File all cutters on one side of chain.
7. Move to other side of chain and repeat process.

Filing Cutter Depth Gauges

The cutter depth gauge clearance is reduced as cutters are sharpened. After every second or third sharpening, reset cutter depth gauges.

1. Place depth gauge tool (.025") firmly across top of two cutters. Make sure depth gauge enters slot in depth gauge tool (see Figure 16).
2. Use medium flat file. File depth gauge level with depth gauge tool.
3. Remove depth gauge tool. With flat file, round off front corner of cutter depth gauge (see Figure 17).

After several hand filings, have authorized service center or sharpening service machine sharpen chain. This will insure even filing.

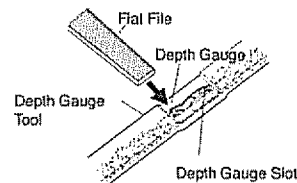

Figure 16 - Depth Gauge Tool On Chain



Figure 17 - Round Off Front Corner Of Depth Gauge

SHARPEN

REPLACING SAW CHAIN

Replace chain when cutters are too worn to sharpen or when chain breaks. Only use replacement chain noted in this manual. Always include new drive sprocket when replacing chain. This will maintain proper driving of chain. **Note:** For proper chain and drive sprocket, see *Illustrated Parts List*.

STORAGE

If storing Pole Saw for more than 30 days, follow steps below.

1. Remove and clean guide bar and chain. Clean guide bar and chain by soaking in petroleum based solvent or mild soap and water mixture.
2. Dry guide bar and chain.
3. Place chain in container filled with oil. This will prevent rust.
4. Wipe a thin coating of oil over surface of guide bar.
5. Wipe off outside of Pole Saw body. Do this with soft cloth dampened with a mild soap and water mixture.
6. Store Pole Saw
 - in a high or locked place, out of children's reach
 - in a dry place
 - with scabbard over guide bar

TECHNICAL SERVICE

You may have further questions about assembling, operating, or maintaining this product. If so, you can visit our Technical Service web site at www.remingtonpowertools.com or contact our Technical Service Department at 1-800-626-2237 (English Only). You may also write to:

DESA Power Tools
P.O. Box 90004
Bowling Green, KY 42102-9004
ATTN: Technical Service

When contacting DESA Power Tools, have ready

- Your Name
- Your Address
- Your Phone Number
- Model Number of Product
- Date of Purchase (Include copy of receipt for written requests)

We reserve the right to amend these specifications at any time without notice. The only warranty applicable is our standard written warranty. We make no other warranty expressed or implied.

REPLACEMENT PARTS AND ACCESSORIES



WARNING: Use only replacement parts and accessories described in this manual. Use of other parts or accessories could damage saw or injure operator.

For original replacement parts and accessories, contact your nearest Authorized Dealer or Authorized Service Center for this product. If they can not supply the part or accessory, contact your nearest Parts Central listed on page 47. Each Authorized Dealer, Authorized Service Center, and Parts Central is independently owned and operated.

See page 46 for an *Illustrated Parts List*.

If you need additional referral information, contact our Technical Service Department (see *Technical Service*).

In Canada call 1-800-561-3372 for parts information.

REPAIR SERVICE

Note: Only use original replacement parts. This will protect your warranty coverage for parts replaced under warranty.

Each Authorized Service Center is independently owned and operated.

Warranty service

If product requires warranty service, return it to nearest Authorized Service Center. You must show proof of purchase. If faulty materials or workmanship caused damage, we will repair or replace product without charge. **Note:** Normal wear, misuse, abuse, neglect, or accidental damage is not covered under warranty.

Non-warranty service

If product requires service, return it to nearest Authorized Service Center. Repairs will be billed to you at regular repair list prices.

For additional Service Center or warranty information, call 1-800-626-2237 or visit our Technical Service web site at www.remingtonpowertools.com.

WARRANTY INFORMATION

REMINGTON BRAND ELECTRIC CHAIN SAW LIMITED WARRANTIES

NEW-PRODUCTS

Standard Warranty

DESA Power Tools warrants this new product and any parts thereof to be free from defects in material and workmanship for a period of one (1) year from the date of first purchase from an authorized dealer provided the product has been maintained and operated in accordance with DESA Power Tools' warnings and instructions

FACTORY-RECONDITIONED-PRODUCTS

Limited Warranty

DESA Power Tools warrants factory reconditioned products and any parts thereof to be free from defects in material and workmanship for 90 days from the date of first purchase from an authorized dealer provided the product has been installed, maintained and operated in accordance with DESA Power Tools' warnings and instructions

TERMS COMMON TO ALL WARRANTIES

The following terms apply to all of the above warranties:

- Always specify model number when contacting the manufacturer. To make a claim under this warranty the bill of sale or other proof of purchase must be presented.
- This warranty is extended only to the original retail purchaser when purchased from an authorized dealer.
- This warranty covers the cost of part(s) required to restore this product to proper operating condition and an allowance for labor when provided by a DESA Power Tools Authorized Service Center. Warranty parts must be obtained through authorized dealers of this product and/or DESA Power Tools who will provide original factory replacement parts. Failure to use original factory replacement parts voids this warranty.
- Travel, handling, transportation, diagnostic, material, labor and incidental costs associated with warranty repairs, unless expressly covered by this warranty, are not reimbursable under this warranty and are the responsibility of the owner.
- Excluded from this warranty are products or parts that fail or become damaged due to misuse, accidents, lack of proper maintenance, tampering, or alterations.
- Excluded from this warranty are products purchased for commercial, industrial or rental usage.
- This is DESA Power Tools' exclusive warranty, and to the full extent allowed by law; this express warranty excludes any and all other warranties, express or implied, written or verbal and limits the duration of any and all implied warranties, including warranties of merchantability and fitness for a particular purpose to one (1) year on new products and 90 days on factory reconditioned products from the date of first purchase. DESA Power Tools makes no other warranties regarding this product.
- DESA Power Tools' liability is limited to the purchase price of the product, and DESA Power Tools shall not be liable for any other damages whatsoever under any circumstances including indirect, incidental, or consequential damages.
- Some states do not allow limitations on how long an implied warranty lasts or the exclusion or limitation of incidental or consequential damages, so the above limitation or exclusion may not apply to you.
- This warranty gives you specific legal rights, and you may also have other rights which vary from state to state.

For information about this warranty contact:

Model _____

Date Purchased _____



Bowling Green, KY 42102-9004
800-626-2237 (English Only)
www.remingtonpowertools.com



Industries of Canada, Inc.
82 Akron Road
Toronto, Ontario
M8W1T2
416-255-5333
Fax: 416-255-5677
www.remingtonpowertools.com

ENGLISH