

Mantis.

Tiller/Cultivator

OWNER'S MANUAL



WELCOME TO THE WORLD OF MANTIS GARDENING!

Here's your new MANTIS Tiller... the lightweight wonder that "Makes Gardening Easier."

Unlike big tillers, your MANTIS Tiller weighs only 20 pounds. So it lifts easily, handles smoothly, tills and weeds precisely. And, unlike other small tillers, it features serpentine tines that churn soil up to ten inches deep. It creates a soft, smooth seed bed, even in problem soil.

Once you know how to use your tiller correctly, we guarantee you'll love it. So first, please read this manual. It shows, step by step, how to use your tiller safely. Plus, it shows how the MANTIS Border Edger can make light work of your edging needs.

If you have questions about any topic in this Manual, or if you wish to order MANTIS Attachments, contact your local authorized MANTIS dealer.



TABLE OF CONTENTS

Safety Rules & Warnings	3-4
Safety Decals	3
Engine & Fuel Warnings	4
Assembly and Mixing Fuel	5-7
Starting	7-8
Additional Information	8
What to Do Just in Case	8
Getting to Your Garden	9
Tilling & Cultivating	9-10
Tine Positioning	10
Cultivating	10

Maintenance	11-12
Storage	13
Trouble Shooting & Specifications	14-15
Service Maintenance Guide	15
Using The Border/Edger Attachment	16
MANTIS Tiller Assembly Layout	17
Engine Parts Assemblies	17-18
EPA Phase 2/California Tier III Emission Control Warranty Statement	19
Limited Warranty Information	20

SAFETY RULES & WARNINGS

You will notice throughout this Owners Manual **Safety Rules and Important Notes**. Make sure you understand and obey these warnings for your own protection.

I. Special Safety Information

⚠ WARNING • DANGER ⚠
ATTENTION: THIS SYMBOL POINTS OUT OUR IMPORTANT SAFETY INSTRUCTIONS.

WHEN YOU SEE THIS SYMBOL, ⚠ HEED IT'S WARNING!! STAY ALERT!!

⚠ WARNING • DANGER ⚠
TO REDUCE THE POTENTIAL FOR ACCIDENTS, COMPLY WITH THE SAFETY INSTRUCTIONS IN THIS MANUAL.

FAILURE TO COMPLY MAY RESULT IN SERIOUS PERSONAL INJURY, AND/OR EQUIPMENT AND PROPERTY DAMAGE.

II. Safety & Warnings

⚠ WARNING • DANGER ⚠
IMPROPER USE OR CARE OF THIS TILLER OR FAILURE TO WEAR PROPER PROTECTION CAN RESULT IN SERIOUS INJURY.

READ AND UNDERSTAND THE RULES FOR SAFE OPERATION AND ALL INSTRUCTIONS IN THIS MANUAL.

WEAR HEARING AND EYE PROTECTION.

⚠ WARNING

The Engine Exhaust from this product contains chemicals known to the State of California to cause cancer, birth defects or other reproductive harm.

PRODUCT EMISSION DURABILITY

The 300 hour emission durability compliance period is the time span selected by the manufacturer certifying the engine emissions output meets applicable emissions regulations, provided that approved maintenance procedures are followed as listed in the Maintenance Section of this manual

III. Safety Decal Information

An important part of the safety system incorporated in this tiller are the warning and information decals found on various parts of the tiller. These decals must be replaced in time due to abrasion, etc. It is your responsibility to replace these decals when they become hard to read. The location and part numbers (P/N) of these decals are illustrated on Page 27.

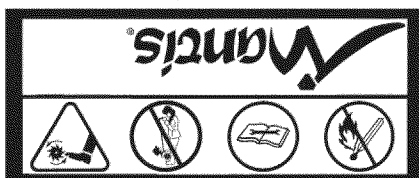

P/N 400620

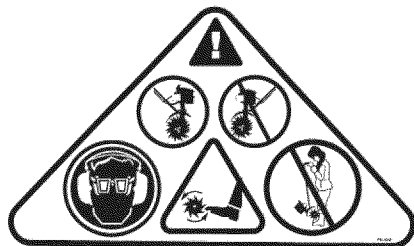

P/N 4043

IMPORTANT ENGINE INFORMATION
 ENGINE FAMILY: 4EHXS.0214KI DISPLACEMENT: 21.2cc
 EMISSION COMPLIANCE PERIOD: 300 HOURS
 THIS ENGINE MEETS U.S. EPA PH2 AND 2005 - 2006 CALIFORNIA EMISSION REGULATIONS FOR SORES. REFER TO OWNER'S MANUAL FOR MAINTENANCE SPECIFICATIONS AND ADJUSTMENTS.



EMISSION CONTROL --
 The emission control system for this engine is EM (Engine Modification).

Emission Control Label located on Engine.
 EXAMPLE ONLY, information on label varies by FAMILY).



CUTTING HAZARD; KEEP FEET AND HANDS AWAY FROM ROTATING TINES.



DO NOT CARRY THE TILLER IN THIS POSITION.



READ OWNER'S MANUAL BEFORE USING TILLER, OR PERFORMING ANY REPAIR OR MAINTENANCE. KEEP OWNERS MANUAL IN A SAFE PLACE.



DON'T FUEL, REFUEL, OR CHECK FUEL WHILE SMOKING, OR NEAR AN OPEN FLAME OR OTHER IGNITION SOURCE.



CAUTION: WHEN ASSEMBLING THE HANDLES, MAKE SURE FUEL TANK FACES OPERATOR. THIS IS THE REAR OF THE TILLER, REFER TO ASSEMBLY INSTRUCTION ON PAGE 7.



INCORRECT ASSEMBLY.



WEAR EAR AND EYE PROTECTION.

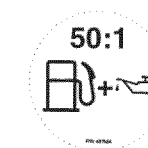

MIX UNLEADED GAS WITH 2 CYCLE 50:1 OIL.

⚠ WARNING • DANGER ⚠
IF THE TILLER IS USED IMPROPERLY OR SAFETY PRECAUTIONS ARE NOT FOLLOWED, THE USERS RISK SERIOUS INJURY TO THEMSELVES AND OTHERS. READ AND UNDERSTAND THIS MANUAL BEFORE ATTEMPTING TO OPERATE THIS TILLER.

IV. Warnings - Do's

Read and understand the owner's manual. Pay particular attention to all sections regarding safety.

1. **Always** keep a firm grip on both handles while the tines are moving and/or the engine is running. BE AWARE!! The tines may coast after throttle trigger is released. Make sure tines have come to a complete stop and engine is off before letting go of the tiller.

2. **Always** maintain a firm footing and good balance. Do not overreach while operating the tiller. Before you start to use the tiller check the work area for obstacles that might cause you to lose your footing, balance or control of the machine.

3. **Thoroughly** inspect the area where equipment is to be used and remove all objects, which can be thrown by the machine.

4. **Always** keep area clear of children, pets, and bystanders.

5. **Always** stay alert. Watch what you

are doing and use common sense. Do not operate unit when fatigued.

6. **Always** dress properly. Do not wear loose clothing or jewelry, they might get caught in moving parts. Use sturdy gloves. Gloves reduce the transmission of vibration to your hands. Prolonged exposure to vibration can cause numbness and other ailments.

7. **While working**, always wear substantial footwear and long trousers. Do not operate the equipment when barefoot or wearing open sandals.

8. **Always** wear ear and eye protection. Eye protection must meet ANSI Z 87.1. To avoid hearing damage, we recommend hearing protection be worn whenever using the equipment.

9. **To reduce fire hazard**, keep the engine, and petrol/gas storage area free of vegetative material and excessive grease.

10. **Start** the engine carefully, according to the manufacturer's instructions and with feet well away from tool(s).

11. **Keep** all nuts, bolts and screws tight

to be sure the equipment is in safe working condition.

12. **Use extreme caution** when reversing or pulling the machine towards you.

13. **Work only** in daylight or good artificial light.

14. **Always** be sure of your footing on slopes.

15. **Exercise** extreme caution when changing direction on slopes.

16. **Always** keep a safe distance between two or more people when working together.

17. **Always** inspect your unit before each use and ensure that all handles, guards and fasteners are secure, operating, and in place.

18. **Always** maintain and examine your Tiller with care. Follow maintenance instructions given in manual.

19. **Always** store tiller in a sheltered area (a dry place), not accessible to children. The tiller as well as fuel should not be stored in a house.

V. Warnings - Don'ts

Don't use tiller with one hand. Keep both hands on handles with fingers and thumbs encircling the handles, while tines are moving, and engine is running.

Don't overreach. Keep a good footing at all times.

Don't run with the machine, walk.

Don't work on excessively steep slopes.

Don't attempt to clear tines while they are moving. Never try to remove jammed material before switching the engine off and making sure the tines have stopped completely.

Don't allow children or incapable people to operate this tiller.

Don't operate while under the influence of alcohol or drugs.

Don't attempt to repair this tiller. Have repairs made by a qualified dealer or repairman. See that only original MANTIS parts are used.

▲ WARNING • DANGER ▲

HANDLE FUEL WITH CARE, IT IS HIGHLY FLAMMABLE. FUELING A HOT ENGINE OR NEAR AN IGNITION SOURCE CAN CAUSE A FIRE AND RESULT IN SERIOUS PERSONAL INJURY AND/OR PROPERTY DAMAGE.

VI. Engine/Fuel Warnings - Do's

Always use fresh gasoline in the fuel mixture. Stale gasoline can cause damage.

Always store fuel in containers specifically designed for this purpose.

Always pull starter cord slowly until resistance is felt. Then pull cord rapidly to avoid kickback and prevent arm or hand injury.

Always operate engine with spark arrestor installed and operating properly. The use of spark arrestor mufflers is required by law in the state of California (Section 4442 of the California Public Resources Code), as well as in other states or municipalities. Federal laws apply on federal lands.

Stop the engine whenever you leave the machine.

Allow the engine to cool before storing in any enclosure.

If the fuel tank needs to be drained, this should be done outdoors.

VII. Engine/Fuel Warnings - Don'ts

Don't fuel, refuel or check fuel while smoking, or near an open flame or other ignition source. Stop engine and be sure it is cool before refueling.

Don't leave the engine running while the tiller is unattended. Stop engine before putting the tiller down or while transporting from one place to another.

Don't refuel, start or run this tiller indoors or in an improperly ventilated area.

Don't run engine when electrical system

causes spark outside the cylinder. During periodical checks of the spark plug, keep plug a safe distance from cylinder to avoid burning of evaporated fuel from cylinder.

Don't check for spark with spark plug or plug wire removed. Use an approved tester.

Don't crank engine with spark plug removed unless spark plug wire is disconnected. Sparks can ignite fumes.

Don't run engine when the odor of gasoline is present or other explosive conditions exist.

Don't operate the unit if gasoline is spilled. Clean up spill completely before starting engine.

Don't operate your tiller if there is an accumulation of debris around the muffler, and cooling fins.

Don't touch hot mufflers, cylinders or cooling fins as contact may cause serious burns.

Don't change the engine governor setting or over speed the engine.

ASSEMBLY

⚠ WARNING • DANGER ⚠

IMPROPER ASSEMBLY OF THIS TILLER CAN RESULT IN SERIOUS INJURY. MAKE SURE TO FOLLOW ALL INSTRUCTIONS CAREFULLY.

IF YOU HAVE ANY QUESTIONS, CONTACT YOUR LOCAL AUTHORIZED MANTIS DEALER

Your MANTIS Tiller comes partially assembled. You must install only the handlebars, the carrying handle, and the tines. This will take just a few minutes if you follow the directions.

First, take all items out of the carton. But do not remove the cardboard from around the Tiller's base.

The list at the right, shows the parts that come with your tiller. Check to make sure you have them.

The bag of hardware is in the plastic bag containing the Owner's Manual and Video.

To assemble your MANTIS Tiller, you'll need two 7/16" wrenches or two adjustable wrenches. We suggest that you install all nuts and bolts only "finger tight" — that is, one-half to one full turn — until you've completed assembly. **The nuts are self locking, but you must use a wrench to tighten them completely.**

HOW TO ASSEMBLE LOWER HANDLES

To identify part numbers, see pages 6 and 27.

1. Use the protective cardboard sleeve to stabilize your tiller. Stand the engine assembly (#8) up.

2. Lay the handle parts within easy reach. You'll need one of the handle clamps (#38) and one of the lower handles (#3). Note that the lower handles have a short leg on one end. (Picture 1)

3. Fit the handle clamp along the outside of the short leg. Line up the holes on the clamp and the leg.

4. Choose one of the two 3-inch bolts (#36). Slide it through the first set of holes — near the elbow where the lower handle curves. (Picture 2)

5. Now slide the other lower handle onto the 3-inch bolt. (Picture 3.) Fit the other clamp onto this other handle's short leg. Add a nut and tighten finger tight.

6. Locate the worm gear housing. It starts just above — and extends down through — the tiller's red fender guard. You'll notice that there's a recessed channel on either side of the housing's top. (Picture 4.)

7. Take the lower handles that you've just put together. Slide them into the two recessed channels.

⚠ Make sure you insert them from the rear of the tiller (gasoline tank faces the operator)... so that the bolt fits along the back of the housing. (Picture 5)

8. Slide the second 3-inch bolt through the second set of holes in the short legs. Add a nut and tighten finger tight.

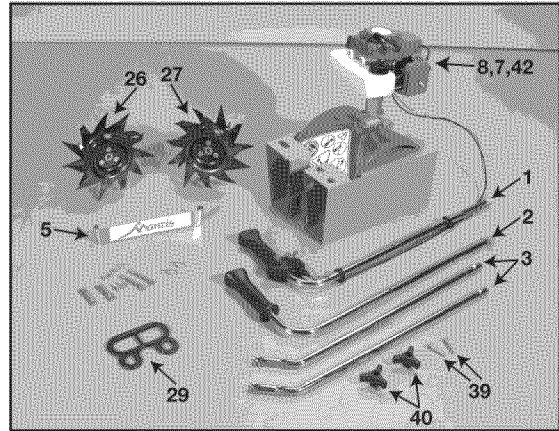

Quantity	Description	*Key #
1	Upper Handle Assembly	2
1	Upper Handle Throttle Side Assembly	1
2	Lower Handles	3
1	Pair Tiller/Cultivator Tines	26/27
1	Engine Assembly (includes Fender Guard & Worm Gear Transmission)	8, 7, 42
1	Handle Brace	5
1	Plastic Carrying Handle	29
1	Bag of Hardware Containing:	
2	Cap Screws	34*
4	Lock Nuts	35
2	Bolts (3" long)	36
2	Tine Retaining Pins	28
2	Handle Clamps	38
1	Throttle Clips	6
2	Bolts	39
2	Knobs	40

*These numbers are the same numbers shown on the Parts Layout on page 16.

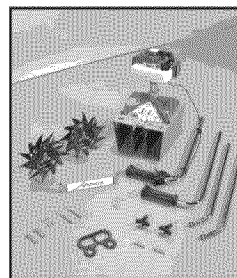

Picture 1

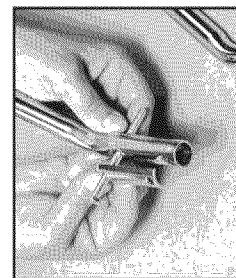

Picture 2

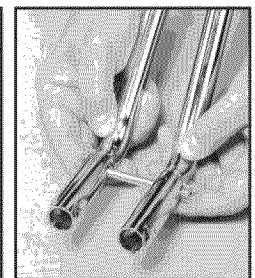

Picture 3

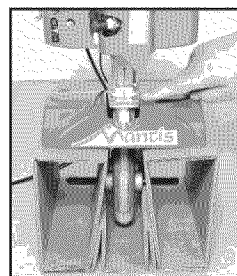

Picture 4

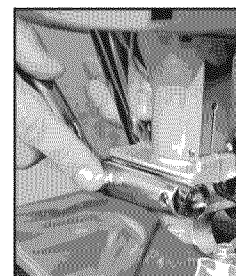

Picture 5

NOTE: THE LOCK NUTS ARE STAMPED. FINGER TIGHT IS APPROXIMATELY 1/2 TO 1-1/2 TURNS.

ASSEMBLY (continued)

HOW TO ASSEMBLE UPPER HANDLES & PLASTIC CARRYING HANDLE.

1. Lightly squeeze the lower handles (#3) toward one another so that they line up with the two smaller holes on the carrying handle (#29). Then slide the carrying handle over and down the lower handles. It will rest about four to six inches above the engine. (Picture 1)

2. Gently pull the lower handles out to their original position.

3. Attach the upper handle assembly (#1) – the handle with the throttle cable and ground wire – onto the right handle, and secure with the handle knob (#40) and 1 round head bolt (#39) (Picture 2). **Be sure you have proper throttle movements and that the throttle cable is not wrapped or twisted around the handle bar.** Squeeze trigger and let go. The triangle must click in both directions. If there is any doubt, remove air filter and

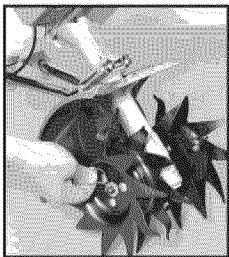

Assembling the Tines for Tilling

1. Remove the cardboard from around your Tiller's base.

2. Slide the tines onto the axle shafts. The "D" hole goes on the outside.

3. Make sure you've installed the tines properly for tilling. Liken the tines to your fingers. When your palm faces the ground, your fingers curl down. Stand behind the Tiller and hold your hand next to the tines. Do the tine blades curl down, as your fingers do? If so, they are in the *tilling* position. (To switch to the cultivating position, see page 10.)

4. To secure each tine to the axle, insert a tine retaining pin.

IMPORTANT NOTE:

Before you use your MANTIS Tiller, read the Safety Rules & Warnings on pages 3-4.

visually check that the throttle triangle hits both the idle screw and the full open stop. **THIS MUST BE DONE BEFORE STARTING THE ENGINE.**

4. Follow the same steps to install the left upper handle onto the other lower handle. (Picture 3)

5. Use the clip (#6) to secure the throttle cable and wire in place on the lower handle. (Picture 4)

6. Now install the Handle Brace. Line it up with the holes on the upper handles. Then insert a Cap Screw (#34) and a Lock Nut (#35) on either side (Picture 5)

7. Use a wrench to tighten Cap Screws and Lock Nuts.

8. Now use wrench to tighten all nuts and bolts firmly and securely.

IMPORTANT NOTE:

Make sure you have installed the handles properly. When you stand behind your tiller, holding the handles, you should face the gasoline tank.

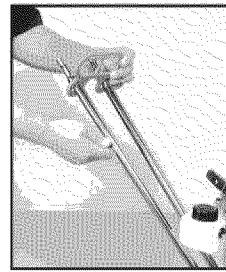

Picture 1

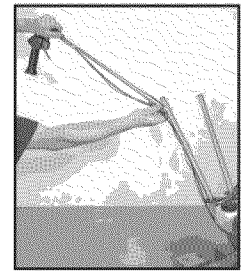

Picture 2



Picture 3

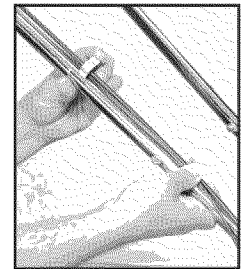

Picture 4

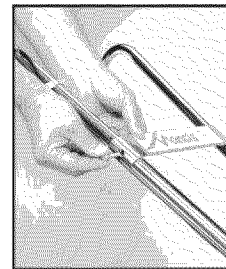

Picture 5



Your MANTIS Tiller comes with a free pre-measured bottle of two-cycle engine oil. Here's how to mix the oil with the gas:

1. Pour 1/2 of the gasoline into a safe container. Do not mix the fuel and oil in the engine fuel tank.

2. Add 2.6 ounces of two-cycle engine oil to the gasoline and mix. Then add the rest of the gasoline.

3. Screw the cap onto the gasoline can. Then swirl the can to blend the oil and gas.

4. Carefully pour the fuel mix into the tiller's fuel tank. After putting the fuel tank's cap back on, wipe up any spilled fuel from tank and gasoline can.

IMPORTANT:

Two stroke fuel separates and ages. Do not mix more than you will use in a month. Using old fuel can cause difficult starting or engine damage. Shake fuel container to thoroughly mix fuel before each use. Do not attempt to run your engine on gasoline only, use

proper fuel mixture.

Need more pre-measured engine oil? You can order it from your local authorized MANTIS dealer.

Remember ...

- Always mix two-cycle oil with gasoline before fueling your tiller. Never, ever run your tiller on gasoline alone. This will ruin your engine and void all warranties.
- Always use a clean gas can and always use unleaded gas.
- Never try to mix the oil and gasoline in the engine fuel tank.
- Always mix oil and gas in the proper proportions: 2.6 ounces of two-cycle engine oil to one gallon of unleaded gasoline.

IMPORTANT NOTE:

Do Not use old or stale oil/gasoline mixture. Always use the proper oil/gasoline mixture. If you do not, your engine will suffer rapid, permanent damage. And you will void the engine warranty.

ASSEMBLY (continued)

WARNING • DANGER
FUEL IS EXTREMELY FLAMMABLE. HANDLE IT WITH CARE. KEEP AWAY FROM IGNITION SOURCES. DO NOT SMOKE WHILE FUELING YOUR EQUIPMENT.

Mixing Fuel

Your MANTIS Tiller is powered by a commercial two stroke, air cooled engine which requires a fuel mixture of gasoline and lubricating oil.

Use a mixture of 50 parts unleaded regular gasoline and 1 part two-stroke MANTIS oil (50:1.) Use branded 89 octane (R+M+2) unleaded gasoline or gasohol (maximum 10% ethyl alcohol, or 15% MTBE, no methyl alcohol.)

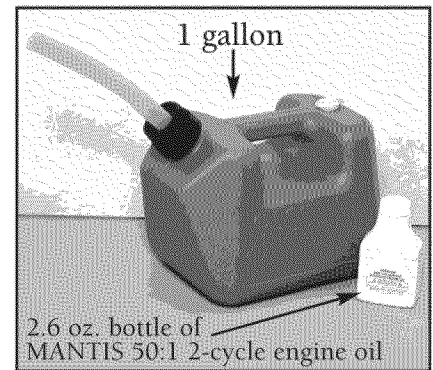

STARTING

To Start Your Tiller for the First Time:

1. Fill the fuel tank with the proper oil/gasoline mixture. (See previous section.)
2. Hand tighten the gasoline cap just until it's snug.
3. Place the **o/i** switch into the "start/on" position. (Picture 1)
4. Pull the choke button all the way out, to completely close the choke. (Picture 2)
5. Locate the **purge bulb** on the upper right of the engine, in front of the fuel tank. (See Picture 3) It sends fuel into the carburetor, for easy

starting. Press the **purge bulb** until you see fuel flow through the **clear fuel return line**. Since you're starting "cold," you may need to press six to eight times. As soon as fuel starts flowing through the clear fuel line, stop pressing! (Picture 3)

6. **Don't** press the throttle trigger during the starting of the engine.
7. Pull the starter cord (Picture 4) until resistance is felt. Then give the recoil starter cord a few brisk pulls until the engine **fires**. Note: Pull the starter cord about 12" to 18". **During cold starting**, you may need to pull at least three or four times before the engine fires.

NOTE: When the choke is closed, never pull the cord more than four or

five times. Overpulling may cause flooding. Also, bear in mind that, when the engine **fires, it only coughs or sputters, and will not run on choke.**

8. Push the choke button in, all the way, to open the choke. (Picture 5)

9. Then pull the starter cord again. The engine should start and run. Let the engine warm up two to three minutes before using.

Follow these steps whenever you are starting the engine "cold", or when the engine has run dry and you have just added fuel. Remember, always use short, brisk pulls. Don't give the cord a long, forceful yank. And, do not let the cord snap back into the starter housing.

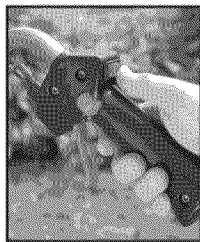
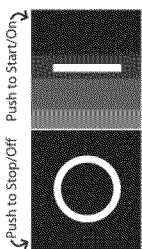

Picture 1

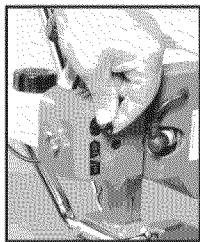

Picture 2

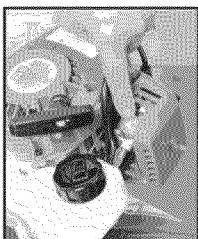

Picture 3

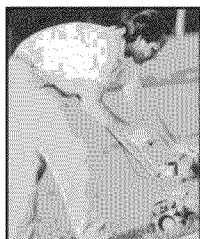

Picture 4

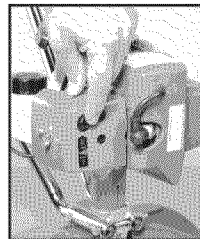

Picture 5

Never use starting fluids as they will cause permanent engine damage. Using them will void the warranty. Before you use the tiller, read the Safety & Warning rules on pages 3-4.

Starting a Warm Engine

1. Push ignition switch to "start/on" position.
2. Push choke button in to the RUN (open) position.
3. If there is no fuel in the clear return line, push primer bulb 3-4 times or until fuel is visible in the line.
4. Pull starter rope using short pulls, 1/2 to 2/3 of the rope length.
5. If engine fails to start in 4

pulls, use "First Time" starting procedure on page this page.

6. With engine running, and both hands on the handles, press the throttle lock out button (Picture 1), then squeeze the throttle trigger gradually to increase the engine speed and engage the tines.

NOTE: Once the throttle trigger is squeezed, you can release the lockout button (Picture 2).

NOTE: Step #6 must be repeated each time your tiller trigger is released.



Picture 1



Picture 2

WARNING
AVOID ACCIDENTAL BLADE ENGAGEMENT
DO NOT SQUEEZE THE THROTTLE TRIGGER WHEN STARTING.
MAINTAIN PROPER IDLE SPEED ADJUSTMENT (2500-3100 RPM)

STARTING (continued)

Additional Information

How to Stop the Engine

Simply push the **o/i** “stop/start” switch to “**o**” (Picture 3). This will stop the engine instantly. If it should ever fail to do so, just pull out the choke button. The engine will stop at once.



Picture 3

About the Choke

The choke controls the amount of air drawn into the engine. Your tiller will run only if the choke is open — that is, if the choke is pushed in.

A Special Feature (with the idle set properly and the engine running)

Even when the engine is running, the tines won't turn unless you press the throttle lock out button and squeeze the throttle lever on the handlebars. And, when you release the throttle lever, the tines will stop.

A Tip for Extending Your Engine's Life

After you start the engine, let your tiller warm up for two to three minutes before you use it. Then, before you put

your tiller away, let it idle for a minute to give the engine a chance to cool down.

WARNING

▲ DANGER ▲

IF ENGINE DOES NOT STOP WHEN SWITCH IS PUT IN THE STOP POSITION, RELEASE THE THROTTLE, ALLOW ENGINE TO IDLE. PUT THE TILLER DOWN, AND PULL THE CHOKE BUTTON OUT TO COLD START (CLOSED) POSITION. CHECK AND RETURN IGNITION SWITCH TO ON POSITION BEFORE STARTING ENGINE AGAIN.

WHAT TO DO JUST IN CASE

If you follow the normal starting procedure, you should have no problem starting your tiller. But, just in case you do have problems, here's what to do.

Make sure the **o/i** switch is on **1** “start.” You'd be surprised how many people forget to push the switch into the “**1**” position.

If the switch was on “**o**” when you pulled the cord, you may have flooded the engine.

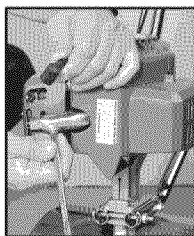

Picture 1



Picture 2

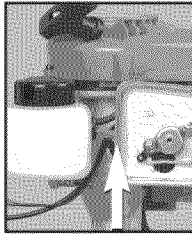

Picture 3

disconnect spark plug wire and remove plug. Use a paper towel or a clean rag to dry the spark plug, then, with the spark plug out of the engine, pull the starter cord several times. Next, replace the spark plug.

Use the wrench to tighten it and replace the cap. Next, put the switch in the “**1**” position and pull the choke button out. Pull the starter cord three or four times until the engine coughs or sputters. Open the choke (push the choke button in) and pull the cord a few times. The engine should start and run.

2. If the end of the spark plug is dry, check to see if the fuel line is blocked. First loosen the fuel cap to relieve the pressure in the tank. The fuel line runs from the fuel tank to the carburetor. Pull it off at the carburetor end. Fuel should drip slowly from the line. Wipe off any excess or spilled fuel.

If fuel does not drip from the line, check the line for any bends or pinches. (Picture 3). Kinks in the line restrict the flow of fuel to the engine. Just straighten out the line. Reconnect. Then follow the normal starting procedure.

If fuel drips too freely, the line may be disconnected from the fuel filter. You'll find the fuel filter inside the fuel tank. Just re-attach the line to the filter, and put

the filter back in the tank. Then follow the normal starting procedure.

Here's Another Way to Start your MANTIS Tiller

If you follow the steps above and your engine still won't start, try this:

1. Push the switch to “**1**”.
2. Push in the choke button to open the choke.
3. Press the plastic bubble a few times.
4. Give the starter cord a few short, quick pulls. The engine should start and run.
5. If the engine does not start, then pull out the choke button to close the choke. Pull the starter cord four to five times. The engine should sputter or cough.
6. After the engine sputters, push the choke button in. Then pull the starter cord. The engine should start and run.
7. If the engine still does not start, repeat steps 2 through 6.

8. If the engine still does not start, call your local authorized MANTIS dealer.

IMPORTANT NOTE:

Never use starting fluids. Starting fluids will cause permanent engine damage. Using them will void the warranty.

IMPORTANT NOTE:

Before you use your MANTIS Tiller, read the Safety Rules & Warnings on pages 3-4.

▲ WARNING ▲

MAKE SURE THE START/STOP SWITCH IS IN THE STOP POSITION. KEEP PLUG WIRE AWAY FROM ENGINE TO AVOID UNINTENTIONAL SPARK.

- First, examine the spark plug. Use the special wrench that comes with our optional MANTIS Handy Item Kit (Item #8444) or a 3/4 inch spark plug wrench. (Picture 1)
- Remove the cap over the spark plug.
- Unscrew the spark plug. (Picture 2)

IMPORTANT NOTE:

To avoid possible damage to the threads, do not try to remove the plug from a hot aluminum cylinder head.

Starting a Flooded Engine

1. If the end of the spark plug is wet, the engine may be flooded. **Make sure the switch is in the “o” position,**

GETTING YOUR TILLER TO YOUR GARDEN

Walk it.

Once your tiller is running, you can “walk” it to your garden. Just press the throttle lock out button and squeeze the throttle lever gently and let the tiller “tip-toe” across your yard on its tines. It won’t hurt your lawn or driveway.

Carry It.

Make sure the engine is off. Then use one hand to grasp the convenient carrying handle. Use the other hand to hold the handlebars. (Picture 1) Then lift your tiller and carry it to your garden. Since it weighs only 20 pounds, it won’t strain your muscles or tire you out!

Take It for a Ride.

You can easily transport your MANTIS Tiller to a friend’s or relative’s house. Just empty the fuel tank. (This is crucial.) Then stow your Tiller in the trunk of your car or truck. It fits easily. And you can put it in and take it out without straining your back.

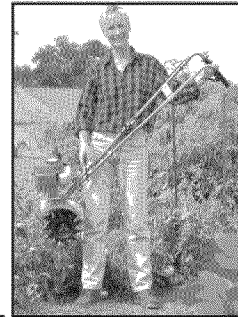

Picture 1



Picture 2

▲ WARNING ▲
NEVER CARRY YOUR TILLER AS THE PERSON IN PICTURE 2 IS DOING. IF YOU DO, YOU WILL SUFFER SERIOUS INJURY.

TILLING

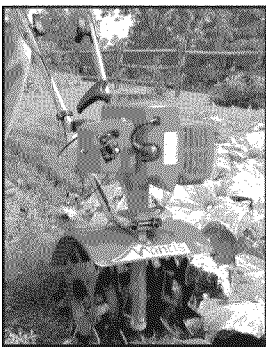

Picture 1

Now You’re Ready to Use Your MANTIS Tiller.

If you’ve seen other tillers, your MANTIS Tiller may surprise you. It tills best when you pull it backward! You see, when you pull your MANTIS Tiller backward, you give extra resistance to the tines, so they dig deeper. (Picture 1)

What’s more when you go backward, you erase your footprints. So your soil stays light and fluffy. With other tillers, by contrast, you walk right over the soil you’ve just tilled, packing it down, so it’s less plantable.

Run Your MANTIS Tiller like a Vacuum Cleaner.

Place your Tiller at the head of the row or area you want to till. Start it up. Then use an easy rocking motion. First, pull your Tiller backward. Then use an easy rocking motion. Again, pull your Tiller backward. Then, let it move forward just a little bit. Then pull it backward again. This will help you till deeper.

Keep repeating these steps until you’ve tilled an entire row. Start again on the next row. It’s much like running a vacuum cleaner! (Picture 2)

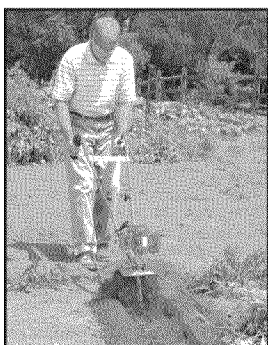

Picture 2



Picture 3

You Can Even Control Depth.

For Deeper Tilling:

Move your Tiller slowly back and forth, as you would a vacuum cleaner. Work the same area over and over until you’ve dug to your desired depth. (Picture 3)

For Shallow Tilling:

Switch the tines to the cultivating position. (See page 10 to learn how.) Then move your Tiller quickly over your soil surface.

For Big Weeds or Tough Roots:

Let your Tiller rock back and forth over the tough spot, until the tines slice through the weed or root.

Your MANTIS Tiller Handles Special Tilling Projects.

Want to turn part of your lawn into a colorful flower border? Your MANTIS Tiller makes it easy! Just run your Tiller back and forth until the sod begins to break up. Then continue tilling. Your Tiller will chop the clumps of sod until they’re fine. Then, it will work them into the soil. Pretty soon, you’ll have a soft, fresh planting bed.

WARNING • DANGER
THE OPERATOR OF THIS TILLER IS RESPONSIBLE FOR ACCIDENTS OR HAZARDS OCCURRING TO HIMSELF, OTHER PEOPLE OR THEIR PROPERTY.

TILLING/CULTIVATING

⚠ WARNING • DANGER ⚠

IF YOUR TINES GET JAMMED OR ENTANGLED, SHUT OFF THE ENGINE AT ONCE. REMOVE THE SPARK PLUG WIRE THEN REMOVE THE OBSTRUCTION WHILE THE ENGINE IS OFF. NEVER TRY TO REMOVE AN OBSTRUCTION WHILE THE ENGINE IS RUNNING. SERIOUS INJURY CAN RESULT.

Your MANTIS Tiller Makes Weeding a Pleasure!

As a tiller, your MANTIS Tiller works the soil down to 10" (25.4 cm) deep. But, as a cultivator, it gently cultivates the surface, only 2" to 3" (5.09 cm to 7.62 cm) deep.

First, you must change the tines to the weeding position. This takes less than a minute.

Then, your MANTIS Tiller's sharp "tine teeth" will slice up those pesky weeds, burying them as you go along. And, since the tines in this position won't dig too deep, they won't hurt your plants' precious root systems.

How about a family-size vegetable garden?

Nowadays many gardeners prefer small gardens — especially in the suburbs, where space is at a premium. But, if you're fortunate enough to own a large lot, you can create a bigger garden — a half acre or more. Here's how:

1. First, hire someone with a

tractor or big tiller to break ground for you. This is a one-time-only investment that's well worth the small cost.

2. Then, use your Tiller to break up any remaining clumps of soil or sod. Unlike a tractor or big tiller, your MANTIS Tiller is a precision tool. It will pulverize your soil into a smooth seed bed.

The result? Your Tiller will cut your weeding time in half, and turn a tiresome chore into a pleasure.

How to Switch From Tilling to Cultivating Position

1. Make sure your Tiller is off.
2. Remove the retaining pins from the tines.
3. Remove the tines from the axle.
4. Place the right-side tine onto the left-side axle. Place the left side tine onto the right-side axle. The "D" hole should be to the outside.
5. Here is how to make sure you've installed the tines properly. Stand behind

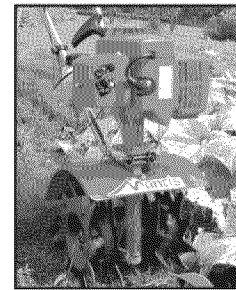

Picture 1

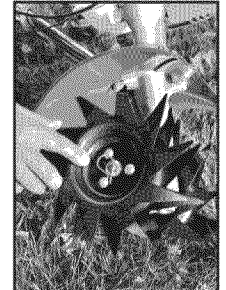

Picture 2

the Tiller and hold your hand, palm up, next to the tines. Do the tine points curl up, as your fingers do? If so, they are in the correct cultivating position.

6. Reinsert the pins.

CULTIVATING

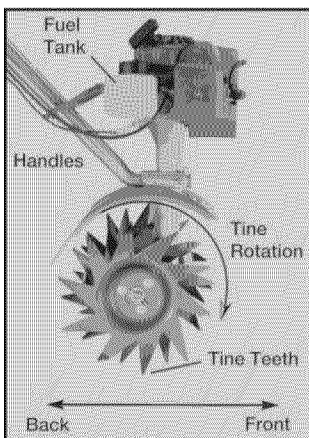

Tilling Position

Tine teeth point in the same direction as the rotation of the tine; or toward the front of the Tiller, away from the operator.

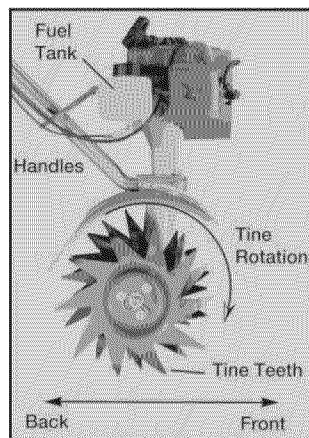

Cultivating Position

Tine teeth point in the opposite direction as the rotation of the tine. Tines point toward the back of the tiller, or toward the operator.

Now You're Ready to Cultivate or Weed.

Guide your Tiller where you want to weed and start it up. Pull your Tiller backward slowly, then let it move forward a bit, in a gentle rocking motion. Watch it slice, shred, and bury those weeds!

Got tough weeds? Lighten your pressure on the throttle to slow your Tiller down. Then work back and forth until your Tiller chops up the weeds. It's easy and effective!

Remember, any tiller will tangle in tall grass, stringy vines, or super-big weeds. So, if you have a "backyard jungle," first use a knife, pruner, or brush cutter to chop up the overgrowth. If the tines become tangled anyway, **push the switch to the "O" position to turn the engine off completely** before trying to clear them.

The optional Tine Detangler (Item #1322) will clear tines in a jiffy. Call your local authorized MANTIS dealer.

Your MANTIS Tiller Will Weed Between Narrow Rows!

Your MANTIS Tiller is a precision weeder that easily fits in tight places. So don't be afraid to weed anywhere: between plants and shrubs; in corners; against fences; on raised beds; in wide rows; even in very narrow rows. Your MANTIS Tiller weeds six* to nine inches wide. So you can run it in a tightly planted garden without damaging your delicate plants. That's good news for suburban gardeners, who often have to plant rows close together!

*With optional Planter Furrow attachment (Item #6222.)

MAINTENANCE

Check the Air Filter Often

A wet or dirty air filter can affect the way your engine starts, performs, and wears. So, it's a good idea to check your air filter once a month.

If you work in dusty soil, or if you want to be on the safe side — then check your filter more often (for instance, before each use). But be sure to replace it at least once a year, in the spring or fall. Clean or change it as needed. It is recommended to change the air filter yearly.

How to Check, Clean and Change the Air Filter

1. Loosen the wing nut on the side

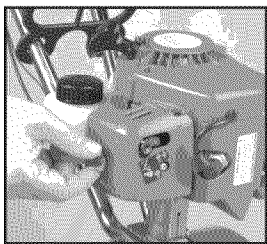

Picture 1

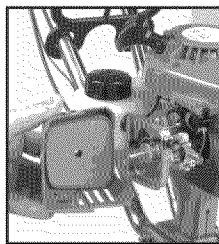

Picture 2

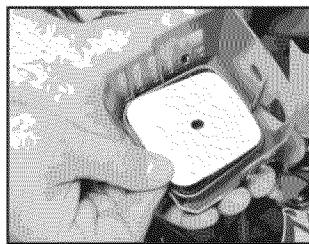

Picture 3

of the air-cleaner cover. (See Picture 1, or look up Key #1 in Air Cleaner Parts Assembly on page 17.)

2. Take off the cover. Make sure to clear the choke button. (Picture 2)

3. The air filter is the pad on the inside of the air-cleaner cover. Check whether it is soiled or moist.

4. If the air filter needs cleaning or no longer fits properly, remove it. Just lift an edge carefully and “peel” it out. (Picture 3)

5. Use a brush to remove debris from the pad.

6. If the air filter is so dirty that it won't come clean, you must replace it or severe engine damage will occur.

Order a new one directly from our Customer Service Dept. Call 1-800-366-6268.

7. Insert your clean filter inside the air-cleaner cover.

IMPORTANT! Make sure filter is “seated” properly in the cover. The filter must fit snugly inside the rim that holds the filter in place.

Installing the filter incorrectly will cause engine damage and void the warranty. Fit the cover back over the air cleaner. (Again, make sure to clear the choke button.)

8. Tighten the wing nut to secure the cover.

Note:

Please check the lip on the Air Cleaner Cover. If the lip is chipped or cracked, it should be replaced. This will prevent dirt from being ingested through the carburetor into the inside of the engine.

How to Check the Grease Level Inside the Worm Gear Housing

When we built your MANTIS Tiller, we lubricated the worm gear housing thoroughly.

It is imperative that you inspect the grease level once a year. Simply remove the cover plate on the worm gear housing. (Picture 1) Then check to make sure the grease comes almost to

the top of the housing. If it doesn't, add lithium #0 grease (Item 9985.) This is the only way to add grease to the worm gear housing. (Picture 2) To purchase MANTIS grease, call your local authorized MANTIS dealer.

Please do not overfill. Too much grease can create pressure, which could cause seals to fail or the clutch to slip.

Fuel Filter Replacement:

Fuel filter to be changed at the end of every season.

Clear Blockages From the Fuel Line & Filter:

After you've used your Tiller for a few seasons, check for blockages in the fuel tank and fuel filter. Such blockages can keep your Tiller from starting.

Clear any blockages you see in the tank, fuel filter, or fuel line. Remember: The fuel filter is located inside the tank. (See Picture 3) Then use the normal starting procedure to start your Tiller.

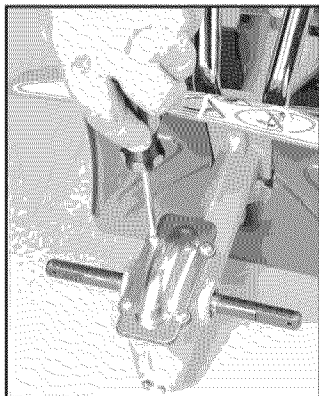

Picture 1

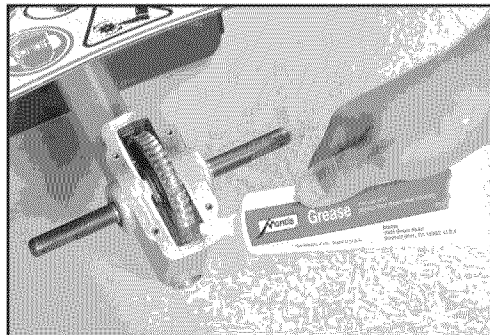

Picture 2

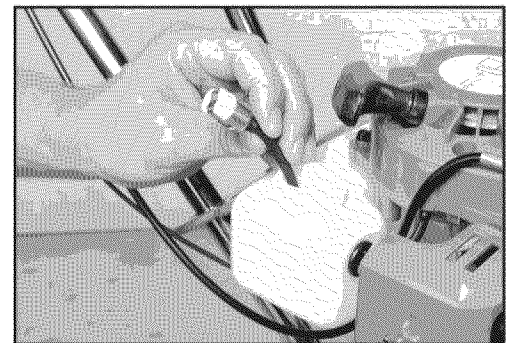

Picture 3

MAINTENANCE (continued)

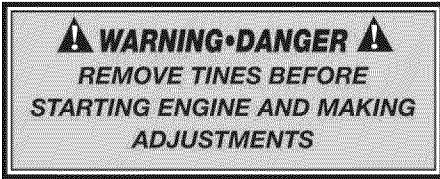

What to Do if Your Engine Idles Too High

What if your engine runs too fast ... or if the tines turn the instant you start the Tiller? You may need to adjust the idle screw (Key #19 under Carburetor on page 17) by itself right below the H and L screws. Gently turn it counter-clockwise. You'll know you've adjusted it correctly when the axles do not turn at low idle.

What to Do if Your Engine Runs "Rough"

If your engine runs "rough" or stalls, you may need to adjust the carburetor and idle screws.

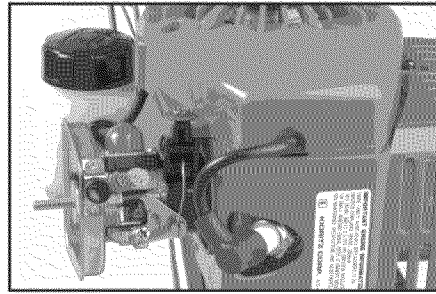

Picture 1

If you remove the air-cleaner cover, you'll see the two carburetor, adjustment screws next to the choke button. (Picture 1)

The "RED" screw is the HIGH-speed adjustment... The "WHITE" screw is the low speed adjustment.

First, remove the tines from the axle. Then start engine. Let it run for two to three minutes. "FLASH" the choke several times during the warm-up to clear any air from the Fuel system.

Then stop the engine after it reaches operating temperature.

Now, turn the RED, high-speed screw counter-clockwise all the way to stop... Then turn the WHITE, low speed screw halfway between the counter-clockwise and clockwise stop positions.

Now restart the engine to finish the carburetor adjustment.

Run the engine at full speed two or three seconds to clear out any excess fuel. Then return to idle.

Now, accelerate the engine to full throttle several times to check for a smooth transition from idle to high speed.

If the engine hesitates turn the WHITE, low-speed screw counter-clockwise one-eighth of a turn. Then accelerate the engine.

Repeat the adjustment until you get a smooth transition to high speed.

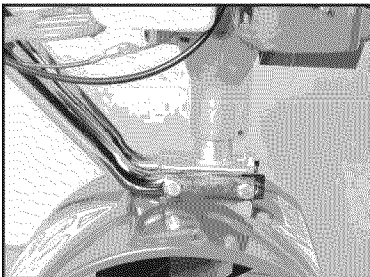

Picture 1 ... Note how the engine doesn't sit all the way down on the transmission.

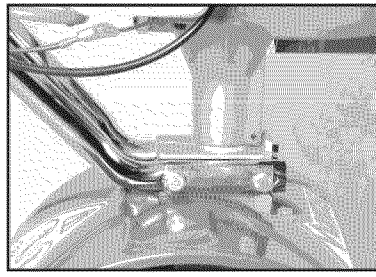

Picture 2 ... Note how the engine sits all the way down on the transmission.

How to Reseat the Flange

At some point, you may find that the tines won't turn when you press the throttle. This may mean the engine isn't sitting all the way down on the worm gear housing.

Perhaps you've been using your Tiller for several years. Or perhaps you've removed the engine for use with our hedge trimmer attachment, then replaced it. In either case, the flange bolt (Key #38, page 18) may have come loose and lifted the engine up.

If this happened you'll notice a gap between the bottom of the engine clutch case (Key #37, page 18) and

the top of the worm gear housing. (Picture 1)

To fix this, loosen the flange bolt. Take the engine off the worm gear housing. Notice the hex head on top of the drive shaft (Key #9, Page 16). Inside the clutch case, you'll find the clutch drum (Key #31, Page 29). Make sure the hex head lines up with the clutch drum inside the clutch case.

Then put the engine back on the worm gear housing. Make sure the plastic carrying handle is not under the fuel tank.

If you've followed these steps properly, there will be no gap between the clutch case and the worm gear housing. (Picture 2) Make sure you tighten the flange bolt!

Cleaning the Muffler Screen

1. Take out the spark plug.

2. Remove the red cylinder cover, (Key #32) which is held on by 2 phillips-head screws, (Key #33) and 1 hex-head screw, (Key #34) which you will need an allen wrench to remove.

3. You will see the metal exhaust guide, held on by 3 more phillips-head screws. (Key #26) Remove the exhaust guide.

4. Behind the exhaust guide (Key #25) will be the muffler gasket (Key #24) and muffler screen (Key #23). The screen sits under the gasket.

5. If the screen (Key #23) is clogged with deposits, it needs to be cleaned. Use carburetor cleaner, and any brush that is not metal. Brush the screen until you are able to see through it.

6. If the screen remains plugged after attempts at cleaning, it must be replaced.

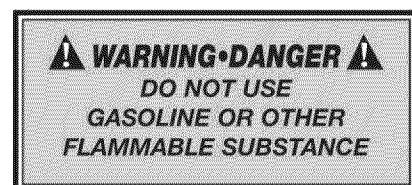
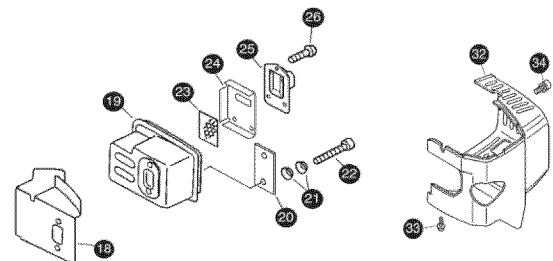

STORAGE

Each fall — or before you store your MANTIS Tiller for any long period — be sure to take these measures:

1. Do not store your Tiller with fuel still in it. Even under ideal conditions, stored fuel containing ethanol or MTBE can start to go stale in 30 days. And, since stale fuel has a high gum content, it can clog the carburetor, this, in turn, will restrict fuel flow. **So, when you're ready to store your Tiller, or will not be using it for more than 2 weeks, drain the fuel tank completely.** (Picture 2)

2. Next, restart the engine to make sure no fuel is left in the carburetor. Then run the engine until it stops. This will prevent gum deposits, forming inside of the carburetor and possible engine damage.

3. Disconnect spark plug wire and remove the spark plug. (Use the wrench that comes in our **optional** Handy item Kit, Item #8444. Or use a 19mm or 3/4" spark-plug wrench.) Pour about a teaspoon of clean, air-cooled, two-cycle oil through the spark-plug hole into the combustion chamber. (Picture 3) Leaving the spark plug out slowly pull the starter cord two or three times to coat the inside of the cylinder wall.

4. Replace the spark plug with a NGK-BPM8Y. A replacement spark plug is included in the **optional** Handy Item Kit item # 8444.

5. Install the spark plug, but leave the spark plug wire disconnected.

6. Clean the air filter as described on Page 11.

7. Clean dirt, grass, and other materials from the entire machine.

8. Wipe the tines with oil or spray them with WD-40, to prevent rusting.

9. Oil the throttle cable and all visible moving parts. (Do not remove the engine cover.)

10. Replace the fuel filter.

11. Check the grease level in the worm gear housing, as described on page 11.

12. Order new parts to replace any that are badly worn or broken. Just call your local authorized MANTIS dealer.

13. Store your Tiller, in an upright position, in a clean, dry place. You can store with the handles in an extended position or folded down. (Picture 1)

14. To fold the handles, follow these easy steps: Loosen the handle knobs (#40), fold the handles forward (see picture 1, inset). Tighten knob securely.

Your handles are now folded and ready to store in a smaller area.

15. Do you have fuel left over from last season? Dispose of it properly. Buy fresh oil and gasoline next season.

How to Prepare Your MANTIS Tiller for Restarting

Unfold the handles into an upright or extended position. Tighten the two handle knobs (#40)

In the Spring, when you take your Tiller out of storage, remove the spark plug. Pull the starter cord three or four times to clean oil from the combustion chamber.

(Picture 4) Wipe oil from the spark plug. Place the spark plug back into the cylinder. Re-connect the spark plug wire back on the spark plug. Then follow the steps on pages 9 & 10 to refuel and restart your Tiller.

Again, Check the Carburetor.

If your Tiller won't restart in the Spring — or if it lacks its usual power — the carburetor may need attention. Follow the steps on page 19 for adjusting the H and L screws. (Picture 5)

Check the Spark Plug Too.

If your Tiller won't restart, or if it lacks full power, the spark plug may be at fault. Check to see if the plug is fouled with oily black deposits. Clean or replace it if it is. (Picture 6)

Also, check whether the center electrode is rounded at the end, or if the ground electrode is worn. If either is the case, you should replace it with a NGK-BPM8Y spark plug. Use a 19mm or a 3/4" spark-plug wrench to install it. Adjust the plug gap to .024 - .028 in. (0.6 to 0.7 mm)

Caution: Do not over tighten the plug. The correct torque is 18 to 22 ft.-lbs. (24-30 n.m)

IMPORTANT NOTE:

To avoid possible damage to the threads, do not try to remove the plug from a hot aluminum cylinder head.

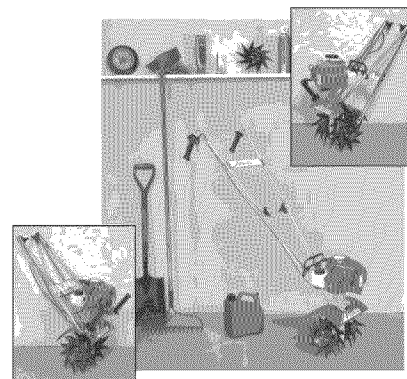
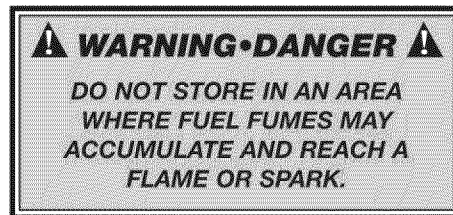

Picture 1

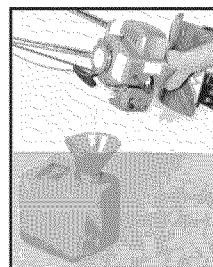

Picture 2

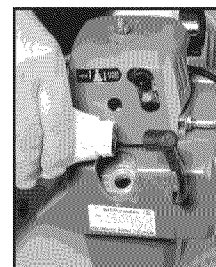

Picture 3

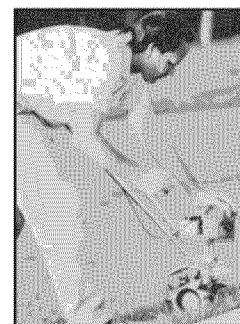

Picture 4

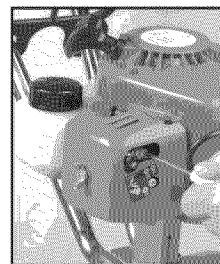

Picture 5

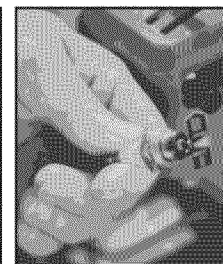

Picture 6



TROUBLE SHOOTING

Problem	Cause	Remedy
1. Tines don't turn when throttle is depressed	<ul style="list-style-type: none"> • Engine is not seated properly on the gear housing. 	<ul style="list-style-type: none"> • Re-install engine following the instructions on page 12 (How to reseal the flange).
2. Engine fails to start	<ul style="list-style-type: none"> • O/I switch is in "O" position. • No fuel in tank. • Fuel strainer clogged. • Fuel line clogged. • Spark plug shorted or fouled. • Spark plug is broken (cracked porcelain or electrodes broken) • Ignition lead wire shorted, broken or disconnected from spark plug. • Ignition inoperative 	<ul style="list-style-type: none"> • Move switch to "I." • Fill Tank. • Replace Strainer. • Clean fuel line. • Install new spark plug. • Replace spark plug. • Replace lead wire or attach to spark plug. • Contact your local authorized dealer.
3. Engine hard to start.	<ul style="list-style-type: none"> • Water in gasoline or stale fuel mixture. • Too much oil in fuel mixture. • Engine under or over choked. • Carburetor out of adjustment. • Gasket leaks (carburetor or cylinder base gasket). • Weak spark at spark plug. 	<ul style="list-style-type: none"> • Drain entire system and refill with fresh fuel. • Drain and refill with correct mixture. • If flooded by over choking, proceed according to instructions in operation section. If under choked, move choke lever to closed position and crank two or three times. • See "Carburetor Adjustment." • Replace gaskets. • Contact your local authorized dealer.
4. Engine continuously floods.	<ul style="list-style-type: none"> • Fuel tank vent line is not in an upright position. 	<ul style="list-style-type: none"> • Return the fuel tank vent line to the upright position and place it under the cylinder cover in the small "pocket" in the cylinder cover
5. There is black smoke coming from exhaust	<ul style="list-style-type: none"> • The muffler screen is clogged 	<ul style="list-style-type: none"> • Clean carbon from muffler screen (page 12)
6. Engine misses.	<ul style="list-style-type: none"> • Dirt in fuel line or carburetor. • Carburetor improperly adjusted. • Spark plug fouled, broken or incorrect gap setting. • Weak or intermittent spark at spark plug. 	<ul style="list-style-type: none"> • Remove and clean. • See "Carburetor Adjustment." • Clean or replace spark plug - set gap to .024-.028 in. (0.6-0.7 mm) • Contact your local authorized dealer.
7. Engine lacks power.	<ul style="list-style-type: none"> • Air filter clogged. • Carburetor out of adjustment. • Muffler clogged. • Clogged exhaust ports. • Spark Arrestor Clogged. • Poor compression. 	<ul style="list-style-type: none"> • Clean or replace air filter. • See "Carburetor Adjustment". • Clean carbon from muffler. • Remove muffler, rotate engine until the piston is at top of cylinder. With a wooden scraper or blunt tool, remove all carbon from exhaust ports. Be careful not to scratch or damage piston or cylinder walls. Blow out all loose carbon with compressed air. Install muffler and gasket. • Clean Spark Arrestor • Contact your local authorized dealer.
8. Engine overheats.	<ul style="list-style-type: none"> • Insufficient oil in fuel mixture • Air flow obstructed 	<ul style="list-style-type: none"> • Mix fuel as described in starting instructions. • Clean flywheel cylinder fins and screen.
9. Engine noisy or knocking.	<ul style="list-style-type: none"> • Spark plug in incorrect heat range. • Bearings, piston ring or cylinder walls are worn. 	<ul style="list-style-type: none"> • Replace with plugs specified for engine. • Contact your local authorized dealer.
10. Engine stalls under load.	<ul style="list-style-type: none"> • Carburetor adjustment too "lean." • Engine overheats. 	<ul style="list-style-type: none"> • See "Carburetor Adjustment." • Remove dust and dirt from between fins.

ENGINE SPECIFICATIONS

Dry Weight	2.8kg — 6 lbs., 3 ounces	Displacement	21.2 cc (1.294 cu. in.)
Type of Engine	Air Cooled, Two stroke, Single-Cylinder, Gasoline Engine	Exhaust System	Spark arrester muffler
Rotation	Clockwise, viewed from TOP	Carburetor	ZAMA diaphragm model CIU type
Bore	32.2 mm (1.268 in.)	Ignition System	Flywheel magneto, capacitor discharge ignition type
Stroke	26.0 mm (1.04 in.)	Starter	Automatic rewind type
Spark Plug	NGK BPM8Y	Oil	Designated, two-stroke, air-cooled engine oil
Fuel	Premixed two stroke fuel	Fuel Tank Capacity .	0.5 lit. (17.0 oz.)
Fuel Oil Ratio	50:1 ratio with MANTIS oil		
Gasoline	Unleaded (see page 7)		

SERVICE MAINTENANCE GUIDE

Area	Maintenance	Frequency
Air Filter	Clean Replace	Daily or every 4 hrs. use Every 3 mths. or 90 hrs. use
Fuel Filter	Inspect Replace	Monthly
Spark Plug	Clean Replace	Every 3 mths. or 90 hrs. use 6 months or 270 hrs. use
Carburetor	Check / Rebuild Replace	6 months or 300 hrs. use Yearly or 600 hrs. use*
Cylinder Exhaust Port	Inspect / Clean	Every 3 mths. or 90 hrs. use
Cooling System	Inspect / Clean	Before Use
Muffler (Spark Arrestor)	Inspect / Clean	Monthly
Gear Housing	Check Grease	Yearly
Tines	Inspect / Clean / Lubricate	After Use
Fuel Leaks	Inspect / Repair	Before Use
Fasteners	Inspect / Tighten / Replace	Before Use
Labels	Inspect / Replace	Before Use
Handles	Inspect / Replace	Before Use
Guards / Safety Devices	Inspect / Replace	Before Use
Fuel Line	Inspect / Replace	Monthly
Starter Rope	Inspect / Replace	Monthly
Fuel Strainer	Replace	Every 3 mths. or 100 hrs. use
Choke	Check	With each re-fueling
Ignition System	Clean Replace	No maintenance For coil and flywheel

* Replacement will be required for commercial use after 600 hours. For Consumer use, cleaning every 6 months is required. Cleaning includes Rebuild Kits.

IMPORTANT: Time Intervals shown are maximum. Actual use and your experience will determine the frequency of required maintenance.

Notes:

USING THE BORDER EDGER ATTACHMENT

Your MANTIS Tiller has been designed and built to accept a wide range of MANTIS Tiller Attachments to increase its usefulness in your lawn and garden. And, all MANTIS Tiller Attachments have been designed for quick and easy attachment to the Tiller or Engine.

The Border Edger

(Item #3222)

The most popular attachment, the Border Edger can be used to create clean, neat edges along walkways, or around trees, shrubs, and garden beds.

The Border Edger has two parts: a wheel and a hardened steel blade, with pointed tines.

How to Install the Border Edger

The following instructions refer to "right" and "left" axles. Assume that you're standing behind your Tiller, as you would for tilling and cultivating.

Some areas of your yard may harbor roots and other underground obstructions. In places like this you'll want to edge your borders shallowly (1" to 2" deep). Here's how to install the Border Edger for shallow edging:

1. First remove your tilling/cultivating tines.

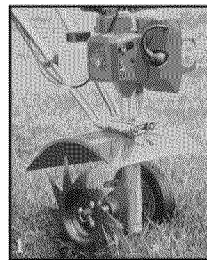

Picture 1



Picture 2

2. Then slide the Edger's wheel onto the right axle.

3. Now slide the Edger blade onto the left axle. The blade's angled face should hit the ground when you spin the blade forward; do not operate tiller without tine pins in place.

4. Insert retaining pins on both left and right axles.

Around walkways and garden beds, you'll want to edge more deeply (3" to 4" deep). Here's how to install the Border Edger for that purpose:

1. Remove the tilling/cultivating tines.

2. Slide the Edger's blade onto the right axle. The blade's pointed face should hit the ground when you spin the blade forward; do not operate tiller without tine pins in place.

3. Slide the wheel onto the left axle.

4. Insert retaining pins on both sides.

How to Use the Border Edger

1. Position your MANTIS Tiller so that the Edger blade is right along the garden edge and the wheel is outside (on the lawn, on the sidewalk, wherever). (Picture 1)

2. Start your Tiller and pull your MANTIS backward along the garden edge. (Picture 2)

The Border Edger Can Handle Special Projects!

1. Install the Edger for deep edging, as directed above. Then use it to cut sod strips.

2. Edge and weed at the same time! Just attach the Edger blade on one axle and a Tiller tine on the other axle, "Mix and match" blades; don't be afraid to experiment.

IMPORTANT NOTE:

If you do a lot of edging, you'll appreciate the MANTIS Wheel Set (Item#9222.) It gives you added stability, for even easier handling.

To order the Wheel Set, or any MANTIS Attachment, call your local authorized MANTIS dealer.

MANTIS TILLER ASSEMBLY

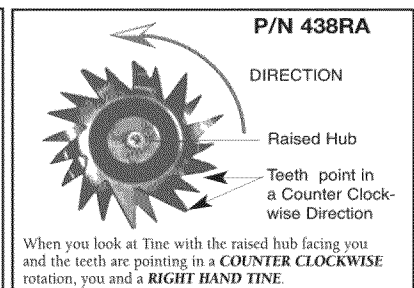
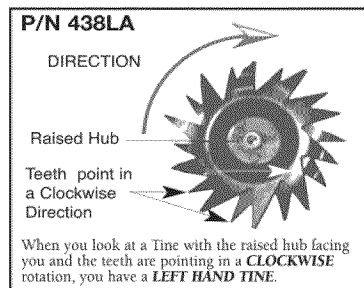
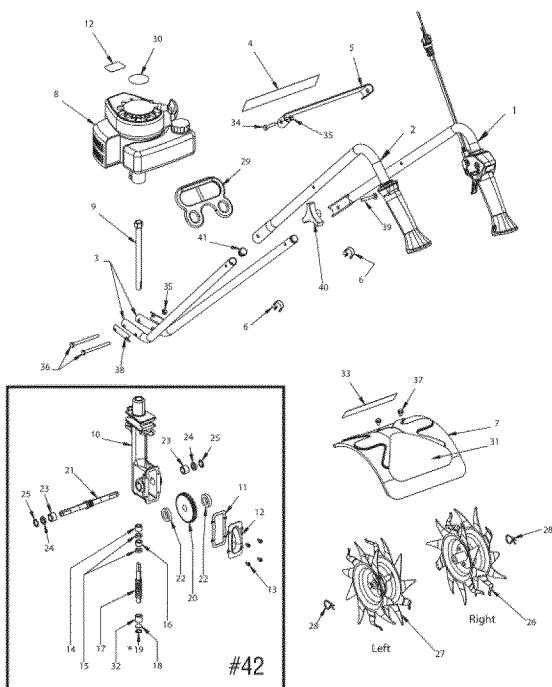

ITEM NAME	QTY	MATERIAL	ITEM NAME	QTY	MATERIAL	ITEM NAME	QTY	MATERIAL			
1	400254	1	Trigger Handle Assm. RH	15	425	2	Worm Bearing Race	29	400218	1	Carrying Handle
2	400255	1	Handle Assm. LH	16	424	1	Worm Thrust Bearing	30	487MA	1	Engine Label
3	400224	2	Lower Handle - Fold Down	17	422	1	Worm Shaft	31	4043	1	Tine Label
4	400620	1	Label	18	426	1	Worm Disk	32	458	1	Roller Bearing
5	148	1	Handle Brace	19	428	1	Retaining Ring	33	4058	1	Mantis Label
6	478	2	Throttle Clip	20	429	1	Worm Gear	34	410	2	Cap Screw 1/4-20 x 1" LG.
7	465	1	Fender Guard	21	431	1	Tine Shaft	35	972	4	Lock Nut 1/4 - 20
8	400908	1	Engine Assm. SV-5C/2	22	430	2	Worm Gear Thrust Washer	36	470	2	1/4 - 20 x 3" Bolt
*9	468	1	Drive Shaft	23	432	2	Worm Gear Bearing	37	140	2	Bolt 1/4-20 x 3/8" Lg.
10	466	1	Worm Gear Housing	24	434	2	Bearing Seal	38	377	2	Handle Clamp
11	436	1	Gasket	25	435	2	Bearing Seal Retainer	39	400509	2	Bolt
12	437A	1	Housing Cover	26	438RA	1	Tine Assm. (RT)	40	400510	2	Knob
13	651	4	Rd. Hd. Self Tapping Screw	27	438LA	1	Tine Assm. (LT)	41	400230	2	Plug
14	423	1	Roller Bearing	28	418-1	2	Tine Retaining Hair Pin	42	400010	1	Transmission Assm.

* Also in Key #42

SV-5C/2 ENGINE PARTS ASSEMBLIES CARBURETOR

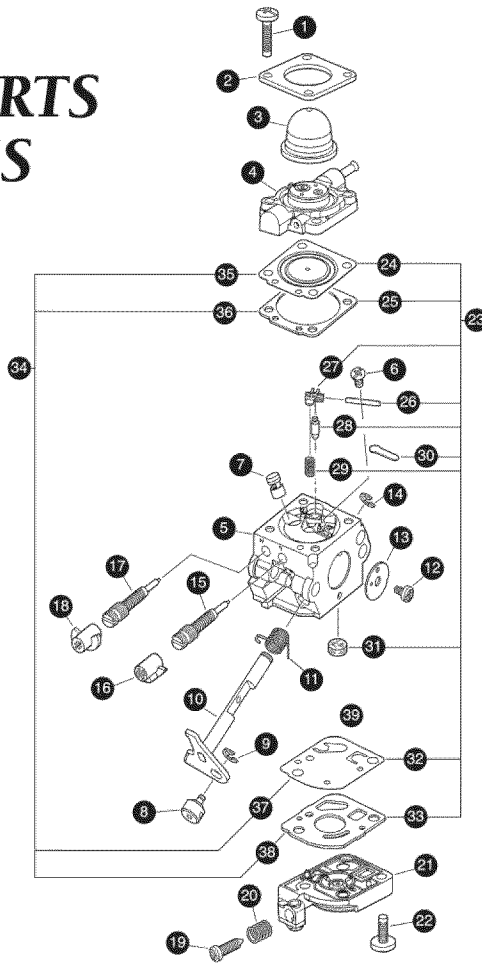

ITEM	PART #	QTY.	DESCRIPTION / REMARKS
	A021001090	1	CARBURETOR -- CIU-K82
1	P005000980	4	SCREW, PURGE BASE
2	P005000620	1	RETAINER, PURGE PUMP
3	12538108660	1	PUMP, PURGE
4	P005000970	1	BASE, PURGE
5		1	BODY, CARBURETOR / NOT AVAILABLE SEPARATELY
6	12533942030	1	SCREW, METERING LEVER PIN
7	12537613120	1	NOZZLE, CHECK VALVE
8	12537242030	1	SWIVEL
9	12532713930	1	CLIP, THROTTLE SHAFT
10	P005001070	1	SHAFT, THROTTLE
11	12531342030	1	SPRING, THROTTLE RETURN
12	12531413930	1	SCREW, THROTTLE VALVE
13	12531649030	1	VALVE, THROTTLE
14	12532715130	1	CLIP, THROTTLE SHAFT
15	12531813120	1	NEEDLE - LOW SPEED
16	12532909860	1	CAP, MIXTURE LIMITER - LOW SPEED
17	12532013310	1	NEEDLE - HIGH SPEED
18	12532939030	1	CAP, MIXTURE LIMITER - HIGH SPEED
19	12533406960	1	SCREW, IDLE ADJUST
20	12533306960	1	SPRING, IDLE ADJUST
21	12532412820	1	COVER, FUEL PUMP
22	12531012820	2	SCREW, FUEL PUMP COVER
23	12530013120	1	REPAIR KIT / INCLUDES ITEMS 24-33
24		1	DIAPHRAGM, METERING
25		1	GASKET, METERING DIAPHRAGM
26		1	PIN, METERING LEVER
27		1	LEVER, METERING
28		1	VALVE, INLET NEEDLE
29		1	SPRING, METERING LEVER
30		1	WELCH PLUG
31		1	STRAINER
32		1	DIAPHRAGM, FUEL PUMP
33		1	GASKET, FUEL PUMP
34	12530313120	1	GASKET/DIAPHRAGM KIT / INCLUDES ITEMS 35-38
35		1	DIAPHRAGM, METERING
36		1	GASKET, METERING DIAPHRAGM
37		1	DIAPHRAGM, FUEL PUMP
38		1	GASKET, FUEL PUMP

AIR CLEANER, MUFFLER, & THROTTLE

GASKET KIT

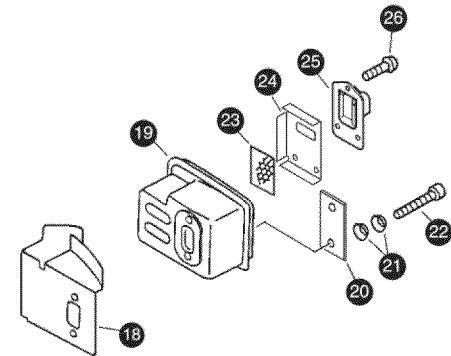
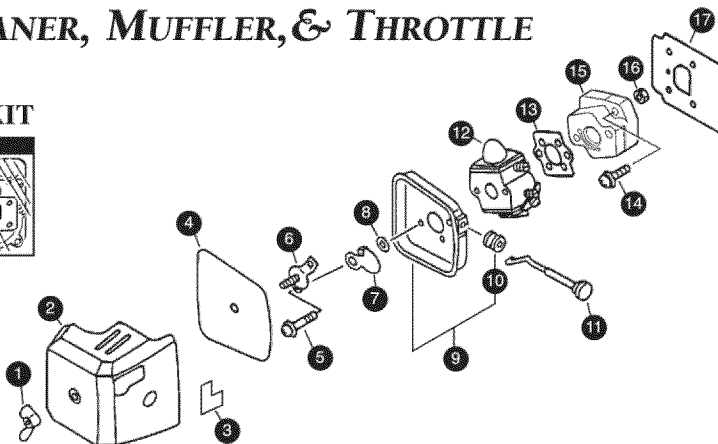
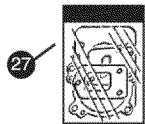

ITEM	PART #	QTY.	DESCRIPTION / REMARKS
1	90052800005	1	WING NUT
2	13032611522	1	COVER, AIR CLEANER
3	89012147530	1	LABEL, CHOKE
4	13031004560	1	FILTER, AIR
5	90024205057	2	SCREW 5X57
6	13041005360	1	BRACKET, AIR CLEANER
7	17851504560	1	SHUTTER, CHOKE
8	17851600830	1	SPACER
9	13030104560	1	CASE, AIR CLEANER / INCLUDES ITEM 10
10	17881005230	1	GROMMET
11	17851004560	1	ROD, CHOKE
12	A021001090	1	CARBURETOR -- CIU-K82
★ 13	13001642031	1	GASKET, INTAKE
14	90023805020	2	SCREW 5X20
15	13001742031	1	INSULATOR
16	90050000005	2	NUT 5
★ 17	13001042032	1	SHIELD, INTAKE

ITEM	PART #	QTY.	DESCRIPTION / REMARKS
★ 18	V104000590	1	SHIELD, EXHAUST
19	A300000521	1	MUFFLER
20	V150000371	1	EYE PLATE
21	V347000000	4	WASHER, CONICAL
22	90010505055	2	BOLT 5X55
23	14586240630	1	SCREEN, MUFFLER
★ 24	V104000072	1	GASKET, EXHAUST
25	A313000700	1	GUIDE, EXHAUST
26	9136704012	3	SCREW 4X12
Also Included in GASKET KIT			
27	P021009110	1	GASKET KIT

SV-5C/2 ENGINE PARTS

FUEL TANK

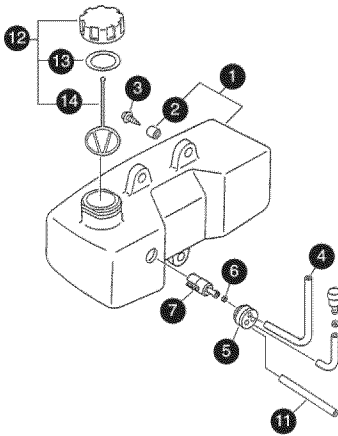

ITEM	PART #	QTY.	DESCRIPTION / REMARKS
1	A35000300	1	TANK, FUEL / INCLUDES ITEM 2
2	13104528230	1	SPACER
3	90027505015	3	SCREW 5X15
4	V471001230	1	PIPE, FUEL - 3X5X210MM / BULK OPTION: 90014
5	V137000030	1	GROMMET
6	13201309820	1	CLIP
7	13120507320	1	FILTER, FUEL
8	A356000030	1	VALVE, CHECK
9	13011100530	1	CLIP, PIPE
10	V471001200	1	PIPE, VENT - 3X5X70MM / BULK OPTION: 90014
11	13201049030	1	PIPE, RETURN - 3X6X50MM / BULK OPTION: 90017
12	13100409060	1	FUEL TANK CAP ASY / INCLUDES ITEM 13-14
13	13101655830	1	GASKET, FUEL TANK CAP
14	13105156030	1	CONNECTOR, FUEL TANK CAP

STARTER, PAWL CATCHER & CLUTCH

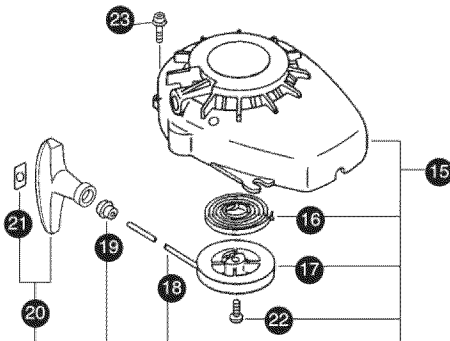

ITEM	PART #	QTY.	DESCRIPTION / REMARKS
15	17720012820	1	STARTER ASY / INCLUDES ITEMS 16-21
16	17722042030	1	SPRING, REWIND
17	17721544430	1	DRUM, STARTER
18	17722605530	1	ROPE, STARTER 3MM(1/8") X 1000MM(39-1/2"), BULK OPTION: 9994440000
19	17722742030	1	GUIDE, ROPE
20	17722811120	1	STARTER GRIP KIT
21	177224611120	1	RETAINER, ROPE
22	17723644330	1	SCREW
23	90023804016	4	SCREW 4X16
24	17500007531	1	CLUTCH ASY / INCLUDES ITEMS 25-27
25	17501605020	1	HUB, CLUTCH
26	17501805130	2	SPRING, CLUTCH
27	17500905131	2	SHOE, CLUTCH
28	17501904630	1	PLATE, CLUTCH
29	90060000010	1	WASHER 10
30	90080836000	1	BEARING, BALL
31	17501004633	1	DRUM, CLUTCH
32	17504404630	1	WASHER, CLUTCH
33	17501411520	1	WASHER, CLUTCH
34	90023806012	1	SCREW 6X12
35	90023804014	4	SCREW 4X14
36	90060000005	1	WASHER 5
37	90060500005	1	SPRING WASHER 5
38	13041611520	1	BOLT 5X25
39	61022311520	1	CASE, CLUTCH

BLOCK

ITEM	PART #	QTY.	DESCRIPTION / REMARKS
1	90016205022	2	BOLT 5X22
2	A130000550	1	CYLINDER
★ 3	V100000160	1	GASKET, CYLINDER
4	P021007712	1	PISTON, KIT / INCLUDES ITEMS 5-8
5	A101000090	1	RING, PISTON
6	10001311520	1	PIN, PISTON
7	10001504630	2	CIRCLIP, PISTON PIN
8	10001411520	2	SPACER, PISTON PIN
9	A011000390	1	CRANKSHAFT ASY / INCLUDES ITEM 10
10	V553000010	1	BEARING, NEEDLE
11	10020411521	1	CRANKCASE KIT / INCLUDES ITEMS 12-16
12	10021242031	2	OIL SEAL
13	10021503930	2	DOWEL PIN
★ 14	10024242030	1	GASKET, CRANKCASE
15	9403536201	2	BEARING, BALL
16	90016205028	3	BOLT 5X28
★ Also included in GASKET KIT			
17	P021009110	1	GASKET KIT
18	A411000220	1	COIL, IGNITION
19	90016204020	2	BOLT 4X20
20	15611004920	1	BUSHING
21	V475002200	1	TUBE
22	15901201620	1	CAP, SPARK PLUG
23	15901103432	1	TERMINAL, SPARK PLUG
24	15901019830	1	SPARK PLUG - BPM-8Y
25	16202152830	1	LEAD, IGNITION
26	61032502730	1	WOODRUFF KEY
27	A409000150	1	FLYWHEEL
28	90060500008	1	SPRING WASHER 8
29	17720212220	1	STARTER PAWL ASY / INCLUDES ITEMS 30-31
30	17721844330	2	PAWL, STARTER
31	17723412220	2	SPRING, PAWL RETURN
32	A160000610	1	COVER, CYLINDER
33	90023804018	2	SCREW 4X18
34	9110704008	2	SCREW 4X8

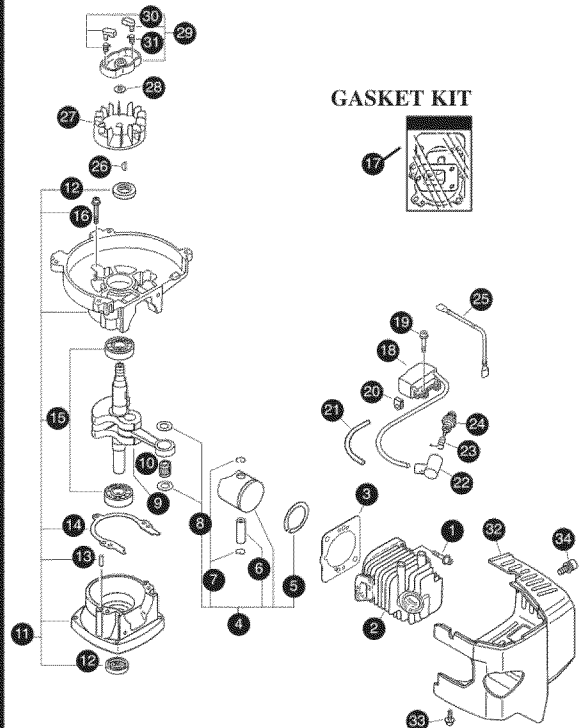

EPA PHASE 2 / CALIFORNIA TIER III EMISSION CONTROL WARRANTY STATEMENT YOUR RIGHTS AND OBLIGATIONS

The Environmental Protection Agency (EPA) and the California Air Resources Board (C.A.R.B.) and The Equipment Manufacturer are pleased to explain the **emission control system warranty** on your EPA Phase 2 / C.A.R.B. Tier III model year 2005 and later small off road engine (SOREs). New small off road engines must be designed, built and equipped to meet stringent EPA and C.A.R.B. anti-smog standards. Echo, Incorporated must warrant the emission control system on your small off road engine for the periods of time listed below provided there has been no abuse, neglect or improper maintenance of your small off road engine.

Your emission control system may include parts such as the carburetor or fuel injected system, and the ignition system and catalytic converter. Also included may be hoses, belts, connectors and other emission-related assemblies.

Where a warrantable condition exists, the Manufacturer will repair your small off road engine at no cost to you including diagnosis, parts and labor.

MANUFACTURER'S WARRANTY COVERAGE:

The 1995 and later small off road engines are warranted for **two years**. If any emission-related part on your engine is defective, the part will be repaired or replaced by the Manufacturer.

OWNER'S WARRANTY RESPONSIBILITIES:

- As the small off road engine owner, you are responsible for the performance of the **required maintenance listed in your *Operator's Manual***. The Manufacturer recommends that you retain all receipts covering maintenance on your small off road engine, but the Manufacturer cannot deny warranty solely for the lack of receipts or for your failure to ensure the performance of all scheduled maintenance.
- As the small off road engine owner, you should however be aware that the Manufacturer may deny you warranty coverage if your small off road engine or a part has failed due to abuse, neglect, improper maintenance or unapproved modifications.

You are responsible for presenting your small off road engine to the Manufacturer's authorized service center as soon as a problem exists. The warranty repairs should be completed in a reasonable amount of time, not to exceed 30 days.

If you have any questions regarding your warranty rights and responsibilities, you should contact your **Product Manufacturer**.

EPA PHASE 2 / CALIFORNIA TIER III EMISSIONS DEFECT WARRANTY EXPLANATION

This is additional detailed information about the EPA PHASE 2/ CALIFORNIA TIER III EMISSIONS DEFECT WARRANTY for your small off road engine.

WHAT DOES THIS WARRANTY COVER?

The Manufacturer warrants that your unit was designed, built and equipped to conform with applicable California emissions standards and that your unit is free from defects in material and workmanship that would cause it to fail to conform with applicable requirements within five (5) years. *The warranty period begins on the date the product is delivered to a retail purchaser.* This is your emission control system, DEFECTS WARRANTY.

HOW WILL A COVERED PART BE CORRECTED?

If there is a defect in a part covered by this warranty, a Manufacturer's Authorized Service Dealer will correct the defect.

You will not have to pay anything to have the part adjusted, repaired or replaced. This includes any labor and diagnosis for warranted repairs performed by the dealer. *In addition, engine parts not expressly covered under this warranty but whose failure is a result of a failure of a covered part will be warranted.*

Emissions System repairs covered under this warranty should be completed in a reasonable time, not to exceed 30 days.

IMPORTANT

If the diagnosis reveals no defect, the emission defect warranty does not apply.

WHAT PARTS ARE COVERED BY THE EPA PHASE 2/ CALIFORNIA TIER III 2005 & LATER SMALL OFF ROAD ENGINE EMISSIONS DEFECT WARRANTY?

- Any emission related part not scheduled for, "required maintenance" (See Engine Operators Manual, "SERVICE MAINTENANCE SCHEDULE") will be repaired or replaced within the warranty period. The repaired or replaced part will be warranted for the remaining Emissions Defect warranty period.
- Any emission related part scheduled for replacement during "required maintenance" (See Engine Operators Manual, "SERVICE MAINTENANCE SCHEDULE") is warranted for the period of time prior to the first scheduled replacement point for that part. Any such part repaired or replaced under warranty shall be warranted for the remainder of the period prior to the first scheduled replacement point for that part.
- Any manufacturer-approved replacement part may be used in the performance of any warranty maintenance or repairs on emission-related parts, and must be provided without charge if the part is still under warranty.
- Any replacement part that is equivalent in performance and durability may be used in non-warranty maintenance or repairs, and shall not reduce the warranty obligations of the manufacturer.
- The owner is responsible for the performance of the required maintenance described in the operators manual.

SPECIFIC EMISSION RELATED WARRANTED PARTS:

- | | |
|---|--|
| - Choke | - Carburetor (complete assembly or replaceable components) |
| - Fuel Injection Assembly or replaceable components | - Air Filter |
| - Electronic Ignition System | - Spark Plug |
| - Catalytic Converter / Muffler Assembly | |

WHAT IS NOT COVERED BY THE EPA PHASE 2/CALIFORNIA TIER III 2005 & LATER SMALL OFF ROAD ENGINE EMISSIONS DEFECT WARRANTY?

- Any failure caused by abuse, neglect, improper maintenance.
- Any failure caused by unapproved modifications, use of unapproved add-on parts/modified parts or unapproved accessories.

MANTIS TILLER LIMITED WARRANTY

MANTIS extends this limited warranty against defects in material and workmanship for a period of five (5) years for normal residential purposes and two (2) years for commercial use from the date of purchase, to the first retail purchaser and each subsequent owner, during the warranty period. This warranty covers all portions of the MANTIS TILLER.

MANTIS will repair or replace, at its option, any part or parts of the product proven to be defective in material or workmanship under normal usage during the warranty period. Warranty repairs and replacements will be made without charge for parts or labor. All parts replaced under warranty will be considered as part of the original product, and any warranty on the replaced parts will expire coincident with the original product warranty. If you think your MANTIS TILLER is defective in material or workmanship, you must send it, along with your proof of purchase (sales receipt) to:

Mantis
1028 Street Road
Southampton, PA 18966

You are responsible for pickup and delivery charges; the product must be returned to us postage paid.

MANTIS assumes no responsibility in the event that the product was not assembled or used in compliance with any assembly, care, safety, or operating instructions contained in the Owner's Manual or accompanying the product; was not used with reasonable care or requires replacement or repair due to accidents or lack of proper maintenance; or was misused, altered, used for

other than normal or intended purposes. This warranty does not cover damage due to normal wear and tear.

You must maintain your MANTIS TILLER by following the maintenance procedures described in the owner's manual. Such routine maintenance, whether performed by you or a dealer, is at your expense.

MANTIS MAKES NO EXPRESS OR IMPLIED WARRANTIES OR REPRESENTATIONS EXCEPT THOSE CONTAINED HEREIN. THE DURATION OF ANY IMPLIED WARRANTY, INCLUDING MERCHANTABILITY AND FITNESS FOR A PARTICULAR PURPOSE, IS LIMITED TO THE DURATION OF THIS WRITTEN LIMITED WARRANTY. MANTIS DISCLAIMS ALL LIABILITY FOR INDIRECT, INCIDENTAL AND/OR CONSEQUENTIAL DAMAGES IN CONNECTION WITH THE USE OF THE MANTIS PRODUCTS COVERED BY THIS WARRANTY. SOME STATES DO NOT ALLOW LIMITATIONS ON HOW LONG AN IMPLIED WARRANTY LASTS AND/OR DO NOT ALLOW THE EXCLUSION OR LIMITATION OF INCIDENTAL OR CONSEQUENTIAL DAMAGES, SO THAT ABOVE LIMITATIONS AND EXCLUSIONS MAY NOT APPLY TO YOU. THIS WARRANTY GIVES YOU SPECIFIC LEGAL RIGHTS, AND YOU MAY ALSO HAVE OTHER RIGHTS WHICH VARY FROM STATES TO STATE.

MANTIS
1028 Street Road
Southampton, PA 18966
(215) 355-9700

Specifications, descriptions, and illustrative material in this literature are as accurate as known at the time of publication, but are subject to change without notice.