

HOOVER[®] SteamVac[™]

Owner's Manual

ENGLISH → pp. 1-13
ESPAÑOL → pág. 14-21
FRANÇAIS → p. 22-29

**The Easy to Use
Deep Cleaner**
with automatic tool conversion

Review this manual before operating deep cleaner

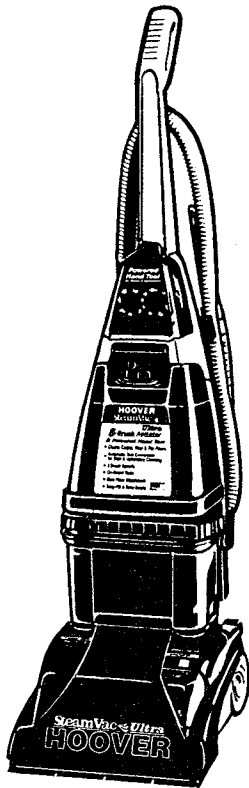

Ultra Models

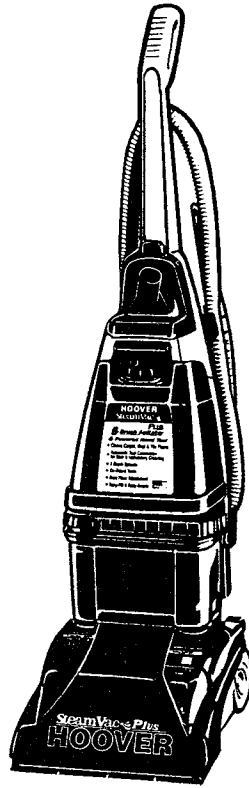

Plus Models

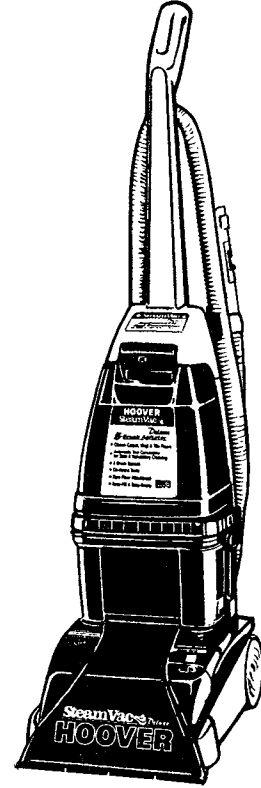

Deluxe Models

These models are included in this manual

**SteamVac[™] Deep Cleaner cleans carpet fibers
by applying hot tap water and cleaning solution.**



Fill in and Retain

This HOOVER deep cleaner is designed for deep cleaning carpet, rugs, carpeted stairs and upholstery. The model and serial numbers are located on the data label on the back of the handle.

For your personal records, please enter the COMPLETE model and serial numbers in the spaces provided and retain this information.

Your deep cleaner is model

and has serial number

It is suggested that you attach your sales receipt to this owner's manual.

Verification of date of purchase may be required for warranty service of your Hoover product.

Index

Important safeguards	2
Unpacking deep cleaner	3
Assembling deep cleaner	4-5
Deep cleaner description	6
General operation	6-9
Filling the clean solution tank	7-8
Emptying the recovery tank	8-9
Agitator speed selector	7
Brush Indicator	7
How to use	
Before you begin	9
After cleaning	9-10
Cleaning carpet	10
Picking up spills	10
Cleaning bare floors	10-11
Using the tools	11
Cleaning carpeted stairs	11-12
Cleaning upholstery	12
If you have a problem	13
Lubrication	12
Service	12
Storage	12
Warranty	13

Important Safeguards!

When using an electrical appliance, always follow basic precaution, including the following:

READ ALL INSTRUCTIONS BEFORE USING APPLIANCE.

WARNING: To reduce the risk of fire, electric shock, or injury:

- Use indoors only.
- Use **Only** on surfaces moistened by the cleaning process or small spills. Do not immerse product.
- **Connect** to a properly grounded outlet only. See "Grounding Instructions".
- Do not clean over floor electrical outlets.
- Do not use without tanks in place.
- Use extra care when cleaning on stairs. Do not place deep cleaner on stairs.
- Use deep cleaner only for its intended use as described in the instructions.
- Use only attachments recommended by The Hoover Company; others may cause hazards.
- The use of an extension cord is not recommended. If an extension cord is absolutely necessary, use at least a 16 gauge 3-wire cord which has a 3-prong grounding type plug and a 3-pole receptacle that accepts the machine plug.
- Unplug deep cleaner when not in use. Turn off all controls before unplugging.
- Always disconnect cord from electrical outlet before servicing the deep cleaner.
- Do not unplug by pulling on cord. To unplug, grasp the plug, not the cord.
- Never handle plug or appliance with wet hands.
- Do not pull or carry by cord, use cord as a handle, close door on cord or pull cord around sharp edges or corners. Do not run appliance over cord. Keep cord away from heated surfaces.
- Do not use with damaged cord or plug. If appliance is not working as it should, has been dropped, damaged, left outdoors, or dropped into water, take it to a Hoover Factory Service Center or Authorized Hoover Warranty Service Dealer.
- Close supervision is necessary when any appliance is used by or near children. Do not allow deep cleaner to be used as a toy or to run unattended at any time.
- Do not point tools toward people or pets.
- Use only commercially available floor cleaners intended for machine application. Do not use any type of wax with deep cleaner.
- To assist in reducing drying time, be certain the area is well ventilated when using detergents and other cleaners with this machine.
- Keep detergents and other cleaners out of children's reach.
- Do not use to pick up flammable or combustible liquids such as gasoline or use in areas where they may be present.
- Do not pick up chlorine bleach, drain cleaner, gasoline or any other toxic material with this appliance.
- Do not pick up anything that is burning or smoking, such as cigarettes, matches, or hot ashes.
- Avoid picking up hard, sharp objects with the deep cleaner. They may damage the machine.
- Keep hair, loose clothing, fingers, feet and all parts of body away from openings and moving parts.
- Do not put any object into openings. Do not use with any opening blocked; keep free of dust, lint, hair, and anything that may reduce air flow.
- To help prevent matting and resoiling, avoid contact with carpets until they are dry. Keep children and pets away from carpets until they are **completely** dry.
- Store in a dry place. Do not expose machine to freezing temperatures.

Save these instructions!



Grounding Instructions

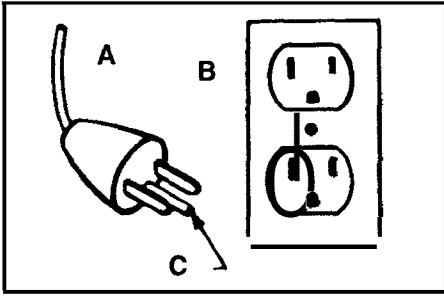

This appliance must be grounded. If it should malfunction or breakdown, grounding provides a path of least resistance for electrical current to reduce the risk of electric shock. This appliance is equipped with a cord having an equipment-grounding conductor (C) and grounding plug (A). The plug must be plugged into an appropriate outlet (B) that is properly installed and grounded in accordance with all local codes and ordinances.

DANGER-

Improper connection of the equipment-grounding conductor can result in the risk of electric shock. Check with a qualified electrician or service person if you are in doubt as to whether the outlet is properly grounded. Do not modify the plug provided with the appliance - if it will not fit the outlet, have a proper outlet installed by a qualified electrician. This appliance is for use on a nominal 120 volt circuit and has a grounding plug that looks like the plug illustrated in sketch (A).

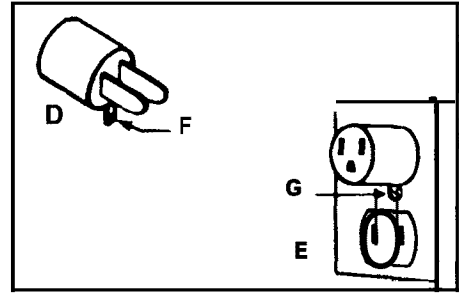

A temporary adapter (D) may be used to connect this plug to a 2-pole receptacle (E) if a properly grounded outlet is not available. The temporary adapter should be used only until a properly grounded outlet (B) can be installed by a qualified electrician. The green colored rigid ear, lug, or the like (F) extending from the adapter must be connected to a permanent ground (G) such as a properly grounded outlet box cover. Whenever the adapter is used, it must be held in place by a metal screw. **NOTE:** In Canada, the use of a temporary adapter is not permitted by the Canadian Electrical Code.

Unpacking

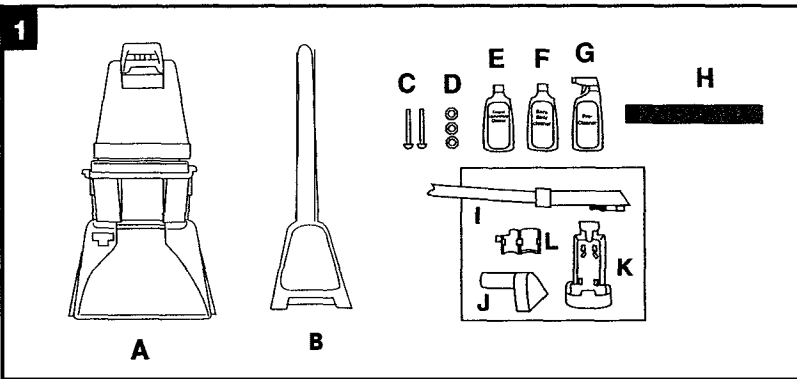

1 Unpack deep cleaner from the carton and identify the parts shown. Remove and dispose of the packing.

- A. Deep cleaner
- B. Upper handle OR
Upper handle for stair/upholstery nozzle storage*
OR Upper handle with powered hand tool**
- c. Bolts (2)
- D. Nuts (3 - one extra included)
- E. Carpet/Upholstery Detergent
- F. Bare Floor Cleaner
- G. PreCleaner (some models)
- H. Bare floor attachment

Contained in carton with hose:

- I. Hose
- J. Stair/upholstery nozzle OR car cleaning tool*
(positioned on rack); Stair/upholstery nozzle not
positioned on rack*
- K. Hose rack and screw (taped on rack under nozzle)
- L. Clip for hose

*Included with Plus models

**Included with Ultra models

Assembling Deep Cleaner

The assembled cleaner will look like this drawing (Ultra model shown).

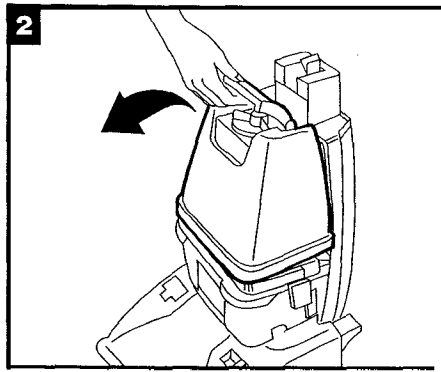
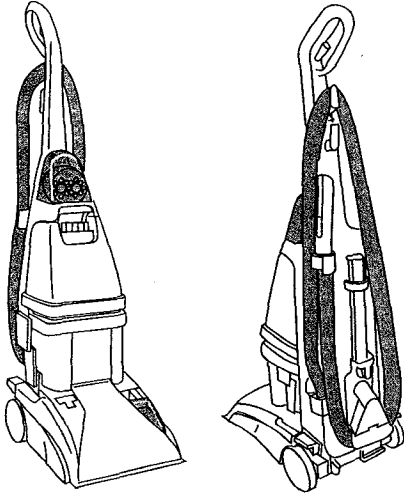

Attach upper handle

- Remove clean solution tank (upper tank) from deep cleaner.

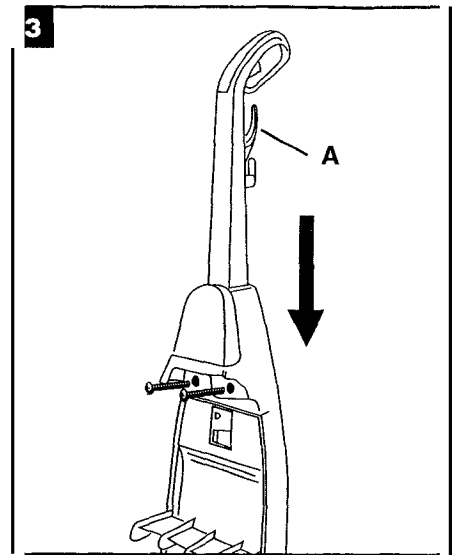

- With cord hook (A) to back of deep cleaner, push upper handle down onto lower handle. Push bolts into holes on front of handle. If bolts will not go through hole easily handle is not pushed completely down.

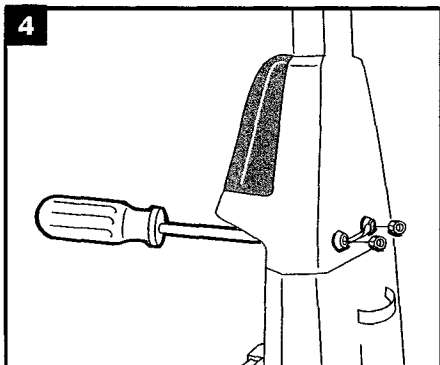

- Place nuts in recessed areas on back of handle. Hold each nut in place while tightening each bolt securely with a Phillips screw driver.

Only two nuts are needed on this model. The extra nut is not required but has been provided for your convenience.

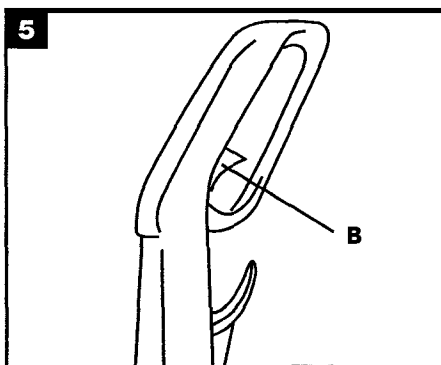

- When handle sections are completely together, squeeze trigger (B) on upper handle to snap trigger rod in place.

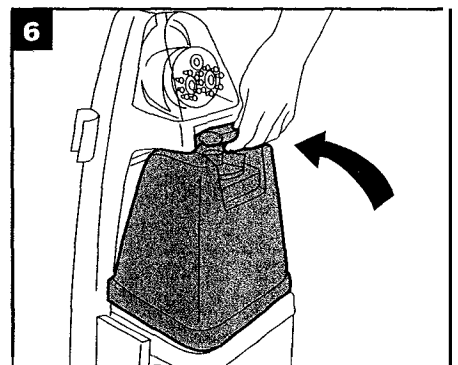

- Replace clean solution tank (upper tank) by positioning bottom first. Press on tank handle to snap top of tank into place.

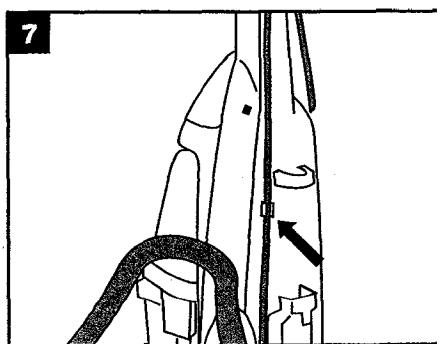

- Press cord into cord clip on back of handle. Pull cord tight.

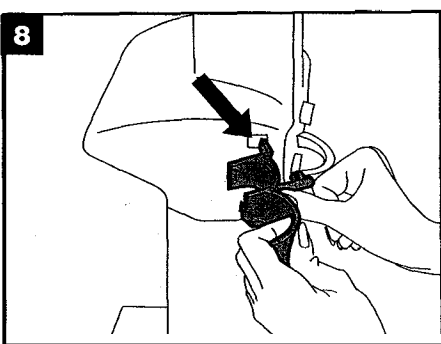

Attach hose clip

- Push tab on side of clip into hole on side of handle.

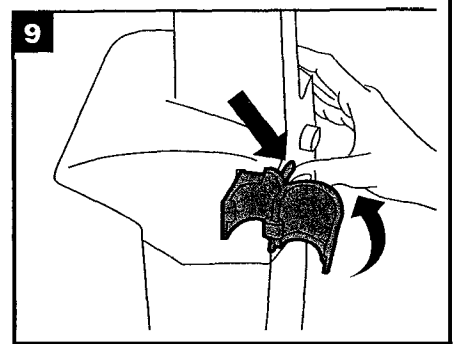

- Pivot clip and push other tab into hole at back of handle to lock into place.

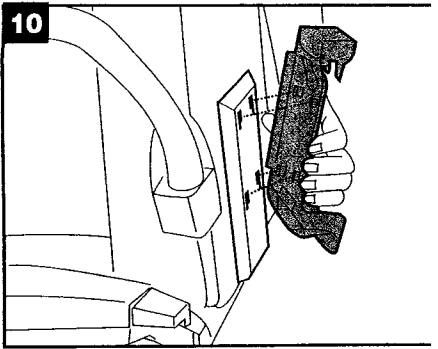

10 Attach hose rack

Remove tool and taped screw from rack.

Insert projections on rack into slots on back of cleaner.

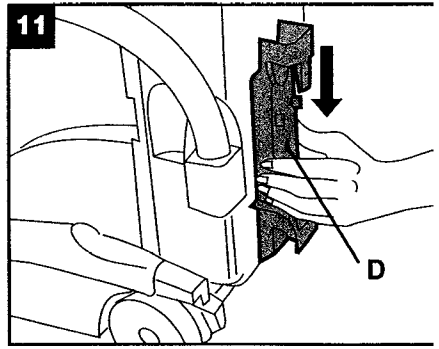

Slide rack down into place. Insert screw at (D) and tighten with a Phillips screwdriver.

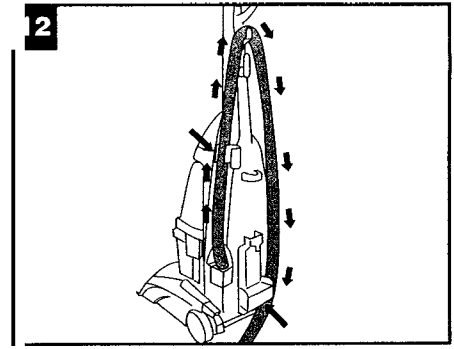

2 Storing hose & tools

Store hose on rack by first positioning hose in front section of clip.

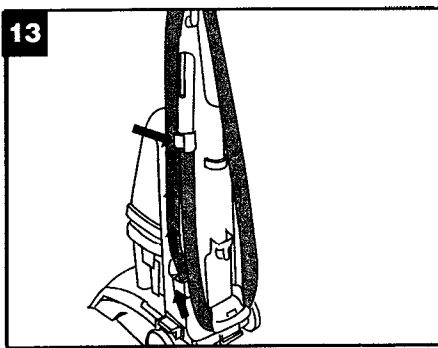

Then continue wrapping hose as shown snapping end of hose connector into clip.

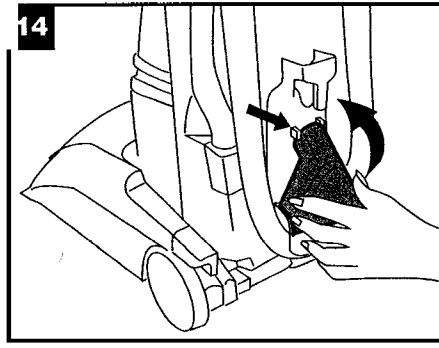

Position tool in holder at base of cleaner and snap it into place as shown at arrow.

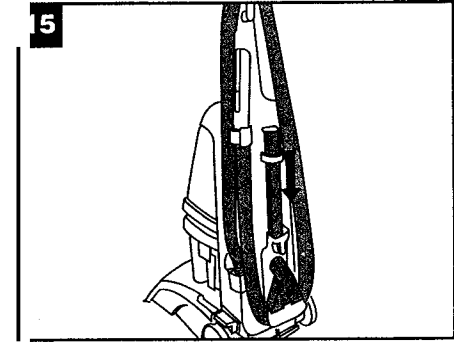

Slide bare floor attachment into holder as shown.

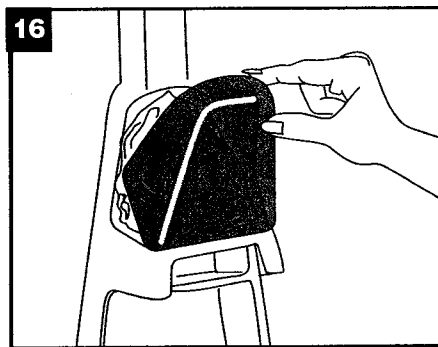

16 For Plus* or Ultra** models

The powered hand tool** is shipped in a plastic bag for protection. Remove the bag before using the tool by first opening tool door.

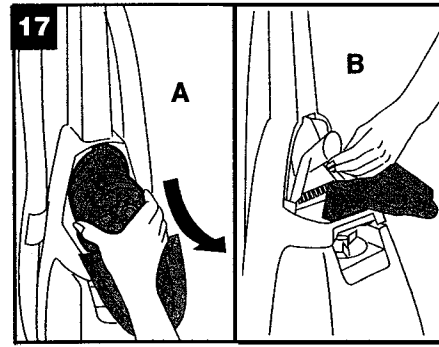

To remove tool** (A), pull it down and outward. To reposition the tool, reverse this procedure. To store stair/upholstery nozzle* (B), open tool door, place nozzle in bracket and fit it securely into position. To remove, reverse this procedure.

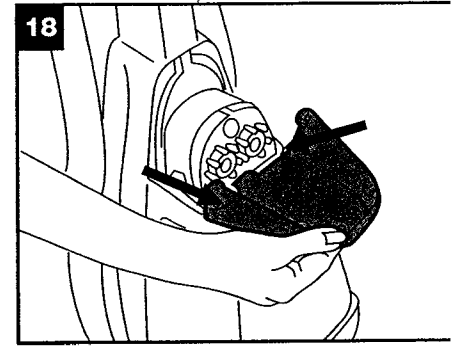

18 How to reattach tool cover

The tool cover is designed with a break-away feature which allows it to snap free if it is pushed open too far. To reattach, align hinges of cover with slots on sides of tool storage area. Push cover down to secure in place.

Deep Cleaner Description

The assembled deep cleaner will look like the drawing.

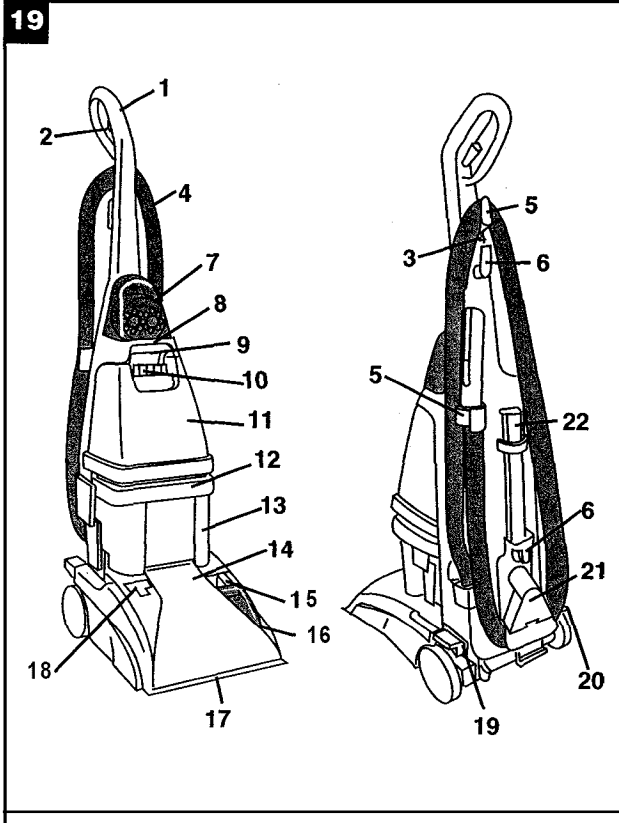

1. Hand grip
 2. Solution trigger: press to release clean solution.
 3. Cord clip: place cord in clip to keep it out of the way when using cleaner
 4. Hose
 5. Hose holders: wrap hose around holders for storage.
 6. Cord hooks: wrap cord around hooks for storage. The top hook can be rotated right or left for quick and easy cord release.
 7. Stair/upholstery nozzle* OR Powered hand tool**
 8. Carrying handle
 9. Clean solution tank handle
 10. Clean solution tank cap/measuring cup
 11. Clean solution tank: holds cleaning solution.
 12. Recovery tank handle: raise handle to unlock tank for removal; lower handle for ward to lock tank into position.
 13. Recovery tank: holds dirty solution.
 14. Hood
 15. Agitator speed selector: slide selector to set brush speed on HI, LO, or OFF.
 16. Brush Indicator: spins when brushes are rotating.
 17. Nozzle.
 18. Cleaning mode indicator: choose either floor or tools
 19. ON/OFF pedal
 20. Handle release pedal: step on pedal to lower handle to operating (floor) position;
 21. Stair/upholstery nozzle OR Car cleaning tool*
 22. Bare floor attachment
- *Included with Plus models
**Included with Ultra models

This deep cleaner is intended for household use.

General Operation

Operate deep cleaner only at voltage specified on data plate on back of cleaner. Plug deep cleaner into a properly grounded outlet.

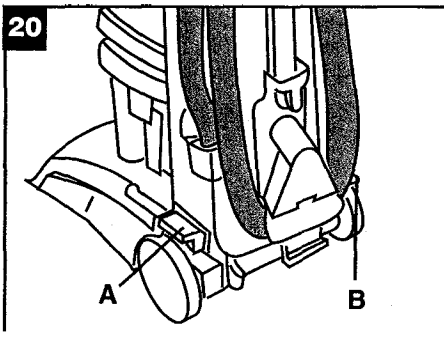

ON/OFF pedal & Handle release pedal

Step on pedal (A) to turn deep cleaner on. Step on pedal again to turn deep cleaner off.

Step on pedal (B) to lower handle to operating position. Handle does not lock into a single position but "floats" to allow convenient operation.

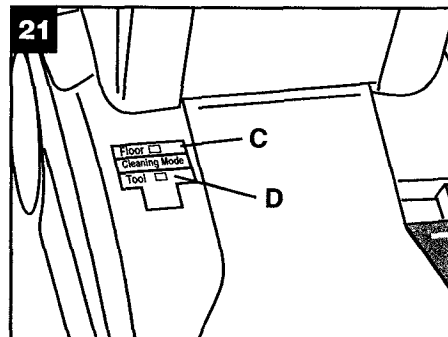

Cleaning mode indicator

Indicator will show a green window next to FLOOR (C) when handle is in the operating position for cleaning carpet rugs and bare floors.

Indicator will show a green window next to TOOL (D) when handle is in the upright position for tool use on stairs upholstery etc.

Deep cleaner automatically divert suction from FLOOR to TOOL when handle is raised from the operating to the upright position.

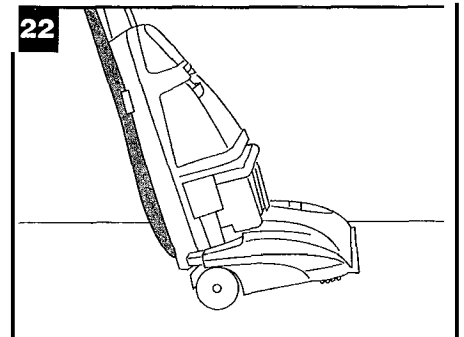

To transport

To move your deep cleaner from room to room put handle in upright and locked position tilt deep cleaner back on wheels and push forward.

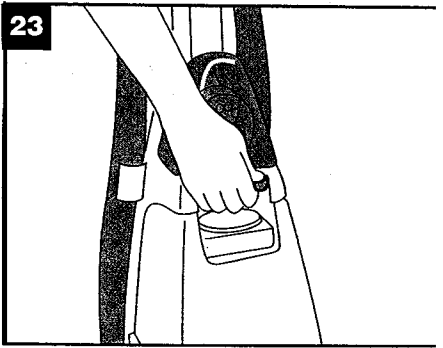

23 The deep cleaner may also be lifted by placing a hand under the upper clean solution tank handle as shown.

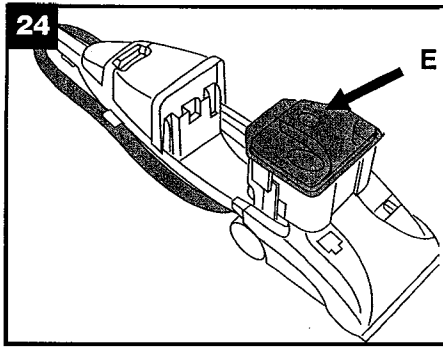

24 When the recovery tank (lower tank) is full the automatic shutoff mechanism will shut off the deep cleaner suction (**suction will be noticeably reduced**).

At that time the red float disk will rise to the top of the recovery tank lid (E). The deep cleaner will no longer pick up dirty solution and the **motor sound will become noticeably higher in pitch**.

When this happens turn deep cleaner off and empty recovery tank before continuing use.

Check clean solution tank also; it may need to be refilled.

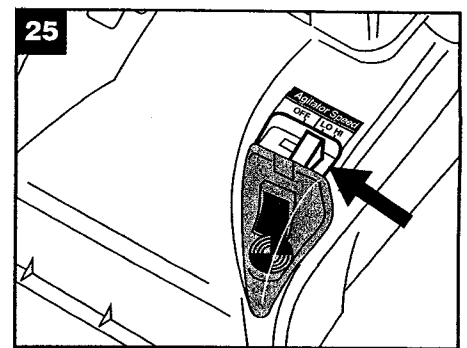

Agitator Speed selector

25 Your 'SteamVac' deep cleaner has three agitator brush settings.

HI - for normal cleaning of carpet and bare floors

LO - for gentle cleaning of carpets and bare floors

OFF - for cleaning carpets and bare floors when brushing is not desired. (Such as when picking up liquid spills. See page 10.)

Slide selector button to the desired setting before cleaning.

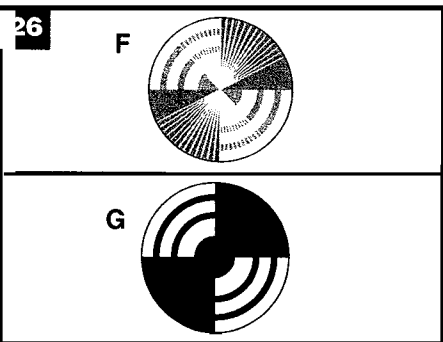

Brush indicator

26 The brush indicator will spin (F) when the deep cleaner is turned ON and the brushes are rotating.

If the indicator does not spin and the pattern is visible (G) when the deep cleaner is turned ON, the brushes are not rotating.

There are three reasons why the brushes may not be rotating:

1. Brush speed selector set on OFF (see previous section).
2. Handle in upright position (see "Cleaning mode indicator," p. 6).
3. Brush indicator screen dirty.

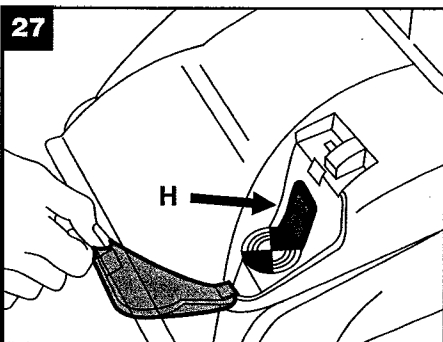

27 To clean screen (H), turn deep cleaner off and disconnect from electrical outlet.

Remove clear cover and wipe off screen with a damp cloth. Snap cover back into position.

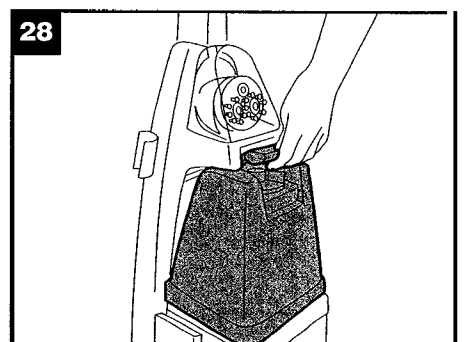

The tanks Clean solution tank (upper tank)

28 The clean solution tank holds the cleaning solution that is to be dispersed onto the surface to be cleaned.

How to fill

Disconnect deep cleaner from electrical outlet.

29 Place deep cleaner handle in the upright, locked position.

To remove tank, press down on handle and pull forward.

Carry tank to a sink.

Continued →

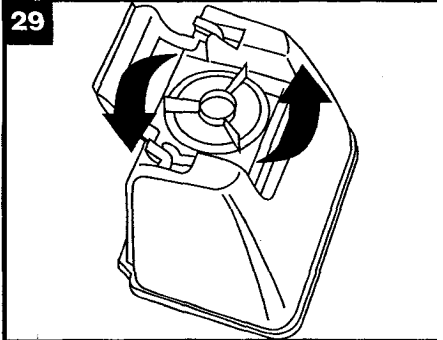

29 Rotate tank cap counterclockwise and lift up to remove cap.

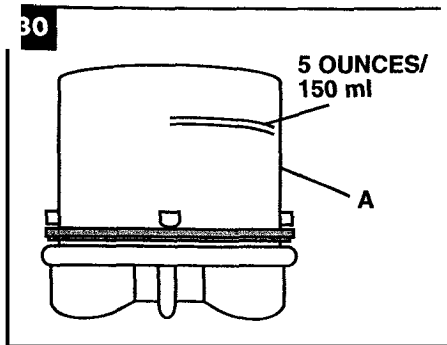

30 Turn cap (A) upside down to serve as a measuring cup.

Using cap, measure detergent following the chart below.

For carpet, carpeted stairs and upholstery:

Fill cap to fill line (5 ounces) with **HOOVER Carpet/Upholstery Detergent**

For bare floors:

Fill cap to fill line (5 ounces) with **HOOVER Bare Floor Cleaner**

Do not use Bare Floor Cleaner on carpet or upholstery. **Do not use any type of wax with your 'SteamVac' deep cleaner.**

NOTE: Use only HOOVER detergents. They are specially formulated for use with your 'SteamVac' deep cleaner.

For heavy traffic areas:

Pre-treat with HOOVER PreCleaner Spray.

If you do not have access to the **PreCleaner Spray**, double the amount of **HOOVER Detergent** (use 2 capfuls or 10 ounces per 1 gallon tank).

CAUTION: Detergents contain Anionic and Nonionic Surfactants. Avoid contact with eyes and skin. In case of contact with eyes, flush with cold water for 15 minutes. In case of contact with skin, wash with water. If Irritation persists, call a physician. For Medical Information (U.S.) call 1-800-752-7889.

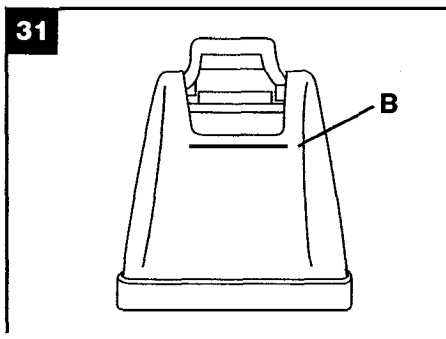

31 Pour detergent into tank. Fill tank to fill line (B) (1 gallon) with hot tap water.

To assure proper performance, use only **HOOVER cleaning detergent.**

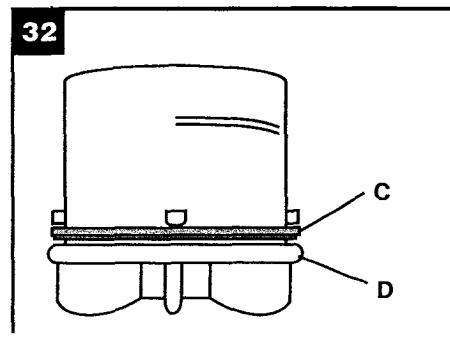

32 If rubber ring (C) on cap has become dislodged, reposition it with uneven side against ledge (D) as shown.

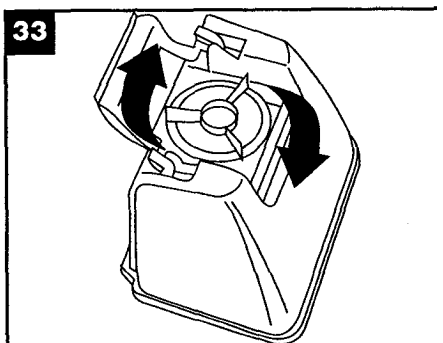

33 Replace cap. Rotate cap clockwise until it locks in place. Cap must be locked in place for proper performance and to prevent leaking.

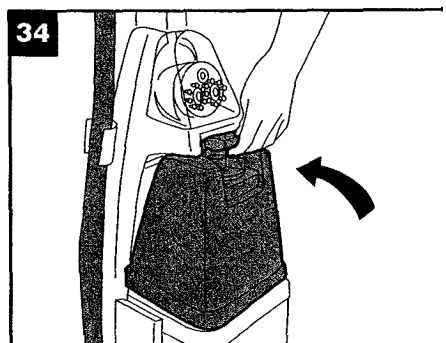

34 Position bottom of tank into unit and press on tank handle to snap tank into place.

Recovery tank (lower tank)

The recovery tank holds the dirty solution that is picked up from the carpet.

When the recovery tank is full, the automatic shut-off will engage (see page 7) and the tank must be emptied.

How to empty

Turn deep cleaner off and disconnect from electrical outlet.

To prevent possible leaking, remove clean solution tank (Fig.28) by pressing down on tank handle and pulling forward; set tank aside (**do not set tank on furniture**).

Step on handle release pedal (Fig. 20) and lower handle until it rests on the floor.

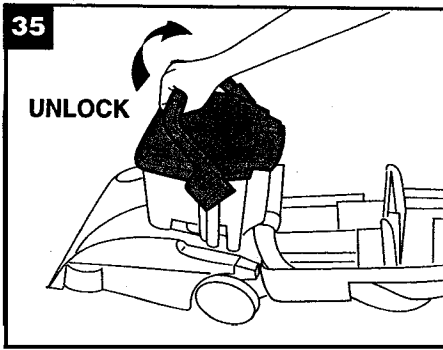

Raise handle to carrying position (straight up) to **unlock tank** from base of deep cleaner. Lift tank from deep cleaner and carry it to a sink or drain.

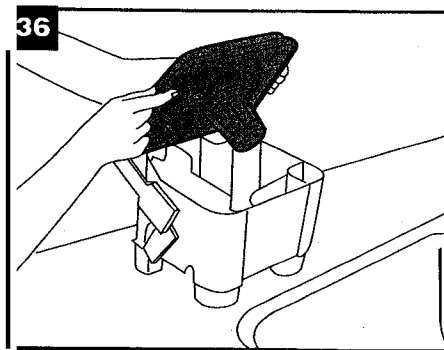

To remove tank lid, lower handle completely toward back of tank and lift off lid. Empty the tank and reposition the lid.

For full suction, it is important that the recovery tank lid is properly secured before cleaning.

Raise tank handle to carrying position to place it into base of cleaner. Move handle completely forward to **lock tank** into place (see Fig. 35).

Raise handle of deep cleaner to upright position and reposition upper clean solution tank.

How to use

Before you begin cleaning

a. Vacuum thoroughly - For carpet, use a vacuum cleaner with an agitator for best results. Vacuum upholstery with a vacuum cleaner with cleaning tool attachments. Use a crevice tool to reach into tufts and folds. **Do not use the 'SteamVac' deep cleaner as a dry vacuum cleaner.**

b. For upholstery, check cleaning code - Use your HOOVER 'SteamVac' deep cleaner only if the upholstery fabric is marked with a "W" (for "wet" clean) or "S/W" (for "solvent/dry" or "wet" clean). **Do not clean fabric marked "S" ("solvent/dry" clean only).** If your upholstery does not have a code, seek professional assistance.

c. Test for colorfastness - Mix detergent and water according to the instructions under "Fill clean solution tank" on pages 7

and 8. Wet a white absorbent cloth with the solution. In a small, hidden area, gently rub the surface with the dampened cloth. Wait ten minutes and check for color removal or bleed with white paper towel or cloth. If surface has more than one color, check all colors.

d. When cleaning entire floor, move furniture out of area to be cleaned (may not be necessary if only high traffic areas are to be cleaned). For furniture too heavy to move, place aluminum foil or wax paper under legs. This will prevent wood finishes from staining carpet. Pin up furniture skirts and draperies.

e. Pretreat spots and heavy traffic areas with HOOVER® PreCleaner™- Test PreCleaner for colorfastness by first spraying it on a hidden area; wait ten minutes and blot with white paper towels or cloth. If no color change is visible, spray PreCleaner onto spots and traffic areas. Wait at least ten minutes. Use your 'SteamVac' deep cleaner to pick up PreCleaner and spot. Repeat until spot is removed; carefully scrub with a household scrub brush if necessary.

Do not saturate carpet or upholstery with PreCleaner.

If you do not have access to the PreCleaner Spray, double the amount of HOOVER Detergent (use 2 capfuls or 10 oz. per 1 gallon) in the clean solution tank.

*Available at additional cost if not included with your model. No cleaning solution removes all stains from all carpets. Stain removal varies with the type of spill, time elapsed before removal, carpet material, and carpet type.

f. To prevent staining, use plastic or aluminum foil to protect wood or metal surfaces from possible water spray.

g. To avoid wetting and possible damage to wood floors underneath area rugs/carpet, either move area rugs/ carpet to a non-wood bare floor surface or place waterproof material (e.g. plastic) underneath them before cleaning.

See pages 10-14 for instructions on various cleaning tasks.

After cleaning

a. Allow carpet or upholstery to dry. To help prevent matting and resoiling the carpet, keep children and pets away from surface until it is **completely dry**. If it is necessary to walk on damp carpet, place towels or white cloths on the traffic areas.

If furniture must be replaced before the carpet is dry, use plastic or aluminum foil pads under legs of furniture so metal slides or wood finishes will not stain the carpet.

b. If desired, the carpet may be rinsed. **Rinsing is not necessary for cleaning**, but it may improve the surface's appearance after it is dry.

If rinsing is desired, be careful not to over-wet the carpet or upholstery.

Allow time for carpet or upholstery to dry completely between cleaning and rinsing. To rinse, follow the same procedure for cleaning only using hot tap water with no detergent in the upper clean solution tank.

c. Empty tanks, rinse with clear water and let air dry. Rinse the solution tank cap and recovery tank lid and let air dry.

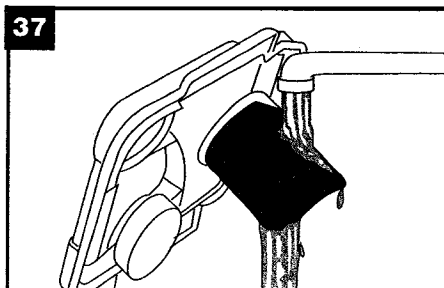

d. Remove debris from recovery tank filter and rinse with clean water.

Note: If the filter must be removed for cleaning, it is easier to replace if the filter is wet.

e. If desired, vacuum thoroughly after carpet has completely dried. This will help reduce any shading left by the deep cleaner's brushes.

To clean nozzle

If lint or other debris becomes lodged in nozzle, **do not attempt to remove nozzle cover.**

Pour one to two cups of clear water on a non-carpeted floor. **Do not pour water onto a wood floor.**

Pick up water with your 'SteamVac' deep cleaner. Repeat as necessary until debris is flushed out of nozzle.

Continued → 9

To clean the outside of the machine, wipe off dirt with a cloth dampened in warm water and mild detergent. **Do not use solvent or petroleum based products to clean the machine.**

Carpet Cleaning

Read "Before you begin cleaning" instructions on page 9.

Fill clean solution tank (upper tank) with HOOVER Carpet/Upholstery Detergent according to instructions on pages 7 and 8.

Move speed selector to **LO** for gentle cleaning or **Hi** for normal cleaning.

Dry hands and plug cord into a properly grounded outlet.

Do not clean over floor electrical outlets.

To avoid walking on damp carpet, start at the end of the room farthest from the door or path to sink where tanks will be emptied and filled.

Step on handle release pedal and lower handle to operating position; turn deep cleaner ON.

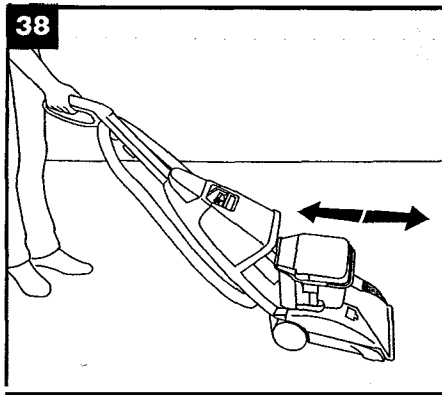

 Squeeze trigger to release cleaning solution and **slowly** push deep cleaner forward (equals one wet stroke).

Continue to squeeze trigger and **slowly** pull deep cleaner back toward you (second wet stroke). Release trigger and slowly push deep cleaner forward over area just sprayed with solution (dry stroke). Then **slowly** pull deep cleaner back toward you without squeezing trigger (dry stroke).

Overlap strokes by 1 inch to help pre-

vent streaking.

Keep nozzle flat on floor for both forward and reverse strokes.

For heavily soiled areas, repeat. **To avoid saturating carpet, do not use more than 4 wet strokes over one area. Always end with dry strokes.**

It is best to alternate wet and dry strokes as described above.

For best cleaning results and to aid in faster drying of carpet, end with more dry strokes. (Continue using dry strokes until little water is visible passing through the recovery tank lid.)

Empty recovery tank when the motor sound becomes higher pitched and there is a loss in suction (see "Automatic shut-off", page 7)

When finished cleaning, follow "After cleaning" instructions on pages 9-10.

Picking up spills

Your HOOVER SteamVac deep cleaner may also be used to pick up **small liquid spills (1 gallon or less, never to exceed 1/4 inch in depth)** on carpet, upholstery, or bare floors.

For best results, pick up spills immediately by placing the stair/upholstery nozzle just above the spill and suction up any residue on top of the carpet. If the spill remains, place either the stair/upholstery nozzle or floor nozzle *with brushes turned OFF* in front of the spill, pull the nozzle very slowly over the spill initially with suction only. Repeat with spray and suction.

When picking up spills on bare floors,

use only the floor nozzle with the bare floor attachment in place and speed selector in the **OFF** position (this will help prevent spreading the spill).

If a spot is left, the stair/upholstery nozzle is generally more effective for removing it. Although no cleaning solution can completely remove all spots, they can be treated by following the instructions provided by the manufacturer of the carpet, upholstery, or bare floor surface being cleaned.

Do not use the SteamVac deep cleaner to pick up flammable or combustible liquids or chemicals.

When finished, follow "After cleaning" instructions on pages 9-10.

Cleaning bare floors

How to attach bare floor attachment

Disconnect deep cleaner from electrical outlet.

To prevent possible leaking, remove clean solution tank and recovery tank before positioning bare attachment.

Refer to Fig. 28 to remove clean solution tank. Set tank aside (do not set tank on furniture).

Refer to Fig. 35 to remove recovery tank.

With handle in upright position, tilt cleaner back so that handle rests on the floor.

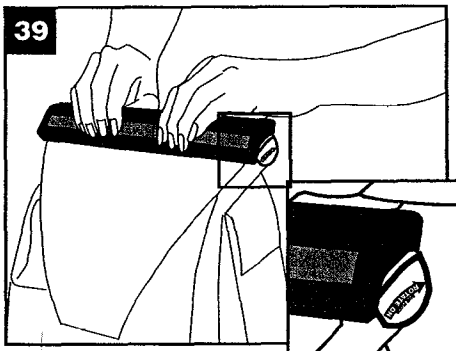

 With foam strip (A) (located under the netting) in position as shown, place attachment on front of nozzle (B). Make sure arrow on end of attachment points in the direction as shown.

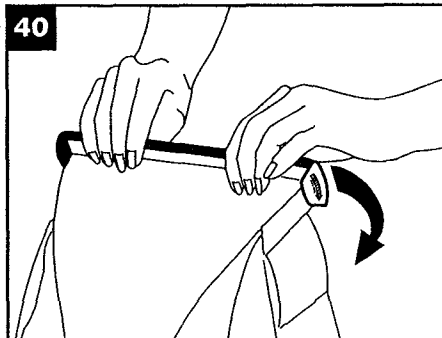

 Push attachment against nozzle while rotating attachment downward until both ends snap into place.

(Note: Some force may be required to rotate and snap attachment into place.)

Return deep cleaner to upright position. Lower handle and replace recovery tank.

Raise handle to upright position and reposition clean solution tank.

To clean floor

Read **Before you begin cleaning** instructions on page 9.

Do not use the SteamVac deep cleaner on hardwood floors.

Fill clean solution tank with HOOVER Bare Floor Cleaner according to instructions on pages 7 and 8.

Do not use any type of wax with your SteamVac deep cleaner.

Move speed selector to the **Lo** or **HI** position for scrubbing or **OFF** if scrubbing is not desired.

Dry hands and plug deep cleaner into a properly grounded outlet.

Step on handle release pedal and lower handle to operating position; turn deep cleaner ON.

To release solution, press trigger. Slowly move deep cleaner forward and backward over area to be cleaned.

To pick up dirty solution, release trigger and slowly move deep cleaner over area where solution has just been dispersed. Use both forward and reverse strokes.

Empty recovery tank when the motor sound becomes higher pitched and there is a loss in suction (see "Automatic shut-off", page 7)

When finished cleaning, follow "After cleaning" instructions on pages 9-10.

Remove attachment from nozzle and rinse in clear water. **Do not remove plastic screen or foam from attachment.**

Using the tools

The powered hand tool (Ultra models) has rotating brushes for extra scrubbing action on small carpet areas, carpeted stairs and upholstery.

The stair/upholstery nozzle has a built-in brush to help provide the scrubbing action some spots may need for removal.

The car cleaning tool (Plus models) can be used for carpet and upholstery in vehicles.

How to attach tool

Disconnect deep cleaner from electrical outlet.

Place handle in upright position and remove hose from rack.

Connect powered hand tool (A) or stair/upholstery nozzle or car cleaning tool (B) to end of hose by sliding it onto connector until the tab (C) locks it securely.

Using your thumb, push forward and up on the latch (D) to remove tool as shown.

Follow the instructions on pages 11-12 for the appropriate cleaning task.

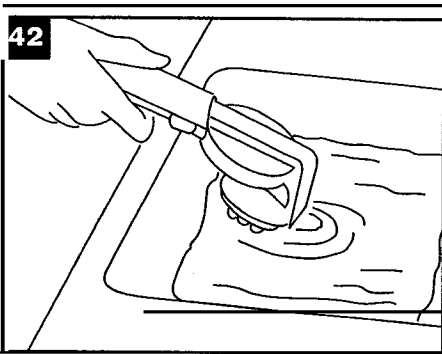
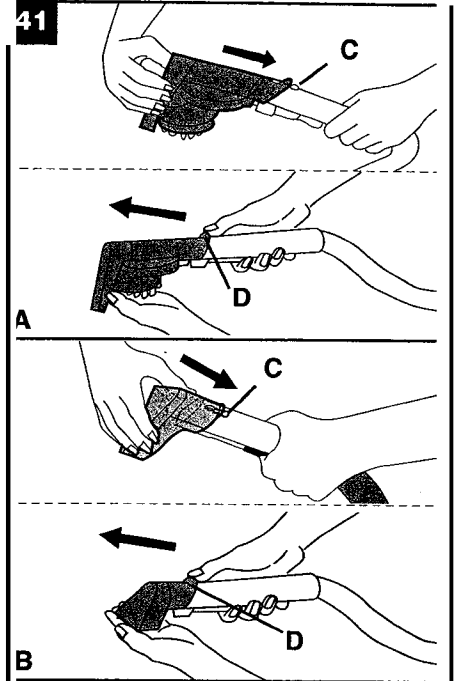

After using tool

1. Follow steps a and b for "After cleaning" on page 9.

2. Rinse tool and hose by filling sink with a small amount of water. Turn deep cleaner ON and pickup the water with the tool.

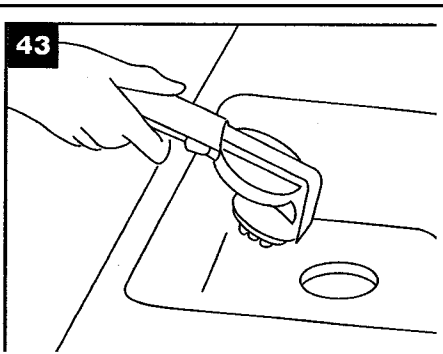

3. Drain hose by turning deep cleaner ON and holding end of hose up for several seconds. Do not press trigger.

4. Disconnect deep cleaner from electrical outlet.

5. Drain solution tube (located inside hose) by pointing end of hose in sink and pressing trigger.

6. Proceed with steps c, d, and e, for "After cleaning" on page 9.

Cleaning carpeted stairs

Read "Before you begin cleaning" instructions on page 9.

Place handle in upright position. **Agitator brushes will not rotate while handle is in upright position.**

Fill clean solution tank with HOOVER Carpet/Upholstery Detergent according to instructions on pages 7 and 8. Attach tool to end of hose.

Hose length may require that machine be placed at the top of the stairs to clean upper half of stairway and at bottom of stairs to clean lower half.

To prevent machine from falling, use extra caution when cleaning on stairs.

Do not place deep cleaner on stairs.

Do not point tools toward people or pets. Dry hands and plug deep cleaner into a properly grounded outlet.

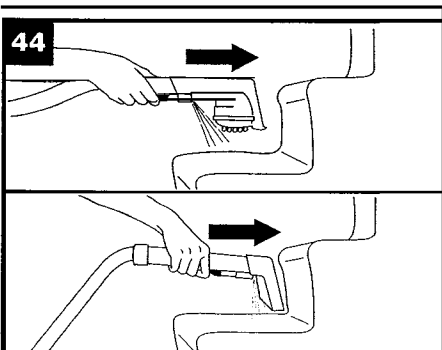

Turn deep cleaner ON.

Pre-spray the carpeted stair by holding the tool (A) or (B) about one inch above the carpet and push it forward while pressing the trigger (equals one wet stroke).

Position tool against the riser and slightly press it into carpet pile. Press the trigger and pull the tool **slowly** over the carpet (second wet stroke). Release trigger at end of stroke.

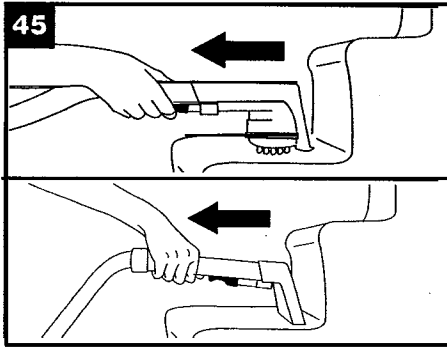

45 Lift tool, and position it against riser. Pull tool **slowly** over carpet without pressing trigger (dry stroke).

It is best to alternate wet and dry strokes as described above. End with more dry strokes to aid in faster drying of carpet.

Overlap strokes by 1/2 inch to help prevent streaking.

To avoid saturating carpet, do not use more than 4 wet strokes over any one area. Always end with dry strokes.

If additional cleaning is necessary, wait until the carpet is completely dry before using the tool again.

Empty recovery tank when the motor sound becomes higher pitched and there is a loss in suction (see "Automatic shut-off", page 7)

When finished cleaning, follow "After cleaning" instructions on page 9 and "After using tool" instructions on page 11.

Cleaning upholstery and automobile interiors

Read "Before you begin cleaning" Instructions on page 9.

Be sure to check the cleaning code on your upholstery. **Use your HOOVER 'SteamVac' deep cleaner only on upholstery marked "W" or "W/S".**

Place handle in upright position. **Agitator brushes will not rotate while handle is in upright position.**

Fill clean solution tank with HOOVER Carpet/Upholstery Detergent according to instructions on pages 7 and 8. Attach tool to end of hose.

Do not point tools toward people or pets.

Dry hands and plug deep cleaner into a properly grounded outlet.

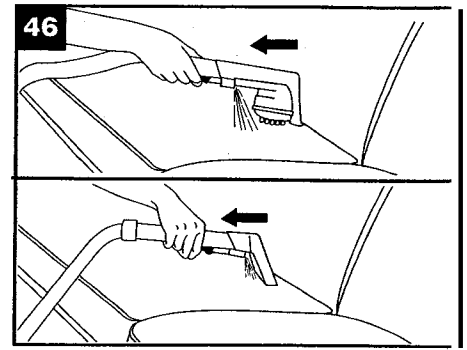

Turn deep cleaner on.

Gently press the tool (A) or (B) onto the fabric. Press the trigger and slowly pull the nozzle over the fabric.

Overlap strokes by 1/2 inch to help prevent streaking.

Make additional strokes without pressing the trigger to remove more moisture.

To clean in corners or creases, lift the tool one-half inch from the fabric and press the solution trigger.

Vacuum up the solution with the tool without pressing the trigger.

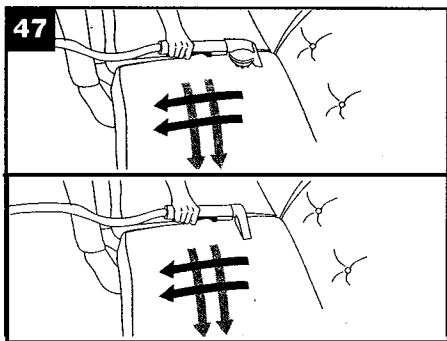

For heavily soiled areas, it may be necessary to repeat the cleaning process. Make crisscrossing strokes to the original pattern; overlap each pass.

Make no more than 2 passes with the solution over any one area to prevent over-wetting and damage to fabric.

If additional cleaning is necessary, wait until the upholstery is completely dry before using the tool again.

Empty recovery tank when the motor sound becomes higher pitched and there is a loss in suction (see "Automatic shut-off", page 7).

When finished cleaning, follow "After cleaning" instructions on page 9 and "After using tool" instructions on page 11.

Storage

Before storing:

- Empty solution tank and rinse thoroughly with clean water.
- Replace **empty** solution tank and turn deep cleaner ON. Squeeze trigger and push deep cleaner forward and back several times to expel any solution remaining in the deep cleaner's system. (Do not use deep cleaner on wood floors.)
- Empty recovery tank and rinse thoroughly with clean water.

Allow brushes and underside of deep cleaner to air dry thoroughly before storing deep cleaner on a carpeted or wood surface.

Do not store deep cleaner with a full solution tank in place.

Lubrication

The motor is equipped with bearings which contain sufficient lubrication for the life of the motor. The addition of lubricant could cause damage. **Do not add lubricant to motor bearings.**

Service

To obtain approved HOOVER service and genuine HOOVER parts, locate the nearest **Hoover Factory Service Center or Authorized Hoover Warranty Service Dealer (Depot)** by:

- checking the Yellow Pages under Vacuum Cleaners - Household" OR
- checking the list of Factory Service Centers provided with this cleaner OR -
- calling 1-800-944-9200 for an automated referral of authorized service outlet locations (U.S. only) OR-
- checking the Service section of The Hoover Company on-line at www.hoovercompany.com

Do not send your cleaner to The Hoover Company in North Canton for service, this will only result in delay.

If further assistance is needed, contact The Hoover Company Consumer Response Center, North Canton, Ohio 44720 Phone: 330-499-9499.

In Canada, contact Hoover Canada, Burlington, Ontario L7R 4A8, Phone: 1-800-263-6376.

Always identify your cleaner by the **complete** model number when requesting information or ordering parts. (The model number appears on the bottom of the cleaner.)

If you have a problem

If a minor problem occurs, it usually can be solved quite easily when the cause is found by using the check list below.

Problem: Machine won't run

Possible cause

Possible solution

- Not firmly plugged in
- Plug unit in firmly
- No voltage in wall plug
- Check fuse or breaker
- Blown fuse/tripped breaker
- Replace fuse/reset breaker

Problem: Low suction

Possible cause

Possible solution

- Recovery tank full/automatic shut off engaged
- Remove and empty recovery tank
- Blockage in tool on end of hose
- Remove tool and clear blockage
- Recovery tank lid not on correctly
- Make sure lid is on securely

Problem: Clean solution won't dispense

Possible cause

Possible solution

- Solution tank not firmly in place
- Make sure tank is securely locked in position
- Solution tank empty
- Refill tank according to instructions for surface being cleaned
- Recovery tank lid not on correctly
- Make sure lid is firmly in place

Problem: Brushes/brush indicator won't rotate during floor cleaning

Possible cause

Possible solution

- Indicator screen dirty
- Remove clear cover over indicator and clean screen; replace cover
- Speed selector on OFF
- Move speed selector to Low or Hi

Full One Year Warranty (Domestic Use)

Your HOOVER® appliance is warranted in normal household use, in accordance with the Owner's Manual against original defects in material and workmanship for a period of one full year from date of purchase. This warranty provides, at no cost to you, all labor and parts to place this appliance in correct operating condition during the warranted period. This warranty applies when the appliance is purchased in the United States including its territories and possessions, or in Canada or from a U. S. Military Exchange. Appliances purchased elsewhere are covered by a limited one year warranty which covers the cost of parts only. This warranty does not apply if the appliance is used in a commercial or rental application.

Warranty service can only be obtained by presenting the appliance to one of the following authorized warranty service outlets. Proof of purchase will be required before service is rendered.

1. Hoover Factory Service Centers.
2. Hoover Authorized Warranty Service Dealers (Depots).

For an automated referral of authorized service outlets in the U.S.A., phone 1-800-944-9200 OR

visit The Hoover Company on-line at www.hoovercompany.com

This warranty does not cover pick up delivery, or house calls; however, if you mail your appliance to a Hoover Factory Service Center for warranty service, transportation will be paid one way.





While this warranty gives you specific legal rights, you may also have other rights which vary from state to state.

If further assistance is needed, or if there are questions concerning this warranty or the availability of warranty service outlets, write or phone the Consumer Response Center, The Hoover Company, 101 East Maple St., North Canton, Ohio 44720. Phone 1-330-499-9499.

In Canada, contact Hoover Canada, Burlington, Ontario L7R 4A8, 1-800-263-6376.

Detach Order Form Here

Part No. 58549-022 (R1)

ACCESSORIES / PART NUMBER		PRICE EACH	QTY.	TOTAL
Carpet / Upholstery Detergent 64 oz. 40301064		\$12.99		
PreCleaner 16 oz. 40302016		\$5.99		
Bare Floor Cleaner 32 oz. 40303032		\$5.99		
Bare Floor Cleaning Tool 48417001		\$5.99		
Nozzle Clean-out Tool 39514001		\$1.00		
TOTAL MERCHANDISE \$				
ADD YOUR APPLICABLE STATE TAX +				
SHIPPING & HANDLING +				\$4.50
TOTAL COST \$				

Use this form to order HOOVER detergents and accessories directly from THE HOOVER COMPANY, NORTH CANTON, OHIO. These items will be shipped to your home freight prepaid. They may also be purchased from your local Hoover dealer or Hoover Factory Service Center. See your Yellow Pages for listings.

Please detach order form and enclose with your check, money order, or credit card information.
Mail-in orders limited to U.S. residents only.

PAYMENT METHOD:

Check or Money Order payable to: The Hoover Company
 Visa MasterCard Exp. Date: _____
 Card Number _____
 Name on Card _____
 Signature (Required) _____
 Daytime Phone & Area Code _____

The Hoover Company
 101 East Maple Street
 North Canton, OH 44720

- 40301064
- 40302016
- 40303032
- 48417001
- 39514001

No. of Items Ordered:

SHIP TO:

Name _____
 Street _____
 City _____ State _____ Zip _____

Please Print Your Name and Address carefully in Ink.
Please allow 3 to 4 weeks for delivery.
Please complete this entire form!