



DVD RECORDER/ VIDEO CASSETTE RECORDER

OWNER'S MANUAL

MODEL: RC897T

Before connecting, operating or adjusting this product,
please read this owner's manual carefully and completely.

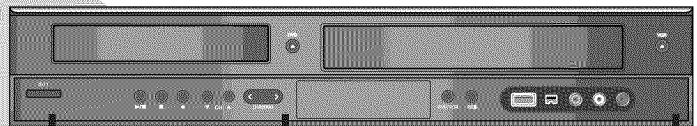

The Clear Choice in Digital Video*



Call us and we will
guide you through your
first recording, for free.

1-800-243-0000

(<http://us.lgservice.com>)



CAUTION: TO REDUCE THE RISK OF ELECTRIC SHOCK DO NOT REMOVE COVER (OR BACK) NO USER-SERVICEABLE PARTS INSIDE REFER SERVICING TO QUALIFIED SERVICE PERSONNEL.



This lightning flash with arrowhead symbol within an equilateral triangle is intended to alert the user to the presence of uninsulated dangerous voltage within the product's enclosure that may be of sufficient magnitude to constitute a risk of electric shock to persons.



The exclamation point within an equilateral triangle is intended to alert the user to the presence of important operating and maintenance (servicing) instructions in the literature accompanying the product.

WARNING: TO PREVENT FIRE OR ELECTRIC SHOCK HAZARD, DO NOT EXPOSE THIS PRODUCT TO RAIN OR MOISTURE.

WARNING: Do not install this equipment in a confined space such as a book case or similar unit.

CAUTION:

Do not block any ventilation openings. Install in accordance with the manufacturer's instructions.

Slots and openings in the cabinet are provided for ventilation and to ensure reliable operation of the product and to protect it from over heating.

The openings should never be blocked by placing the product on a bed, sofa, rug or other similar surface. This product should not be placed in a built-in installation such as a book-case or rack unless proper ventilation is provided or the manufacturer's instruction have been adhered to.

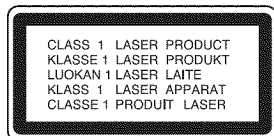

CAUTION: CLASS 3B VISIBLE AND INVISIBLE LASER RADIATION WHEN OPEN AND INTERLOCKS DEFEATED. AVOID EXPOSURE TO THE BEAM.

CAUTION:

This product employs a Laser System. To ensure proper use of this product, please read this owner's manual carefully and retain it for future reference. Should the unit require maintenance, contact an authorized service center.

Performing controls, adjustments, or carrying out procedures other than those specified herein may result in hazardous radiation exposure.

To prevent direct exposure to laser beam, do not try to open the enclosure. Visible laser radiation when open. **DO NOT STARE INTO BEAM.**

CAUTION: The apparatus should not be exposed to water (dripping or splashing) and no objects filled with liquids, such as vases, should be placed on the apparatus.

CAUTION concerning the Power Cord

Most appliances recommend they be placed upon a dedicated circuit;

That is, a single outlet circuit which powers only that appliance and has no additional outlets or branch circuits. Check the specification page of this owner's manual to be certain. Do not overload wall outlets. Overloaded wall outlets, loose or damaged wall outlets, extension cords, frayed power cords, or damaged or cracked wire insulation are dangerous. Any of these conditions could result in electric shock or fire.

Periodically examine the cord of your appliance, and if its appearance indicates damage or deterioration, unplug it, discontinue use of the appliance, and have the cord replaced with an exact replacement part by an authorized servicer.

Protect the power cord from physical or mechanical abuse, such as being twisted, kinked, pinched, closed in a door, or walked upon. Pay particular attention to plugs, wall outlets, and the point where the cord exits the appliance.

To disconnect power from the unit, unplug the unit from the outlet. When installing the product, ensure that the plug is easily accessible.

FCC WARNING: This equipment may generate or use radio frequency energy. Changes or modifications to this equipment may cause harmful interference unless the modifications are expressly approved in the instruction manual. The user could lose the authority to operate this equipment if an unauthorized change or modification is made.

REGULATORY INFORMATION: FCC Part 15

This equipment has been tested and found to comply with the limits for a Class B digital device, pursuant to Part 15 of the FCC Rules.

These limits are designed to provide reasonable protection against harmful interference in a residential installation. This equipment generates, uses and can radiate radio frequency energy and, if not installed and used in accordance with the instructions, may cause harmful interference to radio communications.

However, there is no guarantee that interference will not occur in a particular installation. If this equipment does cause harmful interference to radio or television reception, which can be determined by turning the equipment off and on, the user is encouraged to try to correct the interference by one or more of the following measures:

- Reorient or relocate the receiving antenna.
- Increase the separation between the equipment and receiver.
- Connect the equipment into an outlet on a circuit different from that to which the receiver is connected.
- Consult the dealer or an experienced radio/TV technician for help.

FCC COMPLIANCE: The responsible party for this product's compliance is:

LG Electronics U.S.A., Inc., 1000 Sylvan Avenue, Englewood Cliffs, NJ.

Phone: 1-201-816-2000.

IMPORTANT SAFETY INSTRUCTIONS

1. Read these instructions.
2. Keep these instructions.
3. Heed all warnings.
4. Follow all instructions.
5. Do not use this apparatus near water.
6. Clean only with dry cloth.
7. Do not block any ventilation openings. Install in accordance with the manufacturer's instructions.
8. Do not install near any heat sources such as radiators, heat registers, stoves, or other apparatus (including amplifiers) that produce heat.
9. Do not defeat the safety purpose of the polarized or grounding-type plug. A polarized plug has two blades with one wider than the other. A grounding type plug has two blades and a third grounding prong. The wide blade or the third prong are provided for your safety. If the provided plug does not fit into your outlet, consult an electrician for replacement of the obsolete outlet.
10. Protect the power cord from being walked on or pinched particularly at plugs, convenience receptacles, and the point where they exit from the apparatus.
11. Only use attachments/accessories specified by the manufacturer.
12. Use only with the cart, stand, tripod, bracket, or table specified by the manufacturer, or sold with the apparatus. When a cart is used, use caution when moving the cart/apparatus combination to avoid injury from tip-over.



13. Unplug this apparatus during lightning storms or when unused for long periods of time.
14. Refer all servicing to qualified service personnel. Servicing is required when the apparatus has been damaged in any way, such as power-supply cord or plug is damaged, liquid has been spilled or objects have fallen into the apparatus, the apparatus has been exposed to rain or moisture, does not operate normally, or has been dropped.

Copyrights

- Recording equipment should be used only for lawful copying and you are advised to check carefully what is lawful copying in the area in which you are making a copy. Copying of copyright material such as films or music is unlawful unless permitted by a legal exception or consented to by the rights owner.
- This product incorporates copyright protection technology that is protected by method claims of certain U.S. patents and other intellectual property rights owned by Macrovision Corporation and other rights owners. Use of this copyright protection technology must be authorized by Macrovision Corporation, and is intended for home and other limited viewing uses only, unless otherwise authorized by Macrovision Corporation. Reverse engineering or disassembly is prohibited.
- CONSUMERS SHOULD NOTE THAT NOT ALL HIGH DEFINITION TELEVISION SETS ARE FULLY COMPATIBLE WITH THIS PRODUCT AND MAY CAUSE ARTIFACTS TO BE DISPLAYED IN THE PICTURE. IN CASE OF 525 PROGRESSIVE SCAN PICTURE PROBLEMS, IT IS RECOMMENDED THAT THE USER SWITCH THE CONNECTION TO THE 'STANDARD DEFINITION' OUTPUT. IF THERE ARE QUESTIONS REGARDING YOUR TV SET COMPATIBILITY WITH THIS MODEL 525p DVD+VCR RECORDER, PLEASE CONTACT OUR CUSTOMER SERVICE CENTER.

Manufactured under license from Dolby Laboratories. Dolby and the double-D symbol are registered trademarks of Dolby Laboratories.

Table of contents

INTRODUCTION

| | |
|----------------------------------|------|
| Symbol Used in this Manual | .5 |
| Notes on Discs | .5 |
| Moisture Condensation | .5 |
| Recordable and Playable Discs | .6-7 |
| Recommended recordable DVD discs | .6 |
| Regional Code | .6 |
| Playable Discs | .7 |

CONNECTION AND SETTING

| | |
|--|-----|
| Connecting an Antenna or Cable TV | .8 |
| Connections to your TV (Composite) | .9 |
| Connections to your TV (HDMI) | .10 |
| Connections to your TV (Component) | .11 |
| Connections to your TV (S-Video) | .12 |
| Controlling Your TV with the Supplied Multi-brand Remote Control | .13 |
| Connection to an Amplifier | .14 |
| Accessory Audio/Video (A/V) Connections to Recorder | .15 |
| Connecting a Digital Camcorder | .15 |
| Connecting the IR control cable | .16 |
| Initial Setup Wizard | .17 |
| Using the Home Menu | .18 |

TV VIEWING

| | |
|--|-----|
| Channel Selection | .19 |
| Channel Selection with Channel List menu | .19 |
| General Explanation of On-Screen Display | .20 |
| Displaying Information While Watching TV | .20 |
| Displaying Disc Information on-screen | .20 |

DVD PLAYBACK

| | |
|--------------------------------------|--------|
| Playing a DVD | .21 |
| DVD Playback Options | .22-23 |
| Special Playback Options | .24 |
| Playing an Audio CD or MP3/WMA files | .25 |
| Viewing a JPEG files | .26-27 |
| Playing a MPEG4 Movie File | .28 |

DVD RECORDING

| | |
|--|-----|
| DVD recording | .29 |
| Notes for recording | .29 |
| Recording time and picture quality | .29 |
| Restrictions on video recording | .29 |
| Basic Recording from a TV | .30 |
| Instant Timer Recording | .30 |
| Timer Recording | .31 |
| AV1 Timer Recording using Set-Top Channel option | .32 |
| Playing while you are recording | .33 |
| Recording from External Components | .33 |

DVD EDITING

| | |
|---|-----|
| Title List and Chapter List Menu Overview | .34 |
| VR Mode: Original and Playlist Editing | .35 |
| Adding Chapter Markers | .35 |
| Changing the Title Thumbnails | .35 |
| Making a New Playlist | .36 |

| | |
|---|-----|
| Adding Additional Title/Chapters to the Playlist | .36 |
| Deleting an Original or Playlist Title/Chapter | .37 |
| Deleting a Part | .37 |
| Naming a Title | .38 |
| Time Search | .38 |
| Moving a Playlist Chapter | .39 |
| Hide a Chapter/Title | .39 |
| Protect a Title | .39 |
| Divide One Titles Into Two | .40 |
| Combining Two Chapters Into One | .40 |
| Overwriting Recording | .41 |
| Viewing Title List menu displayed on other DVD Recorders or Players | .41 |
| Playing Your Recordings on Other DVD Players (Finalizing a Disc) | .41 |

VCR PLAYBACK

| | |
|----------------------|-----|
| Playing a Tape | .42 |
| VCR Playback Options | .43 |

VCR RECORDING

| | |
|--|-----|
| VCR recording | .44 |
| Basic Recording from a TV | .44 |
| Instant Timer Recording | .44 |
| Timer Recording | .45 |
| AV1 Timer Recording using Set-Top Channel option | .46 |
| Recording from External Components | .47 |

DUBBING

| | |
|-------------------------|-----|
| Dubbing from DVD to VCR | .48 |
| Dubbing from VCR to DVD | .48 |
| Recording from DV Input | .49 |

SETTINGS AND ADJUSTMENTS

| | |
|----------------------------------|--------|
| Initial Settings | .50 |
| General Settings | .51 |
| Language Settings | .52 |
| Audio Settings | .53 |
| Lock (Parental Control) Settings | .53-55 |
| Recording Settings | .56-57 |
| Disc Settings | .58 |

REFERENCE

| | |
|-----------------------------|-------------|
| Remote Control | .59 |
| Front Panel | .60 |
| Rear Panel | .61 |
| Using an USB Flash Drive | .62 |
| Language Code List | .63 |
| Area Codes List | .63 |
| DVD Audio/Subtitle Language | .64 |
| Troubleshooting | .65-67 |
| Error Message | .68 |
| Glossary | .69-70 |
| Specifications | .71-72 |
| Index | .73-74 |
| Warranty | .Rear Cover |

Introduction

To ensure proper use of this product, please read this owner's manual carefully and retain for future reference.

Symbol Used in this Manual

Note Indicates special notes and operating features.

Tip Indicates tips and hints for making the task easier.

Caution Indicates hazards likely to cause harm to the unit itself or other material damage.

A section whose title has one of the following symbols are applicable only to those discs represented by the symbol.

| Icon | Meaning |
|----------------------------|----------------------------------|
| DVD ALL | All DVD discs listed below. |
| -RW_{VR} | DVD-RW with VR recording mode |
| -RW_{Video} | DVD-RW with Video recording mode |
| RAM | DVD-RAM disc |
| +RW | DVD+RW disc |
| -R | DVD-R disc |
| +R | DVD+R (DL) disc |
| DVD | DVD-Video disc |
| ACD | Audio CDs |
| MP3 | MP3 files |
| WMA | WMA files |
| JPEG | JPEG files |
| VCR | Video Tape |
| MPEG4 | MPEG4 files |

Notes on Discs

Handling Discs

Do not touch the playback side of the disc. Hold the disc by the edges so that fingerprints do not get on the surface. Never stick paper or tape on the disc.

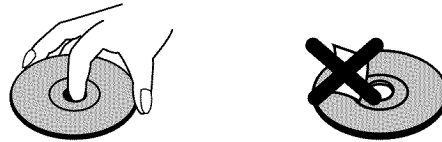

Storing Discs

After playing, store the disc in its case. Do not expose the disc to direct sunlight or sources of heat and never leave it in a parked car exposed to direct sunlight.

Cleaning Discs

Fingerprints and dust on the disc can cause poor picture quality and sound distortion. Before playing, clean the disc with a clean cloth. Wipe the disc from the center out.

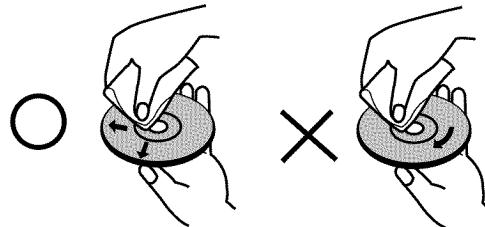













Do not use strong solvents such as alcohol, benzene, thinner, commercially available cleaners, or anti-static spray intended for older vinyl records.

Moisture Condensation

Never operate this product immediately after moving it from a cold location to a warm location. Leave it for two or three hours without operating it. If you use this product in such a situation, it may damage discs/tapes and internal parts.

Recordable and Playable Discs

| Disc Type | Disc Logo | Icon used in this manual | Formatting (new discs) | Compatibility with other DVD Players (finalizing) | Recording Features | |
|-------------------|--|---|--|---|------------------------------|--------------|
| | | | | | Re-writable (Initialization) | Auto Chapter |
| DVD+R DVD+R DL |   |  | Automatically formatted | Playable on DVD+R compatible players. (Finalization necessary) | No | Yes |
| DVD-R Video Mode |  |  | Automatically formatted in Video Mode. | Playable on most DVD Players (Finalization necessary) | No | Yes |
| DVD+RW |  |  | Automatically formatted | Playable on DVD+RW compatible players.(Finalization recommended*5) | Yes | Yes |
| DVD-RW | VR Mode  |  | Manual format in VR mode using "Setup" | Playable only on VR mode compatible players(Finalization unnecessary) | Yes | Yes |
| | Video Mode  |  | Automatically formatted in Video Mode. | Playable on most DVD Players (Finalization necessary) | Yes | Yes |
| DVD-RAM VR Mode |  |  | Automatically formatted in VR Mode. | Playable only on DVD-RAM compatible players. (Finalization unnecessary) | Yes | Yes |

*1 Erasing titles only frees up disc space if you erase the last title.

*2 Erasing titles or chapters frees up disc space.

*3 Erasing titles or chapters does not free up disc space.

*4 "Finalize" is activated only if there is some edited information on the disc (like Hide, Manual Chapter Making...).

*5 Some edited informations are playable on DVD+RW compatible players only after finalization.

*6 Some edited informations may not be compatible on DVD+R compatible players. (Hide, chapter combine, added chapter mark, etc.)

*7 This function cannot operate on special chapters.(first chapter, If two chapters created by erasing a part from an original title, If two chapters created from different titles, If two chapters created by moving an order from an original title, etc..)

Recommended recordable DVD discs

| | DVD-R | DVD-RW | DVD-RAM | DVD+R | DVD+R(DL) | DVD+RW |
|-------------------|--|---|------------------------------|---------------------------------------|----------------------|---|
| Recommended discs | Mitsubishi(8x,16x) Verbatim(8x,16x) | Mitsubishi(4x) Verbatim(4x) JVC(4x) Maxell(4x) | Mitsubishi(3x) Maxell(5x) | Mitsubishi(8,16x) Verbatim(8x,16x) | Mitsubishi(2.4x, 8x) | Mitsubishi(4x) HP(4x) Verbatim(4x) Ricoh(4x) |

Regional Code









This unit has a regional code printed on the rear of the unit. This unit can play only DVD discs labeled same as the rear of the unit or "ALL".

Notes on Regional Codes

- Most DVD discs have a globe with one or more numbers in it clearly visible on the cover. This number must match your unit's regional code or the disc cannot play.
- If you try to play a DVD with a different regional code from the unit, the message "Incorrect region code. Can't play back" appears on the TV screen.

| Recording Features | | | | | | Editing Features | | | | | | | | |
|--------------------|------------|---------------------|-----------------------|-----------------|--------------|------------------|--------------|--------------------------|----------|-----------------|-----------------|-------------------|---------------|--------------|
| Finalize | Unfinalize | Bilingual Recording | Manual Chapter Making | Edit Title Name | Delete Title | Delete Chapter | Divide Title | A-B Delete (Delete part) | Playlist | Combine Chapter | Hide/Show Title | Hide/Show Chapter | Protect Title | Protect Disc |
| Yes | No | No | Yes*6 | Yes | Yes*3 | No | No | No | No | Yes*6 | Yes*6 | Yes*6 | Yes | Yes |
| Yes | No | No | No | Yes | Yes*3 | No | No | No | No | No | No | No | No | No |
| Yes*4 | No | No | Yes | Yes | Yes*1 | No | Yes | No | No | Yes | Yes | Yes | Yes | Yes |
| Yes | Yes | Yes | Yes | Yes | Yes*2 | Yes*2 | No | Yes | Yes | Yes*7 | No | No | Yes | Yes |
| Yes | Yes | No | No | Yes | Yes*1 | No | No | No | No | No | No | No | No | No |
| No | No | Yes | Yes | Yes | Yes*2 | Yes*2 | No | Yes | Yes | Yes*7 | No | No | Yes | Yes |

Playable Discs

| Disc Type | Disc Logo | Icon used in this manual | Characteristics |
|-----------|---|--|---|
| DVD VIDEO |  |  | DVD (8 cm / 12 cm disc) Discs such as movies that can be purchased or rented |
| AUDIO CD |  |  | Audio CD (8 cm / 12 cm disc) Music CDs or CD-Rs/CD-RWs in music CD format that can be purchased |
| DATA DISC |  |     | CD-R/CD-RW/DVD (8 cm / 12 cm disc) CD-R/CD-RW/DVD discs that contain audio titles, MP3, WMA or MPEG4, JPEG files. |

Notes

- Depending on the conditions of the recording equipment or the CD-R/RW (or DVD±R/RW) disc itself, some CD-R/RW (or DVD±R/RW) discs cannot be played on the unit.
- Do not attach any seal or label to either side (the labeled side or the recorded side) of a disc.
- Do not use irregularly shaped CDs (e.g., heart-shaped or octagonal). Doing so may result in malfunctions.
- Depending on the recording software & the finalization, some recorded discs (CD-R/RW or DVD±R/RW) may not be playable.
- DVD-R/RW, DVD+R/RW and CD-R/RW discs recorded using a personal computer or a DVD or CD Recorder may not play if the disc is damaged or dirty, or if there is dirt or condensation on the Recorder's lens.
- If you record a disc using a personal computer, even if it is recorded in a compatible format, there are cases in which it may not play because of the settings of the application software used to create the disc. (Check with the software publisher for more detailed information.)
- This recorder requires discs and recordings to meet certain technical standards in order to achieve optimal playback quality. Pre-recorded DVDs are automatically set to these standards. There are many different types of recordable disc formats (including CD-R containing MP3 or WMA files) and these require certain pre-existing conditions (see above) to ensure compatible playback.
- Customers should note that permission is required in order to download MP3 / WMA files and music from the Internet. Our company has no right to grant such permission. Permission should always be sought from the copyright owner.

Connection and Setting

Depending on your TV and other equipment there are various ways you can connect the recorder. Please refer to the manuals of your TV, VCR, Stereo System or other devices as necessary for additional connection information.

Notes

- Make sure the Recorder is connected directly to the TV and tune the TV to the correct video input channel.
- Do not connect the Recorder's AUDIO OUTPUT jack to the phono in jack (record deck) of your audio system.
- Do not connect the Recorder via another VCR. The DVD image could be distorted by the copy protection system.
- The picture and sound of a nearby TV, VCR, or radio may be distorted during playback. Position the units away from each other or turn off the unit after removing the disc.

Connecting an Antenna or Cable TV

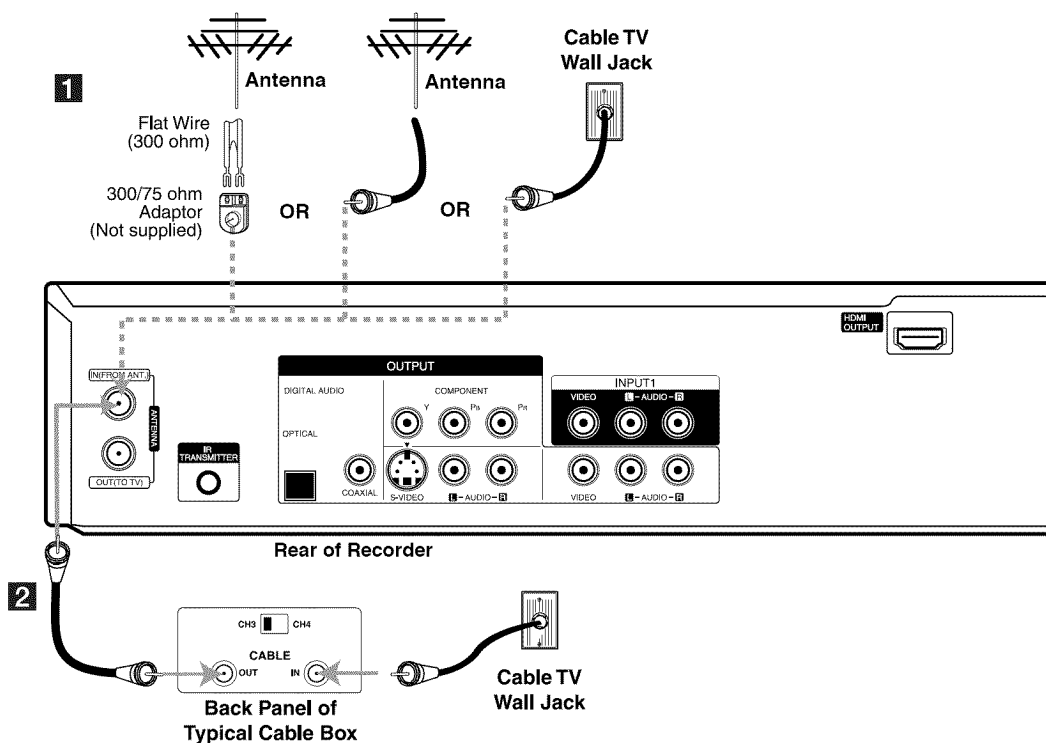

1 Antenna

Connect the Terrestrial TV antenna to the ANTENNA IN jack on the unit. If your antenna cable is flat wire type, use a 300-ohm to 75-ohm antenna adaptor.

2 Cable TV

If a cable box is required for reception the cable channels, connect a coaxial cable from the wall jack to the IN connector on the cable box and a coaxial cable from the OUT connector on the cable box to the ANT. IN on the recorder.

To view or record a CATV channel

1. Tune the TV to the Recorder output channel (CH 3 or 4).
2. Set the Recorder channel selector to the cable output channel. (Example: CH3)
3. Select a channel using the cable converter.

Notes

- With this connection, you cannot record one program while viewing another.
- If you are using a cable box to tune channels, it is not necessary to do Auto Channel Set.

Connections to your TV (Composite)

Make one of the following connections, depending on the capabilities of your TV.

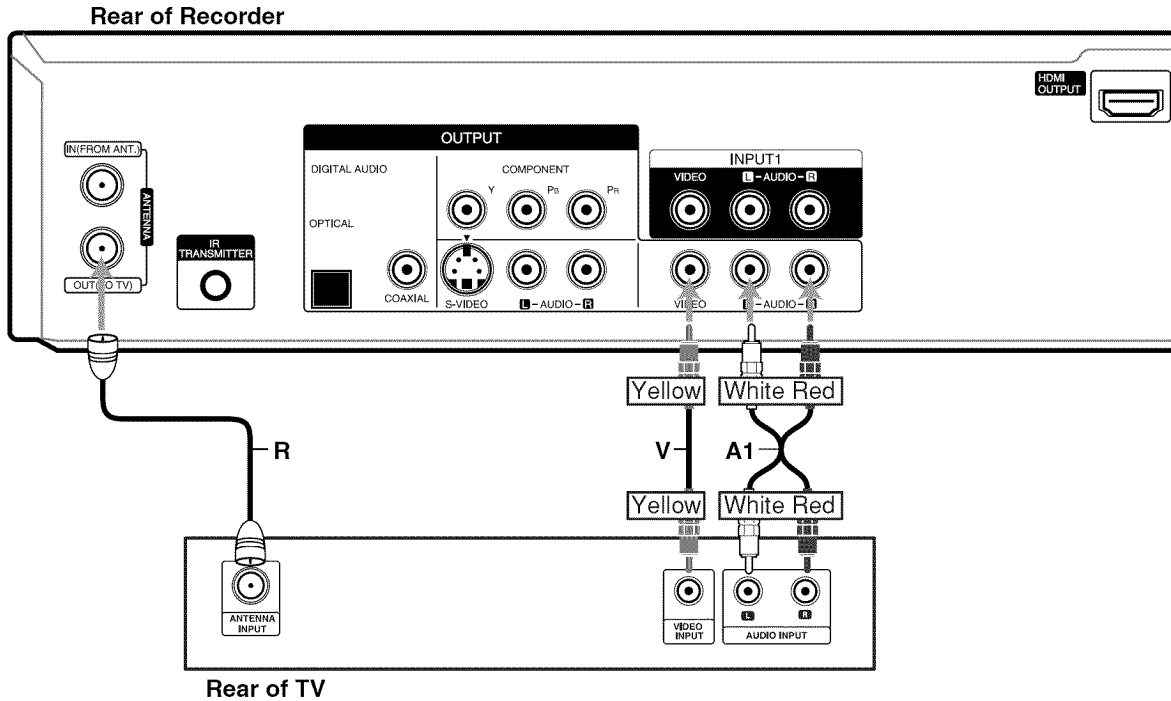

RF coaxial connection

Connect the ANTENNA OUT jack on the Recorder to the antenna in jack on the TV using the supplied 75-ohm Coaxial Cable (R).

Note

This model do not have RF modulated output function RF CH3, or CH4.
You cannot watch this recorder with TV tuner.

Video connection

Connect the VIDEO OUTPUT jack on the Recorder to the video in jack on the TV using the video cable supplied (V).

Note

If you use this connection, set the TV's source selector to VIDEO.

Audio connection

Connect the Left and Right AUDIO OUTPUT jacks on the Recorder to the audio left/right in jacks on the TV using the supplied audio cables (A1).

Connections to your TV (HDMI)

If you have a HDMI TV or monitor, you can connect it to this recorder using a HDMI cable.

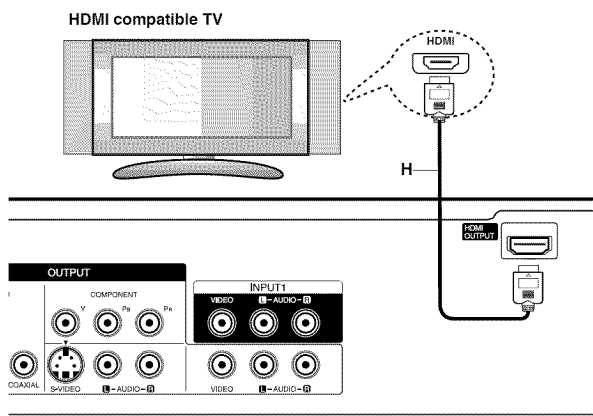

1. Connect the HDMI OUTPUT jack on the recorder to the HDMI INPUT jack on a HDMI compatible TV or monitor (H).
2. Set the TV's source to HDMI (refer to TV's Owner's manual).

Notes

- If your TV is NOT capable of handling 96 kHz sampling frequency, set the [Sampling Freq.] option to [48 kHz] on the setup menu (See page 53). When this choice is made, this unit will automatically convert any 96 kHz signals to 48 kHz so your system can decode them.
- If your TV is not equipped with Dolby Digital and MPEG decoder, set the [Dolby Digital] and [MPEG] options to [PCM] on the setup menu (See page 53).
- If your TV is not equipped with DTS decoder, set the [DTS] options to [OFF] on the setup menu (See page 53). To enjoy DTS multi channel surround, you must connect this recorder to a DTS compatible receiver via one of this recorder's digital audio outputs.
- The arrow on the cable connector body should face up for correct alignment with the connector on the recorder.

(Type A)

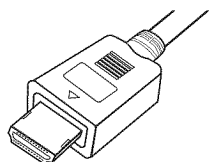

- If there is noise or lines on the screen, please check the HDMI cable.

Tip

When you use HDMI connection, you can change the resolution (480i, 480p, 720p, 1080i or 1080p) for the HDMI output using RES. button on the front panel.

Caution

- Changing the resolution when the recorder is connected with HDMI connector may result in malfunctions. To solve the problem, turn off the recorder and then turn it on again.
- If your TV does not accept your resolution setting, abnormal picture appears on the screen. Please read TV's owner's manual then set the resolution that your TV can accept.

HDMI, the HDMI logo and High-Definition Multimedia Interface are trademarks or registered trademarks of HDMI licensing LLC.

Additional Information for HDMI

- When you connect a HDMI or DVI compatible device make sure of the followings:
 - Try switching off the HDMI/DVI device and this recorder. Next, switch on the HDMI/DVI device and leave it for around 30 seconds, then switch on this recorder.
 - The connected device's video input is set correctly for this unit.
 - The connected device is compatible with 720(1440)x480i, 720x480p, 1280x720p, 1920x1080i or 1920x1080p video input.
- Not all HDCP-compatible DVI devices will work with this recorder.
 - It's impossible copy protected-DVD title's playback in non-HDCP devices.
- For best performance, directly connect the HDMI output to an HDMI input on your TV. If connecting to some device other than a TV or monitor, such as a home theater receiver with an HDMI input, check the following to make sure the HDMI signal will be received correctly:
 - Check the operating instructions of the connected device to make sure that the HDMI input of the device complies with HDMI-HDCP specifications.
 - Check that the HDMI setup menu of any non-display device is set to "pass-through" so that HDMI signals received are not changed in any way (such as changing the video or audio format).

Connections to your TV (Component)

Make one of the following connections, depending on the capabilities of your TV.

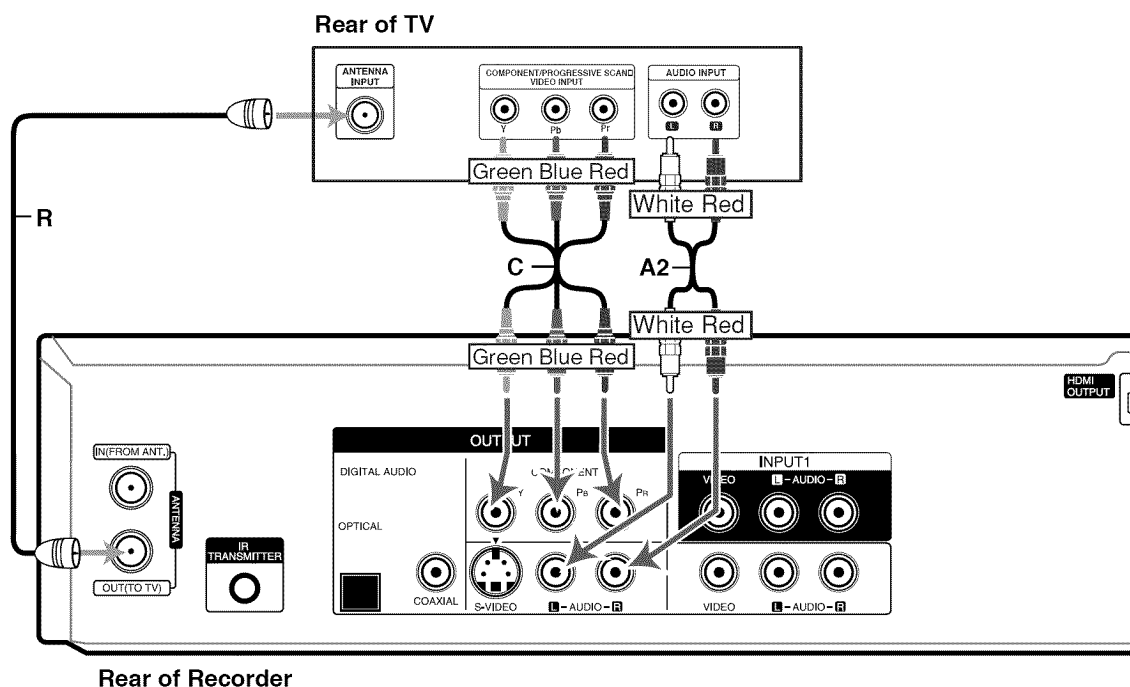

RF coaxial connection

Connect the ANTENNA OUT jack on the Recorder to the antenna in jack on the TV using the supplied 75-ohm Coaxial Cable (**R**).

Component Video connection

If your television is a high-definition or “digital ready” television, you may take advantage of the Recorder’s progressive scan output for the highest video resolution possible.

Connect the COMPONENT OUTPUT jacks on the Recorder to the corresponding in jacks on the TV using an optional Y Pb Pr cable (**C**).

Notes

- Set the resolution to 480p using RES. button on the front panel for progressive signal.
- Progressive Scan does not work with the RF, Video or S-Video connections.
- If your TV does not accept the Progressive Scan format, the picture will appear scrambled.

Audio connection

Connect the Left and Right AUDIO OUTPUT jacks on the Recorder to the audio left/right in jacks on the TV using the supplied audio cables (**A2**).

Connections to your TV (S-Video)

Make one of the following connections, depending on the capabilities of your TV.

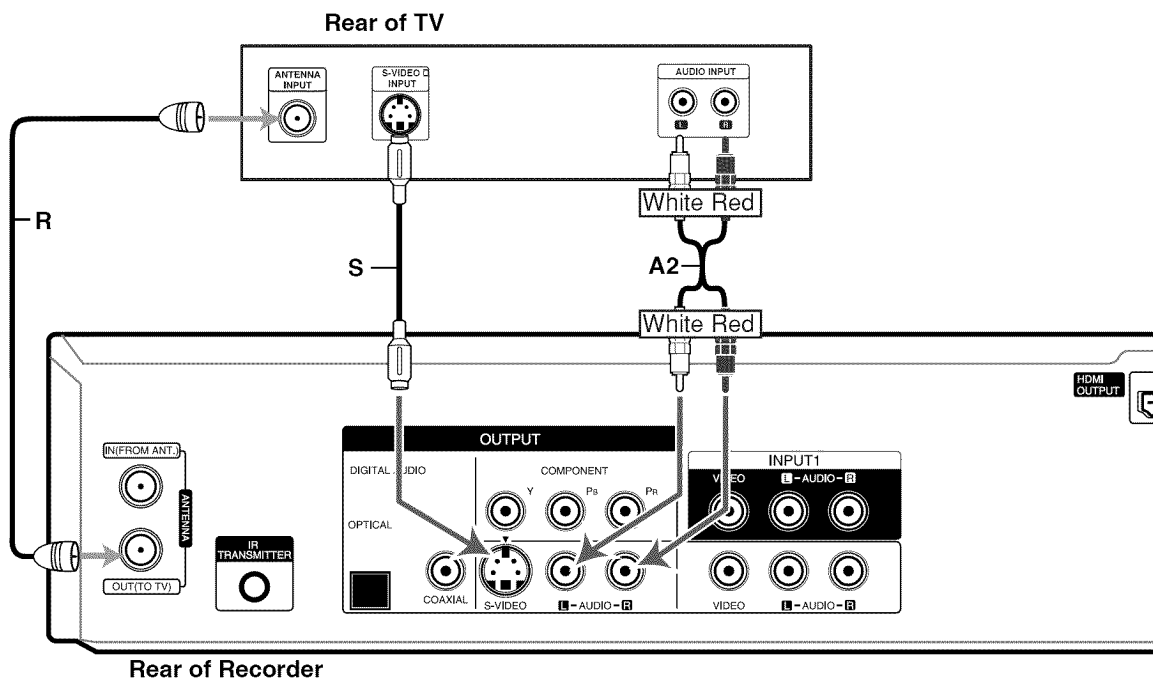

RF coaxial connection

Connect the ANTENNA OUT jack on the Recorder to the antenna in jack on the TV using the supplied 75-ohm Coaxial Cable (**R**).

S-Video connection

Connect the S-VIDEO OUTPUT jack on the Recorder to the S-Video in jack on the TV using the optional S-Video cable (**S**).

Audio connection

Connect the Left and Right AUDIO OUTPUT jacks on the Recorder to the audio left/right in jacks on the TV using the supplied audio cables (**A2**).

Controlling Your TV with the Supplied Multi-brand Remote Control

You can control the sound level, input source, and power switch of your LG TV with the supplied Multi-brand Remote Control.

You can control your TV using the buttons below.

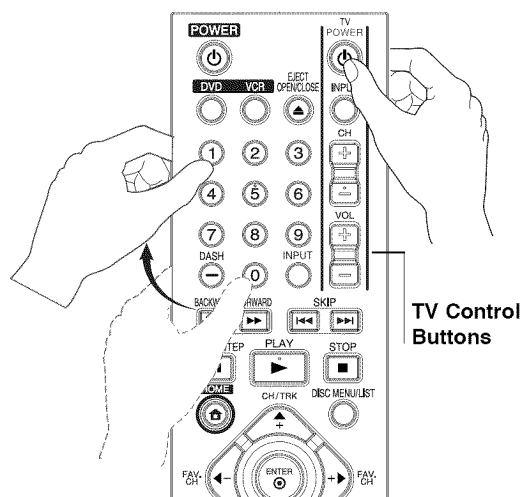

| By pressing | You can |
|-------------|--|
| POWER | Turn the TV on or off. |
| INPUT | Switch the TV's input source between the TV and other input sources. |
| CH +/- | Scans up or down through memorized channels. |
| VOL +/- | Adjust the volume of the TV. |

Note

Depending on the unit being connected, you may not be able to control your TV using some of the buttons.

Controlling other TVs with the Multi-brand Remote Control

You can control the sound level, input source, and power switch of non-LG TVs as well. If your TV is listed in the table below, set the appropriate manufacturer code.

1. While holding down **TV POWER** (⏻) button, press the number buttons to select the manufacturer code for your TV (Refer to table on the right column).
2. Release **TV POWER** (⏻) button.

Code numbers of controllable TVs

If more than one code number is listed, try entering them one at a time until you find the one that works with your TV.

| Manufacturer | Code Number |
|---------------|----------------|
| LG / GoldStar | 1 (Default), 2 |
| Zenith | 1, 3, 4 |
| Samsung | 6, 7 |
| Sony | 8, 9 |
| Hitachi | 4 |

Notes

- Depending on your TV, some or all buttons may not function on the TV, even after entering the correct manufacturer code.
- If you enter a new code number, the code number previously entered will be erased.
- When you replace the batteries of the remote, the code number you have set may be reset to the default setting. Set the appropriate code number again.

Connection to an Amplifier

Connecting to an amplifier equipped with two channel analog stereo or Dolby Pro Logic II/Pro Logic

Connect the Left and Right AUDIO OUTPUT jacks on the Recorder to the audio left and right in jacks on your amplifier, receiver, or stereo system using the audio cables (A) supplied.

Connecting to an amplifier equipped with two channel digital stereo (PCM) or to an Audio/Video receiver equipped with a multi-channel decoder (Dolby Digital™, MPEG 2, or DTS)

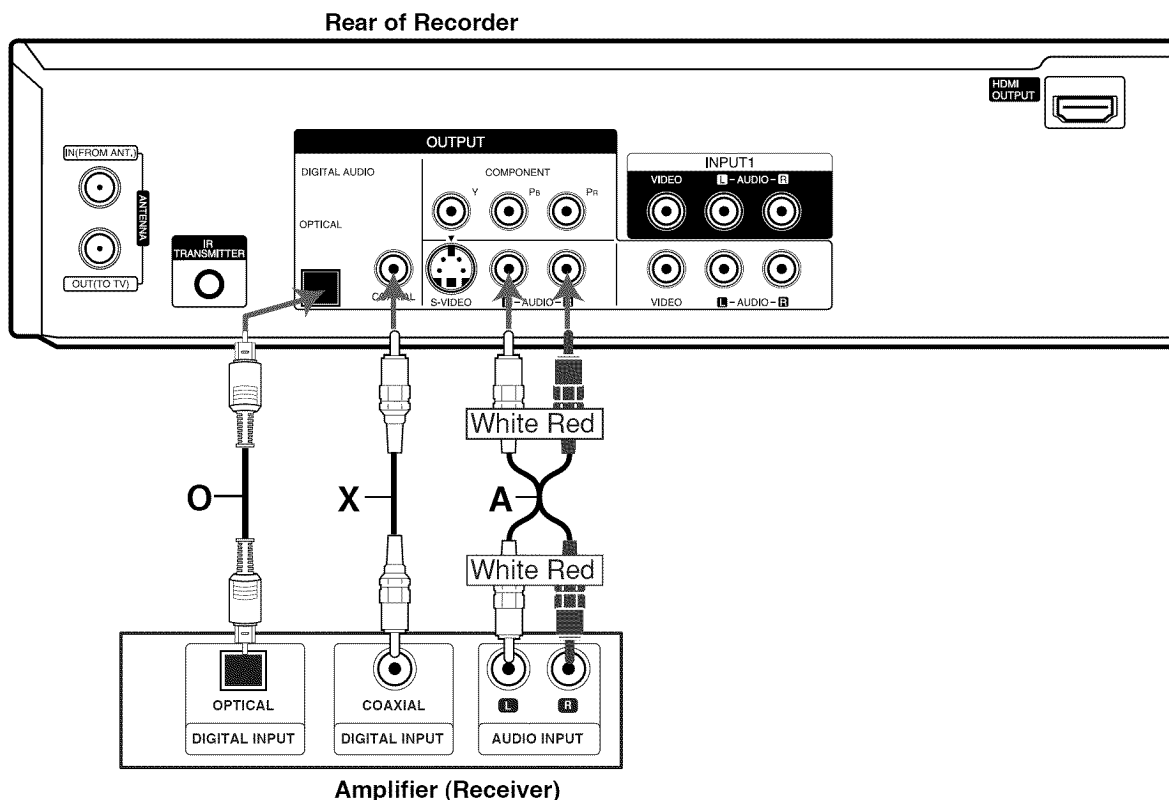

1. Connect one of the Recorder's DIGITAL AUDIO OUTPUT jacks (OPTICAL, COAXIAL) to the corresponding in jack on your amplifier. Use an optional digital (Optical (O), Coaxial (X)) audio cable.
2. You will need to activate the Recorder's digital output. (See [Audio Settings] on page 53).

Caution

Due to the DTS Licensing agreement, the digital output will be in DTS digital out when DTS audio stream is selected.

Notes

- If the audio format of the digital output does not match the capabilities of your receiver, the receiver will produce a strong, distorted sound or no sound at all.
- Six Channel Digital Surround Sound via digital connection can only be obtained if your receiver is equipped with a Digital Multi-channel decoder.
- To see the audio format of the current DVD in the on-screen display, press AUDIO.
- This Recorder does not perform internal (2 channel) decoding of a DTS sound track. To enjoy DTS multi channel surround, you must connect this Recorder to a DTS compatible receiver via one of this Recorder's digital audio outputs.
- While viewing a digital channel, the 2 channel stereo audio is only output through the audio output jacks.
- A digital multi-channel connection provides the best sound quality. For this you need a multi-channel Audio/Video receiver that supports one or more of the audio formats supported by your Recorder (MPEG 2, Dolby Digital and DTS). Check the receiver manual and the logos on the front of the receiver.

Accessory Audio/Video (A/V) Connections to Recorder

Connect the INPUT 1 or AV IN 2 jacks on the Recorder to the audio/video out jacks on your accessory component, using the optional audio/video cables. (Refer to page 33 for [Recording from External Components].)

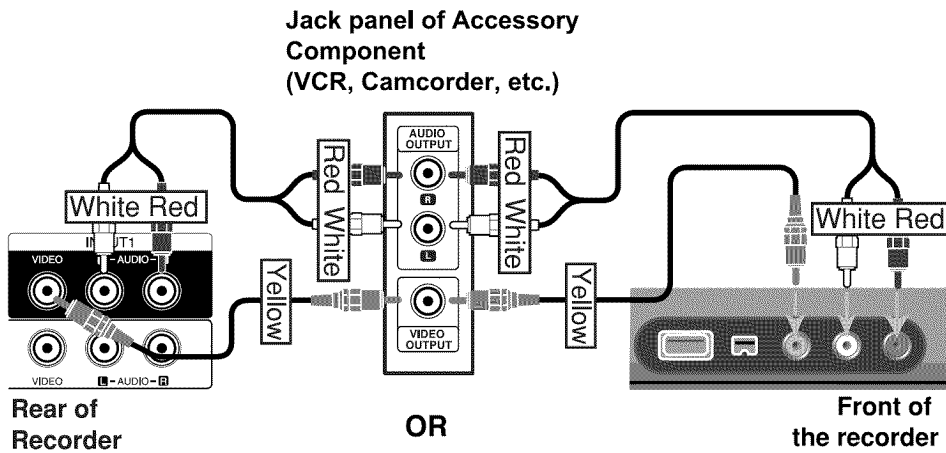

Connecting a Digital Camcorder

Use a DV cable (not supplied) to connect the DV in/out jack of your DV Digital Camcorder to the front panel DV IN jack of this Recorder.

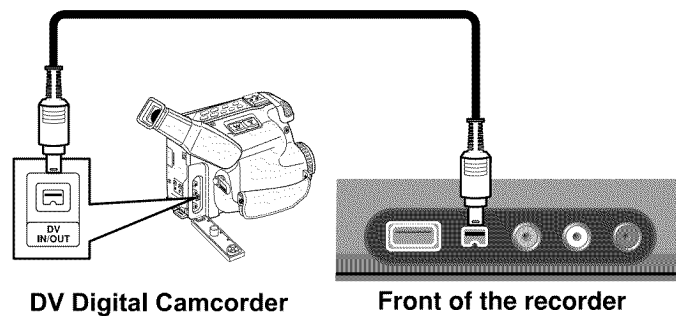

Notes

- This jack is for connection to DV equipment only. It is not compatible with digital satellite tuners or D-VIDEO video decks.
- Disconnecting the DV cable while recording a contents of the connected digital camcorder may result in malfunction.

Connecting the IR control cable

The Recorder sends commands to your connected Set-Top Box to change the channels of it through the IR control cable when AV1 timer recording starts.

1. Connect the plug of the IR control cable to the IR TRANSMITTER jack on the Recorder.
2. Find the Set-Top Box IR Sensor. Refer to "How to find the IR sensor on the Set-Top Box" on right.
3. On the IR control cable, attach the adhesive tape (included) to the flat surface just below of the IR Blaster on the IR control cable.
4. Place the IR Blaster in front of the IR sensor on your Set-Top Box approximately one inch away from the remote sensor.
5. After connecting, make the necessary setting (page 56-57).

Notes

- If your Set-Top Box does not have Audio/Video Out jacks, you cannot use the AV1 timer recording using this connection
- Important, for the Recorder to record programs received through the Set-Top Box, the Set-Top box must remain turned on at all times.
- If your Set-Top Box has IR and RF control together, set the control to IR on the Set-Top box to use this IR connection
- Do not connect an accessory other than the supplied IR control cable to the IR TRANSMITTER jack.
- Do not cover the transmitter.
- Not all Set-Top Box devices will work with this Recorder.
- Refer to the owner's manual of the connected Set-Top Box as well.

Caution

Do not use RF coaxial cable to connect the Set-Top Box

Recommended Set-Top Box devices

- **Cable Box:** Motorola, Pioneer, Scientific Atlanta, Sony
- **Satellite Box:** DirecTV, Echostar, Dish NetWork, HTS, Hughes, JVC, Proscan, RCA, Sony
- **Digital Video Recorder:** Tivo, DirecTV, Dish NetWork, Scientific Atlanta, Motorola, Hughes, Humax, Philips, Sony

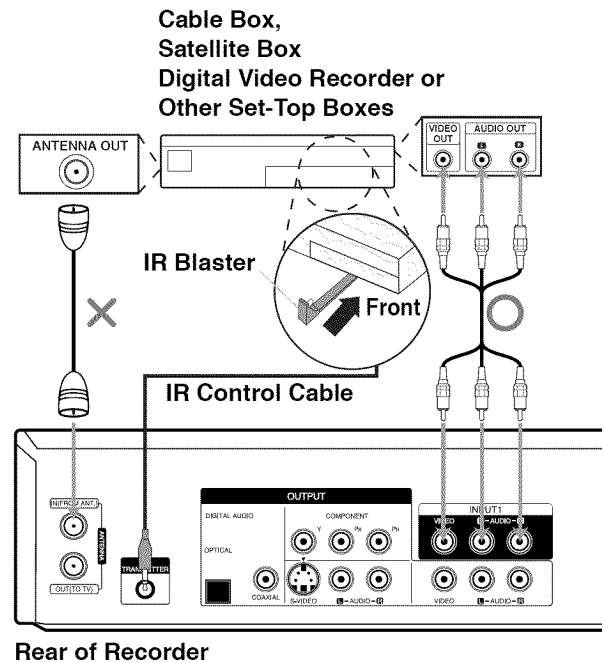

How to find the IR sensor on the Set-Top Box

1. Turn off the Set-Top Box.
2. Hold the Remote Control of the Set-Top Box so that it touches the front of the device.

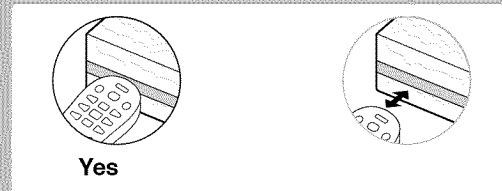

3. Slowly move the Remote Control across the front of the device while pressing **POWER** (⏻) button On and Off. You must press and release the **POWER** (⏻) button each time you move the Remote Control (holding down the button will not work).

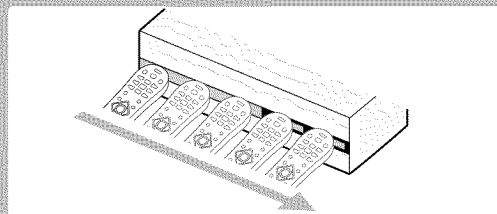

4. When the cable box turns on, you have found the sensor. Remember the location of the sensor.

Initial Setup Wizard

After the **POWER** (⏻) is pressed for the first time to turn on the unit, the Initial Setup Wizard function sets the Language, Channels and Clock step-by-step until the setup is complete.

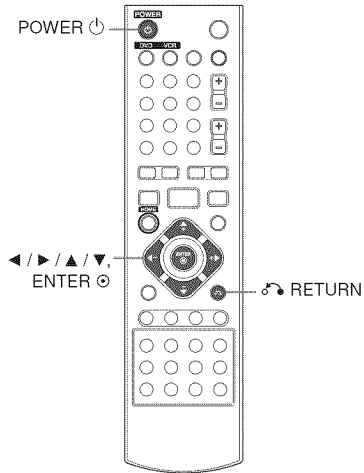

1. Use ▲ / ▼ to select a language for the Setup menu and information display then press **ENTER** (⊙).

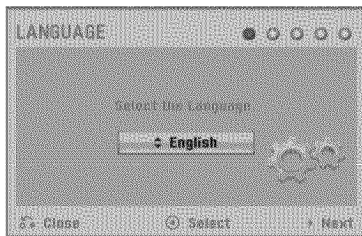

Press **RETURN** (↶) to skip the Initial Setup.

2. Check your antenna connections.
Press ▶ to move next step.

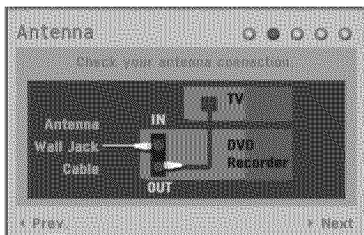

Press ◀ to go back to the previous level.

3. Select the [Tuning Band] option then press ▶.
TV is for over-the-air antenna reception.
CATV is for cable subscribers.

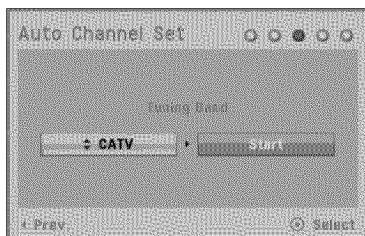

Press ◀ to go back to the previous level.

4. Press **ENTER** (⊙) to begin the channel search.
You can skip the analog channel scanning by pressing ▶.

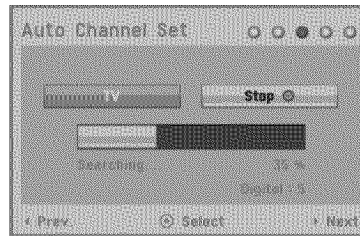

Press ◀ to go back to the previous level.

5. Enter the necessary information for year, date and time.

- ◀ / ▶ (left/right): Moves the cursor to the previous or next column.
- ▲ / ▼ (up/down): Changes the setting at the current cursor position.

You can use numbered buttons to change the setting

Press **ENTER** (⊙) to confirm your setting.

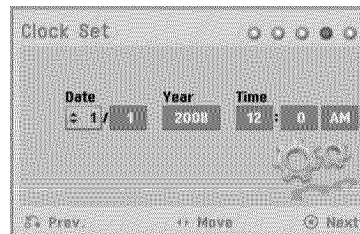

Press **RETURN** (↶) to go back to the previous level.

6. Press **ENTER** (⊙) to exit the menu.

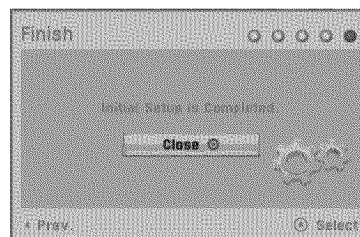

Press ◀ to go back to the previous level.

Note

You can reset the Initial Setup Wizard from the [Factory Set] in the setup menu. (see page 51).

Using the Home Menu

From the Home Menu screen you can access all the Media for playback and recording of the recorder.

1. Press **HOME** (🏠) and the Home menu appears.
2. Use ◀ / ▶ to select the desired main option.
3. Use ▲ / ▼ to select the desired Sub option then press **ENTER** (⊙) to confirm your selection.



4. To exit the HOME menu, press **HOME** (🏠).



Setup

- **Start:** Displays Setup menu.



TV

- **Auto Ch. Scan:** Displays [Auto Channel Set] menu. (See page 50)
- **Channel Edit:** Displays Channel Edit setup menu. (See page 50)
- **Channel List:** Displays the Channel List menu. (See page 19)
- **Timer Record:** Displays [Timer Record] menu. (See page 31, 45)



Movie

- **VCR:** Plays back Video tape. (page 42-43)
- **DISC:**
 - Displays TITLE LIST menu for recordable disc (page 34)
 - Plays back DVD-Video disc (page 21-23).
- **USB:** Displays [Movie List] menu for USB Flash Drive.



Photo (See page 26-27)

- **DISC:** Displays [Photo List] menu for disc.
- **USB:** Displays [Photo List] menu for USB Flash Drive.



Music (See page 25)

- **DISC:** Displays [Music List] menu for disc.
- **USB:** Displays [Music List] menu for USB Flash Drive.



Easy Menu

- **Dubbing:** Displays [Dubbing] menu. (See page 48)
- **Disc Manager:** Displays Disc setup menu. (See page 58)
- **Rec. Mode:** Displays Record Mode setup menu. (See page 56)
- **DV Input:** Displays DV Input mode. (See page 49)

TV Viewing

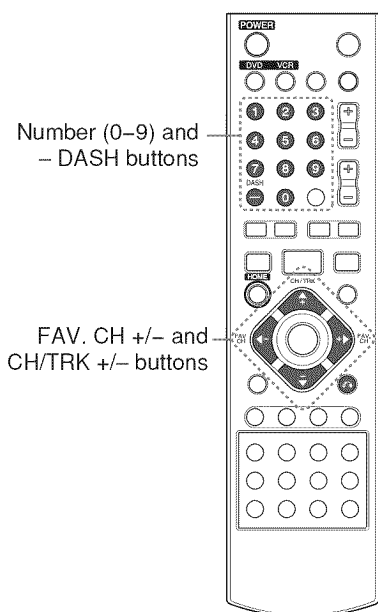

Channel Selection

You can select a channel as shown below.

• Number and – (dash) buttons

Use Number (0-9) and – (dash) buttons to select a channel directly.

- For example, to select digital channel number 27-1, press “2”, “7”, “-”, “1” and press **ENTER** (⊙).
- For example, to select analog channel number 27, press “2”, “7” and press **ENTER** (⊙).

• FAV. CH +/- button

Press **FAV +/-** to scroll through your favorite channels.

Note

To set a favorite channel, use [Channel Edit] option in the Setup menu. (See page 50-51.)

• CH/TRK +/- buttons

Use **CH/TRK +/-** on the Remote Control or **CH ▲/▼** on the front panel to cycle the recorder through the channels in memory.

Channel Selection with Channel List menu



• Displaying Channel List and Changing Channel

1. Press **HOME** (🏠) and the Home menu appears.
2. Select [TV] > [Channel List] and press **ENTER** (⊙). The channel list menu will appear.
3. Select your desired channel using the ▲ / ▼ and press **ENTER** (⊙) to change the channel.

• Switching Channel List

Four types of channel lists are provided for easy and quick channel searching. You can switch the channel lists to TV (CATV), DTV (CADTV), Favorite or ALL.

1. Press ▲ to move the highlight position to top of the channel list.
2. Press ◀ / ▶ to select a [TV (CATV)], [DTV (CADTV)], [Favorite] or [ALL]. Selected channel list appears.

TV (CATV): Shows all analog TV channels.

DTV (CADTV): Shows all digital TV channels.

Favorite: Shows favorite channels. (favorite channel shows **FAV** icon)

ALL: Shows all analog and digital channels.

General Explanation of On-Screen Display

Some DVDs require specific operation or allow only limited operation during playback. When this occurs,  is displayed, action prohibited or not available.

Displaying Information While Watching TV

During viewing the TV, press **DISPLAY** to display/remove the information displayed on-screen. The information will not be displayed during VCR recording.

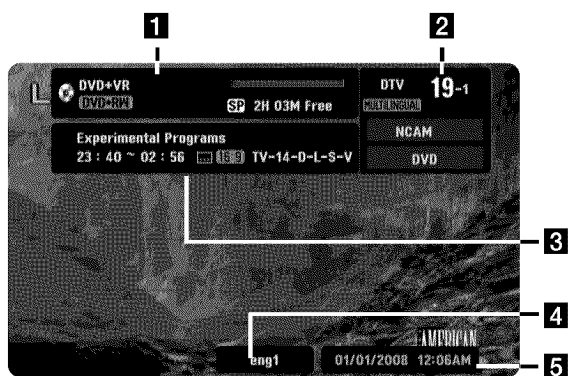



- 1** Indicates the disc format, free space, and elapsed time progress bar.
- 2** Indicates channel number, station name, and audio signal by the tuner.
- 3** Indicates program title, start time, end time, rating, etc. (Digital channel only)
- 4** Indicates audio language for digital channel or output audio signal for analog channel (Stereo, Mono, SAP, etc.).
- 5** Indicates current date and time.

Note

You must set the clock on the setup menu to display the correct start time and end time of the program while viewing digital channel.

Channel Information Icon

 (DTV caption icon)

Indicates that the current channel contains the DTV caption. Press **SUBTITLE** () to select a DTV caption language.

 TV Aspect

Indicates that the current channel is wide or 4:3 picture format.

 (DTV Multiple Audio Icon)

Indicates that the current channel contains the DTV multiple audio languages. Press **AUDIO** to select an audio language.

Displaying Disc Information on-screen

You can display various information about the disc or tape loaded on-screen. Some items can be changed using the menu.

- 1.** Press **DISPLAY** once to show current status.
Example: DVD-RW in VR mode

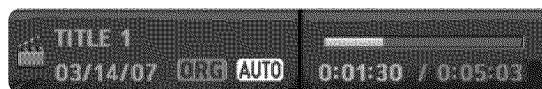

- 2.** Press **DISPLAY** once again to show various playback information. The items displayed differ depending on the disc type or playing status.



- 3.** You can select an item by pressing **▲ / ▼** and change or select the setting by pressing **◀ / ▶**. For details about each item, see the pages in parenthesis.
 - **[Title]:** Current title (or track) number/total number of titles (or tracks) (page 22-23)
 - **[Chapter]:** Current chapter number/total number of chapters (page 22)
 - **[Time]:** Elapsed playing time (page 24)
 - **[Audio]:** Selected audio language (DVD VIDEO only) or audio channel (page 23)
 - **[Subtitle]:** Selected subtitle (page 23)
 - **[Angle]:** Selected angle/total number of angles (page 24)
 - **[Sound]:** Selected sound mode (page 24)

Note

If no button is pressed for 10 seconds, the on-screen display disappears.

DVD Playback

Playing a DVD

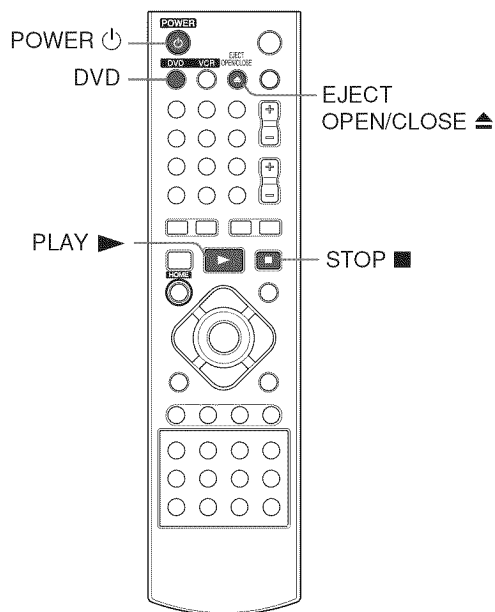

1. Press **DVD** to control the DVD deck.
2. Press **EJECT, OPEN/CLOSE** (▲) to open the disc tray. Load your chosen disc in the tray, with the playback side down.
3. Press **EJECT, OPEN/CLOSE** (▲) to close the tray. Playback starts automatically. If playback does not start, press **PLAY** (▶) or Starts playback using HOME menu.
4. To stop the playback, press **STOP** (■).
The unit records the stopped point, depending on the disc. "■" appears on the screen briefly. Press **PLAY** (▶) to resume playback (from the scene point). If you press **STOP** (■) again or unload the disc ("■" appears on the screen.), the unit will clear the stopped point.
5. Press **EJECT, OPEN/CLOSE** (▲) to remove the disc.
Press **EJECT, OPEN/CLOSE** (▲) to close disc tray or press **POWER** (⏻), the disc tray closes automatically and unit turns off.

Note

If parental control is set and the disc is not within the rating settings you must input the password. (See [Rating] on page 53).

DVD Playback Options

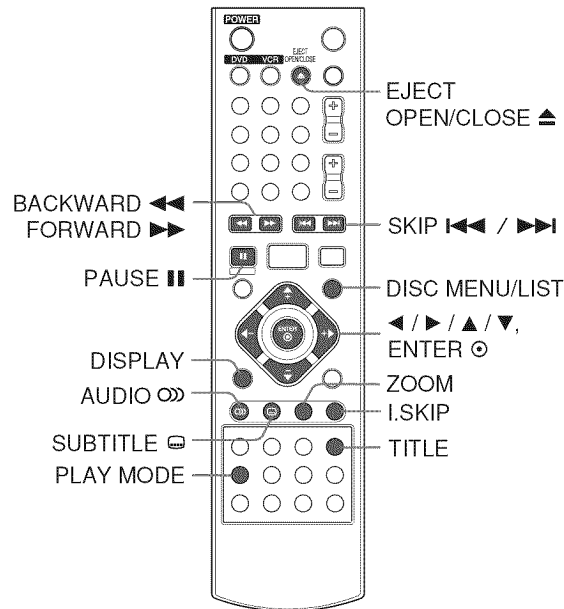

| Buttons | Operations | Discs |
|------------------------------|---|---|
| OPEN / CLOSE (▲) | Opens or closes the disc tray. | All Discs |
| PAUSE () | Pause playback. Press repeatedly to play Frame-by-Frame. You can also use ◀ / ▶ to step backward and forward while in Pause mode. | All Discs DVD ALL MPEG4 |
| BACKWARD (◀◀) / FORWARD (▶▶) | During playback, press repeatedly to select the required scan speed. - DVD; 5 steps, - MPEG4, Audio CD; 3 steps In Pause mode, press BACKWARD (◀◀) / FORWARD (▶▶) for slow motion playback. - DVD; 4 steps, | DVD ALL ACD MPEG4 DVD ALL |
| SKIP (◀◀ / ▶▶) | Press SKIP (▶▶ or ◀◀) briefly during playback to select the next chapter/track or to return to the beginning of the current chapter/track. Press SKIP (◀◀) twice in quick successions to step back to the previous chapter/track. • To go directly to any chapter/track during playback, press DISPLAY twice and use ▲ / ▼ to select the chapter or track icon. Input the chapter/track number or use ◀ / ▶. • On an Audio CD, to go directly to any track, enter the track number using the numbered buttons (0-9) during playback. | DVD ALL MPEG4 ACD MP3 WMA |

DVD Playback Options (Continued)

| Buttons | Operations | Discs |
|----------------|--|---------------------------------|
| ZOOM | Enlarge the video image. (x1 size → x2 size → x4 size → x1 size (normal size)) You can move through the zoomed picture using ◀ / ▶ / ▲ / ▼ buttons. | DVD ALL |
| TITLE | If the current DVD title has a menu, the title menu appears on the screen. Otherwise, the disc menu may appear. | DVD +RW +R |
| DISC MENU/LIST | The disc menu appears on the screen. | DVD |
| SUBTITLE (☑) | During playback, press SUBTITLE (☑) then press ▶ / ◀ repeatedly to select a desired subtitle language. | DVD |
| I.SKIP | Press repeatedly during playback to skip forward 30 seconds. | DVD ALL |
| PLAY MODE | Select a desired play mode while playback. | DVD ALL ACD |
| | [A-]: Repeats a sequence between A (Start point) and B (End point) during playback. Press ENTER (⊙) at your chosen end point then the repeat sequence begins. | |
| | [CHAPTER]: Repeats the current chapter. | DVD ALL |
| | [TITLE]: Repeats the current title. | DVD ALL |
| | [ALL]: Repeats the all titles/tracks. | ACD -RW_{VR} RAM |
| | [Track]: Repeats the current track. | ACD MP3 WMA |
| | [Folder]: Repeats all the tracks on a folder of a disc. | MP3 WMA |
| | [OFF]: Does not play repeatedly. | DVD ALL |
| | <ul style="list-style-type: none"> If you press SKIP (▶▶I) once during Repeat Chapter (Track) playback, the repeat playback cancels. | |
| AUDIO (🔊) | Press AUDIO then press ▶ / ◀ repeatedly to hear a different audio language, audio track or encoding method. | DVD |
| | <p>Note</p> <p>Some discs feature both Dolby Digital and DTS soundtracks. There is no analog audio output when DTS is selected. To listen to the DTS soundtrack, connect this recorder to a DTS decoder via one of the digital outputs. See page 14 for connection details.</p> | |
| | Press AUDIO then press ▶ / ◀ repeatedly during playback to hear a different audio channel. With DVD-RW discs recorded in VR mode that have both a main and a Bilingual audio channel, you can switch between Main (L+L), Bilingual (R+R), or a mix of both (L+R). | DVD ALL |

Special Playback Options

If a menu screen is displayed **DVD**

In some cases, the disc menu might appear instead.

DVD

Use the ◀ / ▶ / ▲ / ▼ buttons to select the title/chapter you want to view, then press **ENTER** (⊙) to start. Press **TITLE** or **DISC MENU/LIST** to return to the menu screen.

Moving to another TITLE **DVD ALL**

When a disc has more than one title, you can move to another title as follows:

- Press **DISPLAY** twice during playback or in stop mode then use ▲ / ▼ to select the title icon. Then, press the appropriate numbered button (0-9) or ◀ / ▶ to select a title number then press **ENTER** (⊙).

Time Search **DVD ALL MPEG4**

To start playing at any chosen time on the disc:

1. Press **DISPLAY** twice during playback. The time search box shows the elapsed playing time.
2. Press ▲ / ▼ to select the time clock icon and [:-:--] appears.
3. Input the required start time in hours, minutes, and seconds from left to right. If you enter the wrong numbers, press ◀ / ▶ to move the under bar () to the wrong number. Then enter the correct numbers.
4. Press **ENTER** (⊙) to confirm. Playback starts from the selected time.

Marker Search **DVD ALL**

To enter a Marker

You can start playback from up to six memorized points. To enter a marker, press **MARKER** at the desired point on the disc. The Marker icon appears on the TV screen briefly. Repeat to enter up to six markers.

To Recall or Clear a Marked Scene

1. During disc playback, press **SEARCH**.
The marker search menu appears on the screen.
2. Use ◀ / ▶ / ▲ / ▼ to select a marker scene that you want to recall or clear.
3. Press **ENTER** (⊙) and playback starts from the marked scene. Or, Press **CLEAR** and use ◀ / ▶ to select [OK] then press **ENTER** (⊙) to delete marked scene from the list.
4. To remove the Marker Search menu, press **RETURN** (↵).

Camera Angle **DVD**

If the disc contains scenes recorded at different camera angles, you can change to a different camera angle during playback. Press **DISPLAY** twice then select the Angle icon during playback. Use ◀ / ▶ to select a desired angle. Note that the number of the current angle appears on the display.

Tip

The Camera Angle icon is displayed on the TV screen when alternate angles are available.

3D Surround **DVD ALL MPEG4**

This unit can produce a 3D Surround effect, which simulates multi-channel audio playback from two conventional stereo speakers, instead of the five or more speakers normally required to listen to multi-channel audio from a home theater system.

1. Press **DISPLAY** twice then use ▲ / ▼ to select the sound icon. Then, use ◀ / ▶ to select [3D SUR.].
2. To turn off the 3D Surround effect, select [NORMAL].

Last Scene Memory **DVD**

This Recorder memorizes last scene from the last disc that is viewed. The last scene remains in memory even if you remove the disc from the Recorder or switch off the Recorder. If you load a disc that has the scene memorized, the scene is automatically recalled.

Notes

- Settings are stored in memory for use any time.
- This Recorder does not memorize settings of a disc if you switch off the Recorder before commencing to play it.
- Last Scene Memory function for a previous DVD title is erased once a different DVD title is played.

Playing an Audio CD or MP3/WMA files

The Recorder can play Audio CDs and MP3/WMA files. Before playing MP3/WMA files, read [MP3/WMA audio file requirement] on right.

1. Press **HOME** (🏠) and the Home menu appears.
2. Select [Music] > [DISC] or [USB] and press **ENTER** (⊙). The [Music List] menu appears on the TV screen.

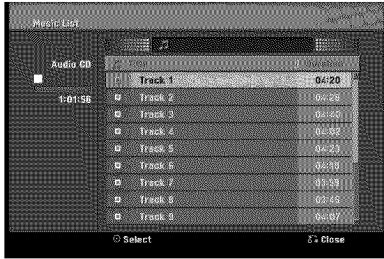

Example) Audio CD

3. Use **▲/▼** to select a track or file then press **PLAY** (▶). Playback starts. You can use variable playback functions. Refer to pages 22-23.
4. To stop playback at any time, press **STOP** (■).

Tips

- You can view TV channel or video input source by pressing **RETURN** (↵). If you want to return to the [Music List] menu, press **DISC MENU/LIST**.
- Press **DISPLAY** to view ID3-Tag information for the MP3 file. If ID3-Tag information is not present, [ID3-Tag: None] will appear. If you select a folder, the number of subfolders and number of MP3/WMA files in the folder are displayed. Press **DISPLAY** again to remove the information screen.
- On CDs, DVDs or USB Flash Drive with mixed content (Audio tracks, MP3/WMA files or JPEG files), you can select between the [Music List] menu and [Photo List] menu by pressing **TITLE** repeatedly.
- If you are in a file list and want to return to the Folder list, use the **▲/▼** to highlight **⏪** and press **ENTER** (⊙) to return to the previous menu screen.

Music List menu options

1. Press **▲ / ▼** to select a track/file or folder on the [Music List] menu then press **ENTER** (⊙).



2. Use **▲ / ▼** to select an option, then press **ENTER** (⊙).
 - **[Play]** Start playback the selected track or file.
 - **[Open]** Opens the folder and a list of files in the folder appears.
 - **[Random]** Start or stop random playback.

Random

1. Press **▲ / ▼** to select a file then press **ENTER** (⊙). The menu options appear.
2. Press **▲ / ▼** to select [Random] option then press **ENTER** (⊙). The unit automatically begins random playback and "RANDOM" appears on the menu screen.
3. To return to normal playback, select [Random] option again then press **ENTER** (⊙).

Tip

By pressing **SKIP** (⏮/⏭) during Random playback, the unit selects another track and resumes Random playback.

MP3/WMA audio file requirement

| Playable discs | MP3 WMA |
|--------------------|---|
| File extensions | “.mp3”, “.wma”. |
| Sampling frequency | within 8 - 48 kHz (MP3), within 32 - 48kHz (WMA) |
| Bit rate: within | 8 - 320kbps (MP3), 32 - 192kbps (WMA) |
| CD-R/RW Format | ISO 9660 and JOLIET. |
| DVD±R/RW Format | ISO 9660 (UDF Bridge format) |
| Maximum Files/Disc | Less than 999 (total number of files and folders) |

Viewing a JPEG files

This unit can play JPEG files. Before playing JPEG recordings, read "Photo file requirement" on page 27.

1. Press **HOME** (🏠) and the Home menu appears.
2. Select [Photo] > [DISC] or [USB] and press **ENTER** (⊙).
3. Use ▲ / ▼ / ◀ / ▶ to select a file or folder and press **ENTER** (⊙).

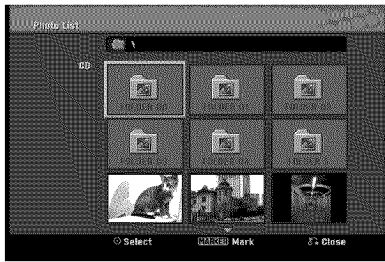

4. Use ▲ / ▼ to select option and press **ENTER** (⊙).

Example: When you select a file.

5. Use ▲ / ▼ to select [Full Screen] then press **ENTER** (⊙).
The selected image is displayed in full screen.

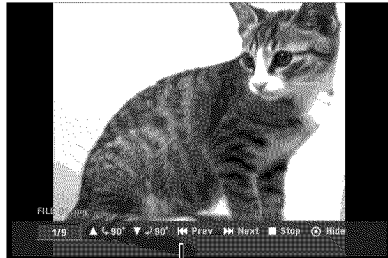

Press **ENTER** (⊙) to make this menu appear or disappear.

6. To stop viewing at any time, press **STOP** (■).

Notes



- If the  icon displays in the [Photo List] menu, it means you cannot see those JPEG files.
- You can view TV channel or video input source by pressing **RETURN** (↵). If you want to return to the [Photo List] menu, press **DISC MENU/LIST**.
- If you are in a file list and want to return to the Folder list, use the ▲/▼ to highlight  and press **ENTER** (⊙) to return to the previous menu screen.
- On CDs, DVDs or USB Flash Drive with mixed content (Audio tracks, MP3/WMA files or JPEG files), you can select between the [Music List] menu and [Photo List] menu by pressing **TITLE** repeatedly.

Photo List menu options

1. Use ▲ / ▼ / ◀ / ▶ to select a file then press **ENTER** (⊙). The menu options appear.



2. Use ▲ / ▼ to select an option then press **ENTER** (⊙) to confirm your selection.
 - **[Open]** Opens the folder and a list of files in the folder appears.
 - **[Full Screen]** Shows the selected file as full screen.
 - **[Slide Show]** Displays Slide Show menu.

Photo playback options

• Still picture

Use **PAUSE/STEP** (⏸) while viewing slide show to pause mode.

• Skip Images

While viewing a picture, press **SKIP** (⏮ / ⏭) once to advance to the next file or return to the previous file.

• Rotate Images

Use ▲ / ▼ while viewing a picture to flip the picture clockwise or counterclockwise.

View Slide Shows

1. Select [Slide Show] option on the [Photo List] menu.
2. Press **ENTER** (⊙).

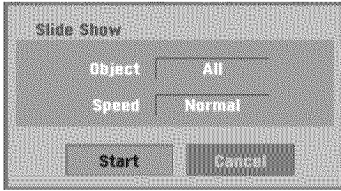

3. Use ◀ / ▶ / ▲ / ▼ to set the options.
[Object] option:
 - [Selected] Views slide show only selected files.
 - [All] Views slide show all files.[Speed] option:
Sets the Slide Show speed to [Normal], [Slow], or [Fast].
4. Select the [Start] option then press **ENTER** (⊙) to start the Slide Show.
5. Press **STOP** (■) to stop the Slide Show and returns to the [Photo List] menu.

Tips

- Selecting multiple files
 1. Press **MARKER**.
A check mark appears on the file. Press **MARKER** again to cancel the marked file.
 2. Repeat step 1 to mark additional file.
- Use the **CLEAR** button to select all files, or cancel all marked files.

Photo file requirement

| | |
|--------------------|---|
| Playable discs | JPEG |
| File extensions | “.jpg” |
| Photo size | Less than 4MB recommended |
| CD-R/RW Format | ISO 9660 and JOLIET. |
| DVD±R/RW Format | ISO 9660 (UDF Bridge format) |
| Maximum Files/Disc | Less than 999 (total number of files and folders) |

Notes Notes on JPEG format

- Progressive and lossless compression JPEG image files are not supported.
- Depending on the size and number of the JPEG files, it may take several minutes to read the contents of the media.

Playing a MPEG4 Movie File

The recorder can play MPEG4 files. Before playing MPEG4 files, read "MPEG4 file requirement" on right.

1. Press **HOME** (🏠).
2. Select [Movie] option.
3. Select a media that contains MPEG4 file(s) then press **ENTER** (⊙).
The [Movie List] menu appears on the TV screen.

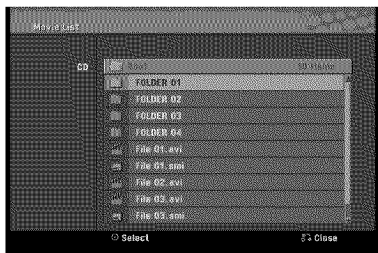

4. Press **▲ / ▼** to select a folder, and press **ENTER** (⊙). A list of files in the folder appears. If you are in a file list and want to return to the Folder list, use the **▲ / ▼** buttons on the remote to highlight **⋮** and press **ENTER** (⊙).
5. If you want to view a particular file, press **▲ / ▼** to highlight a file and press **PLAY** (▶).
You can use variable playback functions. Refer to pages 22-23.
6. Press **STOP** (■) to stop the playback. The [Movie List] menu appears.

Notice for displaying the MPEG4 subtitle

If the subtitle does not display properly, please follow the steps below.

1. Press **PAUSE/STEP** (II) when the subtitle appears.
2. Press and hold **SUBTITLE** (☑) about 3 seconds.
The language code will appear.
3. Press **◀ / ▶** to select another language code until the subtitle is displayed properly.
4. Press **PLAY** (▶) to continue playback.

Note

The MPEG4 subtitle file name has to be identified with the MPEG4 file name to display by this unit.

Movie List menu options

1. Press **▲ / ▼** to select a folder/file on the [Movie List] menu then press **ENTER** (⊙).
[Movie List] menu options appear.
2. Press **▲ / ▼ / ◀ / ▶** to select an option, and press **ENTER** (⊙).
 - [Play] Start playback the selected title.
 - [Open] Opens the folder and a list of files in the folder appears

MPEG4 file requirement

| | |
|---------------------------|--|
| Playable discs | MPEG4 |
| Available resolution size | 720x576 (W x H) pixel |
| MPEG4 file extensions | ".avi" |
| Playable MPEG4 subtitle | ".smi", ".srt", ".sub (Micro DVD format only)", ".txt (Micro DVD format only)" |
| Playable Codec format | "MP43" |
| Playable Audio format | "AC3", "PCM", "MP3", "WMA" |
| Sampling frequency | within 8 - 48 kHz (MP3), within 32 - 48kHz (WMA) |
| Bit rate | within 8 - 320kbps (MP3), within 32 - 192kbps (WMA) |
| CD-R/RW Format | ISO 9660 and JOLIET. |
| DVD±R/RW Format | ISO 9660 (UDF Bridge format) |
| Maximum Files/Disc | Less than 999 (total number of files and folders) |

Notes Notes on MPEG4 format

- The MPEG4 subtitle file name has format to be identified with the MPEG4 file name to be display on the unit.
- If the number of the screen frame is over 29.97 frames per second, this unit may not operate normally.
- If the video and audio structure of MPEG4 file is not interleaved, returns to the menu screen.
- If there is impossible code to express in the MPEG4 file name, it may be displayed as "_" mark.
- This unit does not support the MPEG4 file that is recorded with GMC (Global Motion Compensation).
- If a bitrate of MPEG4 file on the USB is over 5Mbps, the file may not be played properly.
- This unit may not support some MPEG4 files.
- MPEG4 movie files are not playable on this unit.

DVD Recording

Notes for DVD recording

- This Recorder cannot record CD-R or CD-RW discs.
- Fingerprints and small scratches on a disc can affect playback and/or recording performance. Please take proper care of your discs.
- The company does not hold any responsibility to compensate the contents which should have been recorded, and any losses or damages (e.g. losses of business profit, or business intermission) that may arise from malfunction of this recorder (not recording/editing as intended).
- The recording times shown are not exact because the recorder uses variable bit-rate video compression. This means that the exact recording time will depend on the material being recorded.
- When recording a TV broadcast, if the reception is poor or the picture contains interference, the recording times may be shorter.
- The unit cannot record the DTV caption on the recordable DVD disc.
- If you record still pictures or audio only, the recording time may be longer.
- The displayed times for recording and time remaining may not always add up to exactly the length of the disc.
- The recording time available may decrease if you heavily edit a disc.
- If using a DVD-RW disc, make sure you change the recording format (Video mode or VR mode) before you record anything on the disc. See page 58 (Initialize) for how to do this.
- When using a DVD-R or DVD+R disc, you can keep recording until the disc is full, or until you finalize the disc. Before you start a recording session, check the amount of recording time left on the disc.
- When using a DVD-RW disc in Video mode, recording time available will only increase if you erase the last title recorded on the disc.
- The Delete Title option in the Title List (Original) menu only hides the title, it does not actually erase the title from the disc and increase the recording time available (except for the last recorded title on a DVD-RW disc in Video mode).
- Overwrite recording is available using DVD+RW discs.
- When using a DVD+R/RW, the recorder will execute the Menu-making operation to update the new title and editing when removing the disc from the recorder.
- The recordable time is limited to 12 hours for a title.

Recording time and picture quality

There are five preset recording quality modes:

- **XP** – Highest quality setting, gives about 1 hour of recording time on a DVD (4.7GB).
- **SP** – Default quality, sufficient for most applications, gives about 2 hours of recording time on a DVD (4.7GB).
- **LP** – Slightly lower video quality, gives about 4 hour of recording time on a DVD disc (4.7GB).
- **EP** – Low video quality, gives about 6 hour of recording time on a DVD (4.7GB).
- **MLP** – The longest recording time with the lowest video quality, gives you about 14 hours of recording time on a DVD (4.7GB).

Note

You may see a fragmented picture during playing back the contents recorded in EP or MLP mode.

Restrictions on video recording

- You cannot record copy-protected video using this recorder. Copy-protected video includes DVD-Video discs and some satellite broadcasts. If copy-protected material is encountered during a recording, recording will pause or stop automatically and an error message will be displayed on-screen.
- Video that is 'copy-once only' can only be recorded using a DVD-RW disc in VR mode or DVD-RAM disc with CPRM (See page 69).

| Copy control signals | Recordable disc |
|----------------------|---|
| Copy-Free | -RW_{VR} -RW_{Video} +RW |
| | -R +R RAM |
| Copy-Once | -RW_{VR} Ver.1.1, Ver.1.2 with CPRM* |
| | RAM Ver.2.0, Ver.2.1, Ver.2.2 with CPRM* |
| Copy-Never | None |

* The recorded disc can be played only on CPRM compatible equipment

Basic Recording from a TV

Follow the instructions below to record a TV program. Recording starts immediately and continues until the disc is full or you stop the recording.

1. Switch on the Recorder, select the device (DVD) for recording and load a recordable disc. Also make sure that the TV input is set to this recorder.
2. Set a recording mode as necessary by pressing **REC MODE** repeatedly.
DVD: XP, SP, LP, EP, MLP
3. Select the TV channel to record.
4. Use **AUDIO** to select the audio channel for analog channel or audio language for digital channel to record.

The table below shows what will be recorded on the different settings for different types of analog broadcast. The last column (Monitor Audio) shows what you'll hear as it is recording.

| TV Broadcast | Selected Audio | Broadcast Audio | | Monitor Audio |
|--------------|----------------|-----------------|------|---------------|
| | | L Ch | R Ch | |
| MONO | MONO | MONO | MONO | MONO |
| STEREO | STEREO | L | R | STEREO |
| | Left | L | L | Left |
| | Right | R | R | Right |
| | MONO | MONO | MONO | MONO |
| MONO+SAP | MONO | MONO | MONO | MONO |
| | SAP | SAP | SAP | SAP |
| STEREO +SAP | STEREO | L | R | STEREO |
| | SAP | SAP | SAP | SAP |
| | MONO | MONO | MONO | MONO |

If you set the audio channel to SAP (Second Audio Program), but there is no SAP channel being broadcast, the main audio (mono or stereo) will be recorded.

5. Press **REC** once to start recording.
The REC indicator lights in the display window.
6. Press **STOP** (■) to stop recording.

Notes

- The maximum numbers of DVD titles are as show below;
 - DVD-R/RW/DVD-RAM: 99
 - DVD+R/RW: 49
- If the Recorder is powered off during DVD recording, the recording will not be saved.

Instant Timer Recording

Instant Timer Recording allows you to make a recording easily of a preset length without using the program timer.

1. Follow steps 1-4 as shown left (Basic Recording from a TV).
2. Press **REC** repeatedly to select the recording time length. Recording starts after the first press.
DVD: Each subsequent press increases the recording time by 10 minutes.

Checking the Recording Time

Press **REC** or **DISPLAY** once to check the recording time. The recalled setting will automatically return to the TV screen for a moment.

Also, remaining time of recording is shown in the display window.

To Extend the Recording Time

The recording time can be extended anytime by pressing **REC**.

Each subsequent press increases the recording time by 10 minutes (DVD).

To Pause the Recording

1. Press **PAUSE/STEP** (II) to pause the recording.
2. When you want to continue recording, press **PAUSE/STEP** (II) or **REC**.

Notes

- If you press **PAUSE/STEP** (II) during the Instant Timer Recording, it will be canceled.
- The Recorder will automatically power off when the Instant Timer Recording ends.

Timer Recording

1. Press **HOME** (🏠) and the Home menu appears.
2. Select [TV] > [Timer Record] and press **ENTER** (⊙).

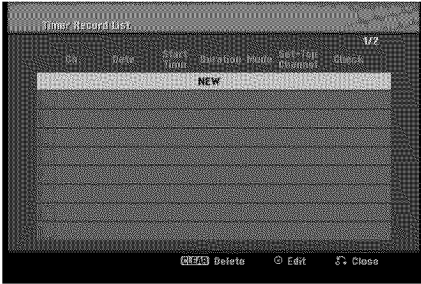

3. Select [NEW] and press **ENTER** (⊙). The Timer Record menu will appear.

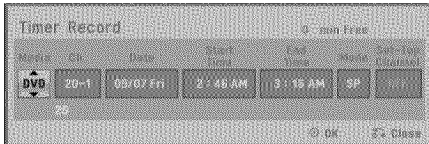

- **[Media]** – Choose a media (DVD).
 - **[Ch.]** – Choose a channel that memorized in this Recorder, or one of the external inputs from which to record (AV1 or AV2).
 - **[Date]** – Choose a date up to 1 month in advance, or select a daily or weekly program.
 - **[Start Time]** – Set the recording start time.
 - **[End Time]** – Set the recording end time.
 - **[Mode]** – Choose a record mode.
DVD: XP, SP, LP, EP, MLP or AT (Auto)
AT(Auto) mode determines how much time is available on the disc or tape and switches record mode, if necessary, to complete recording the program.
 - **[Set-Top Channel]** – Choose a channel or [OFF] for AV1 input timer recording.
For AV1 input timer recording using [Set-Top Channel] option, refer to page 32.
4. Enter the necessary information for your timer recording(s).
 - ◀ / ▶ (left/right) – Move the cursor left/right
 - ▲ / ▼ (up/down) – Change the setting at the current cursor position.
 - Press **RETURN** (↵) to return to the [Timer Record List] menu.
 5. Press **ENTER** (⊙) to save the program.

6. The “Rec. OK” on the [Check] field on the [Timer Record List] menu indicates the timer recording is programmed correctly.
 - **[Rec OK]**: Indicates the Timer Record is in recordable condition.
 - **[No Disc]**: There is no disc in the disc tray.
 - **[Invalid disc]**: The inserted disc is not recordable.
 - **[Unrecordable]**: There is no space to record on the disc.
 - **[Lack Space]**: The space on the disc is insufficient.
 - **[Duplicate Date]**: Timer Record is overlapped with another.
7. Press **RETURN** (↵) to exit the [Timer Record List] menu.

Notes

- You must insert a recordable disc or tape.
- The Timer indicator lights on the front panel display.
- The Recorder will record the audio according to the current TV tuner setting. Use AUDIO to select the audio channel for analog channel to record before switching the Recorder to Standby mode.
- For digital TV recording with multiple audio languages, set audio language from the [DTV Audio] in sub-menu of the Setup menu (see page 52).
- The Recorder will automatically power off when the Timer Recording ends.
- There is a short delay when a timer recording finishes to confirm the recorded program. If two timer recordings are set to record sequentially (one right after the other), the very beginning of the later program may not be recorded.
- You must press **STOP** (■) to stop the Timer Recording.
- The Timer Recording function allows you to record up to 16 programs within a period of one month.

Checking Timer Recording Details

Programming can be checked whenever the Recorder is turned on.

1. Press **HOME** (🏠) and the Home menu appears.
2. Select [TV] > [Timer Record] and press **ENTER** (⊙).
3. Use ▲ / ▼ to select a program.
4. Press **ENTER** (⊙) to edit the selected program. Timer Record menu appears.

Canceling a Timer Recording

You can clear a timer setting anytime before the recording actually starts.

- Use ▲ / ▼ to select a program you want to erase on the [Timer Recorder List] menu, then press **CLEAR** and select [OK] then press **ENTER** (⊙).

AV1 Timer Recording using Set-Top Channel option

1. Connect a Set-Top Box as shown on page 16.
2. Make the necessary settings for the connection as shown on page 56-57.
3. Important, for the Recorder to record programs received through the Set-Top Box, the Set-Top box must remain turned on at all times.
4. Select [TV] > [Timer Record] and press **ENTER** (⊙).

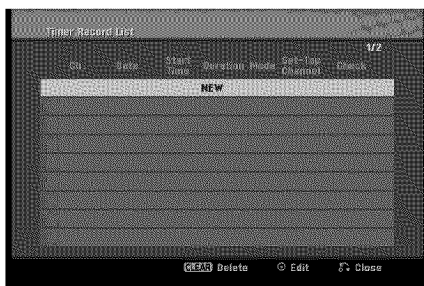

5. Select [NEW] and press **ENTER** (⊙). The Timer Record menu will appear.
6. Enter the necessary information for your timer recording(s).
 - ◀ / ▶ (left/right) – Move the cursor left/right
 - ▲ / ▼ (up/down) – Change the setting at the current cursor position.
 - Press **RETURN** (↵) to exit the Timer Record menu.
7. Set the [Ch.] option to [AV1].

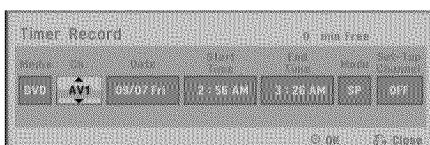

8. Set the [Media], [Date], [Start Time], [End Time], and [Mode] options according to previous page.
9. Set the [Set-Top Channel] option.
 - Select a channel using number or ▲ / ▼ buttons, the Recorder sends commands to change the channel of the connected Set-Top Box through the IR control cable.
 - Select [OFF] using **CLEAR** button, if you do not need the changing the channel of the Set-Top Box.

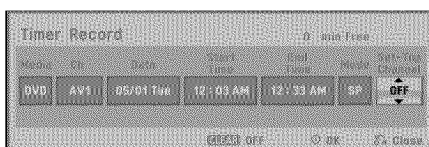

10. Press **ENTER** (⊙) to save the program.
11. The "Rec. OK" on the [Check] field on the [Timer Record List] menu indicates the timer recording is programmed correctly. "[Check] field according to previous page".
12. Press **RETURN** (↵) to exit the [Timer Record List] menu.

Notes

- You must insert a recordable disc.
- The Timer indicator lights on the front panel display.
- The Recorder will automatically power off when the Timer Recording ends.
- There is a short delay when a timer recording finishes to confirm the recorded program. If two timer recordings are set to record sequentially (one right after the other), the very beginning of the later program may not be recorded.
- You must press **STOP** (■) to stop the Timer Recording.

Checking Timer Recording Details

Programming can be checked whenever the Recorder is turned on.

1. Press **HOME** (🏠) and the Home menu appears.
2. Select [TV] > [Timer Record] and press **ENTER** (⊙).
3. Use ▲ / ▼ to select a program.
4. Press **ENTER** (⊙) to edit the selected program. Timer Record menu appears.

Canceling a Timer Recording

You can clear a timer setting anytime before the recording actually starts.

- Use ▲ / ▼ to select a program you want to erase on the Timer Recorder List, then press **CLEAR** and select [OK] than press **ENTER** (⊙).

Tips If you fail the AV1 Timer Recording

- Make sure IR Control Cable connection. (page 16)
- Set the [Set-Top Box Edit] options again then proceed the [Test] option. (page 56-57)
- If IR control is not activated even though you set again, the Recorder may not control your Set-Top Box according to the device's maker or status. Confirm recommended Set-Top Box on page 16 or contact your Set-Top Box provider.

Playing while you are recording **RAM**

You can start play from the beginning of the title while continuing to record it.

While recording (in DVD mode)

1. Press **PLAY** (▶).
Start play of the title you are recording.
2. Press **STOP** (■) to return to the current recording screen.

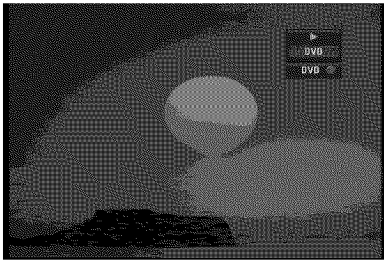

OR

1. Press **TIMESHIFT**.
The PIP(Picture-In-Picture) window appears on the screen as shown below. What is currently being recorded appears as a PIP and you will hear the playback audio.
 - You can switch between PIP window and Main window screen by pressing **TIMESHIFT**.

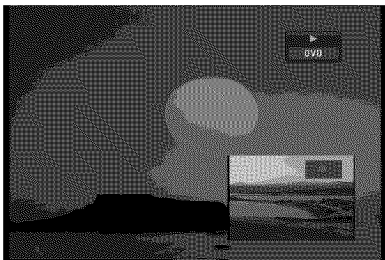

2. Press **STOP** (■) to return to the current recording screen.

Notes

- Play cannot be started until at least 30 seconds after recording starts. (MLP mode: after 1 minute)
- This function does not work in VCR Recording mode.
- This function can operate the DVD-RAM disc only.

Recording from External Components

You can record from an external component, such as a camcorder or VCR, connected to any of the Recorder's external inputs.

1. Make sure that the component you want to record from is connected properly to the Recorder. See page 15.
2. Press **INPUT** repeatedly to select the external input to record from.
 - AV1: Audio/Video Input mounted on back panel.
 - AV2: Audio/Video Input mounted on front panel.
 - DV: DV Input mounted on front panel.
3. Load a recordable disc.
4. Set a recording mode as necessary by pressing **REC MODE** repeatedly.
DVD: XP, SP, LP, EP or MLP.
5. Press ● **REC** once to start recording.
The REC indicator lights in the display window.
6. Press **STOP** (■) to stop recording.

Notes

- Check that the Audio In settings DV Record Audio are as you want them. See page 56.
- If your source is copy-protected using CopyGuard, you will not be able to record it using this recorder. See Copyright on page 3 for more details.
- Recording continues until you press **STOP** (■) or the disc is full.
- To record for a fixed length of time, see [Instant Timer Recording] on page 30.
- When unit is on any external inputs mode (AV1, AV2 and DV) the **CH +/-** buttons don't work, press **INPUT** (on remote) repeatedly to select the TV mode, and then select the TV channels.

DVD Editing

Title List and Chapter List Menu Overview

Using the Title List menu you can edit video content. The editing features available in the Title List menu depend on whether you are editing video on DVD, and whether you're editing Original content, or a Playlist.

There are two ways to edit VR mode DVD-RW discs. You can directly edit the Original content of the disc, or you can create and edit a Playlist. The Playlist doesn't actually change any of the content on the disc, but just controls how the content is played back.

1. Press **DISC MENU/LIST** to display the TITLE LIST menu.

Playback should be stopped when you do this.

- When selecting titles, use the **▲ / ▼** buttons to display the previous/next page if there are more than six titles.
- If you are editing a VR mode disc, press **DISC MENU/LIST** to switch between Original and Playlist menu.
- On the left side of the screen are the menu options. The main part of the screen shows thumbnails of the titles (or chapter) on the DVD. You can change these thumbnails using the **THUMBNAIL** button. (see [Changing Title Thumbnails] on page 35.)
- Press **DISPLAY** to display the information of selected title on the Title List menu.
- After selecting a title or chapter on the Title List or Chapter List menu, then press **ENTER (⊙)**. The menu options on the left side of the menu. Use **▲ / ▼** to select a option then press **ENTER (⊙)** to confirm your selection.

2. To exit the TITLE LIST menu, press **RETURN (↵)** repeatedly.



- 1 Current media.
- 2 Indicates the record mode, free space, and elapsed time progress bar.
- 3 Menu options: To display menu option, select a title or chapter then press **ENTER (⊙)**. The options displayed differ depending on the disc type.
 - **[Play]** Start playback of the selected title or chapter. The hidden titles and chapters on the DVD+R/RW cannot be play back.
 - **[Search]**
 - [Chapter] : Displays Chapter List of the Title.
 - [Time] : Search time for you want start point of the title .
 - **[Delete]** Deletes the title or chapter. (page 37)
 - **[Move]** Moves chapter position on [Chapter List - Playlist] menu (page 39).
 - **[Protect]** Protects accidental recording, editing or deleting of the title.(page 39)
 - **[Edit]** Edits or Deletes a part of the title.
 - [Title Name] : Edits the title name. (page 38).
 - [Delete Part] : Deletes a part of the Title (page 37).
 - [Divide] : Divides a title into two (page 40).
 - [Hide (Show)] : Hides (or Shows) the selected title or chapter. (page 39)
 - **[Playlist Add]** Adds the title or chapter to the Playlist. (page 36)
 - **[Dubbing]** Dubs the title to VCR (page 48).
 - **[Title]** Displays Title List of the chapter.
 - **[Combine]** Combines two chapters into one (page 40).
 - **[Full Play]** Starts playback of the selected title including the hidden chapters.
- 4 Currently selected title.
- 5 Shows the selected title number and total number of titles.
- 6 Thumbnail.
- 7 Shows the title name, recorded date, and recording length.

VR Mode: Original and Playlist Editing

Titles, Chapters and Parts

Titles in the disc's original content contain one or more chapters. When you add a disc's title into the Playlist, all the chapters within that title also added. In other words, chapters in the Playlist behave exactly as chapters on original content. From the Original and Playlist menu you can add or delete parts. Adding a chapter or title to the Playlist creates a new title made up of a section (ie., chapter) of an Original title. Deleting a part removes part of a title from the Original or Playlist menu.

Caution

- When editing using the Delete, Add and Move functions, the start and end frames may not be exactly as set in the start and end point display.
- During Playlist playback, you may notice a momentary pause between edits. This is not a malfunction.

Is editing a DVD like editing a video tape?

No. When you edit a video tape you need one video deck to play the original tape and another to record the edits. With DVD, you edit by making a 'Playlist' of what to play and when to play it. On playback, the Recorder plays the disc according to the Playlist.

About word 'Original' and 'Playlist'

-RWvr **RAM**

Throughout this manual, you will often see the words Original and Playlist to refer to the actual content and the edited version.

- **Original:** content refers to what's actually recorded on the disc.
- **Playlist:** content refers to the edited version of the disc — how the Original content is to be played.

Adding Chapter Markers

Chapter **-RWvr** **+RW** **+R** **RAM**

You can create chapters within a title by inserting chapter marks at the desired points.

Notes

- Chapter markers are inserted at regular intervals automatically. You can change this interval from the Initial Setup menu (see [Auto Chapter] on page 56).
- Addable chapter number has limitation.

1. Play the title.
2. At the point you want to start a new chapter, press **CHP. ADD**.

A chapter marker icon appears on the TV screen.

- You can also put chapter markers in during recording.

Changing the Title Thumbnails

Thumbnail **-RWvr** **+RW** **+R** **RAM**

Each title displayed in the Title List menu is represented by a thumbnail picture taken from the start of that title or chapter.

If you prefer, select a different still picture from within a title.

1. Play the title.
2. Press **THUMBNAIL** to make the currently displayed picture the one that appears in the Title List menu. The still picture that you choose appears in the Title List menu.

Tip

-RWvr **RAM**

You can also change the thumbnail picture of the title on the Chapter List menu. Select a chapter on the Chapter List menu then press **THUMBNAIL**. The thumbnail picture of the title that includes the chapter is changed.

Making a New Playlist

-RWVR **RAM**

Use this function to add an Original title or chapter to the Playlist. When you do this, the whole title or chapter are put into the Playlist (you can delete bits you don't need later - see [Deleting an Original or Playlist title/chapter] on page 37).

The title appears in the Playlist complete with the chapter markers that appear in the Original. However, if you add more chapter markers to the Original later, these are not automatically copied over into the Playlist title.

1. Choose a title or chapter on the [TITLE LIST-Original] menu or [Chapter List-Original] menu to put into the Playlist, then press **ENTER** (⊙).
The menu options appears on the left side of the menu.
2. Use **▲** / **▼** to select [Playlist Add] option then press **▶**.



3. Select [New Playlist] then press **ENTER** (⊙).
The new title appears in the updated Playlist. All chapters of the title are added to the Playlist.

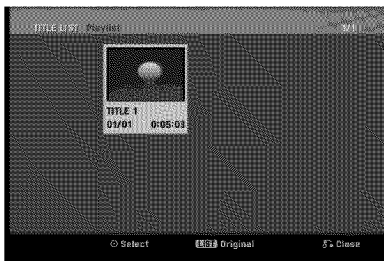

Adding Additional Title / Chapters to the Playlist

-RWVR **RAM**

You can add an Original title or chapter to add to a Playlist title even if it is already registered.

1. Choose a title or chapter on the [TITLE LIST-Original] menu or [Chapter List-Original] menu to put into the Playlist, then press **ENTER** (⊙).
The menu options appears on the left side of the screen.
2. Use **▲** / **▼** to select [Playlist Add] from menu options then press **▶**.



3. Choose a Title List-Playlist that is already registered to insert a title or chapter, then press **ENTER** (⊙).
4. Repeat steps 1-3 to add additional title or chapter on the Playlist.
You can view the added chapters on the [Chapter List-Playlist] menu.

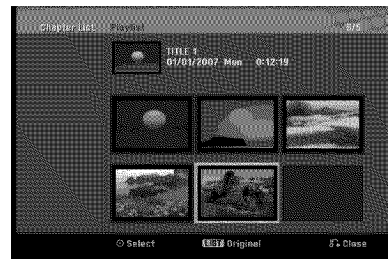

5. Press **RETURN** (↵) to exit, or **DISC MENU/LIST** to go back to the [Title List-Original] menu.

Deleting an Original or Playlist Title/Chapter

When you erase a title or chapter from the Playlist menu, you only remove it from the Playlist; the title/chapter remains in the Original menu.

If you choose to delete a title or chapter from the Original (title/chapter) menu, the title or chapter is actually deleted from the disc and the remaining time available for recording increases. Titles/chapters deleted from the Original are also removed from the Playlist.

Note

It may not be possible to delete chapters that are less than 3 seconds long.

1. Use ◀ / ▶ / ▲ / ▼ to choose a chapter or title you want to delete on the [TITLE LIST] or [Chapter List] menu then press **ENTER** (⊙).
The menu options appears on the left side of the screen.
2. Select [Delete] option from the options on the menu.
Example: Title List (DVD-VR)

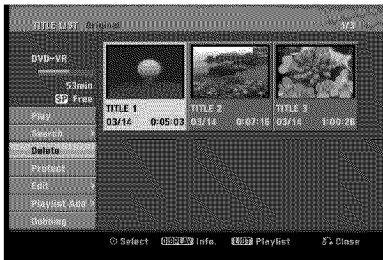

3. Press **ENTER** (⊙) to confirm.
The confirm message for deleting will appear.
4. Use ◀ / ▶ to select [OK] then press **ENTER** (⊙).
The selected chapter or title is deleted.
After pressing **ENTER** (⊙), the new, updated menu is displayed.
5. Repeat steps 1 - 4 to continue to delete from the menu.
6. Press **RETURN** (↵) repeatedly to exit the menu.

Notes

- When DVD+RW recording, the deleted title's name is changed to [Deleted Title].
- If more than two titles are repeatedly deleted, the titles are combined into one.
- When you are deleting a title or chapter, only the last one on DVD+R/RW, DVD-RW (Video mode) increases remaining recording time.
- The Chapter delete function is only available on DVD-RW(VR mode) and DVD-RAM.

Deleting a Part **-RW/VR** **RAM**

You can delete a part which you do not want in the title.

1. Use ◀ / ▶ / ▲ / ▼ to choose a title you want to delete on the Title List menu then press **ENTER** (⊙).
The options appears on the left side of the menu.
2. Select [Edit] > [Delete Part] option then press **ENTER** (⊙).
[Edit] menu appears on the TV screen.
Example: Edit (Delete Part) (DVD-VR)



3. Use play, pause step, search and slow-motion to find the starting point.
4. Press **ENTER** (⊙) at the starting point of the section you want to delete.
[End Point] icon is highlighted.
The part is indicated on the Progress Bar.
5. Use play, pause step, search and slow-motion to find the ending point.
6. Press **ENTER** (⊙) at the ending point of the section you want to delete.
You can cancel the selected point, use ▲ / ▼ to select [Cancel] icon then press **ENTER** (⊙).
7. If you finish to edit, select [Done] icon then press **ENTER** (⊙).
The confirm message for deleting will appear.
Use ◀ / ▶ to select [OK] then press **ENTER** (⊙).
The selected part is deleted from the title and Title List menu appears.

Notes

- It may not be possible to delete parts that are less than 5 seconds long.
- If you select [Cancel] then press **ENTER** (⊙), the Recorder will go to previous option and into Pause mode.

Naming a Title

-RWVR -RWVideo +RW +R -R RAM

You can name the titles.

1. Choose the title you want to name on the Title List menu, then press **ENTER** (⊙).
The menu options appears on the left side of the menu.
2. Use **▲/▼** to select [Edit] > [Title Name] option then press **ENTER** (⊙).
Keyboard menu appears.



3. Enter a name for the title. Use **◀/▶/▲/▼** to select a character then press **ENTER** (⊙) to confirm your selection.
 - **Language:** Selects a keyboard type.
 - **Space:** Inserts a space at the cursor position.
 - **Delete:** Deletes the character to the left of the cursor position.
 - **◀/▶:** Moves the cursor left or right.
 - **OK:** Confirms the name you have entered.
 - **Cancel:** Deletes all characters and exits the Keyboard menu.

Tips

Remote Control buttons for entering a name

- **PLAY (▶):** Inserts a space at the cursor position.
 - **PAUSE/STEP (II):** Deletes the character to the right of the cursor position.
 - **SKIP (I◀◀ / ▶▶I):** Moves the cursor left or right.
 - **STOP (■), CLEAR:** Deletes the character to the left of the cursor position.
 - **0-9:** Enters the character corresponding to the selected column.
 - **DISC MENU/LIST, DISPLAY:** Switches the keyboard type.
4. Choose [OK] then press **ENTER** (⊙) to fix the name and return to the previous menu screen.
 5. Press **RETURN** (↵) repeatedly to exit the menu.

Notes

- Names can be up to 32 characters long.
- For discs formatted on a different recorder, you will see only a limited character set.
- When recording on DVD-R, DVD-RW or DVD+R discs, the entered name is displayed on the DVD player only after finalization.

Time Search

-RWVR -RWVideo +RW +R -R RAM

You can select start point of the title.

1. Choose Use **◀/▶/▲/▼** to choose a title on the TITLE LIST menu then press **ENTER** (⊙).
The options appears on the left side of the menu.
2. Choose Select [Search] > [Time] option then press **ENTER** (⊙).
[Time] menu appears on the TV screen.

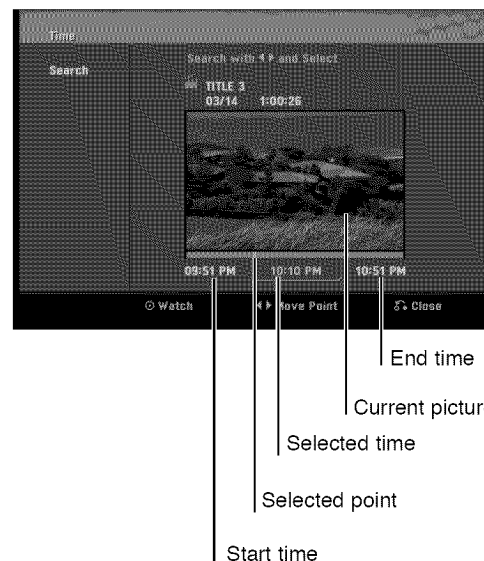

3. Choose Use **◀/▶** to find the point you want to start.
The point increase 1 minute step.
If you press and hold **◀/▶** then the point increase 5 minute step.
4. Choose Press **ENTER** (⊙) to start selected point.

Moving a Playlist Chapter

-RWVR **RAM**

Use this function to re-arrange the playing order of Playlist chapters on the Chapter List-Playlist menu.

Note

This function is not available if there is only one chapter.

1. Select a chapter on the Chapter List-Playlist menu.
2. Press **ENTER** (⊙).
The menu options appears on the left side of the menu.
3. Use **▲** / **▼** to select [Move] option from Playlist options then press **ENTER** (⊙).



4. Use **◀** / **▶** / **▲** / **▼** to choose the place you want to move the chapter then press **ENTER** (⊙).
After pressing **ENTER** (⊙), the updated menu is displayed.

Hide a Chapter/Title **+RW** **+R**

You can skip playing chapters or titles without deleting from the disc.

1. Use **◀** / **▶** / **▲** / **▼** to choose a chapter or title you want to hide on the [TITLE LIST] or [Chapter List] menu, then press **ENTER** (⊙).
Options appear on the left side of the screen.
2. Select [Edit] > [Hide] option.
Example: Title List (DVD+RW)

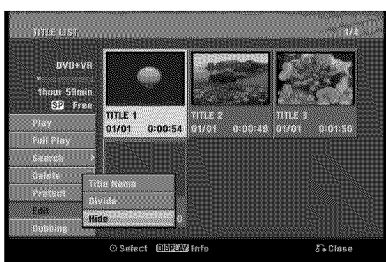

3. Press **ENTER** (⊙) to confirm.
The chapter's or title's thumbnail will dim.

Note

If you select a hidden chapter or title on the TITLE LIST or Chapter List menu, you can 'show' it by choosing [Show] option on the menu. After doing that, you are able to see the chapter or title.

Tip

You can play hidden chapter or title using [Full Play] option in the menu.

Protect a Title

+RW **+R** **-RWVR** **RAM**

Use this function to protect against accidental recording, editing or deleting of the title.

1. Press **DISC MENU/LIST** to display the [TITLE LIST] menu.
2. Use **◀** / **▶** / **▲** / **▼** to choose a title you want to protect then press **ENTER** (⊙).
Options appear on the left side of the screen.
3. Select [Protect] from the options.
Example: Title List (DVD-VR)



4. Press **ENTER** (⊙) to confirm.
The lock mark will appears on the title's thumbnail.

Note

If you select a title that has already been protected on the Title List menu, you can 'unprotect' it by choosing [Unprotect] option from the Title List menu options. After doing that, you can edit and delete the title.

Divide One Title Into Two

+RW

Use this command to split a title up into two new titles.

1. On the Title List menu, select a title you want to divide then press **ENTER** (⊙).
The menu options appears on the left side of the screen.
2. Select [Edit] > [Divide] option.
Example: Title List (DVD+RW)

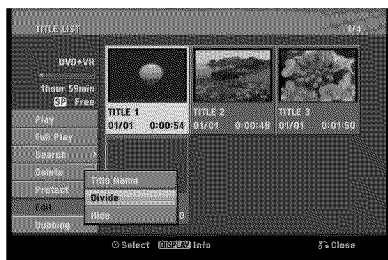

3. Press **ENTER** (⊙).
[Edit (Divide)] menu appears.

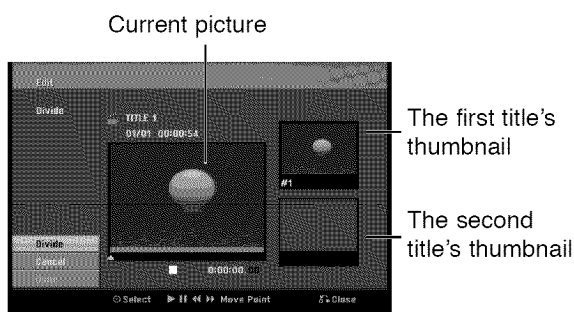

4. Use play, pause step, search and slow-motion to find the point you want to divide the title.
5. Select [Divide] option then press **ENTER** (⊙) at the point.
To reset the point, select [Cancel] option then press **ENTER** (⊙). Repeat from step 4.
6. Choose [Done] option then press **ENTER** (⊙) to fix the dividing point.
The title is divided into two new titles. It take up to 4 minutes to divide.

Note

The dividing point may not be selected if the point is less than 3 seconds long.

Combining Two Chapters Into One

-RWVR +RW +R RAM

Use this function to combine two adjacent chapters into one.

1. On the Chapter List menu, select the second chapter of the two chapters you want to combine then press **ENTER** (⊙).
The menu options appears on the left side of the screen.
2. Use **▲ / ▼** to select [Combine] option.
The combine indicator appears between the two chapters you want to combine.
Example: Title List (DVD-VR)



3. Press **ENTER** (⊙) to combine the chapters.
4. Repeat steps 1 - 3 to continue to combine from the menu.
5. Press **RETURN** (↵) repeatedly to exit the menu.

Notes

This function cannot operate listed as below;

- If there is only one chapter within the title.
- If you select first chapter.
- If two chapters created by erasing a part from an original title.
- If two chapters created from different titles.
- If two chapters created by moving an order from an original title.

Overwriting Recording **+RW**

To overwrite a new video recording on a previously recorded title, follow these steps. This feature is not available for DVD+Rs, that always record at the end of the Disc.

1. Select input source you want to record (TV channel, AV1, AV2, DV).
2. Press **DISC MENU/LIST** to display the TITLE LIST menu.



3. Use **▲ / ▼ / ◀ / ▶** to choose a title you want to overwrite.
4. Press **● REC** to start overwrite recording. Overwrite recording starts from the start point of the title.
5. Press **■ STOP** to stop the overwrite recording. The new title is created and updated menu is displayed.

Notes

- This function is not available for a protected title.
- If you overwrite the longer recording than the current title on the fully recorded disc, the next title is overwritten.
- If next title is protected, the overwriting stops at the starting point of the title.

Viewing Title List menu displayed on other DVD Recorders or Players **+RW +R**

You can view the Title List menu displayed on the other DVD player that is capable of playing DVD+RW or DVD+R discs.

1. Insert DVD+R or DVD+RW disc recorded already.

2. On DVD mode, press **TITLE** in Play mode or Stop mode.

Title List menu will appear as shown below.



3. To play back a title, select the title you want then press **ENTER (⊙)** or **PLAY (▶)**.

Tip

You can remove the Title List menu by pressing **STOP (■)**.

Playing Your Recordings on Other DVD Players (Finalizing a Disc)

Most regular DVD players can play finalized discs recorded in Video mode, finalized DVD+R or DVD+RWs. A small number of players can also play DVD-RW discs recorded in VR mode, finalized or not. Check the manual that came with the other player to check what formats of discs it will play.

Finalizing 'fixes' the recordings and editings in place so that the disc can be played on a regular DVD player or computer equipped with a suitable DVD-ROM drive. Finalizing a Video mode disc creates a menu screen for navigating the disc. The menu can be accessed by pressing **DISC MENU/LIST** or **TITLE**.

To finalize a disc, refer to [Finalize] on page 58.

Notes

- Unfinalized DVD+RW is playable on regular DVD players.
- The edited contents of a DVD+R (DL) disc is compatible on regular DVD players only after finalization.
- Any edited contents of the DVD+R disc are not compatible on regular DVD players. (Hide, chapter combine, added chapter mark, etc.)
- How long finalization takes depends on the type of disc, how much is recorded on the disc, and the number of titles on the disc.
- DVD+R DL disc can take up to 30 minutes to finalize.

VCR Playback

Playing a Tape

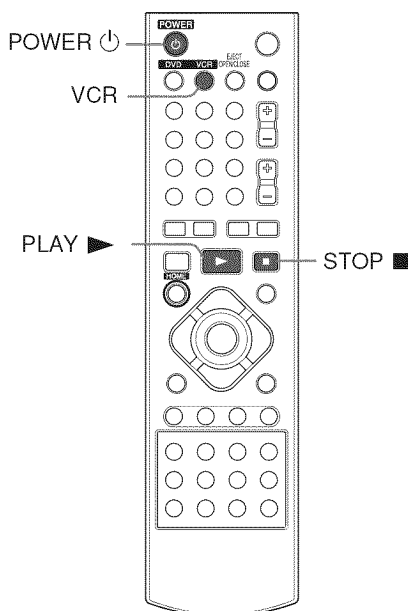

1. Press **VCR** to control the VCR deck.
2. Insert a pre-recorded video cassette.
 - If the unit is powered off, it will power on automatically when the tape is loaded.
 - If the Timer indicator lights on the front panel display window, press **POWER** (⏻) once.
3. Press **PLAY** (▶) to start playback.
 - If a tape without a safety tab is inserted the unit starts playback automatically.
4. Press **STOP** (■) to stop playback.
 - If the tape reaches the end before you press **STOP** (■) the Recorder automatically stops, rewinds and ejects the tape.

Notes

Super video tape Quasi Playback (SQPB)

- This Recorder can play back Super video tape recorded, however, it cannot make recordings using Super video tape format.
- SQPB is an abbreviation for Super video tape Quasi Playback.

VCR Playback Options

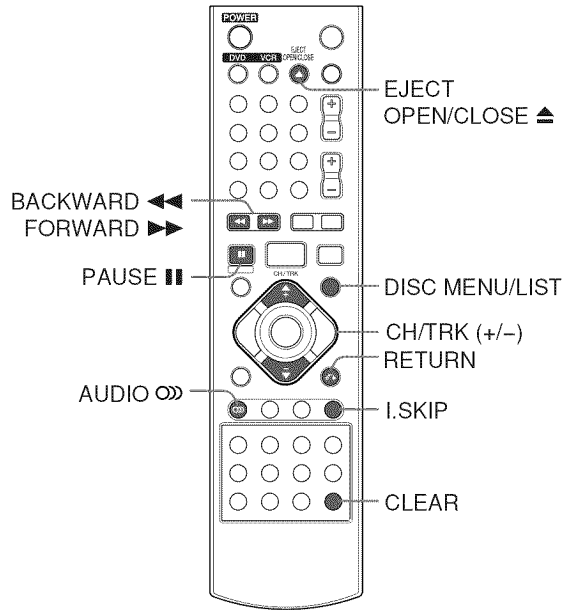

| Buttons | Operations | |
|---------------|--|------------|
| EJECT (▲) | Ejects the tape in the VCR deck. | VCR |
| PAUSE () | Pause playback. Press repeatedly to step forward one frame at a time. <ul style="list-style-type: none"> After 5 minutes in STILL mode the Recorder stops to protect the tape and video heads. | VCR |
| FORWARD (▶▶) | Scan forward. In Stop mode, fast forwards the tape. In Pause mode, starts slow motion playback. <ul style="list-style-type: none"> After 3 minutes in SEARCH mode the Recorder returns to PLAY mode to protect the tape and video heads After 3 minutes in SLOW MOTION mode the Recorder goes back to PLAY mode to protect the tape and video heads. | VCR |
| BACKWARD (◀◀) | Scan backward. In Stop mode, rewinds the tape. <ul style="list-style-type: none"> After 3 minutes in SEARCH mode the Recorder returns to PLAY mode to protect the tape and video heads. | VCR |
| CLEAR | Resets the current tape counter position to 0:00:00. To automatically go to tape counter position 0:00:00, press RETURN while the tape is in Stop mode or in Play mode. | VCR |
| CH/TRK (+/-) | Manually reduces noise on the screen during tape playback. Tracking is set automatically when a tape is inserted. | VCR |
| AUDIO | Sets tape audio to HIFI, LEFT, RIGHT or NORMAL. Use ◀/▶ buttons to select tape audio you want. | VCR |
| I.SKIP | Press repeatedly during playback to skip forward 30 seconds (maximum 180 seconds). | VCR |

VCR Recording

Basic Recording from a TV

Follow the instructions below to record a TV program. Recording starts immediately and continues until the tape is full or you stop the recording.

1. Switch on the Recorder, select the device (VCR) for recording and load a recordable tape. Also make sure that the TV input is set to this recorder.
2. Set a recording mode as necessary by pressing **REC MODE** repeatedly.
VCR: SP, SLP
3. Select the TV channel to record.
4. Use **AUDIO** to select the audio channel for analog channel or audio language for digital channel to record.

The table below shows what will be recorded on the different settings for different types of analog broadcast. The last column (Monitor Audio) shows what you'll hear as it is recording.

| TV Broadcast | Selected Audio | Broadcast Audio | | Monitor Audio |
|--------------|----------------|-----------------|------|---------------|
| | | L Ch | R Ch | |
| MONO | MONO | MONO | MONO | MONO |
| STEREO | STEREO | L | R | STEREO |
| | Left | L | L | Left |
| | Right | R | R | Right |
| MONO+SAP | MONO | MONO | MONO | MONO |
| | SAP | SAP | SAP | SAP |
| STEREO +SAP | STEREO | L | R | STEREO |
| | SAP | SAP | SAP | SAP |
| | MONO | MONO | MONO | MONO |

If you set the audio channel to SAP (Second Audio Program), but there is no SAP channel being broadcast, the main audio (mono or stereo) will be recorded.

5. Press **REC** once to start recording.
The REC indicator lights in the display window.
6. Press **STOP** to stop recording.

Instant Timer Recording

Instant Timer Recording allows you to make a recording easily of a preset length without using the program timer.

1. Follow steps 1-4 as shown left (Basic Recording from a TV).
2. Press **REC** repeatedly to select the recording time length. Recording starts after the first press.
VCR: Each subsequent press increases the recording time by 30 minutes (maximum 540 minutes). Please confirm the VIDEO tape has enough remaining time to be recorded before recording.

Checking the Recording Time

Press **REC** or **DISPLAY** once to check the recording time. The recalled setting will automatically return to the TV screen for a moment.

Also, remaining time of recording is shown in the display window.

To Extend the Recording Time

The recording time can be extended anytime by pressing **REC**.

Each subsequent press increases the recording time by 30 minutes (VCR).

To Pause the Recording

1. Press **PAUSE/STEP** to pause the recording.
2. When you want to continue recording, press **PAUSE/STEP** or **REC**.

Notes

- If you press **PAUSE/STEP** during the Instant Timer Recording, it will be canceled.
- The Recorder will automatically power off when the Instant Timer Recording ends.

Timer Recording

1. Press **HOME** (🏠) and the Home menu appears.
2. Select [TV] > [Timer Record] and press **ENTER** (⊙).



3. Select [NEW] and press **ENTER** (⊙).
The Timer Record menu will appear.



- **[Media]** – Choose a media (VCR).
 - **[Ch.]** – Choose a channel that memorized in this Recorder, or one of the external inputs from which to record (AV1 or AV2).
 - **[Date]** – Choose a date up to 1 month in advance, or select a daily or weekly program.
 - **[Start Time]** – Set the recording start time.
 - **[End Time]** – Set the recording end time.
 - **[Mode]** – Choose a record mode.
VCR: SP, SLP or AT (Auto)
AT(Auto) mode determines how much time is available on the disc or tape and switches record mode, if necessary, to complete recording the program.
 - **[Set-Top Channel]** – Choose a channel or [OFF] for AV1 input timer recording.
For AV1 input timer recording using [Set-Top Channel] option, refer to page 46.
4. Enter the necessary information for your timer recording(s).
 - ◀ / ▶ (left/right) – Move the cursor left/right
 - ▲ / ▼ (up/down) – Change the setting at the current cursor position.
 - Press **RETURN** (↵) to return to the [Timer Record List] menu.
 5. Press **ENTER** (⊙) to save the program.

6. The “Rec. OK” on the [Check] field on the [Timer Record List] menu indicates the timer recording is programmed correctly.
 - **[Rec OK]:** Indicates the Timer Record is in recordable condition.
 - **[No Tape]:** There is no tape in the VCR deck.
 - **[Invalid tape]:** The inserted tape is not recordable.
 - **[Duplicate Date]:** Timer Record is overlapped with another.
7. Press **RETURN** (↵) to exit the [Timer Record List] menu.

Notes

- You must insert a recordable tape.
- The Timer indicator lights on the front panel display.
- The Recorder will record the audio according to the current TV tuner setting. Use AUDIO to select the audio channel for analog channel to record before switching the Recorder to Standby mode.
- For digital TV recording with multiple audio languages, set audio language from the [DTV Audio] in sub-menu of the Setup menu (see page 52).
- The Recorder will automatically power off when the Timer Recording ends.
- There is a short delay when a timer recording finishes to confirm the recorded program. If two timer recordings are set to record sequentially (one right after the other), the very beginning of the later program may not be recorded.
- You must press **STOP** (■) to stop the Timer Recording.
- The Timer Recording function allows you to record up to 16 programs within a period of one month.

Checking Timer Recording Details

Programming can be checked whenever the Recorder is turned on.

1. Press **HOME** (🏠) and the Home menu appears.
2. Select [TV] > [Timer Record] and press **ENTER** (⊙).
3. Use ▲ / ▼ to select a program.
4. Press **ENTER** (⊙) to edit the selected program.
Timer Record menu appears.

Canceling a Timer Recording

You can clear a timer setting anytime before the recording actually starts.

- Use ▲ / ▼ to select a program you want to erase on the [Timer Recorder List] menu, then press **CLEAR** and select [OK] then press **ENTER** (⊙).

AV1 Timer Recording using Set-Top Channel option

1. Connect a Set-Top Box as shown on page 16.
2. Make the necessary settings for the connection as shown on page 56-57.
3. Important, for the Recorder to record programs received through the Set-Top Box, the Set-Top box must remain turned on at all times.
4. Select [TV] > [Timer Record] and press **ENTER** (⊙).

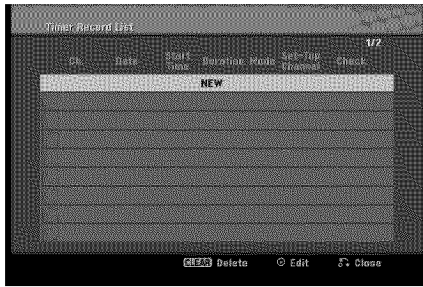

5. Select [NEW] and press **ENTER** (⊙). The Timer Record menu will appear.
6. Enter the necessary information for your timer recording(s).
 - ◀ / ▶ (left/right) – Move the cursor left/right
 - ▲ / ▼ (up/down) – Change the setting at the current cursor position.
 - Press **RETURN** (↵) to exit the Timer Record menu.
7. Set the [Ch.] option to [AV1].

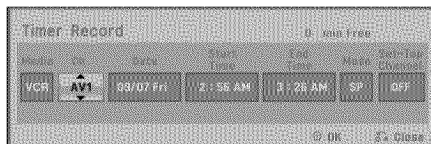

8. Set the [Media], [Date], [Start Time], [End Time], and [Mode] options according to previous page.
9. Set the [Set-Top Channel] option.
 - Select a channel using number or ▲ / ▼ buttons, the Recorder sends commands to change the channel of the connected Set-Top Box through the IR control cable.
 - Select [OFF] using **CLEAR** button, if you do not need the changing the channel of the Set-Top Box.



10. Press **ENTER** (⊙) to save the program.

10. Press **ENTER** (⊙) to save the program.

11. The "Rec. OK" on the [Check] field on the [Timer Record List] menu indicates the timer recording is programmed correctly. "[Check] field according to previous page".

12. Press **RETURN** (↵) to exit the [Timer Record List] menu.

Notes

- You must insert a recordable tape.
- The Timer indicator lights on the front panel display.
- The Recorder will automatically power off when the Timer Recording ends.
- There is a short delay when a timer recording finishes to confirm the recorded program. If two timer recordings are set to record sequentially (one right after the other), the very beginning of the later program may not be recorded.
- You must press **STOP** (■) to stop the Timer Recording.

Checking Timer Recording Details

Programming can be checked whenever the Recorder is turned on.

1. Press **HOME** (🏠) and the Home menu appears.
2. Select [TV] > [Timer Record] and press **ENTER** (⊙).
3. Use ▲ / ▼ to select a program.
4. Press **ENTER** (⊙) to edit the selected program. Timer Record menu appears.

Canceling a Timer Recording

You can clear a timer setting anytime before the recording actually starts.

- Use ▲ / ▼ to select a program you want to erase on the Timer Recorder List, then press **CLEAR** and select [OK] than press **ENTER** (⊙).

If you fail the AV1 Timer Recording

- Make sure IR Control Cable connection. (page 16)
- Set the [Set-Top Box Edit] options again then proceed the [Test] option. (page 56-57)
- If IR control is not activated even though you set again, the Recorder may not control your Set-Top Box according to the device's maker or status. Confirm recommended Set-Top Box on page 16 or contact your Set-Top Box provider.

Recording from External Components

You can record from an external component, such as a camcorder or VCR, connected to any of the Recorder's external inputs.

1. Make sure that the component you want to record from is connected properly to the Recorder. See page 15.
2. Press **INPUT** repeatedly to select the external input to record from.
 - AV1: Audio/Video Input mounted on back panel.
 - AV2: Audio/Video Input mounted on front panel.
 - DV: DV Input mounted on front panel.
3. Load a recordable tape.
4. Set a recording mode as necessary by pressing **REC MODE** repeatedly.
VCR: SP or SLP
5. Press ● **REC** once to start recording.
The REC indicator lights in the display window.
6. Press **STOP** (■) to stop recording.

Notes

- Check that the Audio In settings DV Record Audio are as you want them. See page 56.
- If your source is copy-protected using CopyGuard, you will not be able to record it using this recorder. See Copyright on page 3 for more details.
- Recording continues until you press **STOP** (■) or the disc is full.
- To record for a fixed length of time, see [Instant Timer Recording] on page 44.
- When unit is on any external inputs mode (AV1, AV2 and DV) the **CH +/-** buttons don't work, press **INPUT** (on remote) repeatedly to select the TV mode, and then select the TV channels.

Dubbing

Dubbing from VCR to DVD

You can copy the contents of a Video tape to a DVD using the **DUBBING** button. This allows you to archive your old Video tapes to DVD.

1. Insert a blank DVD disc in the DVD deck and close the disc tray.
2. Insert the video tape you wish to copy into the VCR deck.
3. Select VCR mode by pressing VCR on the remote control or pressing DVD/VCR on the front panel.
4. Find the place on the Video tape from which you want to start dubbing using the PLAY, FF, REW and PAUSE functions. For best results, pause playback at the point from which you want to record.
5. Press the **DUBBING** button.
The Dubbing menu appears.

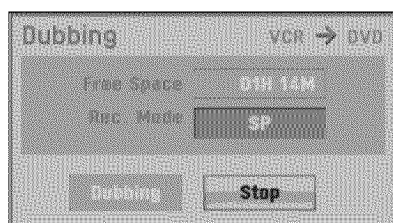

6. Use **▲ / ▼ / ◀ / ▶** to select the desired Record Rec. Mode: XP, SP, LP, EP or MLP.
7. Select [Dubbing] then press **ENTER (⊙)** or **DUBBING** to start copying.
8. To stop dubbing at any other time, press **STOP (■)**.
Dubbing will stop automatically when the Video tape ends.

Note

If the video tape you are attempting to copy is copy protected, you will not be able to copy the tape. It is not permitted to copy Macrovision encoded tapes.

Tip

If you press PAUSE during Dubbing mode, both the DVD and VCR decks go into Pause mode and the **DUBBING** button blinks on the front panel. While in Pause mode, you can adjust the VCR playback position using PLAY, REW, FF, PAUSE/STEP, etc. The DVD deck will remain in Pause mode.
To resume Dubbing, press the **DUBBING** button twice.

Dubbing from DVD to VCR

You can copy the contents of a DVD to a Video tape using the **DUBBING** button.

1. Insert a blank video tape into the VCR deck.
2. Insert the disc you wish to copy in the DVD deck and close the disc tray.
3. Select DVD mode by pressing DVD on the remote control or pressing DVD/VCR on the front panel.
4. Find the place on the DVD (or Disc) from which you want to start dubbing using the PLAY, FF, REW and PAUSE functions.
For best results, pause playback at the point from which you want to record.
5. Press the **DUBBING** button.
The Dubbing menu appears.



6. Use **▲ / ▼ / ◀ / ▶** to select the desired Record Rec. Mode: SP or SLP (3 times SP).
7. Select [Dubbing] then press **ENTER (⊙)** or **DUBBING** to start copying.
8. To stop dubbing at any other time, press **STOP (■)**.
You must stop the dubbing process manually when the DVD movie ends, or the unit may replay and record over and over again.

Note

If the DVD (or Discs) you are attempting to copy is copy protected, you will not be able to copy the disc. It is not permitted to copy Macrovision encoded DVDs (or Discs). [Copy-protected. Cannot record.] is displayed on the TV screen.

Tip

If you press PAUSE during Dubbing mode, both the DVD and VCR decks go into Pause mode and the **DUBBING** button blinks on the front panel. While in Pause mode, you can adjust the DVD playback position using PLAY, REW, FF, PAUSE/STEP, etc. The VCR deck will remain in Pause mode. To resume Dubbing, press the **DUBBING** button twice.

Recording from DV Input

Before DV dubbing

You can connect a DV-equipped camcorder to this recorder using a single DV cable for input and output of audio, video, data and control signals.

- This recorder is only compatible with DV-format (DVC-SD, DV25) camcorders. Digital satellite tuners and Digital VIDEO video recorders are not compatible.
- You cannot connect more than one DV camcorder at a time to this recorder.
- You cannot control this recorder from external equipment connected via the DV IN jack (including two recorders).
- It may not always be possible to control the connected camcorder via the DV IN jack.
- Digital camcorders can usually record audio as stereo 16-bit/48kHz, or twin stereo tracks of 12-bit/32kHz. This recorder can only record one stereo audio track. Set [DV Record Audio] option to Audio 1 or Audio 2 as required (see page 56).
- Audio input to the DV IN jack should be 32 or 48kHz (not 44.1kHz).
- Picture disturbance on the recording may occur if the source component pauses playback or plays an unrecorded section of tape, or if the power fails in the source component, or the DV cable becomes disconnected.

Recording from a Digital Camcorder

You can record from a digital camcorder connected to the DV IN jack on the front panel of this recorder.

Using the recorder's remote, you can control both the camcorder and this recorder.

Before recording, make sure that the audio input for the DV IN jack is set up (see page 56).

Tips

- The source signal must be DVC-SD format.
 - Some camcorders cannot be controlled using this recorder's remote.
 - If you connect a second recorder using a DV cable, you cannot control the second DVD from this one.
 - You cannot control this unit remotely from a component connected to the DV IN jack.
 - You cannot record date and time information from a DV cassette.
 - Disconnecting the DV cable while recording a contents of the connected digital camcorder may result in malfunction.
1. Make sure your digital camcorder is connected to the front panel DV IN jack. See page 15.

2. Check that the DV audio input is as you require. You can choose between Audio 1 (original audio) and Audio 2 (overdubbed audio).
 - DV Input is set from the DV Record Audio in sub-menu of the Setup menu. See DV Record Audio on page 56 for more information.
3. Press **INPUT** repeatedly to select the DV input.
4. Find the place on the camcorder tape that you want to the recording to start from. For best results, pause playback at the point from which you want to record.
 - Depending on your camcorder, you can use this recorder's remote to control the camcorder using the STOP, PLAY, BACKWARD, FORWARD and PAUSE functions.
5. Press **REC** once to start recording.
 - Recording is automatically stopped if the recorder detects no signal.
 - You can pause or stop the recording by pressing **PAUSE/STEP (II)** or **STOP (■)**. You cannot control the camcorder from this Remote Control during recording.
 - In Video mode, the final frame of the recording may remain displayed on screen for a while after recording stops.

Notes

- Depending on the connected camcorder, you may not be able to control it using the Remote Control supplied with this recorder.
- Before you set the mode of your Camcorder to camera mode, turn down the volume of connected Sound device. There can be a howling sound.

DV-Related Messages

You may see the following messages appear on your TV screen when using the DV IN jack.

- **Not connected to Camcorder.**
The camcorder is not connected properly, or the camcorder is switched off.
- **Too many devices connected.**
The DV jack on this recorder supports connection to just one camcorder.
- **Check the tape.**
There is no cassette loaded into the connected equipment.
- **Uncontrollable device.**
This recorder cannot control the camcorder.
- **Updating the information.**
Camcorder is updating the information for DV.
- **Camera mode.**
Camcorder is set to camera mode.

Settings and Adjustments

Initial Settings

In this menu system, there are several ways to customize the settings provided. Most menus consist of three levels to set up the options, but some require greater depth for the variety of settings.

1. Press **HOME** (🏠) and the Home menu appears.
2. Select [Setup] > [Start] and press **ENTER** (⊙).

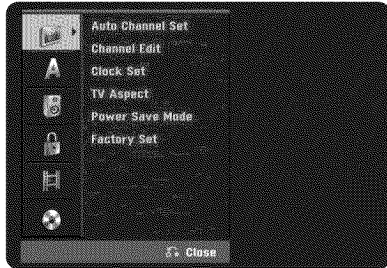

3. Use ▲ / ▼ to select the desired option.
4. While the desired item is selected, press ▶ to move to the second level.
5. Use ▲ / ▼ to select the second desired option.
6. Press ▶ to move to the third level.

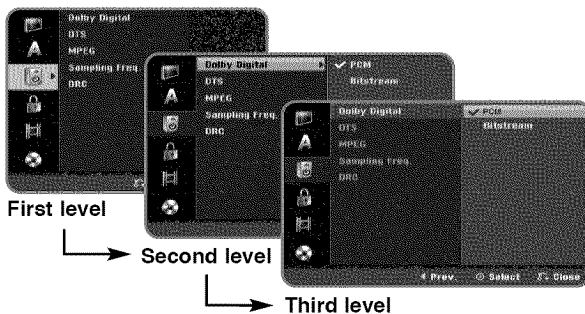

7. Use ▲ / ▼ to select the desired setting then press **ENTER** (⊙) to confirm your selection. Some items require additional steps.
8. Press **RETURN** (↵) or **HOME** (🏠) to exit the Setup menu.

Note

Press ◀ to go back to the previous level.

General Settings

Auto Channel Set

This recorder is equipped with a frequency synthesized tuner capable of receiving the analog and digital channels.



1. Select the [Auto Channel Set] option then press ▶.
2. Use ▲ / ▼ to select the tuning band (TV or CATV) option.
TV is for over-the-air antenna reception.
CATV is for cable subscribers.
3. Press ▶ to highlight [Start] icon.
4. Press **ENTER** (⊙) to begin the channel search. You can skip the analog channel scanning by pressing ▶ while scanning analog channel. The tuner will automatically cycle through all available channels in the area and place them in the tuner's memory.

Notes

- If you want to change the [Band] option, you must execute the auto channel search after changing the [Band] option.
- This Recorder supports only unencrypted channels for cable subscribers.

Channel Edit

You can edit a channel manually (add, delete, etc.).

1. Select the [Channel Edit] option then press ▶.
2. Press **ENTER** (⊙) while the [Edit] icon is highlighted. The Channel List menu appears.

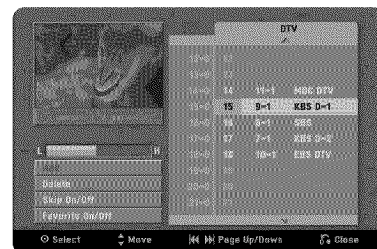

3. Use ◀ / ▶ / ▲ / ▼ to select a channel number then press **ENTER** (⊙).

4. Use ▲ / ▼ to select an option then press **ENTER** (⊙).

- **[Add]** Adds a unmemorized channel manually.
- **[Delete]** Deletes a memorized channel from channel list. A digital channel has multiple channels, so if you delete the digital channel, all multiple channels will be deleted.
- **[Skip On/Off]** (for memorized digital channel only) Set the channel to the skipped channel. The skipped channel number will dim. The channel cannot be selected using the CH (+/-) button during normal TV viewing.
- **[Favorite On/Off]** Set the memorized channel to favorite channel. (favorite channel shows **FAV** icon.)
- **[MFT Adjust]** (for memorized analog channel only) To obtain a clearer picture, tune the MFT option.

5. Press **RETURN** (↵) repeatedly to exit Channel List menu.

Clock Set

You can set the clock.

1. Select the [Clock Set] option then ►.
2. Enter the necessary information for year, date and time.
 - ◀ / ► (left/right): Moves the cursor to the previous or next column.
 - ▲ / ▼ (up/down): Changes the setting at the current cursor position.
3. Press **ENTER** (⊙) to confirm your setting.

TV Aspect

- **[4:3 Letter Box]:** Select when a standard 4:3 TV is connected. Displays theatrical images with masking bars above and below the picture.



- **[4:3 Pan Scan]:** Select when a standard 4:3 TV is connected. Displays pictures cropped to fill your TV screen. Both sides of the picture are cut off.

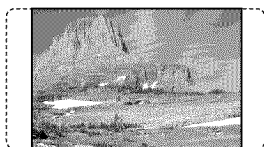

- **[16:9 Wide]:** Select when a 16:9 wide TV is connected.



Power Save Mode

Selects whether this unit is in power save mode when the power is turned off. This option is not available when a timer recording is set.

- **[ON]:** The front panel display is turned off and only signals arriving at the antenna input are passed through when the unit is turned off.
- **[OFF]:** Turns off the [Power Save Mode].

Factory Set

You can reset the Recorder to its original factory settings.

1. Select the [Factory Set] option.
2. Press ► to select [SET] then press **ENTER** (⊙).
3. Select [OK] and press **ENTER** (⊙).
4. Follow the Initial Setup Wizard on page 17.

Language Settings

Note

You can set [DTV Caption], [DTV Caption Style], [DTV Caption Option] and [DTV Audio] options only while viewing digital TV.

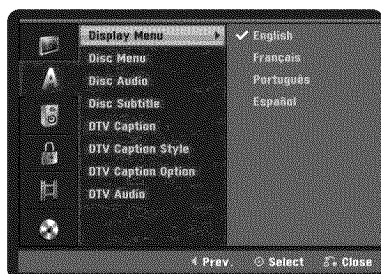

Display Menu

Select a language for the Setup menu and information display.

Disc Menu / Audio / Subtitle

- **[Original]:** Refers to the original language in which the disc was recorded.
- **[Others]:** To select another language, press number buttons then **ENTER** (⊙) to enter the corresponding 4-digit number according to the language code list in the reference chapter (see page 63). If you enter the wrong language code, press **CLEAR**.
- **[OFF]** (for Disc Subtitle): Turn off Subtitle.

DTV Caption

Digital channels sometimes provide caption, often in a different language. You can set a default caption language with this setting. If you select [Off], DTV Caption is not displayed.

Note

DTV caption will appear only if provided by the broadcaster.

Tips

- If available, you can also select a caption language while viewing digital TV viewing, press **SUBTITLE** (⊞) repeatedly.
- If captions are available, the DTV caption icon (⊞) appears on the channel information display to indicate that you can select one of those captions with the **SUBTITLE** (⊞) button.
- Analog Caption is not displayed on this Recorder. If your TV has the Analog Caption function, you can switch the Analog Caption using the TV. If analog and digital caption is overlapped on the TV screen, switch off one of two captions.

DTV Caption Style

Selects the style for caption.

- **[Set by program]** Default caption type provided by a broadcaster is shown when captions appear.
- **[Custom]** Customized text is shown when captions appear. Use [DTV Caption Option] to customize the caption type.

DTV Caption Option

You can set [DTV Caption Option] only when [DTV Caption Style] is selected in [Custom].

- **[Font]:** Selects the font type for captions.
- **[Size]:** Selects the font size for captions.
- **[Color]:** Selects the font color for captions.
- **[Opacity]:** Selects the font opacity for captions.
 - Solid: The text is solid (without any transparency).
 - Flash: The text blinks once a second.
 - Transparent: The text is transparent (In this case, whatever the color is, the color does not affect the captions display).
 - Translucent: The text is translucent.
- **[BG (Background) Color]:** Selects the background color for captions.
- **[BG (Background) Opacity]:** Selects the background opacity for captions.
 - Solid: The text background color is solid (without any transparency).
 - Flash: The text background color blinks once a second.
 - Transparent: The text background color is transparent (In this case, whatever the background color is, the color does not affect the captions.).
 - Translucent: The text background color is translucent.
- **[Edge Type]:** Selects the edge type for captions.
 - None: The text has no edge.
 - Raised: The text is raised.
 - Depressed: The text is depressed.
 - Uniform: The text has a uniform edge.
 - Left Shadow: The text has a left-shadow edge.
 - Right Shadow: The text has a right-shadow edge.
- **[Edge Color]:** Selects the edge color for captions.

DTV Audio

Digital channels sometimes provide multiple audio tracks, often in a different language. You can set a default audio language with this setting.

Tip

If provided by the broadcaster, the **MULTILINGUAL** (DTV Multiple Audio Icon) appears on the channel information display to indicate that you can select one of those audio languages with the **AUDIO** button.

Audio Settings

Each DVD disc has a variety of audio output options. Set the Recorder's Audio Output according to the type of audio system you use.

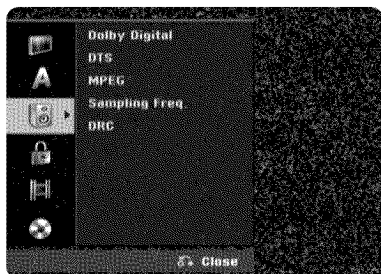

Dolby Digital / DTS / MPEG

- **[Bitstream]:** Select [Bitstream] if you connect the DVD+VCR's DIGITAL AUDIO OUTPUT jack to an amplifier or other equipment with a Dolby Digital, DTS or MPEG decoder.
- **[PCM]** (for Dolby Digital / MPEG): Select when connected to a two-channel digital stereo amplifier. DVDs encoded in Dolby Digital or MPEG will be automatically downmixed to two-channel PCM audio.
- **[OFF]** (for DTS): If you select [OFF], the DTS signal is not output through the DIGITAL AUDIO OUTPUT

Sampling Freq. (Frequency)

Selects the sampling frequency of the audio signal.

- **[48 kHz]:** In case of DVD with 96kHz sampling, Output is converted to 48kHz. If your receiver or amplifier is NOT capable of handling 96 kHz signals, select [48 kHz].
- **[96 kHz]:** The digital audio signals are output in their original sampling format.

DRC (Dynamic Range Control)

With the DVD format, you can hear a program's soundtrack in the most accurate and realistic presentation possible, thanks to digital audio technology. However, you may wish to compress the dynamic range of the audio output (the difference between the loudest sounds and the quietest ones). This allows you to listen to a movie at a lower volume without losing clarity of sound. Set DRC to [ON] for this effect.

Lock (Parental Control) Settings

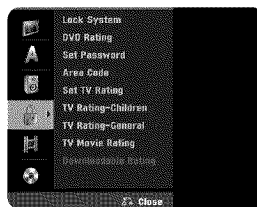

[US Rating]

OR

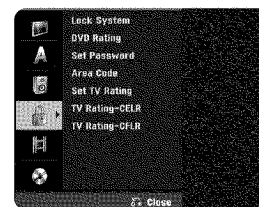

[Canadian Rating]

Notes

- Lock System and TV Rating options are effective for digital TV program only.
- When you set the TV Rating, a program with a TV Rating beyond your rating setting cannot be recorded correctly. (Normal recording, Timer recording, etc.)
- The default TV Rating setting is to allow all programs to be viewed.

Lock System

You can lock certain unsuitable channels to prevent children from accessing them, or set a TV Rating, so that any digital TV program classified above that rating by the broadcaster will be restricted. If the [Lock System] is set to [OFF], TV Rating options are not effective.

The Lock System option is effective for TV Rating and Downloadable Rating options.

1. Select [Lock System] option then press ►.
2. To access the Lock Menu options, you must input the 4-digit password you created. If you have not yet entered a password you are prompted to do so. Input a 4-digit password. Enter it again to verify. If you make a mistake, press **CLEAR**.
3. Select [ON] or [OFF] using the ▲ / ▼ buttons.
4. Press **ENTER** (⊙) to confirm your setting.

DVD Rating

1. Select a rating from 1 to 8 using the ▲ / ▼ buttons. [1]-[8]: Rating one (1) has the most restrictions and rating eight (8) is the least restrictive.

[No Limit]: If you select [No Limit], parental control is not active and the disc plays in full.

2. Press **ENTER** (⊙) to confirm your rating selection, then press **HOME** (🏠) to exit the menu.
3. Press **EJECT, OPEN/CLOSE** (⬆) to activate parental control.

Note

If you set a rating for the recorder, all disc scenes with the same rating or lower are played. Higher rated scenes are not played unless an alternate scene is available on the disc. The alternative must have the same rating or a lower one. If no suitable alternative is found, playback stops. You must enter the 4-digit password or change the rating level in order to play the disc.

Set Password

You can enter or change password.

1. Select [Set Password] option then press ►.
2. Follow step 2 as shown in [Lock System] above.
 - **[Change]:** Enter the new password twice after entering the current password.
 - **[Delete]:** Delete the current password after entering the current password. If you delete password, All of Rating options are set to default.
3. Press **HOME** (🏠) to exit the menu.

Tip If you forget your password

If you forget your password you can reset it using the following steps:

1. Press **HOME** (🏠) and the Home menu appears.
2. Select [Setup] > [Start] and press **ENTER** (⊙).
3. Input the 6-digit number [210499]. When the message appears, select [OK] then press **ENTER** (⊙). The password will be reset.
4. Enter a new password as described above.

Note

If you delete your password, all ratings will be reset to the default setting. The default setting is to allow all programs to be viewed in full.

Area Code

Enter the Area Code whose standards were used to rate the DVD video disc, based on the list in the reference chapter (see page 63).

1. Select [Area Code] option then press ►.
2. Follow step 2 as shown [Lock System].
3. Select the first character using ▲ / ▼ buttons.
4. Shift the cursor using ► buttons and select the second character using ▲ / ▼ buttons.
5. Press **ENTER** (⊙) to confirm your area code selection, then press **HOME** (🏠) to exit the menu.

Set TV Rating

Select [US Rating] or [Canadian Rating] to set the TV rating options according to your local broadcast system. The [Set TV Rating] option is effective for digital TV program only.

TV Rating-Children (US Rating)

Prevents children from watching certain children's TV programs according to the rating setting. This rating applies only to TV programs for children. Unless you block TV programs intended for mature audiences in the TV Rating – General menu, your children could view those programs.

1. Select the [TV Rating-Children] option then press ►.
2. Input a password as shown in [Lock System] on page 53.
3. Select the [Age] or [Fantasy Violence] option then press ►.

| | |
|-------------------------|---|
| Age | Selection applies regardless of content category of rating. |
| Fantasy Violence | Selection applies if TV programs include rating for Fantasy Violence. |

4. Select a rating then press **ENTER** (⊙).

| | |
|---------------------|---|
| TV-Y | All Children. |
| TV-Y7 | Directed toward children age 7 and older. |
| Blocking Off | Permits all programs. |

TV Rating-General (US Rating)

Blocks TV programs that you or your family may not wish to watch, based on the rating scheme set.

1. Select the [TV Rating-General] option then press ►.
2. Input a password as shown in [Lock System] on page 53.
3. Select the [Age], [Dialogue], [Language], [Sex], or [Violence] option then press ►.

| | |
|-----------------|---|
| Age | Selection applies regardless of content category of rating. |
| Dialogue | Selection applies if TV programs have rating for dialogue. |
| Language | Selection applies if TV programs have rating for language. |
| Sex | Selection applies if TV programs have rating for sex. |
| Violence | Selection applies if TV programs have rating for violence. |

4. Select a rating then press **ENTER** (⊙).

| | |
|---------------------|------------------------------|
| TV-G | General audience. |
| TV-PG | Parental guidance suggested. |
| TV-14 | Parents strongly cautioned. |
| TV-MA | Mature audience only. |
| Blocking Off | Permits all programs. |

TV Movie Rating (US Rating)

Blocks movies according to the movie ratings restrictions so children cannot view certain movies. You can set the ratings to block out all the movies with ratings above a specified level. Keep in mind that the movie ratings apply only to movies shown on TV, not TV programs such as soap operas.

1. Select the [TV Movie Rating] option then press ►.
2. Input a password as shown in [Lock System] on page 53.
3. Select a rating then press **ENTER** (⊙).

| | |
|---------------------|---|
| G | General audiences All ages admitted. |
| PG | Parental guidance suggested. Some material may not be suitable for children. |
| PG-13 | Parents strongly cautioned Some material may not be appropriate for children under 13. |
| R | Restricted under 17 requires accompanying parent or adult guardian. |
| NC-17 | No one 17 and under admitted. |
| X | No one 17 and under admitted (Adult only). |
| Blocking Off | Permits all programs. |

Downloadable Rating (US Rating)

The rating information can be updated if a TV station sends the downloadable rating information.

Note

Downloadable Rating is a technology that allows digital TV stations to create and deliver new rating systems in the future if they choose.

1. Select the [Downloadable Rating] option then press ►.
2. Input a password as shown in [Lock System] on page 53.
3. Select a rating title or TV rating then press ►.
4. Select a rating then press **ENTER** (⊙).

Notes

- If rating information is not downloaded from a TV station, the Downloadable Rating option will not be available.
- Rating information is automatically downloaded while watching DTV channels. It may take several seconds.
- The Downloadable Rating option is available for use after rating information is downloaded from a TV station. However, depending on the information from a TV station, it may not be available for use.
- Rating levels may differ depending on the broadcasting station.
- The default option name and Downloadable Rating changes depending on the downloaded information.
- The on-screen display for Downloadable Rating options will appear with a language that TV station sends.
- The rating titles (For example: Humor, etc) and TV ratings (For example: MH, H, VH, etc) may differ depending on the TV station.

TV Rating-CELR (Canadian Rating)

(CELR: Canadian English Language Rating system)

1. Select the [TV Rating-CELR] option then press ►.
2. Input a password as shown in [Lock System] on page 53.
3. Select a rating then press **ENTER** (⊙).

| | |
|---------------------|---|
| E | Exempt TV program includes: news, sports, documentaries and other information program, talk shows, music videos, and variety program. |
| C | Program intended for children under age 8. |
| C8+ | Program generally considered acceptable for children 8 years and over to watch on their own. |
| G | General audience. |
| PG | Parental guidance. |
| 14+ | Program contains themes or content which may not be suitable for viewers under the age of 14. |
| 18+ | Adult program. |
| Blocking Off | Permits all programs. |

TV Rating-CFLR (Canadian Rating)

(CFLR: Canadian French Language Rating system)

1. Select the [TV Rating-CFLR] option then press ►.
2. Input a password as shown in [Lock System] on page 53.
3. Select a rating then press **ENTER** (⊙).

| | |
|---------------------|---|
| E | Exempt TV program |
| G | General - Program intended for audience of all ages. |
| 8 ans+ | Not recommended for young children. |
| 13 ans+ | Program may not be suitable for children under the age of 13. |
| 16 ans+ | Program is not suitable for children under the age of 16. |
| 18 ans+ | Program restricted to adults. |
| Blocking Off | Permits all programs. |

Recording Settings



Disc Record Mode

You can set the picture quality for recording; XP (High Quality), SP (Standard Quality), LP (Low Quality), EP (Extend Quality) MLP (Maximum Long Play). (see page 71).

1. Select the [Disc Record Mode] option then press ►.
2. Use ▲ / ▼ to select a desired Disc Record Mode (XP, SP, LP, EP or MLP).
3. Press **ENTER** (⊙) to confirm your selection, then press **HOME** (🏠) to exit the menu.

VCR Record Mode

You can set the picture quality for VCR recording; SP (Standard Play), SLP (Super Long Play). (see page 71).

1. Select the [VCR Record Mode] option then press ►.
2. Use ▲ / ▼ to select a desired VCR Record Mode (SP or SLP).
3. Press **ENTER** (⊙) to confirm your selection, then press **HOME** (🏠) to exit the menu.

DV Record Audio

You need to set this if you have a camcorder using 32kHz/12-bit sound connected to the front panel DV IN jack. Some digital camcorders have two stereo tracks for audio. One is recorded at the time of shooting; the other is for overdubbing after shooting.

- **[Audio 1]:** On the sound that was recorded while shooting is used.
- **[Audio 2]:** On the overdubbed sound is used.

Auto Chapter

During recording, chapter markers are added automatically at fixed intervals. You can set this interval to 5 minutes or 10 minutes. To turn off automatic chapter marking, select [None].

- **[None]:** To turn off automatic chapter marking.
- **[5 Min]:** Sets the intervals to 5 minutes.
- **[10 Min]:** Sets the intervals to 10 minutes.

Set-Top Box Control

Select [ON] when you connect a Set-Top Box (Cable Box, Satellite Box, Digital Video Recorder, etc) with IR control cable. If not, select [OFF].

Set-Top Box Edit

This setting is available only if the [Set-Top Box Control] option is set to [ON]. If you connect the Recorder to the Set-Top Box as described in page 16 so the Recorder can change the channels on the connected Set-Top Box when timer recording of AV1 input starts.

1. Select [Set-Top Box Edit] on the setup menu then press ►. The [Edit] icon is highlighted.
2. Press **ENTER** (⊙) while the [Edit] icon is highlighted. [Set-Top Box Control] menu shows the current settings.

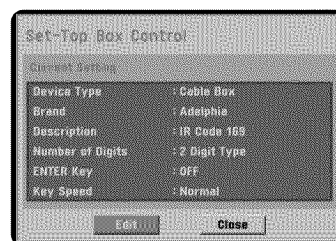

3. If you want to edit the settings, use ◀ / ▶ to select [Edit] icon then press **ENTER** (⊙). The [Set-Top Box Edit] menu appears.

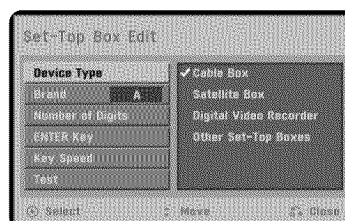

4. Use ▲ / ▼ to select a main option then press **ENTER** (⊙).
 - **[Device Type]** Selects the device type.
 - **[Brand]** Selects the brand of the Set-Top Box.
 - **[Number of Digits]** Selects the number of digits of the Set-Top Box's channel.
 - **[Enter Key]** If your device needs ENTER key to change channels, select [ON]. If not, select [OFF].
 - **[Key Speed]** Select a Key Speed that the recorder sends commands to the connected Set-Top Box.
5. Use ▲ / ▼ to select a sub option then press **ENTER** (⊙).
6. Use ▲ / ▼ to select [Test] option then press **ENTER** (⊙) to verify the connections/settings between the Set-Top Box and the Recorder. The recorder is tuned to AV1 automatically. See right for details.

Test Procedure



- 1) Check the IR control cable connection then press **ENTER** (⊙). (Refer to page 16.)

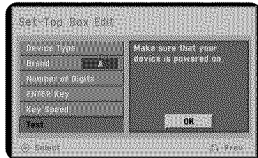

- 2) Turn on the Set-Top Box then press **ENTER** (⊙).



- 3) Use ◀ / ▶ a Remote Control Code of the device then press **ENTER** (⊙).

The list of codes displayed onscreen are based on the device type and brand you selected. Each brand of the device can have multiple sets of codes. One code will be tested at a time; if the code does not work, select another code to test.



- 4) Use ▲ / ▼ / ◀ / ▶ and **ENTER** (⊙) to select a channel.



- 5) Confirm that your Set-Top Box's channel is changed to the selected channel in step 4.

If changed, select [Yes] then press **ENTER** (⊙).
If not changed, select [No] then press **ENTER** (⊙) and repeat from step 3.

- Some Set-Top boxes may not be controlled if the device needs sub channel input - the same as 19-1.



- 6) The Test procedure is complete, press **ENTER** (⊙) to exit the menu.

Tips If you fail to test

- Make sure IR Control Cable connection. (page 16)
- Set the [Set-Top Box Edit] options again then proceed to the [Test] option.
- If IR control is not activated even though you set again, the Recorder may not control your Set-Top Box according to the device's maker or status.
Confirm recommended Set-Top Box on page 16 or contact your Set-Top Box provider.

Disc Settings

Initialize

If you load a completely blank disc, the recorder will initialize the disc.

- DVD-R: The recording mode will always be Video mode.
- DVD-RW/ DVD+RW/DVD+R(DL)/DVD-RAM: The Initialize menu will appear. Select [OK] then press **ENTER** (⊙). DVD-RW disc is initialized to Video mode.

Also, you can reformat the DVD-RW/DVD+RW/ DVD-RAM from the Setup menu as below.



1. Select the [Initialize] option then press **▶**. [Start] icon is highlighted.
2. Press **ENTER** (⊙).
 - In case of DVD-RW, use **◀ / ▶** to select a desired Disc Initialize Mode (VR Mode or Video Mode) then press **ENTER** (⊙).
 - In case of DVD+RW/DVD-RAM, use **◀ / ▶** to select [OK], and press **ENTER** (⊙). It takes a few moments to format the disc.

Caution

If you want to change the disc format, everything recorded on the disc will be erased.

Finalize

Finalizing 'fixes' the recordings in place so that the disc can be played on a regular DVD player or computer equipped with a suitable DVD-ROM drive.

Finalizing a Video mode disc creates a menu screen for navigating the disc. This is accessed by pressing **DISC MENU/LIST** or **TITLE**.

| Icon | Meaning |
|--------------|--|
| -RW | The finalized DVD-RW discs can be unfinalized so that the disc can be edited or recorded again. |
| +R -R | Once you finalize a disc, you can not edit or record anything on the disc. |
| +RW | Discs are automatically finalized when removed from the unit. The edited contents are playable on DVD+RW compatible players only after finalization. |
| RAM | The finalization does not needed. |

1. Select the [Finalize] option then press **▶**.
2. Press **ENTER** (⊙) while [Finalize] is selected. Finalize menu appears.
3. Select [OK] then press **ENTER** (⊙). The Recorder starts finalizing the disc.

Notes

- Finalization can take up to 3-4 minutes or more depending on the type of disc, how much is recorded on the disc, and the number of titles on the disc.
- DVD+R DL disc can take up to 30 minutes to finalize.

Tips

- If you load a DVD-RW that has already been finalized, you can 'Unfinalize' it by choosing [Unfinalize] from the Finalize menu. After doing this, you can edit and re-record onto the disc.
- You cannot unfinalize a DVD-R and DVD+R (DL) disc.
- If [Disc Protect] option is set to [ON], the finalize is not available. To finalize, set [Disc Protect] option to [OFF].

Disc Label

Use the Disc Label feature to enter a name for the disc. This name appears when you load the disc and when you display disc information on-screen.

- The Disc label can be up to 32 characters long.
- For discs formatted on a different Recorder, you will see only a limited character set.

1. Select the [Disc Label] option then press **▶**. [Edit] icon is highlighted.
2. Press **ENTER** (⊙). Keyboard menu appears. To enter characters, see page 38.

Disc Protect

Depending on the type of disc you are using, Disc Protect allows you to preserve your recordings in a variety of ways:

| Icon | Meaning |
|----------------------------|---|
| +RW | Prevents editing, erasing, or overwriting of existing recordings. Allows regular recording. |
| +R | Prevents editing or erasing of existing recordings. Allows regular recording. |
| -RWVR RAM | Prevents editing, erasing, and regular recording. |

Notes

- Disc Protect is not compatible with DVD-RW discs in Video mode or DVD-R discs.
- If you need to unlock a disc to make edits, select [OFF].

Reference

Remote Control

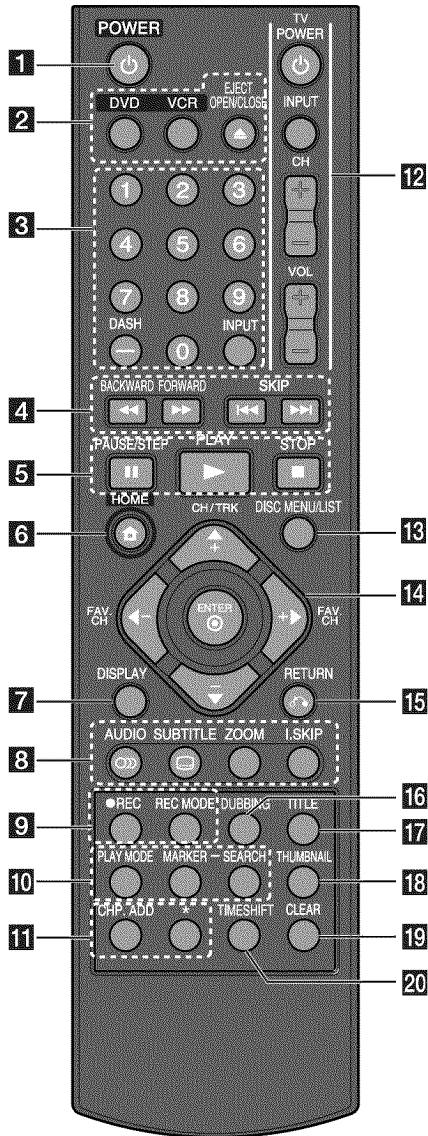

- 1 POWER (⏻):** Switches the unit ON or OFF.
- 2 DVD:** Selects the unit's mode to DVD.
VCR: Selects the unit's mode to VCR.
EJECT, OPEN/CLOSE: Opens and closes the disc tray, and ejects the tape in the VCR deck.
- 3 0-9 numerical buttons:** Selects numbered options in a menu.
DASH (-): Enters a channel number for multiple channels such as 2-1, 2-2, etc.
INPUT: Changes the input source (Tuner, AV1, AV2, or DV IN).

- 4 BACKWARD / FORWARD (◀ / ▶):**
 - DVD: Search backward or forward.
 - VCR: Rewinds/Advances the tape during the STOP mode, for fast reverse/forward picture search.
- SKIP (◀◀ / ▶▶):** Go to next or previous chapter or track.
- 5 PAUSE/STEP (⏸):** Pause playback or recording temporarily.
PLAY (▶): Starts playback.
STOP (■): Stops playback or recording.
- 6 HOME (🏠):** Accesses or removes the HOME menu.
- 7 DISPLAY:** Accesses On-Screen Display.
- 8 AUDIO (🔊):** Selects an audio language or audio channel.
SUBTITLE (🗣): Selects a subtitle language.
ZOOM: Enlarges DVD video image.
I.SKIP (INSTANT SKIP): Skips 30 seconds forward during playback.
- 9 REC (●):** Starts recording.
REC MODE: Selects the recording mode.
- 10 PLAY MODE:** Selects a play mode.
MARKER: Marks any point during playback.
SEARCH: Displays Marker Search menu.
- 11 CHP. ADD:** Inserts a chapter marker when playing/recording.
*: Feature is not available.
- 12 TV Control Buttons:** You can control the sound level, input source, selects TV's channel and power switch of your TV
- 13 DISC MENU/LIST:** Accesses menu on a DVD disc. Switches between Title List-Original and Title List-Playlist menu.
- 14 ◀ / ▶ / ▲ / ▼ (left/right/up/down):** Used to navigate on-screen displays.
ENTER (⊙): Acknowledges menu selection.
CH/TRK (+/-): Scans up or down through memorized channels and adjust tracking.
- 15 RETURN (↶):** Removes the on-screen displays.
- 16 DUBBING:** Press to copy DVD to VCR (or VCR to DVD).
- 17 TITLE:** Displays the disc's Title menu, if available.
- 18 THUMBNAIL:** Selects a thumbnail picture.
- 19 CLEAR:** Removes a mark on the Marker Search menu.
- 20 TIMESHIFT:** To play the title being recorded and also currently being recorded appears as PIP.

Front Panel

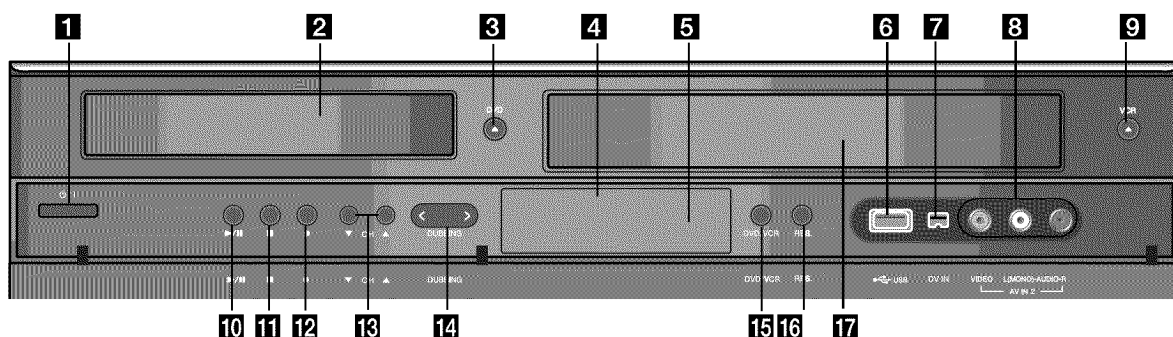

1 **⏻ / I (POWER)**
Switches the Recorder ON and OFF.

2 **Disc Tray (DVD deck)**
Insert a disc here.

3 **⏪ DVD**
Opens or closes the disc tray.

4 **Display window**
Shows the current status of the Recorder.

| | |
|------------|---|
| | Lights when a disc is in the DVD deck. |
| DVD | The DVD deck is selected. |
| | Lights when the Recorder is in playing mode or flashes when search mode. |
| VCR | The VCR deck is selected. |
| | Indicates when the recorder is in timer recording or a timer recording is programmed. |
| | A Video tape is inserted in the VCR deck. |
| REC | The Recorder is recording. |
| PM | Indicates PM time. (AM is not displayed.) |

5 **Remote Sensor**
Point the recorder Remote Control here.

6 **USB Port**
Connect an USB Flash Drive.

7 **DV IN**
Connect the DV output of a digital camcorder.

8 **AV IN 2 (VIDEO /AUDIO (Left/Right))**
Connect the audio/video output of an external source (Audio system, TV/ Monitor, VCR, Camcorder, etc.).

9 **⏪ VCR**
Ejects the tape in the VCR deck.

10 **▶ / ⏸ (PLAY / PAUSE)**
Starts playback.
Pause playback or recording temporarily, press again to exit pause mode.

11 **■ (STOP)**
Stops playback

12 **● (REC)**
Starts recording.
Press repeatedly to set the recording time.

13 **CH (▲/▼)**
Scans up or down through memorized channels.

14 **DUBBING**
Press to copy DVD to VCR (or VCR to DVD).
Lights when the Recorder is dubbing.

15 **DVD/VCR**
Toggles control between the DVD deck and the VCR deck.

16 **RES.**
Sets the output resolution for HDMI and COMPONENT OUTPUT jacks.
- HDMI: 1080p, 1080i, 720p, 480p, 480i
- COMPONENT: 480p, 480i

17 **Cassette Compartment (VCR deck)**
Insert a video cassette here.

Rear Panel

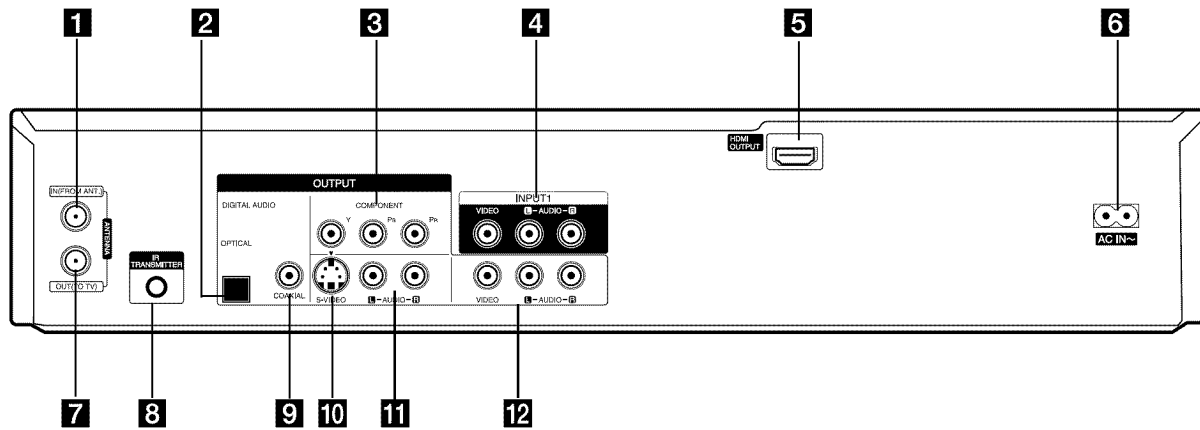

- | | |
|---|--|
| <p>1 ANTENNA IN (FROM ANT.) Connect the antenna to this terminal.</p> <p>2 OPTICAL (DIGITAL AUDIO OUTPUT) Connect to digital (optical) audio equipment.</p> <p>3 COMPONENT OUTPUT (Y P_B P_R) Connect to a TV with Y P_B P_R inputs.</p> <p>4 INPUT 1 (VIDEO/AUDIO (Left/Right)) Connect the audio/video output of an external source (Audio system, TV/Monitor, VCR, Camcorder).</p> <p>5 HDMI OUTPUT HDMI output providing a high quality interface for digital audio and video.</p> <p>6 AC Power Cord Plug into the power source.</p> | <p>7 ANTENNA OUT (TO TV) Connect to a TV with ANTENNA coaxial inputs</p> <p>8 IR TRANSMITTER Connect the IR control cable (if used).</p> <p>9 COAXIAL (DIGITAL AUDIO OUTPUT) Connect to digital (coaxial) audio equipment.</p> <p>10 S-VIDEO OUTPUT Connect to a S-Video Input on TV.</p> <p>11 AUDIO OUTPUT (Left/Right) Connect to a TV or other equipment with audio inputs.</p> <p>12 VIDEO/AUDIO OUTPUT (Left/Right) Connect to a TV with video and audio inputs.</p> |
|---|--|

Caution

Do not touch the inner pins of the jacks on the rear panel.
Electrostatic discharge may cause permanent damage to the unit.

About the Remote Control

Operation Range

Point the Remote Control at the Remote Sensor and press the buttons.

Distance: About 23 ft (7 m) from the front of the Remote Sensor.

Angle: About 30° in each direction of the front of the Remote Sensor.

Battery installation

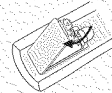

Remove the battery cover on the rear of the Remote Control, and insert R03 (size AAA) battery with ⊕ and ⊖ matched correctly.



Do not mix old and new batteries and never mix different types of batteries such as standard, alkaline, etc.

Using an USB Flash Drive

This unit can play the MP3 / WMA / JPEG / MOVIE files contained in the USB Flash Drive.

Inserting/Removing the USB Flash Drive

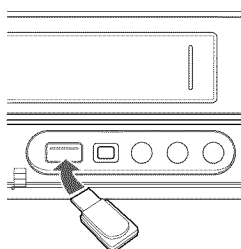

Inserting the USB Flash Drive

Insert straight-in until it fits into place.

Removing the USB Flash Drive

Withdraw the USB Flash Drive carefully when the connected USB Flash Drive is not operating.

Using the USB Flash Drive

1. Insert an USB Flash Drive.
2. Press **HOME** (🏠) on the Remote Control.
3. Select [MUSIC], [PHOTO] or MOVIE option.
4. Select [USB] then press **ENTER** (⊙)
Details for the options are on page 25-28.
5. Press **RETURN** (↩) to exit the MUSIC, PHOTO or MOVIE List menu before extracting the USB Flash Drive.

Compatible USB Flash Drive

1. USB Flash Drive which require additional program installation when you have connected it to a computer, is not supported.
2. USB Flash Drive: USB Flash Drive that support USB1.1.

Notes

- The USB Flash Drive option in the HOME menu is not selectable if the unit is in VCR mode.
- The contents on the disc cannot be moved or copied to USB Flash Drive.
- Keep the USB Flash Drive out of reach of children. If swallowed, seek medical advice immediately.
- This unit supports only USB Flash Drive with FAT16 or FAT32 format.
- The USB Flash Drives which require additional program installation when you have connected it to a computer are not supported.
- This unit is compatible with the Flash type USB device that supports USB 1.1.
- This unit may not support some USB Flash Drives.
- **Do not extract the USB Flash Drive during operation (play, etc.).**
It may cause a malfunction on this unit.

Language Code List

Use this list to input your desired language for the following initial settings: Disc Audio, Disc Subtitle, Disc Menu.

| Language | Code | Language | Code | Language | Code | Language | Code |
|-----------------|------|------------------|------|----------------|------|------------|------|
| Abkhazian | 6566 | Fiji | 7074 | Lingala | 7678 | Singhalese | 8373 |
| Afar | 6565 | Finnish | 7073 | Lithuanian | 7684 | Slovak | 8375 |
| Afrikaans | 6570 | French | 7082 | Macedonian | 7775 | Slovenian | 8376 |
| Albanian | 8381 | Frisian | 7089 | Malagasy | 7771 | Somali | 8379 |
| Ameharic | 6577 | Galician | 7176 | Malay | 7783 | Spanish | 6983 |
| Arabic | 6582 | Georgian | 7565 | Malayalam | 7776 | Sudanese | 8385 |
| Armenian | 7289 | German | 6869 | Maltese | 7784 | Swahili | 8387 |
| Assamese | 6583 | Greek | 6976 | Maori | 7773 | Swedish | 8386 |
| Aymara | 6588 | Greenlandic | 7576 | Marathi | 7782 | Tagalog | 8476 |
| Azerbaijani | 6590 | Guarani | 7178 | Moldavian | 7779 | Tajik | 8471 |
| Bashkir | 6665 | Gujarati | 7185 | Mongolian | 7778 | Tamil | 8465 |
| Basque | 6985 | Hausa | 7265 | Nauru | 7865 | Tatar | 8484 |
| Bengali; Bangla | 6678 | Hebrew | 7387 | Nepali | 7869 | Telugu | 8469 |
| Bhutani | 6890 | Hindi | 7273 | Norwegian | 7879 | Thai | 8472 |
| Bihari | 6672 | Hungarian | 7285 | Oriya | 7982 | Tibetan | 6679 |
| Breton | 6682 | Icelandic | 7383 | Panjabi | 8065 | Tigrinya | 8473 |
| Bulgarian | 6671 | Indonesian | 7378 | Pashto, Pushto | 8083 | Tonga | 8479 |
| Burmese | 7789 | Interlingua | 7365 | Persian | 7065 | Turkish | 8482 |
| Byelorussian | 6669 | Irish | 7165 | Polish | 8076 | Turkmen | 8475 |
| Cambodian | 7577 | Italian | 7384 | Portuguese | 8084 | Twi | 8487 |
| Catalan | 6765 | Japanese | 7465 | Quechua | 8185 | Ukrainian | 8575 |
| Chinese | 9072 | Javanese | 7487 | Rhaeto-Romance | 8277 | Urdu | 8582 |
| Corsican | 6779 | Kannada | 7578 | Rumanian | 8279 | Uzbek | 8590 |
| Croatian | 7282 | Kashmiri | 7583 | Russian | 8285 | Vietnamese | 8673 |
| Czech | 6783 | Kazakh | 7575 | Samoan | 8377 | Volapük | 8679 |
| Danish | 6865 | Kirghiz | 7589 | Sanskrit | 8365 | Welsh | 6789 |
| Dutch | 7876 | Korean | 7579 | Scots Gaelic | 7168 | Wolof | 8779 |
| English | 6978 | Kurdish | 7585 | Serbian | 8382 | Xhosa | 8872 |
| Esperanto | 6979 | Laothian | 7679 | Serbo-Croatian | 8372 | Yiddish | 7473 |
| Estonian | 6984 | Latin | 7665 | Shona | 8378 | Yoruba | 8979 |
| Faroes | 7079 | Latvian, Lettish | 7686 | Sindhi | 8368 | Zulu | 9085 |

Area Code List

Choose a area code from this list.

| Area | Code | Area | Code | Area | Code | Area | Code |
|----------------|------|----------------------------|------|----------------------|------|-----------------|------|
| Afghanistan | AF | Ethiopia | ET | Malaysia | MY | Saudi Arabia | SA |
| Argentina | AR | Fiji | FJ | Maldives | MV | Senegal | SN |
| Australia | AU | Finland | FI | Mexico | MX | Singapore | SG |
| Austria | AT | France | FR | Monaco | MC | Slovak Republic | SK |
| Belgium | BE | Germany | DE | Mongolia | MN | Slovenia | SI |
| Bhutan | BT | Great Britain | GB | Morocco | MA | South Africa | ZA |
| Bolivia | BO | Greece | GR | Nepal | NP | South Korea | KR |
| Brazil | BR | Greenland | GL | Netherlands | NL | Spain | ES |
| Cambodia | KH | Heard and McDonald Islands | HM | Netherlands Antilles | AN | Sri Lanka | LK |
| Canada | CA | Hong Kong | HK | New Zealand | NZ | Sweden | SE |
| Chile | CL | Hungary | HU | Nigeria | NG | Switzerland | CH |
| China | CN | India | IN | Norway | NO | Taiwan | TW |
| Colombia | CO | Indonesia | ID | Oman | OM | Thailand | TH |
| Congo | CG | Israel | IL | Pakistan | PK | Turkey | TR |
| Costa Rica | CR | Italy | IT | Panama | PA | Uganda | UG |
| Croatia | HR | Jamaica | JM | Paraguay | PY | Ukraine | UA |
| Czech Republic | CZ | Japan | JP | Philippines | PH | United States | US |
| Denmark | DK | Kenya | KE | Poland | PL | Uruguay | UY |
| Ecuador | EC | Kuwait | KW | Portugal | PT | Uzbekistan | UZ |
| Egypt | EG | Libya | LY | Romania | RO | Vietnam | VN |
| El Salvador | SV | Luxembourg | LU | Russian Federation | RU | Zimbabwe | ZW |

DVD Audio/Subtitle Language

When you play a DVD VIDEO, the language of the selected audio track or subtitle is abbreviated as follows. See page 23 to change the audio track or subtitle.

| Abbreviation | Language | Abbreviation | Language |
|--------------|------------|--------------|------------|
| ARA | Arabic | ITA | Italian |
| BUL | Bulgarian | IWR | Hcbrcw |
| CHI | Chinese | JPA | Japanese |
| CRO | Croatian | KOR | Korean |
| CZE | Czech | MAL | Malay |
| DAN | Danish | NLD | Dutch |
| DEU | German | NOR | Norwegian |
| ENG | English | POL | Polish |
| ESP | Spanish | POR | Portugucsc |
| FIN | Finnish | RUS | Russian |
| FRE | French | SVE | Swedish |
| GRE | Greek | THE | Thai |
| HUN | Hungarian | TUR | Turkish |
| IDN | Indonesian | VIE | Vietnamese |
| IND | Hindi | ZAF | Afrikaans |
| ISL | Icelandic | | |

Troubleshooting

| General | |
|---|--|
| The power does not turned on. | <ul style="list-style-type: none"> ➔ Plug the power cord into the wall outlet securely. |
| There is no picture. | <ul style="list-style-type: none"> ➔ Select the appropriate video input mode on the TV so the picture from the unit appears on the TV screen. ➔ Connect the video connection securely. |
| Picture noise appears. | <ul style="list-style-type: none"> ➔ You are playing a disc recorded in a color system that is different form your TV. ➔ The video signal from the external component is copy-protected. ➔ Set the resolution that your TV can accept. |
| The channel is not found or stored. | <ul style="list-style-type: none"> ➔ Check your antenna connection. |
| There is no sound. | <ul style="list-style-type: none"> ➔ Connect the audio connection securely. ➔ The input source setting on the amplifier or the connection to the amplifier is incorrect. ➔ The unit is in scan, slow motion, or pause mode. ➔ Try to select another audio channel or source using AUDIO button. ➔ If the audio signal does not come through the DIGITAL AUDIO OUT (OPTICAL or COAXIAL) jack, check the "Audio" setup setting (page 14, 53). |
| The remote control does not work properly. | <ul style="list-style-type: none"> ➔ The remote control is not pointed at the remote sensor of the unit. ➔ The remote control is too far from the unit. ➔ There is an obstacle in the path of the remote control and the unit. ➔ The batteries in the remote control are exhausted. ➔ The remote's manufacturer code returned to the default setting when you replaced the batteries. Reset the code (page 13). |

| Playback | |
|---|---|
| The unit does not start playback. | <ul style="list-style-type: none"> ➔ Insert a playable disc. (Check the disc type, color system, and regional code.) ➔ Place the disc with the playback side down. ➔ Place the disc on the disc tray correctly inside the guide. ➔ Clean the disc. ➔ Cancel the Rating function or change the rating level. |
| Cannot play a tapes. | <ul style="list-style-type: none"> ➔ Tapes recorded under a TV system other than NTSC (PAL, SECAM, etc.) cannot be played. |
| The picture is not clear. | <ul style="list-style-type: none"> ➔ Adjust the tracking by the CH/TRK + - button (see page 43). The video head are dirty. Clean the video head using a video head cleaning cassette. If the cleaning cassette is not available in your area, have the heads cleaned at your nearest dealer (a standard service fee will be charged). Do not use a commercially available liquid type cleaning cassette, as it may damage the video heads. ➔ The video heads may have to be replaced. Consult your local dealer for more information. ➔ The tape is defective. |
| Cannot play a disc recorded using this unit on other player. | <ul style="list-style-type: none"> ➔ Finalize the disc (see page 58). ➔ Check the disc compatibility of the player. ➔ Place the disc on the disc tray correctly inside the guide. ➔ Discs recorded with copy-once material cannot be played on other players. |
| The angle cannot be changed. | <ul style="list-style-type: none"> ➔ Multi-angles are not recorded on the DVD Video being played. ➔ The angle cannot be changed for the titles recorded on this unit. |
| The subtitle language cannot be changed or turned off. | <ul style="list-style-type: none"> ➔ Subtitles are not recorded on the DVD Video being played. ➔ The subtitle cannot be changed for the titles recorded on this unit. |
| Cannot play MP3/WMA/ JPEG/MPEG4 files. | <ul style="list-style-type: none"> ➔ The files are not recorded in a format that the unit can play. ➔ The unit does not support the codec of the MPEG4 movie file. ➔ The resolution is higher than the unit can support. |

Recording

| | |
|---|--|
| Cannot record or does not record successfully. | <ul style="list-style-type: none">➔ Check the remaining space on the disc.➔ If your source is copy-protected, you cannot record it using this unit.➔ Use a VR mode formatted disc for copy-once material. Video that is 'copy-once only' can only be recorded using a DVD-RW disc in VR mode or DVD-RAM disc with CPRM.➔ The power may have failed during recording.➔ In DVD mode, you cannot record the rated digital program, no signal, audio only, scrambled program, etc. If the unit detects an unrecordable signal as described above during recording, the recording will be paused. The recording will be continued when recordable signal is detected in pause mode. If the paused recording is continued for an hour, the recording will be stopped automatically with the message.➔ If you set a DTV rating for the unit and higher rated digital programs are received, the program cannot be recorded. Change the DTV rating level in order to record it. |
| Timer record does not record successfully. | <ul style="list-style-type: none">➔ Clock is not set to correct time.➔ The start time of the timer recording is past.➔ Two timer recordings may have overlapped, in which case only the earlier one will record completely.➔ When setting the recording channel, make sure you set the unit's built-in tuner, not the TV's built-in tuner.➔ If the inserted disc is damaged, the recording may not complete successfully.➔ To operate Timer Record using IR control, the connected Cable Box or Satellite Box must be turned on. |
| Stereo Audio Record and/or Playback is not present. | <ul style="list-style-type: none">➔ TV is not Stereo-compatible.➔ Broadcast program is not in stereo format.➔ The A/V Output jacks on the unit are not connected to TV A/V In jacks. |
| Even though the timer is set, the recorder will not record when | <ul style="list-style-type: none">➔ There is no disc (or tape) loaded.➔ A non-recordable disc (or tape) is loaded.➔ Disc Protect is set to [ON] in the Disc menu (see page 58).➔ There are already 99 titles (DVD-RW, DVD-R, DVD-RAM), 49 titles (DVD+RW, DVD+R(DL)) recorded on the disc. |
| You cannot enter a timer program when | <ul style="list-style-type: none">➔ A recording is already underway.➔ The time you're trying to set has already passed.➔ There are already 16 timer programs set. |
| If two or more timer programs overlap | <ul style="list-style-type: none">➔ The earlier program takes priority.➔ When the earlier program finishes, the later program starts.➔ If two programs are set to start at exactly the same time, the program entered first takes priority. If the disc is damaged, the recording may not complete successfully. In this case even though the Check field shows [Rec. OK], it may not be. |
| If you cannot get a picture and/or audio the DV IN jack, check the bullet points | <ul style="list-style-type: none">➔ Make sure the DV cable is properly connected.➔ Try switching off the connected equipment then switch back on.➔ Try switching the audio input. |

HDMI

The connected HDMI device does not display any picture.

- ➔ Try disconnecting then reconnecting the HDMI cable.
- ➔ Try switching the power of the HDMI device off then back on.
- ➔ The video input of the connected device is set correctly for this unit.
- ➔ The HDMI cable you are using is fully HDMI-compliant. Using a non-standard cable may result in no picture being output.
- ➔ Not all HDCP-compatible DVI devices will work with this unit.

The connected HDMI device does not output sounds.

- ➔ Some HDMI-compatible devices do not output sounds (check the manual that came with the connected device).
- ➔ If your TV is not capable of handling 96 kHz sampling frequency, set the [Sampling Freq.] option to [48 kHz] on the setup menu. When this choice is made, this unit will automatically convert any 96 kHz signals to 48 kHz so your system can decode them.
- ➔ If your TV is not equipped with Dolby Digital and MPEG decoder, set the [Dolby Digital] and [MPEG] options to [PCM] on the setup menu.
- ➔ If your TV is not equipped with DTS decoder, set the [DTS] options to [OFF] on the setup menu. To enjoy DTS multi channel surround, you must connect this unit to a DTS compatible receiver via one of this unit's digital audio outputs.

Resetting the unit

If you observe any of the following symptoms.

- ➔ The unit is plugged in, but the power will not turn on or off.
- ➔ The front panel display is not working.
- ➔ The unit is not operating normally.

You can reset the unit as follows.

- ➔ Press and hold the **POWER** (⏻) button for at least five seconds. This will force the unit to power off then turn the unit back on.
- ➔ Unplug the power cord, wait at least five seconds, and then plug it in again.

Error Message

| Message | Cause | Page |
|---|--|------------------|
| Authorization Error This player is not authorized to play this video | <ul style="list-style-type: none"> You are trying to play the MPEG4 content that was purchased with a different registration code. You cannot play the content on this unit. (MPEG4) | – |
| Cannot divide the title because the title length is under the minimum unit. | <ul style="list-style-type: none"> You cannot make too short title which doesn't have enough play-time. Each separated title should be longer than 3 seconds. | 40 |
| Cannot enter more timer recording items. | <ul style="list-style-type: none"> There are already 16 timer recording items. Delete unnecessary timer recording items. | 31, 45 |
| Change the Recording Time | <ul style="list-style-type: none"> You cannot set starting point of timer record prior to the present time. | – |
| Copy-Protected. Cannot record | <ul style="list-style-type: none"> The broadcast or external input which you are trying to record is copy-protected. A disc which you are trying to dub to cassette tape is copy-protected. | 29, 33 47, 48 |
| Disc is full | <ul style="list-style-type: none"> +RW -RWVideo RAM Create space by erasing unwanted recordings. Even if you erase recorded content from the DVD-R, +R or +R DL, there is no increase in disc space. Available recording space on a DVD-RW (DVD-Video format) or +RW disc increases when the last recording is deleted (space may not increase when you delete other recordings). Use a new disc. | – |
| Finalization has failed. | <ul style="list-style-type: none"> The disc may be dirty or scratched. Use a recommended recordable disc. | – |
| Finalized disc. | <ul style="list-style-type: none"> -RWVR -RWVideo If you want to record on the disc, unfinalize or format the disc. Format will delete all recorded title. | 58 |
| Initialization has failed. | <ul style="list-style-type: none"> The disc may be dirty or scratched. Use a recommended recordable disc. | – |
| Protected disc | <ul style="list-style-type: none"> Make sure the disc is not locked, which protects contents of disc and prevents recording. If you want to record on the disc, set the "Disc Protect" off in SETUP DISC MENU. | 58 |
| Rating Blocked | <ul style="list-style-type: none"> If unit has been rating-blocked, you can not watch or record any rated contents. | 53-55 |
| Rental Expired | <ul style="list-style-type: none"> The MPEG4 VOD content has zero remaining plays. You cannot play it. (MPEG4) | – |
| Set clock first | <ul style="list-style-type: none"> You must set clock of unit before your timer recording, unless timer recording cannot be set. | 51 |
| The number of Chapters cannot exceed 999 | <ul style="list-style-type: none"> If you have made 999 recorded chapters, unit cannot make any more chapter then. | – |
| The number of Titles exceeds 99 | <ul style="list-style-type: none"> If you have made 99 recorded titles, unit cannot make any more titles then. | 30 |
| The region before 3 seconds cannot be deleted. | <ul style="list-style-type: none"> Region should be longer than 3 seconds to be deleted. | 37 |
| TV System : MISMATCH | <ul style="list-style-type: none"> That means you inserted an incompatible disc(discs might be already recorded in different video system with current video signal). If you want to proceed recording,then use another disc or format the disc. Format will delete all recorded title. | – |
| Unfinalization has failed. | <ul style="list-style-type: none"> The disc may be dirty or scratched. Use a recommended recordable disc. | – |
| Wrong password. Would you try again ? | <ul style="list-style-type: none"> If you forgot your password, check the "Set password" section of manual. | 54 |
| ⊘ | <ul style="list-style-type: none"> That symbol means the function you put doesn't work on the unit or specific media. | – |

Glossary

| | |
|--|---|
| Aspect Ratio | The horizontal or vertical ratio of a watching display window. For a common size TV, the ratio is roughly 1.33: 1. The ratio usually applied on DVD titles supporting the wide screen display is about 1, 85:1 or 2.35: 1. |
| Camera (Angle) | For some DVDs, various images shot simultaneously at different angles (left/right/front/back etc.) |
| Country code | A function to limit playback of DVDs according the ratings for prohibiting minors from watching in each country. |
| Copy protection | Copy restriction set by copyright owners, etc. These signals are included in some software or TV programs and restrict recording on this recorder. |
| CPRM (Content Protection for Recordable Media) | CPRM is a copy protection system (with scramble system) only allowing the recording of 'copy once' broadcast programs. CPRM stands for Content Protection for Recordable Media. This Recorder is CPRM compatible, which means that you can record copy-once broadcast programs, but you cannot then make a copy of those recordings. CPRM recordings can only be made on DVD-RW discs formatted in VR mode or DVD-RAM discs, and CPRM recordings can only be played on players that are specifically compatible with CPRM. |
| CHAPTER | It is a lower unit than Title and consists of some chapters. You can search them by its number assigned to each chapter. |
| DTS (Digital Theater System) | A multi-channel digital surround sound format. The basic and most common version of the format is a 5.1 channel system. |
| Dolby Digital | The marketing name for a series of lossy audio compression technologies developed by Dolby Laboratories. It is the common version containing up to six discrete channels of sound, with five channels for normal-range speakers. |
| Down-mixing | This is the process of remixing the multi-channel audio found on some discs into two channels. It is useful when you want to listen to the 5.1 – channel audio recorded on DVDs through your TV's speakers. Some discs prohibit down0mixing. If this is the case, this unit can only output the front two channels. |
| Dynamic range | Dynamic range is the difference between the lowest level of sound that can be heard above the noise of the equipment and the highest level of sound before distortion occurs. Dynamic range compression means reducing the gap between the loudest and softest sounds. This means you can hear dialog clearly at low volume. |
| Finalize | A process that makes play of a recorded CD-R, CD-RW, DVD-R, etc. possible on equipment that can play such media. You can finalize DVD-R, DVD-R DL, DVD-RW (DVD-Video format), +R, and +R DL on the unit. After finalizing, the disc becomes play-only and you can no longer record or edit. However, finalized DVD-RW can be formatted to become recordable. |
| HDMI | HDMI (High Definition Multimedia Interface) supports both video and audio on a single digital connection for use with DVD Players, Set-Top Boxes, and other AV devices. HDMI was developed to provide the technologies of HDCP (High Definition Contents Protection). HDCP is used to protect digital content transmitted and received. HDMI has the capability to support standard, enhanced, or high-definition video plus standard to multi-channel surround-sound audio, HDMI features include uncompressed digital video, a bandwidth of up to 5 gigabytes per second, one connector (instead of several cables and connectors), and communication between the AV source and AV devices such as DTVs. |
| JPEG (Joint Photographic Experts Group) | This is a system used for compressing/decoding color still pictures. If you select JPEG as the storage system on digital cameras, etc., the data will be compressed to 1/10-1/100 of its original size. The benefit of JPEG is less deterioration in picture quality considering the degree of compression. |
| Letter Box | Letterboxing is the practice of transferring widescreen film to video formats while preserving the film's original aspect ratio. Since the video display often has a square aspect ratio, the resulting videographic image has black bars above and below it. Letterboxing was for use in 4:3 television displays when widescreen television was in its technologic infancy. |

Glossary

| | |
|---|---|
| MP3 (MPEG Audio Layer 3) | An audio compression method that compresses audio to approximately one-tenth of its size without any significant loss of audio quality. You can play MP3s you have recorded onto CD-R and CD-RW. |
| MPEG4 (Motion Picture Experts Group) | MPEG4 is the name of a revolutionary new video codec which is based on the new MPEG-4 compression standard for video. You will be able to play MPEG4 movies using this recorder. |
| Original | Titles actually recorded on a DVD-RW (VR mode) or DVD-RAM. Erasing original titles frees up disc space. |
| Pan Scan | One method of adjusting widescreen film images so that they can be shown within the proportions of a standard definition 4:3 aspect ratio television screen, often cropping off the sides of the original widescreen image to focus on the composition's most important aspects. |
| PCM / Bitstream | Pulse-code modulation (PCM) is a digital audio representation of an analog signal where the magnitude of the signal is sampled regularly at uniform intervals. Please select [Bitstream], when digital signals are outputted to the amplifier or other devices equipped with Dolby Prologic or DTS decoders. |
| Progressive scan | NTSC, the video signal standard, has 480 interlaced (i) scan lines, whereas progressive scanning uses twice the number of scan lines. This is called 480p. Using progressive output, you can enjoy the high-resolution video recorded on media such as DVD-Video. Your TV must be compatible to enjoy progressive video. |
| Playlist | Playback information created from the actual recordings on a DVD-RW (VR mode) or DVD-RAM. A Playlist leaves the original titles as they are, and contains only the information needed to control playback. A Playlist title takes up very little disc space. |
| Regional Code | Codes used to prevent the playing of media designed for a device from the country where it is marketed on the version of the same device marketed in another country. Applying code classified by regions 0: all regions 1: North America including the US 2: Japan and Europe 3: Southeast Asia including Korea 4: Australia, New Zealand, and South America 5: Russia and Africa 6: China 7: Not defined yet 8: Within airplanes or ships moving between countries |
| Sampling frequency | Sampling is the process of converting the heights of sound wave (analog signal) samples taken at set periods into digits (digital encoding). Sampling frequency is the number of samples taken per second, so larger numbers mean more faithful reproduction of the original sound. |
| SIMPLINK |  Some functions of this unit are controlled by the TV's remote control when this unit and an LG TV with SIMPLINK are connected through HDMI connection. <ul style="list-style-type: none"> ● Controllable functions by LG TV's remote control; Play, Pause, Scan, Skip, Stop, Power Off, etc. ● Refer to the TV owner's manual for the details of SIMPLINK function. ● LG TV with SIMPLINK function has the logo as shown above. |
| TITLE | The longest unit for measuring DVD movie or music files. (For example a movie volume or a music album) |
| Thumbnail | This refers to a miniature representation of a picture used to display multiple pictures in the form of a matrix. |
| TRACK | A unit for measuring DVD movie or music files. You can search them by its number assigned to each chapter. |
| WMA | Window media audio |

Specifications

General

| | |
|-----------------------|---|
| Power requirements | AC 120V, 60 Hz |
| Power consumption | 23W |
| Dimensions (approx.) | 430 X 78.5 X 260 mm (w x h x d) without foot |
| Net weight (approx.) | 4.2 kg |
| Operating temperature | 5°C to 35°C (41°F to 95°F) |
| Operating humidity | 5 % to 90 % |
| Signal system | NTSC, DTV standard ATSC or Clear QAM over cable |

Recording

| | |
|------------------|--|
| Recording format | DVD Video Recording, DVD-VIDEO |
| Recordable media | DVD-RW, DVD-R, DVD+RW, DVD+R, DVD+R(Double Layer), DVD-RAM |
| Recordable time | |

| Disc | Approx. |
|------------------|---------------------|
| DVD (4.7GB) | 1 hour (XP mode) |
| | 2 hours (SP mode) |
| | 4 hours (LP mode) |
| | 6 hours (EP mode) |
| | 14 hours (MLP mode) |
| DVD+R DL (8.5GB) | 1.8 hours (XP mode) |
| | 3.6 hours (SP mode) |
| | 7.3 hours (LP mode) |
| | 9.1 hours (EP mode) |
| | 21 hours (MLP mode) |

Video recording format

| | |
|--------------------|-----------------------|
| Sampling frequency | 27MHz |
| Compression format | MPEG2 (VBR supported) |

Audio recording format

| | |
|--------------------|---------------|
| Sampling frequency | 48kHz |
| Compression format | Dolby Digital |

Playback

| | |
|-----------------------|--|
| Frequency response | DVD (PCM 48 kHz): 8 Hz to 22 kHz, CD: 8 Hz to 20 kHz DVD (PCM 96 kHz): 8 Hz to 44 kHz |
| Signal-to-noise ratio | More than 100 dB (AUDIO OUT connector) |
| Harmonic distortion | Less than 0.008% (AUDIO OUT connector) |

VCR Specifications

| | |
|------------------|---|
| Head system | Four head helical scan azimuth system |
| Timer | 12-hour display type with AM, PM |
| Tape speed | SP: 33.35 mm/sec, SLP: 11.12 mm/sec |
| Antenna | 75 ohms (VHF/UHF) |
| Channel coverage | Analog (VHF: 2-13, UHF: 14-69, CATV: 1-135) Digital (Terrestrial: 2-69, Cable: 1-135) |

Inputs

| | |
|---------------|---|
| Dynamic range | More than 95 dB (AUDIO OUT connector) |
| ANTENNA IN | Antenna input, 75 ohms |
| VIDEO IN | 1.0 Vp-p 75 ohms, sync negative, RCA jack x 2 |
| AUDIO IN | - 6.0 dBm more than 47 kohms, RCA jack (L, R) x 2 |
| DV IN | 4 pin (IEEE 1394 standard) |
| USB IN | 4 pin (USB 1.1 standard) |

Outputs

| | |
|------------------------------|---|
| VIDEO OUT | 1 Vp-p 75 Ω , sync negative, RCA jack x 1 |
| S-VIDEO OUT | (Y) 1.0 V (p-p), 75 Ω , sync negative, Mini DIN 4-pin x 1(C) 0.3 V (p-p) 75 Ω |
| COMPONENT VIDEO OUT | (Y) 1.0 V (p-p), 75 Ω , sync negative, RCA jack x 1, (PB)/(PR) 0.7 V (p-p), 75 Ω , RCA jack x 2 |
| HDMI video/audio output | 19 pin (HDMI standard, Type A) |
| Audio output (digital audio) | 0.5 V (p-p), 75 Ω , RCA jack x 1 |
| Audio output (optical audio) | 3 V (p-p), 75 Ω , Optical connector x 1 |
| Audio output (analog audio) | 2.0 Vrms (1 kHz, 0 dB), 600 Ω , RCA jack (L, R) x 1 |
| IR TRANSMITTER OUT | 5 V (p-p) |

Accessories

RF cable (1), Remote control (1), Batteries (1), Audio cable (1), Video cable (1), IR control cable (1)

Design and specifications are subject to change without notice.

Index

Numerics

- 16:9 51
- 4:3 Letter Box 51
- 4:3 Pan Scan 51
- 3D Surround 24

A

- Angle 24
- Antenna 8
- AUDIO 23, 43, 59
- Audio Settings 53
- Auto Channel Set 50
- Auto Chapter 56
- AV IN 2 60

B

- BACKWARD 22, 43

C

- Cable TV 8
- Channel Edit 50
- Chapter 69
- Chapter List 34
- CHP. ADD 59
- Cleaning Discs 5
- CLEAR 43, 59
- Clock Set 51
- Combine 34, 40
- Connection
 - Antenna or Cable TV 8
 - RF coaxial 9, 11, 12
 - Video 9
 - Audio 9, 11, 12
 - HDMI 10
 - Component 11
 - S-Video 12
 - Amplifier 14
 - Recorder 15
 - Digital Camcorder 15
 - IR control cable 16
- Controlling other TVs with the Multi-brand Remote Control 13
- Copy protection 69
- Copy-Free 29
- Copy-Never 29
- Copy-Once 29
- Counter 43
- CPRM 69

D

- Delete 34, 37
- Deleting a Part 37
- DIGITAL AUDIO OUTPUT 61
- Disc Information 20
- Disc Label 58
- Disc Menu 52
- DISC MENU/LIST 23

- Disc Protect 58
- Disc Settings 58
- Disc Type 6, 7
- DISPLAY 59
- Display window 60
- Divide 34, 40
- Dolby Digital 53, 69
- Down-mixing 69
- DRC 53
- DTS 53, 69
- DTV Caption 52
- Dubbing 34, 48
- DV dubbing 49
- DV Record Audio 56
- DVD Rating 53
- DVD Editing 34
- DVD VIDEO 7
- DVD+R 6, 7
- DVD+R DL 6, 7
- DVD+RW 6, 7
- DVD-R 6, 7
- DVD-RAM 6, 7
- DVD-RW 6, 7

E

- EP mode 56, 71

F

- Factory Set 51
- Fast forwards 43
- FORWARD 22, 43
- Frame-by-Frame 22
- Front Panel 60
- Full Play 34
- Full Screen 26

G

- General Settings 50

H

- HDCP 69
- HDMI 69
- Hide 34, 39
- Home Menu 18

I

- I.SKIP 23, 43, 59
- Initial Setup Wizard 17
- Initialize 58
- INPUT 59
- INPUT 1 61
- Instant Timer Recording 30, 44
- IR Control 16

J

JPEG 26, 69

L

Language Abbreviation 64
Language Settings 52
Last Scene Memory 24
Lock Settings 53
LP mode 56, 71

M

MLP mode 56, 71
MONO 30, 44
Move 34, 39
MP3 25, 70
MPEG 53
MPEG4 28, 70
MULTILINGUAL 20

N

Numerical buttons 59

O

On-Screen Display 20
Original 70
OUTPUT 61
Overwriting Recording 41

P

Parental Control 53
PAUSE 22, 43
PLAY 21, 42, 59
PLAY MODE 23, 59
Playable Discs 7
Playback
 DVD 21-24
 Audio CD or MP3/WMA 25
 JPEG 26-27
 MPEG4 28
 VCR 42-43
Playlist 70
Power cord 2, 61
Power Save Mode 51
Progressive scan 70
Protect 34, 39

R

Random 25
Rear Panel 61
REC 59
REC MODE 59
Record mode
 DVD 56
 VCR 56
Recordable time 71
Recording
 DVD 29
 VCR 44

Recording Settings 56
Regional code 6, 70
Remote Control 59
Resetting 67
Resolution 10, 60
Resume playback 21
Rotate 26

S

Safety tab 42
Sampling Freq. 53
SAP 30, 44
Satellite Box 16
Search
 Time Search 38
 Marker Search 24
Set-Top Box 16, 56
Setup 18, 50
Show 34, 39
Simplink 70
SKIP 22, 59
Slide Show 27
Sound 20, 24
SP mode 56, 71
Stereo 30, 44
STOP 21, 42, 59
Storing Discs 5
SUBTITLE 23, 59

T

Timer Record 31-32, 45-46
Timer Record List 31-32, 45-46
Title 20, 22-23
Title Name 34, 38
Track 70
Tracking 43, 59
Troubleshooting 65
TV Aspect 51
TV Rating 54-55

U

Unfinalize 58
Unprotect 39
USB 62

V

Video Mode 6
VR Mode 6

W

WMA 25, 70

X

XP mode 56, 71

Z

ZOOM 22-23, 59



LG Electronics, Inc. Limited Warranty - USA

This LG Electronics product, will be repaired or replaced, at LG's option, if it proves to be defective in material or workmanship, under normal use, during the warranty period ("Warranty Period") listed below, effective from the date ("Date of Purchase") of original consumer purchase of the product. This warranty is good only to the original purchaser of the product and effective only when used in the United States, excluding U.S. Territories.

| | |
|---|---|
| WARRANTY PERIOD: LABOR: 90 days from the Date of Purchase. PARTS: One Year from the Date of Purchase. * Parts replaced are warranted for the remaining portion of the original warranty period. | HOW SERVICE IS HANDLED: Call 1-800-243-0000 for instructions on getting the defective unit repaired or replaced. Please retain dated sales receipt and your box to return the unit to LG for repair or replacement. Shipping both ways will be paid by LG during the Warranty Period. After the Warranty Period, you pay inbound shipping charges and LG pays return shipping charges. Visit our website at: http://us.lgservice.com |
|---|---|

THIS WARRANTY IS IN LIEU OF ANY OTHER WARRANTIES, EXPRESS OR IMPLIED, INCLUDING WITHOUT LIMITATION, ANY WARRANTY OF MERCHANTABILITY OR FITNESS FOR A PARTICULAR PURPOSE. TO THE EXTENT ANY IMPLIED WARRANTY IS REQUIRED BY LAW, IT IS LIMITED IN DURATION TO THE EXPRESS WARRANTY PERIOD ABOVE. LG ELECTRONICS WILL NOT BE LIABLE FOR ANY INCIDENTAL, CONSEQUENTIAL, INDIRECT, SPECIAL OR PUNITIVE DAMAGES OF ANY NATURE, EVEN IF ADVISED OF THE POSSIBILITY OF SUCH DAMAGES, INCLUDING WITHOUT LIMITATION, LOST REVENUES OR PROFITS, LOST OR CORRUPTED PROGRAMMING OR DATA, OR ANY OTHER DAMAGE WHETHER BASED IN CONTRACT, TORT OR OTHERWISE. Some states do not allow the exclusion or limitation of incidental or consequential damages or limitation on how long an implied warranty lasts, so the above exclusion or limitation may not apply to you. This warranty gives you specific legal rights and you may also have other rights that may vary from state to state.

THIS LIMITED WARRANTY DOES NOT APPLY TO:

- Damages or operating problems that result from shipping, installation, adjustment of user controls, calibration, maintenance or failure to maintain, or separate system components; and
- Damages or operating problems that result from normal wear and tear, misuse, abuse, operation outside environmental specifications or contrary to the requirements or precautions in the Operating Guide, accident, lightning strikes or other natural causes, unauthorized modification or alteration, incorrect electrical current or voltage, reception problem caused by inadequate home antenna or faulty antenna connections, computer software, institutional or commercial use, or other causes not arising out of defect in material or workmanship.

Therefore, the cost of repair or replacement of such defective product shall be borne by the consumer.

CUSTOMER INTER-ACTIVE CENTER NUMBERS:

| | |
|--|---|
| For nearest Authorized Service Center, Where to buy, Product Assistance, or Customer Assistance | Call 1-800-243-0000 (24 hours a day, 365 days per year) and select appropriate options from the menu. Or visit our website at http://us.lgservice.com |
|--|---|