

SAMSUNG

**TX-R3079WH
TX-R3080WH
TX-R3081WH
TX-S2782H
TX-S2779H
TX-S3082WH**

COLOR TELEVISION



**Owner's
Instructions**

Register your product at www.samsung.com/global/register

Important Warranty Information Regarding Television Format Viewing

Standard screen format televisions (4:3, the aspect ratio of the screen width to height) are primarily designed to view standard format full-motion video. The images displayed on them should primarily be in the standard 4:3 ratio format and constantly moving. Displaying stationary graphics and images on screen, such as the dark top and bottom letterbox bars (wide screen pictures), should be limited to no more than 15% of the total television viewing per week.

Wide screen format televisions (16:9, the aspect ratio of the screen width to height) are primarily designed to view wide screen format full-motion video. The images displayed on them should primarily be in the wide screen 16:9 ratio format, or expanded to fill the screen if your model offers this feature, and constantly moving. Displaying stationary graphics and images on screen, such as the dark side-bars on non-expanded standard format television video and programming, should be limited to no more than 15% of the total television viewing per week.

Additionally, viewing other stationary images and text such as stock market reports, video game displays, station logos, web sites or computer graphics and patterns, should be limited as described above for all televisions. ***Displaying any stationary images that exceed the above guidelines can cause uneven aging of picture tubes (CRTs) that leave subtle, but permanent burned-in ghost images in the television picture. To avoid this, vary the programming and images, and primarily display full screen moving images, not stationary patterns or dark bars.*** On television models that offer picture sizing features, use these controls to view the different formats as a full screen picture.

Be careful in the selection and duration of television formats used for viewing. Uneven CRT aging as a result of format selection and use, as well as other burned-in images, is not covered by your Samsung limited warranty.

Contents

GENERAL INFORMATION

■ List of Features	4
■ Accessories	4
■ Viewing the Control Panel	5
■ Viewing the Connection Panel	6
■ Remote Control	7
■ Installing Batteries in the Remote Control	8

CONNECTIONS

■ Connecting VHF and UHF Antennas	8
■ Connecting Cable TV	9
■ Connecting a VCR	10
■ Connecting an S-VHS VCR	10
■ Connecting a Second VCR to Record from the TV	11
■ Connecting a Camcorder	11
■ Connecting a DVD Player/Set-Top Box	11
■ Connecting a DVD Player/Set-Top Box via HDMI	12
■ Connecting a Digital Audio System	12
■ Connecting an Amplifier/DVD Home Theater	13

OPERATION

■ Turning the TV On and Off	13
■ Plug & Play Feature	13
■ Changing Channels	15
■ Adjusting the Volume	16
■ Viewing the Display	16
■ Viewing the Menus	16
■ Memorizing the Channels	17
■ Setting Up Your Remote Control	18
■ To Select the Source	23
■ To Edit the Input Source Name	23

PICTURE CONTROL

■ Using Automatic Picture Settings	24
■ Changing the Screen Size	25
■ Tilt	26
■ Setting the Film Mode	26

SOUND CONTROL

■ Using Automatic Sound Settings	26
■ Customizing the Sound	27
■ Setting the SRS TruSurround XT	27
■ Automatic Volume Control	28
■ Choosing a Multi-Channel Sound (MTS) track - Digital	28
■ Choosing a Multi-Channel Sound (MTS) track - Analog	29
■ Setting the On/Off Melody	29

CHANNEL CONTROL

■ Selecting the Antenna	30
■ Adding and Erasing Channels	30
■ To set-up Your Favorite Channels	31
■ Viewing the Channel Lists	32
■ Setting the Default Channel List Mode	32
■ Labeling Channels	33
■ Fine Tuning Analog Channels	33
■ Checking the Digital-Signal Strength	34
■ Using the R.Surf Feature	34

TIME SETTING

■ Setting the Time	35
--------------------------	----

FUNCTION DESCRIPTION

■ Selecting a Menu Language	38
■ Using the V-Chip	38
■ Viewing Closed Captions(On-Screen Text Messages) - Digital ...	45
■ Viewing Closed Captions(On-Screen Text Messages) - Analog ..	46
■ Menu Transparency Level	47
■ Setting the Blue Screen Mode	47
■ Setting the Function Help	47

APPENDIX

■ Identifying Problems	48
■ Specifications	48

Symbol



Press



Important



Note



One-Touch
Button

General Information

List of Features

- Adjustable picture settings that can be stored in the TV's memory.
- Automatic timer to turn the TV on and off.
- A special sleep timer.
- V-Chip function.
- Excellent Digital Interface & Networking:
With a built-in HD digital tuner, non-subscription HD broadcasts can be viewed with no Set-Top Box needed.
- Remote Control
The supplied remote can be used to operate the TV as well as most DVD players, Set-top boxes, Cable Boxes and VCRs.
- SRS TruSurround XT
- SRS TruSurround XT provides a virtual Dolby surround system.

Accessories

Please make sure the following items are included with your TV.
If any items are missing, contact your dealer.



Remote Control (AA59-00381A)/
AAA Batteries

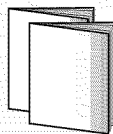

Owner's Instructions/
Safety Guide Manual

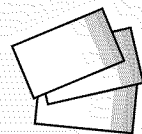

Warranty Cards/Registration Card
(Not available in all locations)

The following parts are sold separately and are available at most electronics stores.

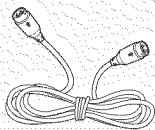

S-VIDEO Cable

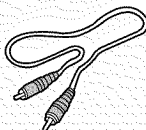

Video Cable

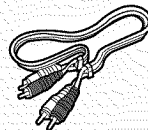

Audio Cable

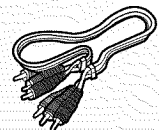

Component Cable

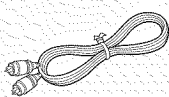

Optical Cable

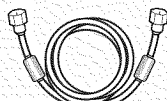

Antenna Cable

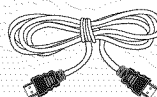

HDMI Cable

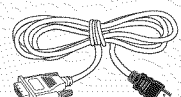

HDMI/DVI Cable

Viewing the Control Panel

Buttons on the Lower-Right Part of the Panel

The buttons on the lower-right panel control your TV's basic features, including the on-screen menu.

To use the more advanced features, you must use the remote control. The product color and shape may vary depending on the model.

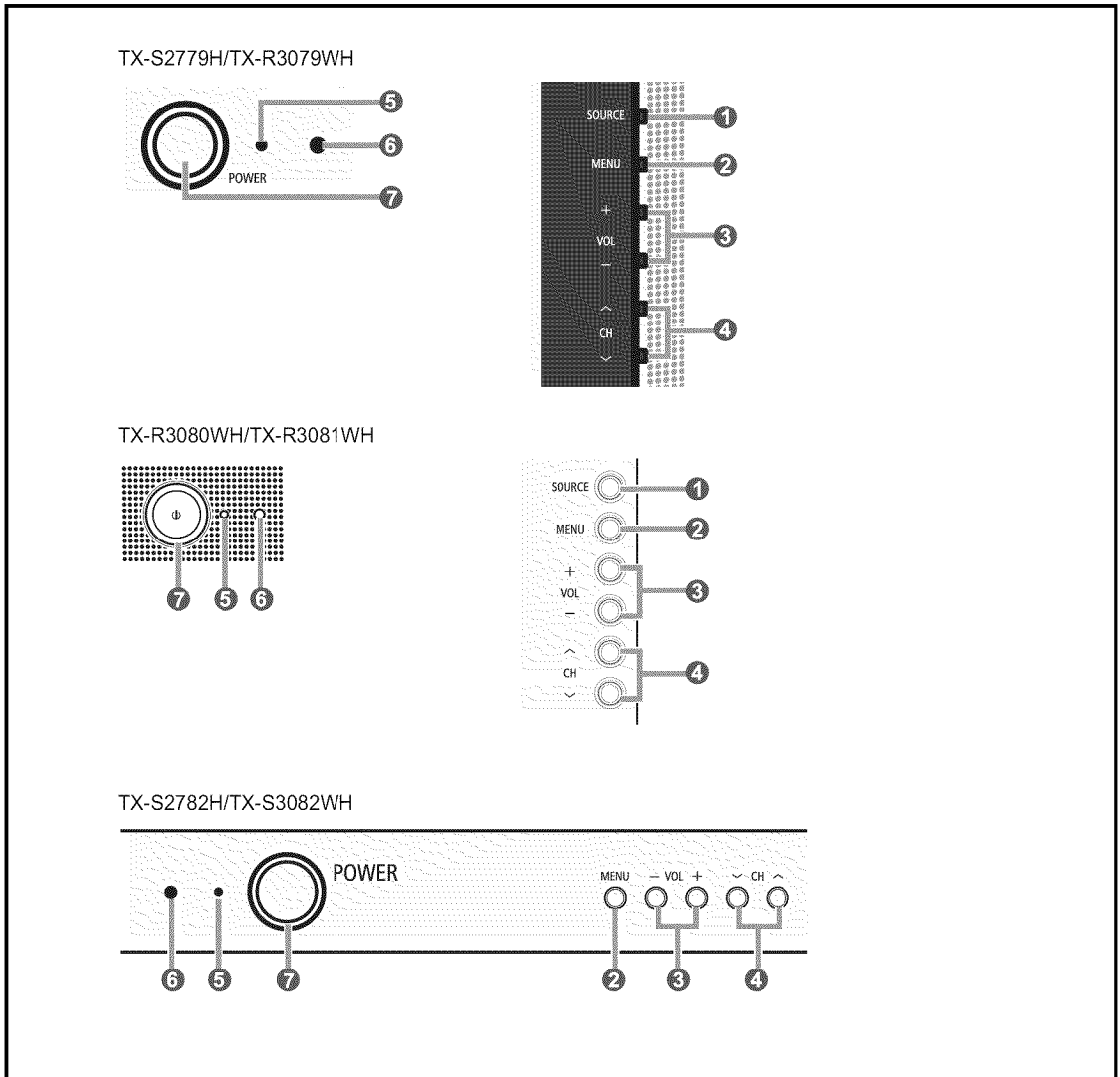

1 SOURCE

Toggles between all the available input sources (TV, AV1, AV2, S-Video, Component1, Component2, HDMI or HDMI1,2 (depending on the model)). In the on-screen menu, use this button as you would use the **ENTER** button on the remote control.

2 MENU

Press to see an on-screen menu of your TV's features.

3 + VOL -

Press to increase or decrease the volume. In the on-screen menu, use the **+ VOL -** buttons as you would use the **◀** and **▶** buttons on the remote control.

4 ^ CH v

Press to change channels. In the on-screen menu, use the **^ CH v** buttons as you would use the **▲** and **▼** buttons on the remote control.

5 Power Indicator

Blinks and turns off when the power is on and lights up in stand-by mode.

6 Remote Control Sensor

Aim the remote control towards this spot on the TV.

7 POWER

Press to turn the TV on and off.

Viewing the Connection Panel

Rear Panel Jacks

Use the rear panel jacks to connect A/V components that will be connected continuously, such as VCR or DVD players. For more information on connecting equipment, see pages 8~13. The product color and shape may vary depending on the model.

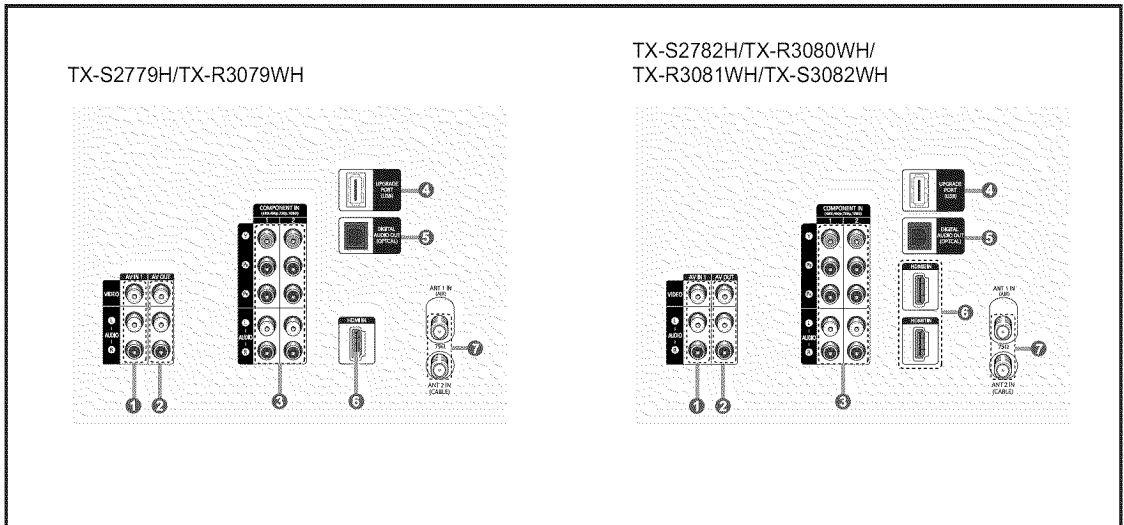

- | | |
|--|--|
| <p>1 AV IN 1
Video and audio inputs for external devices, such as a camcorder or VCR.</p> <p>2 AV IN 2
Connect to the audio/video input jacks of a recording VCR.</p> <p>3 COMPONENT IN 1,2
Connect Component video/audio.</p> <p>4 UPGRADE PORT (USB)
For service only.</p> | <p>5 DIGITAL AUDIO OUT (OPTICAL)
Connect to a Digital Audio component.</p> <p>6 HDMI IN(TX-S2779H/TX-R3079WH)/
HDMI 1, 2 IN(TX-S2782H/TX-R3080WH/
TX-R3081WH/TX-S3082WH)
Connect to the HDMI jack of a device with an HDMI output.</p> <p>7 ANT 1 IN (AIR) / ANT 2 IN (CABLE)
Connect to an antenna (air) or cable TV system.</p> |
|--|--|

Side Panel Jacks

Use the left side panel jacks to connect a component that is used only occasionally, such as a camcorder or video game. (See page 11) The product color and shape may vary depending on the model.

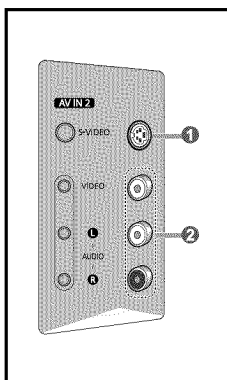

- 1 S-VIDEO IN**
S-Video input for external devices with an S-Video output.
- 2 AV IN 2**
Video and audio inputs for external devices, such as a camcorder or VCR.

Remote Control

You can use the remote control up to a distance of about 23 feet from the TV. When using the remote control, always point it directly at the TV. You can also use your remote control to operate your VCR, Cable box, DVD player, or Set-Top Box.

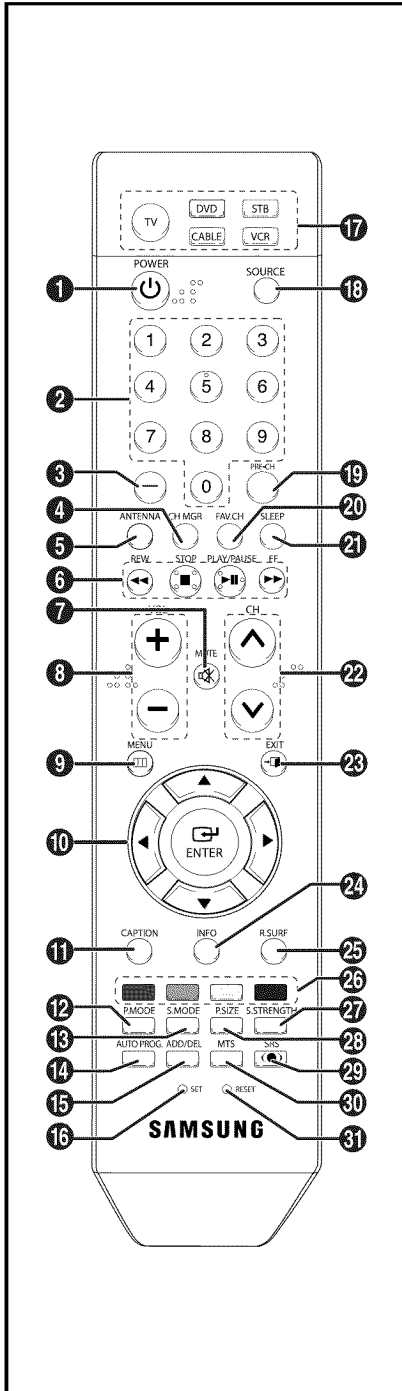

- 1 POWER**
Turns the TV on and off.
- 2 NUMERIC BUTTONS**
Press to change the channel.
- 3 -**
Press to select additional channels (digital and analog) being broadcast by the same station. For example, to select channel "54-3", press "54", then press "-" and "3".
- 4 CH MGR**
Used to display Channel Lists on the screen.
- 5 ANTENNA**
Press to select "AIR" or "CABLE".
- 6 VCR/DVD Functions**
- Rewind
- Stop
- Play/Pause
- Fast/Forward
- 7 MUTE**
Press to temporarily cut off the sound.
- 8 + VOL -**
Press to increase or decrease the volume.
- 9 MENU**
Displays the main on-screen menu.
- 10 UP▲/DOWN▼/LEFT◀/RIGHT▶/ENTER**
Use to select on-screen menu items and change menu values.
- 11 CAPTION**
Controls the caption decoder.
- 12 P.MODE**
Press to select the picture mode.
- 13 S.MODE**
Press to select the sound mode.
- 14 AUTO PROG.**
Press to automatically store selected Air/Cable channels.
- 15 ADD/DEL**
Use to store and delete channels to/from memory.
- 16 SET**
Sets the remote to control your TV, VCR, Cable, DVD, or Set-Top Box.
- 17 TV, DVD, STB, CABLE, VCR**
Press to operate your TV, DVD, STB, CABLE (box), or VCR.
- 18 SOURCE**
Press to display all of the available video sources.
- 19 PRE-CH**
Tunes to the previous channel.
- 20 FAV.CH**
Press to switch to your favorite channels.
- 21 SLEEP**
Press to select a preset time interval for automatic shut off.
- 22 ^ CH v**
Press to change channels.
- 23 EXIT**
Press to exit the menu.
- 24 INFO**
Press to display information on the TV screen.
- 25 R.SURF**
Press to automatically return to a preferred channel after a user-preset time delay.
- 26 Color buttons**
Press to add or delete channels and to store channels to the favorite channel list in the "Channel Manager" menu.
- 27 S.STRENGTH**
Press to check the digital signal strength.
- 28 P.SIZE**
Press to change the screen size.
- 29 SRS**
Selects SRS TruSurround XT mode.
- 30 MTS**
Press to choose stereo, mono or Separate Audio Program(SAP broadcast).
- 31 RESET**
When your remote control does not work, change the batteries and press the RESET button for 2-3 seconds before use.

➤ This is a special remote control for the visually impaired, and has Braille points on the Power, Channel and Volume buttons.

Installing Batteries in the Remote Control

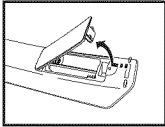

1. Lift the cover at the back of the remote control upward as shown in the figure.
2. Install two AAA size batteries.
 - Make sure to match the "+" and "-" ends of the batteries with the diagram inside the compartment.

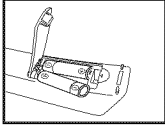

3. Replace the cover.
 - Remove the batteries and store them in a cool, dry place if you won't be using the remote control for a long time. The remote control can be used up to about 23 feet from the TV. (Assuming typical TV usage, the batteries last for about one year.)

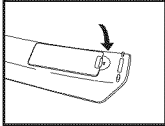

- **If the remote control doesn't work, check the following:**
1. Is the TV power on?
 2. Are the plus and minus ends of the batteries reversed?
 3. Are the batteries drained?
 4. Is there a power outage, or is the power cord unplugged?
 5. Is there a special fluorescent light or neon sign nearby?

Connections

Connecting VHF and UHF Antennas

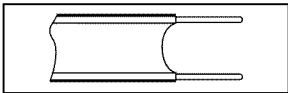

If your antenna has a set of leads that look like this, see "Antennas with 300 Ω Flat Twin Leads" below.

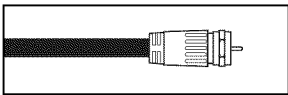

If your antenna has one lead that looks like this, see "Antennas with 75 Ω Round Leads". If you have two antennas, see "Separate VHF and UHF Antennas".

Antennas with 300 Ω Flat Twin Leads

If you are using an off-air antenna (such as a roof antenna or "rabbit ears") that has 300 Ω twin flat leads, follow the directions below.

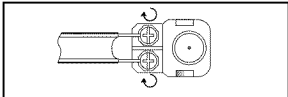

1. Place the wires from the twin leads under the screws on a 300-75 Ω adapter (not supplied). Use a screwdriver to tighten the screws.

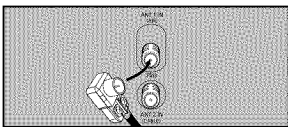

2. Plug the adaptor into the ANT 1 IN (AIR) terminal on the back of the TV.

Antennas with 75 Ω Round Leads

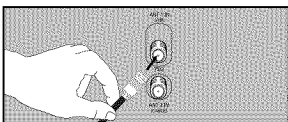

1. Plug the antenna lead into the ANT 1 IN (AIR) terminal on the back of the TV.

Separate VHF and UHF Antennas

If you have two separate antennas for your TV (one VHF and one UHF), you must combine the two antenna signals before connecting the antennas to the TV. This procedure requires an optional combiner-adaptor (available at most electronics shops).

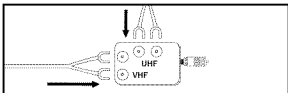

1. Connect both antenna leads to the combiner.

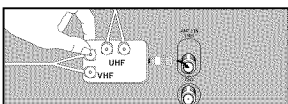

2. Plug the combiner into the ANT 1 IN (AIR) terminal on the back of the TV.

Connecting Cable TV

To connect to a cable TV system, follow the instructions below.

Cable without a Cable Box

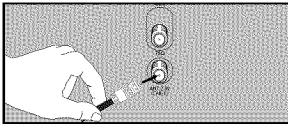

1. Plug the incoming cable into the ANT 2 IN (CABLE) terminal on the back of the TV.
 - Because this TV is cable-ready, you do not need a cable box to view unscrambled cable channels.

Connecting to a Cable Box that Descrambles All Channels

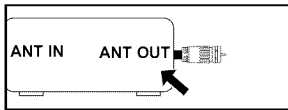

1. Find the cable that is connected to the ANT OUT terminal on your cable box.
 - This terminal might be labeled "ANT OUT", "VHF OUT" or simply, "OUT".

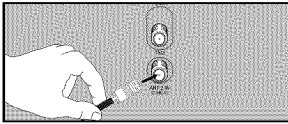

2. Connect the other end of this cable to the ANT 2 IN (CABLE) terminal on the back of the TV.

Connecting to a Cable Box that Descrambles Some Channels

If your cable box descrambles only some channels (such as premium channels), follow the instructions below. You will need a two-way splitter, an RF (A/B) switch, and four lengths of Antenna cable. (These items are available at most electronics stores.)

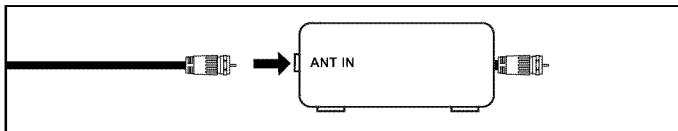

1. Find and disconnect the cable that is connected to the ANT IN terminal on your cable box.
 - This terminal might be labeled "ANT IN", "VHF IN" or simply, "IN".

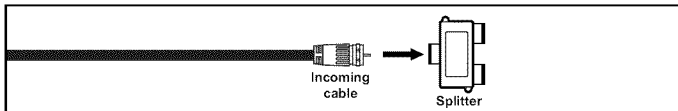

2. Connect this cable to a two-way splitter.

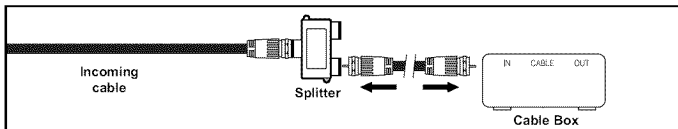

3. Connect an Antenna cable between an OUTPUT terminal on the splitter and the IN terminal on the cable box.

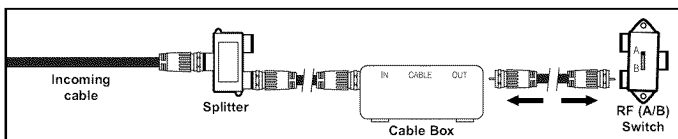

4. Connect an Antenna cable between the ANT OUT terminal on the cable box and the B-IN terminal on the RF (A/B) switch.

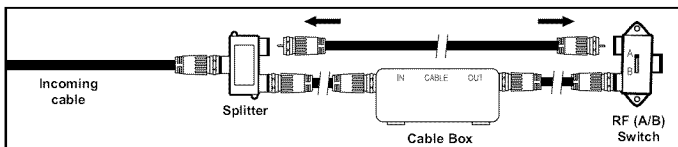

5. Connect another cable between the other OUTPUT terminal on the splitter and the A-IN terminal on the RF (A/B) switch.

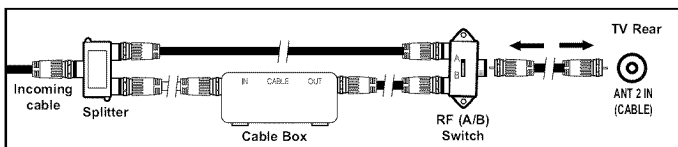

6. Connect the last Antenna cable between the OUT terminal on the RF (A/B) switch and the ANT 2 IN (CABLE) terminal on the back of the TV.

After you have made this connection, set the A/B switch to the "A" position for normal viewing. Set the A/B switch to the "B" position to view scrambled channels. (When you set the A/B switch to "B", you will need to tune your TV to the cable box's output channel, which is usually channel 3 or 4.)

Connecting a VCR

These instructions assume that you have already connected your TV to an antenna or a cable TV system (according to the instructions on pages 8~9). Skip step 1 if you have not yet connected to an antenna or a cable system.

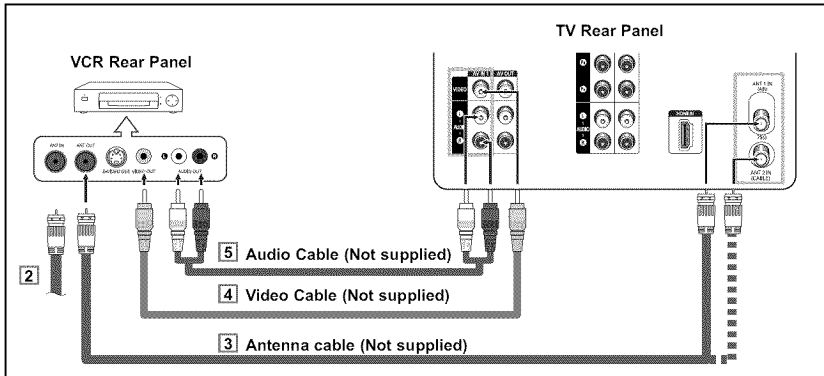
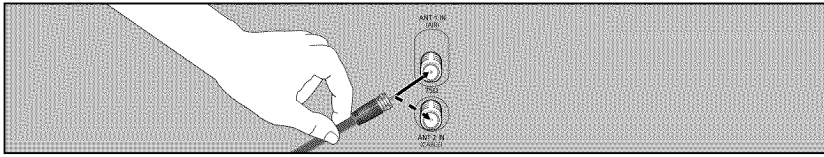

- Each external input source device has a different back panel configuration.
- When connecting an external device, match the color of the connection terminal to the cable.
- Also, you can connect to "AV IN 2" on the side panel of TV.

1. Unplug the cable or antenna from the back of the TV.
2. Connect the cable or antenna to the ANT IN terminal on the back of the VCR.
3. Connect an Antenna cable between the ANT OUT terminal on the VCR and the ANT 1 IN (AIR) or ANT 2 IN (CABLE) terminal on the TV.
4. Connect a Video Cable between the VIDEO OUT jack on the VCR and the AV IN 1 [VIDEO] jack on the TV.
5. Connect Audio Cables between the AUDIO OUT jacks on the VCR and the AV IN 1 [L-AUDIO-R] jacks on the TV.
 - If you have a "mono" (non-stereo) VCR, use a Y-connector (not supplied) to hook up to the right and left audio input jacks of the TV. If your VCR is stereo, you must connect two cables.

Connecting an S-VHS VCR

Your Samsung TV can be connected to an S-Video signal from an S-VHS VCR. (This connection delivers a better picture as compared to a standard VHS VCR.)

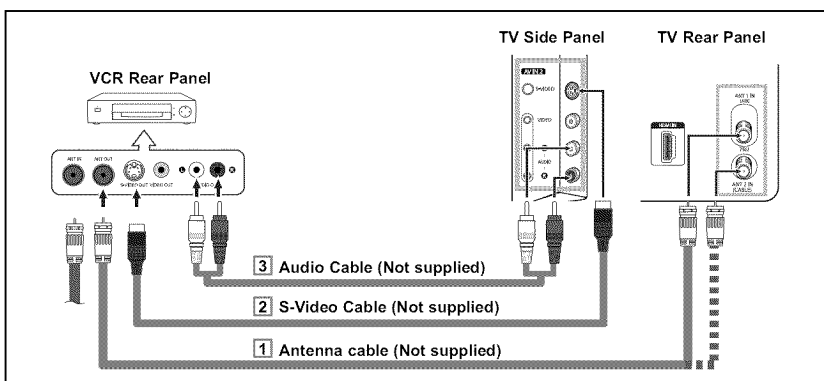

An S-Video cable is usually included with an S-VHS VCR. (If not, check your local electronics store.)

- Each external input source device has a different back panel configuration.
- When connecting an external device, match the color of the connection terminal to the cable.
- Some games may be displayed with a cut off picture when the TV is connected to a game player.

1. To begin, follow steps 1~3 in the previous section to connect the antenna or cable to your VCR and your TV.
2. Connect an S-Video Cable between the S-VIDEO OUT jack on the VCR and the AV IN2 [S-VIDEO] jack on the TV.
3. Connect Audio Cables between the AUDIO OUT jacks on the VCR and the AV IN2 [L-AUDIO-R] jacks on the TV.

Connecting a Second VCR to Record from the TV

Your TV can send out signals of its picture and sound to be recorded by a second VCR. To do this, connect your second VCR as follows:

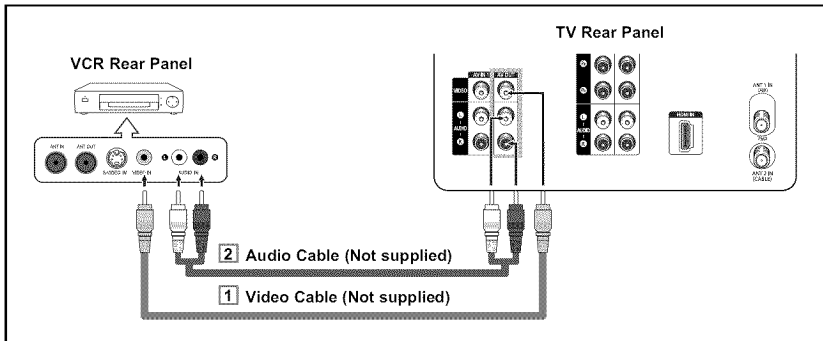

➤ When connecting an external device, match the color of the connection terminal to the cable.

1. Connect a video cable between the AV OUT [VIDEO] jack on the TV and the VIDEO IN jack on the VCR. Refer to your VCR's instructions for more information about how to record using this kind of connection.
2. Connect a set of audio cables between the AV OUT [L-AUDIO-R] jacks on the TV and the AUDIO IN jacks on the VCR. (The VCR input jacks might be either on the front or on back of the VCR.)

Connecting a Camcorder

The side panel jacks on your TV make it easy to connect a camcorder to your TV. They allow you to view the camcorder tapes without using a VCR.

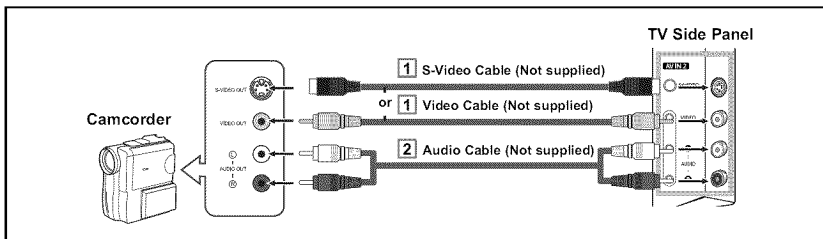

➤ Each external input source device has a different back panel configuration.
➤ When connecting an external device, match the color of the connection terminal to the cable.

1. Connect a Video Cable (or S-Video Cable) between the AV IN2 [VIDEO] (or S-VIDEO) jack on the TV and the VIDEO OUT jack on the camcorder.
2. Connect Audio Cables between the AV IN2 [L-AUDIO-R] jacks on the TV and the AUDIO OUT jacks on the camcorder.

Connecting a DVD Player/Set-Top Box

The rear panel jacks on your TV make it easy to connect a DVD player/Set-Top Box to your TV.

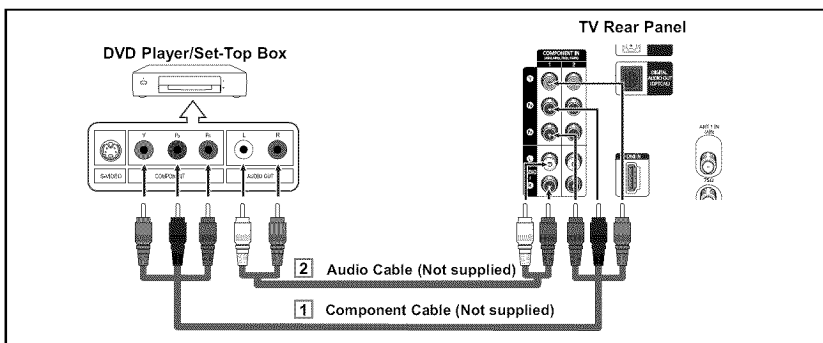

➤ Component video separates the video into Y (Luminance (brightness)), Pb (Blue) and Pr (Red) for enhanced video quality. Be sure to match the component video and audio connections. For example, if connecting the video cable to COMPONENT IN, connect the audio cable to COMPONENT IN also.

➤ Each external input source device has a different back panel configuration.
➤ When connecting an external device, match the color of the connection terminal to the cable.

1. Connect a Component Cable between the COMPONENT IN 1 [Y, Pb, Pr](or COMPONENT IN 2 [Y, Pb, Pr]) jacks on the TV and the COMPONENT Y, Pb, Pr jacks on the DVD Player/Set-Top Box.
2. Connect Audio Cables between the COMPONENT IN 1 [L-AUDIO-R](or COMPONENT IN 2 [L-AUDIO-R]) jacks on the TV and the AUDIO OUT jacks on the DVD Player/Set-Top Box.

Connecting a DVD Player/Set-Top Box via HDMI

This connection can only be made if there is an HDMI/DVI Output jack on the external device.

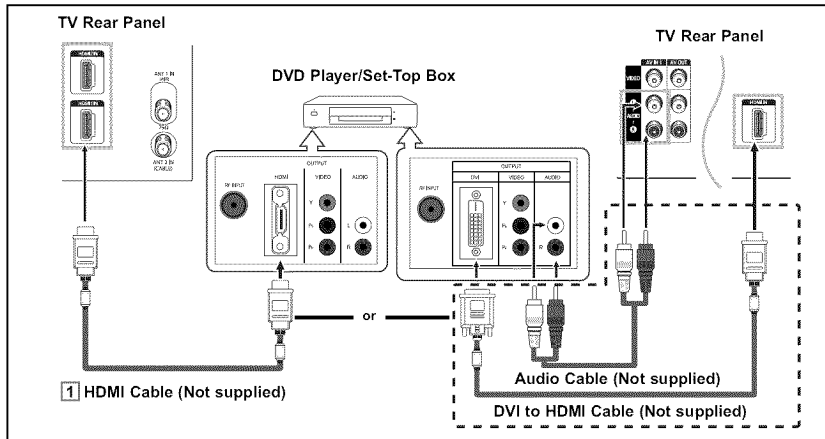

1. Connect an HDMI Cable between the [HDMI IN] or [HDMI IN 1, 2] on the TV and the HDMI OUT on the DVD player/Set-Top Box or connect a DVI to HDMI Cable or DVI-HDMI Adapter between the [HDMI IN] or [HDMI IN 1, 2] jack on the TV and the DVI jack on the DVD player/Set-Top Box.

If connecting via HDMI/DVI, you must also connect audio cables. Connect Audio Cables between the AV IN 1 [L-AUDIO-R] jacks on the TV and the AUDIO OUT jacks on the DVD player/Set-Top Box.

What is HDMI?

- HDMI, or high-definition multimedia interface, is a next-generation interface that enables the transmission of digital audio and video signals using a single cable without compression.
- "Multimedia interface" is a more accurate name for it especially because it allows multiple channels of digital audio (5.1 channels).

The difference between HDMI and DVI is that the HDMI device is smaller in size, has the HDCP (High Bandwidth Digital Copy Protection) coding feature installed, and supports multi-channel digital audio.

- Each external input source device has a different back panel configuration.
- When connecting an external device, match the color of the connection terminal to the cable.
- When connecting via HDMI, you do not need to connect Audio Cables. You only need to connect Audio cables when connecting via HDMI/DVI.

Connecting a Digital Audio System

The rear panel jacks on your TV make it easy to connect a Digital Audio System to your TV.

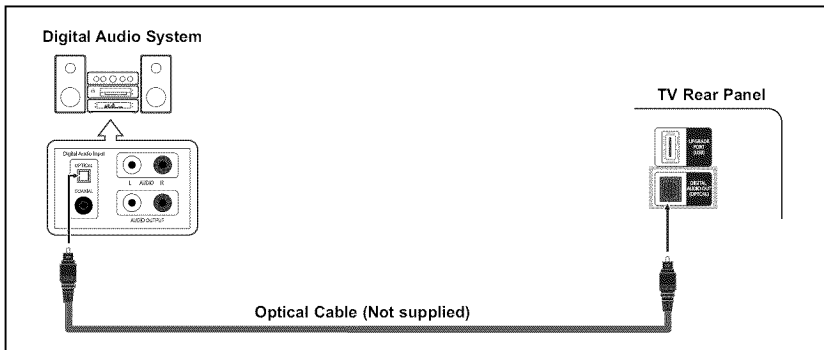

1. Connect an Optical Cable between the [DIGITAL AUDIO OUT (OPTICAL)] jacks on the TV and the Digital Audio Input jacks on the Digital Audio System.

When a Digital Audio System is connected to the [DIGITAL AUDIO OUT (OPTICAL)] terminal: Decrease the gain (volume) of the TV, and adjust the volume level with the system's volume control.

What is OPTICAL?

- Converts the electric signal into an optical light signal, and transmits it through glass fibers. S/PDIF is a transmission system of digital audio in the form of a light wave that uses a glass conductor.
- 5.1CH audio is possible when the TV is connected to an external device supporting 5.1CH.
- Each external input source device has a different back panel configuration.

AV OUT L-AUDIO-R				DIGITAL AUDIO OUT(OPTICAL)			
RF		AV, S-Video	Component, HDMI	RF		AV, S-Video	Component, HDMI
Digital	Analog			Digital	Analog		
Sound Output	Sound Output	Sound Output	Mute	Sound Output	Sound Output	Sound Output	Mute

- If you want to play movies by connecting DVD player or Set-Top Box with the COMPONENT or HDMI IN jacks on the TV, connect the AUDIO OUT jacks on DVD player or Set-Top Box to an Amplifier or DVD Home Theater.

Connecting an Amplifier/DVD Home Theater

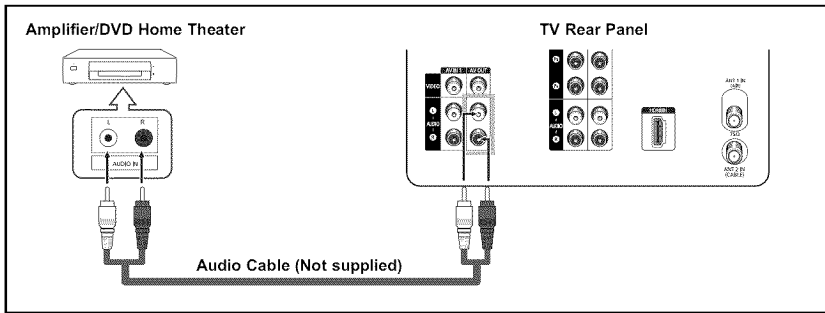

- Each external input source device has a different back panel configuration.
- When connecting an external device, match the color of the connection terminal to the cable.

1. Connect Audio Cables between the AV OUT [L-AUDIO-R] on the TV and AUDIO IN on the Amplifier/DVD Home Theater.

When an audio amplifier is connected to the "AUDIO OUT [L-AUDIO-R]" terminals: Decrease the gain (volume) of the TV, and adjust the volume level with the Amplifier's volume control.

Operation

Turning the TV On and Off

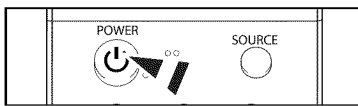

Press the **POWER** button on the remote control. You can also use the **POWER** button on the TV.

Plug & Play Feature

When the TV is initially powered on, basic customer settings proceed automatically and subsequently:

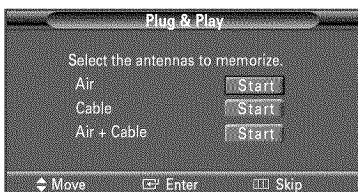

1. Press the **POWER** button on the remote control. The message "Menu language, Channels and Time will be set." is displayed. Press the **ENTER** button, then "Select the language of the OSD." menu is automatically displayed.
2. Press the **ENTER** button to enter the language. Press the **▲** or **▼** button to select language, then press the **ENTER** button. "Select the antennas to memorize." menu is automatically displayed.
3. Press the **▲** or **▼** button to memorize the channels of the selected connection. Press the **ENTER** button to select "Start".
 - If the antenna is connected to ANT 1(AIR), select "Air" and if it is connected to ANT 2 (CABLE), select "Cable".
 - If both ANT 1 (AIR) and ANT 2 (CABLE) are connected, select the "Air + Cable".
 - In Cable mode, you can select the correct signal source among "STD", "HRC", and "IRC" by pressing the **◀** button, then press the **▲** or **▼** button. Press the **▶** button to select "Start", then press the **ENTER** button. Contact your local cable company to identify the type of cable system that exists in your particular area.

Continued...

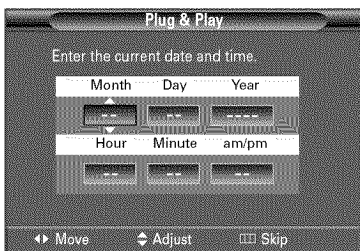
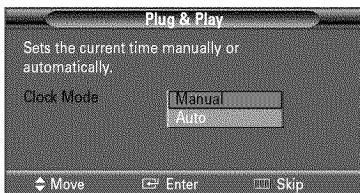

4. The TV will begin memorizing all of the available channels. After all the available channels are stored, the Auto program menu reappears. Press the **ENTER** button when channel memorization is complete. "Clock Mode." menu is automatically displayed.
 - To stop the search before it has finished, press the **ENTER** button with stop selected.

5. Press the **ENTER** button. Press the **▲** or **▼** button to select "Manual" for setting the current time manually, then press the **ENTER** button. "Enter the current date and time." is displayed.
 - If you select "Auto", "Set to daylight savings time." is displayed, then go to step 8.

6. Press the **◀** or **▶** button to move to "Month", "Day", "Year", "Hour", "Minute", or "am/pm". Set the date and time you want by pressing the **▲** or **▼** button, then press the **MENU** button.
 - You can set the Month, Day, Year, Hour, and Minute directly by pressing the number buttons on the remote control.

7. The message "Enjoy your watching." is displayed. When you have finished, press the **ENTER** button.
 - Even if the **ENTER** button is not pressed, the message will automatically disappear after several seconds.

Setting the Clock Automatically

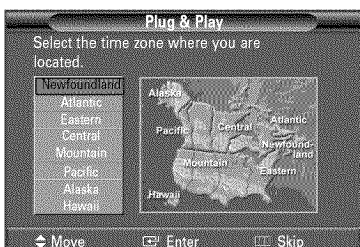

8. Press the **ENTER** button. Press the **▲** or **▼** button to select "On" or "Off", then the **ENTER** button. "Select the time zone where you are located." menu is automatically displayed.

9. Press the **▲** or **▼** button to highlight the time zone for your local area (and to move the highlight to the appropriate time zone on the map of the United States). Press the **ENTER** button. If not, see pages 35~36 to set the clock.

10. The message "Enjoy your watching." is displayed. When you have finished, press the **ENTER** button.
 - Even if the **ENTER** button is not pressed, the message will automatically disappear after several seconds.

Continued...

If you want to reset this feature...

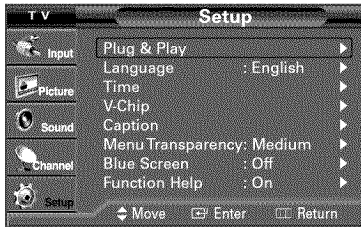

1. Press the **MENU** button to display the menu.
Press the **▲** or **▼** button to select "Setup", then press the **ENTER** button.
2. Press the **ENTER** button to select "Plug & Play".
For further details on setting up options, refer to the pages 13~14.
➤ Plug & Play can only be accessed in the TV mode.

Changing Channels

Using the Channel Buttons

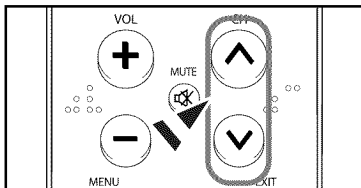

1. Press the **CH ▲** or **CH ▼** button to change channels.
➤ When you press the **CH ▲** or **CH ▼** button, the TV changes channels in sequence. You will see all the channels that the TV has memorized. (The TV must have memorized at least three channels). You will not see channels that were either erased or not memorized. See page 17 to memorize channels.

Using the Number Buttons

Use the number buttons to quickly tune to any channel.

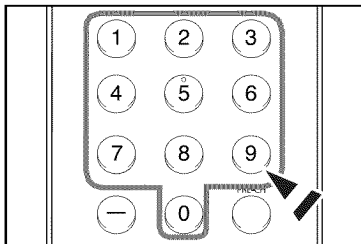

1. Press the number buttons to go directly to a channel.
For example, to select channel 27, press "2," then "7."
The TV will change channels when you press the second number.

Using the "-" Button

The "-" button is used to select channels that broadcast a digital signal.

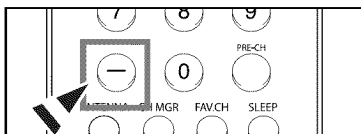

1. For example, for channel 7 (digital), press "7", then "-", then "1".
HD indicates the TV is receiving a digital High Definition signal. SD indicates the TV is receiving an analog Standard Definition signal.

Using the PRE-CH Button to select the Previous Channel

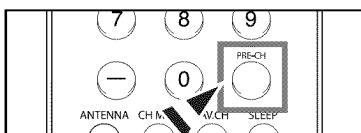

1. Press the **PRE-CH** button.
The TV will switch to the last channel viewed.
➤ To quickly switch between two channels that are far apart, tune to one channel, then use the number button to select the second channel. Then use the **PRE-CH** button to quickly alternate between them.

Adjusting the Volume

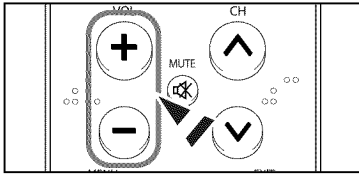

1. Press the **VOL +** or **VOL -** button to increase or decrease the volume.

Using Mute Button

At any time, you can cut off the sound using the MUTE button.

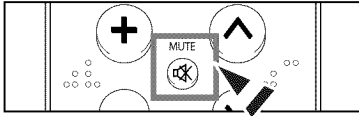

1. Press **MUTE** and the sound cuts off.
The word "MUTE" will appear in the lower-left corner of the screen.
2. To turn mute off, press the **MUTE** button again, or simply press the **VOL +** or **VOL -** button.

Viewing the Display

The display identifies the current channel and the status of certain audio-video settings.

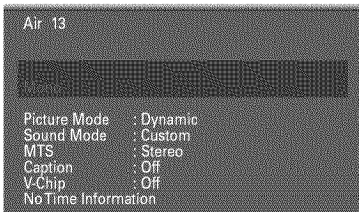

1. Press the **INFO** button on the remote control.
The TV will display the channel, the type of sound, and the status of certain picture and sound settings.

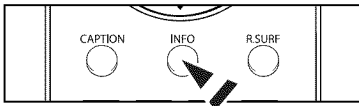

2. Press the **INFO** button once more or wait approximately 10 seconds and it disappears automatically.

Viewing the Menus

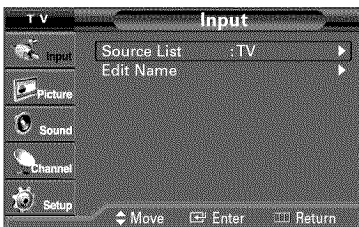

1. With the power on, press the **MENU** button.
The main menu appears on the screen. Its left side has five icons: "Input", "Picture", "Sound", "Channel", "Setup".
2. Use the **▲** or **▼** button to select one of the five icons.
Then press the **ENTER** button to access the icon's sub-menu.
3. Press the **EXIT** button to exit.



- The on-screen menu disappears from the screen after a few seconds.

Memorizing the Channels

Your TV can memorize and store all of the available channels for both “off-air” (air) and cable channels.

After the available channels are memorized, use the **CH ^** or **CH v** button to scan through the channels.

This eliminates the need to change channels by entering the channel digits. There are three steps for memorizing channels: selecting a broadcast source, memorizing the channels (automatic) and adding and deleting channels (manual).

Selecting the Video Signal-source

Before your television can begin memorizing the available channels, you must specify the type of signal source that is connected to the TV (i.e. an air or a cable system).



1. Press the **MENU** button to display the menu.
Press the **▲** or **▼** button to select “Channel”, then press the **ENTER** button.

2. Press the **ENTER** button select “Antenna”.
Press the **▲** or **▼** button to select “Air” or “Cable”, then press the **ENTER** button.

Press the **EXIT** button to exit.

Storing Channels in Memory (Automatic Method)



1. Press the **MENU** button to display the menu.
Press the **▲** or **▼** button to select “Channel”, then press the **ENTER** button.
2. Press the **▲** or **▼** button to select “Auto Program”, then press the **ENTER** button.

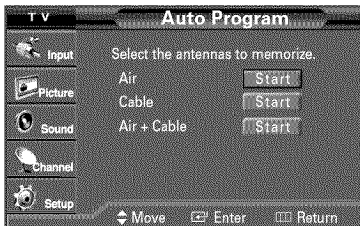

3. Press the **▲** or **▼** button to select the antenna connection, then press the **ENTER** button.
 - > Air: “Air” antenna signal.
 - > Cable: “Cable” antenna signal.
 - > Air+Cable: “Air” and “Cable” antenna signals.
 - > If the antenna is connected to ANT 1 IN (AIR), select “Air” and if it is connected to ANT 2 IN (CABLE), select “Cable”.
 - > If both ANT 1 IN and ANT 2 IN are connected, select the “Air + Cable”.
 - > If you selected “Air”, then go to step 5.

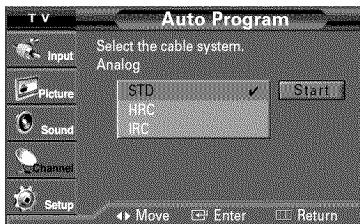

4. Select the correct signal source (STD, HRC, and IRC) by pressing the **◀** button, then press the **▲** or **▼** button.
Press the **▶** button to select “Start”, then press the **ENTER** button.
 - > STD, HRC, and IRC identify various types of cable TV systems. Contact your local cable company to identify the type of cable system that exists in your particular area. At this point the signal source has been selected.



5. After all the available channels are stored, the “Auto Program” menu reappears.
Press the **EXIT** button to exit.

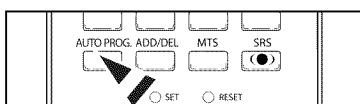

-  You can also press the **AUTO PROG.** button on the remote control to bring up the Auto Program menu.

Setting Up Your Remote Control

After it has been set up properly, your remote control can operate in five different modes: TV, VCR, Cable, DVD, or Set-Top Box. Pressing the corresponding button on the remote control allows you to switch between these modes, and control whichever piece of equipment you choose.

> The remote control might not be compatible with all DVD Players, VCRs, Cable boxes, and Set-Top Boxes.

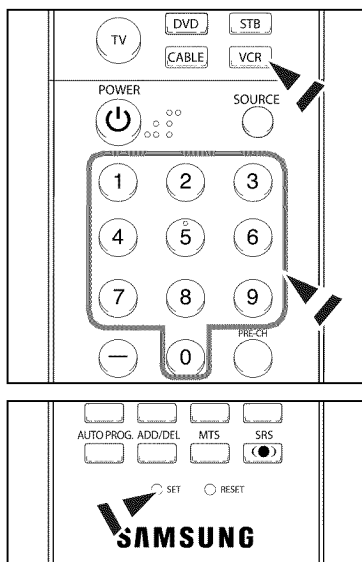

Setting Up the Remote control to Operate Your VCR

1. Turn off your VCR.
2. Press the **VCR** button on your TV's remote control.
3. Press the **SET** button on your TV's remote control.
4. Using the number buttons on your remote control, enter three digits of the VCR code listed on page 20 of this manual for your brand of VCR. Make sure you enter three digits of the code, even if the first digit is a "0". (If more than one code is listed, try the first one.)
5. Press the **POWER** button on the remote control. Your VCR should turn on if your remote control is set up correctly.

If your VCR does not turn on after set-up, repeat steps 2, 3 and 4, but try one of the other codes listed for your brand of VCR. If no other codes are listed, try each VCR code, 000 through 080.

Note on Using Remote Control Modes: VCR

When your remote control is in "VCR" mode, the volume buttons still control your TV's volume.

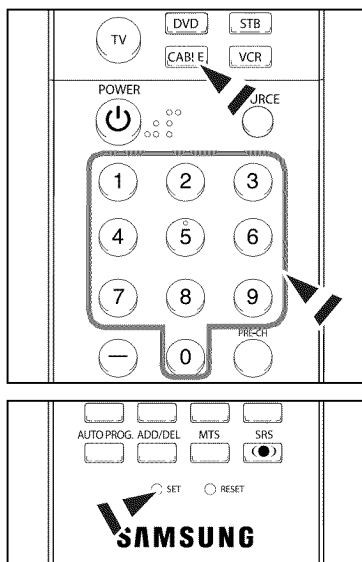

Setting Up the Remote control to Operate Your Cable Box

1. Turn off your cable box.
2. Press the **CABLE** button on your TV's remote control.
3. Press the **SET** button on your TV's remote control.
4. Using the number buttons on your remote control, enter three digits of the cable box code listed on page 21 of this manual for your brand of cable box. Make sure you enter three digits of the code, even if the first digit is a "0". (If more than one code is listed, try the first one.)
5. Press the **POWER** button on the remote control. Your cable box should turn on if your remote control is set up correctly.

If your cable box does not turn on after set-up, repeat steps 2, 3 and 4, but try one of the other codes listed for your brand of cable box. If no other codes are listed, try each code, 000 through 046.

Note on Using Remote Control Modes: Cable Box

When your remote control is in "CABLE" mode, the volume buttons still control your TV's volume.

Continued...

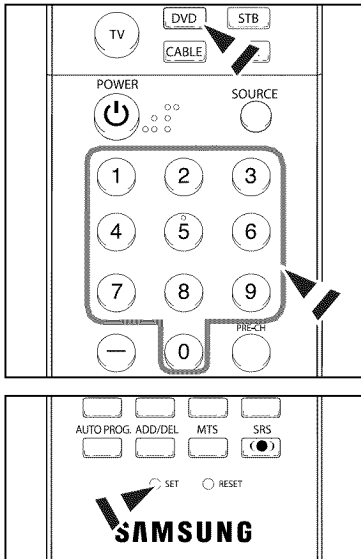

Setting Up the Remote control to Operate Your DVD

1. Turn off your DVD.
2. Press the **DVD** button on your TV's remote control.
3. Press the **SET** button on your TV's remote control.
4. Using the number buttons on your remote control, enter three digits of the DVD code listed on page 22 of this manual for your brand of DVD. Make sure you enter three digits of the code, even if the first digit is a "0". (If more than one code is listed, try the first one.)
5. Press the **POWER** button on the remote control.
Your DVD should turn on if your remote control is set up correctly.

If your DVD does not turn on after set-up, repeat steps 2, 3 and 4, but try one of the other codes listed for your brand of DVD. If no other codes are listed, try each code, 000 through 141.

Note on Using Remote Control Modes: DVD

When your remote control is in "DVD" mode, the volume buttons still control your TV's volume.

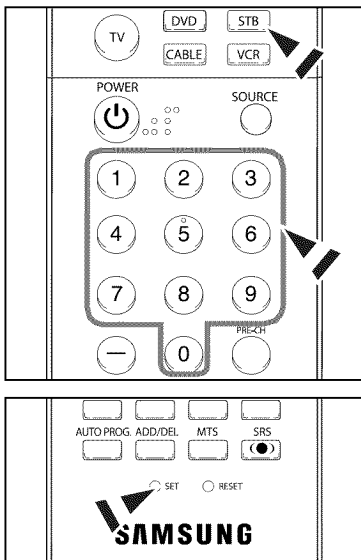

Setting Up the Remote control to Operate Your Set Top Box

1. Turn off your STB.
2. Press the **STB** button on your TV's remote control.
3. Press the **SET** button on your TV's remote control.
4. Using the number buttons on your remote control, enter three digits of the STB code listed on page 21 of this manual for your brand of STB. Make sure you enter three digits of the code, even if the first digit is a "0". (If more than one code is listed, try the first one.)
5. Press the **POWER** button on the remote control.
Your STB should turn on if your remote control is set up correctly.

If your STB does not turn on after set-up, repeat steps 2, 3 and 4, but try one of the other codes listed for your brand of STB. If no other codes are listed, try each code, 000 through 074.

Note on Using Remote Control Modes: STB

When your remote control is in "STB" mode, the volume buttons still control your TV's volume.

Continued...

Remote Control Codes

VCR

Brand	Code
SAMSUNG	000 001 002 003 004 005 077 078 079
ADMIRAL	020
AIWA	025
AKAI	004 027 032
AUDIO DYNAMICS	007 026
BELL&HOWELL	018
BROKSONIC	022
CANDLE	002 003 006 008 015 055
CANON	021 056
CITIZEN	002 003 006 008 015 055
COLORTYME	007
CRAIG	002 024
CURTIS MATHES	002 007 008 017 021 025 056 064 066
DAEWOO	003 010 011 012 013 014 015 016
DB	007 026
DIMENSIA	017
DYNATECH	025
ELECTROHOME	034
EMERSON	001 003 006 021 022 025 030 032 034 040 047 050 052 060 063 065 066 067 069 073
FISHER	018 024 028 029 048 051 061
FUNAI	025
GENERAL ELECTRIC	002 005 017 021 056
GO VIDEO	002
LG(Goldstar)	006 007 008 009 010
HARMAN KARDON	007
HITACHI	019 025 041 042 074
INSTANT REPLAY	021
JC PENNEY	002 007 018 019 021 026 037 041 054 056
JCL	007 008 018 021 026 037
KENWOOD	007 008 018 026 037
KLH	070
LLOYD	025
LOGIK	038
LXI	025
JVC	081 082 083
MAGNAVOX	021 056 059
MARANTZ	007 008 018 021 026 037 062
MARTA	006
KONIA	036
ORION	073 074 075 076
MEI	021
MEMOREX	006 021 024 025
MGA	034
MIDLAND	005
MINOLTA	019 041 075

Brand	Code
MITSUBISHI	019 034 041 046
MONTGOMERY WARD	020
MTC	002 025
MULTITECH	002 005 025 038
NEC	007 008 018 026 037 062 064
OPTIMUS	020
PANASONIC	021 056 071 072
PENTAX	019 041 075
PENTEX RESEARCH+	008
PHILCO	021 056 059
PHILIPS	021 080
PIONEER	019 026 039 053
PORTLAND	015 049 055
PROSCAN	017
QUARTZ	018
QUASAR	021 056
RADIO SHACK/REALISTIC	006 018 020 021 024 025 029 034 048 056
RCA	002 017 019 021 035 041 043 057 068 076
SANSUI	026
SANYO	018 024
SCOTT	003 047 052 067
SEARS	006 018 019 024 028 029 041 048 051
SHARP	020 034 045 015
SHIMTOM	027 033 038 058
SIGNATURE	025
SONY	027 033 044
SYLVANIA	021 025 056 059
SYMPHONIC	025
TANDY	018 025
TASHIKA	006
TATUNG	037
TEAC	025 037 068
TECHNICS	021
TEKNIKA	006 021 025 031
TMK	066
TOSHIBA	003 019 029 051 052
TOTEVISION	002 006
UNITECH	002
VECTOR RESEARCH	007 026
VICTOR	026
VIDEO CONCEPTS	007 026
VIDEOSONIC	002
WARDS	002 003 006 019 020 021 024 025 034 038 041
YAMAHA	007 008 018 026 037
ZENITH	023 027 033

Continued...

CABLE BOX

Brand	Code
SAMSUNG	000 001 002 003 004 005 006 007
GI	041
HAMLIN	003 024 031
HITACHI	025 030
JERROLD	038 039
MACOM	025 030
MAGNAVOX	019 023 028
OAK	026
PANASONIC	003 022 027 037 044
PHILIPS	019 021 023 028
PIONEER	004 018 020 044
RCA	014 022 040
REGAL	003

Brand	Code
REGENCY	015 023
SA	042 043
SCIENTIFIC ATLAN	042 043
SPRUCER	022
STARGATE 2000	036
SYLVANIA	016
TEXSCAN	016
TOCOM	032
UNIVERSAL	033 034
VIEWSTAR	019 021 023 028
WAMER AMEX	046
ZENITH	017 029 035 037 045

SAMSUNG SET-TOP BOX

Product	Code
Ground wave STB	001 002
Satellite STB	003
CABLE STB	004
STB DVD COMBO	008
Satellite STB HDD COMBO Standard	009

Product	Code
Satellite STB HDD COMBO Premium	010
CABLE STB HDD COMBO Standard	011
CABLE STB HDD COMBO Premium	012
Ground wave STB HDD COMBO Standard	013
Ground wave STB HDD COMBO Premium	014

SET-TOP BOX

Brand	Code
ALPHASTAR	023
ANAM	043
CHANNEL MASTER	018 034
CROSSDIGITAL	019
CHAPARRAL	035
DIRECT TV	015 016 017 019 022 045 060 061 062 065 066 067 068
DAEWOO	074
DISH NETWORK SYSTEM	069 070
DISHPRO	069
DRAKE	018 024 032
DX ANTENNA	027
ECHOSTAR	025 069 070 071
EXPRESSVU	069
GOI	069
GE	065
GENERAL INSTRUMENT	046 047 048 063 064
HTS	069
HOME CABLE	056
HITACHI	022
HUGHES NETWORK	015 017
IQ	020
IQ PRISM	020
JANEIL	059
JERROID	063
JVC	069 070

Brand	Code
LG(Goldstar)	044 073
MAGNAVOX	016 021 036 038 039 040 041 042
MEMOREX	016
MOTOROLA	064
MACOM	018
mitsubishi	015
NEXT LEVEL	047 048 064
PHILIPS	015 016 017 021 033 036 038 039 040 041 042 067
PRIMESTAR	046 049 050 063
PANASONIC	058 059 061 062
PAYSAT	016
PROSCAN	065 066
RCA	051 052 053 065 066
RADIOSHACK	064
REALISTIC	057
STS	020 027
STAR TRAK	026
SKY	031
SKY LIFE	005 006 007
SHACK	064
STAR CHOICE	064
SONY	054 060
TOSHIBA	015 017 028 029 030 072
ULTIMATE TV	060 066
UNIDEN	016 021 037 055 056 057
ZENITH	024 031 068

Continued...

SAMSUNG DVD

Product	Code
DVD	000 001 002
DVDR	003 004
BD Record	005 006
VCR COMBO	007 008 009 010 011
VCR Record	012
DHR COMBO	013

Product	Code
Home Theater VCR COMBO	014 015 016
HDD Record COMBO	017
TWIN TRAY COMBO	018
STB DVD COMBO	019
DVD Receiver	020
AV Receiver	021

DVD

Brand	Code
ANAM	030
AUDIOVOX	075
AUDIOLOGIC	085
ANABA	072
APEX DIGITAL	070 071 074 086 083 084 088 111 112
AIWA	114
BROKSONIC	062
BLAUPUNKT	074
B&K	122 123
CURTIS MATHES	027
CYBER HOME	065 077 078 079 082
CLARION	080 125
CIRRUS	081
CINEVISION	095
DAEWOO	066
DENON	146
FARENHEIT	067 068
FISHER	090
GPX	060
GO VIDEO	061 089 133 135
GE	069 074
GREENHILL	074
HITACHI	064 113
HITEKER	071
HOYO	073
HARMAN / KARDON	091 110
IRT	089
INTEGRA	092
JBL	091
JVC	022 033 115 116
JATON	073
KENWOOD	051 108 109
KISS	073
KONKA	059 100 106 107
KLH	074 075
LG(Goldstar)	025 031
LOEWE	057
LASONIC	058
MOBILE AUTHORITY	054
MEMOREX	055
MALATA	056
MAGNAVOX	076 093
MINTEK	074 094
MONYKA	073

Brand	Code
NORCENT	048 049 050
NEXT BASE	052
NEC	053
NANTAU	144
NESA	074
OPTOMEDIA ELECTRONICS	105
OPTIVIEW	072
ONKYO	076 092 119
PHILCO	044 045
PRINCETON	046 047
PROSCAN	023
PANASONIC	024 034 124 134 136 137 138
PHILIPS	036 076
ROTEL	117 118
RIO	120
RCA	023 035 074 075 131 132
RAITE	073
ROWA	038
SAMPO	104
SONY	026 029 126 127 128 129 130 141
SHERWOOD	039 041
SVA	042
SYLVANIA	043 093
SHARP	140
SANSUI	062
SANYO	062
SHINSONIC	094
SANYO	090
THOMSON	145
TOSHIBA	028 062 076
TECHNICS	139
TVIEW	072
TOKAI	073
TEAC	096
TECHWOOD	097
TREDEX	098 099 101
URBAN CONCEPTS	076
VENTURER	075
VOCOPRO	102
YAMAHA	032 063
YAMAKAWA	040 073
XWAVE	103
ZENITH	076 121

To Select the Source

Use to select TV or other external input sources connected to the TV.
Use to select the input source of your choice.

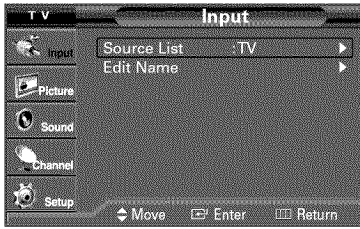

1. Press the **MENU** button to display the menu.
Press the **ENTER** button to select "Input".

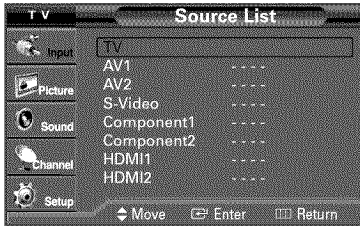

2. Press the **ENTER** button to select "Source List".
Press the **▲** or **▼** button to select signal source, then press the **ENTER** button.
- You can choose between the following sets of jacks: TV, AV1, Component1, Component2, HDMI or HDMI1, 2 (depending on the model) on the TV's rear panel and AV2 or S-Video on the TV's side panel.

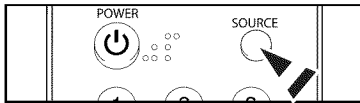

-  Press the **SOURCE** button on the remote control to view an external signal source.
- HDMI will appear in the Source list for models TX-S2779H and TX-R3079WH. HDMI1/HDMI2 will appear in the Source list for models TX-S2782H, TX-R3080WH, TX-R3081WH, and TX-S3082WH.

To Edit the Input Source Name

Name the device connected to the input jacks to make your input source selection easier.

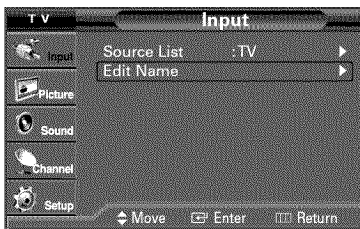

1. Press the **MENU** button to display the menu.
Press the **ENTER** button to select "Input".
Press the **▲** or **▼** button to select "Edit Name", then press the **ENTER** button.

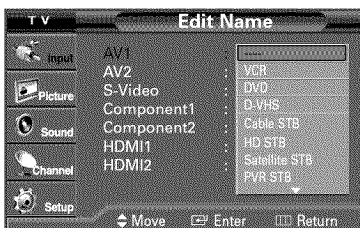

2. Press the **▲** or **▼** button to select "AV1", "AV2", "S-Video", "Component1", "Component2", "HDMI(TX-S2779H, TX-R3079WH)" or "HDMI1, 2(TX-S2782H, TX-R3080WH, TX-R3081WH, TX-S3082WH)" input jack, then press the **ENTER** button.
3. Press the **▲** or **▼** button to select "VCR", "DVD", "D-VHS", "Cable STB", "HD STB", "Satellite STB", "PVR STB", "AV Receiver", "DVD Receiver", "Game", "Camcorder", "DVD Combo", "DHR", "Internet TV Recv.", "Interactive TV Recv.", "VOD STB", or "TV" input source, then press the **ENTER** button.

Press the **EXIT** button to exit.

Picture Control

Using Automatic Picture Settings

Your TV has four automatic picture settings (“Dynamic”, “Standard”, “Movie”, “Custom”) that are preset at the factory. You can activate either Dynamic, Standard, Movie, or Custom by making a selection from the menu.

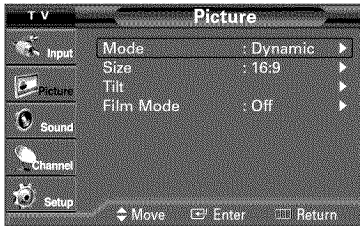

1. Press the **MENU** button to display the menu.
Press the **▲** or **▼** button to select “Picture”, then press the **ENTER** button.

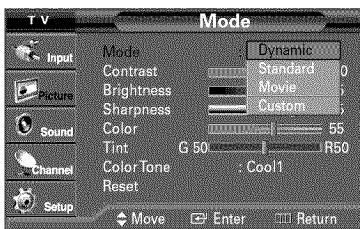

2. Press the **ENTER** button to select “Mode”.
Press the **ENTER** button again.
Press the **▲** or **▼** button to select the “Dynamic”, “Standard”, “Movie”, or “Custom” picture setting, then press the **ENTER** button.

- Choose **Dynamic** to increase the clarity and sharpness of the picture.
- Choose **Standard** for the standard factory settings.
- Choose **Movie** when watching movies.
- Choose **Custom** if you want to adjust the settings according to personal preference.

➤ Picture mode needs to be adjusted separately for each input.

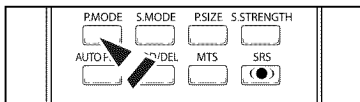

3. Press the **▲** or **▼** button to select “Contrast”, “Brightness”, “Sharpness”, “Color”, or “Tint”, then press the **ENTER** button.

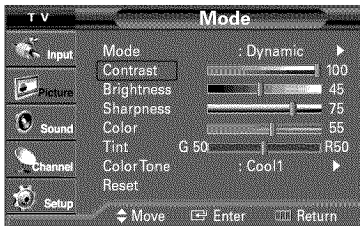

4. Press the **◀** or **▶** button to decrease or increase the value of a particular item.
 - Each adjusted setting will be stored separately according to its input mode.
 - When you make changes to Contrast, Brightness, Sharpness, Color, or Tint, OSD color will also be adjusted accordingly.

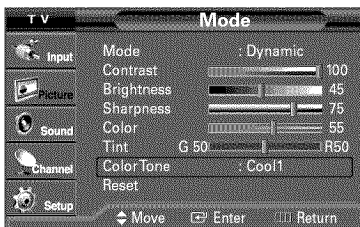

5. Press the **ENTER** button to return to “Mode”.
6. Press the **▲** or **▼** button to select “Color Tone”, then press the **ENTER** button.

Continued...

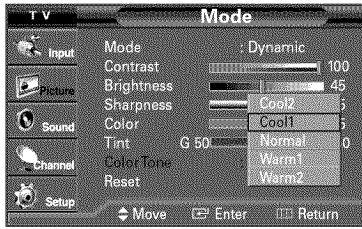

- Press the **▲** or **▼** button to select "Cool2", "Cool1", "Normal", "Warm1", or "Warm2", then press the **ENTER** button.

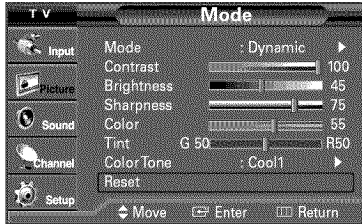

Resetting the Picture Settings to the Factory Defaults

- Press the **▲** or **▼** button to select "Reset", then press the **ENTER** button.
Press the **EXIT** button to exit.
➤ Each picture mode can be reset.

Changing the Screen Size

Screen size selection depends on the type of video input.

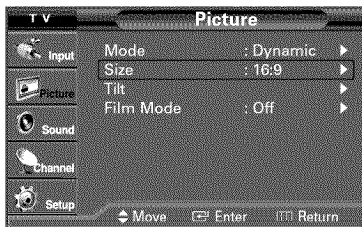

- Press the **MENU** button to display the menu.
Press the **▲** or **▼** button to select "Picture", then press the **ENTER** button.
- Press the **▲** or **▼** button to select "Size", then press the **ENTER** button.

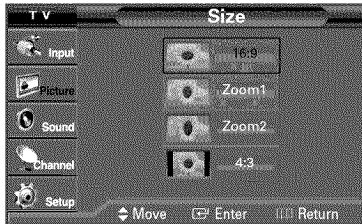

- Press the **▲** or **▼** button to select the screen format you want, then press the **ENTER** button.

Press the **EXIT** button to exit.

- ◆ **16:9**: Sets the picture to 16:9 wide mode.
- ◆ **Zoom1**: Magnifies the size of the picture on the screen.
- ◆ **Zoom2**: Expands the Zoom1 format picture.
- ◆ **4:3**: Sets the picture to 4:3 normal mode.

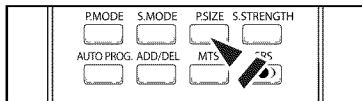

- Press the **P.SIZE** button on the remote control repeatedly to change the picture size.
- Changing the Screen Format feature availability depends on the current broadcasting signal format.
- Only "16:9" and "4:3" modes are available in DTV, Component (720p,1080i), HDMI (720p, 1080i) modes.

Viewing with a 4:3 signal (When a 4:3 signal is received)

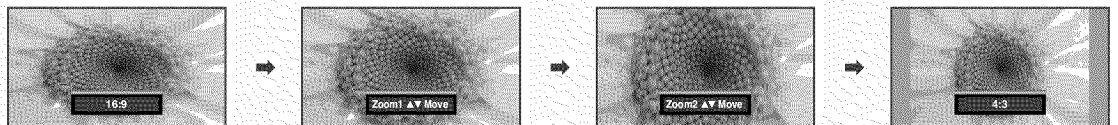

Viewing with a 16:9 signal (When a 16:9 signal is received)

The illustrations below show the picture change while viewing a DVD title.

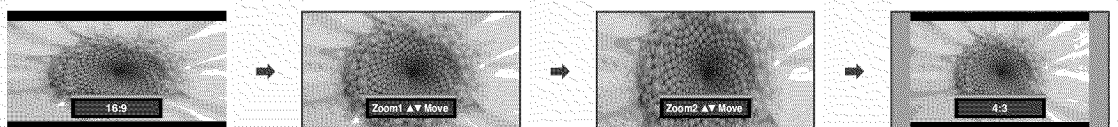

Tilt

Due to the Earth's magnetic field there may be some minor image tilt depending on the TV's location. When this occurs, follow the steps below.

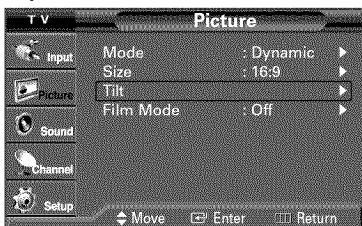

1. Press the **MENU** button to display the menu.
Press the **▲** or **▼** button to select "Picture", then press the **ENTER** button.
2. Press the **▲** or **▼** button to select "Tilt", then press the **ENTER** button.
Press the **◀** or **▶** button to adjust screen tilt.
Press the **EXIT** button to exit.



Setting the Film Mode

Film mode automatically senses and processes film signals from all sources and adjust the picture for optimum quality.

- Film mode is supported in 480i only.

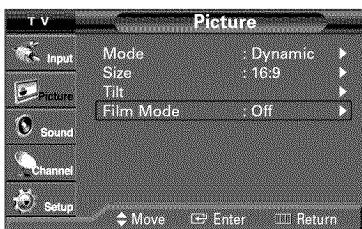

1. Press the **MENU** button to display the menu.
Press the **▲** or **▼** button to select "Picture", then press the **ENTER** button.
2. Press the **▲** or **▼** button to select "Film Mode", then press the **ENTER** button.

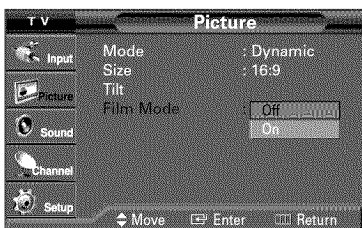

3. Press the **▲** or **▼** button to select "Off" or "On", then press the **ENTER** button.
Press the **EXIT** button to exit.

Sound Control

Using Automatic Sound Settings

Your TV has automatic sound settings ("Standard", "Music", "Movie", "Speech", and "Custom") that are preset at the factory. Or, you can select "Custom", which automatically recalls your personalized sound settings.



1. Press the **MENU** button to display the menu.
Press the **▲** or **▼** button to select "Sound", then press the **ENTER** button.
2. Press the **ENTER** button to select "Mode".
Press the **▲** or **▼** button to select "Standard", "Music", "Movie", "Speech", or "Custom" sound setting, then press the **ENTER** button.
Press the **EXIT** button to exit.

Continued...

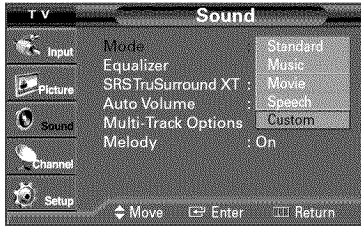

- ♦ Choose **Standard** for the standard factory settings.
- ♦ Choose **Music** when watching music videos or concerts.
- ♦ Choose **Movie** when watching movies.
- ♦ Choose **Speech** when watching a show that is mostly dialog (i.e., news).
- ♦ Choose **Custom** to recall your personalized settings (see "Customizing the Sound").

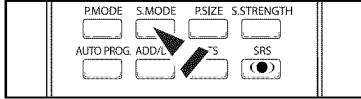

- ▣ Press the **S.MODE** button on the remote control repeatedly to select one of the standard sound settings.

Customizing the Sound

The sound settings can be adjusted to suit your personal preference. (Alternatively, you can use one of the "automatic" settings.)



1. Press the **MENU** button to display the menu. Press the **▲** or **▼** button to select "Sound", then press the **ENTER** button.
2. Press the **▲** or **▼** button to select "Equalizer", then press the **ENTER** button.

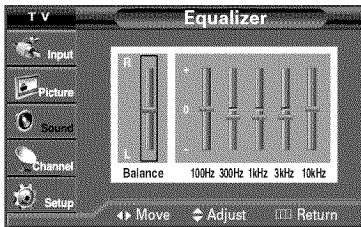

3. Press the **◀** or **▶** button to select a particular frequency to adjust. Press the **▲** or **▼** button to increase or decrease the level of the particular frequency, then press the **ENTER** button.

Press the **EXIT** button to exit.

- **L/R Sound Balance Adjustment:**
To adjust the sound balance of the L/R speakers.
- **Bandwidth Adjustment (100Hz, 300Hz, 1KHz, 3KHz, 10KHz):**
To adjust the level of different bandwidth frequencies.
- If you make any changes to the equalizer settings, the sound mode is automatically switched to the "Custom" mode.

Setting the SRS TruSurround XT

TruSurround XT is a patented SRS technology that solves the problem of playing 5.1 multichannel content over two speakers. TruSurround delivers a compelling, virtual surround sound experience through any two-speaker playback system, including internal television speakers. It is fully compatible with all multichannel formats.



1. Press the **MENU** button to display the menu. Press the **▲** or **▼** button to select "Sound", then press the **ENTER** button.
2. Press the **▲** or **▼** button to select "SRS TruSurround XT", then press the **ENTER** button.

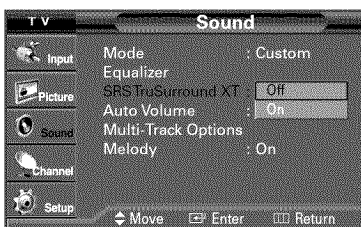

3. Press the **▲** or **▼** button to select "On" or "Off", then press the **ENTER** button. Press the **EXIT** button to exit.

Continued...

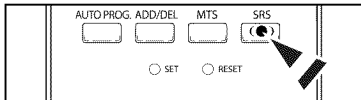

Press the **SRS** button on the remote control to select “On” or “Off”.

TRADEMARK & LABEL LICENSE NOTICE



TruSurround XT, SRS and Symbol are trademarks of SRS Labs, Inc. TruSurround XT technology is incorporated under license from SRS Labs, Inc.

Automatic Volume Control

Reduces the differences in volume level among broadcasters.

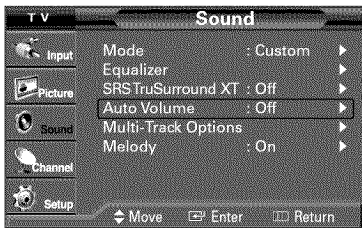

1. Press the **MENU** button to display the menu. Press the **▲** or **▼** button to select “Sound”, then press the **ENTER** button.
2. Press the **▲** or **▼** button to select “Auto Volume”, then press the **ENTER** button.

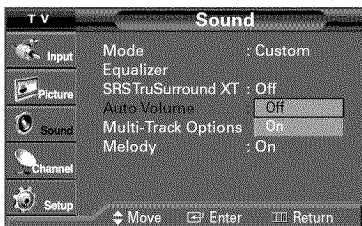

3. Press the **▲** or **▼** button to select “On” or “Off”, then press the **ENTER** button. Press the **EXIT** button to exit.

Choosing a Multi-Channel Sound (MTS) track - Digital

The digital-TV transmission system is capable of simultaneous transmission of many audio tracks (for example, simultaneous translations of the program into foreign languages). The availability of these additional “multitracks” depends upon the program.

Preferred Language

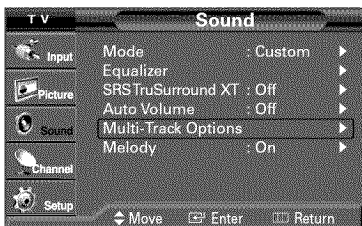

1. Press the **MENU** button to display the menu. Press the **▲** or **▼** button to select “Sound”, then press the **ENTER** button.
2. Press the **▲** or **▼** button to select “Multi-Track Options”, then press the **ENTER** button.



3. Press the **ENTER** button to select “Preferred Language”. Press the **▲** or **▼** button to choose the language (English, Spanish or French) you want, then press the **ENTER** button. Press the **EXIT** button to exit.

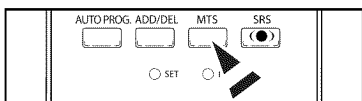

Press the **MTS** button on the remote control to listen in a language other than the preferred language.

Choosing a Multi-Channel Sound (MTS) track - Analog

Multi-Track Sound



1. Press the **MENU** button to display the menu.
Press the **▲** or **▼** button to select "Sound", then press the **ENTER** button.
2. Press the **▲** or **▼** button to select "Multi-Track Options", then press the **ENTER** button.



3. Press the **▲** or **▼** button to select "Multi-Track Sound", then press the **ENTER** button.
Press the **▲** or **▼** button to select a setting you want, then press the **ENTER** button.

Press the **EXIT** button to exit.

- Choose **Mono** for channels that are broadcasting in mono, or if you are having difficulty receiving a stereo signal.
- Choose **Stereo** for channels that are broadcasting in stereo.
- Choose **SAP** to listen to the Separate Audio Program, which is usually a foreign-language translation.

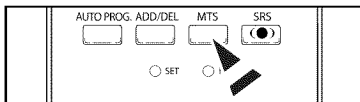

- Press the **MTS** button on the remote control repeatedly to select "Mono", "Stereo", or "SAP".

Setting the On/Off Melody

A melody sound can be set to come on when the TV is powered On or Off.

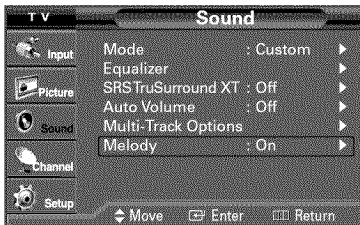

1. Press the **MENU** button to display the menu.
Press the **▲** or **▼** button to select "Sound", then press the **ENTER** button.
2. Press the **▲** or **▼** button to select "Melody", then press the **ENTER** button.

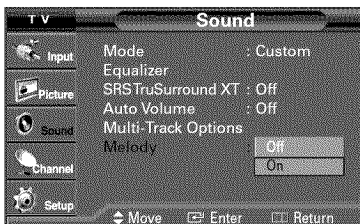

3. Press the **▲** or **▼** button to select "On" or "Off", then press the **ENTER** button.
Press the **EXIT** button to exit.

Channel Control

Selecting the Antenna

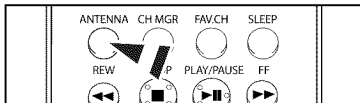
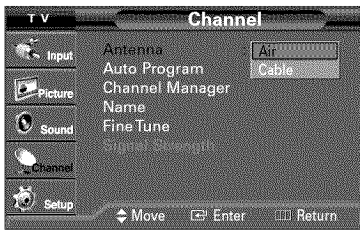

1. Press the **MENU** button to display the menu.
Press the **▲** or **▼** button to select "Channel", then press the **ENTER** button.
2. Press the **ENTER** button to select "Antenna".
Press the **▲** or **▼** button to select "Air" or "Cable", then press the **ENTER** button.
Press the **EXIT** button to exit.

 Press the **ANTENNA** button on the remote control to select Air or Cable.

- If the antenna is connected to ANT 1 IN (AIR), select "Air" and if it is connected to ANT 2 IN (CABLE), select "Cable".
- If both ANT 1 IN (AIR) and ANT 2 IN (CABLE) are connected, select the antenna input you want. If the antenna input is not selected properly, noise may appear on the screen.

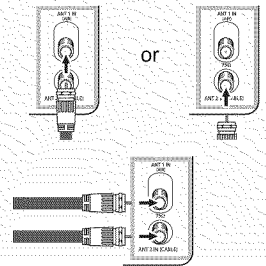

Adding and Erasing Channels

You can add or delete a channel to display the channels you want only.
To use the Channel Manager function, first run Auto Program (see page 17).

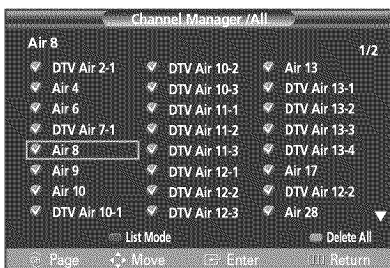

1. Press the **MENU** button to display the menu.
Press the **▲** or **▼** button to select "Channel", then press the **ENTER** button.
2. Press the **▲** or **▼** button to select "Channel Manager", then press the **ENTER** button.
3. Press the **ENTER** button to select "All".
4. Press the **▲** or **▼** button to select a channel to delete, then press the **ENTER** button.
Press the **▲** or **▼** button to select "Delete", then press the **ENTER** button to delete the channel.

Continued...

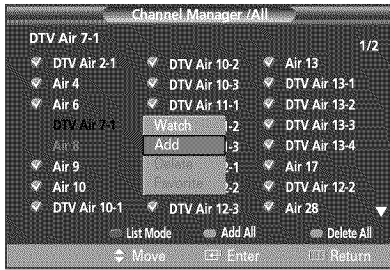

- Press the **▲** or **▼** button to select a channel to add, then press the **ENTER** button.

Press the **▲** or **▼** button to select "Add", then press the **ENTER** button to add the channel.

Press the **EXIT** button to exit.

➤ All added channels will be shown on "Added" menu.

- ♦ **Red button:** Press repeatedly to select "All", "Added", or "Favorite".
- ♦ **Green button:** Press to add all channels deleted.
- ♦ **Yellow button:** Press to delete all channels memorized.

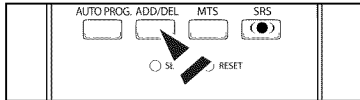

- Press the **ADD/DEL** button on the remote control. Press the **CH ▲** and **CH ▼** button to select the channel to be added or deleted, then press the **ENTER** button.

To set-up Your Favorite Channels

You can set channels you watch frequently as favorites.



- Press the **MENU** button to display the menu. Press the **▲** or **▼** button to select "Channel", then press the **ENTER** button.

- Press the **▲** or **▼** button to select "Channel Manager", then press the **ENTER** button.

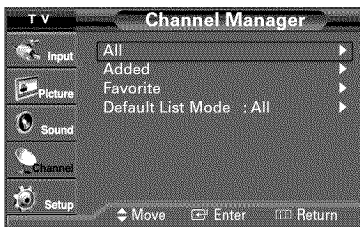

- Press the **▲** or **▼** button to select "All" or "Added", then press the **ENTER** button.

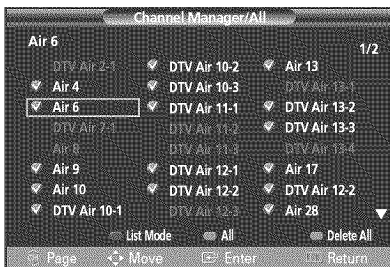

- Press the **▲/▼/◀/▶** button to select a channel as a favorite channel, then press the **ENTER** button.

Press the **CH ▲** and **CH ▼** button to display the next channel list page.



- Press the **▲** or **▼** button to select "Favorite", then press the **ENTER** button. The "♥" symbol will appear and the channel will be set as a Favorite. To cancel your Favorite channel selection, press the **ENTER** button until the "♥" symbol disappears.

Press the **EXIT** button to exit.

➤ Only memorized channels can be set as favorite channels.

➤ All favorite channels will be shown on "Favorite" menu.

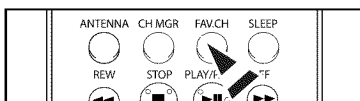

- To select the favorite channels you have set up, press the **FAV.CH** button on the remote control.

Viewing the Channel Lists

You can display a list of all channels, added channels or your favorite channels.

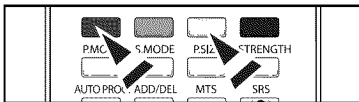
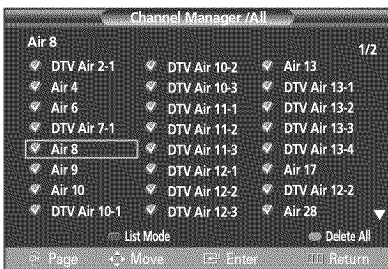

1. Press the **MENU** button to display the menu.
Press the **▲** or **▼** button to select "Channel", then press the **ENTER** button.
2. Press the **▲** or **▼** button to select "Channel Manager", then press the **ENTER** button.
3. Press the **▲** or **▼** button to select "All", "Added" or "Favorite", then press the **ENTER** button.
To toggle between your all channels, add channels, or favorite channels, use the red button on the remote control.
Press the **EXIT** button to exit.

- ◆ **Red button:** Press repeatedly to select "All", "Added", or "Favorite".
- ◆ **Yellow button:** Press to delete all channels memorized.

Setting the Default Channel List Mode

You can set All, Added, or Favorite to be the Default List that appears when you press the CH. MGR button.

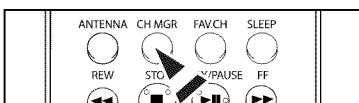

1. Press the **MENU** button to display the menu.
Press the **▲** or **▼** button to select "Channel", then press the **ENTER** button.
2. Press the **▲** or **▼** button to select "Channel Manager", then press the **ENTER** button.
3. Press the **▲** or **▼** button to select "Default List Mode" then press the **ENTER** button.
Press the **▲** or **▼** button to select "All", "Added", or "Favorite", then press the **ENTER** button.
➤ The Channel list you want to appear when you press the **CH MGR** button.

- ◆ **All:** Shows All the channels when you press the CH MGR button on the remote control.
- ◆ **Added:** Shows Added channels when you press CH MGR button on the remote control.
- ◆ **Favorite:** Shows Favorite channels when you press CH MGR button on the remote control.

Press the **EXIT** button to exit.

- 📺 Press the **CH MGR** button on the remote control to bring up the Channel Lists.

Labeling Channels

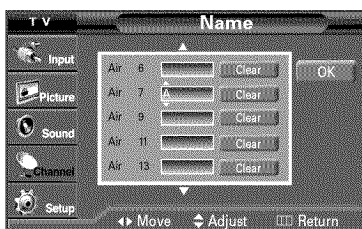
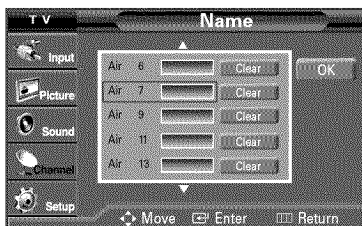

1. Press the **MENU** button to display the menu. Press the **▲** or **▼** button to select "Channel", then press the **ENTER** button. Press the **▲** or **▼** button to select "Name", then press the **ENTER** button.
2. Press the **▲** or **▼** button to select the channel to be assigned a new name, then press the **ENTER** button.
3. Press the **▲** or **▼** button to select a letter, a number or a blank (Results in this sequence: A...Z, 0...9, +, -, *, /, blank). Press the **▶** button to switch to the next field, which will be selected. Select a second letter or digit by pressing the **▲** or **▼** button, as above. Repeat the process to select the last three digits. When you have finished, press the **ENTER** button to assign the new name. To erase the assigned new name, select "Clear" by pressing the **◀** or **▶** button, then press the **ENTER** button. Press the **EXIT** button to exit.

- The names of digital broadcasting channels are automatically assigned and thus cannot be assigned by users.
- When you use a cable card to watch cable broadcasting, it may take some time for a channel name to be displayed due to the time it takes to receive data.
- If you add or delete the TV channel, the corresponding label information will also be added or deleted.

Fine Tuning Analog Channels

Use fine tuning to manually adjust a particular channel for optimal reception.

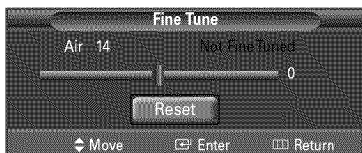
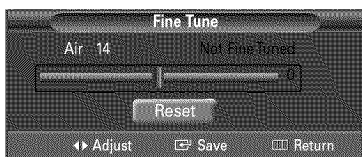

1. Press the **MENU** button to display the menu. Press the **▲** or **▼** button to select "Channel", then press the **ENTER** button.
2. Press the **▲** or **▼** button to select "Fine Tune", then press the **ENTER** button.
3. Press the **◀** or **▶** button to adjust the fine tuning.
4. To store the fine tuning setting in the TV's memory, press the **ENTER** button. To reset the fine tuning setting, press the **▼** button to select "Reset", then press the **ENTER** button. Press the **EXIT** button to exit.

- Only analog TV channels can be fine tuned.
- "+" will appear next to the number of fine-tuned channels.

Checking the Digital-Signal Strength

Unlike analog channels, which can vary in reception quality from “snowy” to clear, digital (HDTV) channels have either perfect reception quality or you will not receive them at all. So, unlike analog channels, you cannot fine tune a digital channel. You can, however, adjust your antenna to improve the reception of available digital channels.

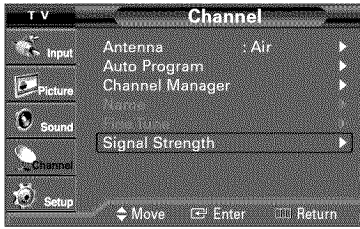

1. Press the **MENU** button to display the menu. Press the **▲** or **▼** button to select “Channel”, then press the **ENTER** button.
2. Press the **▲** or **▼** button to select “Signal Strength”, then press the **ENTER** button. If the signal strength meter indicates that the signal is weak, physically adjust your antenna to increase the signal strength. Continue to adjust the antenna until you find the best position with the strongest signal.

Press the **EXIT** button to exit

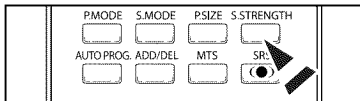
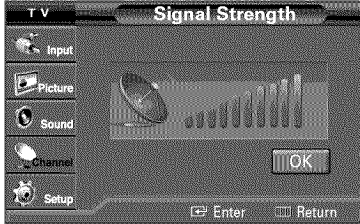

-  You can also press the **S.STRENGTH** button on the remote control to check the signal strength.

Using the R.Surf Feature

This feature allows you to set the TV to return to a particular channel after a certain amount of time. For example, you may be watching a channel when commercials start. You can set the R.Surf to “5 minutes”, then switch channels. After 5 minutes, the TV will return to the original channel. To use the R.Surf feature:

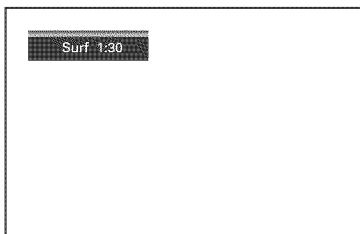
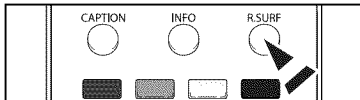

1. While you are watching the channel to which you want to return, press the **R.SURF** button. The “Surf Off” is displayed.
2. Press the **R.SURF** button again to set the timer in thirty second intervals, up to five minutes.
 - The time will start decreasing while you are setting up the timer, and will reset after 5 minutes has passed or you turn it off.
3. The time you set will begin counting down on the screen. When the time runs out, the TV will return to the channel you were watching when you set the timer.

Time Setting

Setting the Time

Setting the clock is necessary in order to use the various timer features of the TV.
Also, you can check the time while watching the TV. (Just press the INFO button.)

Option 1: Setting the Clock Manually

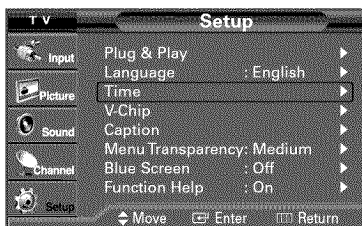

1. Press the **MENU** button to display the menu.
Press the **▲** or **▼** button to select "Setup", then press the **ENTER** button.
Press the **▲** or **▼** button to select "Time", then press the **ENTER** button.

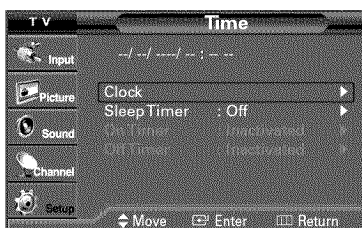

2. Press the **ENTER** button to select "Clock".

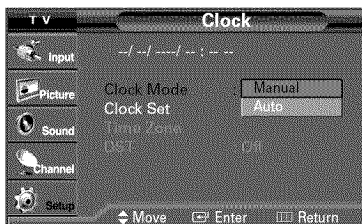

3. Press the **ENTER** button to select "Clock Mode".
Press the **▲** or **▼** button to select "Manual", then press the **ENTER** button.



4. Press the **▲** or **▼** button to select "Clock Set", then press the **ENTER** button.

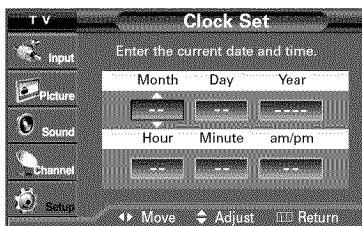

5. Press the **◀** or **▶** button to move to "Month", "Day", "Year", "Hour", "Minute", or "am/pm". Set the date and time you want by pressing the **▲** or **▼** button, then press the **ENTER** button.

Press the **EXIT** button to exit.

- The current time will appear every time you press the **INFO** button.
- You can set the month, day, year, hour, and minute directly by pressing the number buttons on the remote control.

Continued...

Option 2: Setting the Clock Automatically

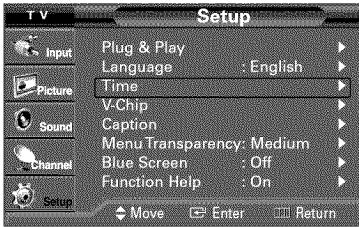

1. Press the **MENU** button to display the menu. Press the **▲** or **▼** button to select "Setup", then press the **ENTER** button. Press the **▲** or **▼** button to select "Time", then press the **ENTER** button.

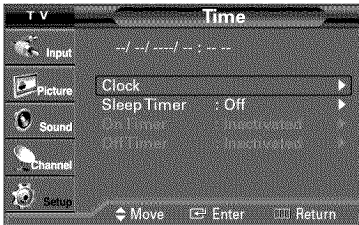

2. Press the **ENTER** button to select "Clock".

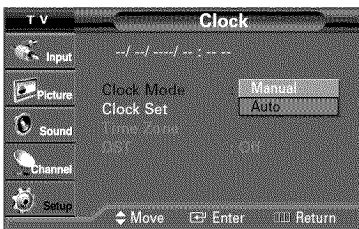

3. Press the **ENTER** button to select "Clock Mode". Press the **▲** or **▼** button to select "Auto", then press the **ENTER** button.

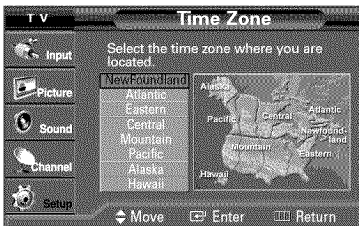

4. Press the **▲** or **▼** button to select "Time Zone", then press the **ENTER** button.
5. Press the **▲** or **▼** button to highlight the time zone for your local area (and to move the highlight to the appropriate time zone on the map of the United States), then press the **ENTER** button.

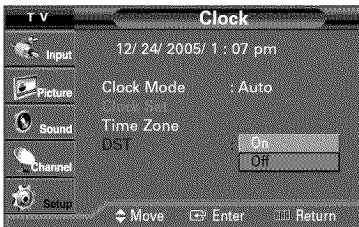

6. Press the **▲** or **▼** button to select "DST" (Daylight Saving Time), then press the **ENTER** button. Press the **▲** or **▼** button to select "On" or "Off", then press the **ENTER** button. Press the **EXIT** button to exit.
 - Depending on the broadcast station and signal, the auto time may not be set correctly. If this occurs, set the time manually.
 - Air or cable must be connected in order to set the time automatically.

Setting the On/Off Timer

Use this feature to set the TV to turn on or off at a desired time.

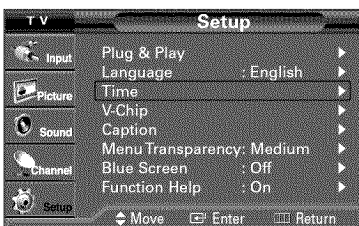

1. Press the **MENU** button to display the menu. Press the **▲** or **▼** button to select "Setup", then press the **ENTER** button. Press the **▲** or **▼** button to select "Time", then press the **ENTER** button.

Continued...

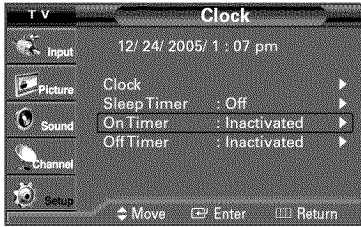

2. Press the ▲ or ▼ button to select "On Timer", then press the **ENTER** button.

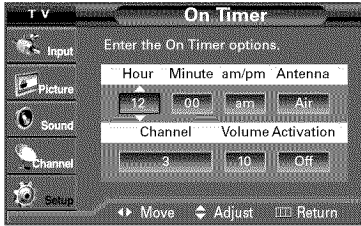

3. Press the ▲ or ▼ button to set the hour, then press the ► button to move to the next step.
Set other items using the same method as above.
 - When finished, press the **MENU** button to return.
 - You can set the hour, minute, and channel directly by pressing the number buttons on the remote control.

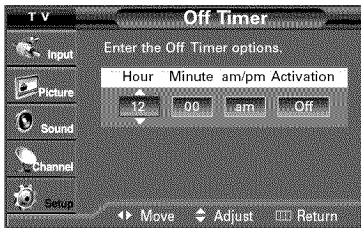

4. Press the ▲ or ▼ button to select "Off Timer", then press the **ENTER** button.
5. Press the ▲ or ▼ button to set the hour, then press the ► button to move to the next step.
Set other items using the same method as above.

Press the **EXIT** button to exit.

- Auto Power Off

When you set the timer "On", the TV will eventually turn off, if no controls are operated for 3 hours after the TV was turned on by timer. This function is only available in timer "On" mode and prevents overheating, which may occur if a TV is on for too long.

Setting the Sleep Timer

The sleep timer automatically shuts off the TV after a preset time (from 30 to 180 minutes).

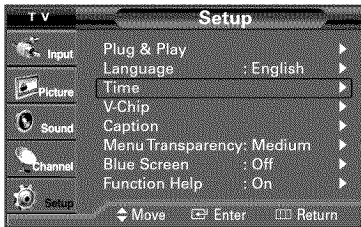

1. Press the **MENU** button to display the menu.
Press the ▲ or ▼ button to select "Setup", then press the **ENTER** button.
Press the ▲ or ▼ button to select "Time", then press the **ENTER** button.

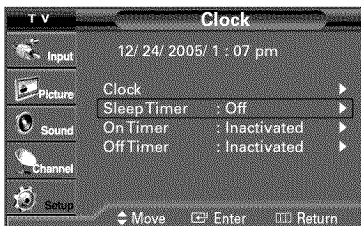

2. Press the ▲ or ▼ button to select "Sleep Timer", then press the **ENTER** button.



3. Press the ▲ or ▼ button to select the minute.
Setting the Timer sets the Activation to "On" automatically.

To cancel the set sleep timer:

Press the ► button to select "Activation".

Press the ▲ or ▼ button to select "Off", then press the **ENTER** button.

Press the **EXIT** button to exit.

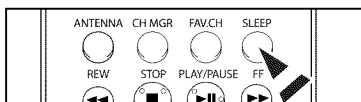

- ☐ Press the **SLEEP** button on the remote control until the appropriate time interval appears (any of the preset values from "30 min" to "180 min").

Function Description

Selecting a Menu Language

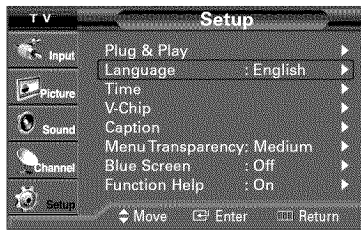

1. Press the **MENU** button to display the menu.
Press the **▲** or **▼** button to select "Setup", then press the **ENTER** button.
Press the **▲** or **▼** button to select "Language", then press the **ENTER** button.

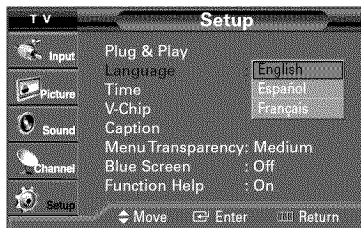

2. Press the **▲** or **▼** button to select the appropriate language: "English", "Español" or "Français", then press the **ENTER** button.
Press the **EXIT** button to exit.

Using the V-Chip

The V-Chip feature automatically locks out programs that are deemed inappropriate for children. The user must enter a PIN (personal ID number) before any of the V-Chip restrictions are set up or changed.

Setting Up Your Personal ID Number (PIN)

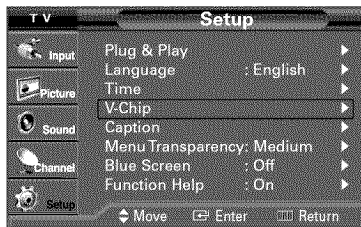

1. Press the **MENU** button to display the menu.
Press the **▲** or **▼** button to select "Setup", then press the **ENTER** button.
2. Press the **▲** or **▼** button to select "V-Chip", then press the **ENTER** button.
The message "Enter PIN" will appear. Enter your 4 digit PIN number.
➤ The default PIN number of a new TV set is "0-0-0-0".

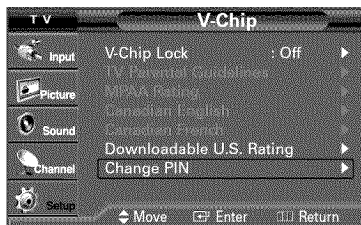
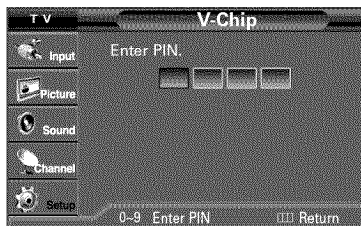

3. The "V-Chip" screen will appear.
Press the **▲** or **▼** button to select "Change PIN", then press the **ENTER** button.
The Change PIN screen will appear. Choose any 4 digits for your PIN and enter them.
As soon as the 4 digits are entered, the "Confirm new PIN" screen appears.
Re-enter the same 4 digits. When the Confirm screen disappears, your PIN has been memorized.

Press the **EXIT** button to exit.

- If you forget the PIN, press the remote control buttons in the following sequence, which resets the pin to 0-0-0-0 : Power Off. → MUTE → 8 → 2 → 4 → Power On.

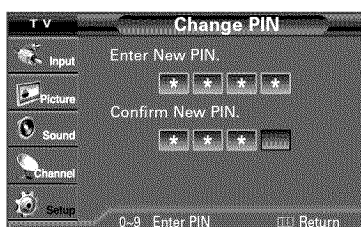

Continued...

How to Enable/Disable the V-Chip



1. Press the **MENU** button to display the menu.
Press the **▲** or **▼** button to select "Setup", then press the **ENTER** button.
2. Press the **▲** or **▼** button to select "V-Chip", then press the **ENTER** button.
The message "Enter PIN" will appear. Enter your 4 digit PIN number.
3. The "V-Chip" screen will appear.
To enable the V-Chip feature, press the **ENTER** button so that the "V-Chip Lock" field is "On". (Pressing the **▲** or **▼** button will alternate between "On" and "Off".)
Press the **ENTER** button.
Press the **EXIT** button to exit.

How to Set up Restrictions Using the "TV Parental Guidelines"

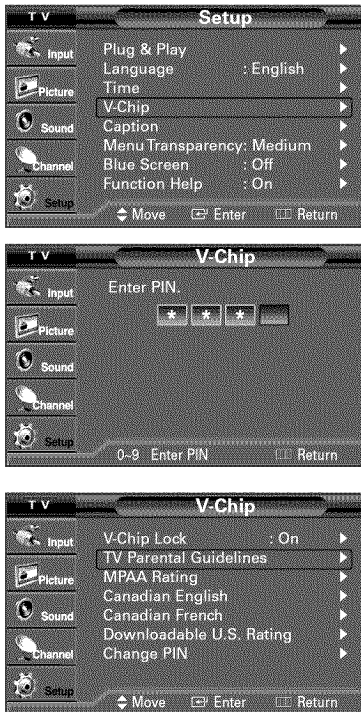

First, set up a personal identification number (PIN), and enable the V-Chip. (See previous section.)
Parental restrictions can be set up using either of two methods: The TV guidelines or the MPAA rating.



1. Press the **MENU** button to display the menu.
Press the **▲** or **▼** button to select "Setup", then press the **ENTER** button.
2. Press the **▲** or **▼** button to select "V-Chip", then press the **ENTER** button.
The message "Enter PIN" will appear. Enter your 4 digit PIN number.
3. The "V-Chip" screen will appear. Press the **▲** or **▼** button to select "TV Parental Guidelines", then press the **ENTER** button.
4. The "TV Parental Guidelines" screen will appear.
Press the **▲** or **▼** button to select one of the six aged based categories:
 - **TV-Y:** Young children.
 - **TV-Y7:** Children 7 and over.
 - **TV-G:** General audience.
 - **TV-PG:** Parental guidance.
 - **TV-14:** Viewers 14 and over.
 - **TV-MA:** Mature audience.

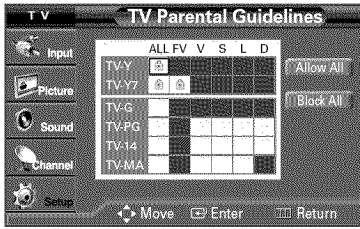

Continued...



5. At this point, one of the TV-Ratings is selected. Press the **ENTER** button. Depending on your existing setup, the “” symbol will be selected. (Blank = Unblocked,  = Blocked) While “” is selected, press the **ENTER** button to block or unblock the category. To select a different TV-Rating, press the **▲** or **▼** button and then repeat the process.
- Allow all: Press to unlock all TV ratings. / Block all: Press to lock all TV ratings.
 - The TV-Y, TV-Y7, TV-G, TV-PG, TV-14 and TV-MA have additional options. See the next step to change any of the following sub-ratings:

- **FV:** Fantasy violence.
- **D:** Sexually suggestive dialog.
- **L:** Adult language.
- **S:** Sexual situation.
- **V:** Violence.

- The V-Chip will automatically block certain categories that are “more restrictive”. For example, if you block “TV-Y” category, then TV-Y7 will automatically be blocked. Similarly, if you block the TV-G category, then all the categories in the “young adult” group will be blocked (TV-G, TV-PG, TV-14, and TV-MA). The subratings (D, L, S, V) work together similarly. (See next section.)

6. How to set the FV, V, S, L and D sub-ratings. First, select one of these TV-Ratings: TV-Y, TV-Y7, TV-G, TV-PG, TV-14, or TV-MA (See Step 4, on page 39), and press the **ENTER** button. The “” symbol will be displayed for each sub-rating. While “” is selected, press the **▶** button to go to a sub rating. Press the **ENTER** button to block the sub rating. To select a different TV-Rating, press the **▲** or **▼** button and then repeat the process.
- The V-chip will automatically block certain categories that are “More restrictive”. For example, if you block “L” sub-rating in TV-PG, then the “L” sub-ratings in TV-14 and TV-MA will automatically be blocked.

7. Press the **EXIT** button to clear all the screens. (Or proceed to the next section, and set up additional restrictions based on the MPAA codes.)

- These categories consist of two separate groups: TV-Y and TV-Y7 (young children through age 7), and TV-G through TV-MA (everybody else). The restrictions for these two groups work independently: If a household includes very young children as well as young adults, the TV guidelines must be set up separately for each age group.
-
- **TV-Y:** All children. The themes and elements in this program are specifically designed for a very young audience, including children from ages two to six.
 - **TV-Y7:** Directed to older children. The themes and elements in this program may include mild physical or comedic violence, or may frighten children under the age of seven.
 - **TV-G:** General audience. It contains little or no violence, no strong language, and little or no sexual dialog or situations.
 - **TV-PG:** Parental guidance suggested. This program may contain infrequent coarse language, limited violence, some suggestive sexual dialog and situations.
 - **TV-14:** Parents strongly cautioned. This program may contain sophisticated themes, sexual content, strong language and more intense violence.
 - **TV-MA:** Mature audiences only. This program may contain mature themes, profane language, graphic violence and explicit sexual content.

Continued...

How to Set up Restrictions Using the MPAA Ratings: G, PG, PG-13, R, NC-17, X, NR

The MPAA rating system uses the Motion Picture Association of America (MPAA) system, and its main application is for movies. When the V-Chip lock is on, the TV will automatically block any programs that are coded with objectionable ratings (either MPAA or TV-Ratings).

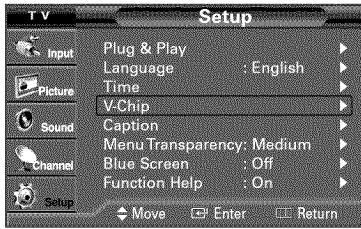

1. Press the **MENU** button to display the menu. Press the **▲** or **▼** button to select "Setup", then press the **ENTER** button.
2. Press the **▲** or **▼** button to select "V-Chip", then press the **ENTER** button. The message "Enter PIN" will appear. Enter your 4 digit PIN number.

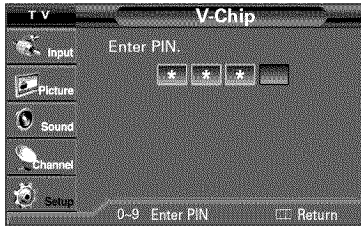

3. The "V-Chip" screen will appear. Press the **▲** or **▼** button to select "MPAA Rating", then press the **ENTER** button.

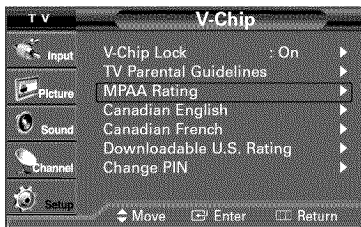

4. Press the **▲** or **▼** button to select a appropriate restriction. Press the **ENTER** button to activate the restriction selected. The "🔒" symbol is indicated. While "🔒" is selected, press the **ENTER** button to block or unblock the category. Press the **EXIT** button to exit.

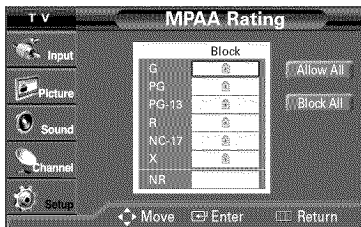

➤ Allow all: Press to unlock all TV ratings. / Block all: Press to lock all TV ratings.

- ♦ **G**: General audience (no restriction).
- ♦ **PG**: Parental guidance suggested.
- ♦ **PG-13**: Parents strongly cautioned.
- ♦ **R**: Restricted. Children under 17 should be accompanied by an adult.
- ♦ **NC-17**: No children under age 17.
- ♦ **X**: Adults only.
- ♦ **NR**: Not rated.

➤ The V-Chip will automatically block any category that is "more restrictive". For example, if you block the "PG-13" category, then "R", "NC-17" and "X" will automatically be blocked also.

Continued...

How to Set up Restrictions Using the 'Canadian English'

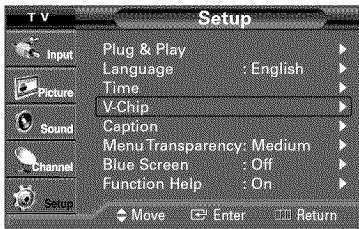

1. Press the **MENU** button to display the menu.
Press the **▲** or **▼** button to select "Setup", then press the **ENTER** button.
2. Press the **▲** or **▼** button to select "V-Chip", then press the **ENTER** button.
The message "Enter PIN" will appear. Enter your 4 digit PIN number.

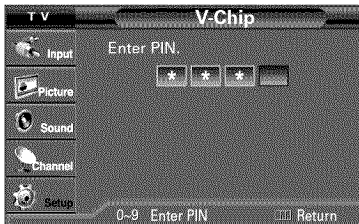

3. The "V-Chip" screen will appear. Press the **▲** or **▼** button to select "Canadian English", then press the **ENTER** button.

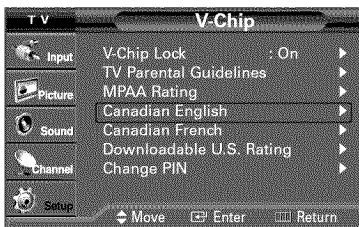

4. Press the **▲** or **▼** button to select a appropriate restriction.
Press the **ENTER** button to activate the restriction selected.
The "🔒" symbol is indicated.
Press the **EXIT** button to exit.

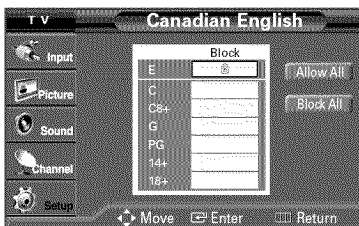

➤ Allow all: Press to unlock all TV ratings. / Block all: Press to lock all TV ratings.

- **E:** Exempt programming includes...news, sports, documentaries and other information programming, talk shows, music videos, and variety programming.
- **C:** Programming intended for children under age 8.
- **C8+:** Programming generally considered acceptable for children 8 years and over to watch on their own.
- **G:** General programming, suitable for all audiences.
- **PG:** Parental guidance.
- **14+:** Programming contains themes or content which may not be suitable for viewers under the age of 14.
- **18+:** Adult programming.

➤ The V-Chip will automatically block any category that is "more restrictive".
For example, if you block "G" category, then "PG", "14+" and "18+" will automatically be blocked also.

Continued...

How to Set up Restrictions Using the 'Canadian French'

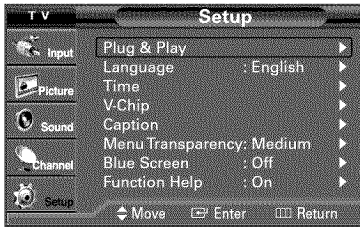

1. Press the **MENU** button to display the menu.
Press the **▲** or **▼** button to select "Setup", then press the **ENTER** button.
2. Press the **▲** or **▼** button to select "V-Chip", then press the **ENTER** button.
The message "Enter PIN" will appear. Enter your 4 digit PIN number.

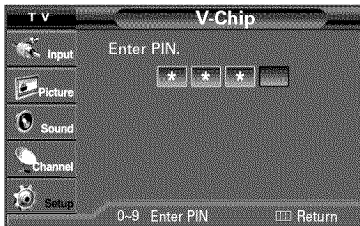

3. The "V-Chip" screen will appear. Press the **▲** or **▼** button to select "Canadian French", then press the **ENTER** button.



4. Press the **▲** or **▼** button to select a appropriate restriction.
Press the **ENTER** button to activate the restriction selected.
The "🔒" symbol is indicated.

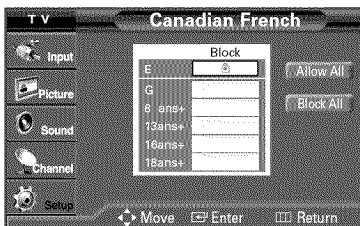

- Allow all: Press to unlock all TV ratings. / Block all: Press to lock all TV ratings.

- ♦ **E**: Exempt programming includes...news, sports, documentaries and other information programming, talk shows, music videos, and variety programming.
- ♦ **G**: General.
- ♦ **8 ans+**: Not recommended for young children.
- ♦ **13 ans+**: Programming may not be suitable for children under the age of 13.
- ♦ **16 ans+**: Programming is not suitable for children under the age of 16.
- ♦ **18 ans+**: Programming restricted to adults.

- The V-Chip will automatically block any category that is "more restrictive". For example, if you block "8 ans+", then "13 ans+", "16 ans+" and "18 ans+" will automatically be blocked also.

Continued...

Using the V-Chip for Digital channels

Parental restriction information can be used while watching DTV channels.

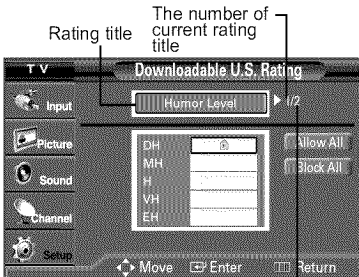
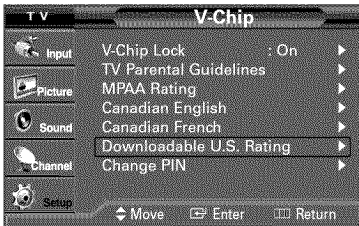
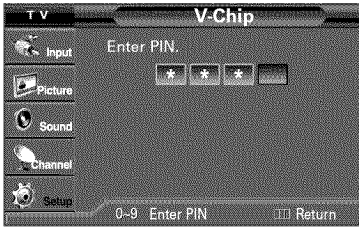
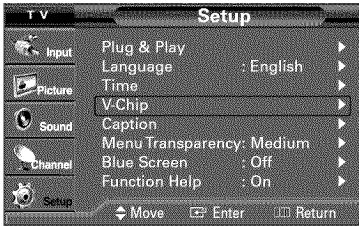

The number of all rating title

1. Press the **MENU** button to display the menu. Press the **▲** or **▼** button to select "Setup", then press the **ENTER** button.
2. Press the **▲** or **▼** button to select "V-Chip", then press the **ENTER** button. The message "Enter PIN" will appear. Enter your 4 digit PIN number.
3. The "V-Chip" screen will appear. Press the **▲** or **▼** button to select "Downloadable U.S. Rating", then press the **ENTER** button.
 - If information is not downloaded from the broadcasting station, the "Downloadable U.S. Rating" menu is deactivated.
 - Parental restriction information is automatically downloaded while watching DTV channels. It may take several seconds.
 - The "Downloadable U.S. Rating" menu is available for use after information is downloaded from the broadcasting station. However, depending on the information from the broadcasting station, it may not be available for use.
4. Press the **▲** or **▼** button to select a appropriate restriction. Press the **ENTER** button to activate the restriction selected. The "🔒" symbol is indicated. Press the **EXIT** button to exit.
 - Allow all: Press to unlock all TV ratings. / Block all: Press to lock all TV ratings.
 - Parental restriction levels differ depending on the broadcasting station.
 - The default menu name and Downloadable US rating changes depending on the downloaded information.
 - Even if you set the On-screen display to your desired language, the "Downloadable U.S. Rating" menu will appear in English only.
 - The rating will automatically block certain categories that are more restrictive.
 - The rating titles (For example: Humor Level.etc) and TV ratings (For example: DH,MH,H.etc) may differ depending on the broadcasting station.

Viewing Closed Captions(On-Screen Text Messages) - Digital

The Digital Captions function operates on digital channels.

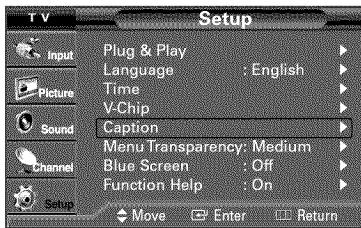

1. Press the **MENU** button to display the menu.
Press the **▲** or **▼** button to select "Setup", then press the **ENTER** button.
2. Press the **▲** or **▼** button to select "Caption", then press the **ENTER** button.

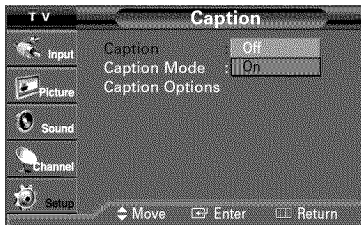

3. Press the **ENTER** button to select "Caption".
Press the **▲** or **▼** button to select "On", then press the **ENTER** button.

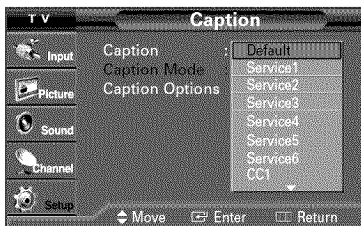

4. Press the **▲** or **▼** button to select "Caption Mode", then press the **ENTER** button.
Press the **▲** or **▼** button to select the submenu (Default, Service1~ Service6, CC1~CC4 or Text1 ~ Text4) you want, then press the **ENTER** button.

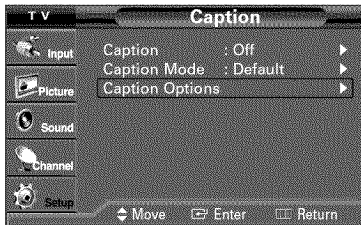

5. Press the **▲** or **▼** button to select "Caption Options", then press the **ENTER** button.

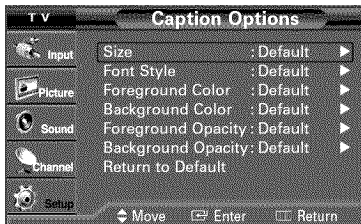

6. Press the **ENTER** button to select "Size".
Press the **▲** or **▼** button to select the desired caption option, then press the **ENTER** button.
Press the **▲** or **▼** button to select the desired sub-menu options (see options below), then press the **ENTER** button.

Press the **EXIT** button to exit.

- The availability of captions depends on the program being broadcast.
- "Default" means to follow the standard set by the broadcaster.
- Foreground and Background cannot be set to have the same color.
- Foreground Opacity and Background Opacity cannot be both set to "Transparent".

- ◆ **Size:** This option consists of "Default", "Small", "Standard", and "Large". The default is "Standard".
- ◆ **Font style:** This option consists of "Default", "Style0 ~ Style 7". You can change the font you want. The default is "Style 0".
- ◆ **Foreground Color:** This option consists of "Default", "White", "Black", "Red", "Green", "Blue", "Yellow", "Magenta", and "Cyan". You can change the color of the letter. The default is "White".
- ◆ **Background Color:** This option consists of "Default", "White", "Black", "Red", "Green", "Blue", "Yellow", "Magenta", and "Cyan". You can change the background color of the caption. The default is "Black".
- ◆ **Foreground Opacity:** This option consists of "Default", "Solid", "Flashing", "Translucent", and "Transparent". You can change the opacity of the letter.

Continued...

- **Background Opacity:** This option consists of "Default", "Solid", "Flashing", "Translucent", and "Transparent". You can change the background opacity of the caption.
- **Return to Default:** This option sets each of "Size", "Font style", "Foreground Color", "Background Color", "Foreground Opacity", and "Background Opacity" to its factory default.

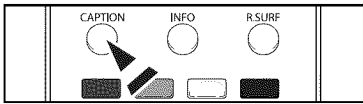

 You can also press the **CAPTION** button on the remote control to select Captions "On" or "Off".

Viewing Closed Captions(On-Screen Text Messages) - Analog

The Analog Caption function operates in either analog TV channel mode or external signal mode. (Depending on the broadcasting signal, the Analog Caption function may operate on digital channels.)

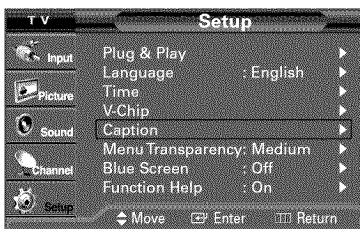

1. Press the **MENU** button to display the menu.
Press the **▲** or **▼** button to select "Setup", then press the **ENTER** button.
2. Press the **▲** or **▼** button to select "Caption", then press the **ENTER** button.

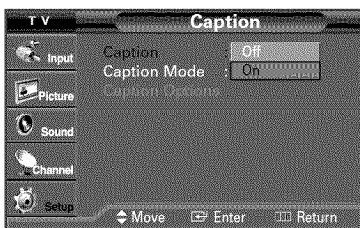

3. Press the **ENTER** button to select "Caption".
Press the **▲** or **▼** button to select "On", then press the **ENTER** button.

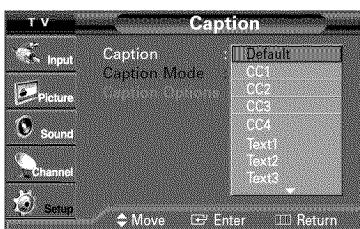



4. Press the **▲** or **▼** button to select "Caption Mode", then press the **ENTER** button.
Press the **▲** or **▼** button to select the submenu (CC1~CC4 or Text1 ~ Text4) you want, then press the **ENTER** button.
Press the **EXIT** button to exit.

➤ The default is "CC1".

- **CC1:** The Primary Synchronous Caption Service. These are captions in the primary language that must be in sync with the sound, preferably matched to a specific frame.
- **CC2:** The Special Non-Synchronous Use Captions. This channel carries data that is intended to augment information carried in the program.
- **CC3:** Secondary Synchronous Caption Service. Alternate program-related caption data, typically second language captions.
- **CC4:** Special Non-Synchronous Use Captions. Similar to CC2.
- **Text1:** First Text Service. This may be various non-program related data.
- **Text2:** Second Text Service. Additional data, usually not program related.
- **Text3/Text4:** Third Text Service. These data channels should be used only if Text1 and Text2 are not sufficient.

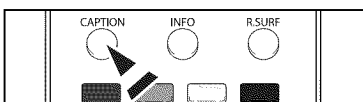
➤ The availability of captions depends on the program being broadcast.



 You can also press the **CAPTION** button on the remote control to select Captions "On" or "Off".

Menu Transparency Level

Adjusts the transparency of the menu screen.

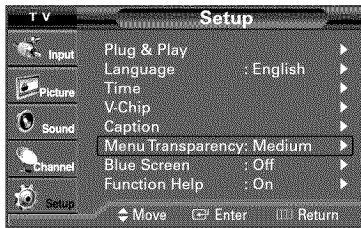

1. Press the **MENU** button to display the menu.
Press the **▲** or **▼** button to select "Setup", then press the **ENTER** button.

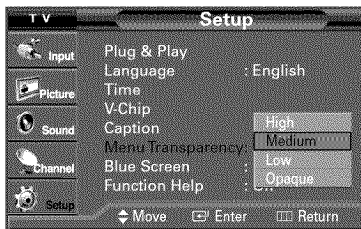

2. Press the **▲** or **▼** button to select "Menu Transparency", then press the **ENTER** button.
Press the **▲** or **▼** button to select the level you want, then press the **ENTER** button.
Press the **EXIT** button to exit.

Setting the Blue Screen Mode

If no signal is being received or the signal is very weak, a blue screen automatically replaces the noisy picture background.
If you wish to continue viewing the poor picture, you must set the "Blue Screen" mode to "Off"



1. Press the **MENU** button to display the menu.
Press the **▲** or **▼** button to select "Setup", then press the **ENTER** button.



2. Press the **▲** or **▼** button to select "Blue Screen", then press the **ENTER** button.
Press the **▲** or **▼** button to select "On" or "Off", then press the **ENTER** button.
Press the **EXIT** button to exit.

Setting the Function Help

Displays help on the menu functions.



1. Press the **MENU** button to display the menu.
Press the **▲** or **▼** button to select "Setup", then press the **ENTER** button.



2. Press the **▲** or **▼** button to select "Function Help", then press the **ENTER** button.
Press the **▲** or **▼** button to select "On" or "Off", then press the **ENTER** button.
Press the **EXIT** button to exit.
➤ The default setting of the function help is On.

Appendix

Identifying Problems

If the TV seems to have a problem, first try this list of possible problems and solutions.
If none of these troubleshooting tips apply, call your nearest Samsung service center.

Problem	Possible Solution
Poor picture	Try another channel. Adjust the antenna. Check all wire connections.
Poor sound quality.	Try another channel. Adjust the antenna.
No picture or sound.	Try another channel. Press the SOURCE button. Make sure the TV is plugged in. Check the antenna connections. Make sure the MUTE button is off.
No sound or sound is too low at maximum volume.	First, check the volume of units connected to your TV (digital broadcasting receiver, DVD, cable broadcasting receiver, VCR, etc.). Then, adjust the TV volume accordingly.
Picture rolls vertically.	Check all wire connections.
The TV operates erratically.	Unplug the TV for 30 seconds, then try operating it again.
The TV won't turn on.	Make sure the wall outlet is working.
Remote control malfunctions	Replace the remote control batteries. Clean the upper edge of the remote control (transmission window). Check the battery terminals. Press the TV button to put your remote operate your TV. control in the "TV" mode. Make sure the remote has batteries. Check that the "+" and "-" ends of the batteries are inserted correctly.
Digital broadcasting screen problem.	Please check the digital signal strength and input antenna.
The image is too light or too dark.	Adjust the Brightness and Contrast. Adjust the Fine tuning.
The visual qualities of digital channels vary.	The visual qualities of digital channels may vary depending on the original production method (analog or digital). <ul style="list-style-type: none"> • If the original production method is digital: High visual quality program. • If the original production method is analog: The digital program displayed on the screen is originally an analog program which has been converted to digital. The visual quality is of an SD grade.
Although the TV caption shows HD, the visual quality is not satisfactory.	The HD caption that appears when switching channels or when pressing the Information button on the remote control means the selected channel is a digital channel. If the broadcasting station converts an analog signal into digital and transmits the signal, the visual quality may not be perfect.

Specifications

Model Name	TX-R3079WH	TX-R3080WH	TX-R3081WH	TX-S2782H	TX-S2779H	TX-S3082WH
Screen Size (Diagonal)	30 inches	30 inches	30 inches	27 inches	27 inches	30 inches
Power Supply	AC110-120V~ 60 Hz					
Power Consumption	180W	180W	180W	165W	165W	180W
Sound Output	10W + 10W					
Dimensions (WxDxH) Body	934 x 406 x 568 mm/ 36.7 x 15.9 x 22.3 inches	796 x 415 x 586 mm/ 31.3 x 16.3 x 23.0 inches	796 x 415 x 586 mm/ 31.3 x 16.3 x 23.0 inches	771 x 420 x 593 mm/ 30.3 x 16.5 x 23.3 inches	796 x 415 x 586 mm/ 31.3 x 16.3 x 23.0 inches	910 x 415 x 570 mm/ 35.8 x 16.3 x 22.4 inches
Weight	54.5 Kg/120.1 lbs	54.5 Kg/120.1 lbs	54.0 Kg/119.0 lbs	41.0 Kg / 90.3 lbs	43.0 Kg / 94.7 lbs	53.2 Kg / 117.2 lbs



Contact SAMSUNG WORLD-WIDE

If you have any questions or comments relating to Samsung products, please contact the SAMSUNG customer care center.

Country	Customer Care Center ☎	Web Site	Address
CANADA	1-800-SAMSUNG (7267864)	www.samsung.com/ca	Samsung Electronics Canada Inc., Customer Service 55 Standish Court Mississauga, Ontario L5R 4B2 Canada
			Samsung Electronique Canada Inc., Service à la Clientèle 55 Standish Court Mississauga, Ontario L5R 4B2 Canada
U.S.A	1-800-SAMSUNG (7267864)	www.samsung.com	Samsung Electronics America, Inc. 105 Challenger Road Ridgefield Park, NJ 07660-0511